

# Science and Practice of Pressure Ulcer Management

Marco Romanelli  
Michael Clark  
Amit Gefen  
Guido Ciprandi  
*Editors*

*Second Edition*



Springer

---

# Science and Practice of Pressure Ulcer Management

---

Marco Romanelli • Michael Clark  
Amit Gefen • Guido Ciprandi  
Editors

# Science and Practice of Pressure Ulcer Management

Second Edition

 Springer

*Editors*

Marco Romanelli  
Department of Dermatology  
Santa Chiara Hospital, University of Pisa  
Pisa  
Italy

Michael Clark  
Welsh Wound Innovation Centre  
Rhondda Cynon Taf  
Wales  
United Kingdom

Amit Gefen  
Department of Biomedical Engineering  
Faculty of Engineering  
Tel Aviv University  
Tel Aviv  
Israel

Guido Ciprandi  
Bambino Gesù' Children's Hospital  
Rome  
Italy

ISBN 978-1-4471-7411-0      ISBN 978-1-4471-7413-4 (eBook)  
<https://doi.org/10.1007/978-1-4471-7413-4>

Library of Congress Control Number: 2018946738

© Springer-Verlag London Ltd., part of Springer Nature 2018

This work is subject to copyright. All rights are reserved by the Publisher, whether the whole or part of the material is concerned, specifically the rights of translation, reprinting, reuse of illustrations, recitation, broadcasting, reproduction on microfilms or in any other physical way, and transmission or information storage and retrieval, electronic adaptation, computer software, or by similar or dissimilar methodology now known or hereafter developed.

The use of general descriptive names, registered names, trademarks, service marks, etc. in this publication does not imply, even in the absence of a specific statement, that such names are exempt from the relevant protective laws and regulations and therefore free for general use.

The publisher, the authors, and the editors are safe to assume that the advice and information in this book are believed to be true and accurate at the date of publication. Neither the publisher nor the authors or the editors give a warranty, express or implied, with respect to the material contained herein or for any errors or omissions that may have been made. The publisher remains neutral with regard to jurisdictional claims in published maps and institutional affiliations.

This Springer imprint is published by Springer Nature, under the registered company Springer-Verlag London Ltd.

The registered company address is: The Campus, 4 Crinan Street, London, N1 9XW, United Kingdom

---

## Foreword

The mission of the European Pressure Ulcer Advisory Panel (EPUAP) is:

*To provide relief for persons suffering from, or at risk of, pressure ulcers, through research and the education of the public and by influencing pressure ulcer policy in all European countries towards an adequate patient centred and cost effective pressure ulcer care.*

To this end we are indebted to Professor Marco Romanelli, his co-editors and chapter authors in developing the second edition of *Science and Practice of Pressure Ulcer Management* on behalf of and as a resource for the EPUAP.

Written by experts in the prevention and management of pressure ulcers, the book complements the first edition with new chapters in areas including bioengineering (biomarkers and cushion characteristics); special populations: paediatrics and obstetrics and gynaecology; health-related quality of life; confounding factors relating directly to skin protection including incontinence-associated dermatitis, microclimate and skin care; advanced treatment therapies and innovation; and the Stop Pressure Ulcer Day and other initiatives.

Aimed at dermatology clinicians, surgeons, nurses and allied healthcare professionals, the book is a key clinical reference text for the prevention and treatment of pressure ulcers, an aspect of medicine and healthcare which can be clinically challenging.

Prague, Czech Republic

Jane Nixon, Ph.D., M.B.E.

---

# Contents

<b>1</b>	<b>The Potential of Biomarkers in the Early Detection of Pressure Ulcers</b> . . . . .	<b>1</b>
	Dan Bader and Cees Oomens	
<b>2</b>	<b>The Critical Characteristics of a Good Wheelchair Cushion</b> . . . . .	<b>17</b>
	Ayelet Levy, Naama Shoham, Kara Kopplin, and Amit Gefen	
<b>3</b>	<b>Epidemiology of Pressure Ulcers</b> . . . . .	<b>33</b>
	Nils Lahmann and Jan Kottner	
<b>4</b>	<b>Nutrition and Pressure Ulcers</b> . . . . .	<b>41</b>
	Emanuele Cereda and Jos M. G. A. Schols	
<b>5</b>	<b>Risk Assessment in Pressure Ulcers</b> . . . . .	<b>57</b>
	Vera Lúcia Conceição de Gouveia Santos, Letícia Faria Serpa, Guadalupe Maria Lobo Cordero, Sandra Guerrero Gamboa, Heidi Hevia Campos, and Otilia Cruz Castañeda	
<b>6</b>	<b>Health Related Quality of Life (HRQOL) Implications for People with Pressure Ulcers</b> . . . . .	<b>79</b>
	Trudie Young, Katia Furtado, and Paulo Alves	
<b>7</b>	<b>Incontinence-Associated Dermatitis (IAD) and Pressure Ulcers: An Overview</b> . . . . .	<b>89</b>
	Dimitri Beekman	
<b>8</b>	<b>Microclimate: Rediscovering an Old Concept in the Aetiology of Pressure Ulcers</b> . . . . .	<b>103</b>
	Michael Clark	
<b>9</b>	<b>Skin Care</b> . . . . .	<b>111</b>
	Sue Bale, Janice Cameron, Sylvie Meaume, and Andrea Ingegneri	
<b>10</b>	<b>Pressure Ulcers in Pediatric Patients</b> . . . . .	<b>125</b>
	Guido Ciprandi, Teresa Oranges, and Anna Barbara Schluer	

<b>11</b>	<b>Pressure Ulcers After Epidural Anaesthesia</b> . . . . .	151
	Agata Janowska, Valentina Dini, Marilena Pradal, Giulia Davini, and Francesco Uccelli	
<b>12</b>	<b>Advanced Dressings in Pressure Ulcers</b> . . . . .	159
	Agata Janowska, Michela Macchia, and Battistino Paggi	
<b>13</b>	<b>Adjunctive Therapies in Pressure Ulcers</b> . . . . .	175
	Jakub Taradaj and Elia Ricci	
<b>14</b>	<b>Negative Pressure Wound Therapy in the Management of Pressure Ulcers</b> . . . . .	189
	Valentina Dini, Salvatore Panduri, and Marco Romanelli	
<b>15</b>	<b>Surgical Management of Pressure Ulcers</b> . . . . .	199
	Alessandro Scalise, Caterina Tartaglione, Marina Pierangeli, Vania Recchi, Matteo Torresetti, and Luc Téot	
<b>16</b>	<b>The Stop Pressure Ulcer Day and Other Initiatives by EPUAP</b> . . . . .	229
	Christina Lindholm, Michael Clark, and Zita Kis Dadara	
<b>17</b>	<b>Innovation in Pressure Ulcer Prevention and Treatment</b> . . . . .	237
	Keith Harding and Michael Clark	
	<b>Index</b> . . . . .	243

---

## Contributors

**Paulo Alves** Centre for Interdisciplinary Research in Health (CIIS), Wound Research Lab, Universidade Católica Portuguesa, Porto, Portugal

**Dan Bader** Faculty of Health Sciences, University of Southampton, Southampton, UK

Department of Biomedical Engineering, Technical University of Eindhoven, Eindhoven, The Netherlands

**Sue Bale** Llanfrechfa Grange Hospital, Cwmbran, UK

**Dimitri Beeckman** Department of Public Health, University Centre for Nursing and Midwifery, Ghent University, Ghent, Belgium

**Janice Cameron** Department of Dermatology, Oxford Radcliffe Hospitals NHS Trust, Churchill Hospital, Oxford, UK

**Heidi Hevia Campos** Nursing Department, Nursing School of Andrés Bello University, Viña del Mar, Chile

**Otilia Cruz Castañeda** Ostomy and Wound Clinic, Regional General Ignacio Zaragoza I.S.S.S.T.E. Hospital, Mexico City, Mexico

**Emanuele Cereda** Clinical Nutrition and Dietetics Unit, Fondazione IRCCS Policlinico “San Matteo”, Pavia, Italy

**Guido Ciprandi** Bambino Gesù’ Children’s Hospital, Rome, Italy

**Michael Clark** Welsh Wound Innovation Centre, Rhondda Cynon Taf, Wales, UK

**Guadalupe Maria Lobo Cordero** Department of Clinical Nursing, Wound Ostomy and Incontinence Center—PROCURA, La Central Clinic, Aguascalientes, Mexico

**Zita Kis Dadara** Barmherzige Brüder Austria, Vienna, Austria

**Giulia Davini** Department of Dermatology, Santa Chiara Hospital, University of Pisa, Pisa, Italy

**Valentina Dini** Department of Dermatology, Santa Chiara Hospital, University of Pisa, Pisa, Italy



**Katia Furtado** Multidisciplinary Wound Care Team in Alentejo Unidade Local de Saúde do Norte Alentejano, Hospital de Portalegre, Portalegre, Portugal

**Sandra Guerrero Gamboa** Nursing Department, National University of Colombia, Bogotá D.C., Cundinamarca, Colombia

**Amit Gefen** Department of Biomedical Engineering, Faculty of Engineering, Tel Aviv University, Tel Aviv, Israel

**Vera Lúcia Conceição de Gouveia Santos** Medical-Surgical Nursing Department, School of Nursing (EE-USP), University of São Paulo, São Paulo, SP, Brazil

**Keith Harding** Welsh Wound Innovation Centre, Rhondda Cynon Taff, Wales, UK

**Andrea Ingegneri** Department of Dermatology, Santa Chiara Hospital, University of Pisa, Pisa, Italy

**Agata Janowska** Department of Dermatology, Santa Chiara Hospital, University of Pisa, Pisa, Italy

**Kara Kopplin** Efficacy Research, Standards and Compliance, ROHO, Inc, Belleville, IL, USA

**Jan Kottner** Department of Dermatology and Allergy, Charité-Universitätsmedizin Berlin, Berlin, Germany

**Nils Lahmann** Department of Geriatrics, Charité-Universitätsmedizin Berlin, Berlin, Germany

**Ayelet Levy** Department of Biomedical Engineering, Faculty of Engineering, Tel Aviv University, Tel Aviv, Israel

**Christina Lindholm** Sophiahemmet University, Stockholm, Sweden

**Michela Macchia** Department of Dermatology, Santa Chiara Hospital, Pisa, Italy

**Sylvie Meaume** Hôpital Charles Foix, Ivry sur Seine, France

**Cees Oomens** Department of Biomedical Engineering, Technical University of Eindhoven, Eindhoven, The Netherlands

**Teresa Oranges** Department of Dermatology, Santa Chiara Hospital, University of Pisa, Pisa, Italy

**Battistino Paggi** HeKa s.c.s., Biella, Italy

**Salvatore Panduri** Department of Dermatology, Santa Chiara Hospital, University of Pisa, Pisa, Italy

**Marina Pierangeli** Department of Plastic and Reconstructive Surgery, Università Politecnica delle Marche, Ancona, Italy

**Marilena Pradal** Department of Dermatology, Santa Chiara Hospital, University of Pisa, Pisa, Italy

**Vania Recchi** Department of Plastic and Reconstructive Surgery, Marche Politechnical University, Ancona, Italy

**Elia Ricci** Difficult Wound Healing Unit, St. Luca's Clinic, Pecetto Torinese, Italy

**Marco Romanelli** Department of Dermatology, Santa Chiara Hospital, University of Pisa, Pisa, Italy

**Alessandro Scalise** Department of Plastic and Reconstructive Surgery, Università Politecnica delle Marche, Ancona, Italy

**Anna Barbara Schluer** University Children's Hospital, Zurich, Switzerland

**Jos M. G. A. Schols** Department of Family Medicine, Maastricht University, Maastricht, The Netherlands

Department of Health Services Research, Maastricht University, Maastricht, The Netherlands

**Letícia Faria Serpa** Institute of Education and Research, Oswaldo Cruz German Hospital, São Paulo, SP, Brazil

**Naama Shoham** Department of Biomedical Engineering, Faculty of Engineering, Tel Aviv University, Tel Aviv, Israel

**Jakub Taradaj** Department of Physiotherapy Basics at Academy School of Physical Education, Katowice, Poland

College of Rehabilitation Sciences at University of Manitoba, Winnipeg, Canada

**Caterina Tartaglione** Department of Plastic and Reconstructive Surgery, Università Politecnica delle Marche, Ancona, Italy

**Matteo Torresetti** Department of Plastic and Reconstructive Surgery, Marche Politechnical University, Ancona, Italy

**Luc Téot** Wound Healing Unit, Pôle EMMBRUN, Department of Surgery, Montpellier University Hospital, Montpellier, France

**Francesco Uccelli** Department of Dermatology, Santa Chiara Hospital, University of Pisa, Pisa, Italy

**Trudie Young** Welsh Wound Innovation Centre, Wales, UK



# The Potential of Biomarkers in the Early Detection of Pressure Ulcers

1

Dan Bader and Cees Oomens

---

## Introduction

In the minimal data set for risk factors, based on the UK National Institute of Health Research (NIHR) PURPOSE Program in Leeds, skin condition and immobility are considered to be critical primary factors for pressure ulcer development [1]. However, an assessment of these parameters is necessarily vague, based on subjective clinical judgement. Indeed the most commonly employed risk assessment scales (RAS) for nurses, developed by Braden, Waterlow and Norton, include a wide range of factors, such as mobility, age, sex, and incontinence. Although there has been considerable research of an epidemiological nature, there has been relatively little new fundamental research that has led to a causal relationship between specific factors and the risk of developing a pressure ulcer. An example of the former study examined the sensitivity and specificity of the existing RAS [2], and reported an incorrect classification for up to 30% of the hospitalized patients with PUs. Thus, patients at high risk might not receive adequate preventative measures. This identifies a critical need to develop objective robust methods for clinical use, based on physiological mechanisms, to assess integrity/status of soft tissues. This will inform levels of risk and provide effective management in the form of rigorous intervention strategies.

---

D. Bader (✉)

Faculty of Health Sciences, University of Southampton, Southampton, UK

Department of Biomedical Engineering, Technical University of Eindhoven,  
Eindhoven, The Netherlands

e-mail: [D.L.Bader@soton.ac.uk](mailto:D.L.Bader@soton.ac.uk)

C. Oomens

Department of Biomedical Engineering, Technical University of Eindhoven,  
Eindhoven, The Netherlands

e-mail: [C.W.J.Oomens@tue.nl](mailto:C.W.J.Oomens@tue.nl)

## Bioengineering Solutions

Over the last 50 years, much of the research focus has been centred on adapting biomechanical and physiological measurements for use at the loaded patient-support interface. As an example, considerable effort was made in developing an array of discrete sensors, which could map the pressure distribution at the loaded interface and provide an aid to clinical prescription of an appropriate support surface. Such measurements can also be used as a biofeedback tool to the patient providing evidence of postural factors associated with pelvic obliquity, tilt and rotation and the efficacy of pressure relief regimes. As pressure is force per unit area it is obvious that the shape of a subject will have an effect on the interface pressure distribution. Both shape and form of a subject at a load-bearing site will depend upon the underlying bony skeleton, the quantity, tone and shape of the musculature and the amount of subcutaneous fat, as well as the resilience of the intervening skin. It has been proposed that each of these tissues exhibit a distinct tolerance to mechanical loading, in terms of their time to damage [3]. As an example, physiological and anatomical studies show that irreversible muscle cell damage is initiated after 3 h of ischaemia and is almost complete by 6 h. Additionally, there is a complex interaction between body morphology and interface pressure and there are many cases for which subjects with very similar body types can exhibit distinctly different interface pressures. Indeed the range of interface pressures on various anatomical sites vary widely with the underlying anatomy and it is not often possible to predict the interface pressures from the individual body type and body mass index. Accordingly, it is evident that monitoring both the magnitude and period of interface pressures alone will not prove sufficient to alert the clinician to potential areas of tissue breakdown. This has motivated a number of investigators to utilize alternative measurement techniques, which can provide indicators of compromise to the health of soft tissues in the loaded state. A series of studies have been reported which examined the effects of pressure and time on soft tissue viability, using physical sensing systems, typically transcutaneous oxygen and carbon dioxide tensions ( $TcPO_2/TcPO_2$ ) or Laser Doppler fluxmetry [4–6]. A number of criteria were developed for the former technique based on the reduction of  $TcPO_2$  in the absence or presence of increased  $TcPCO_2$  above unloaded basal values. This approach indicated, for example, that normal pressure relieving strategies conducted by a wheelchair-bound individual, such as pushing-up from the cushion, were not sufficient to restore tissue viability to basal levels of  $TcPO_2$  [7, 8]. More recently, the present authors have examined the viability of skin tissues when supported for prolonged periods, specifically on both a spine-board [9] and an alternating pressure air mattress (APAMs). As an example, they demonstrated that the internal pressures of a prototype APAM, which could be adjusted to subject morphology, was successful in maintaining tissue viability at the sacrum for supine volunteers [10]. Using the same criteria, the performance of lateral rotation provided by an active mattress system was examined in comparison to the response provided by manual repositioning adopted by the nursing staff [11].

## Motivation for Biomarker Research

It is evident that in order to interrogate the effects of externally-applied mechanical loading at the tissue level, it is most appropriate to sample the biochemical milieu, in the form of a range of biomarkers. This would reflect the internal state of the tissues incorporating compromise of both blood supply and lymphatic drainage and the resulting effects at the cellular level. As an example, in the absence of adequate oxygen delivery, cell metabolism converts from an aerobic to anaerobic state, with an associated increase in molecules such as lactate leading to a decrease in local pH. This is potentially damaging to the viability of the cell niche.

A biomarker may be defined as a measurable characteristic that reflects the presence and/or severity of some disease state or some other physiological state of an organism. This can be achieved by sampling either tissues or body fluids from an individual and analyzing its constituents. A biomarker can also represent a substance that either is introduced into an organism as a means to examine organ function or other aspects of health or whose detection indicates a particular disease state, for example, the presence of an antibody may indicate an infection. Thus, biomarkers can be specific cells, molecules, genes or their products, enzymes or hormones. Although the term biomarker is relatively new, the concept is well established in pre-clinical research and clinical diagnosis. For example, cholesterol values are risk indicators for coronary and vascular disease, while C-reactive protein (CRP) is a marker for inflammation.

Indeed research to identify biomarkers has blossomed in the last few decades, with a plethora of research studies associated with diverse long-term conditions, such as cardiovascular disease, diabetes and cancer (Table 1.1). This is supported by a very active industrial interest, with companies involved for example in developing glucose biosensors for individuals with diabetes. By contrast, with reference to either chronic wound fluid or pressure ulcers per se, the literature review revealed relatively few papers related to biomarkers from different medium.

An ideal biomarker for early PU detection should exhibit the following characteristics:-

- Easy specimen collection (minimally invasive, small representative volumes)
- Simple, robust method of analysis at relatively low cost
- Stable for subsequent analysis

**Table 1.1** Published studies on biomarkers in disease states

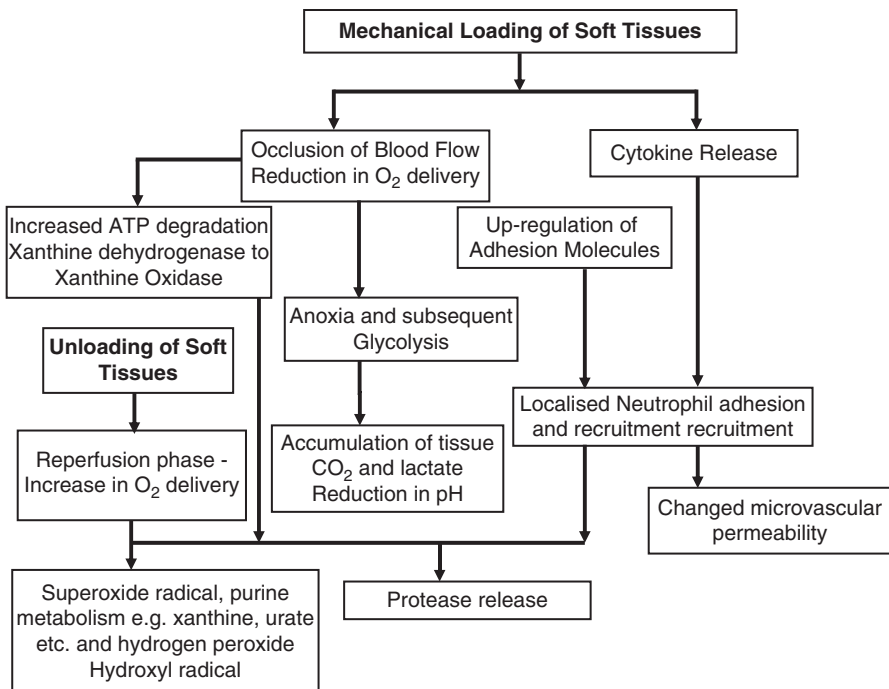
PubMed (August 5th 2015) search revealed
• 74,918 papers on biomarkers and cardiovascular disease
• 24,918 papers on biomarkers and diabetes
• 267,922 papers on biomarkers and cancer
• 2360 papers on biomarkers and chronic obstructive pulmonary disease
• 81 papers on biomarkers in chronic wound fluid
• 13 papers on biomarkers in wound fluid in chronic ulcers
• 107 papers on biomarkers and pressure ulcers, including 10 on early detection, 59 on treatment

- High sensitivity/specificity characteristics matched to the method of analysis
- Provides a means to evaluate intervention strategies designed to produce effective prevention with the resulting benefits to the individual and the health services

These features will be discussed according to the tissue/fluid interrogated in studies involving both able-bodied volunteers and subjects deemed to be at risk of developing a pressure ulcer.

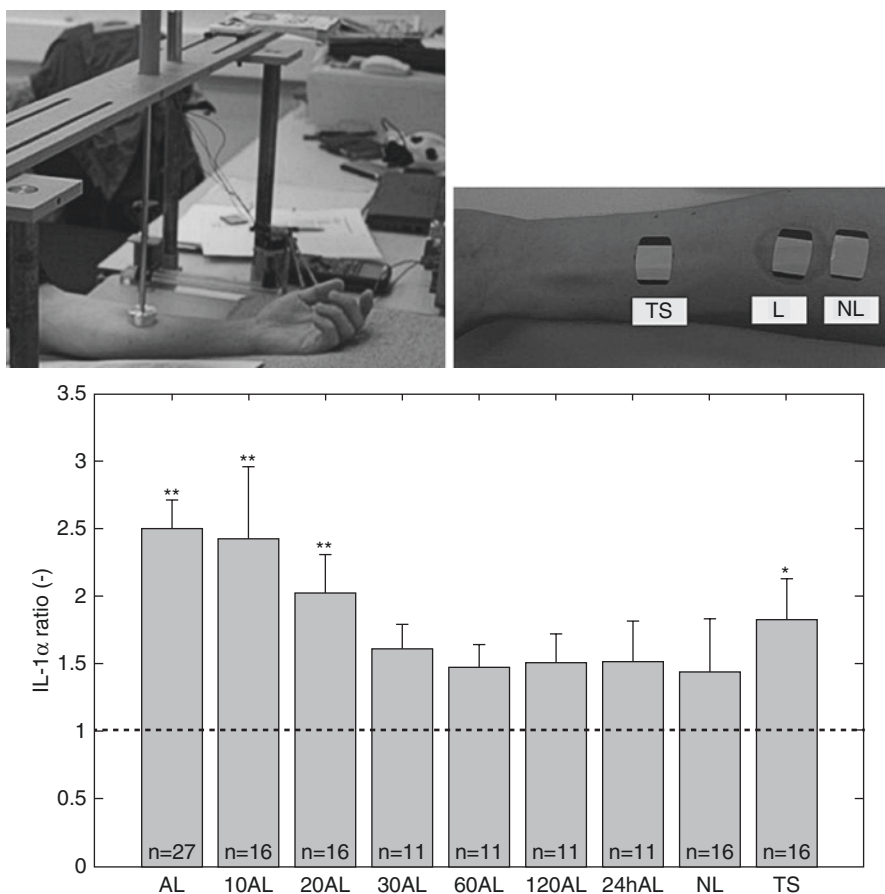
## Epidermal Markers

It is well established that inflammation is one of the earliest response of skin to mechanical irritation. This is activated by the keratinocytes within the epidermis, which release a cascade of markers, notably involving cytokines and chemokines (Fig. 1.1). These molecules have long been identified as major mediators of inflammation, although their precise role in the development of pressure ulcers remains unclear. Previous studies, however, have demonstrated that IL-1 $\alpha$  is a pluripotent, multifunctional cytokine that plays a key role in the initiation and development of inflammatory and immune responses. Keratinocytes constitutively produce IL-1 $\alpha$  and their competitive antagonist, IL-1RA. Furthermore, IL-1 $\alpha$  is known to induce the production of IL-8.

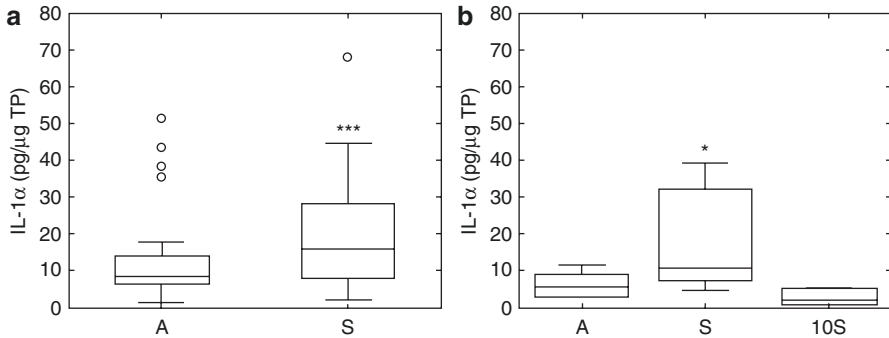


**Fig. 1.1** Schematic indicating the potential biomarkers to be collected in soft tissues subjected to mechanical loading and subsequent unloading (based on [24, 50])

A non-invasive method to absorb cytokines and chemokines from the skin surface was described [12], using a commercial product (Sebutape, CuDerm Corp., US), a lipophilic polymeric silicone coated film which can extract sebum from the skin [13]. These tapes cause minimal stripping of corneocytes or damage to the stratum corneum and inflict minimal pain to the subject. This method was employed in studies which reported increased levels of IL-1 $\alpha$ , IL-1RA and IL-8 released from tissue engineered epidermal constructs exposed to mechanical loading (equivalent to 150 mmHg for 1 h) [14, 15]. This method was also employed to examine the response of forearm skin to mechanical loading [14, 15]. The authors reported an up-regulation of IL-1 $\alpha$  of tissue loading when compared to unloaded basal values, which may persist for up to 24 h after load removal (Fig. 1.2). The ratio values were higher than that following tape stripping, a known stimulant for IL-1 $\alpha$  release. This



**Fig. 1.2** Top-Experimental set-up to measure cytokine release from loaded tissues; bottom results indicating the ratio of cytokine release from loaded versus unloaded tissue sites immediately following loading at a pressure of 10.6 kPa and subsequently at 10–120 min (10AL–120AL) and 24 h (24 hAL) after loading, adjacent to an unloaded site (NL). TS represent a positive control following tape stripping (based on [17])



**Fig. 1.3** Box and Whisker plots of IL-1 $\alpha$  normalised to total amounts of protein (TP) at the left arm (A) and sacrum (S), and a distance of 10 cm distance from the sacrum. The results are shown for (a) patients without a pressure ulcers and (b) for patients with a Category 1 ulcer at the sacrum. Wilcoxon signed rank test \*  $p < 0.1$ , \*\*\*  $p < 0.01$  (based on [51])

approach was extended to a cohort of patients ( $n = 36$ ) from three different wards of a hospital in the Netherlands. Five of the total number of patients presented with a non-blanchable erythema classified as a Category 1 PU. The findings generally revealed higher levels of IL-1 $\alpha$  associated with the sacrum compared to the forearm. However, close examination of the data for the five patients with Category 1 PUs, revealed this elevation to be localised over the ulcer site, with values at a distance of 100 mm away from the ulcer to be more comparable to the basal values determined at the arm (Fig. 1.3). A recent study incorporating Sebutape collection demonstrated that the ratio of IL-1 $\alpha$  and total protein can be used as a robust measure of the effect of shear force on the skin of able-bodied volunteers [16].

The experimental data of cytokine release from the epidermis was examined using a mathematical model to predict transport behaviour through the outer layers of the skin [17]. The authors highlight that only specific cytokines can be released within a practical time frame following loading and suggest that other markers, such as lactate, would be required to provide a more complete assessment of soft tissue status.

## Sweat Markers

The sweat glands store molecules reflective of the local state of skin tissues and deposit them at the epidermal surface. Sweat analysis has been traditionally used to assess subjects with cystic fibrosis. Indeed newborn screening (NBS) for cystic fibrosis (CF) is increasingly being implemented in the US, because early detection permits access to specialized medical care and improves outcomes. However, the diagnosis of CF is not always undemanding and although the sweat chloride test remains the gold standard it does not always provide the definitive answer [18]. By contrast, very little work has been reported on the analysis of sweat under ischaemic conditions. Of the few studies, Van Heyningen and Weiner [19] demonstrated a decreased sweat rate following tourniquet application to the arm. They also indicated that prolonged arterial occlusion resulted in an increase in both sweat lactate and



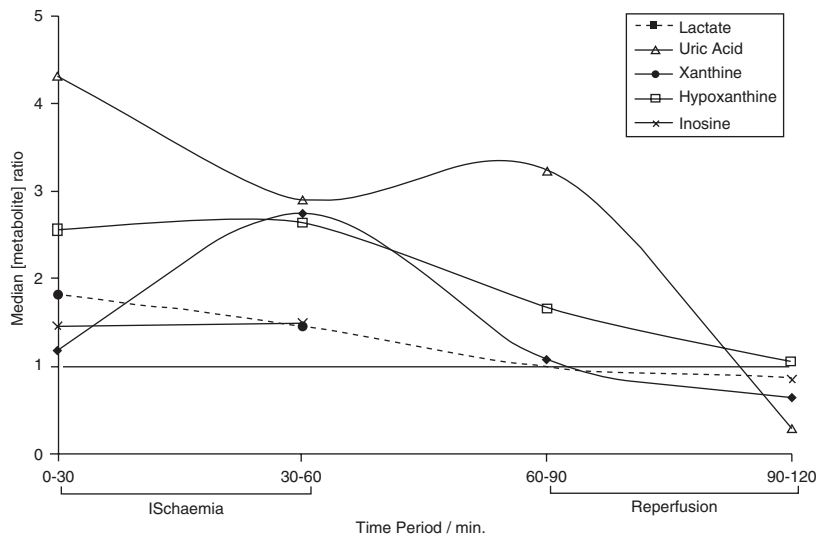
urate concentrations. Ferguson-Pell and Haggisawa [20] demonstrated the feasibility of measuring analyte concentrations in sweat from the volar arm of the forearm using a commercial system (Macroduct, Wetcor Inc., US) with the sweat induced by pilocarpine nitrate and iontophoresis. Elevated levels of lactate were recorded during local tissue indentation, which returned to basal levels following load removal in a group of able-bodied participants. However the commercial system could not be used at a loaded body support interface, as its physical bulk would distort the features of that interface.

An alternative approach was adopted by one of the present authors to assess the metabolic state of loaded soft tissues. Thermally-induced sweat was collected on a small thin piece of filter paper from able-bodied participants tested in a microclimate controlled environment [21, 22]. The authors demonstrated that

- There were different profiles of sweat constituents when the load was applied using a uniaxial indenter as opposed to hydrostatic loading via a tourniquet.
- The concentrations of lactate, urea and urate in sweat were all elevated during loading periods in association with a reduced sweat rate.
- There was some recovery of sweat constituents to basal levels during the reperfusion phase.
- In debilitated individuals, there was an increased concentration of sweat analytes during extended periods of wheelchair sitting [22].

In a separate study the status of loaded tissues was monitored, using a combination of physical sensors and sweat biomarkers, at the sacrum of able-bodied volunteers [4]. A range of parameters was estimated from the separate measurements techniques. Results indicated that  $T_cPO_2$  levels were progressively reduced with applied pressures, such that above a threshold value for loaded  $T_cPO_2$ , equivalent to a reduction of 60% from unloaded median values, there was an associated increase in  $T_pPCO_2$  values. In addition, above this threshold, there was a significant relationship between this parameter and the loaded/unloaded concentration ratios for sweat lactate and urea. These findings strongly infer that such robust parameters could prove useful as markers of tissue viability as a direct consequence of tissue ischaemia.

It is well established that mechanical-induced ischaemia is followed by a complex biochemical response when the blood supply is re-established and this may result in additional injury to the tissue [23]. During ischaemia-reperfusion (I/R), one aspect of biochemical changes involves the irreversible degradation of high-energy ATP (Fig. 1.1). In addition, an important mechanism is triggered with the influx of molecular oxygen during reperfusion, which can lead to the formation of unstable and reactive oxygen-derived free radicals, or superoxides [24]. Their presence can cause tissue damage by initiating an inflammatory cascade, resulting in microvascular dysfunction and cell apoptosis. There is considerable evidence in the literature that I/R is associated with purine metabolism in particular, some of its terminal products, which may directly produce cell injury [25]. Indeed, the appearance of purines in body fluids, such as blood and plasma, has been used as evidence of



**Fig. 1.4** Median sweat concentrations ratios on the sacrum for able-bodied volunteers during two separate collection periods of mechanical-induced ischaemia followed by two periods of reperfusion (based on [28])

cellular hypoxia [26]. Such purines include allantoin, hypoxanthine, inosine, uric acid and xanthine. Accordingly a cohort study was performed on healthy volunteers to examine purine levels in sweat [27, 28]. Sweat was collected in five separate 30 min periods, namely one unloaded period, followed by two loading periods and subsequently two reperfusion periods. The results as presented (Fig. 1.4) report the median biomarker ratios of loading compared to unloaded values. It can be seen that for both first and second ischaemic periods, all biomarker ratios were significantly above unity and, in some cases, exceeded a value of 3.0. During the first recovery period, the ratio values for xanthine, hypoxanthine and uric acid all remained above unity suggesting that the 30min period was insufficient for adequate recovery from the ischaemic insult, although lactate returned to basal levels. It was also noted that the high concentrations of uric acid in previously ischaemic tissue implied the formation of other free radicals, which have been implicated in tissue damage [29, 30]. This implies that the sweat purines provide additional information on tissue status to that available from sweat metabolites such as lactate and urea. During the second reperfusion period, the decrease in hypoxanthine ratio to unity may indicate that the purine metabolism had effectively returned to basal levels.

It is relevant to note that current literature includes a number of studies incorporating sweat analysis for a range of applications, each suggesting a promising future in metabolomics [31–33]. Sophisticated analytical tools, for example, liquid chromatography-mass spectrometry (LC-MS) or high-resolution NMR spectroscopy [34], have been shown to identify a selection of analytes from microliter volumes of sweat. In a separate study sweat patches were used to non-invasively sample cytokines in ambulatory settings over time [35]. These authors described an ultrasensitive method which demonstrated that the cytokine concentrations in sweat

e.g. IL-1 $\alpha$ , IL-1 $\beta$ , IL-8, IL-6 and TNF- $\alpha$  can be correlated with circulating levels in plasma.

The potential for biosensors for critical metabolic markers, such as lactate, is now becoming a reality [36]. A recent paper described microfluidic models for eccrine sweat generation and flow and included a review of blood-to-sweat partition pathways in order to explain how biomarker concentrations in sweat changes with flow rate [37]. The work revealed that both flow rate and biomarker diffusion determine the effective sampling rate of biomarkers at the skin surface. A broad class of biomarkers were considered including ions, small molecules e.g. lactate, pyruvate and urea, and small proteins including cytokines. The authors champion the use of sweat as a biofluid, which can be continually sampled at low fluid generation rates with no physiological consequences to the individual. Other advantages include the potential of incorporating a biosensing system in close proximity with the biofluid as it is created, sensing at low sweat rates a wide-range of biomarkers that correlate with blood. Sweat sensing also offers the potential of small fluid generation permitting adequate time for biomarkers with low membrane permeability to partition into the biofluid.

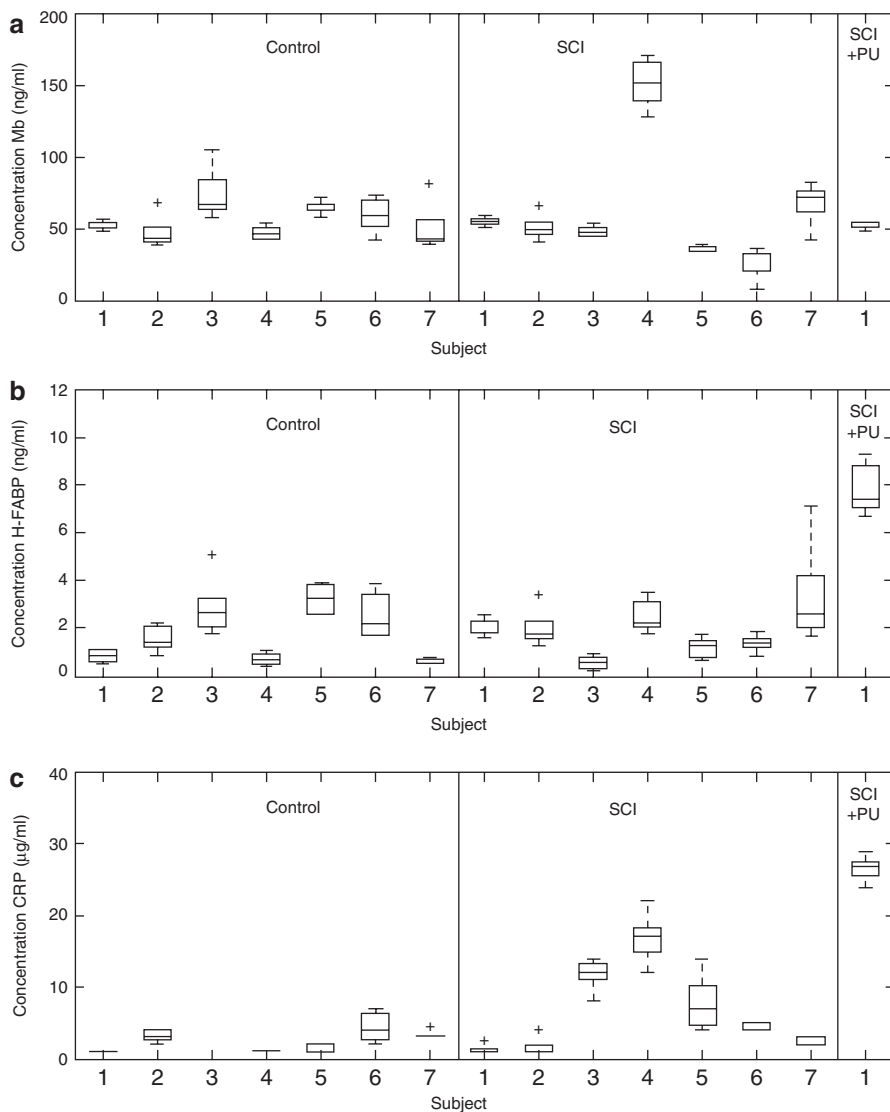
However, sweat collection and analysis might not prove appropriate for all at risk sub-populations. As an example, the sweat glands of some spinal cord injured (SCI) individuals are less sensitive regardless of central or exogenous stimulation [38].

---

## Systemic Markers

A more conventional means of analysing biomarkers involves the collection and subsequent analysis of body fluids, such as blood and urine. Indeed a few studies have examined the potential of this approach in identifying subjects with pressure ulcers. For example, Boonefey et al. [39] analysed the production of cytokines in elderly patients with severe PUs. Findings indicated a significant up-regulation of acute-phase protein and IL-6 blood levels, although similar elevations were not apparent with IL-1 and TNF serum concentrations. The authors suggested that IL-6 produced by cells in damaged areas together with cortisol may aggravate malnutrition and hypercatabolism in individuals with pressure ulcers.

The susceptibility of subjects with spinal cord injury (SCI) to deep pressure ulcers (Categories III/IV or deep tissue injury) have long been recognised due to their inherent impaired sensitivity, disuse muscle atrophy and impaired vasculature [40, 41]. Accordingly, the prevalence of pressure ulcers in this population has been studied frequently to identify risk factors and determine the individual susceptibility to PU development [42, 43]. As an example, some researchers postulated that the established change in skin resistance to external forces post SCI could be attributed to breakdown of the structural protein collagen [44, 45]. They reported increased levels of collagen degradation products, hydroxylysine and hydroxyproline, in a small group of SCI subjects, suggesting a decreased skin stiffness and strength associated with structural damage. This approach on human subjects, dormant for over 20 years, was recently re-visited in Eindhoven [46]. The focus was on identifying early markers for deep pressure ulcer or deep tissue injury (DTI), with the initial damage hidden beneath intact skin. In the study, circulatory levels of



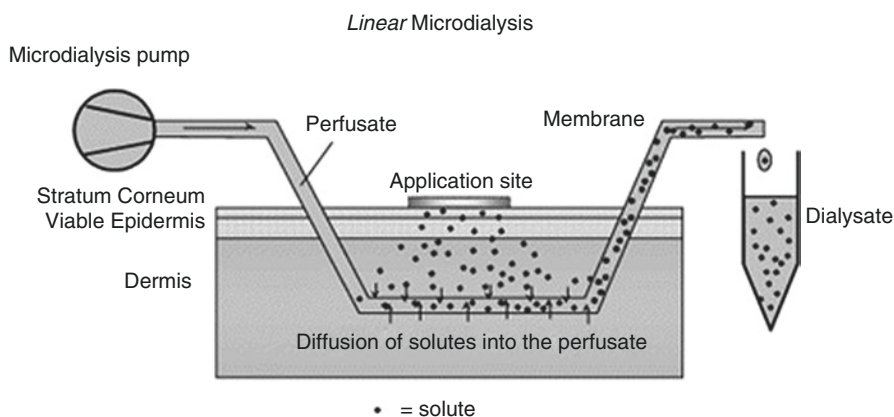
**Fig. 1.5** Concentrations of (a) Myoglobin (Mb), (b) heart-type fat acid binding protein (H-FABP) and (c) C-reactive protein for both sets of subjects taken on 5 consecutive days. *Control* control subjects, *SCI* spinal cord injury, *SCI + PU* SCI with a pressure ulcer. *U/L* units per litre (based on [46])

biomarkers for muscle damage were investigated. Baseline concentrations of creatine kinase (CK), myoglobin (Mb), heart-type fatty acid binding protein (H-FABP), and C-reactive protein (CRP) were measured in small groups of nondisabled subjects and subjects with SCI, over a period of 5 days (Fig. 1.5). Each subject exhibited a unique concentration profile for each of the markers, although some correlations were evident, for example, there was a positive correlation

between CK and H-FABP and Mb and H-FABP for both SCI and control subject groups. There was also a trend toward higher CRP levels in the SCI subjects, although the differences were not statistically significant ( $p > 0.05$ ). Furthermore, the only SCI subject with a Category II pressure ulcer exhibited higher H-FABP and CRP concentrations than all other subjects. Because the variations in each of the marker concentrations were smaller than the predicted increases after PUs, this combination of plasma markers may prove appropriate for the early detection of deep pressure ulcers.

## Microdialysis

To interrogate the internal state of the tissues, a minimally invasive technique, microdialysis, has been used. It represents a diffusion-based separation method that allows water-soluble analytes within the extracellular space to freely diffuse across a hollow fibre semi-permeable dialysis membrane (Fig. 1.6). This minimally invasive sampling technique was initially adopted in neuroscience to quantify chemicals related to neurotransmitters and energy utilization in the brain, but has been subsequently used for *in vivo* biochemical collection from fluid perfused through a range of tissues, including skin, tendon, muscle and gastrointestinal tract.



**Fig. 1.6** Top, schematic indicating the principles of the microdialysis technique and Bottom, images of its application at the forearm

As an example, it was employed to examine the temporal and spatial generation of cytokines in allergen-induced responses in human skin [47]. The study, involving a cohort of normotensive volunteers, employed multiplex cytokine array assays to distinguish the temporal and spatial profiles for skin-based proteins following both wounding and the development of allergenic inflammation. Results indicated an up-regulation of IL-1 $\alpha$ , IL-6 and IL-8 evident up to 6 h of sampling, whereas TNF $\alpha$  and other cytokines remained close to baseline at all times. However, it is clear that the tissue perturbation caused by the insertion of the catheter might itself influence the release of chemokines and cytokines [48]. Therefore the use of adequate controls are critical with this technique. In a current study, the authors have indicated that the diffusion of the analytes into the hollow fibres is not affected by external pressures applied to the skin of the forearm Accordingly, our research is focused on comparing the cytokine release in three phases, unloaded, loaded and reperfusion periods, with a view to identifying the altered profiles resulting from mechanical loading.

---

## Final Comments

In many situations of daily living, such as lying in bed and prolonged sitting, the skin is exposed to applied pressures, which will inevitably deform the soft tissue composite over bony prominences establishing an internal mechanical state. In some cases this results in tissue breakdown leading to the development of pressure ulcers. However the relationship between the measured interface or external pressures and the internal interstitial stresses/strains within the tissues is necessarily complex in nature. Thus the potential to interrogate the biochemical milieu of these internal tissues could provide an indication of their status, prior to their gross breakdown. There are a number of biofluids which can be collected directly at the skin surface or systemically in blood or urine, which contain concentrations of selected biomarkers indicative of early damage to skin and underlying soft tissues. Previous studies on both healthy volunteers and individuals at risk of developing PUs, have demonstrated the potential of some biomarkers, for example, sweat lactate, the pro-inflammatory cytokine, IL-1 $\alpha$  and CRP levels in blood. However, certain technical limitations remain before appropriate robust biosensors could be incorporated into a routine screening protocols to be used in conjunction with traditional risk assessment scales to assess vulnerable patients in hospital and the community. Current limitations include limited sample volumes, low concentration levels, particularly for cytokines and the temporal profiles and interaction of the biomarkers, each of which could be overcome with current analytical tools, sensing technologies and well designed test protocols. Moreover, micro-dialysis might prove valuable as a “gold standard” against which simple “paper-based” systems could be evaluated as point-of-care diagnostic sensors [49]. These system could incorporate micro-fluidics to improve the spatial and temporal profiles of the sampling method. Ultimately an ideal indicator of PU risk will carry information about the condition of the cells as a direct representation of the integrity of skin, fat and muscle tissues in both loaded and unloaded conditions.

## References

1. Coleman S, Nelson EA, Keen J, Wilson L, McGinnis E, Dealey C, Stubbs N, Muir D, Farrin A, Dowding D, Schols JM, Cuddigan J, Berlowitz D, Jude E, Vowden P, Bader DL, Gefen A, Oomens CW, Schoonhoven L, Nixon J. Developing a pressure ulcer risk factor minimum data set and risk assessment framework. *J Adv Nurs*. 2014;70(10):2339–52.
2. Schoonhoven L, Haalboom JR, Bousema MT, Algra A, Grobbee DE, Grypdonck MH, Buskens E, prePURSE study group. Prospective cohort study of routine use of risk assessment scales for prediction of pressure ulcers. *BMJ*. 2002;325(7368):797.
3. Blaisdell FW. The pathophysiology of skeletal muscle ischaemia and the reperfusion syndrome: a review. *Cardiovasc Surg*. 2002;10(6):620–30.
4. Knight SL, Taylor RP, Polliack AA, Bader DL. Establishing predictive indicators for the status of soft tissues. *J Appl Physiol*. 2001;90:2231–7.
5. Liao F, Garrison DW, Jan YK. Relationship between nonlinear properties of sacral skin blood flow oscillations and vasodilatory function in people at risk for pressure ulcers. *Microvasc Res*. 2010;80(1):44–53.
6. Jan YK, Brienza DM, Boninger ML, Brenes G. Comparison of skin perfusion response with alternating and constant pressures in people with spinal cord injury. *Spinal Cord*. 2011;49:136–41.
7. Bogie KM, Nuseibeh I, Bader DL. Early progressive changes in tissue viability in the seated spinal cord injured subject. *Paraplegia*. 1995;33:1441–7.
8. Coggrave M, Rose L. A specialist seating assessment clinic: changing pressure relief practice. *Spinal Cord*. 2003;41(12):692–5.
9. Oomens CWJ, Zenhorst W, Broek M, Hemmes B, Poeze M, Brink PRG, Bader DL. A numerical study to analyse the risk for pressure ulcer development on a spine board. *Clin Biomech*. 2013;28:736–42.
10. Chai CY, Bader DL. The physiological response of skin tissues to alternating support pressures in able-bodied subjects. *J Mech Behav Biomed Mater*. 2013;28:427–35.
11. Woodhouse M, Worsley PR, Voegeli D, Schoonhoven L, Bader DL. The physiological response of soft tissue to periodic repositioning as a strategy for pressure ulcer prevention. *Clin Biomech*. 2015;30:166–74.
12. Perkins MA, Osterhues MA, Farage MA, Robinson MK. A non-invasive method to assess skin irritation and compromised skin conditions using simple tape adsorption of molecular markers of inflammation. *Skin Res Technol*. 2001;7(4):227–37.
13. Pagnoni A, Kligman AM, el Gammal S, Stoudemayer T. Determination of density of follicles on various regions of the face by cyanoacrylate biopsy: correlation with sebum output. *Br J Dermatol*. 1994;131(6):862–5.
14. Bronneberg D, Bouten CV, Oomens CW, van Kemenade PM, Baaijens FP. An in vitro model system to study the damaging effects of prolonged mechanical loading of the epidermis. *Ann Biomed Eng*. 2006;34(3):506–14.
15. Bronneberg D. Biochemical markers for early detection of pressure ulcers. PhD Thesis, Technical University of Eindhoven; 2007.
16. de Wert LA, Bader DL, Oomens CW, Schoonhoven L, Poeze M, Bouvy ND. A new method to evaluate the effects of shear on the skin. *Wound Repair Regen*. 2015;23(6):885–90. <https://doi.org/10.1111/wrr.12368>.
17. Cornelissen LH, Bronneberg D, Bader DL, Baaijens FPT, Oomen CWJ. The transport profile of cytokines in epidermal equivalents subjected to mechanical loading. *Ann Biomed Eng*. 2009;37(5):1007–18.
18. Farrell, et al. Guidelines for diagnosis of cystic fibrosis in newborns through older adults: cystic fibrosis foundation consensus report. *J Pediatr*. 2008;153(2):S4–S14.
19. Van Heyningen R, Weiner JS. The effects of arterial occlusion on sweat composition. *J Physiol*. 1952;116(4):404–13.
20. Ferguson-Pell M, Hagsisawa S. Biochemical changes in sweat following prolonged ischemia. *J Rehabil Res Dev*. 1988;25(3):57–62.

21. Polliack AA, Taylor R, Bader DL. The analysis of sweat during soft tissue breakdown following pressure ischaemia. *J Rehabil Res Dev.* 1993;30(2):250–9.
22. Polliack AA, Taylor RP, Bader DL. Sweat analysis following pressure ischaemia in a group of debilitated subjects. *J Rehabil Res Dev.* 1997;34(3):303–8.
23. Granger DN, Korthuis R. Physiological mechanisms of post-ischemic tissue injury. *Annu Rev Physiol.* 1995;57:311–32.
24. Taylor RP, James T. The role of oxidative stress in the development and persistence of pressure ulcers. In: Bader DL, et al., editors. *Pressure ulcer research: current and future perspectives.* Berlin: Springer; 2005. p. 205–32.
25. Fox IH, Palella TD, Kelly WN. Hyperuricemia: a marker for cell energy crisis. *N Engl J Med.* 1987;317(2):111–2.
26. Woolliscroft JO, Fox JH. Increased body fluid purine levels during hypotensive events: evidence for ATP degradation. *Am J Med.* 1986;81:472–8.
27. Wang Y-N. The response of soft tissues to mechanical loads at different structural levels and the implications in their breakdown. PhD thesis, Queen Mary, University of London; 2000.
28. Bader DL, Wang Y-N, Knight SL, Polliack AA, James T, Taylor RP. Biochemical status of soft tissues subjected to sustained pressure. In: Bader DL, et al., editors. *Pressure ulcer research: current and future perspectives.* Berlin: Springer; 2005. p. 109–28.
29. McCord JM. Oxygen-derived free radicals in post-ischaemic tissue injury. *N Engl J Med.* 1985;312:159–63.
30. Walubo A, Smith PJ, Folb PI. Oxidative stress during anti-tuberculosis therapy in young and elderly patients. *Biomed Environ Sci.* 1995;8:106–13.
31. Mena-Bravo A, Luque de Castro MD. Sweat: a sample with limited present applications and promising future in metabolomics. *J Pharm Biomed Anal.* 2014;90:139–47.
32. Dutkiewicz EP, Lin JD, Tseng TW, Wang YS, Urban PL. Hydrogel micropatches for sampling and profiling skin metabolites. *Anal Chem.* 2014;86(5):2337–44.
33. Derbyshire PJ, Barr H, Davis F, Higson SP. Lactate in human sweat: a critical review of research to the present day. *J Physiol Sci.* 2012;62(6):429–40.
34. Kutysenko VP, Molchanov M, Beskaravayny P, Uversky VN, Timchenko MA. Analyzing and mapping sweat metabolomics by high-resolution NMR spectroscopy. *PLoS One.* 2011;6(12):e28824.
35. Marques-Deak A, Cizza G, Eskandari F, Torvik S, Christie IC, Sternberg EM, Phillips TM. Measurement of cytokines in sweat patches and plasma in healthy women: validation in a controlled study. *J Immunol Methods.* 2006;315(1–2):99–109.
36. Rassaei L, Olthuis W, Tsujimura S, Sudhölter EJ, van den Berg A. Lactate biosensors: current status and outlook. *Anal Bioanal Chem.* 2014;406(1):123–37.
37. Sonner Z, Wilder E, Heikenfeld J, Kasting G, Beyette F, Swaile D, Sherman F, Joyce J, Hagen J, Kelley-Loughnane N, Naik R. The microfluidics of the eccrine sweat gland, including biomarker partitioning, transport, and biosensing implications. *Biomicrofluidics.* 2015;9(3):031301.
38. Yaggie JA, Niemi TJ, Buono MJ. Adaptive sweat gland response after spinal cord injury. *Arch Phys Med Rehabil.* 2002;83(6):802–5.
39. Bonnefoy M, Coulon L, Bienvenu J, Boisson RC, Rys L. Implication of cytokines in the aggravation of malnutrition and hypercatabolism in elderly patients with severe pressure sores. *Age Ageing.* 1995;24(1):37–42.
40. Scelsi R. Skeletal muscle pathology after spinal cord injury: our 20 year experience and results on skeletal muscle changes in paraplegics, related to functional rehabilitation. *Basic Appl Myol.* 2001;11(2):75–85.
41. Rapp LM. Physiological changes in tissues denervated by spinal cord injury tissues and possible effects on wound healing. *Int Wound J.* 2008;5(3):435–44.
42. Garber SL, Rintala DH, Hart KA, Fuhrer MJ. Pressure ulcer risk in spinal cord injury: predictors of ulcer status over 3 years. *Arch Phys Med Rehabil.* 2000;81(4):465–71.
43. Chen Y, Devivo MJ, Jackson AB. Pressure ulcer prevalence in people with spinal cord injury: age-period-duration effects. *Arch Phys Med Rehabil.* 2005;86(6):1208–13.



44. Rodriguez GP, Claus-Walker J. Biochemical changes in skin composition in spinal cord injury: a possible contribution to decubitus ulcers. *Paraplegia*. 1988;26(5):302–9.
45. Rodriguez GP, Claus-Walker J, Kent MC, Garza HM. Collagen metabolite excretion as a predictor of bone- and skin-related complications in spinal cord injury. *Arch Phys Med Rehabil*. 1989;70(6):442–4.
46. Loerakker S, Huisman ES, Seelen HA, Glatz JF, Baaijens FP, Oomens CW, Bader DL. Plasma variations of biomarkers for muscle damage in male nondisabled and spinal cord injured subjects. *J Rehabil Res Dev*. 2012;49(3):361–72.
47. Clough GF, Jackson CL, Lee JJ, Jamal SC, Church MK. What can microdialysis tell us about the temporal and spatial generation of cytokines in allergen-induced responses in human skin in vivo? *J Invest Dermatol*. 2007;127(12):2799–806.
48. Stenken JA, Church MK, Gill CA, Clough GF. How minimally invasive is microdialysis sampling? A cautionary note for cytokine collection in human skin and other clinical studies. *Am Assoc Pharm Scient*. 2010;12(1):73–8.
49. Katis IN, Holloway JA, Madsen J, Faust SN, Garbis SD, Smith PJ, Voegeli D, Bader DL, Eason RW, Sones CL. Paper-based colorimetric enzyme linked immune-sorbent assay fabricated by laser induced forward transfer. *Biomicrofluidics*. 2014;8(3):036502.
50. Mirtaheri P, Gjøvaag T, Worsley PR, Bader DL. A review of the role of the partial pressure of carbon dioxide in mechanically loaded tissues: the canary in the cage singing in tune with the pressure ulcer mantra. *Ann Biomed Eng*. 2015;43(2):336–47.
51. Bronneberg D, Spiekstra SW, Cornelissen LH, Oomens CW, Gibbs S, Baaijens FP, Bouten CVC. Cytokine and chemokine release upon prolonged mechanical loading of the epidermis. *Exp Dermatol*. 2007a;16(7):567–73.



# The Critical Characteristics of a Good Wheelchair Cushion

# 2

Ayelet Levy, Naama Shoham, Kara Kopplin,  
and Amit Gefen

## Introduction

Pressure ulcers (PUs) are known to develop when soft weight-bearing tissues are subjected to sustained increased deformations, usually between a bony prominence and an external support surface [1–3]. PUs are commonly staged with respect to the depth on the ulcer and the tissues it involves, with the most severe ulcers, which involve muscle and bone tissues, termed deep tissue injuries (DTI). A number of contributing or confounding factors, such as impaired mobility and sensory capacities, alterations in skin status and moisture, poor nutrition and impaired perfusion, are also associated with PU development [2, 4]. Hence, populations at risk are the elderly and frail, patients post spinal cord injury (SCI), brain trauma or stroke, patients with impaired mobility or sensory capacities, or even patients who undergo prolonged surgery, as these individuals are more likely to spend prolonged periods in a static position, and are also less likely to readily detect the risk [2]. The prevalence of PUs in the acute, critical and pediatric care settings can be as high as 46%, 45.5% and 72.5%, respectively, while the incidence of PUs in the aged care settings can be as high as 59% [5]. The most prevalent locations for PU development are the sacrum (28.3%), buttocks (17.2%) and heels (23.6%) [6], which are associated with both prolonged sitting and supine lying. The average monthly cost per such case, e.g. to the Canadian healthcare system, was reported to be \$4745 [7]. The total cost to manage a single full-thickness PU in the United States can be as high as \$70,000, and PU annual treatment costs to the US healthcare system are estimated to be 11 billion dollars [8]. Many studies have documented the increased morbidity and

---

A. Levy · N. Shoham · A. Gefen (✉)  
Department of Biomedical Engineering, Faculty of Engineering, Tel Aviv University,  
Tel Aviv, Israel  
e-mail: [gefen@eng.tau.ac.il](mailto:gefen@eng.tau.ac.il)

K. Kopplin  
Efficacy Research, Standards and Compliance, ROHO, Inc, Belleville, IL, USA

mortality associated with PUs in both community and hospital settings, as well as their significant contribution to healthcare costs and lengths of hospital stay [9].

There is evidence in the literature that PUs and PU interventions have a significant impact on health-related quality of life and inflict substantial burden on patients [10]. Reported that the majority of patients indicated that suffering PUs affected their lives emotionally, mentally, physically and socially [11]. While the most common complaint is the pain, patients also express their discomfort with the appearance, smell and fluid leakage from the ulcer. PU patients are often dependent on others to manage and care for their ulcer and describe their discomfort with the dressing materials and pressure-relieving equipment [11]. Since treatment of PUs is medically challenging, costly, and very unpleasant for sufferers, efforts are put towards risk assessment and prevention strategies [2], which in turn, depends on thorough understanding of the aetiology.

## Pressure Ulcers in the Spinal Cord Injury Population

Sitting-acquired PUs are common in individuals who chronically depend on a wheelchair for mobility, such as those with a SCI. These patients spend up to 18 h a day in a wheelchair and often suffer from impaired sensation in their buttocks, preventing them from detecting the risk in a timely manner. In fact, in Europe as well as in the U.S., at least one in every four persons with SCI is affected by PUs, with the most common site being under or around the ischial tuberosities (ITs) [12, 13].

In the weeks and months following the acute injury, disuse-related pathoanatomical and pathophysiological changes occur in the buttocks, as tissues adapt to the chronic sitting and inactivity of muscular innervations. Perhaps the most documented is the disuse-induced muscular atrophy (MA), which includes massive loss of muscle volume [14], thinning of muscle fibers, and increased numbers of fast-twitch over slow-twitch fibers. The MA onsets as early as 4–6 weeks after the acute injury, and progresses at a noticeable rate for at least several months, after which the rate of muscle wasting tends to slow down, but the absolute tissue loss persists [15–17]. High levels of intramuscular fat infiltration (FI) are also prevalent after a SCI. Intramuscular adipose depots can be found in able-bodied individuals as well, however, while the normal intramuscular FI level is 1–2% of the total body fat [18], FI levels post SCI can be up to 4-times greater than that. The chronic sitting and disuse also affect the weight-bearing bony structures. Specifically, substantial bone loss has been described in a number of cross-sectional studies, with the time course of bone loss depending on the bone compartment. Rapid loss of trabecular bone may level off 1–3 years post injury, while slower cortical bone loss appear to decrease progressively beyond 10 years post injury [19]. Furthermore, bone shape adaptation (BA), namely flattening of the tips of the ITs in response to the sustained sitting loads has been reported in the literature [20–22]. These phenomena are likely to affect the risk of PUs in SCI patients. As the alterations of the weight-bearing structures occur, the internal loading states in the tissues are affected.

Furthermore, initial weight-loss followed by considerable weight-gain are very common in the few months and years following a SCI. Specifically, there is tendency for an initial weight-loss of 5.3–9.1 kg at the short term (within weeks) after the acute injury, which is followed by a major weight-gain of 1.3–1.8 kg *per week* during the rehabilitation phase [23, 24]. The decrease and increase in the body-weight are due to a hypercatabolic ‘shock’ response and a lower-level of physical activity, respectively [25].

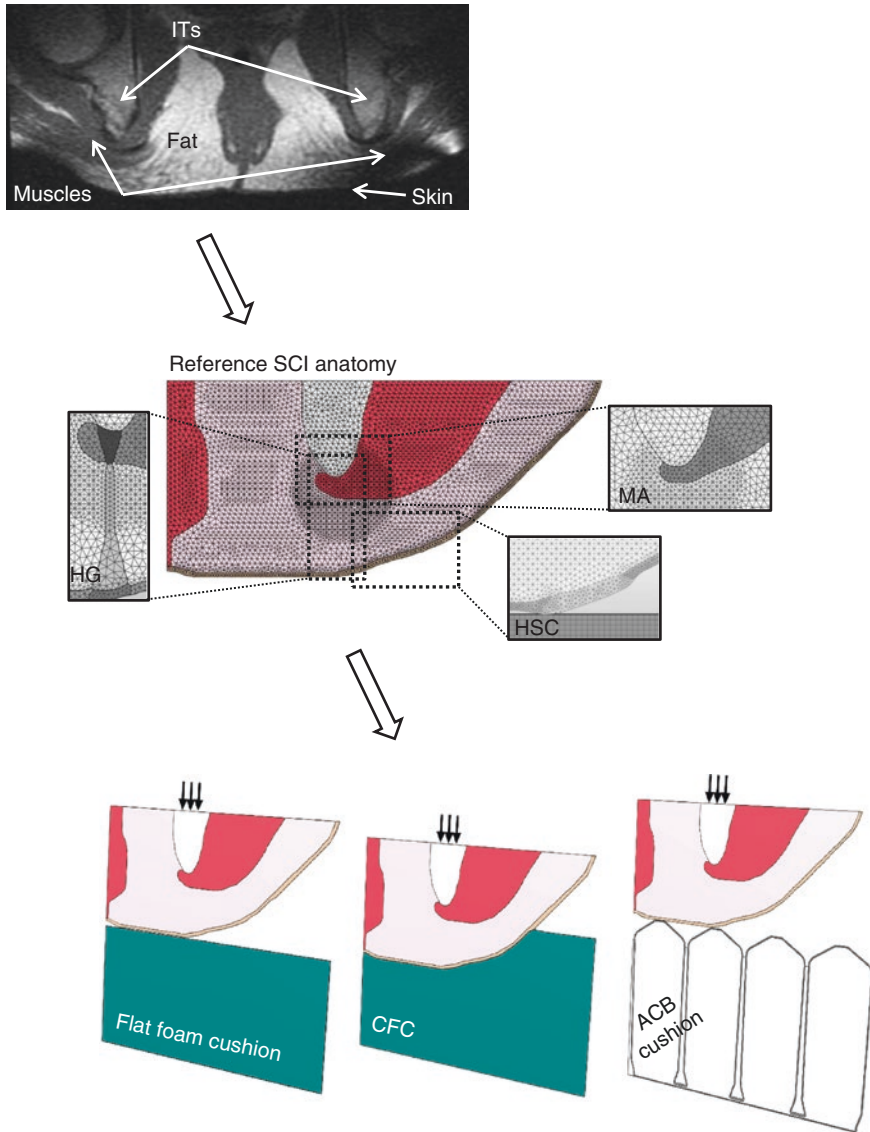
In addition, one may consider a patient who already had PUs in the past, which healed but left scars in the skin, fat and/or muscle tissues, and hence the mechanical properties of these soft tissues of the buttocks are locally abnormal and inhomogeneous, which in turn affects internal tissue loads in the scars and also in adjacent, non-scared tissues.

## Computational Modeling for Studying the Efficacy of Wheelchair Cushions

The finite element (FE) method is a computational technique for finding the internal mechanical loads, (deformations, strains and stresses) in structures having complex shapes and multiple materials. In practice, the complex geometry of the structure is divided into numerous small elements – each with a simple geometry (such as pyramids), and the differential governing equations that describe the mechanical interactions are solved numerically for every element with respect to its neighboring elements, in order to ultimately construct the solution to the entire structure.

In order to examine the effects of (age-related) skin stiffness, soft tissue scarring, bone shape-adaptation, MA, FI and changes in BMI post a SCI, on the mechanical loads developing in the soft tissues of the buttocks of a SCI patient, 54 model variants of the seated buttocks were developed [26–29] (Fig. 2.1). Each model variant included the ischial tuberosities (ITs), the gluteus maximus skeletal muscles and the colon smooth muscle, subcutaneous fat tissue, skin and either a flat foam cushion, a contoured foam cushion (CFC) or an air-cell-based (ACB) cushion for support. The model variants differed in support structure and stiffness properties, IT anatomy, fat and muscle volume and structure and soft tissue global stiffness or local scarring. Each of the model variants was based on a single, coronal MRI slice through the buttocks, acquired from a male subject 1 year after a SCI (age 21 years, weight 90 kg) who was scanned in an open MRI, sitting on a rubber tire (non-weight-bearing) and then fully weight-bearing on a semi-rigid flat support in our previous work [22] (Fig. 2.1). To generate the reference anatomical model, the non-weight-bearing MRI slice was loaded to the ScanIP® module of Simpleware® [30], where it was automatically segmented to the different tissue components listed above and then uniformly extruded to a 4-mm depth, representing the MRI resolution in the Z-axis. Mechanical properties of all tissues were adopted from the literature [26–29].

Next, we artificially introduced pathoanatomical variations and different supports to form the different model variants (Fig. 2.1). First, we investigated how thin, flat or hypertrophic scars in the skin affect the developing soft tissues shear loads



**Fig. 2.1** Computational (finite element) modeling of the buttocks of an individual with a spinal cord injury (SCI): (a) Anatomical components of the model variants, as seen in the MRI slice. (b) Three-dimensional mesh of the reference anatomy and three of the considered pathoanatomical variations, for example: (1) *HG* hourglass-shaped scar in the muscle, fat and skin tissues, (2) *MA* muscular atrophy, (3) *HSC* hypertrophic skin scar. (c) General loading configurations of the buttocks when seated on a flat foam cushion, a contoured foam cushion (CFC) or an air-cell-based (ACB) cushion

during sitting-down on flat foam cushions with different stiffness properties, in ‘young’ or ‘aged’ skin conditions [26]. Adding these skin scars into the model allowed investigations of how shear loading may develop when the skin is

supposedly more fragile or already locally damaged. Next, we examined how BA, MA, muscle spasms or a combination of the above, affect peak soft tissue stresses when seated on two flat foam cushions or an ACB cushion [27]. The geometry of the ACB cushion was based on a 4-mm slice through the pre-inflated air cells and its mechanical properties were evaluated using a simple buckling experiment detailed in [27]. Then, we looked into how muscle, fat and skin tissue scarring in a patient with a history of PUs in their buttocks, affect the resulting mechanical stresses in these soft tissues during sitting on the aforementioned ACB cushion [28]. We introduced ten scars of different shapes and dimensions to the model variants, corresponding to the modeling work of Sopher et al. [31], to describe cases of patients who already suffered PUs in their buttocks, which healed but left scars in their soft tissues. Finally, we explored how changes in BMI, intramuscular FI, MA and combinations of these conditions, affect the internal soft tissue loads in the buttocks of SCI patients, while sitting on a CFC, which has been fitted close to the time of the injury but has not been replaced in subsequent years [29].

Loading configurations were chosen to simulate descent of the ITs downwards, as these bones transfer a portion of the bodyweight to the overlying soft tissues during sitting. When tested on flat foam cushions or the CFC, uniform pressure was applied downwards on the top of the ITs with its magnitude calibrated by fitting the resulting vertical displacement of the ITs in preliminary analyses to the empirical descent of the ITs which was measured by comparing the non-weight-bearing and weight-bearing MRI scans [22]. When tested on the ACB cushion, a downwards displacement was prescribed on the superior surface of the IT so that the final distance between the skin and the base of the ACB cushion (the clearance above “bottom-out”) was 32 mm, slightly above the 1-inch distance recommended for keeping away from bottoming-out [32]. The front and back planes of the buttocks and cushions were fixed in the perpendicular direction to assure thin slice model conditions. The inferior surface of the cushion was fixed for all translations and rotations, and tied interfaces were defined between all the tissue components. Frictional sliding was defined between the skin and the cushions with the coefficient of friction set to 0.4 in all simulations.

Meshing the model variants was performed using ScanIP® module of Simpleware® [30], with specific refinements to the skin and to the muscle and fat tissues near the tip of the ITs. Tetrahedral elements were assigned to the tissues, CFC and ACB cushion while hexahedral elements were assigned to the flat foam cushions. The FE simulations were all set up using PreView of FEBio, analyzed using the Pardiso linear solver of FEBio in its structural mechanics mode, and post-processed using PostView of FEBio [33].

---

## Critical Characteristics of Effective Wheelchair Cushion Designs

*Now that the etiology of PUs is better understood, the pathoanatomical variations in individuals have been considered, and the aforementioned computer simulation tools are available, five key characteristics of effective wheelchair cushion designs can be identified.*

## Immersion and Envelopment

The basic elements that, in combination, represent the potential cushioning performance of a cushion are immersion (the depth that a body penetrates into the surface), and envelopment (the intimacy of the cushion to the body). The ISO defines the characteristic of envelopment as “the ability of a cushion to conform, so to fit or mould around the irregular shape of the body” [34]. The importance of these characteristics are articulated by the ISO wheelchair cushion testing standards committee in the introduction of the Wheelchair Seating—Part 12: Envelopment testing technical specification, which provides detail of test equipment and method, for the measurement of “performance” of a wheelchair cushion intended to use immersion and envelopment to reduce local areas of pressure (by effectively supporting more tissue) [35].

In our biomechanical analysis, in order to quantify the extent of immersion and envelopment of the buttocks into the cushions a parameter  $\alpha$  was defined, being the percentage of skin area that is in full contact with the cushion surface [27]. Stress concentrations formed in the gluteus muscle near the tip of the IT in both ACB and foam cushion simulations, but immersion was considerably greater in the case of an ACB cushion. Accordingly,  $\alpha$  for the ACB cushion increased up to 91–93%, but only reached 58–65% for the foams. Consistent with the superior fit of the ACB cushion to the body contours, peak stress components in all tissues were four-orders-of-magnitude lower with the ACB cushion, with respect to the foams. We attribute this advantage of the ACB cushion in lowering peak tissue stresses to the substantially greater buttocks immersion it facilitates, which creates a much larger contact area for load transfer. As the contact area between the cushion and the skin increases, loads are transferred more uniformly, minimizing potentially hazardous areas of stress concentrations. Since sustained tissue loads imply safe sitting time for wheelchair users, as suggested in [36, 37], it appears that ACB cushions hold a benefit over foam cushions by providing greater immersion, which lowers internal tissue loads.

When we looked at the process of weight regaining on flat foam cushions, for example after completing a pushup, we found that skin shear loads exhibited a strongly non-linear increase, with a greater slope during the first half of the loading period, while fat shear loads increased linearly through the entire time course of loading [26]. This finding suggests that when sitting on standard foam cushions, the more sensitive period with respect to skin integrity is during initial skin-support contact. Since the skin-support contact area during the initial contact is relatively small, loads are temporarily more concentrated than when reaching full weight bearing. This phenomenon emphasizes the importance of large contact area for load transfer, as reflected in appropriate immersion and envelopment of the buttocks during sitting.

## Adjustability to the Uniqueness of the Individual, at the Initial Fitting

Each and every user of a wheelchair cushion has morphologies, pathologies, and risks of tissue breakdown that are unique to them. While not all of the risks can be

reduced, the cushion plays an important role in preventing PUs by having the capability of intimately adjusting to the individual, to achieve the desired immersion and envelopment to minimize the deformation that leads to internal tissue stresses and strains.

In our analysis, we introduced several particular risks, the first being the risk from previous PUs and the resulting scars. Investigating the influence of soft tissue scarring on peak tissue stresses during sitting or repositioning on flat foam cushions revealed that skin shear stresses increase in and around the (less deformable) scar. Importantly, the extent of the increase in loads within and adjacent to the scars strongly depended on the scar geometry, with the highest skin loads developed when a hypertrophic scar was present. This indicates that when sitting on a flat foam cushion, scarred skin is more vulnerable to a second breakdown event, especially if a thick (hypertrophic) scar has formed, which delineates new implications for the treatment of existing wounds to minimize hypertrophic scarring, and for risk assessment of individuals with a history of PUs [26]. Interestingly, when seated on an ACB cushion, soft tissue scarring induced, in general, lower peak stress values in the soft tissues of the buttocks with respect to the stress levels in the (non-scarred) reference case [28]. Peak effective and shear stresses in the skin decreased by up to 40% in all the simulated scar cases, while peak compressive and tensile stresses decreased by up to 41% in 8 out of 10 simulated scar cases. Likewise, peak stresses in fat tissue of scarred buttocks decreased on the ACB cushion with respect to the reference case by 40–65%, while gluteus muscle peak effective and shear stresses decreased by 10–45% in 9 of the 10 scars simulated. Furthermore, we tested the most severe soft tissue scar cases on a flat foam cushion, for direct comparison. We found that on a flat foam cushion, severe hour-glass shaped scar, involving muscle fat and skin tissues, causes an average increase of 155% and 70% in peak fat and muscle stresses, respectively, when compared against the reference, non-scarred, SCI anatomy on the same flat foam cushion. We concluded that the adjustability of the ACB cushion allows for improved stress distributions in the soft tissues of the buttocks, in the presence of scarred, stiffer tissue areas, compared to flat foam cushions.

We also considered the specific effects of bone adaptation (BA), muscle atrophy (MA), muscle spasms, and since an individual may experience all of these effects, the combination of all of the above were considered [27]. Sitting on the ACB cushion resulted in a substantially different loading state in the buttocks tissues with respect to flat foam cushions when all of these potential conditions were considered. Specifically, while BA increased peak stresses in muscles when seated on foams (8% increase in effective stress), the ACB cushion consistently promoted the opposite effect (41% decrease in effective stress). Likewise, though MA increased fat and skin effective stresses when sitting on the foams (by 57% and 37%, respectively), the ACB cushion was again able to reduce these stresses (by 60% and 23%, respectively) [27]. Therefore, the ACB cushion holds an additional advantage over foams when it comes to coping with and adjusting to the aforementioned chronic SCI pathoanatomies.

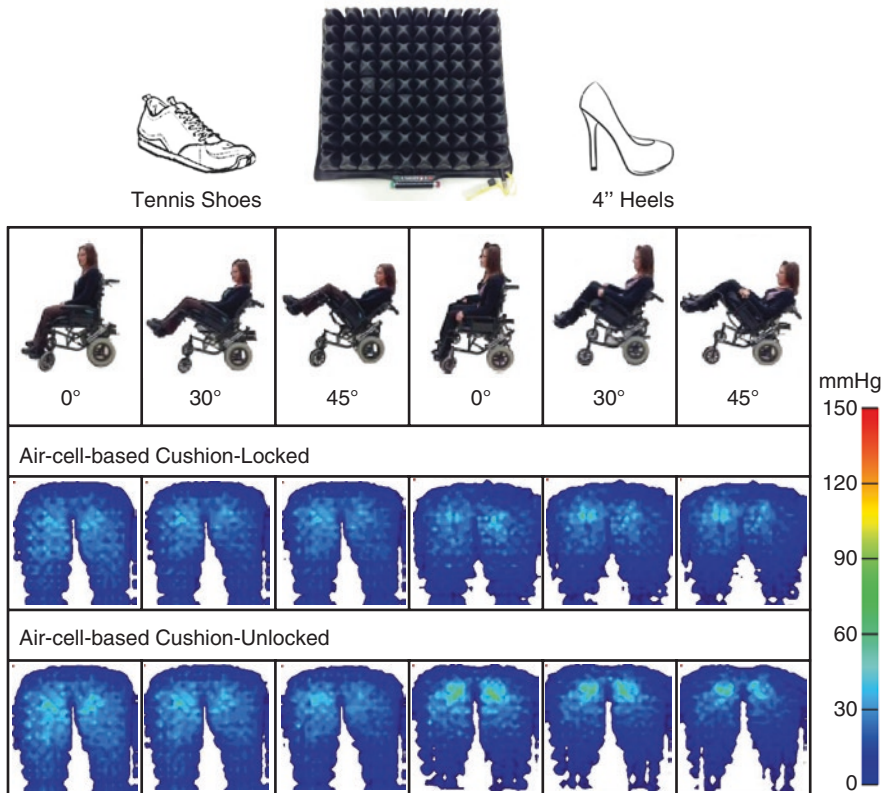


## **Adaptability to Movement and Activities of the Individual Throughout the Day**

Our recent research [27] has demonstrated that a critical characteristic of effective wheelchair cushions is their ability to adjust to the body by providing adequate immersion and envelopment, which can greatly reduce tissue deformations, thereby preventing the tissue and cell damage associated with DTI. In Gefen [38], the remarkable disuse-related physiological changes that occur to the seated body over time have been reviewed [38]. Both papers point to a critical need for cushions to adjust to the body of the individual, both at the initial seating assessment as well as when changes occur over time. There exists another critical characteristic of wheelchair cushions however; the ability to adapt to changes in positioning associated with daily living, without the user having to actively adjust the cushion. While many cushions meet the first three characteristics we have described, there are very few which can also adapt to these activities of daily living without a conscious, active intervention by the individual. An example focusing on footwear follows. We studied two cushion technologies and five cushion variations. All cushions were code-verified in the US Medicare system as “adjustable skin protection cushions” and adjusted per manufacturer’s recommendations. Refinements were made using an XSensor pressure mapping system as in rehabilitation clinics, to achieve maximum contact area and minimize peak pressures (Fig. 2.2). A test subjects wearing tennis shoes was asked to sit in a Tilt-in-Space Chair set to 0°, 30° and 45° (without further adjustments to the cushions) and pressure maps were recorded. The footwear was then changed to four” high heels and data collection was repeated (Fig. 2.2). While inherent differences were observed across product performances, we found that in some products, changing the shoe type had a dramatic influence on peak pressures and contact areas for all postures. Measures of cushion efficacy in protecting users must suitably assess the way the cushion performs as the user’s body and function change over long times. Equally important however, is the cushion’s ability to automatically adapt to changes in the user’s sitting position throughout the day, which is influenced by numerous factors, including the wardrobe as shown here. It is unrealistic to expect that users would manually adjust their cushion each time they change clothes or perform an activity, so the self-accommodation of these common changes in positioning, and even wardrobe, is a critical characteristic of a good wheelchair cushion.

## **Adjustability to the Individual, Throughout the Subsequent Weeks, Months, and Years**

Numerous wheelchair cushions are sufficiently adjustable to meet the needs of the individual, initially, to immerse and envelop the body. However, while many cushion succeed in this aspect, not all of them have the capability of accommodating all of the changes that may occur to the body during the useful life of the cushion. In our analysis, when simulating bodyweight changes which are typical to the first



**Fig. 2.2** Contact pressure maps of a test subject sitting on an air-cell-based (ACB) cushion, wearing either tennis shoes or four” heels, in a Tilt-in-Space chair set to 0°, 30° and 45°. This is one example of a superior performance of the ACB cushion technology, as it automatically adapts to changes in the user’s sitting position and is negligibly affected by wardrobe, both in a constricted airflow configuration (**Locked**) and in a free airflow configuration (**Unlocked**)

months and years after the acute injury (between  $-25\%$  and  $+40\%$  fat mass) on CFCs, we found that effective and shear strains and stresses increased considerably with the chronological time-course of disuse [29]. For example, the peaks and respective ranges of effective and shear strains which developed in fat tissue increased by  $\sim 220\%$  and  $110\%$ , respectively, in the model variant where the fat mass was increased by  $40\%$ , with respect to the ‘ideal fit’ reference model. In addition to that, the inhomogeneity in the strain and stress distributions in muscle tissue also increased with the simulated time-course post injury, resulting in greater strain and stress values in the model variants where the fat mass was increased [29]. FI and MA exacerbated the inhomogeneity of strain and stress distributions in both fat and muscle tissues and resulted in increased strain and stress values, particularly when severe weight-gain (additional  $40\%$  fat) was considered as well. For example, the peak effective and shear strains which developed in muscle tissue when a combination of severe weight-gain and severe FI was simulated increased to  $24\%$  and  $15\%$ ,

respectively, compared to strain values of 11% and 6% in the ‘ideal fit’ case. Combining these, we found that a CFC which has been fitted at a time close to the SCI but has not been replaced for several years thereafter substantially loses its efficacy in protecting patients from developing PUs, particularly DTIs, since shear loads and deformations are increasing internally in the soft tissues as the body responds to the chronic sitting and disuse [29]. Considering that within several months, at the latest, a SCI patient is expected to gain bodyweight and additional fat mass, extra-muscularly and intramuscularly, lose gluteal muscle mass and experience flattening of the ITs due to BA, the individual’s anatomy is, in fact, changing progressively and remarkably, but the CFC does not. As these changes take place and progress over time, the cushion’s contoured design quickly becomes irrelevant to the altered anatomy, both in terms of the adapted external buttock surfaces and the internal pathoanatomy, which can place patients at a considerable risk for PUs and DTI. Therefore, our simulations results highlights the importance of sufficient ‘adjustability’ over time, to maintain ideal immersion and envelopment, as a critical design feature for any cushion that is meant to protect against PUs.

### **Durability, Over Time, Throughout the Weeks, Months, and Years**

We have demonstrated the need of the cushion to adapt to the individual over time to maximize immersion and envelopment; however, in order to maintain the level of efficacy, the cushion must not only be adjustable, but also durable. Recently, Sprigle and Delaune [39] published their research comparing the performances of foam cushions, gel-filled cushions, and air cushions [39]. Their testing revealed that foam cushions have a much higher prevalence of fatigue, as compared to air-filled cushions and gel-filled cushions. Twenty-one percent of foam cushions, 20% of gel-filled cushions, and 16% of air-filled cushions showed visible damage throughout the duration of the study. Furthermore, they showed that foam cushions used 12 h per day for longer than a year were 7 times more likely to have tears, 2.23 times more likely to be discolored, and 3 times more likely to show brittleness than those foam cushions used for under 12 months. In Ferguson-Pell [40], the fact that foam cushions deteriorate with time, even when they are not being used, is highlighted [40]. This deterioration is caused by the brittleness of the polymer matrix, leading to fractures and softening of the product. Soiling and liquid products will further break down the foam, as they are particularly susceptible to moisture. The longer the foam cushion is in use, the greater and the faster the damage will progress. Gel cushions also show age, often times developing hard or consolidated regions that need to be kneaded to break up and to help prolong the lifespan of the product.

The ISO wheelchair seating working group (ISO/TC 173/SC 1/WG11) has recognized the importance of performing bench testing of wheelchair cushions, while simulating aging of the products, to capture the deterioration in efficacy [34]. The standard ISO 16840-6 “Wheelchair Seating—Part 6; Determination of the changes in properties following simulated extended use—seat cushions” introduces this

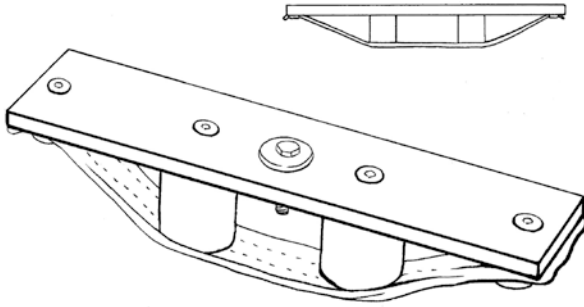
critical need to evaluate cushion performance over time [41]. First, the cushion is tested to characterize the properties of a new cushion, then it is subjected to multiple simulated aging processes, and finally re-tested to characterize the changes in properties. The suggested aging processes include thermal accelerated aging, bacterial, urinary and faecal soiling, disinfection, laundering, and ultraviolet and ozone exposure, all of which can be expected during the life of the cushion.

---

## The Impact of Research on Industry, Regulation and Reimbursement Policies

Science and public policy are in a virtual “tug-o-war” regarding beneficiary access to the goods and services that address their needs. When credible science exists then policy makers are compelled to take notice and will find it difficult to ignore in establishing coverage and payment policies. However, when scientific knowledge is insufficient, and this may still be the case in PU prevention and treatment research, policymakers are prone to establishing coverage and payment rules that primarily focus on financial objectives, or are biased towards broad characterization and commoditizing of medical equipment, with less attention to ensuring that products are indeed capable of meeting the individual’s medical needs. The problems that this creates are exacerbated by the fact that health care policies, coverage and payment are often being compartmentalized by care settings with no consideration of the individual’s care and treatment throughout the continuum of care. Over time, this may actually increase the overall costs to the individual and the healthcare system, as the individual’s needs are unmet and further damage occurs. For example, if certain wheelchair cushions that are prescribed and reimbursed for prevention or care of PUs do not actually provide the intended benefits to the individual (though policy makers assumed they would, due to a gap in understanding), the prevalence and incidence of PUs in the wheelchair user population will actually rise, thus pushing the healthcare costs upwards.

Initial steps in bridging this gap were taken in the early 2000s in the US, when the Medicare system adopted a method of evaluating the depth of supported immersion a cushion which is considered a “skin protection cushion” could provide, specifically HCPCS (Healthcare Common Procedure Coding System) codes E2603, E2604 (“nonadjustable skin protection seat cushions”), and E2622, E2623 (“adjustable skin protection seat cushions”). An analog of the pelvis, proposed by Springle et al. [42], was developed for bench testing, constructed of two inner cylinders, which represent the position of the ischial tuberosities, and two outer cylinders, 40 mm higher, which represent the relative positions of the greater trochanters [42] (Fig. 2.3). The test method of using a loaded contour jig is required by the Durable Medical Equipment Pricing Data Analysis and Coding (DME PDAC), a Medicare contractor who evaluates cushions and classifies them by Medicare HCPCS codes (<https://www.dmepdac.com/>). This coding determines which cushions can be prescribed to individuals, with costs reimbursed by the Medicare system. It is therefore a critical function intended to ensure patient access to appropriate medical equipment.



**Fig. 2.3** An analog of the pelvis, proposed by Springle et al. [42], constructed of two inner cylinders, which represent the position of the ischial tuberosities, and two outer cylinders, 40 mm higher, which represent the relative positions of the greater trochanters

The loaded contour test does provide a rudimentary method of evaluating whether a cushion may have the depth capacity to accommodate the immersion of the pelvis in a standard and overload condition, and it does serve as a simple threshold that can eliminate cushions from making a skin protection claim if they do not pass this test. However, a cushion could easily be designed for the sole purpose of passing this specific test, without providing clinical benefit. Additionally, the standard requires the cushion to be re-tested after simulated aging of 18 months, but no simulated aging techniques are recommended. With the publication of ISO 16840–6, the hope is that this new wheelchair cushion aging standard will be adopted by the Medicare system in part or in whole to provide definition of how the cushions should be aged. Furthermore, the term “adjustable” is applied to the cushion codes E2622 and E2623, which must meet all of the requirements of the non-adjustable cushions.

---

## Summary and Conclusions

There is a growing understanding that appropriate immersion and envelopment of the body into a wheelchair cushion are key factors in protecting patients against sitting acquired PUs, as they allow for improved dissipation of soft tissue loads and deformations. A good wheelchair cushion should first be capable of accommodating the seated buttocks, providing the adequate immersion and envelopment of the seated individual, during the initial seating assessment. This feature was acknowledged when the Medicare system adopted a method of evaluating the depth of supported immersion a cushion provides to determine whether it should be classified as a “skin protection cushion”. A good wheelchair cushion should be able to conform to individuals with different anatomies, or sometimes disuse-related pathoanatomies, and offer the optimal biomechanical conditions in the soft weight-bearing tissues of the buttocks. Then, the cushion should be able to maintain its efficacy over the time of

intended use. It should also be able to accommodate changes in posture and weight shifts associated with daily living, and conform to the remarkable disuse-related anatomical and physiological changes, which are expected in the months and years following a SCI. Furthermore, the cushion should maintain its physical and mechanical properties as well as its performance over time and despite exposure to various degenerating conditions, which can be expected during the life of the cushion.

In this chapter, we demonstrate the novel use of FE computational modeling in wheelchair cushion assessment and its ability to isolate different risk factors associated with either the cushion or the individual. Given the advances in understanding that tissue deformation is a key contributor to DTI and PUs, and the availability of new tools to assess relative protection against deformation through immersion and envelopment, during everyday life, over time as the individual changes, and over time as the cushion changes, there is a considerable gap between public policy and the tests which are currently applied to evaluate the efficacy of cushions, and the challenges and measures that should be applied.

---

## References

1. Gefen A. The biomechanics of sitting-acquired pressure ulcers in patients with spinal cord injury or lesions. *Int Wound J*. 2007;4:222–31.
2. National Pressure Ulcer Advisory Panel, European Pressure Ulcer Advisory Panel and Pan Pacific Pressure Injury Alliance. *Prevention and Treatment of Pressure Ulcers: Quick Reference Guide*. In: Emily Haesler, editor. Osborne Park, Western Australia: Cambridge Media; 2014.
3. Coleman S, Nixon J, Keen J, Wilson L, McGinnis E, Dealey C, Stubbs N, Farrin A, Dowding D, Schols JM, Cuddigan J, Berlowitz D, Jude E, Vowden P, Schoonhoven L, Bader DL, Gefen A, Oomens CW, Nelson EA. A new pressure ulcer conceptual framework. *J Adv Nurs*. 2014;70(10):2222–34.
4. Coleman S, Gorecki C, Nelson EA, Closs SJ, Defloor T, Halfens R, Farrin A, Brown J, Schoonhoven L, Nixon J. Patient risk factors for pressure ulcer development: systematic review. *Int J Nurs Stud*. 2013;50(7):974–1003.
5. Pieper B, National Pressure Ulcer Advisory Panel, editors. *Pressure ulcers: prevalence, incidence and implications for the future*. Washington: NPUAP; 2012.
6. VanGilder C, Macfarlane GD, Meyer S. Results of nine international pressure ulcer prevalence surveys: 1989 to 2005. *Ostomy Wound Manage*. 2008;54(2):40–54.
7. Chan BC, Nanwa N, Mittmann N, Bryant D, Coyte PC, Houghton PE. The average cost of pressure ulcer management in a community dwelling spinal cord injury population. *Int Wound J*. 2013;10(4):431–40.
8. Duncan KD. Preventing pressure ulcers: the goal is zero. *Jt Comm J Qual Patient Saf*. 2007;33(10):605–10.
9. Allman RM, Goode PS, Burst N, Bartolucci AA, Thomas DR. Pressure ulcers, hospital complications, and disease severity: impact on hospital costs and length of stay. *Adv Wound Care*. 1999;12(1):22–30.
10. Gorecki C, Brown JM, Nelson EA, Briggs M, Schoonhoven L, Dealey C, Defloor T, Nixon J. Impact of pressure ulcers on quality of life in older patients: a systematic review. *J Am Geriatr Soc*. 2009;57(7):1175–83.
11. Spilsbury K, Nelson A, Cullum N, Iglesias C, Nixon J, Mason S. Pressure ulcers and their treatment and effects on quality of life: hospital inpatient perspectives. *J Adv Nurs*. 2007;57(5):494–504.

12. Raghavan P, Raza WA, Ahmed YS, Chamberlain MA. Prevalence of pressure sores in a community sample of spinal injury patients. *Clin Rehabil.* 2003;17(8):879–84.
13. Garber SL, Rintala DH, Hart KA, Fuhrer MJ. Pressure ulcer risk in spinal cord injury: predictors of ulcer status over 3 years. *Arch Phys Med Rehabil.* 2000;81(4):465–71.
14. Carda S, Cisari C, Invernizzi M. Sarcopenia or muscle modifications in neurologic diseases: a lexical or pathophysiological difference? *Eur J Phys Rehabil Med.* 2013;49:119–30.
15. Scott JM, Warburton DE, Williams D, Whelan S, Krassioukov A. Challenges, concerns and common problems: physiological consequences of spinal cord injury and microgravity. *Spinal Cord.* 2011;49:4–16.
16. Castro MJ, Apple DF Jr, Staron RS, Campos GE, Dudley GA. Influence of complete spinal cord injury on skeletal muscle within 6 month of injury. *J Appl Phys.* 1999;86:350–8.
17. Giangregorio L, McCartney N. Bone loss and muscle atrophy in spinal cord injury: epidemiology, fracture prediction, and rehabilitation strategies. *J Spinal Cord Med.* 2006;29:489–500.
18. Shaw CS, Clark J, Wagenmakers AJ. The effect of exercise and nutrition on intramuscular fat metabolism and insulin sensitivity. *Annu Rev Nutr.* 2010;30:13–34.
19. Zehnder Y, Luthi M, Michel D, et al. Long-term changes in bone metabolism, bone mineral density, quantitative ultrasound parameters, and fracture incidence after spinal cord injury: a cross-sectional observational study in 100 paraplegic men. *Osteoporos Int.* 2004;15(3):180–9.
20. de Bruin ED, Herzog R, Rozendal RH, Michel D, Stussi E. Estimation of geometric properties of cortical bone in spinal cord injury. *Arch Phys Med Rehabil.* 2000;81:150–6.
21. Rittweger J, Gerrits K, Altenburg T, Reeves N, Maganaris CN, de Hann A. Bone adaptation to altered loading after spinal cord injury: a study of bone and muscle strength. *J Musculoskelet Neuronal Interact.* 2006;6:269–76.
22. Linder-Ganz E, Shabshin N, Itzhak Y, Yizhar Z, Siev-Ner I, Gefen A. Strains and stresses in sub-dermal tissues of the buttocks are greater in paraplegics than in healthy during sitting. *J Biomech.* 2008;41:567–80.
23. Cox SA, Weiss SM, Posuniak EA, Worthington P, Prioleau M, Heffley G. Energy expenditure after spinal cord injury: an evaluation of stable rehabilitating patients. *J Trauma.* 1985;25:419–23.
24. Crane DA, Little JW, Burns SP. Weight gain following spinal cord injury: a pilot study. *J Spinal Cord Med.* 2011;34:227–32.
25. Chen Y, Henson S, Jackson AB, Richards JS. Obesity intervention in persons with spinal cord injury. *Spinal Cord.* 2006;44:82–91.
26. Levy A, Kopplin K, Gefen A. Simulations of skin and subcutaneous tissue loading in the buttocks while regaining weight-bearing after a push-up in wheelchair users. *J Mech Behav Biomed Mater.* 2013;28:436–47.
27. Levy A, Kopplin K, Gefen A. An air-cell-based cushion for pressure ulcer protection remarkably reduces tissue stresses in the seated buttocks with respect to foams: finite element studies. *J Tissue Viability.* 2014;23(1):13–23.
28. Levy A, Kopplin K, Gefen A. Computer simulations of the efficacy of air-cell-based cushions in protecting against reoccurrence of pressure ulcers. *J Rehabil Res Dev.* 2014;51(8):1297–319.
29. Shoham N., Levy A, Kopplin K, Gefen A. Contoured foam cushions cannot provide long-term protection against pressure ulcers for individuals with a spinal cord injury: modeling studies. *Adv Skin Wound Care.* 2014.
30. Simpleware® Ltd. ScanIP, +FE, +NURBS and +CAD Reference Guide ver. 5.1, 2012. <http://www.simpleware.com/software/>.
31. Sopher R, Nixon J, Gorecki C, Gefen A. Effects of intramuscular fat infiltration, scarring, and spasticity on the risk for sitting-acquired deep tissue injury in spinal cord injury patients. *J Biomech Eng.* 2011;133(2):021011.
32. National Guideline Clearinghouse (NGC). Guideline synthesis: Prevention of pressure ulcers. In: National Guideline Clearinghouse (NGC) [<http://www.guideline.gov/syntheses/printView.aspx?id=25078>]. Rockville (MD): Agency for Healthcare Research and Quality (AHRQ); 2006 Dec (revised 2011 Jan). <http://www.guideline.gov>. Accessed 20 Oct 2013.

33. Maas SA, Ellis BJ, Ateshian GA, Weiss JA. FEBio: finite elements for biomechanics. *J Biomech Eng.* 2012;134(1):5–11.
34. Wheelchair seating, ISO/TC 173/SC 1/WG 11, 2014.
35. ISO 16840–12 “Wheelchair Seating—Part 12 Apparatus and Method for Cushion Envelopment Testing”.
36. Oomens CWJ, Bressers OFJT, Bosboom EMH, Bouten CVC, Bader DL. Can loaded interface characteristics influence strain distributions in muscle adjacent to bony prominences? *Comput Methods Biomech Biomed Engin.* 2003;3:171–80.
37. Shabshin N, Zoizner G, Herman A, Ougortsin V, Gefen A. Use of weight-bearing MRI for evaluating wheelchair cushions based on internal soft-tissue deformations under ischial tuberosities. *J Rehabil Res Dev.* 2010;47:31–42.
38. Gefen A. Tissue changes in patients following spinal cord injury and implications for wheelchair cushions and tissue loading: a literature review. *Ostomy Wound Manage.* 2014;60(2):34–45.
39. Sprigle S, Delaune W. Factors that influence changes in wheelchair cushion performance over time. *Assist Technol.* 2014;26(2):61–8.
40. Ferguson-Pell MW. Technical considerations: seat cushion selection. *J Rehabil Res Dev Clin Suppl.* 1998;(2):49–73. (Fourth Printing: March).
41. ISO 16840–6. “Wheelchair Seating—Part 6. Determination of the changes in properties following simulated extended use—Seat cushions”.
42. Sprigle S, Press L, Davis K. Development of uniform terminology and procedures to describe wheelchair cushion characteristics. *J Rehabil Res Dev.* 2001;38(4):449–61.





Nils Lahmann and Jan Kottner

## Introduction

According to Lasts' Dictionary of Epidemiology, "Epidemiology is the study of the distribution and determinants of health-related states or events in specified populations and the application of this study to control health problems" [1]. Thus, the epidemiology of pressure ulcers (PUs) describes the frequencies and characteristics of individuals with PUs in specified populations in order to control this skin and tissue disease. The frequency of PUs can be described using the two broad concepts prevalence and incidence. Table 3.1 contains commonly used mathematical expressions and descriptions to estimate PU frequencies.

Each of the mathematical expressions has its use in PU epidemiology for different purposes [2, 3]. The basic meaning of PU **prevalence** is that it describes the 'load' or burden of this disease in a population or setting. In contrast a rate is a measure of acceleration and usually expressed as PU **incidence**. The purpose of incidence is to determine the speed of a spread of the disease and to determine the risk. Finally a ratio—similar to a proportion—might be used to describe the extent of a problem—but more often it is used to describe the **odds** which is a description of the chance of having a PU. Finally, the ratio of two odds is commonly used to determine the strength of the association of a exposure/risk factor (odds-ratio) or even more competing exposures/risk factors (e.g., standardized  $\beta$  coefficients in logistic regression models) in PU analytic epidemiology.

---

N. Lahmann (✉)  
Department of Geriatrics, Charité-Universitätsmedizin Berlin,  
Berlin, Germany  
e-mail: [nils.lahmann@charite.de](mailto:nils.lahmann@charite.de)

J. Kottner  
Department of Dermatology and Allergy, Charité-Universitätsmedizin Berlin,  
Berlin, Germany

**Table 3.1** Frequency descriptions of pressure ulcer occurrence

Mathematical expression	General description	Term
Proportion	Individuals with pressure ulcer(s)/individuals with pressure ulcer(s) + individuals without pressure ulcers	Prevalence
Rate	Individuals developing pressure ulcer(s) in a period of time/individuals who could develop pressure ulcer(s) during a period of time	Incidence
Ratio	Individuals with pressure ulcer(s)/individuals without pressure ulcer(s)	Odds

## Numerators and Denominators

There are different types and definitions of prevalence, incidence and odds in PU epidemiology. Most of them can be distinguished according to (1) the definition of the cases in the numerator and (2) the definition of specified populations (cases and non-cases) in the denominator. Following examples illustrate example definitions of numerators:

- All individuals who have at least one PU: This can be regarded as a basic or ‘standard’ numerator, often used in the calculation of a ‘crude’ or ‘overall’ prevalence. For example Galvan—Martinez et al. reported in their study in three second-level hospitals in Mexico: “The overall prevalence of the PU was 17%” [4]. McDermott-Scales et al. reported “a crude prevalence rate of 15.6% for wounds across nursing disciplines” in a community care setting in Ireland [5].
- All individuals who have at least one PU category II or higher. This avoids possible misclassifications and measurement errors of category I PUs, which are very common (e.g., [6, 7]). For example Schoonhoven et al. used PU category II or higher in their study about prevalence and incidence in hospitalized Dutch patients and found that “...prevalence varied between 12.8% and 20.3%” [8].
- All individuals who have acquired a PU in a facility: Depending on what kind of facility has been studied, this ‘facility acquired PU’ (FAPU) has been also referred as ‘hospital-acquired PU’ (HAPU) or ‘ward acquired PU’ (WAPU). To determine this with a minimum risk of bias, correct documentation is essential. When evaluating PU risk effectiveness measuring FAPU prevalence should be preferred but PU incidence is even more suitable in the context of quality evaluation [3]. Gunningberg and colleagues found in their study in five Swedish hospitals: “The prevalence of ulcers was 14.9% and 11.6% were HAPU” [9]. “The ward-acquired pressure ulcer rate in general hospital wards was 3.9% (1.5% excluding grade 1). In intensive care, the rate was 14.9% (8.5% excluding grade 1) in a study of 32.400 hospital patients in Germany [10]. Vangilder et al. reported in a large US study: “Overall prevalence rates were highest in long-term acute care (22%). FA (“*facility-acquired*”) rates were highest in adult intensive care units (ICUs) and ranged from 9.2% (general cardiac care unit [CCU]) to 12.1% (medical ICU)” [11].

- All individuals who have acquired a PU in a specific period of time. This is used for the calculation of a period prevalence. Nonnenmacher et al. reported a period prevalence of PUs of 1.8% (625 cases) in study in a large German university hospital [12].
- All individuals who have a PU at specific body-parts. Depending on the research objectives, some PUs have to be excluded from the nominator. For instance in order to determine the association between PUs at the trunk Kottner et al. [13] excluded PUs occurring at other body areas: “The overall proportion of patients with at least one pressure ulcer at the trunk was 2.0% (99% CI 1.8–2.2) for category 2 and 0.9% (99% CI 0.8–1.0) for category 3/4 pressure ulcers.” [13]. For example if the efficacy of pressure redistribution surfaces have to be evaluated, it is obvious that PUs that might have developed by medical devices such as tubes in the nose or mouth would have not been prevented by using a mattress. Thus, these device-related PUs must be excluded.
- All individuals with an a priori defined degree or level of risk. This has been used to enhance the possibility to compare results across settings or institutions and to reduce confounding. In epidemiology this is called stratification. For instance Schluer et al. reported in a study in pediatric care, that sixty-five per cent (n = 100) of all patients were considered at risk of developing a PU according to a cut-off of 20 of the Braden score. Thirty-five per cent of patients in the risk group were afflicted with one or more PUs [14]. However, since an a priori definition will never achieve 100% sensitivity, this procedure harbors the risk that individuals who are not at risk but do have a pressure ulcer, will not be considered in the calculation [15].

Denominators can also be defined in different ways, for example:

- All individuals in the examined setting at a specific moment (point prevalence) or during a specific time (period prevalence).
- All individuals with an a priori defined specific degree of risk. This is commonly performed by the use of standardized PU risk assessment scales like the Braden, Norton, or Waterlow scores. Individuals or patients with a specific condition or in a specific care setting. In PU research this is often the case for spinal cord injury patients [16], patients undergoing (long) operation theatre procedures, geriatric patients [17] or intensive care patients.

Almost all combinations of numerators and denominators are possible. The most common prevalence estimates in contemporary PU research are:

#### 1. Crude/overall (point) prevalence

**Crude (point) prevalence (%)** = number of all individuals with at least one pressure ulcer at a specific point in time/all individuals in the study sample (population) at a specific point in time

## 2. Risk group prevalence

**Risk group prevalence (%)** = number of all individuals at risk with pressure ulcer at a specific point in time/all individuals at risk in the study sample (population) at a specific point in time

## 3. Facility-acquired prevalence

**Facility-acquired prevalence (%)** = number of all individuals who developed a pressure ulcer in the facility at a specific point in time/all individuals in the study population/the facility at a specific point in time

The most common PU incidence figures are:

### 1. Cumulative incidence

**Cumulative incidence (%)** = number individuals developing pressure ulcer during a specific time period/total number of individuals (initially without a pressure ulcer) in the study sample/population over a specific time period

An example of cumulative incidence is given by Nijs et al. They reported a cumulative incidence of 20.1% of pressure ulcers grade 2–4 occurring at least 48 h after admission in a long-stay surgical Intensive Care Unit (ICU) population in a Belgium university hospital [18].

### 2. Incidence density

**Incidence density** = number of individuals developing a pressure ulcer during a specific time period/total number of individuals per risk time (e.g. bed days) in the study sample/or population over a specific time period

In comparison to cumulative incidence, incidence density is more precise measure because it considers the actual time under risk. Dugaret et al. compared both rates in 602 patients who were admitted during 2 weeks to an emergency department in France. Results showed that the cumulative incidence was 4.9% and the incidence density was 5.4 per 1000 patients per hour [19]. To explain the difference in both rates the following example is given (Table 3.2). There are two wards ‘A’ and ‘B’ with ten patients initially without a PU. In this hypothetical example, all patients

**Table 3.2** Comparison of cumulative incidence and incidence density

	Patients	Length of stay	Patients developing a PU	Cumulative incidence	Incidence density
Ward A	10	5	2	$2/10 \times 100 = 20\%$	$2/(10 \times 5) = 4$
Ward B	10	20	2	$2/10 \times 100 = 20\%$	$2/(10 \times 20) = 1$

in ward A have a length of stay of 5 days, while in ward ‘B’, all patients have a length of stay of 20 days. In both wards, two patients develop a pressure ulcer. The cumulative incidence is identical in both wards ( $2/10 = 20\%$ ). Since the patients risk time differs between both wards (5 days in comparison to 20) the incidence density in ward ‘A’ is 4 ( $2/50$  patient days), whilst in ward ‘B’ it is only 1 ( $2/200$  patient days). Cumulative incidence does not consider differences in patient risk time.

---

### Further Methodological Issues in Pressure Ulcer Epidemiology

In the historical context, epidemiological measures were typically used to describe diseases such as infections, diabetes, pulmonary diseases etc. This makes it sometime difficult ,to adopt these measures to the specific need and issues of PU occurrences. The most common methodological problems are:

1. Frequency of wounds: in comparison to diseases which are present or absent individuals can suffer from more than one PU.
2. Severity of wounds: the inclusion of different PU categories leads to different prevalence and incidence figures (see above).
3. Especially regarding facility ,acquired PUs or PU incidence measures it has to be taken into account, that some types of deep PUs may take several days to be fully developed [20, 21].
4. Random variation [3, 22].

The above mentioned ,challenges have to be adequately considered, if epidemiological measures like incidence will be used for the monitoring of the quality of care or reimbursement issues.

---

### Prevalence and Incidence of Pressure Ulcers

One of the most comprehensive summaries of PU prevalence and incidence figures was published in 2014 in the ‘Prevention and Treatment of Pressure Ulcers: Clinical Practice Guideline’ [3]. In general it can be said that PU frequencies are highest in high risk settings like in geriatric or critical care. However, due the aforementioned reasons published figures are hardly comparable. Despite efforts a common accepted methodology for PU epidemiology is missing so far.

## References

1. Last JM, Spasoff RA, International Epidemiological Association. A dictionary of epidemiology. Oxford: Oxford University Press; 2001.
2. Baharestani MM, Black JM, Carville K, Clark M, Cuddigan JE, Dealey C, Defloor T, Harding KG, Lahmann NA, Lubbers MJ, Lyder CH, Ohura T, Orsted HL, Reger SI, Romanelli M, Sanada H. Dilemmas in measuring and using pressure ulcer prevalence and incidence: an international consensus. *Int Wound J*. 2009;6:97–104.
3. National Pressure Ulcer Advisory Panel, European Pressure Ulcer Advisory panel, Pan Pacific Pressure Injury Alliance. Prevention and treatment of pressure ulcers: clinical practice guideline. In: Emily Haesler, editor. Osborne Park, Western Australia: Cambridge Media; 2014.
4. Galvan-Martinez IL, Narro-Llorente R, Lezama-de-Luna F, Arredondo-Sandoval J, Fabian-Victoriano MR, Garrido-Espindola X, Lozano-Platonoff A, Contreras-Ruiz J. Point prevalence of pressure ulcers in three second-level hospitals in Mexico. *Int Wound J*. 2014;11:605–10.
5. McDermott-Scales L, Cowman S, Gethin G. Prevalence of wounds in a community care setting in Ireland. *J Wound Care*. 2009;18:405–17.
6. Halfens RJ, Bours GJ, Van Ast W. Relevance of the diagnosis 'stage 1 pressure ulcer': an empirical study of the clinical course of stage 1 ulcers in acute care and long-term care hospital populations. *J Clin Nurs*. 2001;10:748–57.
7. Kottner J, Raeder K, Halfens R, Dassen T. A systematic review of interrater reliability of pressure ulcer classification systems. *J Clin Nurs*. 2009;18:315–36.
8. Schoonhoven L, Bousema MT, Buskens E. The prevalence and incidence of pressure ulcers in hospitalised patients in the Netherlands: a prospective inception cohort study. *Int J Nurs Stud*. 2007;44:927–35.
9. Gunningberg L, Stotts NA, Idvall E. Hospital-acquired pressure ulcers in two Swedish county councils: cross-sectional data as the foundation for future quality improvement. *Int Wound J*. 2011;8:465–73.
10. Lahmann NA, Kottner J, Dassen T, Tannen A. Higher pressure ulcer risk on intensive care?—comparison between general wards and intensive care units. *J Clin Nurs*. 2012;21:354–61.
11. Vangilder C, Amlung S, Harrison P, Meyer S. Results of the 2008–2009 international pressure ulcer prevalence survey and a 3-year, acute care, unit-specific analysis. *Ostomy Wound Manage*. 2009;55:39–45.
12. Nonnemacher M, Stausberg J, Bartoszek G, Lottko B, Neuhaeuser M, Maier I. Predicting pressure ulcer risk: a multifactorial approach to assess risk factors in a large university hospital population. *J Clin Nurs*. 2009;18:99–107.
13. Kottner J, Gefen A, Lahmann N. Weight and pressure ulcer occurrence: a secondary data analysis. *Int J Nurs Stud*. 2011;48(11):1339–48.
14. Schluer AB, Cignacco E, Muller M, Halfens RJ. The prevalence of pressure ulcers in four paediatric institutions. *J Clin Nurs*. 2009;18:3244–52.
15. Lahmann N, Halfens R, Dassen T. Not at risk—nevertheless a pressure ulcer. *Cent Eur J Med*. 2006;1:270–83.
16. Zakrasek EC, Creasey G, Crew JD. Pressure ulcers in people with spinal cord injury in developing nations. *Spinal Cord*. 2014;53(1):7–13.
17. Chen CC, Yen CJ, Dai YT, Wang C, Huang GH. Prevalence of geriatric conditions: a hospital-wide survey of 455 geriatric inpatients in a tertiary medical center. *Arch Gerontol Geriatr*. 2011;53:46–50.
18. Nijs N, Toppets A, Defloor T, Bernaerts K, Milisen K, Van den Berghe G. Incidence and risk factors for pressure ulcers in the intensive care unit. *J Clin Nurs*. 2009;18:1258–66.
19. Dugaret E, Videau MN, Faure I, Gabinski C, Bourdel-Marchasson I, Salles N. Prevalence and incidence rates of pressure ulcers in an Emergency Department. *Int Wound J*. 2014;11(4):389–91.

20. Aoi N, Yoshimura K, Kadono T, Nakagami G, Iizuka S, Higashino T, Araki J, Koshima I, Sanada H. Ultrasound assessment of deep tissue injury in pressure ulcers: possible prediction of pressure ulcer progression. *Plast Reconstr Surg.* 2009;124(2):540–50.
21. Kottner J, Dassen T, Lahmann N. Prevalence of deep tissue injuries in hospitals and nursing homes: two cross-sectional studies. *Int J Nurs Stud.* 2010;47(6):665–70.
22. Kottner J, Lahmann N. Comparative quality measurements part 3: funnel plots. *Pflege.* 2014;27(1):41–9.



# Nutrition and Pressure Ulcers

# 4

Emanuele Cereda and Jos M. G. A. Schols

## Introduction

For most health care professionals, the relevance of adequate nutrition for preserving skin and tissue viability and to promote tissue repair processes like wound healing is not in question. A good nutritional status reflects an overall healthy condition. Yet, little scientific evidence is available about the relation between nutrition and wound healing. Fortunately, in recent years more and more studies in this field are performed related to the problem of pressure ulcers (PUs).

In this chapter, after a short introduction on the relationship between nutritional status and PUs and on the general nutritional management of PU patients, attention will be paid to the assumed role of nutrients in preserving tissue viability and improving wound healing. Thereafter, the elements of adequate nutritional care as part of integrated PU-care will be discussed. Recommendations based on the most recent guidelines will be given for daily practice. Specific attention will be paid to the supplementation with high protein, arginine and micronutrients.

---

E. Cereda

Clinical Nutrition and Dietetics Unit, Fondazione IRCCS Policlinico

“San Matteo”, Pavia, Italy

e-mail: [e.cereda@smatteo.pv.it](mailto:e.cereda@smatteo.pv.it)

J. M. G. A. Schols (✉)

Department of Family Medicine, Maastricht University, Maastricht, The Netherlands

Department of Health Services Research, Maastricht University, Maastricht, The Netherlands

e-mail: [jos.schols@kpnmail.nl](mailto:jos.schols@kpnmail.nl)



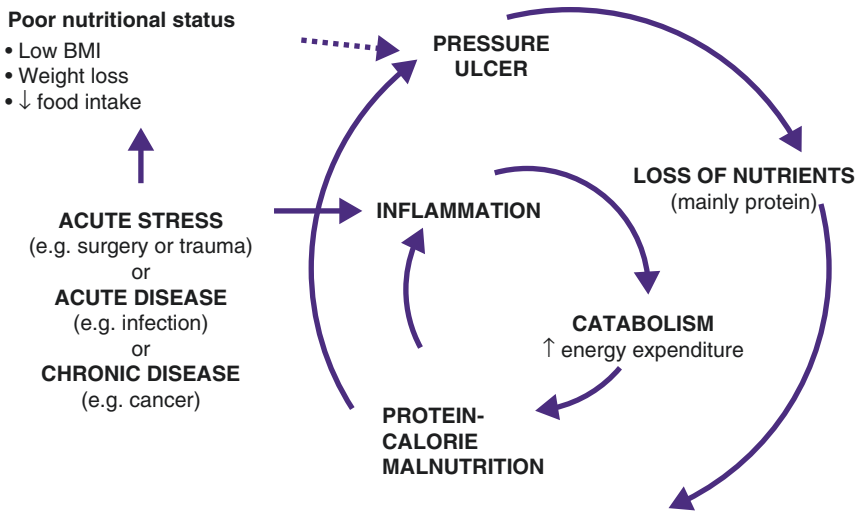
## Pressure Ulcers; the Possible Relation with Nutritional Status

Pressure ulcers (PUs), have affected humans in all times. They are one of the most costly and physically debilitating care problems and show a high prevalence and incidence in all health care sectors throughout the world. In addition, prevalence data are often higher in specific populations like, frail and disabled nursing home residents, patients receiving palliative care and patients in intensive care units [1–3].

PUs cause a great deal of discomfort for patients. They cause much pain, lead to a reduced quality of life, slow rehabilitation and delay hospital discharge. In addition they increase costs for hospitals, long-term care facilities and the community considerably. The cost-of-illness of pressure ulcers has been calculated to be at least 1% of the total Dutch health care budget and 4% of the UK respectively [4–7]. Therefore, addressing the overall management of PUs is nowadays a prominent national healthcare issue in many western countries.

The development of pressure ulcers depends on extrinsic and intrinsic risk factors. The most important and well known extrinsic risk factors are pressure, shear, friction and microclimate, which via complex and synergistic actions may lead to the formation of pressure ulcers. Intrinsic factors have an effect on tissue viability and consequently influence the pathophysiological response to mechanical loading and stress. Studies have found significant associations with age, sex, limited activity, care dependency, incontinence (bowel and bladder), acute disease (e.g. infection) and nutritional status. The relative influence of each of these intrinsic risk factors is still unclear [8].

Both poor nutritional intake and poor nutritional status have been shown to correlate with the development of PU as well as with protracted healing of wounds. Notwithstanding methodological shortcomings, cross-sectional and prospective studies suggest that there is a fairly strong correlation between malnutrition and the development of PUs [9–12]. Studies related to PUs have mostly focused on the relation between PUs and undernutrition and they have reported that 60–90% of PU patients are malnourished. Multivariate analysis of epidemiological data indicates that a poor nutritional status and related factors such as low body weight and poor oral food intake are independent risk factors for the development of pressure ulcers [13–15]. Moreover, many acute and chronically ill as well as elderly patients, at risk of PUs or with established PUs, suffer from undesired weight loss [16, 17]. A study from Shahin et al. 2010 studying the relationship between malnutrition parameters and pressure ulcers in German hospitals and nursing homes clearly established a significant relationship between the presence of pressure ulcers and undesired weight loss (5–10%) in hospitals and nursing homes. Inadequate and poor nutritional intake was strongly related to the presence of pressure ulcers in both health care settings as well [18]. Nonetheless, the relationship between malnutrition and PUs is likely bidirectional, being the basis of a vicious cycle. A PU is responsible for an increased inflammatory background which, in turn, causes an increase in energy requirements [19]. Accordingly, the inability of PU patients to meet protein-calorie needs is further emphasized (Fig. 4.1).



**Fig. 4.1** Inter-relationship between nutrition and pressure ulcers

Altogether, these findings underline the importance of adequate nutritional care in PU (prone) patients.

## Pressure Ulcers; Risk Assessment, Prevention and Treatment

To target PU preventive actions in the right way, risk assessment aimed at identifying susceptible patients is of utmost importance in daily clinical practice. PU risk assessment should be performed in a structured, multidisciplinary way and include activity, mobility, the skin's viability and moisture and nutritional status.

Next to clinical judgment, risk assessment can be supported by using a pressure ulcer risk assessment scale. There are several widely used risk assessment scales, such as the Waterlow pressure sore risk scale and the Braden scale, which consists of 6 items referring to sensory perception, skin moisture, activity, mobility, nutritional status and the extent of friction and shear forces [20, 21].

The advice is to incorporate one of such scales including the evaluation of the nutritional domain, structurally in the daily care process because this can alert healthcare professionals to the possibility of pressure ulcers continuously.

## Pressure Ulcers; Prevention and Treatment in General

After establishing the risk of getting a PU or if a PU is diagnosed, preventive measures should be initiated.

Relevant preventive measures are:

- regular inspection of the skin together with the use of skin emollients to hydrate a dry skin;
- reduction of the duration and magnitude of pressure on vulnerable areas of the body by performing repositioning of at-risk patients in combination with the use of support surfaces, like mattresses seats and cushions;
- optimization of the patient’s general health condition, including improvement of mobility and nutritional status.

In the case of a confirmed pressure ulcer, therapeutic measures must be taken directly, during the course of which the preventive measures remain in force.

Curative intervention consists primarily of appropriate wound care to encourage tissue repair as much as possible. In addition attention must be paid to the patient’s general health status, the management of secondary infection, pain and psychosocial suffering and last but not least also to adequate nutritional care.

---

## **Basic Aspects of Tissue Power and Wound Healing; the Assumed Role of Nutrients**

To preserve tissue viability and to promote adequate wound healing, several endogenous factors play an important role, for instance the power of the body to preserve tissue homeostasis and tissue defence mechanisms including processes that generate an adequate inflammatory reaction as well as the defence response to deal adequately with acute tissue damage and to handle the subsequent bacterial burden of a wound and finally also the complex processes of tissue repair.

In this process nutrients play also a relevant role. Under here a short description of the most relevant nutrients is given.

### **Calories by Carbohydrate, Fat and Protein**

Carbohydrate, protein, and fat supply the energy source (kilocalories) for the body. The provision and consumption of adequate kilocalories supports collagen and nitrogen synthesis and healing and promotes anabolism by sparing protein from being used as an energy source. Fat is the most concentrated source of kilocalories, transports the fat-soluble vitamins (A, D, E, K) and provides insulation under the skin and padding to bony prominences. It is also an essential part of cellular membranes, which is important for preserving tissue viability and for wound repair processes. Moreover, attention has recently been given to omega-3 essential fatty acids as potential modulators of the wound healing process [22]. Meats, fishes, eggs, dairy products, and vegetable oils represent resources of fat.

## Protein and Amino Acids

Protein is the only nutrient containing nitrogen and is composed of amino acids. Protein is important for tissue perfusion, preservation of the immune function, repair and synthesis of enzymes involved in wound healing, cell multiplication, collagen and connective tissue synthesis. Foods that provide all essential amino acids, such as meat, poultry, fish, eggs, milk products, and soybeans, are considered complete proteins. During period of stress or trauma such as injury and wound healing, certain amino acids, such as arginine and glutamine, become conditionally essential. L-Arginine is 32% nitrogen and has been shown to increase concentrations of hydroxyproline, which is an indicator of collagen deposition and protein in the wound site [23–25]. The role of arginine in wound healing will be described later.

## Vitamins and Minerals

Ascorbic acid (vitamin C), a water soluble vitamin, is a cofactor with iron during the hydroxylation of proline and lysine in the production of collagen. Hence a deficiency of vitamin C may prolong the healing time and contributes to reduced resistance to infection [9]. The required daily intake of vitamin C is achieved with the consumption of fruits and vegetables. Vitamin A and Vitamin E are fat soluble vitamins and the dietary intake comes from a variety of foods. Vitamin A acts as a stimulant during the wound healing process to increase collagen formation and promote epithelisation. Vitamin E acts as an anti-oxidant and the required intake can easily be met with food and/or a multivitamin, unless a deficiency is confirmed.

Zinc, a cofactor for collagen formation, also metabolizes protein, liberates vitamin A from storage in the liver, and assists in immune function. Copper is an essential mineral for collagen cross-linking. If deficiencies are suspected, suppletion can be provided for instance via multivitamins [26–28].

## Water

Water is distributed throughout the body in our intracellular, interstitial, and intravascular compartments and serves as the transport medium for moving nutrients to the cells and removing waste products. Water constitutes 60% of an adults body, thus being the most important nutrient for life. An elderly individual generally has an increase in body fat and a decrease in lean body mass resulting in a decrease in the percentage of water stored. Individuals with draining wounds, diarrhoea, elevated temperature, or increased perspiration require additional fluids to replace fluid lost. Hydration needs are met from liquids plus the water content of food [29, 30].

---

## Adequate Nutritional Care as Part of Integrated PU-Care

To preserve a good tissue viability and tissue repair power in PU-(prone) patients adequate nutritional care as part of integrated PU care is required.

Under here, the essentials of this required nutritional care are described including the most important specific evidence based recommendations. The latter are based upon the most recent revised international guidelines of both the National Pressure Ulcer Advisory Panel (USA) and the European Pressure Ulcer Advisory Panel (NPUAP-EPUAP 2014) in which a specific nutritional part is incorporated.

In essence, the nutritional recommendations for prevention and treatment of PUs involve:

- recommendations to follow the basic nutritional cycle to achieve tailor-made nutritional care;
- recommendations on Calorie intake, Protein intake, Hydration, Vitamins and Minerals;
- New is a specific recommendation on the supplementation with high protein, arginine and micronutrients. This will be described in a separate part of this chapter, as mentioned before.

---

## The Nutritional Cycle

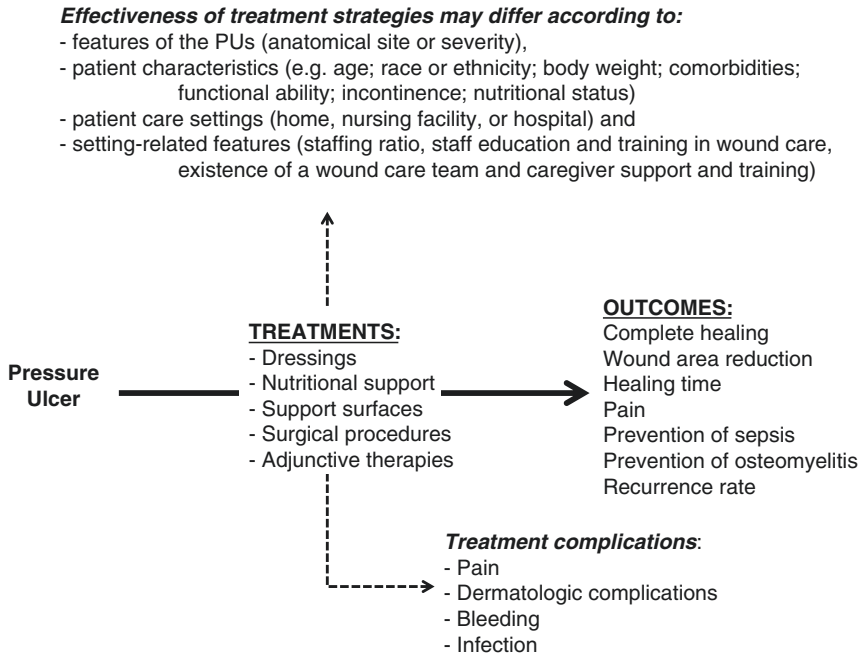
Screening and assessment of nutritional status followed by adequate nutritional intervention should be part of the prevention and treatment plan for patients at risk for PUs (Fig. 4.2).

---

## Nutritional Screening

Unless the patient has a terminal illness, undernutrition is a reversible risk factor for pressure ulcer development, making early identification and management critical. Patients at risk of pressure ulcers or with PUs in which progress towards healing is not observed, often are in danger of undernutrition. Therefore, nutritional screening in patients at risk or with a PU should be completed at admission to a health care setting but also with each condition change or if a new ulcer occurs and/or progress towards healing is delayed [23, 31–33].

Healthcare organizations should have a policy on nutritional screening. Screening tools should be easy to use, validated, and reliable for the patient population served. Validated screening tools are widely used nowadays. The Mini-Nutritional Assessment (MNA) and the MNA short form were noted in a cross-sectional study by Langkamp-Henken et al. to have an advantage over using visceral protein when screening and assessing nutritional status [34]. The MNA-SF was revised to six questions and re-validated for adults 65 and older and has a 80% sensitivity and specificity and 97% positive predictive value of impaired nutritional status according



**Fig. 4.2** Workflow of treatment strategies [53]

to clinical judgement [35]. The Malnutrition Screening Tool (MUST) has been validated in acute care, long term care and the community and identifies those individuals underweight or at risk for undernutrition [36].

When the screening tool triggers nutrition as a point of necessary attention, timely referral to the appropriate professionals is critical. A subsequent nutritional assessment should be completed by a registered dietician who collaborates and communicates with the other members of the healthcare team including the speech therapist, responsible for screening, evaluating and treating swallowing problems, the occupational therapist who works to strengthen the patients' ability to feed themselves and the nursing staff whose responsibilities include monitoring the patient's acceptance of nutrition. The physician is responsible for the over-all care of the patient and ordering any treatments recommended by the team.

## Nutritional Assessment

The in-depth nutritional assessment is a methodical process of obtaining and interpreting data in order to make decisions about the basis of nutrition-related problems. The assessment includes interpretation and analysis of medical, nutritional, biochemical data and food-medication interactions; obtaining anthropometric measurements; and evaluation of visual signs of poor nutrition, oral status, chewing/swallowing ability, and/or diminished ability to eat independently.

Anthropometric measurements include height, weight and body mass index (BMI = weight [kg]/height [m] squared—[kg/m<sup>2</sup>]). Obtaining an accurate height and weight is important, since these values are the basis for calculating body mass index (BMI) and caloric requirements. Individuals should be weighed on a calibrated scale, at the same time of the day, and wearing the same amount of clothing. Special beds nowadays often are equipped with a device to weigh an immobile individual. The assessment of the weights status to determine the weight history and to identify significant weight loss >5% in the last 30 days or >10% in the last 180 days is very relevant because this places an individual at increased nutritional risk and has a negative effect on wound healing [37, 38]. Yet, an obese patient is also at risk for PU development and healing may be delayed when the diet consumed is inadequate in nutrients including protein. In patients unable to maintain the standing position height could be derived from knee-heel length through the use of appropriate and validated ethnic-specific equations [39, 40].

In addition a diet history should be performed to assess the adequacy of the total nutrient intake by determining the type, quantity and frequency of food usually consumed by the patient. A further nutrition focused clinical examination should explore signs of poor nutrition like changes in the hair, skin or nails, such as thin, dry hair, brittle nails or cracked lips. In addition also the patient's ability to eat normally and independently should be determined: individuals with missing or decayed teeth or ill-fitting dentures often reduce their intake of difficult to chew protein foods, thus restricting their caloric intake and increasing the chance for weight loss. Moreover, individuals with swallowing problems, dysphagia or disabilities that cause dependency on others for eating and drinking, may become dehydrated and lose weight. All these conditions may lead to an increased PU risk and can negatively affect wound healing.

Analysis of current laboratory values is also a component of the nutritional assessment, but not a very important one. Biochemical assessment data must be used with caution because values can be altered by hydration, medication, and changes in metabolism. There is not one specific laboratory test that can expressly determine an individual's nutritional status. Serum hepatic proteins including albumin, prealbumin and transferrin may not correlate with the clinical observation of nutritional status [41, 42].

Serum concentrations of these laboratory parameters may not be markers of malnutrition or caloric repletion, but instead may be indicators of morbidity severity and risk of mortality.

## Nutritional Intervention

After the nutritional assessment, an individualized nutritional care plan should be developed for patients at risk of or with a PU. Caloric, protein, fluid and vitamin/mineral requirements should be individualized and increased or decreased, depending on the assessed requirements of the patient.

The nutritional intervention strategy always tries to focus first on improving normal oral nutritional intake. Yet, despite many daily efforts on this, for instance by taking into account individual preferences on foods and drinks and by improving

mealtime ambiance, it is known that many patients with PUs cannot meet their nutritional demands via normal intake only [19]. Therefore, the incorporation of fortified foods and/or oral nutritional supplements (ONS) into the treatment plan should be determined. Fortified foods include commercial products, such as cereal, soup, cookies, or dairy products enriched with additional calories and protein or enriched menu items. When normal oral intake is inadequate, enteral or parenteral nutrition is considered, if it is consistent with the individual's goal. When the gut is functioning, enteral feeding via oral nutritional supplements in addition to the diet, or total tube feeding is the preferred route.

Research supports the theory of providing ONS to reverse undernutrition, prevent PU-occurrence and promote PU healing [43–45]. ONS in addition to the regular diet should be preferably consumed in between meals, because then they do not affect normal intake negatively.

In any case, it is not sufficient to prescribe only. Compliance to intervention must be monitored and food and fluid intakes reviewed periodically.

---

## **Recommendations on Calorie Intake, Protein Intake, Hydration, Vitamins and Minerals**

The consistent research made in the last 15 years in the field of “nutrition and PU” has brought the incorporation into international guidelines of a chapter dedicated to the improvement of nutritional care [46]. The statements included are primarily oriented on how to adjust the intake of calories, proteins, vitamins, minerals and water in patients both having or at high risk of developing PUs. It is interesting to note that the evidence collected substantially refers to an adult population and, although pediatric patients may be at high risk of skin breakdown and nutritional derangements, high-quality research still needs to be conducted in this segment of the population. A summary of recommendations and the related strength of evidence is presented in Table 4.1.

### **Energy Intake**

In patients assessed to be at risk of malnutrition, nutritional intervention should be tailored to achieve an energy intake of 30–35 kcal/kg of body weight daily. This applies to both adults having or at risk of developing PUs. In any case, starting from this general statement, the provision should be individualized based on underlying medical conditions, weight changes and weight status. Those being underweight or having experienced unintended weight loss may need additional energies. Accordingly, disease-related dietary restrictions should be reconsidered under medical control when they have a negative impact on nutrients and fluid intake. In line with this, the use of fortified foods and/or high-calorie, high-protein ONS between meals should always be considered when estimate requirements are difficult to cover with oral diet. In patients at high risk of developing due to acute-stress conditions (e.g. surgery) the use of ONS has been demonstrated to reduce the occurrence of new PU of about 25% and it is strongly recommended [47].



**Table 4.1** Recommendations and strength of evidence for “Nutrition in Pressure Ulcer Prevention and Treatment” from NPUAP-EPUAP 2014 Guidelines [46]

Statement	Strength
<i>Nutrition screening</i>	
– Screen nutritional status for each individual at risk of or with a pressure ulcer: <ul style="list-style-type: none"> <li>• at admission to a health care setting;</li> <li>• with each significant change of clinical condition; and/or</li> <li>• when progress toward pressure ulcer closure is not observed</li> </ul>	C
– Use a valid and reliable nutrition screening tool to determine nutritional risk	C
– Refer individuals screened to be at risk of malnutrition and individuals with an existing pressure ulcer to a registered dietitian or an inter-professional nutrition team for a comprehensive nutrition assessment	C
<i>Nutrition assessment</i>	
– Assess the weight status of each individual to determine weight history and identify significant weight loss ( $\geq 5\%$ in 30 days or $\geq 10\%$ in 180 days)	C
– Assess the individual’s ability to eat independently	C
– Assess the adequacy of total nutrient intake (food, fluid, oral supplements and enteral or parenteral nutrition)	C
<i>Care planning</i>	
– Develop an individualized nutrition care plan for individuals with or at risk of a pressure ulcer	C
– Follow relevant and evidence-based guidelines on nutrition and hydration for individuals who exhibit nutritional risk and who are at risk of pressure ulcers or have an existing pressure ulcer	C
<i>Energy intake</i>	
– Provide individualized energy intake based on underlying medical condition and level of activity	B
– Provide 30–35 kcal/kg body weight for adults at risk of a pressure ulcer who are assessed as being at risk of malnutrition	C
– Provide 30–35 kcal/kg body weight for adults with a pressure ulcer who are assessed as being at risk of malnutrition	B
– Adjust energy intake based on weight change or level of obesity. Adults who are underweight or who have had significant unintended weight loss may need additional energy intake	C
– Revise and modify/liberalize dietary restrictions when limitations result in decreased food and fluid intake. These adjustments should be made in consultation with a medical professional and managed by a registered dietitian whenever possible	C
– Offer fortified foods and/or high calorie, high protein oral nutritional supplements between meals if nutritional requirements cannot be achieved by dietary intake	B
– Consider enteral or parenteral nutritional support when oral intake is inadequate. This must be consistent with the individual’s goals	C
<i>Protein intake</i>	
– Provide adequate protein for positive nitrogen balance for adults assessed to be at risk of a pressure ulcer	C
– Offer 1.25–1.5 g protein/kg body weight daily for adults at risk of a pressure ulcer who are assessed to be at risk of malnutrition when compatible with goals of care, and reassess as condition changes	C
– Provide adequate protein for positive nitrogen balance for adults with a pressure ulcer	B

**Table 4.1** (continued)

Statement	Strength
– Offer 1.25–1.5 g protein/kg body weight daily for adults with an existing pressure ulcer who are assessed to be at risk of malnutrition when compatible with goals of care, and reassess as condition changes	B
– Offer high calorie, high protein nutritional supplements in addition to the usual diet to adults with nutritional risk and pressure ulcer risk, if nutritional requirements cannot be achieved by dietary intake	A
– Assess renal function to ensure that high levels of protein are appropriate for the individual	C
– Supplement with high protein, arginine and micronutrients for adults with a pressure ulcer Category/Stage III or IV or multiple pressure ulcers when nutritional requirements cannot be met with traditional high calorie and protein supplements	B
<i>Hydration</i>	
– Provide and encourage adequate daily fluid intake for hydration for an individual assessed to be at risk of or with a pressure ulcer. This must be consistent with the individual's comorbid conditions and goals	C
– Monitor individuals for signs and symptoms of dehydration including change in weight, skin turgor, urine output, elevated serum sodium, and/or calculated serum osmolality	C
– Provide additional fluid for individuals with dehydration, elevated temperature, vomiting, profuse sweating, diarrhea, or heavily exuding wounds	C
<i>Vitamins and minerals</i>	
– Provide/encourage individuals assessed to be at risk of pressure ulcers to consume a balanced diet that includes good sources of vitamins and minerals	C
– Provide/encourage an individual assessed to be at risk of a pressure ulcer to take vitamin and mineral supplements when dietary intake is poor or deficiencies are confirmed or suspected	C
– Provide/encourage an individual with a pressure ulcer to consume a balanced diet that includes good sources of vitamins and minerals	B
– Provide/encourage an individual with a pressure ulcer to take vitamin and mineral supplements when dietary intake is poor or deficiencies are confirmed or suspected	B

## Protein Intake

Recommendations on how to manage protein intake are incorporated into guidelines in strong connection with those pertaining energy intake. Indeed, there could be no protein anabolism and new tissue synthesis in absence of energy supply. In agreement with other international society guidelines, the advised protein target is 1.25–1.5 g/kg per day. As proteins represent the building bricks of new tissues and patients at risk of or suffering from PUs are typically of advanced age, the recommendation for 0.8 g/kg body weight for a healthy adult is considered inadequate. Again, specific restrictions associated with comorbid status should be taken into account and eventually reconsidered based on current clinical conditions. Usual diet should be improved accordingly and the use of high-calorie, high-protein ONS is strongly recommended in those not able to meet estimated requirements, particularly in presence of a high risk of developing PU due to acute-stress conditions.

## Hydration

Although recommendations are all of low-grade, water remains undoubtedly the most important nutrient being it essential for the maintenance of blood tissue flow and a cofactor for most enzymatic reactions. Minimum daily requirements are set to 30 mL/kg/day or 1 mL/kcal of energy intake. It should be considered that foods generally account only for 20% of total fluid needs. Patients with dysphagia are more likely to experience difficulties in meeting their needs. Nonetheless, daily requirements should be individualized according to comorbid conditions and the presence of factors potentially responsible for imbalance such as elevated temperature, vomiting, profuse sweating, diarrhea, or heavily exuding wounds.

## Vitamins and Minerals

As already reported, patients with PUs or at risk of developing PUs are frequently unable to meet protein-calorie requirements. Accordingly, deficits in micronutrients are more likely to occur. Oral diet should be a good source also of these and the use of supplements should always be considered when dietary intake is poor and deficiencies are confirmed or even suspected. This applies to both patients having a PU or at risk of it.

---

## Promising Effects of Arginine Enriched Oral Nutritional Supplements on Wound Healing

Finally, there is high-quality, high-strength evidence that specific micronutrients such as arginine, as well as zinc and antioxidants, can exert an additional benefit to PU healing. A specific recommendation has been recently included in the upcoming (2014) edition of the NPUAP-EPUAP guidelines and rated as a grade-B evidence (see Table 4.1).

However, based on recent data—adding to those previously collected—the strength is going to increase further (grade-A) as the additional value of these micronutrients is likely to be independent of that of proteins and calories. Nonetheless, these macronutrients must always be provided to promote new tissue synthesis in this category of patients that in fact should be considered malnourished by definition. Furthermore, it is noteworthy that no effect was found for each of these nutrients when provided alone and only the combination of them within a high-energy support is likely responsible for a positive effect on healing.

A preliminary suggestion for the beneficial use of nutritional formula enriched with arginine, zinc and antioxidants dates back to 2001 [48]. After that date three small randomized and controlled trials were published [49–51]. The main limitations of these studies were the small sample size, the inclusion of specific groups of patients and the lack of control for calorie and protein support among intervention groups (Table 4.2). However, the first study by Cereda et al. [50] was able to show an effect of enriched formula in patients primarily fed by enteral route, while the study by van Anholt et al. [51] demonstrated the effectiveness in non-malnourished patients.

**Table 4.2** Randomized trials evaluating the efficacy of a nutritional formula enriched with arginine, zinc and antioxidants on the healing of PUs [46]

Study	Participants (N)	Study duration	Intervention	Endpoint	Summary of results	Limitations	Risk of bias
Benati et al. [48]	Cognitively impaired elderly inpatients (N = 16)	2 weeks	High-protein supplement enriched with AZA vs. high-protein support vs. routine care	Pressure Ulcer Status Tool	Patient treated with the enriched formula appeared to experience higher improvement	Very small study; results were provided only graphically; short duration	High
Desneves et al. [49]	Inpatients (N = 16) with Stage II–IV PU	3 weeks	Standard hospital diet + oral formula enriched with AZA vs. standard diet	PUSH score	Improved rate of healing	Very small study; sub-optimal randomization; short duration	High
Cereda et al. [50]	Long-term care (N = 28) residents with Stage II–IV PU of recent onset	12 weeks	High-calorie, high-protein protein support enriched with AZA vs. high-calorie, normal-protein support	PU area and PUSH score	Difference in ulcer area significant by week 8; difference in PUSH score significant by week 12	Small study; mainly tube-fed patients	Moderate
Van Anholt et al. [51]	Non-malnourished PU patients (N = 43) with a Stage III and IV PU from hospitals and long-term care	8 weeks	High-calorie, high-protein support enriched AZA vs. non-caloric placebo	PU area, PUSH score, nursing time duration, number of dressings	Significant difference in all the endpoints considered	Small study; only non-malnourished patients able to drink ONS; control group treated with a non-caloric placebo	Moderate
Cereda et al. [52]	Malnourished PU patients (N = 200) with a Stage II–IV PU from long-term care or home-care services	8 weeks	High-calorie, high-protein oral support enriched with AZA vs. an isocaloric, isonitrogenous formula	PU area, complete healing, number of dressings and wound infections	Significant difference in ulcer area	Only malnourished patients able to drink ONS; setting of care	Low

AZA arginine, zinc and antioxidants, ONS oral nutritional supplements, PU pressure ulcer, PUSH pressure ulcer scale for healing

The shortcomings of previous studies have been recently overcome in the Oligo-Element Sore Trail (OEST) [52]. This large (N = 200) randomized (1:1), double-blind, controlled trial compared a high-calorie, high-protein nutritional formula enriched with arginine, zinc and antioxidants with an active isocaloric, isonitrogenous control formula confirming that a disease-specific support improves PU healing, with a 20% higher reduction in PU area after 8 weeks of intervention. Accordingly, although in PU patients with normal gut function and unable to meet energy needs by normal food the use of a high-calorie, high-protein support—by either oral or enteral route—is recommended, additional supplementation with specific nutrients (arginine, zinc and antioxidants) results in improved healing. The use of this formula is therefore to be considered whenever and wherever possible.

---

## References

1. Vanderwee K, Clark M, Dealey C, Gunningberg L, Defloor T. Pressure ulcer prevalence in Europe: a pilot study. *J Eval Clin Pract.* 2007;13(2):227–32.
2. Cuddigan J, Ayello E, Sussman C, editors. *Pressure ulcers in America: prevalence, incidence and implications for the future: an executive summary of the National Pressure Ulcer Advisory Panel Monograph.* Reston, VA: NPUAP; 2001.
3. Amir Y, Meijers J, Halfens R. Retrospective study of pressure ulcer prevalence in Dutch general hospitals since 2001. *J Wound Care.* 2011;20(1):18, 20-5
4. Hopkins A, Dealey C, Bale S, Defloor T, Worboys F. Patients stories of living with a pressure ulcer. *J Adv Nurs.* 2006;56(4):345–53.
5. Allman RM, Goode PS, Burst N, Bartolucci AA, Thomas DR. Pressure ulcers, hospital complications and disease severity: impact on hospital costs and length of stay. *Adv Wound Care.* 1999;12(1):22–30.
6. Severens JL, Habraken JM, Duivenvoorden S, Frederiks CMA. The cost of illness of pressure ulcers in The Netherlands. *Adv Skin Wound Care.* 2005;15(2):72–7.
7. Bennet G, Dealey C, Posnett J. The cost of pressure ulcers in the UK. *Age Ageing.* 2004;33(3):230–5.
8. National Pressure Ulcer Advisory Panel and European Pressure Ulcer Advisory Panel. *Prevention and treatment of pressure ulcers: clinical practice guideline.* Washington, DC: NPUAP; 2009.
9. Pinchcofsky-Devin GD, Kaminski MV. Correlation of pressure sores and nutritional status. *J Am Geriatr Soc.* 1986;34:435–40.
10. Thomas DR. The role of nutrition in prevention and healing of pressure ulcers. *Clin Geriatr Med.* 1997;13:497–511.
11. Berlowitz DR, Wilking SVB. Risk factors for pressure sores. A comparison of cross-sectional and cohort-derived data. *J Am Geriatr Soc.* 1989;37:1043–50.
12. Green SM, Winterberg H, Franks PJ, et al. Nutritional intake in community patients with pressure ulcers. *J Wound Care.* 1999;8:325–30.
13. Guenter P, Malyszek R, Bliss DZ, Steffe T, O'Hara D, LaVan F, Monteiro D. Survey of nutritional status in newly hospitalized patients with stage III or stage IV pressure ulcers. *Adv Skin Wound Care.* 2000;13(4 Pt 1):164–8.
14. Thomas DR, Verdery RB, Gardner L, Kant A, Lindsay J. A prospective study of outcome from protein-energy malnutrition in nursing home residents. *JPEN.* 1991;15:400–4.
15. Mathus-Vliegen EMH. Nutritional status, nutrition and pressure ulcers. *Nutr Clin Pract.* 2001;16:286–91.
16. Ek AC, Unosson M, Larsson J, Von Schenck H, Bjurulf P. The development and healing of pressure ulcers related to the nutritional state. *Clin Nutr.* 1991;10:245–50.

17. Kerstetter JE, Holthausen BA, Fitz PA. Malnutrition in the institutionalized older adult. *J Am Diet Assoc.* 1992;92:1109–16.
18. Shahin ES, Meijers JM, Schols JM, Tannen A, Halfens RJ, Dassen T. The relationship between malnutrition parameters and pressure ulcers in hospitals and nursing homes. *Nutrition.* 2010 Sep;26(9):886–9.
19. Cereda E, Klersy C, Rondanelli M, Caccialanza R. Energy balance in patients with pressure ulcers: a systematic review and meta-analysis of observational studies. *J Am Diet Assoc.* 2011;111:1868–76.
20. Bergstrom N, Braden BJ, Laguzza A, Holman V. The Braden Scale for predicting pressure sore risk. *Nurs Res.* 1987;36(4):205–10.
21. Jalali R, Rezaie M. Predicting pressure ulcer risk: comparing the predictive validity of 4 scales. *Adv Skin Wound Care.* 2005;18(2):92–7.
22. Chow O, Barbul A. Immunonutrition: role in wound healing and tissue regeneration. *Adv Wound Care (New Rochelle).* 2014;3:46–53.
23. Stratton RJ, Green CJ, Elia M. Disease-related malnutrition: an evidence-based approach to treatment. Oxon: CABI; 2003.
24. Kirk SJ, Hurson M, Regan MC, Holt DR, Wasserkrug HL, Barbul A. Arginine stimulates wound healing and immune function in elderly human beings. *Surgery.* 1993; 114:155–60.
25. Barbul A, Lazarou SA, Efron DT, Wasserkrug HL, Efron G. Arginine enhances wound healing and lymphocyte immune response in humans. *Surgery.* 1990;108:331–7.
26. Ronchetti IP, Quaglino D, Bergamini G. Ascorbic acid and connective tissue. *Subcell Biochem.* 1996;25:249–64.
27. Ter Riet G, Kessels AG, Knipschild PG. Randomized clinical trial of ascorbic acid in the treatment of pressure ulcers. *J Clin Epidemiol.* 1995;48(12):1453–60.
28. Institute of Medicine. Dietary Reference Intakes: the essential guide to nutrient requirements. Washington, DC: National Academy of Sciences (NAS); 2006.
29. Thomas DR, Cote TR, Lawhorne L, et al. Understanding clinical dehydration and its treatment. *J Am Med Dir Assoc.* 2008;9:292–301.
30. JMGA S, De Groot CP, van der Cammen TJ, Olde Rikkert MG. Preventing and treating dehydration in the elderly during periods of illness and warm weather. *J Nutr Health Aging.* 2009;13(2):150–7.
31. Elia M, Zellipour L, Stratton RJ. To screen or not to screen for adult malnutrition? *Clin Nutr.* 2005;24(6):867–84.
32. Kondrup J, Allison SP, Elia M, Vellas B, Plauth M. ESPEN guidelines for nutrition screening 2002. *Clin Nutr.* 2003;22(4):415–21.
33. Ferguson M, Capra S, Bauer J, Banks M. Development of a valid and reliable malnutrition screening tool for adult acute hospital patients. *Nutrition.* 1999;15:458–64.
34. Langkamp-Henken B, Hudgens J, Stechmiller JK, Herrlinger-Garcia KA. Mini nutritional assessment and screening scores are associated with nutritional indicators in elderly people with pressure ulcers. *J Am Dietetic Assoc.* 2005;105(10 (Print)):1590–6.
35. Kaiser MJ, Bauer JM, Ramsch C, MNA—International Group, et al. Validation of the Mini Nutritional Assessment short-form (MNA-SF): a practical tool for identification of nutritional status. *J Nutr Health Aging.* 2009;13:782–8.
36. BAPEN (British Association of Parenteral and Enteral Nutrition) Malnutrition Advisory Group. The MUST Report, Nutritional screening of adults: a multidisciplinary responsibility. *Journal.* 2008. [http://www.bapen.org.uk/must\\_tool.html](http://www.bapen.org.uk/must_tool.html).
37. Landi F, Onder G, Gambassi G, Pedone C, Carbonin P, Bernabei R. Body mass index and mortality among hospitalized patients. *Arch Intern Med.* 2000;160:2641–4.
38. Sullivan DH, Johnson LE, Bopp MM, Roberson PK. Prognostic significance of monthly weight fluctuations among older nursing home residents. *J Gerontol A Biol Sci Med Sci.* 2004;59:M633–9.
39. Cereda E, Bertoli S, Battezzati A. Height prediction formula for middle-aged (30–55 y) Caucasians. *Nutrition.* 2010;26:1075–81.

40. Chumlea WC, Guo SS, Wholihan K, Cockram D, Kuczmarski RJ, Johnson CL. Stature prediction equations for elderly non-Hispanic white, non-Hispanic black, and Mexican-American persons developed from NHANES III data. *J Am Diet Assoc.* 1998;98:137–42.
41. Shenkin A. Serum prealbumin: is it a marker of nutritional status or of risk of malnutrition. *Clin Chem.* 2006;52(12):2281–5; PMID: 17068165. *Clinical Chemistry* 2006; 52(12):2177–9
42. Lim SH, Lee JS, Chae SH, Ahn BS, Chang DJ, Shin CS. Prealbumin is not a sensitive indicator of nutrition and prognosis in critical ill patients. *Yonsei Med J.* 2005;46(1):21–6.
43. Bergstrom N, Horn SD, Smout RJ, et al. The National Pressure Ulcer Long-term Care Study: outcomes of pressure ulcer treatments in long-term care. *J Am Geriatr Soc.* 2005;53:1721–9.
44. Bourdel-Marchasson I, Barateau M, Rondeau V, Dequae-Merchadou L, Salles-Montaudon N, Emeriau JP, et al. A multi-center trial of the effects of oral nutritional supplementation in critically ill older inpatients. *Nutrition.* 2000;16(1):1–5.
45. Wilson MMG, Purushothaman R, Morley JE. Effect of liquid dietary supplements on energy intake in the elderly. *Am J Clin Nutr.* 2002;75:944–7.
46. National Pressure Ulcer Advisory Panel, European pressure Ulcer Advisory Panel and Pan Pacific Pressure Injury Alliance. In: Haesler E, editor. *Prevention and treatment of pressure ulcers: quick reference guide.* Osborne Park, WA: Cambridge Media; 2014.
47. Stratton RJ, Ek AC, Engfer M, Moore Z, Rigby P, Wolfe R, Elia M. Enteral nutritional support in prevention and treatment of pressure ulcers: a systematic review and meta-analysis. *Ageing Res Rev.* 2005;4:422–50.
48. Benati G, Delvecchio S, Cilla D, Pedone V. Impact on pressure ulcer healing of an arginine-enriched nutritional solution in patients with severe cognitive impairment. *Arch Gerontol Geriatr Suppl.* 2001;7:43–7.
49. Desneves KJ, Todorovic BE, Cassar A, Crowe TC. Treatment with supplementary arginine, vitamin C and zinc in patients with pressure ulcers: a randomised controlled trial. *Clin Nutr.* 2005;24:979–87.
50. Cereda E, Gini A, Pedrolli C, Vanotti A. Disease-specific, versus standard, nutritional support for the treatment of pressure ulcers in institutionalized older adults: a randomized controlled trial. *J Am Geriatr Soc.* 2009;57:1395–402.
51. van Anholt RD, Sobotka L, Meijer EP, Heyman H, Groen HW, Topinková E, van Leen M, Schols JMGA. Specific nutritional support accelerates pressure ulcer healing and reduces wound care intensity in non-malnourished patients. *Nutrition.* 2010;26:867–72.
52. Cereda E, Klersy C, Crespi A, Seriola M, D'Andrea F, for the OligoElement Sore Trial (OEST) Study Group. A nutritional formula enriched with arginine, zinc and antioxidants for the healing of pressure ulcers: a randomized, controlled trial. *The Oligoelement Sore Trial (OEST).* *Ann Intern Med.* 2015;162(3):167–74.
53. Smith ME, Totten A, Hickam DH, Fu R, Wasson N, Rahman B, Motu'apuaka M, Saha S. Pressure ulcer treatment strategies: a systematic comparative effectiveness review. *Ann Intern Med.* 2013;159(1):39–50.



# Risk Assessment in Pressure Ulcers

# 5

Vera Lúcia Conceição de Gouveia Santos,  
Letícia Faria Serpa, Guadalupe Maria Lobo Cordero,  
Sandra Guerrero Gamboa, Heidi Hevia Campos,  
and Otilia Cruz Castañeda

## Introduction

Pressure ulcers (PU) are a serious public health problem in hospitals, nursing homes and home care, resulting in hospitalization, institutionalization, loss of quality of life, and high health care costs [1]. Increased mortality and prolonged hospital stay are significantly associated ( $p < 0.001$ ) with high prevalence of Pus [2]. Besides these outcomes and treatment costs, PUs also lead to psychological and social costs to the patient and family.

Increased morbidity and mortality rates associated with PUs reflect the importance of prevention strategies aiming at increasing the protection of patients and reducing their exposure to risk factors. One of the most important aspects of PU

---

V. L. C. de Gouveia Santos (✉)  
Medical-Surgical Nursing Department, School of Nursing (EE-USP),  
University of São Paulo, São Paulo, SP, Brazil  
e-mail: [veras@usp.br](mailto:veras@usp.br)

L. F. Serpa  
Institute of Education and Research, Oswaldo Cruz German Hospital, São Paulo, SP, Brazil

G. M. L. Cordero  
Department of Clinical Nursing, Wound Ostomy and Incontinence Center—PROCURA,  
La Central Clinic, Aguascalientes, Mexico

S. G. Gamboa  
Nursing Department, National University of Colombia, Bogotá D.C., Cundinamarca,  
Colombia

H. H. Campos  
Nursing Department, Nursing School of Andrés Bello University, Viña del Mar, Chile

O. C. Castañeda  
Ostomy and Wound Clinic, Regional General Ignacio Zaragoza I.S.S.S.T.E. Hospital,  
Mexico City, Mexico



prevention is the identification of patients at risk, or more specifically, of risk factors that make the individual more vulnerable to the development of these lesions [3].

---

## Risk Factors for PU Development

Until recently, PUs were considered a failure of nursing care. Florence Nightingale (1820–1910) already believed that good nursing care could prevent PUs, while her contemporary, Dr. Jean-Martin Charcot (1825–1893), an influential French physician, claimed that medicine could do nothing about this condition [4]. Fortunately, scientific development and in-depth studies on this type of wound have contributed to a change in attitude of health professionals, who are now more aware that the entire health team needs to be committed to the success of PU prevention programs.

Because most PUs can be prevented, the development of a PU is considered an adverse event that negatively reflects the quality of care [5]. The Joint Commission for the Accreditation of Health Care Organization, an independent, not-for-profit American organization, defined PU incidence as an indicator of quality of care [6]. Since then, a number of initiatives have been taken worldwide to prevent the development of PUs and ensure patient safety [7].

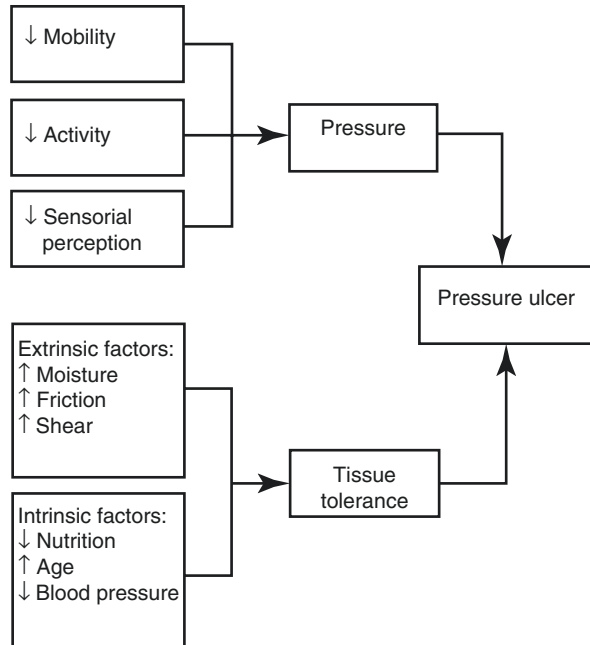
The purpose of PU risk assessment is to identify not only individuals who need preventive measures, but also specific risk factors for PU development [8]. The first known studies on PU risk were conducted more than 50 years ago [8].

Pressure is the most important factor in the development of the PUs; there is a positive correlation of PU development with duration and intensity of pressure and tissue tolerance [9–13]. Duration of pressure and shear and friction forces are critical determinants of PUs [13–15]. PU development is a complex, multidimensional phenomenon directly associated with several risk factors besides pressure, which have been classified as intrinsic and extrinsic factors [3, 13–20].

- *Intrinsic factors:* Those factors related to the physical and psychological aspects of the individual, such as age (especially, early or advanced age), mobility and activity, respiratory status, tissue oxygenation and perfusion, predisposing diseases, medication use, nutrition and hydration, overall skin health, body temperature, sensory perception, hematological changes, general health, history of a previous PU.
- *Extrinsic factors:* Those factors are related to the external aspects of the individual, such as use of perfumes, talcum powder or cleaning agents, inadequate conditions of moisture and temperature, support surfaces on which the patient is lying or sitting, manual massage techniques involving the skin surface, and excessive moisture in areas subjected to pressure and friction, especially in the perianal region because of incontinence, profuse sweating or exudates. All these factors decrease tissue resistance to pressure and other mechanical forces.

The first conceptual schema for the study of the etiology of PUs (Fig. 5.1) was developed by Braden and Bergstrom [16].

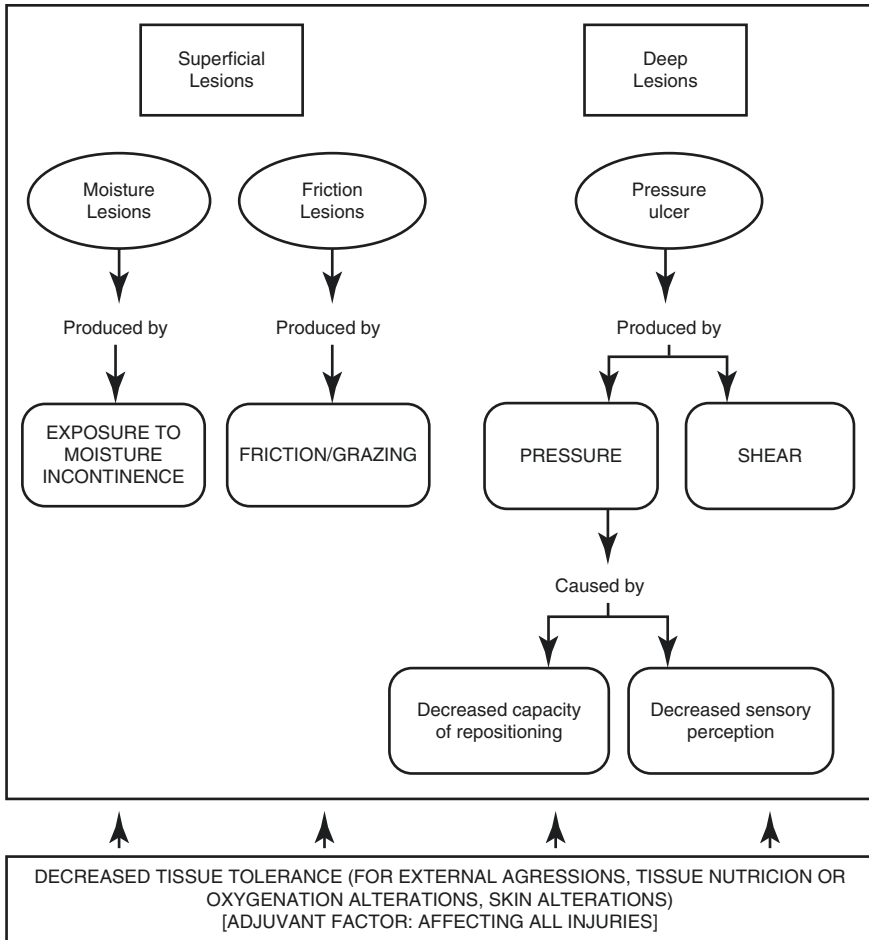
**Fig. 5.1** Conceptual schema for the study of the etiology of PUs according to Braden and Bergstrom [16]



More recently, a theoretical scheme excluding systemic factors was proposed by García Fernández et al. [8] for the study of the etiology of skin lesions (Fig. 5.2).

A systematic review of the literature [8], including studies from 1962 to 2009, identified 83 risk factors in 56 risk assessment scales for PU development, which were then classified into 23 risk dimensions by a panel of 18 experts, using the Delphi Method. The 23 dimensions were used to construct a theoretical model (middle-range theory) of chronic wound development to explain the etiology of wounds caused by moisture, pressure, friction, a combination of pressure and moisture, pressure and friction, a combination of multiple factors, and comorbid factors. The Clinical Guideline of the American College of Physicians [21], describes advanced age, Black or Hispanic ethnicity, low body weight, cognitive impairment, physical impairment and other comorbid conditions that affect the integrity of soft tissues and wound healing, including urinary and fecal incontinence, diabetes, edema, impaired microcirculation, hypoalbuminemia, and malnutrition as risk factors for PUs. Two other reviews [13, 22] identified similar risk factors, including levels of activity and mobility, perfusion, and skin health. Secondary risk factors were skin moisture, age, hematological measures (serum metabolic concentrations of protein, albumin, hemoglobin, and lymphopenia), nutrition and general health status [13, 22].

Body temperature, immunity, gender, and race may require further investigation to confirm their importance as predictors of PU development [13]. The complex interaction of multiple factors increases the likelihood of PU development [13]. Reduced physical mobility affects the patient ability to effectively relieve pressure and increases the risk of shear and friction injuries [13, 23]. Coleman et al. [13]



**Fig. 5.2** Theoretical model for the development of skin ulcers of not systemic origin and dependence-related lesions (García Fernández et al. [8])

found that reduced activity and mobility was a key risk factor in 80.5% of the reviewed studies. Patient level of mobility has shown to be more predictive of PU development than the total score of all assessment scales [13, 22].

The identification of patients at high risk of PUs is an early intervention strategy important for the primary, secondary and tertiary levels of prevention that may reduce the incidence of complications, patient suffering, and costs to the health system [22]. Risk assessment should start on admission to a health facility and repeated regularly during hospitalization, nursing home stay or at home.

Pressure ulcer is one of the most prevalent adverse events in intensive care unit (ICU) patients [24, 25]. Long periods of bed rest imposed by the therapeutic regimen, use of potent drugs with sedative, analgesic and relaxant effects, and physical limitations or disabilities that may be caused by the underlying disease [24, 26] may

reduce or even prevent the patient to efficiently react to pain and discomfort caused by prolonged pressure on the tissues. In addition, hemodynamic instability, decreased perfusion, and poor nutritional status, whether due to a major trauma, sepsis, surgery, starvation or lack of appetite [24, 26] may lead to reduced tissue tolerance for pressure and consequently increased risk of Pus [27, 28]. These patients usually require the use of mechanical ventilation, vasoactive drugs, vascular catheters, and drains, which combined with their clinical condition, make them more vulnerable to developing muscle atrophy and Pus [22, 26, 28, 29].

Surgical patients commonly develop PUs since the surgical procedure and up to five days after surgery due to their exposure to physical pressure in the operating room, although the lesions are often overlooked or only described as a “hyperemia identified in the ICU” [30, 31]. The tolerance of the cardiovascular system to surgical procedures is influenced by pharmacological agents designed to maintain the proper venous return and systemic vascular resistance. However, circulatory and respiratory changes may occur during surgery, causing hypotension and consequently affecting tissue perfusion, thus requiring the use of vasoactive drugs to improve blood circulation for preservation of cerebral and myocardial perfusion [30–32].

The prevention of PUs depends on the clinical ability to assess the level of risk of PU development in order to design a prevention program [20, 33]. The nurse’s clinical judgment is fundamental in this process; however, several instruments have been developed to identify the risk factors and thereby refine this assessment, individualizing the care and optimizing prevention costs [20, 33]. A Cochrane review [34] was conducted to determine whether the use of structured risk assessment tools in the prediction of PU development contributes to a reduction in the incidence of PUs and found only two randomized, controlled clinical trials with different levels of scientific quality. Although the authors concluded that there is no evidence to support that the use of systematic and structured risk assessment tools leads to a reduction in the incidence of PUs, these instruments are considered useful and complementary to the nurse’s clinical assessment. This recommendation is based on a systematic review and meta-analysis by García-Fernández et al. [35].

---

## Risk Assessment Tools

Because of the need to improve the clinical and health care practice and give professionals increased ability and confidence in the risk assessment process, several authors have proposed risk assessment tools, which differ in complexity, scope and ease of use, and that have been tested and validated worldwide.

Selecting a risk assessment tool requires practical and ethical considerations. Some methods of PU risk assessment may have a high predictive value, such as determining the interface pressure between the contact surface and the patient, or measuring albumin and prealbumin levels. However, these methods are not suitable for clinical practice, especially in developing countries, because they are invasive and high-cost procedures.

In 2002, there were more than 40 risk assessment tools for PU development [36], many of them based on the Norton scale [37–39]. In the 1980s, authors such as Waterlow in England and Braden and colleagues in the US still used the assessment of PU risk as a basis for the development of their instruments. The Waterlow scale [40] was developed to be applied to the nursing process and is the most commonly used in the UK and some European countries, apparently because it involves a larger number of variables compared to the Norton scale and Braden scale, and considers preventive measures. The Braden Scale for Predicting Pressure Sore Risk (Braden scale) was developed as a strategy to decrease the incidence of PUs in a health service [41]. Measures for the prediction of PUs continued to be developed to assess patients in different settings, such as the Cubbin & Jackson scale in 1991 for critically ill patients [4, 42], the Walsall Community Pressure Sore Risk Score Calculator in 1993 for patients treated at home or in the community [43], and the Sunderland scale generic version [44] and for pediatric patients [45, 46] in 1995 and 2003, respectively.

Knowing about risk assessment tools means knowing not only the items, forms of application, target population, and interpretation of ratings of a scale, but also their measurement properties (i.e., reliability and validity). The ability of risk assessment scales to predict the development of PUs is measured by sensitivity and specificity.

Sensitivity is defined as the probability that the assessment tool identifies those individuals who do develop a specific disease. Specificity is defined as the probability that the test result will be negative when the test is applied to a person who actually does not have the disease [47]. Thus, in the case of pressure ulcer risk assessment scales, sensitivity corresponds to the percentage of patients classified as being at risk who are likely to develop PUs and specificity refers to the percentage of patients correctly classified as not being at risk and did not develop PUs.

There are two other aggregate measures: the positive and negative predictive values. The positive predictive value (PPV) is the percentage of individuals classified as being at risk of PUs who actually developed PUs. The negative predictive value (NPV) is the percentage of people classified as not being at risk who is truly free of PUs [48].

Although widely studied, further studies are necessary to confirm and compare the performance of risk assessment scales - as well as their assessment factors, domains or subscale items—in different populations and in different countries.

Following, the most widely used scales in the US, Europe, Asia, and Latin American countries are presented in more detail.

## **The Norton Scale**

The first risk assessment tool for PUs was developed by Norton, McLaren and Exton-Smith in 1962 [38, 49] to assess geriatric patients. The authors identified various risk factors (physical condition, mental state, activity, mobility, and incontinence), which were later included in the scale. Each parameter was described by

one or two words and rated from 1 to 4. The sum of the ratings gives a total risk score ranging from 5 to 20, with lower scores indicating higher risk. The cutoff score of 14 indicates risk and scores  $\leq 12$  indicate high risk for PU development. In 1987, Norton proposed the score of 16 as a cutoff point for classifying individuals at moderate risk for PU development, widening the range of patients who require special care [50]. Studies have noted a linear relationship between Norton scores and incidence of PUs [38, 50–53].

A literature review found that the Norton scale shows a sensitivity of 66% (range, 0–92%), specificity of 65% (range, 31–94%), PPV of 27% (range, 7–53%), and NPV of 93% (range, 80–93%), thus exhibiting a wide variation in range of measurement properties [54].

A previous study reported more stable and adequate levels of sensitivity (range, 81–92%) and specificity (36–59%) for the Norton scale, and better predictive ability compared to other scales [14]. Similarly, a recent study [55] indicated that the Norton Scale was more efficient than the Braden and Waterlow scales in predicting PU development in surgical patients. A recent study in the Czech Republic showed the best predictive validity values for the Braden Scale, followed by the Norton Scale and the Waterlow Scale, in that order, with areas under the ROC curve of 0.696, 0.672 and 0.579 [56], respectively.

Although the Norton scale has always been considered an instrument easy to apply, some important deficiencies in its evaluation parameters has been observed, as the failure to present an operational definition of the parameters used for risk assessment, and not consider nutritional factors and skin friction [57]. Because of these disadvantages, other risk assessment scales were developed based on the Norton scale, but including some parameters to complement those proposed in the original scale to improve the results obtained. One of these instruments is the Gosnell scale, which will be presented below.

## The Gosnell Scale

In 1973, Gosnell adapted the Norton scale by using four of its five subscales, replacing the parameter “physical condition” with “nutrition”, and including items related to the assessment of skin conditions, such as appearance, tone and sensitivity [57]. Other variables, such as body temperature, vital signs, medication regimen, and medical diagnosis are also assessed but not rated numerically; parameters involved in the assessment of the skin are classified with the use of descriptors [57].

García-Fernández et al. [58] concluded that the Gosnell Scale was more appropriate for use in patients with neurological and orthopedic conditions, showing high predictive power.

A study with 230 patients with a mean age of 60 years, admitted to neurological, orthopedic, medical and intensive care units, compared the predictive validity of four PU risk assessment tools (the Braden, Gosnell, Norton and Waterlow scales). Although the Braden scale had sensitivity of 53% and specificity of 100% for scores  $\leq 16$  indicating risk of PUs, the Gosnell scale showed higher predictive power [59].

This scale was also applied to 30 residents from a geriatric center and showed sensitivity of 50% and specificity of 73% [60].

The Gosnell scale is very comprehensive and was the first to provide an operational definition of terms to reduce inter-observer variability. However, no systematic review or reliability and validity studies have been done to evaluate its effectiveness.

## The Waterlow Scale

In 1985, Waterlow proposed a scale that would work as a guide for risk assessment and prevention of PUs [40]. The scale was the result of a survey conducted at the Musgrove Park Hospital in the UK. The purpose of the scale was to create awareness of the causes of PU development and offer a method for risk assessment, PU staging, and prevention or the necessary active treatment. Waterlow suggested that the PU risk assessment should be included in nursing care plans and that the frequency of reassessment would be decided by the nurse, according to the patient's assessed level of risk. The Waterlow scale or Waterlow score has shown to be a valid tool for PU risk assessment at patient admission to the health service, establishing the patient's level of risk, and therefore enabling the implementation of appropriate preventive measures. When a patient is classified into a risk category, a list of preventive measures can be assessed [40].

Risk factors for the development of PUs can be divided into two groups [40]:

- Intrinsic factors: body build (weight for height), mobility, nutritional status, incontinence, infection, and clinical conditions (e.g., neurological disorders, anemia and malignancy); and
- Extrinsic factors: external effects of drugs, weight distribution, type of treatment, personal hygiene, and patient management.

The Waterlow scale is composed of eight items. The sum of their ratings gives a total risk score, with higher scores indicating higher risk of PUs. The reverse side of the scale provides information on the types of preventive aids associated to the assessed risk status. Incremental changes in the score indicate the patient's level of risk, as follows: at risk, 10 to 14; high risk, 15 to 19; and very high risk, 20 or above [40]. The cross-culturally adapted and validated Brazilian-Portuguese version of the Waterlow scale showed a cutoff score of 15 and scores  $\geq 15$  as the best values to predict the development of PUs, with sensitivity and specificity of 87% and 76%, respectively [61].

Several studies have been conducted comparing the Waterlow scale especially to the Norton and Braden scales. Pang and Wong [62] assessed 106 patients, 89 of them over the age of 65 years, from a rehabilitation hospital in Hong Kong. The Waterlow scale had a sensitivity of 95%, specificity of 44%, and PPV of 29%, with scores  $\geq 16$  indicating risk of PU development. Wellard and Lo [63] found that the Waterlow scale showed high sensitivity in patients with spinal cord injury.

A Brazilian study [64] with 98 hospitalized patients obtained optimal cutoff points of 17, 20, and 20 for the first, second and third risk assessments, respectively, using the Waterlow scale. Also, sensitivity values of 71.4%, 85.7%, and 85.7% and specificity values of 67, 40.7, and 32.9% were obtained for the first, second, and third assessments, respectively. These results indicate that the Waterlow scale was more sensitive and less specific at the three assessments [64].

Other Brazilian studies also confirmed the validity of the Waterlow scale in critically ill patients [65] and patients with traumatic spinal cord injury [66]. In addition, reported that the Waterlow scale allowed monitoring of the care provided, positively influencing the clinical outcomes [66].

In a recent prospective cohort study [67] performed with 55 severely ill patients, the Braden and Waterlow scales were administered on admission to an ICU and every 48 h. The Braden and Waterlow scales showed low and moderate sensitivity (41% and 71%, respectively) and low specificity (21% and 47%, respectively). The study concluded that the Braden Scale proved to be a good screening instrument and that the Waterlow scale had better predictive power [67].

Other studies have shown different results. An Australian cohort study [68] with 274 patients hospitalized in a tertiary level hospital, reported poor predictive validity of the Waterlow scale. In a cross-sectional observational study [69], the Waterlow scale did not meet the study requirements of at least 70% sensitivity and 70% specificity.

## The Cubbin and Jackson Scale

This scale was developed by Cubbin and Jackson in 1991 based on the Norton Scale format [70]. It was designed for assessment of PU risk in intensive care patients. The Cubbin and Jackson scale is composed of ten items: age, weight, the skin condition of the whole body, mental state, mobility, nutrition, respiration, incontinence, hygiene, and hemodynamic state. Each item is rated from 1 to 4 with summative scores ranging from 10 to 40. The lower the score, the higher is the likelihood of PU development [71].

There are few studies testing the validity of the Cubbin and Jackson scale. A literature review [72] considered the Cubbin and Jackson scale as the one with best predictive validity among PU risk assessment scales tested for ICU patients.

The cross-culturally adapted and validated Portuguese version of the scale shows 73.3% sensitivity, 86.7% specificity, 52.4% PPV, 94.2% NPV and accuracy of 0.91 measured by the area under the receiver operating characteristic (ROC) curve or AUC [71]. Criterion validity (also called predictive validity) was tested by comparing the Portuguese version of the Cubbin and Jackson scale with the Braden scale (the gold standard), and it was found that the revised Cubbin and Jackson scale showed better predictive values for PU development in intensive care patients [71].

Other comparative studies show that the Cubbin and Jackson scale has been most effective in assessing risk of PU development in intensive care patients. A prospective South Korean study with 219 critically ill surgical patients compared three



scales - the Braden, Song and Choi, and Cubbin and Jackson scales - to find the instrument that best measures risk of PUs [73]. The Cubbin and Jackson scale was the most effective, showing 95.0% sensitivity, 81.5% specificity, 53.5% PPV, 98.6% NPV, and AUC of 0.902 for a cutoff score of 28 [73].

More recently, a retrospective study evaluated the predictive validity of the Cubbin and Jackson scale for PU development based on 829 electronic medical records of critically ill patients from four ICUs of a tertiary level hospital [74]. For a cutoff point of 24 and incidence of PUs of 14.2%, the scale showed 72.0% sensitivity, 68.8% specificity, 27.7% PPV, 93.7% NPV, and AUC of 0.76. Information related to eight of the ten items (except mobility and hygiene) of the Cubbin and Jackson scale was extracted from electronic medical records. The use of nursing information from electronic medical records may help health professionals in the evaluation of the effectiveness of PU prevention and management strategies, and increase the efficiency of nursing services [74].

However, a study evaluating the main factors associated with the development of PUs (including previously unidentified factors) in a mixed ICU, used a modified Cubbin and Jackson scale in 1629 adults. Clinical treatment and treatment duration were the most important and prevalent factors. A cutoff point of 29, already used in other studies, was not optimal for the identification of patients at high risk of PUs, requiring further investigation of patient populations, associated risk factors for PUs, and on the significance of individual components of the scale [75].

## The Braden Scale

The Braden Scale for Predicting Pressure Sore Risk (Braden scale) was developed in 1987 [41, 50] as a means to optimize strategies for the prevention of PUs and consequent reduction of the incidence of these lesions. A conceptual framework was developed for the study of the etiology of PUs, involving two critical determinants: intensity and duration of pressure and tolerance of the skin and supporting structures for pressure [16]. According to the conceptual model, the intensity and duration of pressure involve the risk factors sensory perception, mobility and activity. The tolerance of the skin and underlying structures for pressure or the capacity of the tissue to tolerate the mechanical load refers to intrinsic factors, such as nutrition, and extrinsic factors, including moisture, friction and shear. A scale composed of six subscales (sensory perception, activity, mobility, humidity, nutrition and friction and shear) was built based on this conceptual model (Fig. 5.1).

The sensory perception subscale measures the patient's ability to notice and respond to discomfort caused by exposure to increased pressure on the skin. The sensation of pressure or discomfort makes the person to change position or seek assistance to make small or large shifts in body weight. The inability to feel or recognize pressure or discomfort increases the risk of PU development. The activity and mobility subscales are used to assess the frequency and duration of activity, or changes in position. Mobility refers to the patient's ability to relieve pressure through movements while lying in bed and activity refers to the frequency of

movements when the patient is out of bed. The nutrition subscale measures the usual pattern of food consumption by controlling the daily intake of the meal provided, indicating the amount of protein, fluid intake, need and acceptance of dietary supplements, and use of tube feeding or total parenteral nutrition. The moisture subscale assesses the degree of moisture to which the skin is exposed. Urinary or anal incontinence, wound drainage, perspiration and food waste are potential sources of moisture. At last, the friction and shear subscale measures the patient's ability to move or be moved leaving the skin free from contact with the surface of the bed or chair during position changes [14].

The subscales are rated from 1 to 4, except friction and shear, which is rated from 1 to 3. The sum of the ratings gives a total risk score (possible range: 6 to 23), with lower scores indicating higher risk of PUs. For many years it was considered that scores  $\leq 16$  were indicative of risk for PU development [14]. In a later study [76], a cutoff score of 18 was suggested for the assessment of elderly populations who are physiologically unstable or have low access to individualized care. In 2002, a new risk classification was proposed by Ayello and Braden [77] and the patient's level of risk was indicated by incremental changes in scores as follows: at risk, 15 to 18; moderate, 13 to 14; high risk, 10 to 12; and very high, risk  $\leq 9$ . This risk classification can help practitioners determine when aggressive prevention measures should be taken, valuing the clinical judgment of the health professional. The same authors also suggested a prevention protocol according to the patient's risk score [77].

Several reviews have been conducted on the predictive validity of the Braden scale in different populations. The Braden scale is considered the PU risk assessment tool most studied worldwide.

Pancorbo-Hidalgo et al. [78] conducted a literature review and concluded that the Braden scale has a better balance of sensitivity (57.1%) and specificity (67.5%) for a cutoff score of 16 compared to the Norton and Waterlow scales.

A more recent systematic review and meta-analysis [35] compared the predictive capacity of PU risk assessment scales published between 1962 and 2010 in English, Spanish, Portuguese, Korean, German and Greek with nurses' clinical judgment to predict PU development. Thirty-one of 57 identified studies included a validation study and four studies tested nurses' clinical judgment as a risk prediction factor. The meta-analysis showed levels of relative risk (RR) for the Braden scale (RR = 4.26), Norton scale (RR = 3.69); Waterlow scale (RR = 2.66); Cubbin and Jackson scale (RR = 8.63); mEntal status, Mobility, Incontinence, Nutrition and Activity (EMINA) scale (RR = 6.17); Pressure Sore Predictor Scale (RR = 21.4); and nurses' clinical judgment (RR = 1.89), confirming the high predictive power of almost all scales. Nurses' clinical judgment did not show adequate predictive power when used alone [35].

A review of the literature of articles on the predictive validity of the Braden scale for pressure ulcer development, which were published between 1946 and 2013, selected 38 papers involving 17,934 patients [79]. The authors concluded that the scale had moderate predictive validity, caused in part by heterogeneity among studies [79]. A recent review and meta-analysis by the same research team [80] of articles published from 1966 to 2013 identified 21 studies with high methodological

quality on PU risk assessment involving a total of 6070 patients. The pooled sensitivity, specificity and AUC were 0.72 (95% CI, 0.68–0.75), 0.81 (95% CI, 0.80–0.82), and 0.84 (SE = 0.02) respectively, confirming a moderate to good predictive validity of the scale. A detailed analysis showed that age and reference standards were the factors that most affected the predictive validity of the Braden scale [80].

Studying the predictive validity of the Braden, Norton and Waterlow scales in the elderly, the authors [81] found 29 studies showing a moderate predictive validity for the scales, with similar variations in sensitivity and specificity among studies. A high heterogeneity (80%) was observed among scales, which is in agreement with previous studies. Studies applying the Braden scale used five different cutoff points, which is probably the primary cause of heterogeneity [81]. Other review including nine studies carried out with a total of 40,361 residents of long-term care facilities [82] found pooled sensitivity, specificity, PPV, and NPV of 86, 38, 28, and 93%, respectively. Through a random effects model, the study showed that the Braden scale has good overall predictive validity [RR = 4.33; 95% CI, 3.28–5.72]. Nevertheless, the authors concluded that the adequacy of this scale for this population is questionable in view of its low specificity and PPV, which may be attributed to the cutoff point used and prevention strategies implemented by the institutions [82].

In addition to the systematic reviews, a number of cohort studies have investigated the predictive validity of the Braden scale using different cutoff scores and by comparing or not comparing it with other scales. The most important findings from recent studies are described below.

Three articles reported that higher cutoff scores have resulted in better predictive validity for the following PU risk assessment tools: the Braden scale and Norton scale modified by the INSALUD scale (Norton-MI scale) for hospitalized patients [83], the Modified Norton scale for hospitalized patients in general [49], and the Braden scale for critical patients [84]. Nevertheless, Källman and Lindgren [49] confirmed that the cutoff scores recommended for the Braden, Norton and Risk Assessment Pressure Sore (RAPS) scales proved to be valid in general hospitals.

With regard to the specific items of the scales, Wang et al. [85] found that, although the interrater reliability of the Braden, Norton and Waterlow total scores were all quite high, the reliability of some items was not so good. Thus, health professionals should administer these instruments with special attention to the items moisture, physical condition, and skin type. Further studies should consider changes in these items making them less ambiguous and more reliable. Serpa and Santos [20] observed that the nutrition subscale of the Braden Scale was not predictive of PU development in critical patients. In contrast, serum albumin levels and the Subjective Global Assessment showed to be better predictors of PUs. Perfusion and skin conditions were considered important factors for risk assessment of PUs, but not on the Braden scale [13, 22].

In the 2000s, several other studies have tested different cutoff points for the Braden scale, obtaining increased predictive validity with cutoff points of 14 for hospitalized patients in China [86], 19 for hospitalized patients in Germany [87]; and 13 for critically ill patients in Brazil [88–90].

A prospective study was conducted in the Netherlands [36] evaluating the routine use of risk assessment scales (the Norton, Waterlow, and Braden scales) to

predict UP in neurological, geriatric and medical-surgical patients at the recommended cutoff points. The results show poor PPV for all scales (7, 5.3 and 7.8%, respectively) and also low values of sensitivity and specificity for the Norton scale (46.2% and 60.4%, respectively), Waterlow scale (89.5% and 22.4%, respectively), and Braden scale (43.5% and 67.8%, respectively).

One systematic review and meta-analysis analyzed the predictive validity of Waterlow, Modified Braden, and Cubbin & Jackson's pressure ulcer risk scales, based on 17 well-designed studies assessing diagnosis. As ROC AUC is over 0.7, all analyzed instruments showed moderate predictive validity, but they have limited interpretation due to high differences between studies. In addition, Waterlow's instrument is insufficient for use as a screening tool owing to low sensitivity [91].

A Brazilian study [92] compared the Braden and Waterlow scales and found that the sensory perception and friction and shear Braden subscales and the mobility and appetite Waterlow subscales were the most important risk factors in predicting PU development in hospitalized patients.

Most studies showing evidence of the good predictive value of various PU risk assessment scales reinforce the importance of these tools for the nurses' clinical judgment. According to the latest version of the consensus recommendations on prevention and treatment of Pus [3] developed by the National Pressure Ulcer Advisory Panel (NPUAP), European Pressure Ulcer Advisory Panel (EPUAP) and Pan Pacific Pressure Injury Alliance (PPPIA), a selected risk assessment tool should be appropriate to the population, valid and reliable (Strength of evidence = C; strength of recommendation = X).

---

## Pediatric Scales

The problem of PUs has been well documented in the adult population, but not in the pediatric and neonatal populations, despite the susceptibility of the skin to PUs among pediatric and neonatal patients and indications of a high incidence of PUs in these groups. The use of PU risk assessment tools is essential for risk prevention and decision making before or after the signs of PUs [93].

The mechanism of PU development in pediatric patients is similar to that in adults, but differs in location. Children under three years old often suffer from bedsores in the heels, ears and occipital region. In fact, the pediatric patient who cannot move is at a high risk of developing PUs [94].

The incidence and prevalence of pediatric PUs vary across different population groups from 0.29% [95] to 24% in pediatric ICUs [45].

## The Braden Q Scale

The Braden Q scale is the pediatric version of the Braden Scale. It was developed by Quingley and Curley in 1996 and is the most studied and used PU risk assessment tool in this population group [46]. Children of 1 to 5 years of age are evaluated by the Braden Q scale using two parameters: the first measures the intensity and

duration of pressure (mobility, activity and sensory perception), and the second parameter assesses tissue tolerance by determining moisture, shear, nutrition status, perfusion, and tissue oxygenation [46, 96].

The Braden Q scale includes six original subscales of the Braden scale (mobility, activity, sensory perception, moisture, nutrition, and friction and shear), and an additional subscale (tissue perfusion and oxygenation) that also considers the clinical characteristics of pediatric patients, such as the use of a transpyloric or gastric tube feeding catheter, blood pressure, oxygen saturation, hemoglobin quantification, blood pH, capillary refill, and use of non-invasive technology in intensive care [97].

Each subscale is rated from 1 (at risk) to 4 (low risk). The sum of the ratings gives a total score (possible range, 7 to 28), with lower scores indicating higher risk of developing PUs. The authors of the scale proposed the following risk classification based on total scores: high risk, 16 or less; moderate risk, 17 to 21; low risk, 22 to 25; and no risk, above 25 [45]. PU prevention programs should include at least a full skin assessment and administration of the Braden Q scale within the first 24 h of admission. The authors recommend that this procedure be repeated daily on all patients who score 16 or less, are on bed rest or chairfast, or who has a change in clinical condition [97].

In the original study, the Braden Q scale was administered to 322 pediatric ICU patients, showing 83% sensibility and 58% specificity with good predictive power [45, 46]. A score of 16 or less indicates increased risk for pressure-ulcer development [46]. The validity of the scale has also been tested by several studies conducted in different populations; these studies reported sensitivity ranging from 0.88 to 0.98 and specificity ranging from 0.58 to 0.99 [94].

The Braden Q scale was applied in the UK to children from 3 weeks to 8 years of age, without congenital heart disease, and showed sensitivity of 100%, specificity of 73.1%, PPV of 2.56, NPV of 100 and AUC of 0.87 (95% IC, 0.75–0.98). When the scale was applied to older children or children with congenital heart disease, values of sensitivity and AUC were reduced and confidence intervals were extended, showing lower limits <0.5. The Braden Q scale had a sensitivity of 75%, specificity of 72.6%, PPV of 1.5, NPV of 99.8 AUC of 0.74 (95% CI, 0.49–0.98) when applied to children 14 years of age [98]. In a recent study conducted in China, values of sensitivity of 71% and specificity of 53% were obtained for a cutoff of 19. The AUC for the Braden Q Scale items ranged from 0.543 to 0.612 [99]. The Turkish version of the scale had a Cronbach's alpha of 0.80 for the total score, with alpha ranging from 0.72 to 0.82 among the subscales. According to ROC analysis, sensitivity was high (AUC = 0.95,  $p < 0.001$ ) for all subscales, and high levels of specificity (AUC = 52.8,  $p < 0.001$ ) were observed [95].

The Braden Q scale was cross-culturally adapted and validated to Brazilian Portuguese by Maia and colleagues in 2007 [96] confirming the internal consistency (Cronbach's alpha = 0.936), intra-observer agreement (ICC = 0.995) and inter-observer agreement (ICC = 0.998) of the original scale. The Colombian Spanish version of the Braden Q scale was validated in 100 patients, of whom 57 were hospitalized in a pediatric intensive care unit (PICU) and 43 in an intermediate intensive care unit (IICU) [93]. The scale showed sensitivity of

90%, specificity 60.8%, PPV of 66.6%, NPV of 87.5% and efficiency of 74.4% for PICU patients, while its application in the IICU yielded sensitivity of 80%, specificity of 96.1%, PPV of 66.6%, NPV of 98%, and an efficiency of 94.7% for correctly classifying patients [93]. These predictive validity values are consistent with those reported for the Braden Scale at cutoff scores from 16 to 18 in different adult populations treated in tertiary level care settings (as described in the previous segment).

### **Neonatal Skin Risk Assessment Scale (NSRAS)**

Huffness and Logsdon [100] developed the Neonatal Skin Risk Assessment Scale (NSRAS) specifically for the neonatal population ( $\leq 21$  days old) based on the Braden Scale for adults [101]. Initially, six subscales (general physical condition, activity, nutrition, mental status, mobility, and moisture) were created for neonates, but three subscales (mental status, mobility, and moisture) had low reliability and were later removed from psychometric evaluation. General physical condition is evaluated according to the gestational age. The remaining subscales showed sensitivity of 83%, specificity of 81%, reliability of 97%, PPV of 0.50, and NPV of 0.95 for a cutoff point of 5 [100]. Although the mental status, mobility and moisture subscales were removed, the use of the total instrument is recommended because of the importance of these items in the etiology of PUs and the fact that they are considered essential in determining skin breakdown [19]. The following risk classification was defined based on total scores: low risk, 29 to 26; moderate risk, 25 to 21; and high risk,  $\leq 20$  [100, 102]. Recently, Herrera et al. [93] applied the NSRAS to 47 newborns from a neonatal ICU, obtaining 93.3% sensitivity, 75% specificity, 63.6% PPV, 96% NPV and 80.8% efficiency. Dolack et al. (2013) [19] tested the scale in newborns in most modern environmental conditions, using incubators with moisture control that allows reduction of transepidermal losses, which will probably have an impact on the predictive measures of the scale. However, the final results have not been published to date.

### **Neonatal Skin Condition Scale (NSCS)**

The NSCS scale was developed by the Association of Women's Health, Obstetric and Neonatal Nurses (AWHONN) in collaboration with the National Association of Neonatal Nurses (NANN) in 2001 to provide evidence-based guidelines for neonatal skin care [19]. Lund and Osborne [103] applied the instrument in 2820 children from 51 neonatal ICUs and well-baby nurseries in 27 US states, and concluded that higher scores were associated with increased risk of systemic infection, prolonged hospital stays, and an increased risk of skin breakdown. The NSCS is a very basic scale, assessing only dryness, erythema and excoriation, and is recommended for children weighing more than 1000  $\mu\text{g}$ . No further studies on the NSCS scale were found in the literature to date.

## Final Considerations

Prevention of PUs requires a better understanding of all aspects involved in the development of these lesions by health professionals, as well as attitudes toward ethical care, and adoption of best practices, including the search for adequate resources.

This chapter covered one of the most important strategies for PU prevention, included as a recommendation in guidelines of international agencies, such as the NPUAP, EPUAP and PPPIA. Some of the described scales already show evidence of their predictive ability, requiring increased research to determine the most appropriate cutoff points, according to the characteristics of the patient being assessed and resources available in different institutions and different countries. Moreover, further studies evaluating the outcome of the care provided by risk-adjusted programs and cost-effectiveness of new products, techniques and equipment for the prevention of these injuries are also necessary [104].

New alternatives of risk assessment scales for pressure ulcer have been studied by professionals according to their needs, such as: a scale to assess the risk of surgical positioning injuries in adult patients [105]; a Bayesian predictive model from medications, diagnosis and Braden scale features that identifies known and suspected high PU risk factors, and also substantially increases sensitivity of the prediction - nearly three times higher comparing to logistical regression models [106]. Both tools need more research to confirm their reliability and validity for clinical use.

A longitudinal, six-month cohort study evaluated the validity of the Braden and EMINA scales, selecting quantitative cutoffs to differentiate the risk of pressure ulcer in home-based care patients. The new cut-off points according to the present study are established for Braden: zero risk, 23; low risk, 16–22; moderate risk, 11–15 and high risk  $\leq 10$ , being for EMINA: zero risk, 0; low risk, 1–6; Moderate risk, 7–11, and high risk, 12–15 [107].

It is important to identify areas where the knowledge of the professionals involved in patient care appears to be deficient, as this may guide the planning of strategies for the dissemination and adoption of preventive measures by the team [108]. Although several strategies can be used to improve the level of knowledge of health professionals, it is mandatory to identify personal and institutional barriers that hinder the achievement of the proposed goals [109].

The risk assessment tools (RAT) or pressure ulcer risk assessment scores (PURAS) are widely used across all healthcare settings to help clearly identify patients prevention strategies should be targeted towards. NICE recommends that a validated tool is used to support clinical judgment when assessing risk and the international guidelines (National Pressure Ulcer Advisory Panel (NPUAP), European Pressure Ulcer Advisory Panel (EPUAP) and Pan Pacific Pressure Injury Alliance (PPPIA) and to have caution of ‘do not rely on a total risk assessment tools score alone as a basis for risk prevention subscales and should be other risk factors examined to guide risk-based planning’.

There is much discussion around the utility of RATs. In a Cochrane review of RAT, Moore and Cowan concluded that there is no reliable evidence to suggest that use of structured systematic PURAS reduces the incidence of pressure ulcers [110].

---

## References

1. Krasner D. Pressure ulcers: assessment, classification and management. In: Krasner D, Kane D, editors. *Chronic wound care*. 2nd ed. Wayne: Health Management; 1997.
2. Louro M, Ferreira M, Póvoa P. Evaluation of a prevention protocol of pressure ulcers. *Rev Bras Ter Intensiva*. 2007;19:337–41.
3. NPUAP, EPUAP, PPIIA. Prevention and treatment of pressure ulcers: quick reference guide. In: Haesler E, editor. 2nd ed. Cambridge, Perth: Media; 2014.
4. Ousey K. *Pressure area care*. Oxford: Wiley; 2009.
5. Black JM, Edsberg LE, Baharestani MM, et al. Pressure ulcers: avoidable or unavoidable? Results of the National Pressure Ulcer Advisory Panel Consensus Conference. *Ostomy Wound Manage*. 2011;57:24–37.
6. Mainz J. Defining and classifying clinical indicators for quality improvement. *Int J Qual Health Care*. 2003;15:523–30.
7. Allegranzi B, Storr J, Dziekan G, et al. The first global patient safety challenge “clean care is safer care”: from launch to current progress and achievements. *J Hosp Infect*. 2007;65(Suppl 2):115–23.
8. García-Fernández FP, Agreda JJ, Verdú J, et al. A new theoretical model for the development of pressure ulcers and other dependence-related lesions. *J Nurs Scholarsh*. 2014;46:28–38.
9. Linder-Ganz E, Gefen A. The effects of pressure and shear on capillary closure in the microstructure of skeletal muscles. *Ann Biomed Eng*. 2007;35:2095–107.
10. NPUAP. Terms and definitions related to support surfaces. 2007. [http://www.npuap.org/wp-content/uploads/2012/03/NPUAP\\_S3L\\_TD.pdf](http://www.npuap.org/wp-content/uploads/2012/03/NPUAP_S3L_TD.pdf). Accessed 22 Oct 2015.
11. Hanson D, Langemo DK, Anderson J, et al. Friction and shear considerations in pressure ulcer development. *Adv Skin Wound Care*. 2010;23:21–4.
12. Strazzieri-Pulido KC, Santos VLGC. Support surfaces: Parte I. *Rev Estima*. 2010;8:40–2.
13. Coleman S, Gorecki C, Nelson EA, et al. Patient risk factors for pressure ulcer development: systematic review. *Int J Nurs Stud*. 2013;50:974–1003.
14. Bergstrom N, Braden BJ, Laguzza A, et al. The Braden Scale for predicting pressure sore risk. *Nurs Res*. 1987;36:205–10.
15. Coleman S, Nixon J, Keen J, et al. A new pressure ulcer conceptual framework. *J Adv Nurs*. 2014;70:2222–34.
16. Braden B, Bergstrom N. A conceptual schema for the study of the etiology of pressure sores. *Rehabil Nurs*. 1987;12:8–12.
17. Souza DMST, Santos VLGC. Úlceras por pressão e envelhecimento. *Rev Estima*. 2006;4:36–44.
18. Benoit R, Mion L. Risk factors for pressure ulcer development in critically ill patients: a conceptual model to guide research. *Res Nurs Health*. 2012;35:340–62.
19. Dolack M, Huffines B, Stikes R, et al. Updated Neonatal Skin Risk Assessment Scale (NSRAS). *Ky Nurse*. 2013;61:6.
20. Serpa LF, Santos VL. Validity of the Braden Nutrition Subscale in predicting pressure ulcer development. *J Wound Ostomy Continence Nurs*. 2014;41:436–43.
21. Qaseem A, Mir TP, Starkey M, et al. Risk assessment and prevention of pressure ulcers: a clinical guideline from the American College of Physicians. *Ann Intern Med*. 2015;162:359–69.
22. Raju D, Su X, Patrician AP, et al. Exploring factors associated with pressure ulcers: a data mining approach. *Int J Nurs Stud*. 2015;52:102–11.



23. Coqueiro JM, Brito RS. Multiple risk factors and preventive strategies of pressure ulcers: systematic review. *J Nurs UFPE Online*. 2013;7:6215–22.
24. de Paiva MC, de Paiva SA, Berti HW. Adverse events: analysis of a notification instrument used in nursing management. *Rev Esc Enferm USP*. 2010;44:286–94.
25. Aranaz-Andrés JM, Aibar-Remón C, Limón-Ramírez R, et al. IBEAS design: adverse events prevalence in Latin American hospitals. *Rev Calidad Asistencial*. 2011;26:194–200.
26. Bucknall TK. Medical error and decision making: learning from the past and present in intensive care. *Aust Crit Care*. 2010;32:150–6.
27. Apostolopoulou E, Tselebis A, Terzis K, et al. Pressure ulcer incidence and risk factors in ventilated intensive care patients. *Health Sci J*. 2014;8:333–9.
28. Campanilli TCGF, Santos VLGC, Strazzieri-Pulido KC, et al. Incidence of pressure ulcers in cardiopneumologic intensive care unit patients. *Rev Esc Enferm USP*. 2015;49:7–14.
29. Carvalho PO, Gomes AC, Gomes ET. Risk assessment for development of pressure ulcers in critical patients. *J Nurs UFPE Online*. 2015;9:8512–8.
30. Lewicki LJ, Mion L, Splane KG, et al. Patient risk factors for pressure ulcers during cardiac surgery. *AORN J*. 1997;65:933–42.
31. Padula CA, Osborne E, Williams J. Prevention and early detection of pressure ulcers in hospitalized patients. *J Wound Ostomy Continence Nurs*. 2008;35:66–75.
32. Shahin ES, Dassen T, Halfens RJ. Pressure ulcer prevalence and incidence in intensive care patients: a literature review. *Nurs Crit Care*. 2008;13:71–9.
33. Bergquist S. Subscales, subscores, or summative score: evaluating the contribution of Braden Scale items for predicting pressure ulcer risk in older adults receiving home health care. *J Wound Ostomy Continence Nurs*. 2001;28:279–89.
34. Moore ZE, Cowman S. Risk assessment tools for the prevention of pressure ulcers. *Cochrane Database Syst Rev*. 2014;2:CD006471.
35. García-Fernández FP, Pancorbo-Hidalgo PL, Agreda JJ. Predictive capacity of risk assessment scales and clinical judgment for pressure ulcers: a meta-analysis. *J Wound Ostomy Continence Nurs*. 2014;41:24–34.
36. Schoonhoven L, Haalboom JR, Bousema MT, et al. Prospective cohort study of routine use of risk assessment scales for prediction of pressure ulcers. *BMJ*. 2002;325:797.
37. Norton D, Exton-Smith AN, McLaren R. An investigation of geriatric nursing problems in hospital. London: National Corporation for the Care of Old People; 1962.
38. Goldstone LA, Goldstone J. The Norton score: an early warning of pressure sores? *J Adv Nurs*. 1982;7:419–26.
39. Norton D. Norton revised risk scores. *Nurs Times*. 1987;83:6.
40. Waterlow J. Pressure sores: a risk assessment card. *Nurs Times*. 1985;81:49–55.
41. Bergstrom N, Demuth PJ, Braden BJ. A clinical trial of the Braden scale for predicting pressure sore risk. *Nurs Clin North Am*. 1987;22:417–28.
42. Jackson C. The revised Jackson/Cubbin pressure area risk calculator. *Intensive Crit Care Nurs*. 1999;15:169–75.
43. Dealey C. The care of wounds: a guide for nurses, 3rd ed. Oxford: Blackwell; 2008. Brazilian Portuguese edition: Dealey C. Cuidando de feridas: Um guia para as enfermeiras (trans: Lacerda RA, Santos VLGC), 3rd edn. São Paulo: Atheneu; 2008.
44. Lowery MT. A pressure sore risk calculator for intensive care patients: ‘the Sunderland experience’. *Intensive Crit Care Nurs*. 1995;11:344–53.
45. Curley MA, Quigley SM, Lin M. Pressure ulcers in pediatric intensive care: incidence and associated factors. *Pediatr Crit Care Med*. 2003a;4:284–90.
46. Curley MA, Razmus IS, Roberts KE, et al. Predicting pressure ulcer risk in pediatric patients: the Braden Q Scale. *Nurs Res*. 2003b;52:22–33.
47. Fletcher R, Fletcher S. Clinical epidemiology: the essentials. 4th ed. Philadelphia: Lippincott Williams & Wilkins; 2005. Brazilian Portuguese edition: Fletcher R, Fletcher S. Epidemiologia Clínica: Elementos essenciais (trans: Martins RM) 4ª Ed. Porto Alegre: Artmed; 2006.
48. Brown SJ. The Braden scale: a review of the research evidence. *Orthop Nurs*. 2004;23:30–8.

49. Källman U, Lindgren M. Predictive validity of 4 risk assessment scales for prediction of pressure ulcer development in a hospital setting. *Adv Skin Wound Care*. 2014;27:70–6.
50. Haalboom JR, den Boer J, Buskens E. Risk-assessment tools in the prevention of pressure ulcers. *Ostomy Wound Manage*. 1999;45:20–34.
51. Gutiérrez-Fernández F. Prevenir las úlceras por presión es garantizar la calidad asistencial. *Enfermería Científica*. 1993;140:7–10.
52. Braden BJ, Bergstrom N. Predictive validity of the Braden Scale for pressure sore risk in a nursing home population. *Res Nurs Health*. 1994;17:459–70.
53. Norton D. Calculating the risk: reflections on the Norton Scale. *Adv Wound Care*. 1996;9:38–43.
54. García-Fernández FP, Pancorbo-Hidalgo PL, Torra i Bou JE, et al. Escalas de valoración de riesgo de úlceras por presión. In: Soldevilla-Agreda JJ, Torra I Bau JE, editors. *Atención integral en las heridas crónicas*. 1st ed. Madrid: SPA; 2004.
55. Kumari S, Sharma D, Rana A, et al. Risk assessment tool for pressure ulcer development in Indian surgical wards. *Indian J Surg*. 2015;77:206–12.
56. Sateková L, Ziaková K, Zelenikova R. Predictive validity of the Braden scale Norton Scale and Waterlow Scale in the Czech Republic. *Int J Nurs Pract*. 2017;23:e12499.
57. Gosnell DJ. Assessment and evaluation of pressure sores. *Nurs Clin North Am*. 1987;22:399–416.
58. García-Fernández FP, Bermejo-Cobo J, Pérez-Catalán MJ, et al. Validación de dos escalas de valoración del riesgo de úlceras por presión: Gosnell y Nova-4. *Rev Enferm*. 1999;22:685–7.
59. Jalali R, Rezaie M. Predicting pressure ulcer risk: comparing the predictive validity of 4 scales. *Adv Skin Wound Care*. 2005;18:92–7.
60. Pancorbo-Hidalgo PL, García-Fernández FP, Soldevilla-Agreda JJ, et al. Valoración del riesgo de desarrollar úlceras por presión: uso clínico en España y metaanálisis de la efectividad de las escalas. *Gerokomos*. 2008;19:84–98.
61. Rocha ABL, Barros SMO. Pressure ulcer risk assessment: sensitivity and specificity properties of the portuguese version of Waterlow scale. *Acta Paul Enferm*. 2007;20:143–50.
62. Pang SM, Wong TK. Predicting pressure sore risk with the Norton, Braden, and Waterlow scales in a Hong Kong rehabilitation hospital. *Nurs Res*. 1998;47:147–53.
63. Wellard S, Lo SK. Comparing Norton, Braden and Waterlow risk assessment scales for pressure ulcers in spinal cord injuries. *Contemp Nurse*. 2000;9:155–60.
64. Serpa LF, de Gouveia Santos VL, Gomboski G, et al. Predictive validity of Waterlow scale for pressure ulcer development risk in hospitalized patients. *J Wound Ostomy Continence Nurs*. 2009;36:640–6.
65. Araújo TM, Araújo MFM, Caetano JA. Comparison of risk assessment scales for pressure ulcers in critically ill patients. *Acta Paul Enferm*. 2011;24:695–700.
66. Studart RMB, Melo EM, Lopes MVO, et al. Nursing technology in the prevention of pressure ulcer in people with spinal cord injury. *Rev Bras Enferm*. 2011;64:494–500.
67. Borghardt AT, Prado TN, Araújo TM, et al. Evaluation of the pressure ulcers risk scales with critically ill patients: a prospective cohort study. *Rev Lat Am Enfermagem*. 2015;23:28–35.
68. Webster J, Gavin N, Nicholas C, et al. Validity of the Waterlow scale and risk of pressure injury in acute care. *Br J Nurs*. 2010;19:S14, S16, S18 passim.
69. Tannen A, Balzer K, Kottner J, et al. Diagnostic accuracy of two pressure ulcer risk scales and a generic nursing assessment tool. A psychometric comparison. *J Clin Nurs*. 2010;19:1510–8.
70. Hunt J. Application of a pressure area risk calculator in an intensive care unit. *Intensive Crit Care Nurs*. 1993;9:226–31.
71. Souza B. Translation, adaptation, and validation of the Sunderland Scale and the Cubbin & Jackson Revised Scale in Portuguese. *Rev Bras Ter Intensiva*. 2013;25:106–14.
72. Jun Seongsook RN, Jeong Ihnsook RN, Lee Younghee RN. Validity of pressure ulcer risk assessment scales; Cubbin and Jackson, Braden, and Douglas scale. *Int J Nurs Stud*. 2004;41:199–204.
73. Kim EK, Lee SM, Lee E, et al. Comparison of the predictive validity among pressure ulcer risk assessment scales for surgical ICU patients. *Aust J Adv Nurs*. 2009;26:87–94.

74. Kim EK, Choi M, Lee J, et al. Reusability of EMR data for applying Cubbin and Jackson Pressure Ulcer Risk Assessment scale in critical care patients. *Health Inform Res.* 2013;19:261–70.
75. Ahtiala M, Soppi E, Wiksten A, et al. Occurrence of pressure ulcers and risk factors in a mixed medical-surgical ICU: a cohort study. *JICS.* 2014;15:340–3.
76. Bergstrom N, Allman RM, Carlson CE, et al. Pressure ulcers in adult: prediction and prevention. Quick reference guide for clinician. *AHCPR.* 1992:92–0050.
77. Ayello EA, Braden B. How and why to do pressure ulcer risk assessment. *Adv Skin Wound Care.* 2002;15:125–33.
78. Pancorbo-Hidalgo PL, Garcia-Fernandez PF, Lopez-Medina IM, et al. Risk assessments scales for pressure ulcer prevention: a systematic review. *J Adv Nurs.* 2006;54:94–110.
79. Park SH, Park YS. Predictive validity of the Braden Scale for pressure ulcer risk: a meta-analysis. *J Korean Acad Nurs.* 2014;44:595–607.
80. Park SH, Choi YK, Kang CB. Predictive validity of the Braden Scale for pressure ulcer risk in hospitalized patients. *J Tissue Viability.* 2015a;24:102–13.
81. Park SH, Lee YS, Kwon YM. Predictive validity of pressure ulcer risk assessment tools for elderly: a meta-analysis. *West J Nurs Res.* 2015b. <https://doi.org/10.1177/0193945915602259>.
82. Wilchesky M, Lungu O. Predictive and concurrent validity of the Braden scale in long-term care: a meta-analysis. *Wound Repair Regen.* 2015;23:44–56.
83. González-Ruiz JM, Sebastián-Viana T, Losa-Iglesias ME, et al. Braden scale and Norton scale modified by INSALUD in an acute care hospital: validity and cutoff point. *Adv Skin Wound Care.* 2014;27:506–11.
84. Jin Y, Piao J, Lee SM. Evaluating the validity of the Braden scale using longitudinal electronic medical records. *Res Nurs Health.* 2015;38:152–61.
85. Wang LH, Chen HL, Yan HY, et al. Inter-rater reliability of three most commonly used pressure ulcer risk assessment scales in clinical practice. *Int Wound J.* 2015;12:590–4.
86. Kwong E, Pang S, Wong T, et al. Predicting pressure ulcer risk with the modified Braden, Braden, and Norton scales in acute care hospitals in Mainland China. *Appl Nurs Res.* 2005;18:122–8.
87. Balzer K, Pohl C, Dassen T, et al. The Norton, Waterlow, Braden, and Care Dependency Scales: comparing their validity when identifying patients' pressure sore risk. *J Wound Ostomy Continence Nurs.* 2007;34:389–98.
88. Paranhos WY, Santos VLCG. Avaliação de risco para úlceras de pressão por meio da Escala de Braden, na língua portuguesa. *Rev Esc Enferm USP.* 1999;33:191–206.
89. Matuo CM, da Silva Cardoso JR, Santos VLCG, et al. Predictive validity of Braden scale for hospitalized patients. *J Wound Ostomy Continence Nurs.* 2008;35:S64–5.
90. Serpa LF, Santos VL, Campanili TC, et al. Predictive validity of Braden scale for pressure ulcer risk in critical care patients. *Rev Lat Am Enfermagem.* 2011a;19:50–7.
91. Park SH, Lee HS. Assessing predictive validity of pressure ulcer risk Scales—a systematic review and meta-analysis. *Iran J Public Health.* 2016;45(2):122–33.
92. Serpa LF, Santos VL, Peres GR, et al. Validity of the Braden and Water low subscales in predicting pressure ulcer risk in hospitalized patients. *Appl Nurs Res.* 2011b;24:e23–8.
93. Herrera G, León CL, Sepúlveda J, et al. Escalas de valoración del riesgo para úlceras por presión en población pediátrica y neonatal. *Medicina de Postgrado.* 2015;22:20–5.
94. Kottner J, Hauss A, Schlüer AB, et al. Validation and clinical impact of paediatric pressure ulcer risk assessment scales: a systematic review. *Int J Nurs Stud.* 2013;50:807–18.
95. Bora Güneş N, Kiliçarslan TE. Çocuk Hastalarda Braden Q Basiç Ülseri Değerlendirme Ölçeği'nin Türkçe Geçerlilik ve Güvenirliliği [Turkish version of the Braden Q Scale for pressure ulcer risk assessment in pediatric patients]. *J Anatolian Nurs Health Sci.* 2014;17:6–13.
96. Maia ACAR, Pellegrino DMS, Blanes L, et al. Portuguese translation and validation of the Braden Q scale for predicting pressure ulcer risk in pediatric patients. *Rev Paul Pediatr.* 2011;29:405–14.
97. Noonan C, Quigley S, Curley MA. Using the Braden Q Scale to predict pressure ulcer risk in pediatric patients. *J Pediatr Nurs.* 2011;26:566–75.

98. Tume LN, Siner S, Scott E, et al. The prognostic ability of early Braden Q Scores in critically ill children. *Nur Crit Care*. 2013;19:98–103.
99. Lu YF, Yang Y, Wand Y, et al. Predicting pressure ulcer risk with the Braden Q Scale in Chinese pediatric patients in ICU. *Chinese Nurs Res*. 2015;2:1–5.
100. Huffiness B, Logsdon MC. The neonatal skin risk assessment scale for predicting skin breakdown in neonates. *Issues Compr Pediatr Nurs*. 1997;20:103–14.
101. Wu SS, Ahn C, Emmons KR, et al. Pressure ulcers in pediatric patients with spinal cord injury: a review of assessment, prevention, and topical management. *Adv Skin Wound Care*. 2009;22:273–84.
102. Gray M. Which pressure ulcer risk scales are valid and reliable in a pediatric population? *J Wound Ostomy Continence Nurs*. 2004;31:157–60.
103. Lund CH, Osborne JW. Validity and reliability of the neonatal skin condition score. *J Obstet Gynecol Neonatal Nurs*. 2004;33:320–7.
104. McInnes E, Jammali-Blasi A, Bell-Syer SE, et al. Support surfaces for pressure ulcer prevention. *Cochrane Database Syst Rev*. 2011;4:CD001735.
105. Lopes CMM, Haas VJ, Dantas RAS, Oliveira CG, Galvão CM. Assessment scale of risk for surgical positioning injuries. *Rev Latino Am Enfermagem*. 2016;24:e2704. <https://doi.org/10.1590/1518-8345.0644.2704>. [www.eerp.usp.br/rlae](http://www.eerp.usp.br/rlae).
106. Kaewprag P, Newton C, Vermillion B, Hyun S, Huang K, Machiraju R. Predictive models for pressure ulcers from intensive care unit electronic health records using Bayesian networks. *BMC Med Inform Decis Mak*. 2017;17(Suppl 2):65. <https://doi.org/10.1186/s12911-017-0471-z>.
107. Hultin L, Olsson E, Carli C, Gunningberg L. Pressure mapping in elderly care: a tool to increase pressure injury knowledge and awareness among staff. *J Wound Ostomy Continence Nurs*. 2017;44(2):142–7. <https://doi.org/10.1097/WON.0000000000000301>.
108. Miyazaki MY, Caliri MH, dos Santos CB. Knowledge on pressure ulcer prevention among nursing professionals. *Rev Lat Am Enfermagem*. 2010;18:1203–11.
109. Fernandes LM, Caliri MHL, Haas VJ. The effect of educative interventions on the pressure ulcer prevention knowledge of nursing professionals. *Acta Paul Enferm*. 2008;21:305–11.
110. Fletcher J. An overview of pressure ulcer risk assessment tools. *Wounds UK*. 2017;13(1):18–26.



# Health Related Quality of Life (HRQOL) Implications for People with Pressure Ulcers

# 6

Trudie Young, Katia Furtado, and Paulo Alves

## Introduction

There is no doubt whatsoever that pressure ulcers impact heavily on patient morbidity, mortality, and quality of life [1]. Pressure ulcers are a public health problem that causes suffering and decreased quality life for individuals and their caregivers [2, 3]. The results of a systematic review confirm that pressure ulcers significantly affect HRQOL. Pain was identified as a major concern but other pressure ulcer symptoms and interventions, together with healthcare environment all contributed to reducing HRQOL [1]. In relation to healthcare provision the absence of pressure ulcers is considered an indicator of quality care delivery [4, 5].

The concept quality of life is still indefinite, it is associated with an individual's perspective on life satisfaction regardless of the time in life, the location or situation and may change over time. The World Health Organization, Working Group on Quality of Life (WHOQoL), refers to the perception of the individual in relation to their position in life, within the context of culture and systems values that are related to their goals, expectations, standards and concerns. Price and Harding [6], consider that for the majority of individuals with chronic wounds the main focus of treatment is often complete healing, with the aim of achieving the healed state as quickly as

---

T. Young (✉)

Welsh Wound Innovation Centre, Wales, UK

e-mail: [trudie.young@wwic.wales](mailto:trudie.young@wwic.wales)

K. Furtado

Multidisciplinary Wound Care Team in Alentejo Unidade Local de Saúde do Norte Alentejano, Hospital de Portalegre, Portalegre, Portugal

P. Alves

Centre for Interdisciplinary Research in Health (CIIS), Wound Research Lab, Universidade Católica Portuguesa, Porto, Portugal

e-mail: [pjpalves@porto.ucp.pt](mailto:pjpalves@porto.ucp.pt)

possible. However for some individuals healing may not be a realistic expectation, in which case quality of life and symptom management become increasingly important.

## Health Belief Model

There are many theories and subsequent models that attempt to provide an explanation and framework to enlighten health related actions. The Health Belief Model is an example of a theory based on the principle that individual's health related behaviour is influenced by their belief regarding the severity of the illness, which is often stimulated by the onset of disease. The model takes into account the wider issues such as cost and benefit of following a specific course of action involving preventative and treatment pathways and subsequent concordance. The main criticism with the model is that is based upon the premise of rational behaviour rather than on the more subjective elements of human behaviour such as emotional responses to health related situations [7].

## Measurement of HRQOL

The measurement of HRQOL provides an insight into the impact of disease on an individual [8]. There exists a plethora of scales/tools that attempt to measure HRQOL. The tools differ mainly in the content specific to the four domains whilst acknowledging the pillars of emotional, physical, psychological and social well-being. Each domain has indicators that can be assessed e.g. self-esteem, anxiety and depression, physical ability and the ability to function in social roles [7]. According to Price [9], different researchers have developed models of HRQOL based on different domains. For Fallowfield, HRQOL is a multidimensional construct that encompasses four primary domains (variables): psychological; physical; social and role functioning; and issues relating to well-being [10]. Others have proposed up to six domains, while Todd [11] recommended only three domains, physical, social and psychological, sufficient to describe the impact of disease on patients.

HRQOL scales can be generic or disease specific. A common generic scale that has been used to measure HRQOL in tissue viability is the Short Form 36. The Barthel Index although not a HRQOL tool rather it's a measure of functional independence is also used and focusses on the activities of daily living. The generic aspect of these tools can result in a failure to establish if differences exist between individuals with pressure ulcers and those without, therefore using them in combination has been suggested as a way of overcoming this limitation [12, 13].

There has been growing interest and importance placed upon patient reported outcome measures (PROMs) [14]. Gorecki et al. [15] following a systematic review of the literature combined with patient interviews, developed a conceptual framework that populated four HRQOL domains (symptoms, physical functioning,

psychological well-being and social functioning) with 13 pressure ulcer specific sub-domains (pain and discomfort, exudate, odour, mobility daily activities general malaise, sleep, mood, anxiety and worry, self-efficacy and dependence, appearance and self-consciousness, social isolation and participation).

## **The Impact of Pressure Ulceration on the Individual's Quality of Life**

It is often difficult for both healthcare professionals and individuals to establish if it is the pressure ulcer itself or co-morbidities that are having a detrimental effect on an individual's HRQOL [16]. Pressure ulceration is a complication of ill health whether it is acute or chronic disease process. Franks, Winterberg and Moffatt identified 14 co-morbidities in a cohort of 75 patients with pressure ulcers including acute, chronic, and life limiting conditions e.g. fractured neck of femur, chronic heart failure and cancer [13]. A time component can further complicate the ability to tease out the specific effects on HRQOL attributed to pressure damage with acute illness taking precedence over pressure damage whereas the impact of the development pressure ulceration in individuals with chronic conditions caused major impairment and difficulty [8]. The situation is further complicated by elderly individuals who may be confused and cognitively impaired and as such are unable to provide objective information. Whittington [17] found that the majority of people with pressure ulcers were more than 65 years old.

The impact of pressure ulcers on HRQOL is substantial, causing pain and discomfort and affecting sleep, rehabilitation, mobility, and psychological, physical and social aspects of people lives [18–20]. However, pressure ulcers usually develop as a consequence of some other factors which cause restrictions in sleep, mobility and other dimensions, which put the individual at risk of pressure ulcer development. Thus, it is important to gain better understanding of the complex relationship among the various factors that affect HRQOL. In addition, the intensive treatment required for managing pressure ulcers is associated with significant treatment burden, which further impacts HRQOL outcomes [18, 19]. The literature shows that pressure ulcers have a negative impact in all domains of quality of life [21]. The major concerns identified relate to severe and constant pain, and negative impact on physical, psychological and social needs.

Patients often describe constant pain associated with pressure ulcers, which includes pain in general, during dressing change, and when under medical devices for reduction/relief of pressure [18, 21, 22]. Pain was an ever-present feature in the phenomenological study done by Hopkins [16] in patients with pressure ulceration, in which the pain was said to be endless, constant and caused by the treatment and equipment used in the management of pressure ulceration. Health professionals tend to underestimate pain and most of the times the analgesia is insufficient to relieve pain [16, 18, 23]. Some patients don't even complain about their pain and attribute their pain to their age and other co-morbidities. It's a debilitating situation, responsible for physical and social restrictions, namely in performing daily life

activities, participating in social activities and sleeping. Patients tend not to move as they know that movement will cause more pain [16].

Exudate and odour are causes of innumerable problems, such as family and social isolation, pain and physical restrictions. Wound odour is a very distressing symptom and impacts greatly on quality of life, causing feelings of embarrassment and depression [21, 24, 25].

The effects of immobility are significant in people with chronic ulcers [26–28]. Pressure ulcers reduce drastically physical activity, often confining the person to a wheel chair or bed and delay their rehabilitation [15, 18, 29]. Unlike leg ulcers, pressure ulcers result in physical lifestyle changes, adapted living environments, and eventually could lead to hospitalization [15, 18].

A change in body image is clearly a problem for patients with pressure ulceration [18, 21]. The incapacity of maintaining hygiene affects their well-being. It's frequently the sensation of being dirty or smelling, due to the pressure ulcers, which can lead to family and social isolation behaviours. Fox [21] identified that pressure ulceration produced altered and negative body image and fear. This is understandable due to the tissue death and scarring resulting from pressure ulceration. Pressure ulcer interventions cause substantial burden to patients, with consequences including loss of appetite, feeling powerless and other emotional problems such as low mood, hopelessness and anger [18, 30]. Individuals have verbalized a sense of powerlessness and worthlessness [16].

Nurse visits restrict patients' lives and reduce their ability to remain involved in their social activities [16]. Patients report that the physical restrictions imposed by the pressure ulcers and by treatment, including hospitalization, restricted their social life [18, 21].

## **Influence of Pressure Ulcers on Patients, Family and Healthcare Professionals**

Pressure ulcers affect the quality of life not only of the individuals but also of family, carers and associated healthcare professionals. Living with an ulcer brings several changes to people and their families e.g. by restricting the lives of the individuals and that of their carers [16]. This was also highlighted by Baharestani [31], in wives caring for elderly housebound husbands with deep pressure ulcers. The fragility of the wives was evident along with limited social support systems for the carers.

For clinicians, caring for individuals with pressure ulcers, there is no doubt that having such wounds may impact on the individuals' HRQOL. Clinicians generally accept that a pressure ulcer will have some impact on patients' quality of life and may even make assumptions about what it must be like to experience a pressure ulcer. Healthcare providers should be acutely aware of and sensitive to the impact of pressure ulceration on quality of life. Gorecki [8] used semi-structured interviews with individuals with pressure ulcers ( $n = 25$ ) to identify many contributory factors that interplay with HRQOL outcomes that included experience of care received e.g. variations in care, relationships with healthcare professionals.



Individuals have claimed that the language used by nurses to describe their pressure ulcers (they were not able to see the ulcer in certain anatomical locations) as horrific [20]. In addition there is an underestimation by medical and nursing staff of the impact of pressure damage on individuals HRQOL, specifically the amount and impact of the pain associated with the pressure ulceration [16, 19, 20]. For individuals with pressure ulcers the vulnerability, fear and dependency experience is not easily shared with others and is often invisible and overlooked by healthcare professionals. On the other hand there is the paradox that even people with disabilities report that they have a good quality of life [32, 33], contrary to the general perspective of the healthcare professionals who tend to assume that people with disabilities have a low quality of life, regardless of reporting otherwise [34].

Attributing blame can be perceived as part of the social processes used by individuals to understand, cope and live with a condition that is felt to be beyond their control [35]. Spilsbury et al. [20], used qualitative semi-structured interviews with 23 hospital in-patients, the results showed that all participants attributed blame for pressure ulcer development. Three reasons for apportioning blame were identified; some participants directed blame at their chronic condition, poor health, or loss of weight and appetite. Others specifically blamed healthcare professionals for failing to attach priority to their reports of an ulcer or delays in skin inspection; and a small number reported it was the actions of healthcare professionals that caused the ulcer.

Gorecki et al. [18] found that many patients had difficulty in accepting their pressure ulcer, but others developed coping strategies and learned to accept the situation. The comparison with other situation worse than theirs, often led participants to an acceptance of their situation as fatalism [16].

Patients with pressure ulcers are usually very passive about asking justifications related to pressure ulcer intervention [36]. However, patients express desire to be involved in decisions about their wound care and want help from health professionals to become independent [18]. Difficulties often arise when the patient, the family and the healthcare team are not prepared to deal with or understand all of the aspects involved in the problem [37].

In theory aggressive prevention strategies can potentially cause more suffering than benefits. Preventing pressure ulceration in patients who are dying can be impossible due to skin failure [38]. It's important to establish, what is the priority, comfort versus prevention. Nevertheless, there is a need to minimize the negative impact of prevention interventions in the decrease of the quality of life of the patient (24).

## Financial Implications

Pressure ulcers can play an important role in patients' trajectories from illness to full recovery, they are perceived to increase hospital stays, costs and result in dependency associated with on-going treatments [20]. Beside financial costs to

individuals and their families, other indirect costs can be enumerated as time lost from work, forced early retirement and other expenses associated with morbidity and mortality.

## Education

Alves et al. [39] highlight the contribution of healthcare professionals in the prevention of complications and maintenance of pressure ulcer with person's quality of life through prevention strategies and the development of educational strategies for caregivers. The level of education is certainly an important factor in relation to self-care and is sometimes a hindrance for treatment. Edwards [40] questioned if education could influence healing rates and found that patients who had knowledge of pathophysiology of ulcer formation had more commitment in maintaining treatment. These results suggest that health education sessions can promote concordance to treatment and therefore improve HRQOL of patients with chronic wounds. However, success is not always achieved, as not all prevention depends directly on the actions of healthcare professionals; there is the influence of contributing factors such as malnutrition, global deterioration of health and palliation as well as shortages of professionals and prevention material. This leads to demotivation and frustration of informal caregivers as well as healthcare professionals. As even with the implementation of all strategies and the provision of material resources for prevention, pressure ulceration will continue to develop.

## Organisations

Organisations have an important role in education, research and in providing materials for patients that can be adapted for ethnically diverse populations. Pressure ulcer prevention as a quality indicator has driven institutions to promote pressure ulcer prevention. The international consensus [41] on well-being highlighted the importance of organisations in ensuring the well-being of their employees, to enable them to care for the wellbeing of others [37].

---

### Conclusion

HRQOL is a dynamic multifactorial and patient-centered concept which aims to establish the emotional, psychological, physical and social impact of diseases, symptoms, complications and treatments on an individual. A main objective of health care is to improve the quality of life. Assessment of HRQOL is considered subjective in nature due to the personal nature of the experience that can vary over time. HRQOL can be measured by directly asking the person themselves or through the use of patient-reported outcome measures (PROMs), rating scales and pressure ulcer specific HRQOL assessment tools [42, 43].

When comparing individuals with pressure ulcers to those without ulceration, there is evidence of a significant impact of the disease on the physical, social and

psychological aspects of their life. In addition they have to live with the symptoms of the disease, general health problems, care interventions, high rates of depression and a low quality of life [18, 30, 44]. The challenge in these patients is attempting to tease out the factors that are likely to be influenced by the ulceration while acknowledging the broader holistic problems they encounter [45]. Nevertheless, it is possible to improve quality of life of these patients, by adopting best practice and appreciating the individual's perspective and opinion. Education also assumes an important place in improving the quality of life of people with pressure ulcers.

HRQOL data assists clinicians and organisations in determining and subsequently planning to meet individual health needs. Healthcare professionals have a responsibility to assess and manage the impact of pressure damage on the HRQOL of an individual alongside traditional diagnostic and treatment options.

---

## References

1. Agency for Healthcare Research and Quality (AHRQ). Are we ready for this change? Preventing pressure ulcers in hospitals: a toolkit for improving quality of care. Rockville, MD. April 2011. <http://www.ahrq.gov/professionals/systems/long-term-care/resources/pressure-ulcers/pressureulcertoolkit/putool1.html>.
2. Russo CA, Elixhauser A. Hospitalizations related to pressure sores. In Statistical Brief #3. AHRQ Healthcare cost and utilization project. April 2006. [www.hcupus.ahrq.gov/reports/stat-briefs/sb3.pdf](http://www.hcupus.ahrq.gov/reports/stat-briefs/sb3.pdf). Accessed 14 June 2013.
3. Vangilder C, Macfarlane GD, Meyer S. Results of nine international pressure ulcer surveys: 1989 to 2005. *Ostomy Wound Manage.* 2008;54:40–54.
4. Pancorbo-Hidalgo PL, et al. Risk assessment scales 4 pressure ulcer prevention: a systematic review. *J Adv Nurs.* 2006;54:94–110.
5. Elliott J. Strategies to improve the prevention of pressure ulcers. *Nurs Older People.* 2010;22(9):31–6.
6. Price P, Harding K. Cardiff. Wound Impact Schedule: the development of a condition specific questionnaire to assess health-related quality of life in patients with chronic wounds of the lower limb. *Int Wound J.* 2004;1:10–7.
7. Bowling A. *Research methods in health.* 2nd ed. Buckingham: Open University Press; 2002.
8. Gorecki C, et al. What influences the impact of pressure ulcers on health-related quality of life? A qualitative patient-focused exploration of contributory factors. *J Tissue Viability.* 2012;21:3–12.
9. Price P, Harding K. Measuring health-related quality of life in patients with chronic ulcers. *J Wound Care.* 1996;8:91–4.
10. Fallowfield L. *The quality of life: missing dimension in healthcare.* London: Souvenir Books; 1990.
11. Price P. Psychological impact of skin breakdown. In: Flanagan M, editor. *Wound healing and skin integrity.* Chichester: Wiley-Blackwell; 2013. p. 102–16.
12. Clark M. Pressure ulcers and quality of life. *Nurs Stand.* 2002;16:74–78, 80.
13. Franks PJ, Winterberg H, Moffatt CJ. Health-related quality of life and pressure ulceration assessment in patients treated in the community. *Wound Repair Regen.* 2002;10:133–40.
14. Gorecki C, et al. Patient-reported outcome measures for chronic wounds with particular reference to pressure ulcer research: a systematic review. *Int J Nurs Stud.* 2014;51:157–65.
15. Gorecki C, Brown JM, Lamping DL, Nixon J. Development of a patient-reported outcome measure of quality of life for use with patients with pressure ulcers. Pressure ulcers: not just a disease of the elderly—are your patients at risk 2009a. In: TWELFTH annual European Pressure Ulcer Advisory Panel Open Meeting, 2011.

16. Hopkins A, Dealey C, Bale S, Defloor T, Worboys F. Patient stories of living with a pressure ulcer. *J Adv Nurs*. 2006;56:345–53.
17. Whittington K, Patrick M, Roberts JL. A national study of pressure ulcer prevalence and incidence in acute care hospitals. *J Wound Ostomy Continence Nurs*. 2000;27:209–15.
18. Gorecki C, Brown JM, Nelson EA, Briggs M, Schoonhoven L, Dealey C, Defloor T, Nixon J, European Quality of Life Pressure Ulcer Project group. Impact of pressure ulcers on quality of life in older patients: a systematic review. *J Am Geriatr Soc*. 2009b;57:1175–83.
19. Franks PJ. Quality of life as an outcome indicator. In: *A colour guide to the nursing management of chronic wounds*. London: Mosby; 1997.
20. Spilsbury K, Nelson A, Cullum N, Iglesias C, Nixon J, Mason S. Pressure ulcers and their treatment and effects on quality of life: hospital inpatient perspectives. *J Adv Nurs*. 2007;57:494–504. <https://doi.org/10.1111/j.1365-2648.2006.04140.x>.
21. Fox C. Living with a pressure ulcer: a descriptive study of patients' experiences. *Br J Community Nurs*. 2002;7:10, 12, 14, 16.
22. Essex HN, Clark M, Sims J, Warriner A, Cullum N. Health-related quality of life in hospital in patients with pressure ulceration: assessment using generic health-related quality of life measures. *Wound Repair Regen*. 2009;6:797–805.
23. Douglas V. Living with a chronic leg ulcer: an insight into patients' experiences and feelings. *J Wound Care*. 2001;10:355–60.
24. National Pressure Ulcer Advisory Panel and Pan Pacific Pressure Injury Alliance. In: Haesler E, editor. *Prevention and treatment of pressure ulcers: clinical practice guideline*. Osborne Park, WA: Cambridge Media; 2014.
25. Langemo D, Emily H, Wayne N, Aletha T, Young T. Evidence-based guidelines for pressure ulcer management at the end of life. *Int J Palliat Nurs*. 2015;21:225–32.
26. Price P, Butterworth RJ, Bale S, Harding K. Measuring quality of in patients with granulating wounds. *J Wound Care*. 1994;3(1):49–50.
27. Franks P. Quality of life as an outcome indicator. In: *A colour guide to the nursing management of chronic wounds*. London: Mosby; 1998.
28. Mudge E. Meeting report. Tell me if it hurts: the patient's perspective of wound pain. *Wounds UK*. 2007;3:6–7.
29. Gorecki C, Lamping DL, Brown JM, Madill A, Firth J, Nixon J. Development of a conceptual framework of HRQL in pressure ulcers: a patient focused approach. *Int J Nurs Stud*. 2010;47:1525–34.
30. Blanes L, Carmagnani MI, Ferreira LM. Quality of life and self-esteem of persons with paraplegia living in São Paulo, Brazil. *Qual Life Res*. 2009;18:15–21.
31. Bahaarestani M. The lived experience of wives caring for their frail, homebound elderly husbands with pressure ulcers. *Adv Wound Care*. 1994;7:40–52.
32. Albrecht GL, Devlieger PJ. The disability paradox: high quality of life against all odds. *Soc Sci Med*. 1999;48(8):977. [https://doi.org/10.1016/S0277-9536\(98\)00411-0](https://doi.org/10.1016/S0277-9536(98)00411-0).
33. Phillips D. *Quality of life: concept, policy and practice*. London: Routledge; 2006.
34. Hammell W. Exploring quality of life following high spinal cord injury: a review and critique. *Spinal Cord*. 2004;42:491–502.
35. Bury M, Newbould J, Taylor D. A rapid review of the current state of knowledge regarding lay led self-management of chronic illness: evidence review. National Institute for Health and Clinical Excellence; 2005.
36. Hammer C, Cullum NA, Roe BH. Patients' perception of chronic leg ulcers. *J Wound Care*. 1994;3(2):99–101.
37. Lucas LS, Martins JT, Robazzi ML. Quality of life of wound patients in the lower limbs. leg ulcer. *Cienc Enferm*. 2008;14(1):43–52.
38. Naylor WA. A guide to wound management in palliative care. *Int J Palliat Nurs*. 2005;11:572–9.
39. Alves P, Filomena M, Paulo R, Lúcia S. *Epidemiology of pressure ulcers: interpreting Epidemiologic data as quality indicator*. Lisboa: Servir; 2013.
40. Edwards IM, Moffatt C, Franks P. An exploration of patients understanding of leg ulceration. *J Wound Care*. 2002;11(1):35–9.

41. International Society of Lymphology. The diagnosis and treatment of Peripheral lymphedema: 2013 consensus document. *Lymphology*. 2013;46:1–11.
42. Gorecki C, Lamping DL, Nixon J, Brown JM, Cano S. Applying mixed methods to pretest the Pressure Ulcer Quality of Life (PU QOL) instrument. *Qual Life Res*. 2012;21:441–51.
43. Gorecki C, Brown JM, Cano S, Lamping DL, et al. Development and validation of a new patient reported outcome measure for patients with pressure ulcers: the PU QOL instrument. *Health Qual Life Outcomes*. 2013. <https://doi.org/10.1186/1477-7525-11-95>.
44. Luna P, Paulo A. Prevalence risk and pressure ulcer prevention in long-term care units. Dissertation in Evidence and Decision Health. Faculty of Medicine, University of Porto; 2012.
45. Franks PJ, Collier ME. Quality of life: the cost to the individual. In: Morisson M, editor. *The prevention and treatment of pressure ulcers*. London: Harcourt Publishers Limited; 2001. p. 37–45.



# Incontinence-Associated Dermatitis (IAD) and Pressure Ulcers: An Overview

# 7

Dimitri Beeckman

## Introduction

Urinary incontinence is a global health problem affecting 8.2% of the 2008 world population (4.3 billion). By 2018, numbers will increase up to an estimated 423 million individuals being affected with urinary incontinence (21.6% of the population) [1]. Fecal incontinence is also common in men and women aged 65 and older, with a 17% incidence rate over 4 years. Fecal incontinence and urinary incontinence may share common pathophysiologic mechanisms and need regular assessment in older adults [2]. Incontinence is a debilitating disorder (physically, emotionally, socially and psychologically) and has an important impact on quality of life [3]. Not only patients are affected, but also their caring family, relatives and friends, professional caregivers and the society [1, 3].

Together with incontinence, the appearance and function of the skin are altered with aging, resulting in higher rates of skin complaints. One of the most common skin complaints associated with incontinence and ageing is incontinence-associated dermatitis (IAD) [4]. IAD is a type of irritant contact dermatitis that is associated with the prolonged exposure of the skin to urine or faeces [5]. IAD is often associated with skin redness, rash, or vesiculation [6].

There is a small but growing body of evidence that provides insight into the definition, epidemiology, etiology, and pathophysiology of IAD. The past decade has seen a growth in publications focusing on IAD and the differentiation between IAD and pressure ulcers. Today, IAD as a skin disorder seems to be more and more accepted in clinical practice and research worldwide, as indicated by an increasing number of PubMed entries since 2006 [6].

---

D. Beeckman

Department of Public Health, University Centre for Nursing and Midwifery,  
Ghent University, Ghent, Belgium  
e-mail: [Dimitri.Beeckman@UGent.be](mailto:Dimitri.Beeckman@UGent.be)

It is a daily challenge for healthcare professionals in hospitals, nursing homes and the community to maintain a healthy skin in patients with incontinence [7, 8]. Clinicians need to be vigilant both in maintaining optimal skin conditions and in diagnosing and treating minor cases of IAD prior to progression and skin breakdown [9, 10]. Patients with IAD can experience discomfort, pain, burning, itching or tingling in the affected areas. In addition, the development of IAD can result in an undue burden of care, loss of independence, disruption in activities and/or sleep, and reduced quality of life, worsening with frequency and quantity of soiling [11, 12].

---

## Definition and Terminology for Incontinence-Associated Dermatitis

In 2007, IAD was defined by an international expert panel as skin inflammation manifested as redness with or without blistering, erosion, or loss of the skin barrier function that occurs as a consequence of chronic or repeated exposure of the skin to urine or fecal matter [13]. The terminology to describe skin problems associated with incontinence is diverse, and currently more than 18 terms are used in the literature. In the International Statistical Classification of Diseases and Related Health Problems (10th Revision Version for 2007) (ICD-10), the World Health Organization (WHO) classifies incontinence-related skin problems as ‘Diseases of the skin and subcutaneous tissue’ (Chapter XII, L00-L99) in subcategory ‘Dermatitis and eczema’ (L20-L30). The current version of the ICD-10 contains coding for diaper dermatitis but does not contain separate coding for IAD [11, 14].

The term used to classify incontinence-related skin problems used in the Medical Subject Heading Terms database of the US National Library of Medicine (MeSH database) is diaper rash. Diaper rash is defined as a type of irritant dermatitis localized to the area in contact with a diaper and occurring most often as a reaction to prolonged contact with urine, faeces, or retained soap or detergent [15]. As IAD occurs frequently in geriatric care settings, the use of the terms ‘diaper rash’ might not be appropriate for adult persons. In the North American Nursing Diagnosis Association (NANDA), IAD is not mentioned [16].

In international literature, no common terminology is used to indicate the presence of incontinence associated skin problems. The terminology focuses on a description of the skin (e.g. skin maceration), the cause of the irritation (e.g. moisture lesion, incontinence lesion and incontinence dermatitis), the location of the skin problem (e.g. perineal dermatitis) or the material causing the skin problem (e.g. diaper dermatitis) [8, 15].

Currently, IAD is considered a part of a broader group of skin conditions that are referred to as moisture-associated skin damage (MASD) [17]. MASD is used as an umbrella to cover damage of the skin caused by different types of moisture sources, including urine or faeces, perspiration, wound exudate, mucus, and saliva. The most common forms of MASD are IAD, intertriginous dermatitis, periwound moisture-associated dermatitis, and peristomal moisture-associated dermatitis [17]. The term IAD is preferred over the more general term MASD as it distinguishes the skin problem directly with the urine and/or fecal incontinence and not with other conditions (such as perspiration or wound exudate).

## **Etiology and Pathophysiology of Incontinence-Associated Dermatitis**

The etiology of IAD is complex and related to both recurrently chemical and physical irritation of the skin barrier, triggering inflammation and subsequent skin damage [6]. Some studies provide insights into time of IAD onset. Bliss et al. [18] reported that the median time to onset of IAD was 13 days (range 6 to 42 days,  $n = 981$  nursing home residents). In 2011, Arnold-Long et al. [19] reported a time to onset of 13.5 days with a range of 3–25 days. In an intensive care study (2011), Bliss et al. [20] found a median time to onset of IAD of 4 days (range 1–6 days,  $n = 45$  critically ill patients). The development of IAD is attributable to multiple factors having a negative impact on the skin barrier function, including [6, 15, 21]:

- Chemical irritants in incontinence (such as the digestive intestinal enzymes protease and lipase);
- Changes in the skin surface pH;
- Associated microorganisms (such as the *Candida Albicans* causing fungal infections);
- Repeated skin cleansing activities;
- An occlusive perineal environment (due to the use of incontinence pads);
- Mechanical factors such as friction.

The IAD pathophysiology is summarized in Fig. 7.1.

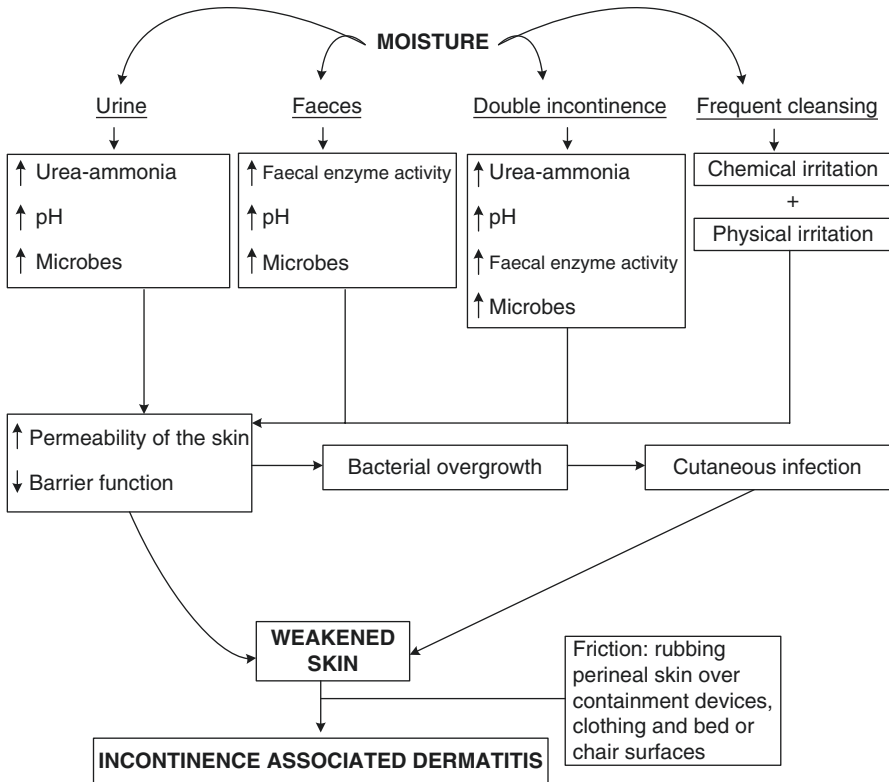
In particular older patients are affected by IAD as the ageing process is associated with a decline of cell replacement in the skin, compromised barrier function and mechanical protection, delayed wound healing, decreased sweat and sebum production, and reduced content of natural moisturizing factors and lipids [4].

### **The Stratum Corneum (SC) and the Barrier Function of the Skin**

The outermost layer of the epidermis, the stratum corneum (SC), is responsible for the biomechanical barrier function of the skin. The SC is continuously renewed and comprises between 15 and 20 layers of flattened skin cells (corneocytes). The number of layers (and so the thickness of the stratum corneum) depends on the skin area [22]. Corneocytes comprise keratinocytes in the epidermis and contain a variety of components, such as proteins, sugars and other substances that together are known as natural moisturising factor (NMF). NMF comprises filaggrin proteolysis and includes water-soluble, hygroscopic molecules that are mainly located in the corneocytes. The NMF supports skin hydration and leads to an effective and flexible barrier [22]. The SC is adversely transformed with age [23, 24]. The main reasons are:

- the keratin filaments within the corneocytes are prone to crosslinking;
- the amount of intercellular lipids decreases resulting in fewer lipid bilayers;
- the rate of corneocytes turnover decreases.





**Fig. 7.1** Etiology of Incontinence-Associated Dermatitis (based on the systematic review by Beeckman and associates [15])

Prolonged exposure to moisture from incontinence leads to SC damage. Hyperhydration of the keratinocytes and disruptions of the intercellular lipid bilayers are caused by excessive skin surface moisture [25, 26]. As a result, the corneocytes swell and the thickness of the SC increases. Furthermore, lipases and proteases from the gastro-intestinal tract (in case of faecal incontinence) attack the SC proteins and lipids.

### The Impact of pH on the Barrier Function of the Skin

The pH plays a fundamental role in the barrier function of the skin, the SC cohesion and in regulating the resident bacteria on the skin [22]. The healthy skin surface is acidic with a pH of 4–6 [27]. An increase of the skin pH will increase swelling of the SC, will cause the skin to be more permeable, will increase the risk of bacterial colonization (and thus cutaneous infections), will alter the lipid rigidity and will reduce the skin barrier function. Furthermore, it increases the activity of lipid processing enzymes, resulting in abnormal lipid processing [27]. Lipolytic (lipid digesting) and proteolytic (protein digesting) enzymes in faeces significantly increase the risk of damaging the SC. Liquid faeces have an even more damaging effect

compared to formed stool as they tend to have significant more digesting enzymes [13]. In the latest expert opinion document by Beeckman et al. [11] the experts concluded that enzymes are even more active in a higher pH environment. This may explain why patients with mixed incontinence (urinary and fecal) may experience more skin problems linked with their incontinence [11].

Excessive skin surface moisture itself (or hyperhydration) does not alter the skin surface pH [28]. However, the chemical process of urease transforms the urea in the urine into ammonium; thus eventually increasing the skin surface pH [29].

---

## **External Factors Increasing the Risk of Incontinence-Associated Dermatitis Development**

A reduced skin barrier function and additional occlusive skin conditions (caused by diapers and/or incontinence pads) may further facilitate the degeneration of the SC infiltration by and other irritants and microorganisms (such as the *Candida Albicans*) [15, 21]. In addition, frequent incontinence episodes (requiring frequent skin cleansing) will lead to the chemical irritation because of the repeated use of water and skin cleansing agents. Furthermore, the use of washcloths for skin washing and towels for drying will to physical irritation [15, 22]. Reduced mobility and limited ability to move independently in bed and chairs causes friction and shear loads in the SC and the epidermis diminishing the strength of the epidermal barrier further [22].

---

## **Prevalence and Incidence of Incontinence-Associated Dermatitis**

Prevalence and incidence figures for IAD that are internationally comparable are missing. The prevalence varies between 5.6 and 50%, and incidence between 3.4 and 25% [14]. In many countries, the precise number of patients affected by IAD is even unknown. The lack of an ICD-10 coding for IAD an internationally validated and standardized method for IAD data collection contribute to the wide variation in prevalence and incidence figures [11]. Besides, variation is caused by the complexity of recognising the condition and distinguishing it from other skin lesions (such as superficial pressure ulcers) [30–32]. This finding clearly indicates that a standardisation in outcome definition and methods in epidemiological and clinical IAD research is urgently needed.

---

## **Risk Assessment and Risk Factors for Incontinence-Associated Dermatitis**

Comparable to the domain of pressure ulcers, researchers attempted to develop tools to assess the risk of patients to develop IAD [33, 34]. Different from pressure ulcer risk assessment tools (such as the Braden, Waterlow, Norton tool), IAD assessment tools are not widely used by clinicians. In the expert opinion document (2015) [11], the panel of experts does not recommend the use of a separate risk

assessment tool for IAD; although awareness of key risk factors for IAD is needed. Besides, the panel pointed out that the previously mentioned pressure ulcer risk assessment tools are not designed for IAD, nor do they adequately predict risk of IAD development [11].

Essentially, all patients with urinary and/or fecal incontinence are at risk of developing IAD. Besides, following additional factors will increase the risk of IAD development in incontinent patients: frequent episodes of incontinence (especially faecal), the use of occlusive containment products, poor skin condition (e.g. due to aging/steroid use/diabetes), reduced mobility, diminished cognitive awareness, inability to perform personal hygiene, pain, increased body temperature (pyrexia), certain medications (antibiotics, immunosuppressant), poor nutritional status, and critical illness. Although increased age is associated with higher prevalence of incontinence, age does not appear to be an independent risk factor for IAD [8, 22]. More research is needed in this domain.

---

## Observation of Incontinence-Associated Dermatitis

The diagnosis of IAD is based on visual inspection of the perineal and perigenital skin. Typical locations for IAD to occur are the perianal and sacrococcygeal areas, the thighs and the buttocks [14]. IAD only occurs in skin areas being exposed to urine and/or faeces [11, 14]. If similar skin damage occurs in areas that not have been exposed to urine or faeces, another type of MASD should be considered (intertriginous dermatitis, periwound moisture-associated dermatitis, and peristomal moisture-associated dermatitis).

In patients with light skin tones, early signs of IAD are erythema (ranging from pink to red) and a whitened appearance and slight swelling of the surrounding skin (indicating maceration). Evidence points out that the appearance of erythema is strongly associated with skin maceration in older incontinent patients [22, 35]. In patients with darker skin tones, the skin looks paler, darker, purple, dark red or yellow.

In both patients groups (light skin tones and darker skin tones), the affected area has poorly demarcated edges and may be patchy or continuous over large areas. Because of the underlying inflammation, areas of IAD where skin is intact may feel warmer and firmer than surrounding unaffected skin. Lesions including vesicles or bullae, papules or pustules may be observed. The epidermis may be damaged to varying depths; in some cases the entire epidermis may be eroded exposing moist, weeping dermis [8, 11, 14] (See Fig. 7.2).

An inflamed and eroded skin has a high risk for secondary infection [6]. *Candida Albicans* is the most frequent fungal infection in geriatric IAD patients [6]. In 2007, Junkin and Selekof [21] found that 18% of 198 hospitalized patients with urinary, fecal or double urinary and fecal incontinence had evidence of IAD with secondary cutaneous candidiasis based on visual inspection. Clinical signs are punctuate pustules and satellite lesions spreading around the IAD area. Bacterial infections may also occur in the course of IAD. In 2014, Campbell and Coyer [36] found that 32% of patients with IAD had a rash indicative of a fungal infection.

IAD observation is complex and different stages of severity are described [14, 22]. IAD severity can range from intact skin (with different levels of erythema),

**Fig. 7.2** IAD Category 2 with poorly demarcated edges over a large area with clear signs of inflammation. The epidermis is damaged to varying depths; in some areas the entire epidermis is eroded exposing moist, weeping dermis. (Photo courtesy of D. Beeckman)



maceration and swelling, disappearance of the skin structure and erosions, eventually leading to cutaneous wounds.

A study in 2015 pointed out that pain is an essential characteristic of IAD, especially occurring during skin cleansing activities [12]. Pain can range from tingling, over itching and burning [12]. During the last years, a series of IAD classification tools and scores have been published and tested regarding psychometric properties. In 2015, Clarke-O'Neill et al. [37] concluded that the existing IAD instruments are too time-consuming and linguistically complex for use in routine clinical practice in nursing homes. The research also concluded that observation with an instrument could be improved by adding reference photographs of skin illustrating the categories. In 2015 a simplified classification system consisting of three categories supported by photographs (including being “at risk”) was proposed:

- **Category 0** = No redness and skin intact (at risk): Skin is normal as compared to rest of body (no signs of IAD)
- **Category 1** = Red but skin intact (mild)—edema can be present
- **Category 2** = Red with skin breakdown (moderate-severe)—edema, vesicles/bullae/skin erosion, denudation of skin, skin infection can be present

Such a classification may be useful for documentation, clinical decision making and research purposes [6, 11]. However, further validation studies are needed before this tool can be introduced in practice.

---

## Incontinence-Associated Dermatitis and Pressure Ulcers

### Association Between IAD and Pressure Ulcers

Clinicians often experience difficulties to correctly identify IAD and to distinguish it from pressure ulcers (mainly erythema or up to the level of partial thickness skin loss) and other (moisture related) skin conditions [8, 38]. In healthcare systems where pressure ulcer occurrence is used to assess the quality of care and is linked with reimbursement and litigation, misdiagnosis of IAD as a pressure ulcer has potentially serious

implications [11, 39]. From a clinical point of view, we know that IAD frequently occurs in the absence of any causal factor for pressure ulcer development (pressure/shearing forces on the skin and the underlying soft tissue) and that babies are frequently affected with irritant diaper dermatitis (similar pathophysiological process for IAD) when their skin is exposed to prolonged wetness. The international guidelines for pressure ulcer prevention and treatment in 2014 [39] and the IAD best practice document in 2015 [11] underline the need to correctly diagnose pressure ulcers and to differentiate them from other skin lesions which occur in the same areas on the skin. Even though the clinical presentation of partial thickness pressure ulcers and IAD is similar, the underlying etiologic factors differ.

Pressure ulcers are localized injuries to the skin and/or underlying tissue, usually over a bony prominence due to the impact of mechanical forces (pressure and shear) [39]. Pressure ulcers can be divided in four categories: non-blanchable erythema (cat. I), partial thickness skin loss (cat. II), full thickness skin loss (cat. III) and full thickness tissue loss (cat. IV). IAD and pressure ulcers have different etiologies but may co-exist: IAD is a ‘top down’ injury, i.e. damage is initiated on the surface of the skin, while pressure ulcers are believed to be ‘bottom up’ injuries, where damage is initiated by changes within soft tissues below and within the skin. The pathophysiological and histopathological differences between IAD and pressure ulcers are largely understudied. Only in 2007, Houwing and colleagues [40] performed 14 skin biopsies and concluded that an ischemic and irritation pattern emerged, in both pressure ulcers and IAD. However, the pattern of irritation appeared to be more associated with lesions that clinically fitted the description of IAD. Based on this small-scale study, the researchers concluded that there was no justification for the introduction of an (at that time) new diagnostic entity such as IAD. In a recent systematic review and meta-analysis by Beeckman et al. [4] incontinence and IAD were found to be risk factors for pressure ulcer development.

Luboz et al. [41] relate this association between prolonged exposure to skin surface moisture and irritants to changes of the mechanical skin properties of the skin and underlying tissue. They link the associated risk for pressure ulcer development with the increase of the coefficient of friction and tissue stiffness changes. Additionally, local inflammation will increase the temperature of the skin leading to further diminishing of the cutaneous resistance against tissue deformation. On the other hand, we know that category I and partial thickness skin lesions will increase the susceptibility for IAD development [6]. Research points out that determining if the inflammation of the skin in the buttock and sacral areas is primarily due to pressure or irritation is difficult and confusing [8].

## **Differentiation Between IAD and Pressure Ulcers**

Multiple studies showed that pressure ulcer classification is difficult [8, 14] and that misclassification between pressure ulcers and incontinence associated dermatitis (IAD) frequently occurs [11, 42]. As previously mentioned, the differential diagnosis between pressure ulcers and IAD is mainly based on visual examination. Misclassification has significant implications for prevention, treatment, and for

**Table 7.1** Synthesis of the EPUAP position statement on pressure ulcer classification and IAD differentiation

	Pressure ulcer	Incontinence-associated dermatitis (IAD)
Cause	Pressure and/or shear must be present	Moisture must be present (e.g. shining, wet skin caused by urinary incontinence or diarrhoea)
Location	A wound over a bony prominence is likely to be a pressure ulcer	IAD may occur over a bony prominence. However, pressure and shear should be excluded as causes, and moisture should be present
Shape	If the lesion is limited to one spot, it is likely to be a pressure ulcer	Diffuse, different superficial spots are more likely to be IAD
Depth	Partial thickness skin loss and full thickness skin loss	Superficial (partial thickness skin loss)
Necrosis	A black necrotic scab on a bony prominence is a pressure ulcer grade 3 or 4. If there is no or limited muscular mass underlying the necrosis, the lesion is a pressure ulcer grade 4	No necrosis
Edges	Distinct edges	Diffuse or irregular edges
Colour	If redness is non-blanchable, this is most likely a pressure ulcer grade 1	Blanchable or non blanchable erythema Pink or white surrounding skin due to maceration

reporting and benchmarking on quality of care. Classification skills are likely to benefit from education [38]. In 2005, Defloor and colleagues [42] published the EPUAP statement on the differentiation between pressure ulcers and IAD. In this statement, wound-related characteristics (causes, location, shape, depth, edges, and colour) and patient-related characteristics were defined to clarify the difference between a pressure ulcer and IAD. Based on this statement, an international working group of experts developed and tested the e-learning PuClas education tool (<http://www.puclas.ugent.be/puclas/>), a world-wide used tool to learn and teach about pressure ulcer classification, translated in many languages. Currently a revised version of the tool (PuClas3, <http://puclas3.ucvvgent.be/>) is published and online available [43]. A summary of the PuClas guideline is provided in Table 7.1.

## Management of Incontinence-Associated Dermatitis

Management (prevention and treatment) of IAD is a significant challenge for healthcare professionals. Delivering care that is based on state-of-the-art research is hampered by the absence of an internationally and inter-professionally accepted terminology, a standardized definition, high quality studies and national and international guidelines [6].

Both the prevention and treatment of IAD include the removal of occlusive conditions, gentle skin cleansing, skin protection (e.g. “barrier products”), and the

application of therapeutic ointments like dexpanthenol, zinc, or antimycotics [6]. Although the number of studies about prevention and treatment of IAD is increasing, the current evidence is still limited [44]. One reason is the use of many different and sometimes ill-defined outcome parameters in clinical studies [11]. As previously mentioned, reviews identified different operational definitions of IAD, the use of various clinical severity scales with varying numbers of categories, different biophysical skin barrier and appearance parameters (e.g. erythema, transepidermal-water loss, skin surface pH), bacterial loads to name but a few [15, 45, 46]. Skin surface interleukin levels, stratum corneum hydration, or skin surface roughness are other parameters recently used to characterize diapered skin and to measure intervention effects in infants and adults. Furthermore there are more than six published clinical scores to measure the risk and/or the severity of IAD [8] but their usefulness as outcomes in clinical research is unexplored so far.

Prevention of IAD includes three strategies:

- skin cleansing to remove dirt, debris and microorganisms;
- skin moisturization to repair or augment the skin's barrier, retain and/or increase its water content, reduce transepidermal water loss and restore or improve the intercellular lipid structure; and
- the application of a skin barrier product to prevent skin breakdown by providing an impermeable or semi-permeable barrier on the skin.

Recent studies and expert opinions recommend the application of a skin barrier product as an essential element of skin care to prevent or treat IAD. A wide range of creams, ointments, pastes, lotions and films is available as well as different skin barrier formulations such as petrolatum-based, dimethicone-based, zinc oxide-based, or liquid film-forming acrylate. The terminology used to describe the properties of products is not standardized. Despite their widespread use, little is known about the efficacy and effectiveness of products from well-designed randomized controlled clinical trials. A number of studies compared the use and effect of different types of skin regimens, but study design weaknesses are common.

Barrier products are necessary to protect the skin of patients who suffer urinary and fecal incontinence [6]. The presence of high moisture and corrosive enzymes from intestinal fluids can lead to devastating breakdown of the skin leading to denuding and erosion of the skin [14]. Current products which are used to protect the skin from these challenges include occlusive barrier ointments, creams, pastes, polymeric film formers and cyanoacrylates. Determining the relative performance of these barrier materials is difficult for clinicians and is generally anecdotal [11]. A wide variety of products and formulas with both moisturizing and barrier capacity exists. Skin protectants probably vary in the magnitude of protection from exposure to irritants, but we have inadequate evidence to rank these products based on their barrier function while preventing maceration of underlying skin [8]. In addition, we have inadequate evidence to determine the effect of the concentration of active ingredients [8, 14]. For example, dimethicone is classified as a non-occlusive emollient and skin protectant, but some products contain 1% dimethicone, while others

contain 3% or 5% dimethicone. Because of these deficits in knowledge and clinical evidence, it is not surprising that product selection remains a challenge for clinicians when preventing and managing IAD.

Evidence on the effectiveness alone of skin care regimens to prevent or treat IAD are yet insufficient for policy making. Health care budgets are limited, hence policy makers are facing the problem how to set priorities in the allocation of health care resources to different treatment options. Knowledge on this can be obtained by performing economic evaluations of health care interventions providing payers and regulatory bodies with better insights how to establish priorities within cost-constrained health care budgets. To date, there are limited cost-effectiveness studies with regard to IAD.

---

### Conclusion

To conclude, managing IAD can correctly be described as an important challenge for clinical practice and research. Too many patients suffer from it, and still too little effort is done to improve outcomes in these patients. Problems are mainly related to accurate observation, differentiation, and appropriate management. Significant efforts, mainly in terms of education, are made to improve the differentiation between IAD and pressure ulcers. However, these efforts are mainly locally organised and they vary in term of intensity between organisations. A more general awareness about the association between IAD and pressure ulcers is needed. Tissue viability experts and incontinence specialists must play a leading role in developing this area.

---

### References

1. Irwin DE, Kopp ZS, Agatep B, Milsom I, Abrams P. Worldwide prevalence estimates of lower urinary tract symptoms, overactive bladder, urinary incontinence and bladder outlet obstruction. *BJU Int.* 2011;108(7):1132–8.
2. Markland AD, Goode PS, Burgio KL, Redden DT, Richter HE, Sawyer P, Allman RM. Incidence and risk factors for fecal incontinence in black and white older adults: a population-based study. *J Am Geriatr Soc.* 2010;58(7):1341–6.
3. Meyer I, Richter HE. Impact of fecal incontinence and its treatment on quality of life in women. *Women's Health (Lond Engl).* 2015;11(2):225–38.
4. Beekman D, Van Lancker A, Van Hecke A, Verhaeghe S. A systematic review and meta-analysis of incontinence-associated dermatitis, incontinence, and moisture as risk factors for pressure ulcer development. *Res Nurs Health.* 2014;37(3):204–18.
5. Kottner J, Beekman D. Incontinence-associated dermatitis and pressure ulcers in geriatric patients. *G Ital Dermatol Venereol.* 2015;150(6):717–29; [Epub ahead of print].
6. Gray M, Beekman D, Bliss DZ, Fader M, Logan S, Junkin J, Selekof J, Doughty D, Kurz P. Incontinence-associated dermatitis: a comprehensive review and update. *J Wound Ostomy Continence Nurs.* 2012;39(1):61–74.
7. Beekman D, Woodward S, Rajpaul K, Vanderwee K. Clinical challenges of preventing incontinence-associated dermatitis. *Br J Nurs.* 2011;20(13):784–6, 788, 790.
8. Doughty D, Junkin J, Kurz P, Selekof J, Gray M, Fader M, Bliss DZ, Beekman D, Logan S. Incontinence-associated dermatitis: consensus statements, evidence-based guidelines for prevention and treatment, and current challenges. *J Wound Ostomy Continence Nurs.* 2012;39(3):303–15; quiz 316-7.



9. Hall KD, Clark RC. A prospective, descriptive, quality improvement study to decrease incontinence-associated dermatitis and hospital-acquired pressure ulcers. *Ostomy Wound Manage.* 2015;61(7):26–30.
10. Jacobson TM, Wright T. Improving quality by taking aim at incontinence-associated dermatitis in hospitalized adults. *Medsurg Nurs.* 2015;24(3):151–7.
11. Beeckman D, et al. Proceedings of the global IAD expert panel. Incontinence-associated dermatitis: moving prevention forward. *Wounds Int.* 2015. [www.woundsinternational.com](http://www.woundsinternational.com)
12. Van Damme N, Vanryckeghem E, Verhaeghe S, Beeckman D. Incontinence-associated dermatitis in elderly: a qualitative phenomenological study on patient experiences. Paper presented at the 18th Annual Conference of the European Pressure Ulcer Advisory Panel, Ghent, Belgium.
13. Gray M, Bliss DZ, Doughty DB, Ermer-Seltun J, Kennedy-Evans KL, Palmer MH. Incontinence-associated dermatitis: a consensus. *J Wound Ostomy Continence Nurs.* 2007;34(1):45–54; quiz 5-6.
14. Gray M, Black JM, Baharestani MM, Bliss DZ, Colwell JC, Goldberg M, Kennedy-Evans KL, Logan S, Ratliff CR. Moisture-associated skin damage: overview and pathophysiology. *J Wound Ostomy Continence Nurs.* 2011;38(3):233–41.
15. Beeckman D, Schoonhoven L, Verhaeghe S, Heyneman A, Defloor T. Prevention and treatment of incontinence-associated dermatitis: literature review. *J Adv Nurs.* 2009;65(6):1141–54.
16. North American Nursing Diagnosis Association (NANDA). *Nursing diagnoses: definitions and classification, 2007–2008.* North American Nursing Diagnosis Association, Philadelphia, PA; 2008. <http://www.nanda.org/>. Accessed 12 Aug 2015.
17. Black JM, Gray M, Bliss DZ, Kennedy-Evans KL, Logan S, Baharestani MM, Colwell JC, Goldberg M, Ratliff CR. MASD part 2: incontinence-associated dermatitis and intertriginous dermatitis: a consensus. *J Wound Ostomy Continence Nurs.* 2011;38(4):359–70; quiz 371-2.
18. Bliss DZ, Zehrer C, Savik K, Smith G, Hedblom E. An economic evaluation of four skin damage prevention regimens in nursing home residents with incontinence: economics of skin damage prevention. *J Wound Ostomy Cont Nurs.* 2007;34(2):143–52.
19. Arnold-Long M, Reed L. Incontinence associated dermatitis in a long-term acute care facility: findings from a 12 week prospective study. *J Wound Ostomy Continence Nurs.* 2011;38(Supplement):S7. (Abstract).
20. Bliss DZ, Savik K, Thorson MAL, Ehman SJ, Lebak K, Beilman G. Incontinence associated dermatitis in critically ill adults. *J Wound Ostomy Continence Nurs.* 2011;38(4):1–13.
21. Junkin J, Selekof JL. Prevalence of incontinence and associated skin injury in the acute care inpatient. *J Wound Ostomy Continence Nurs.* 2007;34(3):260–9.
22. Kottner J, Ludriksone L, Garcia Bartels N, Blume-Peytavi U. Do repeated skin barrier measurements influence each other's results? An explorative study. *Skin Pharmacol Physiol.* 2014;27(2):90–6.
23. Crowther JM, Sieg A, Blenkinsop P, Marcott C, Matts PJ, Kaczvinsky JR, Rawlings AV. Measuring the effects of topical moisturizers on changes in stratum corneum thickness, water gradients and hydration in vivo. *Br J Dermatol.* 2008;159(3):567–77.
24. Biniek K, Kaczvinsky J, Matts P, Dauskardt RH. Understanding age-induced alterations to the biomechanical barrier function of human stratum corneum. *J Dermatol Sci.* 2015;80(2):94–101. <https://doi.org/10.1016/j.jdermsci.2015.07.016>.
25. Bouwstra JA, de Graaff A, Gooris GS, Nijssse J, Wiechers JW, van Aelst AC. Water distribution and related morphology in human stratum corneum at different hydration levels. *J Invest Dermatol.* 2003;120(5):750–8.
26. Warner RR, Stone KJ, Boissy YL. Hydration disrupts human stratum corneum ultrastructure. *J Invest Dermatol.* 2003;120(2):275–84.
27. Choi EH, Man MQ, Xu P, Xin S, Liu Z, Crumrine DA, Jiang YJ, Fluhr JW, Feingold KR, Elias PM, Mauro TM. Stratum corneum acidification is impaired in moderately aged human and murine skin. *J Invest Dermatol.* 2007;127(12):2847–56.
28. Minematsu T, Yamamoto Y, Nagase T, Naito A, Takehara K, Iizaka S, et al. Aging enhances maceration-induced ultrastructural alteration of the epidermis and impairment of skin barrier function. *J Dermatol Sci.* 2011;62(3):160–8. Epub 2011/04/19. eng

29. Hachem JP, Crumrine D, Fluhr J, Brown BE, Feingold KR, Elias PM. pH directly regulates epidermal permeability barrier homeostasis, and stratum corneum integrity/cohesion. *J Invest Dermatol*. 2003;121(2):345–53.
30. Defloor T, Schoonhoven L. Inter-rater reliability of the EPUAP pressure ulcer classification system using photographs. *J Clin Nurs*. 2004;13(8):952–9.
31. Vanderwee K, Defloor T, Beecckman D, Demarré L, Verhaeghe S, Van Durme T, Gobert M. Assessing the adequacy of pressure ulcer prevention in hospitals: a nationwide prevalence survey. *BMJ Qual Saf*. 2011;20(3):260–7.
32. Beecckman D, Schoonhoven L, Fletcher J, Furtado K, Gunningberg L, Heyman H, Lindholm C, Paquay L, Verdú J, Defloor T. EPUAP classification system for pressure ulcers: European reliability study. *J Adv Nurs*. 2007;60(6):682–91.
33. Storer-Brown D. Perineal dermatitis: can we measure it? *Ostomy Wound Manage*. 1993;39(7):8–32.
34. Nix DH. Validity and reliability of the perineal assessment tool. *Ostomy Wound Manage*. 2002;48(2):43–9.
35. Ichikawa-Shigeta Y, Sugama J, Sanada H, Nakatani T, Konya C, Nakagami G, et al. Physiological and appearance characteristics of skin maceration in elderly women with incontinence. *J Wound Care*. 2014;23(1):18–9, 22–3, 6 passim.
36. Campbell JL, Coyer FM, Osborne SR. Incontinence-associated dermatitis: a cross-sectional prevalence study in the Australian acute care hospital setting. *Int Wound J*. 2014;3(3):403–11. <https://doi.org/10.1111/iwj.12322>.
37. Clarke-O'Neill S, Farbroth A, Lagerstedt Eidrup ML, Cottenden A, Fader M. Is it feasible to use incontinence-associated dermatitis assessment tools in routine clinical practice in the long-term care setting? *J Wound Ostomy Continence Nurs*. 2015;42(4):379–88.
38. Beecckman D, Schoonhoven L, Fletcher J, Furtado K, Heyman H, Paquay L, De Bacquer D, Defloor T. Pressure ulcers and incontinence-associated dermatitis: effectiveness of the pressure ulcer classification education tool on classification by nurses. *Qual Saf Health Care*. 2010;19(5):e3.
39. National Pressure Ulcer Advisory Panel, European Pressure Ulcer Advisory Panel and Pan Pacific Pressure Injury Alliance. In: Haesler E, editor. *Prevention and treatment of pressure ulcers: quick reference guide*. Osborne Park, WA: Cambridge Media; 2014.
40. Houwing RH, Arends JW, Canninga-van Dijk MR, Koopman E, Haalboom JR. Is the distinction between superficial pressure ulcers and moisture lesions justifiable? A clinical-pathologic study. *Skinmed*. 2007;6(3):113–7.
41. Luboz V, Perrier A, Bucki M, Diot B, Cannard F, Vuillermé N, et al. Influence of the calcaneus shape on the risk of posterior heel ulcer using 3D patient-specific biomechanical modeling. *Ann Biomed Eng*. 2015;43(2):325–35.
42. Defloor T, Schoonhoven L, Fletcher J, Furtado K, Heyman H, Lubbers M, Witherow A, Bale S, Bellingeri A, Cherry G, Clark M, Colin D, Dassen T, Dealey C, Gulacsi L, Haalboom J, Halfens R, Hietanen H, Lindholm C, Moore Z, Romanelli M, Soriano JV, Trustees of the European Pressure Ulcer Advisory Panel. Statement of the European Pressure Ulcer Advisory Panel—pressure ulcer classification: differentiation between pressure ulcers and moisture lesions. *J Wound Ostomy Continence Nurs*. 2005;32(5):302–6; discussion 306.
43. Beecckman D, Schoonhoven L. European Pressure Ulcer Advisory Panel. PuClas3 eLearning Module. University Centre for Nursing and Midwifery and European Pressure Ulcer Advisory Panel, 2015. <http://puclas3.ucvvgent.be/>.
44. Beecckman D, Van Damme N, Schoonhoven L, Van Lancker A, Kottner J, Beele H, Gray M, Woodward S, Fader M, Van den Bussche K, Van Hecke A, Verhaeghe S. Interventions for preventing and treating incontinence-associated dermatitis in adults. *Cochrane Database Syst Rev*. 2015;(4):CD011627. <https://doi.org/10.1002/14651858.CD011627>.
45. Hodgkinson B, Nay R. Effectiveness of topical skin care provided in aged care facilities. *Int J Evid Based Healthc*. 2005;3(4):65–101.
46. Kottner J, Lichterfeld A, Blume-Peytavi U. Maintaining skin integrity in the aged: a systematic review. *Br J Dermatol*. 2013;169(3):528–42.



# Microclimate: Rediscovering an Old Concept in the Aetiology of Pressure Ulcers

8

Michael Clark

---

## Introduction

The ‘state of the art’ in our understanding of the aetiology of pressure ulcers has been described in both editions of the International Pressure Ulcer guidelines [1, 2] in part produced by the European Pressure Ulcer Advisory Panel (EPUAP). However one key difference between these texts separated only by 5 years, is the inclusion of discussion upon the role of microclimate changes in the recent guidelines [2] that were not present in the earlier report of pressure ulcer aetiology [1].

The concept of microclimate is typically considered to reflect the combination of temperature and humidity or moisture acting at the skin surface at the body-support surface interface [3] and has emerged in the past five years as a new area for exploration when considering pressure ulcer development. However understanding that changes in skin temperature or humidity might influence pressure ulcer development are not new ideas, but rather reflect the rediscovery of views on pressure ulcer aetiology held thirty years ago. In the foreword to the proceedings of the first pressure ulcer conference to be held in the United Kingdom, Roaf [4] commented that ‘we know how to avoid bed sores and tissue necrosis—maintain the circulation, avoid long continued pressure, abrasions, extremes of heat and cold, maintain a favourable microclimate, avoid irritating fluids and infection. The problem is the logistics of this programme.’ So from the beginning of pressure ulcer activity in the UK microclimate and microclimate changes were seen as being a key part of successful pressure ulcer prevention. However by the mid 1980’s there was a considerable increase in the availability of specialist pressure-redistributing beds, mattresses and (to a lesser extent) seat cushions [5] and focus shifted from microclimate management to the quantification of the pressures applied to the skin by various support surfaces (for

---

M. Clark  
Welsh Wound Innovation Centre, Rhondda Cynon Taf, Wales, UK

example [6–10]). It has only been in the past five years that microclimate management has re-emerged perhaps partly due to new support surface cover materials and also growing clinical interest in understanding pressure ulcer development [3, 11].

## Why Should Skin Temperature and Humidity Influence Pressure Ulcer Development?

Endotherms can maintain body temperature at a minimal metabolic rate across a range of ambient temperatures, the thermal neutral zone (TNZ) [12]. As ambient temperatures approach the lower and upper boundaries of the TNZ metabolic rate must increase to maintain a constant core temperature. Metabolic rate will also rise as core temperature increases with a 1 °C rise in core temperature causing a 10–13% increases in oxygen consumption [13]. So at extremes of ambient temperature and where core temperature rises the demand for oxygen is increased and this increased demand may not be met where skin and soft tissues are loaded so reducing local blood and oxygen supply.

Extremes of moisture or dryness at the skin surface can also be anticipated to produce changes in the skin. High levels of skin wetness (be this from perspiration, incontinence, wound exudate) can reduce dermal collagen cross-linkage so weakening the stratum corneum [14] similar effects can be seen where relative humidity is high with a 25 fold decrease in stratum corneum strength at 100% relative humidity compared with its strength in a 50% relative humidity environment [15]. Excess moisture also changes the skin's coefficient of friction [16] making superficial damage through abrasion more likely. Dry skin also presents clinical challenges [3] with reduced lipid levels in dry skin along with less water content and weakened junctions between the epidermis and the dermis.

Interactions between skin temperature and humidity can also be observed that may induce deleterious changes in skin and soft tissue. For example reduced relative humidity may lead to increased sweat evaporation so reducing skin temperature while delamination of the stratum corneum increases with increasing temperature and humidity [17].

From human physiology through to tissue sample studies there are a range of potential modes of action through which changes in the local microenvironment of loaded skin and soft tissues may accelerate or prompt tissue damage leading to early forms of pressure injury. Gefen [18] modeled the likely interactions between microclimate, pressure and the development of superficial pressure damage. In this model five associations were proposed—that superficial pressure damage was more likely to occur where;

- As skin temperature increased
- As ambient temperature increased
- As relative humidity increased
- As pressure upon the skin increased, and
- As the permeability of bed sheet/clothing decreased.

While the potential modes of action where microclimate changes may impact on tissue viability appear both reasonable and valid, is there clinical evidence associating both microclimate changes and management with the occurrence of current pressure ulcers and the prediction of future pressure injuries?

## Skin Temperature and Pressure Ulcers

From the late 1970s regional variations in skin surface temperature were assessed both to identify areas of potential pressure injury and to assess the likely healing of established full-thickness pressure ulcers (for example [19–21]). Newman and Davis [20] reported the development of pressure ulcers (category II and above) at the sacrum of ninety-one elderly hospital in-patients admitted with no visible sacral pressure damage. Of the 91 patients, 19% (n = 17) had unusual thermal patterns at the sacrum where 11 showed a warm area surrounded by a thermal gradient of less than 1 °C/cm while six thermal anomalies were associated with creasing of the skin at the sacrum. Five of the 11 patients with diffuse warm areas developed pressure ulcers (severity unreported) while a further patient with a crease in the sacral skin also developed a pressure ulcer within ten days of admission to hospital. These six pressure ulcers were reported to have developed either exactly where the thermal anomaly was located (n = 4) or adjacent to the anomaly (n = 2). No other subject in this early study developed pressure ulceration. In common with many early reports of pressure ulcer studies no information was provided upon the pressure ulcer preventive care allocated to the study participants. Norton scores [22] were reported by Newman and Davis with the majority 53/91 reported to have a Norton score higher than 14 upon admission suggesting a ‘low risk’ patient population for pressure ulcer development. The sensitivity and specificity of the use of thermography and the Norton score to predict risk of pressure ulcer development in this study were similar (thermography sensitivity 100%, specificity 39.3%; Norton scale sensitivity 83%, specificity 36.1%) however the thermal images required the elderly patients to lie with their sacrum and buttocks exposed for around 30 min potentially creating a poor experience of the first part of their stay in hospital! This early work by Newman and Davis suggested that the temperature of intact skin could form the basis for pressure ulcer prediction especially where the thermal anomaly suggested damage deep within the soft tissues (diffuse warm spot at the skin surface) however the technique appeared no better than standard pressure ulcer risk assessment and was likely to lead to a loss of dignity for the patient being assessed for thermal anomalies.

Sprigle and colleagues [23] reported upon skin temperature changes at anatomical sites prone to pressure ulceration in 65 predominantly non-ambulatory in- and out- patients within an acute rehabilitation hospital. All sixty-five participants had persistent erythema at the bony landmark and the skin temperature at the area of erythema was compared with the temperature at adjacent areas where no erythema was visible. Skin temperature was considered to be similar across the two measurement sites if the difference was below 1 °F. Across the 65 participants eighty skin

sites with erythema and adjacent control locations were measured with the skin temperature similar in 12 cases, cooler in 18 and warmer in 50. This indicates that skin temperature changes are likely to be found between areas of erythema and the surrounding skin but that erythematous areas may be warmer or cooler than the surrounding skin and that areas of early pressure damage may remain at a similar temperature to surrounding non-damaged skin. These results are ambiguous in terms of clarifying the value of using skin temperature to discriminate between areas of erythema and apparently 'normal' skin.

Clark [24] followed a cohort of 52 elderly people newly admitted to hospital with no visible pressure damage at the sacrum for 14 days during their hospital stay. Skin temperature at the interface between the sacrum and bed mattress was recorded upon admission and after 14 days six patients (11.5%) developed superficial pressure damage at the sacrum. Where pressure ulceration occurred the temperature between the sacral skin and mattress upon admission was 34.53 °C (Standard deviation, SD, 0.58), where no pressure ulcers developed sacral skin temperature while lying in bed was similar (35.02 °C SD 0.18). This study was flawed given the lack of control over the selection of the support surface used in bed—11/52 were allocated active support surfaces (alternating mattresses) the other 41 rested on reactive surfaces (foam mattresses) and skin surface temperature stability while lying on alternating surfaces has been reported in a volunteer study [25] where sacral skin temperature remained constant while resting on an alternating mattress but increased on average by 1.3 °C while the subjects rested on a foam mattress.

While these clinical studies may have conflicting results on the value of skin surface temperature data as indicators of potential tissue damage, they reinforce the challenges faced when trying to obtain such physiological data in health care settings where control over the ambient environment and allocated pressure ulcer preventive care may not be possible. In the laboratory clearer indications of the impact of modifying skin surface temperature have been seen. Kokate and colleagues [26] loaded 12 metal discs upon the dorsal surface of young pigs. Each disc was loaded to provide a surface pressure of 100 mmHg maintained for five hours, however the discs were presented at different temperatures ranging from 25 °C, 35, 40–45 °C. Where 100 mmHg was applied for five hours at the lowest temperature (25 °C) no skin or muscle damage was observed. As the temperature of the loaded discs increased moderate levels of muscle damage was observed at 35 °C with skin and muscle damage recorded at the higher temperatures. This set of experiments suggests that cooling skin may provide additional protection from pressure damage.

Ten years ago, Lachenbruch [27] summarized these, and other studies of the effect of skin temperature on pressure ulcer development concluding that a 5 °C reduction in skin surface temperature might provide similar benefits in terms of skin integrity as the most expensive patient support surfaces. Whether such a drop in surface temperature would be acceptable to patients is unclear! Recently the effects of cooling on tissue viability have been explored in a rat model [28] where a load of 700 mmHg was applied for 3 h to the trochanteric area of rats with either local warming (+10 °C) or local cooling (−10 °C). Load application with local cooling

reduced the accumulation of cytokine tumor necrosis factor alpha (TNF-  $\alpha$ ) compared with pressure and local warming, suggesting a protective effect of cooling against inflammation. Under loading with heating or cooling no change in the production of interleukin 1 $\beta$  was observed. In humans the effect of local cooling or warming has been explored in terms of their effect on the hyperemic response after removal of load from soft tissues [29]. In a group of ten spinal cord injured and ten uninjured controls a 60 mmHg load was applied to the sacrum for 20 min followed by a recovery period of similar duration. Three test protocols were applied pressure without temperature modification, pressure with local cooling ( $-10^{\circ}\text{C}$ ) and pressure with local heating ( $+10^{\circ}\text{C}$ ). In both the SCI and control groups smaller hyperemic responses were observed where pressure was applied with local cooling compared with either no temperature changes or local heating with this reduced hyperemic response attributed to reduced metabolic and neurogenic activity. Local cooling has been recently associated with changes in cytokine production and reduced hyperemic responses after loading—whether such changes can be translated into interventions that help cool vulnerable skin and soft tissues without reducing the quality of life for patients through reduced skin temperatures is a challenge for the coming years.

## Skin Humidity and Pressure Ulcers

High relative humidity at the junction between the skin and support surface has long been related to pressure ulcer development. In 1992, the then US Agency for Health Care Policy and Research issued its pressure ulcer prevention guidelines [30] where it was recommended that relative humidity above 40% should be avoided to help prevent pressure ulcers, the source of this specific threshold is unclear. Clark [24] reported skin-mattress relative humidity at the sacrum of 52 elderly hospital patients admitted with no visible sacral skin damage. Among this cohort six developed superficial sacral pressure ulcers and in this group the mean relative humidity measured at the sacrum upon admission to hospital was 74.1% (SD 11.6). Where no superficial skin damage occurred the mean relative humidity at the sacrum upon admission was considerably lower, 43.0% (SD 3.7) however as noted earlier mattress allocation was not controlled within this study and some subjects were allocated alternating pressure support surfaces with the majority resting upon foam mattresses. Black and colleagues [31] reported a small controlled study comparing pressure ulcer incidence upon two reactive support surfaces—one low air loss bed with ‘microclimate management’ the comparator being a powered mattress. The powered mattress was the support surface used within a single centre cardio-vascular intensive care unit and prior to the study five of the powered mattresses were replaced with the low air loss bed with microclimate management. Eligible subjects were those patients within the intensive care unit (ICU) expected to have a length of stay in ICU for longer than 3 days, did not require a support surface to assist with pulmonary or wound challenges and were not on an end-of-life pathway. Fifty-two subjects were recruited with 31 receiving microclimate management and 21 the

ICU standard bed mattress, the process of allocation to the two regimes was unreported. On average the duration of follow up was 7 days with skin assessments every 3 days. During the study five patients developed a total of eight pressure ulcers—three of these presented as category II wounds under a facemask upon a single patient allocated the microclimate control mattress. The other pressure ulcers presented only among patients upon the standard ICU mattress and these tended to be superficial (two Category I ulcers, two category II and one suspected deep tissue injury). There was also a small number of patients who entered the study with pressure injuries (severity unspecified)—on the standard ICU mattress two patients each with a single ulcer showed deterioration of their wounds during the stay in ICU. One suspected deep tissue injury present upon a patient allocated the microclimate control mattress did not progress to an open wound, the other patients allocated to the microclimate control mattress were reported to show no deterioration of their pressure damage or were lost to follow-up. Black et al. [31] noted that their results may simply reflect the age of the support surfaces with the standard ICU mattresses in use for seven years compared with the new microclimate control mattresses and no data was reported upon the skin microclimate at the sacrum (or other anatomical landmarks) within the two groups of subjects. The effect of support surfaces upon modifying the microclimate at vulnerable body sites is further compromised by the effect of the various under-pads and transfer sheets often placed upon the bed surface to help repositioning and continence management [32]. As yet the impact of humidity, and its control, on pressure ulcer incidence is poorly understood with the influence of other practices (for example transfer sheets) detracting from microclimate management systems ability to moderate microclimate factors.

---

## Discussion

Microclimate and pressure ulcer prevention have been associated for many years although active consideration of microclimate factors were perhaps lost while the clinical and research communities focused upon load management. Re-discovery of the microclimate as a potential factor in pressure ulcer prevention in recent years offers new perspectives on how pressure ulcer prevention could be complemented through management of the microclimate. Increasingly reductions in skin surface temperature are being associated with benefits for pressure ulcer prevention both in modifying the hyperaemic response and reduction proliferation of certain cytokines. However these potentially beneficial changes may be achieved at a cost of reduced patient acceptance due to the local skin cooling such interventions would require. Moisture and humidity management may also offer benefits in terms of reduced superficial pressure ulcer development although as yet the ability of commercially available microclimate management systems to alter the microclimate at vulnerable body locations is poorly reported. Additionally the impact of other care practices (under-pads for example) upon microclimate changes appears to reduce the potential benefit of microclimate management systems.



Microclimate is a growing area of activity in pressure ulcer prevention although several hurdles yet remain. For many years discussion around pressure redistribution focused upon perceived, albeit inaccurate, ‘safe’ thresholds (e.g., 32 mmHg at the skin surface) it would be a weakness of the microclimate debate where similar false thresholds developed for skin temperature and humidity. Zhong and co-workers [33] noted that there is limited *in-vitro* or *in-vivo* data upon the normal interactions between human skin and external fabrics and where available ‘existing *in vivo* experimental studies have rarely led to any significant results and solid conclusions’. Part of this challenge lies in the multiple changes in skin condition between individuals and within individuals at different body sites, these intra- and inter- differences in skin condition will likely lead to microclimate also varying among and within subjects restricting the ability of any single study to clearly demonstrate microclimate changes with skin outcomes. One solution to this challenge [33] may be for stronger dialogue between the textile research field and the pressure ulcer community—perhaps the third edition of this book will feature a joint chapter on developments in microclimate and its effect on pressure ulcer prevention?

---

## References

1. National Pressure Ulcer Advisory Panel and European Pressure Ulcer Advisory Panel. Prevention and treatment of pressure ulcers: clinical practice guideline. Washington, DC: National Pressure Ulcer Advisory Panel; 2009.
2. National Pressure Ulcer Advisory Panel, European Pressure Ulcer Advisory Panel and Pan Pacific Pressure Injury Alliance. In: Haesler E, editor. Prevention and treatment of pressure ulcers: clinical practice guideline. Osborne Park, WA: Cambridge Media; 2014.
3. International review. Pressure ulcer prevention: pressure, shear, friction and microclimate in context. A consensus document. London: Wounds International. 2010. <http://www.woundsinternational.com/clinical-guidelines/international-review-pressure-ulcer-prevention-pressure-shear-friction-and-microclimate-in-context> Accessed 22 Dec 2014.
4. Roaf R. The causation and prevention of bed sores. *J Tissue Viability*. 2006;16(2):6–8. Reprinted from *Bedsore Biomechanics*, McMillan Press, 1976.
5. Clark M, Cullum N. Matching patient need for pressure sore prevention with the supply of pressure redistributing mattresses. *J Adv Nurs*. 1992;17(3):310–6.
6. Welch G. Interface pressure measurement. *Decubitus*. 1989;2(4):8–10.
7. Rondorf-Klym LM, Langemo D. Relationship between body weight, body position, support surface, and tissue interface pressure at the sacrum. *Decubitus*. 1993;6(1):22–30.
8. Whittemore R, Bautista C, Smith C, Bruttomesso K. Interface pressure measurements of support surfaces with subjects in the supine and 45-degree Fowler positions. *J ET Nurs*. 1993;20(3):111–5.
9. Defloor T. The effects of position and mattress on interface pressure. *Appl Nurs Res*. 2000;13(1):2–11.
10. Scott EM, Baker EA, Kelly PJ, Stoddard EJ, Leaper DJ. Measurement of interface pressures in the evaluation of operating theatre mattresses. *J Wound Care*. 1999;8(9):437–41.
11. Clark M, Black J. Skin IQ™ Microclimate manager—made easy. [http://www.woundsinternational.com/pdf/content\\_9818.pdf](http://www.woundsinternational.com/pdf/content_9818.pdf). Accessed 22 Dec 2014.
12. Randall DJ, Eckert R. *Animal physiology: mechanisms and adaptations*. 2nd ed. San Francisco: Freeman WH; 1983.
13. Du Bois EF. The basal metabolism in fever. *J Am Med Assoc*. 1921;77(5):352–5.

14. Mayrovitz HN, Sims N. Biophysical effects of water and synthetic urine on skin. *Adv Skin Wound Care*. 2001;14(6):302–8.
15. Brienza DM, Geyer MJ. Using support surfaces to manage tissue integrity. *Adv Skin Wound Care*. 2005;18:151–7.
16. Gerhardt LC, Strässle V, Lenz A, et al. Influence of epidermal hydration on the friction of human skin against textiles. *J R Soc Interface*. 2008;5(28):1317–28.
17. Wu KS, van Osdol WW, Dauskardt RH. Mechanical properties of human stratum corneum: effects of temperature, hydration, and chemical treatment. *Biomaterials*. 2006;27(5):785–95.
18. Gefen A. How do microclimate factors affect the risk for superficial pressure ulcers: a mathematical modeling study. *J Tiss Viab*. 2011;20(3):81–8.
19. Verhonick PJ, Lewis DW, Goller HO. Thermography in the study of decubitus ulcers: preliminary report. *Nurs Res*. 1972;21(3):233–7.
20. Newman P, Davis PH. Thermography as a predictor of sacral pressure sores. *Age Ageing*. 1981;10(1):14–8.
21. Trandel RS, Lewis DW, Verhonick PJ. Thermographical investigation of decubitus ulcers. *Bull Prosthet Res*. 1975;10(10–24):137–55.
22. Norton D, McLaren R, Exton-Smith AN. An investigation of geriatric nursing problems in hospital. Edinburgh, NY: Churchill-Livingstone; 1975.
23. Sprigle S, Linden M, McKenna D, et al. Clinical skin temperature measurement to predict incipient pressure ulcers. *Adv Skin Wound Care*. 2001;14(3):133–7.
24. Clark M. The aetiology of superficial sacral pressure sores. In: Leaper D, Cherry G, Dealey C, Lawrence J, Turner T, editors. *Proceedings of the 6th European Conference on Advances in Wound Management*. Amsterdam: McMillan Press; 1996. p. 167–70.
25. West J, Hopf H, Szaflarski N. The effects of a unique alternating-pressure mattress on tissue perfusion and temperature. In: 5th Annual meeting of the European tissue repair society. Padua: ETRS; 1995.
26. Kokate JY, Leland KJ, Held AM, Hansen GL, Kveen GL, Johnson BA, Wilke MS, Sparrow EM, Iazzo PA. Temperature-modulated pressure ulcers: a porcine model. *Arch Phys Med Rehabil*. 1995;76(7):666–73.
27. Lachenbruch C. Skin cooling surfaces: estimating the importance of limiting skin temperature. *Ostomy Wound Manage*. 2005;51(2):70–9.
28. Lee B, Benyajati S, Woods JA, Jan YK. Effect of local cooling on pro-inflammatory cytokines and blood flow of the skin under surface pressure in rats: feasibility study. *J Tiss Viab*. 2014;23(2):69–77.
29. Jan YK, Liao F, Rice LA, Woods JA. Using reactive hyperemia to assess the efficacy of local cooling on reducing sacral skin ischemia under surface pressure in people with spinal cord injury: a preliminary report. *Arch Phys Med Rehabil*. 2013;94(10):1982–9.
30. Panel on the Prediction and Prevention of Pressure Ulcers in Adults. *Pressure Ulcers in Adults. Prediction and prevention: clinical practice guideline number 3*. AHCPH Publication No. 92-0047. Rockville, MD: Agency for Health Care Policy and Research, Public Health Service, U.S. Department of Health and Human Services; 1992.
31. Black J, Berke C, Urzendowski G. Pressure ulcer incidence and progression in critically ill subjects: influence of low air loss mattress versus a powered air pressure redistribution mattress. *J Wound Ostomy Continence Nurs*. 2012;39(3):267–73.
32. Williamson R, Lachenbruch C, VanGilder C. A laboratory study examining the impact of linen use on low-air-loss support surface heat and water vapor transmission rates. *Ostomy Wound Manage*. 2013;59(8):32–41.
33. Zhong W, Xing MM, Pan N, Maibach HI. Textiles and human skin, microclimate, cutaneous reactions: an overview. *Cutan Ocul Toxicol*. 2006;25(1):23–39.



Sue Bale, Janice Cameron, Sylvie Meaume,  
and Andrea Ingegneri

## Introduction

The skin is the largest organ in the body and it is essential that clinicians involved in pressure area care are cognizant of the need to maintain or improve its condition. Healthy, normal skin is the first and best line of defense against the invasion of microorganisms, chemicals, and trauma. The skin is constantly exposed to potential irritants and chemicals, any of which may cause damage [1]. Furthermore, the skin has an immune defense function through its Langerhans cells. Part of the immune system that fights foreign invaders like viruses and bacteria. The skin is also a production plant using the energy of the sun to make vitamin D, essential for many functions of the body.

In addition, mechanical forces, allergy, inflammation, systemic disease, and burns also impair skin integrity, producing a range of responses. These include erosion, pressure ulceration and ulceration, erythema, papules, and vesicles [2].

With regard to pressure ulcer prevention and management of the older person, skin care is a particular challenge, as people live for longer and are continually raising their expectations of healthcare. In addition, the developed world is experiencing increased numbers of older people within their populations. Davies [3] reports that despite differing welfare systems country policies for older people are broadly consistent in their targets. The aims of such policies are to maintain older people in

---

S. Bale  
Llanfrechfa Grange Hospital, Cwmbran, UK

J. Cameron  
Department of Dermatology, Oxford Radcliffe Hospitals NHS Trust, Churchill Hospital,  
Oxford, UK

S. Meaume  
Hôpital Charles Foix, Ivry sur Seine, France

A. Ingegneri (✉)  
Department of Dermatology, Santa Chiara Hospital, University of Pisa, Pisa, Italy

their chosen environment, whilst promoting autonomy and a meaningful life [4–6]. Nolan [7] describes global initiatives that aim to prevent or delay ill health, where nurses are encouraged to be proactive in improving the health of older people, especially in the community setting.

In the UK an Audit Commission review [8] recommended that increased attention be paid to the problems of incontinence in patients cared for in the community. Incontinence has been identified as a factor that precedes skin damage and it would seem appropriate that preventing and managing incontinence should be an important aim of nursing care. As people become older, protection of the skin against the effects of incontinence is of particular importance, and as recommended by Le Lievre [9], the development of cost-effective, evidenced-based management strategies should be a priority.

---

## Normal Skin

Originating from the embryonic ectoderm and mesoderm, the skin is the largest organ in the human body, making up approximately 16% of total body weight (about 9 kg) and covering a surface area of 1.8 m<sup>2</sup> [10]. The skin has four main functions: protection, sensation, vitamin D manufacture, and thermal regulation. Additional functions include acting as an energy and water reserve, excreting urea and salts in sweating.

---

## Protection

The skin provides protection against loss of water and electrolytes, chemical and mechanical assaults, bacterial and pathogenic invasion, and ultraviolet radiation. In essence, the skin maintains a homeostatic environment and acts as a barrier.

---

## Sensation

This is part of the body's ability to protect itself from the surrounding environment. Normal skin is sensitive to pain, touch, temperature, and pressure, through its network of nerve endings or receptors. When stimulated these receptors transmit impulses or signals to the cerebral cortex where they are interpreted.

---

## Manufacture of Vitamin D

Vitamin D is synthesized in the presence of daylight. Epidermal cells synthesize 7-dehydrocholesterol, converting it to cholecalciferol or vitamin D when exposed to ultraviolet rays [10].

---

## Thermal Regulation

In health normal core body temperature is around 37 °C. The skin controls this optimum temperature by the two mechanisms of sweating and blood circulation. When the body is too warm vasodilation occurs, which draws blood to the surface of the skin so cooling it down. In addition, sweat coats the skin's surface and as it evaporates, also cools the skin. When too cold vasoconstriction of blood vessels redirects heat to the body core and internal organs so preserving heat. At the same time shivering results from the arrector pili muscles attached to hair follicles contracting. This has the effect of causing the hairs to stand erect so preserving heat by forming an insular layer of air between the hair and skin.

The epidermis and the dermis are the two layers of which the skin is comprised. Supporting these main layers is a layer of subcutaneous fat as insulation and protection from physical forces, although some parts of the body including the heels, elbows, and shins do not have this protective fatty layer.

---

## The Epidermis

The epidermis is a protective and physical barrier, very thin. It is composed of cells called keratinocytes. The keratinocytes meet five different stages of the course of their life, starting from the deepest part of the epidermis where they are born, rising up to the surface where they will then fall apart. During their existence they undergo cornea cytomorphosis or keratinogenesis passing from living cells endowed with nucleus, to dead cells without nucleus and forming simple corneal lamellae that determine the keratinization of the skin and its protection.

The epidermis also serves to protect against radiation from the sun. this function is carried out by the melanocytes found in the basal layer of the epidermis. These cells when they are exposed to light they produce melanin which helps to protect against ultraviolet radiation.

The epidermis is the avascular, outer layer of the skin nourished by the diffusion of nutrients, and is thickest on the soles of the feet and palms of the hands [11]. Starting from the outside it comprises six layers:

- **Horny layer—stratum corneum.** The horny outer layer consisting of cells that are dead and desquamating. These cells are thin and flat and keratinized.
- **Clear cell layer—stratum lucidum.** The translucent layer, just below the stratum corneum and only present where the skin is thickened. The cells comprising this layer contain large amounts of keratin, and this layer is commonly found where trauma and friction are evident, leading to the development of calluses and corns.
- **Granular layer—stratum granulosum.** The precursor of keratin, keratohyalin a granular substance is found in this layer. Keratohyalin gradually replaces the cytoplasm of the cells in this layer.
- **Prickle cell layer—stratum spinosum.** The cells that comprise this layer are characterized by the fine cusps or processes that resemble prickles. These hold the cells together and protect against the physical forces of shear and friction.

- Basal layer—stratum basale. The layer joins the dermis and contains cells that are rapidly dividing. Over a period of 21–28 days these cells migrate up to the outer layer of the epidermis.
- The epidermal/dermal junction. Here there is an undulation of dips and peaks, the rete malpighii pegs that help to give strength to the skin, protecting from physical forces such as shear and friction.

---

## The Dermis

The dermis is the layer of skin under the epidermis. It is a thicker layer of connective tissue that contains nerves, blood and lymphatic vessels, hair follicles, collagen and sweat glands. The blood vessels of the dermis help to maintain a constant body temperature. Collagen and elastin are produced by cells called fibroblasts. Collagen and elastin give turgidity and elasticity to the skin.

This vascular layer is derived from the embryonic mesoderm and is approximately 0.5–3 mm in thickness. Well supplied by blood vessels and nerves, it contains hair follicles, blood capillaries, sebaceous glands, and sweat glands. These structures are contained by a matrix of collagen and elastin and form support for underlying structures. Between 40 and 80% of total body water is held in the dermis [10]. The dermis includes the following structures and cells:

- Ground substance. The gel-like material in which connective tissue cells and fibers are embedded. It provides an emergency water store.
- Tissue mast cells. These cells are closely approximated to hair follicles and blood vessels, producing heparin and histamine, as part of tissue repair when injury to the skin occurs.
- Tissue macrophages. These cells are able to engulf and digest foreign bodies such as debris and bacteria and are especially active when tissues are injured. Macrophages also play a key role in regulating the healing process.
- Collagen fibers. Collagen is the major structural protein and is secreted by dermal fibroblasts as tropocollagen. Normal human dermis mainly consists of type I collagen, a fiber-forming collagen. Type I collagen accounts for between 77 and 85% of collagen [12]. Collagen is the protein that gives skin its tensile strength.
- Elastin fibers. Another dermal protein that provides skin with its elastic recoil properties. Elastin prevents skin from being permanently misshapen and these fibers form spirals or coils that allow for distraction and return to normal configuration. It contains high amounts of proline and glycine, though it accounts for less than 2% of the skin's dry weight [12].
- Lymph vessels. Drain excess fluid and plasma proteins from the dermis [10] and connect with the body's lymphatic system.
- Nerve endings. Sensory or afferent nerves that carry information about the outside world to the brain and spinal cord, and continually monitor the environment of individuals. The sensory nerves convey the sensations of heat, cold, touch, and pain. Specialized sensory receptors are found in the dermis (and also in the basal layer of the epidermis).

- Sweat glands—sudoriferous glands. Spiral structures composed of epithelial tissue that emerge from the dermis or subcutaneous tissue, opening by a duct onto the surface of the skin. They secrete a mixture of water, sodium chloride, and small amounts of urea, lactic acid, and potassium ions. In extreme temperatures as much as 3.5 kg of body weight can be lost in a day.
- Sebaceous glands. There are thousands of these minute holocrine glands on the skin that secrete an oily, colorless, odorless fluid, sebum, through the hair follicles. Sebum is a moisturizing substance that forms a waterproof covering.

---

## How Age Damages Skin

As the years go the skin undergoes changes. The functionality of the skin is reduced: increase in transepidermal water loss (TEWL), the ability of the skin to fight infections; adjusting body temperature also decreases. During several cell cycles, DNA can be damaged and cells can grow without control, resulting in skin cancer.

Reduces the concentration of collagen and elastin in the dermis. Increased lines of expression deeper around the mouth and forehead. Hair and nails are thinner and brittle.

---

## Thinning and Loss of Elasticity

It is estimated that the paper-thin appearance of the skin in older people is due to a 20% reduction in dermal skin thickness compared to youth [1]. In the normal aging process, the epidermal junctions become flattened and dermal papillae and epidermal rete ridges or pegs are destroyed, rendering the skin vulnerable to physical damage as the epidermal layers can more easily separate from each other [1]. Skin also loses elasticity as the fibroblasts responsible for elastin and collagen synthesis decline in number, elastic fibers thicken, and the ability for elastic recoil is lost, so causing creases and wrinkles.

---

## Reduction of Fatty Layers and Drying

At the same time the amount of subcutaneous or adipose fat lessens, so providing less of a cushion for underlying bone. This occurs primarily in areas such as the face, shins, hands, and feet. Additionally, natural moisture from sebum secretion reduces in old age, as these sweat glands become smaller, leading to increased dryness of the skin. Overall, the aging process adversely affects skin quality causing dry, thin, inelastic skin that is susceptible to damage. Potential sources of skin damage include pressure, friction, and shear, either individually or in combination. In addition, damp skin caused by exposure to excessive moisture is more vulnerable to shearing forces and at risk from loss of barrier function. Incontinence in old age renders the skin vulnerable to damage when excess or caustic moisture from urine, stool, or frequent washing reduces skin tolerance.

## How Incontinence Damages Skin

It is an expected norm that adults are in control of bladder and bowel functions, incontinence only being tolerated in babies and the very young. Indeed, much value is often placed on children's achieving continence in the western world. However, epidemiological research reports that the number of people experiencing incontinence far exceeds the number that seek help and advice from healthcare professionals [13]. Not a disease in its own right, incontinence is a symptom of a broad range of underlying conditions. Incontinence is most common in older women, affecting 11.6% of all women included in a postal survey of 22,430 people [14]. In this survey stress incontinence and urge incontinence were significantly increased in parous women compared to nulliparous women, particularly in those who had borne four or more children.

There is some evidence that attitudes towards incontinence are improving. Willis [15] reports the value of a national awareness campaign by the Department of Health and the Continence Foundation in directing people to the appropriate professional services. In addition, the Royal College of Physicians report that the number of people seeking healthcare advice is increasing [16].

Swaffield [13] highlights the extent of the problem of incontinence in healthcare institutions and social services facilities. She reports that many surveys have demonstrated high rates of incontinence in these care settings and argues that this is due to inappropriate assessment and intervention on the part of healthcare professionals. Swaffield also suggests that there is a need not only to correctly identify patients who could be treated but also to improve public and professional understanding, assessment, treatment, and management of incontinence. A recent census of nursing care and care homes [17] highlighted incontinence as being extremely prevalent, where caring for patients' incontinence problems accounted for the greatest input in nursing time.

## Urinary Incontinence

The most common types of urinary incontinence are stress incontinence, urge incontinence, and overflow incontinence:

- Stress incontinence is a failure of the urethral sphincter that results from a weakness in the pelvic floor, which allows the urethra to descend and the sphincter to open. This type of incontinence commonly occurs with sudden abdominal pressure on the bladder, usually on coughing, laughing, or sneezing.
- Urge incontinence is caused either by an overactive detrusor function (motor urgency) or by hypersensitivity (sensory urgency). This type of incontinence is caused by contraction of the detrusor muscle of the bladder leading to the urge to void even though only a small amount of urine has collected.
- Overflow incontinence is caused by urinary retention that arises due to an obstruction (feces or tumor), an underactive detrusor muscle or failure of the urethra to open.



---

## Fecal Incontinence

This is far less common than urinary incontinence. Johanson and Lafferty [18] report fecal incontinence as being especially prevalent in older people and those requiring long-term care. This type of incontinence is typically caused by constipation or fecal impaction, and also by damage to the pelvic floor and anal sphincter.

---

## Maceration and Incontinence Dermatitis

Maceration occurs a result of prolonged exposure of the skin to excessive moisture from profuse sweating, urinary incontinence, and wound exudate. Cutting [19] describes macerated skin as a frequent result of urinary incontinence. He cites literature from 1974 onwards and reports a strong relationship between excessive skin moisture and the development of pressure ulcers. Hampton and Collins [20] highlight the problem of maceration and associated excoriation as increasing the risk of damage to the skin from friction.

As discussed above, patients generally experience urinary incontinence more frequently than fecal incontinence. Fiers [21] highlights the harmful effects of urinary incontinence on the skin where bacteria and ammonia cause undesirable alkaline skin conditions and destructive enzymatic activity is also increased. However, Leyden et al. [22], Berg [23], and Kemp [24] suggest that a combination of urinary and fecal incontinence is most harmful to skin. Urine and feces together raise the pH of skin and thus increase the harmful activity of proteases and lipases. Andersen et al. [25] described this when reporting the results of a study that included healthy human volunteers. These researchers observed that when applied directly onto healthy skin, the digestive enzymes found in feces caused severe skin irritation. Exposure to excessive moisture increases the permeability of the skin and leads to a reduction of the skin barrier function. Patients in whom the skin barrier function has been disturbed in this way are at risk from developing contact dermatitis, an exogenous eczema, caused by external factors that have either irritated the skin or caused an allergic reaction [26]. Incontinence dermatitis is an irritant dermatitis, which occurs as a result of high moisture exposure, friction, bacteria, and enzymatic activity. Nursing assessment tools and clinical guidelines designed to identify patients at particular risk of skin damage highlight both urinary and fecal incontinence as contributory factors [27].

---

## The Evidence that Rejects the Use of Soap and Water

When patients experience episodes of incontinence they are washed to remove the harmful chemicals contained in urine and/or feces and also to eliminate malodor and promote patient comfort. When patients are frequently incontinent it follows that they are washed frequently. If soap and water is used the pH of skin alters, becoming alkaline instead of acidic, thus adversely affecting its protective function [28]. The pH of normal skin is about 5.5, which is referred to as the “acid mantle”

because this pH prevents bacterial growth and inhibits the action of digestive enzymes [1]. As the skin becomes more alkaline, it increases its permeability to watersoluble irritants [29], thus rendering it more vulnerable to tissue breakdown. Soap consists of fatty acids or triglycerides and has been used as a cleansing agent for thousands of years. In general use soap is beneficial. Kirsner and Froelich [30] report the benefits of using soap in healthcare for infection control to cleanse skin and prevent disease, but this is not the case for patients who are experiencing incontinence. Alkaline soap reduces the thickness and number of the layers of cells in the stratum corneum and emulsifies and removes the protective lipid coating of the skin [12]. She reports that it takes 45 min to restore normal skin pH following washing with soap, and that prolonged exposure may need 19 h. In addition, washing macerated, excoriated skin with soap and water will lead to dryness of the skin from a decrease in skin surface lipids.

---

## **The Evidence that Supports the Use of Specialized Skin-Care Products**

Skin care of the incontinent patient consists of a regimen of skin cleansing and skin protection with a barrier preparation. Lutz and White [31] report the benefits of using specialized skin moisturizers when caring for patients with incontinence as it relieves dryness and protects against excessive moisture and irritants. These researchers report that specialized skin protectants provided better protection against washing than other protectants. Other research has demonstrated the effectiveness of implementing skin-care protocols for patients with incontinence. Lewis-Byers et al. [32] report the results of a small randomized controlled trial in which it was found that the use of soap and water together with a moisturizer was less effective and more time-consuming than using a no-rinse cleanser and a durable barrier cream. Bale et al. [29] report similar results in a study that explored the benefits of implementing a new skin-care protocol that included the introduction of specialized skin-care products. These researchers report a statistically significant reduction in the incidence of incontinence dermatitis and grade 1 pressure ulcers in combination with significant savings in staff time and product costs.

---

## **Elements of Skin Care**

The US Agency for Health Care Policy and Research (ACHPR) guidelines for managing patients with urinary incontinence [27] recommend that: skin is inspected regularly, gently cleansed with a mild cleansing agent immediately after soiling, absorptive pads are used, and topical barriers are used to protect the skin from moisture.

- Skin inspections. Skin condition should be assessed regularly. For the older person with incontinence this may be daily or more frequently.

- Assess level of continence and treat incontinence appropriately. This may involve adapting patients' physical environment to include providing clothing that can be easily removed, physiotherapy, improving access to toilets, providing walking aids and assistance to access toilets, regular toileting or provision of commode, and regular cleansing and changing of soiled incontinence aids.
- Skin care. The aim here is to keep the skin clean, dry, and well moisturized to maintain the best barrier possible against skin damage. The use of specialized, pH-balanced skin cleansers, the avoidance of damaging soaps, and protecting skin with skin barriers appropriate to individual patient needs are important elements.

---

## How Excessive Wound Exudate Damages Skin

Wound fluid has a beneficial role to play in wound repair in a normal healing acute wound. It has been shown that in the normal healing process high levels of enzyme activity, responsible for clearing the debris from the wound, decrease as the wound heals. However, research studies suggest that exudate from chronic ulceration appears to have a damaging effect on normal wound healing due to continued raised levels of tissue destructive enzymes [33–35].

Normal skin barrier function has been shown to be compromised in peri-wound skin compared to normal skin [36]. Excessive exudate can damage the vulnerable peri-wound skin through enzymatic activity and by causing physical damage to the structure of skin. Cutting and White [37] argue that when patients have existing pressure ulcers, the exudate that drains can cause skin damage by irritating the surrounding skin. In chronic wounds, proteases (present in the exudate), particularly matrix metalloproteases, are thought to actively damage healthy skin through their enzymatic action [35].

Excessive wound exudate can cause physical damage to the structure of the skin. Cutting [19] describes how the stratum corneum initially absorbs fluid, causing swelling. Further saturation reduces barrier function, leading to skin breakdown. As with urinary incontinence the peri-wound skin can become macerated from prolonged contact with the wound exudate.

---

## Protection of the Peri-Wound Skin from Wound Exudate

The aim of exudate management is to achieve an optimal moisture balance within the wound environment and prevent damage to the surrounding skin. Dressing choice and peri-wound protection plays a large part in patient comfort. It is important to understand how the different dressings handle moisture and thus their suitability for the wound and the expected wear time. Dressings with adhesive borders should be avoided on patients with edematous tissue, fragile skin, wet skin, or where there is localized inflammation present around the wound.

Prolonged exposure to wound exudate on previously healthy skin may result in maceration and further loss of epithelium. The macerated skin may appear white, thickened, and hard. The use of a suitable skin protectant applied to the peri-wound skin will prevent skin damage from wound exudate and reduce the risk of further loss of epithelium. Where maceration and inflammation are present, the skin will appear erythematous and may be moist or weeping [38]. The patient may complain of burning, stinging, and itching of the affected area. Treatment of erythematous maceration may require the application of a topical corticosteroid preparation to reduce the local inflammation prior to the use of a barrier preparation. Creams are easier to apply to wet skin than ointments. A potent topical steroid should be used for 1–2 days only and gradually reduced over the next few days. A barrier preparation can then be applied to the peri-wound area as a skin protectant. Various skin barrier preparations are available including ointments, creams, and a barrier film that leaves a protective film on the skin surface. The barrier film comes as a spray and also in an impregnated foam on a stick. It can be applied to vulnerable skin under adhesive dressings to aid adhesion and prevent trauma on removal.

---

## Prevention of Pressure Injuries

Prevention of hospital-acquired pressure injuries (HAPI) remains a crucial clinical challenge especially for those patients undergoing surgery. In addition to standard of preventive interventions (anti-decubitus mattress, active or passive patient mobilization) the use of a 5-layer silicone foam applied in the areas under pressure (sacrum, heel, etc) resulted in a significant decrease of pressure injuries [39].

---

## Skin Care at End of Life

In USA one fifth of population will be 67 years or older by 2040 [40], and more and more people are experiencing more comorbid diseases in their last years. Concomitant with this demographic change is the fact that the number of frail elderly patients will increase and will probably elect palliative rather than curative care at the end of life. Overall, there is limited information on wounds at the end of life. There are few studies on the prevalence and incidence of wounds at the end of life. The prevalence rates reported between 13 and 47% [41, 42], and incidence rates from 8% to 17% [41–43]. Most, if not all, people at the end of life are at risk for developing soft tissue ulcerations. Decubitus ulcers occurring at the end of life are often unavoidable and largely attributable to malnutrition and immobilization of patients. Individuals at the end of life who have a wound confront several problems, including accepting a palliative approach or more aggressive wound treatment. Patients should be advised that many wounds at the end of life do not heal. The rupture of tissues in patients at the end of life is caused by several factors: low concentration of oxygen in the tissues, low levels of hemoglobin and alterations in the

gas exchange. With age, the skin becomes more frail, thinner and prone to injury; healing could be delayed. As the end of life approaches, activity and mobility decrease, leading to tissue ischaemia by prolonged pressure. Comorbidities and pain can have a negative impact on mobility; the elbows, the sacrum and the heels are particularly vulnerable to pressure. The presence of moisture—for example, wound exudate, sweat and feces or urine - makes the tissue much more vulnerable to friction, increases the risk of tissue breakage. The elderly hunger and thirst have decreased, resulting in dehydration. Malnutrition and protein-caloric dehydration compromise skin turgidity. All these factors leave the tissue vulnerable to new cracks and compromise the normal wound healing mechanisms.

---

## Wound Care

The goals of palliative and wound healing wounds vary little from one another, apart from the goal of healing. Palliative care becomes the main objective when the patient's general state has expired, the wound does not improve or deteriorate significantly, where aggressive interventions are no longer appropriate or quality of life can no longer be improved. The care target is then redirected to palliation. Palliative care includes: pain management, wound management, the appropriate choice of medication, reducing the risk of infections, peri-wound protection, reducing odors. The care goals will focus on improving the quality of life.

---

## Prevention and Treatment of Wounds

In general, the recommendations to maintain skin integrity include a gentle cleansing with a low pH skin cleanser, the use of barrier creams to maintain good hydration. It is useful to minimize the damaging effects of incontinence. During mobilization of the patient, the buttocks and sacral areas must be protected. Although a general guideline is to reposition an individual in bed every 2 h, it is necessary to consider the general state of the patient: hemodynamic instability, pain, nausea or vomiting. With reduced ventilation capacity at the end of life, many people require the head elevation of the bed. The guideline is to keep the head of the bed as low as possible—preferably 30° or less—to minimize friction [44].

Dressings for wounds. Normal comfort is improved with fewer dressing changes, so it is advisable to select a dressing for several days. The sacral area or other bony prominences should be protected with a low friction coefficient, foam or hydrocolloid film to minimize friction.

The exudate of the wound is the fluid that oozes from the extracellular spaces. Protecting periwound tissue is important and can be a challenge; Excessive exudate can cause perilesional maceration. The exudate can be managed by a barrier cream on the periwound zone or skin protection. In the case of minimal exudate, a hydrocolloidal, hydrogel or composite dressing works well. With moderate exudate it can use a hydrogel, hydrocolloid, foam, composite or calcium alginate. When the

exudate is a composite, plentiful, hydrophilic or calcium alginate, expanded dressing should be selected.

Chronic wounds are considered colonized with bacteria [45]. During colonization, microorganisms are present and replicate on the wound surface. In the event of infection, bacteria invade healthy tissue and produce pathophysiological effects. At the end of life, patients have a compromised immune system that is less able to fight infection. The classic signs of wound erythema, pain, infection, edema and purulent exudate, heat.

**Necrotic tissue and debridement.** Necrotic tissues can promote the growth of bacteria. It becomes essential to remove the necrotic tissues by surgical or medical debridement.

The smell of wounds can be embarrassing for the patient. It is necessary to change the dressing more frequently. Non-viable tissues must be untangled; Autolytic debridement is often the least painful method for the individual. Surgical debridement is not recommended because it is often considered excessive bleeding and excessive pain.

Based on the guidelines, pain assessment is now mandatory on a routine basis (Based on the distribution of pain VAS scores), even for people unable to express pain. Individuals with cognitive impairments can be assessed by observing behaviors such as facial expression, vocalizations, changes in activity, body movements or changes in mental status such as crying or irritability.

Pain control should be part of the patient's goals and wishes related to care. The management of pain associated with wounds is achieved through a balance between adequate wound care, necessary medications and conservative measures. Analgesics should be prescribed according to the guidelines of the World Health Organization (WHO) for pain control.

---

## References

1. Baranoski S, Ayello EA, editors. *Wound care essentials*. Springhouse, PA: Lippincott, Williams & Wilkins; 2004.
2. Bryant R. Skin pathology and types of damage. In: Bryant RA, editor. *Acute and chronic wounds: nursing management*. St Louis: Mosby; 2000.
3. Davies B. The reform of community and long-term care of elderly persons: an international perspective. In: Scharf T, Wenger GC, editors. *International perspectives on community care for older people*. Aldershot: Avebury; 1995.
4. International Association of Gerontology. *Adelaide Declaration on Aging*. *Australas J Aging*. 1998;17(1):3-4.
5. Department of Health. *Modernizing social services: promoting independence, improving protection, reviewing standards*. London: The Stationery Office; 1998.
6. Hanford L, Easterbrook L, Stevenson J. *Rehabilitation for older people: the emerging policy agenda*. London: King's Fund; 1999.
7. Nolan J. Improving the health of older people: what do we do? *Br J Nurs*. 2001;10(8):524-8.
8. Audit Commission. *First assessment: a review of district nursing services in England and Wales*. London: Audit Commission; 1999.
9. Le Lievre S. The management and prevention of incontinence dermatitis. *Br J Nurs*. 2001;6(4):180-5.

10. Docherty C, Hodgson R. Skin disorders. In: Alexander MF, Fawcett JN, Runciman PJ, editors. *Nursing practice: hospital and home, the adult*. Edinburgh: Churchill Livingstone; 2000.
11. Bale S, Harding KG. Chronic wounds 3: pressure ulcers. In: Bale S, Harding K, Leaper D, editors. *An introduction to wounds*. London: Emap Healthcare; 2000.
12. Wysocki AB. Anatomy and physiology of skin and soft tissue. In: Bryant RA, editor. *Acute and chronic wounds: nursing management*. St Louis: Mosby; 2000.
13. Swaffield J. Continence. In: Alexander MF, Fawcett JN, Runciman PJ, editors. *Nursing practice: hospital and home, the adult*. Edinburgh: Churchill Livingstone; 2000.
14. Haggard V. Strong developments. *Nurs Times*. 2000;91:33.
15. Willis J. Outreach for prevention. *Nurs Times*. 1996;92.
16. Royal College of Physicians. *Incontinence: causes, management and provision. A report from the royal college of physicians*. London: RCP; 1995.
17. Donald I, Cope B, Roberts S. Nursing care and care homes—a census view. *J Community Nurs*. 2002;16(8):14–5.
18. Johanson JF, Lafferty J. Epidemiology of faecal incontinence. The silent affliction. *Am J Gastroenterol*. 1996;91(1):33–6.
19. Cutting KF. The causes and prevention of maceration of the skin. *J Wound Care*. 1999;8(4):200–1.
20. Hampton S, Collins F. SuperSkin: the management of skin susceptible to breakdown. *Br J Nurs*. 2001;10(11):742–6.
21. Fiers SA. Breaking the cycle: the etiology of incontinence dermatitis and evaluating and using skin care products. *Ostomy Wound Manage*. 1996;2(3):33–43.
22. Leyden JJ, Katz S, Stewart R, Klingman AM. Urinary ammonia and ammonia producing microorganisms in infants with and without diaper dermatitis. *Arch Dermatol*. 1997;113(12):1678–80.
23. Berg RW. Aetiology and pathophysiology of diaper dermatitis. *Adv Dermatol*. 1986;3:75–98.
24. Kemp MG. Protecting the skin from moisture and associated irritants. *J Gerontol Nurs*. 1994;20(9):8–14.
25. Andersen PH, Bucher AP, Saeed I, et al. Faecal enzymes: in vivo human skin irritant. *Contact Dermatitis*. 1994;30:152–8.
26. Cameron J, Powell S. Contact dermatitis: its importance in leg ulcer patients. *Wound Manage*. 1992;2(3):12–3.
27. Agency for Health Care Policy and Research. *Urinary incontinence in adults: acute and chronic management. clinical practice guideline number 2 (1996 Update)*. AHCPR Publication No 96–0682; 1996.
28. Gfatter R, Hackl P, Braun F. Effects of soap and detergents on skin surface pH, stratum corneum hydration and fat content in animals. *Dermatology*. 1997;195:258–62.
29. Bale S, Tebble N, Jones VJ, Price PE. The benefits of introducing a new Cavilon skin care protocol in patients cared for in nursing homes. *J Tissue Viability*. 2004;15:3.
30. Kirsner RS, Froelich CW. Soaps and detergents: understanding their composition and effect. *Ostomy Wound Manage*. 1998;44(3A Suppl):62S–9S.
31. Janning B, Lutz JB. Measuring skin barrier washing-off resistance. In: *Proceedings of the 7th European conference on advances in wound management*. London: EMAP Healthcare Ltd; 1997.
32. Lewis-Byers K, Thayer D, Kahl A. An evaluation of two incontinence skin care protocols in a longterm care setting. *Ostomy Wound Manage*. 2000;48:1244–51.
33. Drinkwater SL, Smith A, Sawyer BM, Barnard KG. Effect of venous ulcer exudates on angiogenesis in vitro. *Br J Surg*. 2002;89(6):709–13.
34. Wysocki AB, Staiano-Coico L, Grinnell F. Wound fluid from chronic leg ulcers contains elevated levels of metalloproteinases MMP-2 and MMP-9. *J Invest Dermatol*. 1993;101:64–8.
35. Trengrove N, Langton SR, Stacey MC. Biochemical analysis of wound fluid from non-healing and healing chronic leg ulcers. *Wound Repair Regen*. 1996;4:234–9.

36. Bishop SM, Walker M, Rogers AA, Chen WYJ. Importance of moisture balance at the wound-dressing interface. *J Wound Care*. 2003;12(4):125–8.
37. Cutting KF, White RJ. Maceration of the skin and wound bed 1: its nature and causes. *J Wound Care*. 2002;11(7):275–8.
38. Newton H, Cameron J. Skin care in wound management. A clinical education in wound management booklet. Holsworthy: Medical Communications UK; 2004.
39. Riemenschneider KJ. Prevention of pressure injuries in the operating room: a quality improvement project. *J Wound Ostomy Continence Nurs*. 2018;45(2):141–5.
40. National Institutes of Health. Improving end-of-life care. State-of-the-science conference statement. Bethesda, MD: NIH, December 6–8, 2004. <http://consensus.nih.gov/2004/2004EndOfLifeSOS024html.htm>. Accessed 28 June 2011.
41. Chaplin J. Valutazione del rischio di piaghe da decubito in cure palliative. *J Tissue Vitalità*. 2000;10(1):27–31.
42. Galvin J. Una verifica dell'incidenza dell'ulcera da pressione in un ambiente di cure palliative. *Int J Palliat Nurs*. 2002;8(5):214–21.
43. Reifsnnyder J, Hoplamazian L. Incidenza e prevalenza di ulcere da pressione in hospice. *J Palliat Med*. 2005;8(1):244.
44. National Pressure Ulcer Advisory Panel and European Pressure Ulcer Advisory Panel. Prevention and treatment of pressure ulcers: clinical practice guideline. Washington, DC: National Pressure Ulcer Advisory Panel; 2009. [www.epuap.org/](http://www.epuap.org/). Accessed 30 June 2011.
45. Gardner S, Frantz RA, Park H, Scherubel M. The interrater reliability of the clinical signs and symptoms checklist in diabetic foot ulcers. *Ostomy Wound Manage*. 2007;53(1):46–51.

---

## Additional Reading

- Bergstrom N, Bennett MA, Carlson CE, et al. Treatment of pressure ulcers. Clinical practice guideline, No. 15. Rockville MD: US Department of Health and Human Services. Public Health Service, Agency for Health Care Policy and Research. AHCPR Publication No 95–0652; 1994.
- Jeter KF, Lutz JB. Skin care in the frail, elderly, dependent, incontinent patient. *Adv Wound Care*. 1996;9(1):29–34.
- Korting HC, Kober M, Mueller, et al. Influence of repeated washings with soap and synthetic detergents on PM and resident flora on the skin of forehead and forearm. *Acta Derm Venereol*. 1987;67:41–7.
- Rottman WL, Grove G, Lutz JB, et al. Scientific basis of protecting peri-wound skin. In: Proceedings 3rd European conference in advances in wound management. London: Macmillan; 1994, p. 38–40.





# Pressure Ulcers in Pediatric Patients

# 10

Guido Ciprandi, Teresa Oranges,  
and Anna Barbara Schluer

---

## Introduction: An Old But Recent Story

Pressure ulcers (PUs) are a common and highly relevant professional care issues in hospitals. They are associated with psychological and physical suffering, increased morbidity and mortality rate and higher costs for health care worldwide. Through large-scale, nationwide epidemiological studies, the prevalence of PUs in medical care institutions for adults is now known and well documented [1–9].

While the problem of PUs in adults has received a great deal of attention, far less is known about PUs in neonates and children. Recent studies have indicated that PUs are also common in the pediatric population, and in the last 10 years greater attention has been paid to this problem. There is greater awareness that pediatric patients in certain health care settings are also at high risk of developing PUs [10, 11]. Prevalence rates for PUs in hospitalized pediatric patients range from 3 to 35% [10]. Two cases of pediatric patients are presented in Box 10.1.

Figs. 10.1 and 10.2

---

G. Ciprandi (✉)  
Bambino Gesù' Children's Hospital, Rome, Italy

T. Oranges  
Department of Dermatology, Santa Chiara Hospital, University of Pisa, Pisa, Italy

A. B. Schluer  
University Children's Hospital, Zurich, Switzerland  
e-mail: [barbara.schlueer@kispi.uzh.ch](mailto:barbara.schlueer@kispi.uzh.ch)

**Box 10.1****Case of Celia**

Celia was born after 33 weeks of gestation. Two hours after birth her condition changed to critical due to insufficient breathing. It was unclear if this was due to her preterm birth or to other influences, and she was intubated and transferred to a neonatal intensive care unit (NICU). After admission to the NICU a Relaxatio diaphragmatica was diagnosed, this necessitated a thoracotomy and tightening of the diaphragm within the first 36 h of Celia's life. About 72 h after first nasal intubation to support the mechanical ventilation, Celia's condition was stable. The fixation of the nasal tube was routinely checked and refixed. At this point a severe skin breakdown on her nose, diagnosed as a category 3 PU, was assessed. The tube was fixed without pressure or shear to the alinasal or nasal septum, providing the greatest possible relief from the tube. The PU demarcated within the following 2 days. After extubation, the PU was treated three times a day with pure hydrogel without any secondary dressing. This made it possible to assess any changes in the skin immediately; further, the hydrogel provided the necessary fluid to the intact skin and protected the skin breakdown with a thin layer. Ten days after the first diagnosis of the category 3 PU, part of the necrosis peeled off, followed by a total peeling of the necrotic skin at day 20 of Celia's life. After discharge at the age of 28 days, a slightly visible already light and elastic scar could be seen. At the age of 6 months no visible scar could be seen on Celia's nose and she had no further limitations due to breathing. This case presents a typical localization of a PU in a pre-term neonate as well as effective wound therapy with unusual but positive effects, meeting the special needs of these vulnerable patients. Not only could Celia's skin be kept intact, but also the requirements of treating the category 3 PU could be met, and Celia was not affected by any unnecessary substances from wound dressings.

**Case of Tiziano**

Tiziano was 10 years old when, suffering from fulminating septicaemia, he was in very critical condition. He was mechanically ventilated and treated with extracorporeal membrane oxygenation (ECMO) due to insufficient cardiac function for 10 days. He lay on a polyurethane foam mattress, but due to his unstable and critical condition, no regular position changes could be carried out. When ECMO was turned off at day 15 after hospital admission, several occipital PUs were diagnosed. Four of them were necrotic and diagnosed as category 3 PUs, two of them as category 2 and one as a category 1 PU. No active treatment for any of these PUs were performed, although they were carefully assessed for any changes or signs of infection. Four weeks after first diagnosis the largest PU presented as a 4 × 3 cm necrosis, which peeled off and presented as granulation tissue. Due to Tiziano's on-going dialysis at this time and continuous high-dose immunization, wound healing was delayed. In consideration of all these factors an appropriate wound treatment was chosen and was changed twice a week. After another 4 weeks the wound completely healed with alopecia the size of a one-euro coin. Neither Tiziano nor his family were affected by the scarring at the time, and they were informed that a surgical intervention could be performed at a later point.

**Fig. 10.1** Celia's PU on day 10



**Fig. 10.2** One of Tiziano's PUs 2 months after admission to the pediatric intensive care unit



---

## The Pediatric Patient and Its Challenges

“The United Nations Convention on the Rights of the Child defines a child as “a human being below the age of 18 years”. Within this time period one distinguishes between neonate, infants, toddlers, preschool child, school child and adolescent. A neonate is defined as a child from birth up until its first 30 days of life. This includes preterm neonates, which means neonates born before 38 weeks of gestational age. Children born after 37 weeks of gestational age are categorized as term-born neonates. A newborn is a neonate within his first hours of life. An infant is a child in the time period from the age of 4 weeks up to its first birthday, followed by toddlers, which are children from the age of 1 up to their third birthday. A preschool child is between 3 and 5 years old, a school child between 6 and 12 years of age; adolescence covers the time from 12 up to the 18th birthday (ICD 10, Version 2010 (P05-P08)) (Table 10.1).

**Table 10.1** Pediatric heterogeneous age

Nearly adult	16–18 years
Adolescent	12–16 years
Teen	8–12 years
Young school	5–8 years
Preschool	3–5 years
Toddler	12–36 months
Infant	Up to 12 months
Newborn	0–30 gg
Preterm	Before 38 gestational week
Low birth weight <sup>a</sup>	
Very low birth weight <sup>b</sup>	
Extremely low birth weight <sup>c</sup>	
Small for age <sup>d</sup> (or small-for-dates or small-and-light-for-dates)	

From: *International Statistical Classification of Diseases and Related Health Problems tenth Revision—ICD 10, Version 2010 (P05–P08)*

<sup>a</sup>**Low birth weight (LBW)** is defined as a birth weight of a liveborn infant of less than 2500 g regardless of gestational age

<sup>b</sup>**Very low birth weight (VLBW)**, which is less than 1500 g

<sup>c</sup>**Extremely low birth weight (ELBW)**, which is less than 1000 g

<sup>d</sup>**Small for Gestational Age**, usually referred to as weight and length below 10th centile for gestational age

It should be kept in mind that pediatric patients, in comparison to adults, are in widely differing health conditions. The overall health status of children is generally better and multi-morbidity is limited to a small percentage of patients, like very low term neonates (born before 32 weeks of gestation age), newborns with congenital abnormalities, cromosomopathies, perinatal distress syndrome or children with chronic conditions. Survival rates of both critically and chronically ill neonates, infants and children have improved dramatically in recent years, introducing new challenges for medical and nursing care. Furthermore, new devices, ECMO, long lasting surgical procedures (LLSP) and advanced therapies in critical areas of admittance requires much more attention in order to prevent pressure-related ulcers [12].

## The Skin in Pediatrics: From Fetus to Newborn

Children's skin undergoes several changes throughout the first 18 years of life. The most important function of the skin is to protect against water loss, absorptions of noxious substances, intrusions of microorganisms and physical trauma. The skin of children is morphologically and functionally different from adult skin. Within the first days of life neonates undergo various adaptation processes needed to accommodate the transition from the wet intrauterine environment to the dry outside environment. During the first months and years the skin continues to develop and evolve its structure and functions (Tables 10.2, 10.3 and 10.4).

**Table 10.2** Skin developmental stages

1. Embryonic period	5–8 weeks
2. Embryo-fetal transition	9–10 weeks
3. Early fetal period	11–14 weeks
4. Middle fetal period	15–20 weeks
5. Late fetal period	Up to 21 weeks

In the Late Fetal Period Skin becomes functional, develops stratum corneum (earlier than other species), a skin barrier activity appears, there is a basal layer expansion and a periderm disaggregation. The number of skin layers increase from 3, 28 gw, up to 15 layers, 32 weeks of gestation

(Courtesy of Ciprandi G and Boldrini R, Bambino Gesu' Children's Hospital, Rome, Italy)

**Table 10.3** Skin features in neonatal age

- Underdevelopment of subcutaneous fat tissue
- Less of cohesion between epidermis and dermis
- Dermal instability
- Alkaline skin surface
- From aquatic to aerobic
- Fat, Zincum and metallic deficiencies
- Increased risk for traumas (shearing and friction forces)
- Reduced calories storage
- Reduced insulation and loss of surface temperature
- Reduced secretions and sebum production (the mechanical coat protection)

**Table 10.4** Skin host defence in neonatal age

- Bacterial count on skin surface from 1.000.000 up to 10.000.000
- Number of bacterial species recognized: More than 100
- IgA reduced from 108–12, to 105
- Microvascular network, from  $\mu^4$  to  $\mu^2$  (reduced volume of the capillary boundles)
- Immature granulocyte neutrophils (GN) 30% (versus 10% to 15%)
- Number of skin macrophages (M) 25%–40%
- Reduced number of myeloid progenitor stem cells
- Reduced adhesion of GN and pseudopodal activity of M

(Courtesy of Ciprandi G and Boldrini R, Bambino Gesu' Children's Hospital, Rome, Italy)

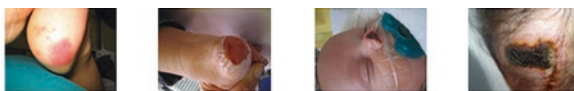
The unique physiological needs of children with regard to skin first require some explanation. Physiologically, fluid and electrolyte disturbances occur more frequently and develop more rapidly in infants and young children than in older children and adults. The higher proportion of water content and greater relative surface area of young bodies increases the risk of dehydration under the metabolic demands associated with fever. Skin cells that are not well perfused may be hypoxic and are at risk of breaking down even with minimal trauma.

It is known that any skin breakdown, especially in critically ill neonates and infants, increases the risk of septicemia as well as related severe complications and higher mortality. Pressure ulcers also cause an increase in pain, infection and calorie expenditure in pediatric patients and therefore it is of great importance to avoid any damage to the fragile skin of pediatric patients.

### Pressure Ulcer: Definition Including Particular Specializations in Children (Preterm/Newborns)

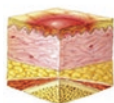
A PU is a localized injury to the skin and/or underlying tissue as a result of pressure, or pressure in combination with shear forces. (National Pressure Ulcer Advisory Panel (NPUAP) and European Pressure Ulcer Advisory Panel (EPUAP), 2014) (Fig. 10.3).

According to the guidelines of NPUAP and EPUAP (National and European Pressure Ulcer Advisory Panels), PUs are differentiated into four different categories, with category one being the least severe, and defined as “intact skin with non-blanchable redness of a localized area usually over a bony prominence” and category four the worst, being defined as “full thickness tissue loss with exposed bone, tendon or muscle” [13]. These EPUAP/NPUAP categories are also used frequently in pediatric settings [10, 14]. To what extent these PU etiologies are true for pediatric patients and whether there are any differences in classifying PUs in pediatric patients according to adult categories has not been studied so far and is thus unknown. In more recent times we strongly advocate a more modern and physiological definition for a Pediatric Pressure Ulcer, which is identified as a “Localised area of tissue destruction and death due to a *compression* of soft tissues between a *bone’s* or a *bone’s-like* prominence and an *external* or a “*self*” surface - *pertinent to the body itself*, for a “*short*” time” [15].

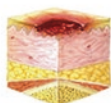


- A pressure ulcer is a localized injury to the skin and/or underlying tissue as a result of pressure, or pressure in combination with shear forces.

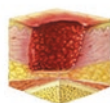
- 4 Categories:



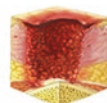
Category 1



Category 2



Category 3



Category 4

**Fig. 10.3** Pressure ulcer in pediatric patients

## Risk Factors and Risk Assessment Scales

The tissue tolerance of a person is an intermediate variable and not a causal factor in the development of PUs. How high the pressure must be and how long it must be maintained to cause skin damage depends on the individual's tissue tolerance [16]. "The tissue tolerance of an individual is influenced by two major components—the tissue tolerance for pressure, meaning the capacity of the tissue to redistribute pressure—and the tissue tolerance for oxygen, meaning factors that influence oxygen distribution within the tissue and the oxygen need of the tissue" ([16], p. 211). Tissue mass, patient age, nutritional status and dehydration, medications and mental and physical condition of the patient, body temperature and co-morbidity are relevant determinants which influence tissue tolerance [16], [17]. In pediatric patients skin breakdown is a common topic and it is not the same as an pressure ulcer. Maintaining skin integrity in pediatric patients is difficult because of patients vulnerability, acuity and the highly invasive interventions and therapies they receive (Table 10.5).

Potential risk factors for PUs are immobility and decreased skin sensitivity [18]. These are well known risk factors for adult patients with some evidence that in pediatric patients these risk factors increase the risk of pressure ulcer development as well [18]. With regard to the pediatric patient, sick children in general, but also due to limited communication skills, neonates, infants and toddlers, disabled and neurologically impaired children, seem to be at particular risk of developing pressure ulcers.

Further, several risk factors with regard to external devices are known for pediatric patients. The consequences of immobility and decreased skin sensitivity and risk

**Table 10.5**

Anatomophysiological features of the pediatric skin

• Serum albumin levels (<2.5 mg/dL)
• < Protein, arginin, A, C, Zn
• No acid mantle (pH >5.5)
• Thinner dermis (1–10 times <)
• Reduction in water content
• Reduced sebum production
• Immature sweat for temperature regulation
• Infant skin absorbs and loses water faster
• Reduced amount of natural moisturizing factor
• Stratum corneum less than 70%
• Suprapapillary epidermis less than 80%
• Infant corneocytes and granular layer keratinocytes are smaller due to high cell turnover rates
• Skin microflora alteration (>TEWL)
• Delayed full functioning of melanocytes
• Intensity of pression: capillaries collapse 23 mmHg
• Duration of pressure without hystological damages: less than 90'

factors related to equipment such as tubes, IV catheterization and CPAP have been described [19]. Especially patients in pediatric intensive care units (PICU) are at increased risk for skin failure. Here the pressure of tubes in oscillation and extracorporeal membrane oxygenation as well as the decreased tissue tolerance in these patients due to their critical condition makes these children most vulnerable [20]. The need for additional medical and therapeutic aids, such as wheelchairs, unadjusted orthoses and prostheses [21] are known risk factors for pressure ulcer development in children as well [15].

A problem limited to neonates is their immature skin with regard to the friable skin and circulatory system, which leads to extravasation, or skin failure due to strapping or tubing or monitoring sensors [22, 23].

Despite the known risk factors, a reliable and valid PU risk assessment tool with validated cut-off points, applicable to a wide range of the juvenile population from neonates to adolescents, is still not available. Many of the available assessment tools, like the Braden-Q scale, are modifications of PU risk scales for adults and include variables deemed especially important for PU development in the adult population, e.g. mobility, incontinence, moisture, and nutrition. The relevance and clinical effectiveness of specifically pediatric PU risk scales has not so far been investigated. An example of a pressure ulcer risk assessment tool used in daily clinical practice is the Bambino Gesù' Children's Hospital Skin Assessment Tool (Table 10.6).

Medical devices on the skin are the predominant risk factor for PU occurrence in pediatric patients [18], [19, 23]. With regard to neonates and infants, in whom mechanical ventilation support devices have shown to be the major risk factor, this was also reported in the studies of Schindler et al. [20], Curley et al. [19] and Boesch et al. [24].

**Table 10.6** The Bambino Gesù' children's hospital assessment tool

Category	0	1	2
1. <b>Age</b>	<1 mos	<1 yr	>1 yr
2. <b>Admittance</b>	NICU-PICU	CTS, NS	Others
3. <b>Class of pathology</b>	Rare disease	Syndrome	No C.I.
4. <b>Weight</b>	<1.000 kg	<2.00 kg	>2.00 kg
5. <b>Mobility</b>	I. With M.I.	Without M.I.	Normal
6. <b>Dermatitis</b>	Grade III	Grade II	Grade I
7. <b>Oedema</b>	High	Moderate	Limited
8. <b>Multiple devices</b>	Up to 5	3 to 5	1 or 2
9. <b>Biometry</b>	Up to 3 points	1 to 3 ps.	None
<b>Score</b>	<b>Risk</b>	<b>Assessment</b>	
<b>1 to 3</b>	High	Every 8 hrs	
<b>3 to 6</b>	Intermediate	Daily	
<b>7 to 11</b>	Low	Every 3 days	
<b>12 and &gt;</b>	No risk	If score <	

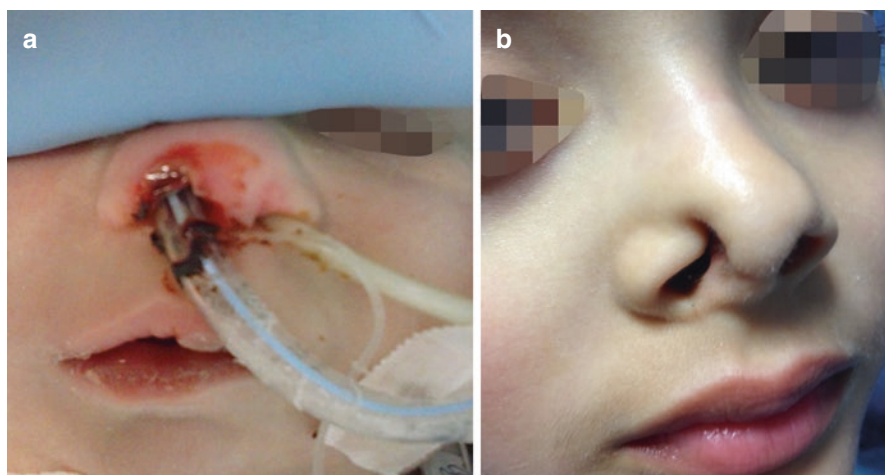
*NICU-PICU* neonatal/pediatric intensive care unit, *CTS, NS* cardiothoracic surgery, neurosurgery, *M.I.* metabolic instability



Younger age can also be considered as major PU risk factor in pediatric patients. Curley et al. [19], Schindler et al. [20], McCord et al. [25]. Due to their developmental status, young pediatric patients (under the age of 5 years) are, unable to differentiate pressure from other sensory perceptions of such devices properly and therefore are most vulnerable.

Regarding the localization of PUs, the feet and nose are the most commonly affected areas in pediatric patients. The feet, especially ankles or heels and toes, were also frequently affected areas in the study of Curley et al. [19], as were the occiput and ear. A possible explanation for this is that in neonates and infants monitoring devices like oxygenation sensors and IV catheters are fixed to the feet of the child [26, 27]. PUs in the area of the nose are often caused by a nasogastric feeding tube, ventilation tube or by a CPAP mask with prongs [28]. In those cases, the prolonged decubitus of the device induce an erosion of the skin and a subsequent damage of the hyaline cartilage of the nose. The permanent loss of the cartilage is the fatal result with a dramatic disfigurement and a permanent lesion (Fig. 10.4a, b).

With regard to the risk factors, medical devices, especially mechanical ventilation support devices, a PICU stay, younger age and limited nutrition and activity were the major risk factors. In the development of risk assessment tools for the pediatric population, the risk factor “devices on the skin” has only become part of such scales since 1998 [29]. PICU stay and younger age as risk factors are not part of a pediatric risk assessment scale. We can conclude that the use of risk assessment scales in pediatric health care should focus specifically on external medical devices and on limited mobility and activity. Risk assessment scales for adults are not precise enough to cover all relevant pediatric risk factors. According to our findings, and in line with clinical expertise in the field of PU development in children, it is



**Fig. 10.4** (a) decubitus of the nasogastric tube, with bleeding and cartilage of the nose becoming ischemic (b) 5 years later: sequelae of the cartilage destruction because of the device and needs for plastic reconstructive surgery

more reliable to focus on different pediatric risk populations, and also to assess device related factors contributing to the development of PUs.

---

## Preventive Interventions: Prevention and Rehabilitation

Pressure ulcer prevention is multifaceted and requires skills, knowledge and consistency in medical and nursing practice. Risk assessment, skin assessment, repositioning and pressure relief are integral components of effective prevention of PUs in children [22]. The preventive measures taken for children are often those recommended for adult patients [23]. Baharestani and Ratliff [14] have highlighted the importance of specific age-related preventive strategies. Preventive measures should meet the individual needs of each child and therefore, with regard to preventive measures, special attention must be paid to neonates and infants [23]. Basically, the prevention in pediatric patients must be aggressive: skin breakdown is in ambush because of the skin thickness, the high risk for tears, the reduction of dermal capillaries, the evenience of physiological or pathological urinary tract, fecal and salivary incontinence. At last but not least there is an increase in the number and species of skin-surface pathogens and babies aged less than 1 year are immunocompromised, because of an immature immunological system.

Various preventive measures based on the clinical experience of nursing experts in the care of children are known and used. However, no research based preventive measures with regard to special pediatric needs have been established. The preventive measures described for children are skin care, pressure-relieving facilities (sheep skin, silk sheets and gel or water pillows for neonates; special pressure-relieving mattresses for older children [23], and regular turning of the child/neonate [23]. With regard to neonates it seems most important to meet the baby's need with regard to its immature skin [23]. Timely skin assessment is recommended but no frequency is described; such assessment includes examining the skin for evidence of new damage.

Repositioning should be performed regularly in immobile patients and should pay special attention to the relevant anatomical localizations in children, which are the occipital, sacral, and calcaneal areas [22]. Repositioning is not recommended for hemodynamically unstable patients. Next to manual repositioning, therapeutic pressure-relieving surfaces may also be required [22]. The range of available support surfaces for children is limited [22]. Foam mattresses aim to redistribute body weight and the movement of a child is only slightly limited [22]. Alternating air systems often do not fit well in children. The active and spontaneous movement of a child is limited in an alternating air system mattress and the lower weight or size of a child will increase the risk that a child lays between the effective parts of such devices [22]. The cells of such mattresses, which are fitted for adults, are described as being too large for children, and pediatric-specific mattress systems are not very common [30].

Many PUs in neonates and children develop along medical devices [18, 22]. No specific preventive measures with regard to this fact are available today.

Preventive measures targeting medical devices are most frequently performed in pediatric patients to decrease the risk of PU occurrence [28]. This is in line with the

fact that these devices are THE major risk factor for PU occurrence in pediatric patients and that pediatric patients treated in PICUs are a high-risk group.

To the best of our knowledge no study assessing preventive measures to decrease PU risk and prevalence in the pediatric population is available today.

Total skin assessment, repositioning and skin care were conducted frequently as preventive measures in our studies [28]. With regard to different skin condition in different age groups, like the immature skin of neonates (especially preterm neonates), regular head to toe skin assessment and appropriate skin care seem important as preventive measures to decrease PU risk in pediatric patients. In order to a better understanding of the relationship between a device and a related ulcer we recognize different preventive strategies based on device *Categories*, *Body sites* and *Severity*, as shown in Table 10.7.

The use of pressure related surfaces is not very common in pediatric patients. Devices especially adapted to pediatric needs, like small sizes for lower weight, are not widely available [22, 30]. However, many advices are strongly advocated as evidence based tools, in order to reduce the undue numbers of complications associated to high-teck devices (Table 10.8).

Since 2014 two guidelines highlight preventive intervention (NICE, 2014, NPUAP/EPUAP, 2014) for effective PU preventive measures with special attention to the pediatric population and their unique risk factors in terms of PU occurrence.

Examples of pediatric specific pressure ulcer prevention are the underpadding of any medical devices (Figs. 10.5, 10.6, 10.7 and 10.8):

**Table 10.7** Devices and device-related preventive strategies

Device-related PUs prevention	
<i>Devices: categories</i>	
• Dressing	(appropriate and adherent)
• Materials (cast, corset)	(indirect contact, inspection)
• Adhesives and Glues	(avoidance or silicon film in between)
• Metallic devices	(frequent rotational protocol)
• Stitches	(proper removal-time)
<i>Devices: body site</i>	
• Probe SpO <sub>2</sub>	(Toe, feet)
• Mask	(Nose-Bucca)
• OTT—NTT	(Nose-Bucca)
• Tracheostomy	(Trach site)
• ArterialVenous line	(Possible extravasation syndrome)
• Peristomal areas	(abdominal wall)
• External genitalia	(Catheter)
<i>Devices: severity of the site and related disease</i>	
• Cspinal Shunt	(head and neck, vital structures, infections)
• Gastrostomy	(perilesional skin, prolaxu)
• Ileostomy	(caustic fluids)
• CVC	(hematogenous spread, sepsis, loss of the a-v line)

**Table 10.8** Device health policy

1. Adjust the rotational protocol to the body size
2. Proper fixation of catheters
3. Reduce material's density\*
4. Favor tools with low biological memory (**bioflexibility**)
5. Undervalue size/caliber
6. Prevent skin surface breakdown/infection (**pressure-preventing device**)
7. Protect tutorial skin-contact
8. Provide for indirect pression of stoma-device
9. > quality of specialist car

\*Material Density:  $\text{kg}/\text{dm}^3$

Silicon:	0.6–0.8
Silicon Rubber:	1.12–1.14
Nylon:	1.04–1.50
PVC:	1.3–1.4
Rubber:	1.7–2.2
PTFE (Teflon):	2.2
Polyurethanes:	1.8–2.5
Steel:	*7.85

**Fig. 10.5** Examples for medical device related specific Heel pressure ulcer prevention



**Fig. 10.6** Examples for medical device related specific Heel pressure ulcer prevention



**Fig. 10.7** Examples for medical device related specific Heel pressure ulcer prevention



**Fig. 10.8** Examples for medical device related specific Heel pressure ulcer prevention



---

## Prevalence and Incidence

Prevalence rates for PUs in hospitalized pediatric patients range from 3 to 35% [10]. The rather high prevalence of PUs in children makes it a relevant care problem for this target population.

Pediatric patients hospitalized in the PICU setting are most often affected by a PU (44%). This is in line with a prior study of Escher-Neidig et al. (1989), which assessed a PU prevalence of 40% in PICU patients after heart surgery. Prevalence rates for neonates and infants appear to vary between 26% [31] and 61.5% [32].

Most pediatric patients are affected by a category 1 PU and severe PUs are limited to older pediatric patients. Most category 1 PUs are reversible. Several authors have therefore recommended defining pressure ulcer prevalence by starting the category system at category 2 [16, 33], and to consider a category 1 PU as the most important risk factor for developing a higher category of PUs [11, 16, 34]. Following this line of reasoning would implicate that many pediatric patients are in fact at high risk.

Yet, the overall prevalence rate of category 2 and higher varies between 3%.-5.1% [26, 27, 32]. This means that the progression to a higher category PU in fact seems to occur rather infrequently.

**Table 10.9** Common localizations of pressure ulcers in pediatric patients (0–18 years)

Along medical devices (> 50%)
Feet especially heels/calcaneus
Face (especially nose) most common site in patients under 1 year of age
Hands
Occiput (highly prevalent in PICU setting in patients with critical life condition and under mechanical ventilation)
Sacrum (most common in older patients (older than 8 years) and with chronic conditions)
Shoulders and Toes

Nevertheless the diagnosis of a category 1 PU requires appropriate preventive intervention.

As described in the literature, a comparatively high proportion of surgical patients, especially patients after orthopedic treatment or patients with cerebral palsy and spinal cord lesions showed category 3 and 4 PUs and were older than 8 years of age. This leads to the assumption that especially older pediatric patients with chronic conditions may be affected by more severe PUs.

Most common localizations of pressure ulcers in pediatric patients differ from those of adults and are presented in Table 10.9.

## Wound Treatment in Pediatric Patients

Epidemiological studies and empirical evidence report that the most common wound types in pediatric patients include epidermal stripping, extravasation injuries, surgical wounds, incontinence associated dermatitis, chemical and thermal injuries, wounds secondary to congenital abnormalities and pressure ulcers [14], [35] Table 10.10. We must remember that Pressure Ulcer in a Child is a complex wound in a complex patient.

Wound care in pediatric patients needs to take account of several relevant differences from care in adult patients [36]. The most important fact is that wound treatment should avoid any further harm to the fragile skin in children of all ages.

There are a number of guidelines for wound treatment in adult patients regarding both the treatment of PUs as well as wounds in general [13]. No specific guideline for wound treatment in pediatric pressure ulcer wounds is available today. Up until now, there has been a lack of knowledge and research to guide clinical practice in the field of treatment of PUs in pediatric patients [37].

The use of any dressing in pediatric patients must rely on a clear goal for the intended treatment, with consideration of potential critical aspects like further harm or trauma. In addition, any dressing use in pediatric patients must protect the skin from further harm, like epidermal stripping. But how to proceed in the treatment? As in adult patients, the wound bed preparation and the debridement is the first action in order to increase the possibility for a pediatric ulcer to definitely heal.

## Debridement in Pediatric Patients

Wound debridement in children is an integral part of chronic-wound management and practitioners involved in wound care must be fully competent at wound-bed assessment and have an awareness of the options available for debridement. Before any other treatment, the wound bed must be prepared with a proper debridement which gives the clinician the advantage of accurately assessing the severity and extent of the wound. *Autolytic debridement (AD)* is selective and only necrotic tissue is liquefied. It is also virtually painless for the child. AD can be achieved with the use of occlusive or semi-occlusive dressings which maintain wound fluid in contact with the necrotic tissue. In pediatric patients is advisable the use of thin and transparent hydrocolloids cut no more than 2 cm other than ulcer borders, otherwise you could have a peri-wound maceration. The perilesional skin must be prepared with protective barrier spray, fragrance-, preservative- and alcohol free. Alginate hydrogels are not of some advantage with respect to amorphous types. The frequency of dressing changes varies from daily to every 4 days depending on the age and pressure location: frequent changes are required for newborn and infants affected by ear, occipital, malleolar and spinal ulcers. Transparent films may fit these prerequisites: moisture vapor permeable, conformable and extensible, true barrier effect to outside contaminants, easy to be removed and easy to handle and shaped. AD is used with light to moderate exudate, is very selective, effective, versatile, easy to perform and painless. However is not as rapid as surgical debridement and the occlusive situation must be monitored closely for signs of infection due to anaerobic growth.

*Enzymatic Debridement (ED)* use chemical enzymes recognized as fast acting products that produce slough of necrotic tissue. Some enzymatic debriders are selective, while some are not. The first type is suitable for children older than 3 years of age. Collagenase ointments may fit only the pediatric ulcers sparing the intact skin

**Table 10.10** Different categories of complex wounds in children

• <b>Well known wounds:</b>	62.5%
PU (Newborn, Prem, SFA, LBW, WLBW)	
• <b>Emerging wounds:</b>	<b>37.5%</b>
Graft versus host disease	(GVHD)
Extravasation syndrome	(EXVs)
Acute cancrum oris	(NOMA)
Acquired sting and bite	(AWs)
Posttransplantation wounds	(Open and partial open abdomen)
Device associated wounds	(DAW)
ECMOwounds	(Extracorporeal membrane oxygenation)
Inflam Chr Intestinal Dis	(ICID)
AutoImmune-Ass Ulcers	(AAU)
Rare and other wounds	(ROW)

and may be used to debride both adherent slough and eschar. ED may be used as the first debridement instead of sharp clearing when fragile and bleeding tissues are part of the lesion or when a bleeding disorder is present. In few cases inflammation or discomfort may occur and we prefer to use ED in children aged more than 3 years.

In pediatric patients *surgical debridement (SD)* must be cautious thus avoiding inadvertent tissue damages, vascular break-in and haemorrhage. Particular attention must be paid to a possible infection upgrading and subsequent hematogenous spread (bacterhaemia). The goal is to remove necrotic tissue, biofilm, cluster of bioburden, fibrinous slough, infected firm exudate, clots and excessive hypergranulation. But at the same time we have to spare safe granulation, island of growing epithelium, borders, network of dermal capillary bundles and perilesional skin. Due to a peculiar fragility of the skin the limit between a soft burden and fragile healthier tissues is nearly virtual in pediatric patients.

This poses the basis for a *microsurgical debridement (MD)*. Loops 4.5× or operating microscope (6 up to 26×) should be used. Under visual magnificated control, wide lesions, tenacious eschar, distressful and or infected ulcers could be properly and carefully treated. The purpose of this technique is to perform a “one and not repeated procedure”, avoiding staged debridements. In this way we are sure to reduce the parental anxia and children stress and pain. The MD reduces the interval existing between the healing time and a possible rehabilitation. If we consider disabled children affected by pressure ulcers it's mainly advocated to start as soon as possible a FKT program including hydrotherapy, tutorial adoption and wheelchair systematic use. During the MD deep biopsies of soft tissues could be done for a more pertinent microbiological diagnosis. The ability for a wound to heal is directly proportional to a well-done tridimensional wound bed preparation. The impact of microsurgical technique for pediatric debridement drastically reduced the number of unnecessary procedures done under general anesthesia. At one time the stressful and painful serial sharp debridements used for bedridden patients is now confined to adolescents and nearly adults. In our experience bedside debridements in children is incomplete in 75% in infants and in 63% in hospitalized children. But this percent increase in homecaring pediatric patients, up to 80% whatever is the age. Finally, this “all in one procedure” allows deep biopsies during the MD approach. Tissue biopsy or aspiration sampling of infected tissue is the “gold standard” for culture of skin and soft tissue infection and is especially important in premature and newborn, because of their physiological immunocompromission. Swab cultures are probably the most commonly used method to determine the resistance pattern of skin pathogens treated in nursing home residents. However, they are controversial, especially when obtained from chronic wounds. The culture may be obtained from an uninfected wound and lead to unnecessary antibiotic therapy. If material superficial to the infected living tissue is sampled, colonizers may be isolated. Adequate debridement of pressure ulcers remains paramount to managing the wound, regardless of whether the future plan is for an eventual surgical coverage (flap, graft) or the wound is to heal by secondary intention. In our opinion the final debridement and reconstruction must be done at the same time and not as separate procedures. Current trends favor a single-session surgical action in all children but those affected by polymicrobial or multiresistant infections.



After a satisfactory debridement has been achieved NPWT for PU treatment is highly recommended, in some studies in pediatric patients with, for example, PU wounds as well as acute and chronic wounds with partial and full thickness skin loss and considerable exudation. The advantages of the use of NPWT in pediatric patients are well described in those studies and accurately studied by us.

---

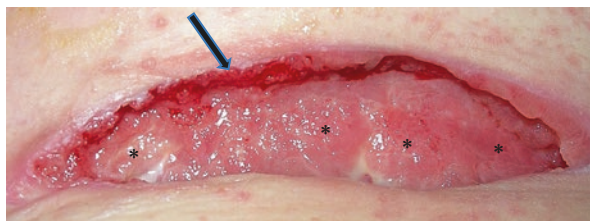
## NPWT in Pediatric Patients

Evangelista Torricelli, 1608—University of Rome La Sapienza, is credited with introducing the first man-made vacuum when he turned over a column of mercury in a glass tube yielding the world's first barometer (and ultimately lending his name to a common unit of air pressure). This was the first example of a Negative Pressure. After 400 years, NPWT in children have to be considered in size and noise no more than a toy, not invasive, to be touched in collaboration with the small patient, no more than a complex dress and with an easy nursing for caregivers. In few words, in Europe this device is considered as a simple and safe procedure for complex pathologies in a challenging heterogeneous age and for patients affected by multiple comorbidities. And what about the child's feeling? The child can attend to the social age-related activities, without interference, he experience a pain relief, he can sleep and live with a nearly normal posture, no more noise rumours, no more bad odours and mother's doesn't get on nerves because of n anxia reduction.

The NPWT is a 3C system, Clean, Clear and Closed. The main actions in pediatric patients are removal of a localized oedema, the exudate suction and management, the improvement in local microvascular and lymphatic flows. In addition, NPWT promotes the angiogenesis increasing granulation tissue formation and at the same time reducing bacterial counts. The NPWT in children is an Ilizarov's like system for soft pediatric tissues. We demonstrated two type of effects in children: biomechanical and biomolecular. In the first case NPWT participate to a Removal of dead-cells and senescent cells from the hedges, exposing cells from able-to-Heal surfaces. In the second phase ther's the activation of quiescent cells and finally the pressure is able to modify the cellular phenotype, inducing the cross-talks and cellular interactions. Stretching effects inducing morphological modifications are pressure conditioned and cells stretched becomes hyperproliferating. The increased cell-cycle activity is clearly visible on the edges and at bottom of the wound (Fig. 10.9). Transmission Electron Microscope studies the morphofunctional expression of tissue viability: increasing number of normal-shaped intracellular organules, perinuclear fine chromatin dispersion and proper visualization of inter-cellular thigh junctions are some examples of a new firm, solid and otherwise well structured neotissue, following the NPWT treatment. (Fig. 10.10). The experience of one of the Authors (GC), after 260 consecutive children treated with the NPWT we did not observe any major complication due to the procedure. 22% of patients were aged less than 1 yr. and the average duration is 16 days. The pressure, in the preferred continuous modality, is from 40 up to 80 mmHg and can reach 100 mmHg in ages over 3 yrs. We use microporous foam in order to avoid inside gauze-growth of granulating tissues. A poor result, no evidence for a reduction, has been noted in

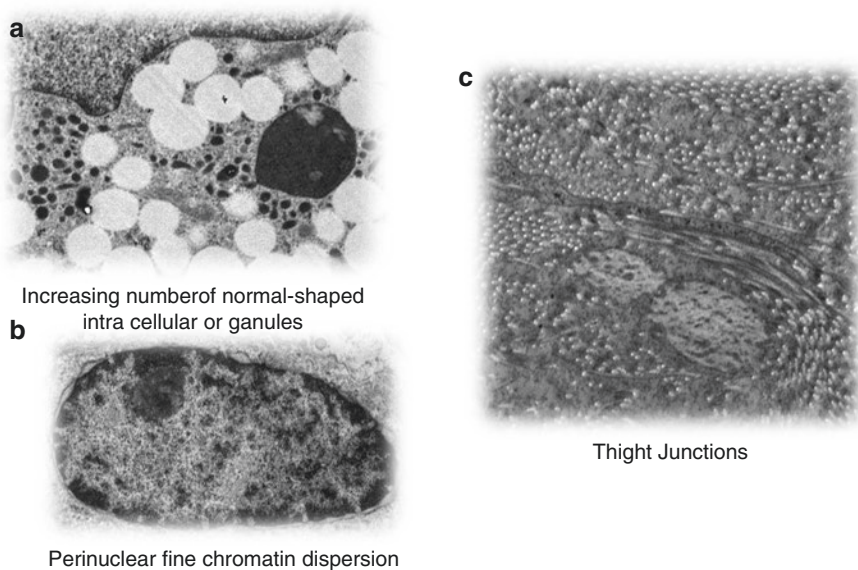
8% of the cases and a delayed primary closure in 7%. Major surgery as for skin grafts (8%), rotational muscle flaps (6% with two propeller flaps) was used only if really necessary and mandatory.

The recent use of simplified-canysterless devices are advisable because of a lot of important improvements. These instruments are ultraportable (70 g or less), no-canyster, single-use, with a fixed negative pressure at a  $-80$  mmHg regimen in continuous, self-powered (2AA lithium batteries) and easy to be used, with just one



- Progressive increase of the pressure (from 40 to 80 mmHg)
- Starting with an intermittent application (first two days)
- Check the wound axis and body position when applying
- Check the device position when positioning

**Fig. 10.9** NPWT of a pressure ulcer in a 9 yr old boy. First change. Arrow is pointing at bordal granulating tissues and \* indicates growing tissue on the bottom of the wound. Main points to be observed when you apply the NPWT in children: (1) Progressive increase of the pressure (from 40 to 80 mmHg) (2) Starting with an intermittent application (first two days) (3) Check the wound axis and body position when applying (4) Check the device position when positioning



**Fig. 10.10** TEM analysis of tissues after 3 cycles of NPWT. Morphofunctional expressions of tissue viability. (a): Increasing number of normal-shaped intracellular organelles. (b): Perinuclear fine chromatin dispersion. (c): Tight Junctions

one button. These tools are allocated for a low treatment period (< 20 days) and the mean dressing-wear-time is reduced to a minimum, not exceeding 15' for one change. Simplified NPWT device is used also in premature patients, in difficult body site such as for spinal lesions. Because they are canisterless, the exudate moves through the pad and a mixed action of absorption and evaporation can manage until 250 mL of wound fluids (Figs. 10.11 and 10.12).



**Fig. 10.11** Stage III pressure ulcer in a newborn aged 24 days of life. The wound affects the malleolar area of the left foot. This lesion was previously treated for 7 consecutive days with a NPWT in another hospital: continuous modality, medium intensity,  $-125$  mmHg of pressure, black foam as a filler. As a result of this too long interval and too high negative pressure regimen, we can see the maceration of the perilesional skin and an hypergranulating tissue with focal areas of bleeding. Despite this high negative pressure, there are some persistent areas of slough yellow colored



**Fig. 10.12** This baby is a candidate for a simplified, canisterless NPWT. In this case a filler is not required, a lower negative pressure not exceeding  $-80$  mmHg is the goal and a thin foam or a thin pad as in this situation can help the wound to heal. We used a PICO system (Smith and Nephew®) with two consecutive changes, after a soft debridement as a first step

It remains a clinical challenge to use dressings which are both appropriate to the goal that has to be achieved in wound healing as well as to the specific pediatric needs, such as the different skin condition in different age categories, small body sites and active patients [14]. In pediatric care there is an urgent need to pediatric specific wound treatment. The use of dressings who prepare wound beds and support a soft debridement are highly recommended. If necessary a microsurgical debridement has to be performed by health care professional which are trained in wound treatment of pediatric patients and which have to knowledge of the special needs in different age groups. It is most important that fear and pain of children had to be avoided from first wound treatment on. Debriding wounds can therefore be done under local anesthesia, under analgesedation or nitrous oxide.

After cleaning the wound a careful assessment of the wound and surrounding tissue has to be performed and any needs to avoid further lesion along the effective wound needs to be considered. In most pediatric pressure related wounds exudate is not a highly prevalent problem. Therefore dressings with regards to the certain amount of exsudate are helpful. Often small and cuttable dressings are preferred to apply them easily in the sometimes small bodysites in younger children.

Needs of dressings for pediatric wound care are presented in Table 10.11 (Fig. 10.13).

**Table 10.11** Needs of dressing used in pediatric wound care

Easy to handle, easy to apply
Save in performance
No limitation of mobility and activity of children
Allow skin assessment of the surrounding skin
Do not affect the fragile skin in neonates, no epidermal stripping
To be adapted in very small areas and body sites
Adequate exudate management
Cutable no fix borders
Long intervals for dressing changes
Painfree dressing changes



**Fig. 10.13** Easy procedure to keep a foam hand-wearable: a protection against device-related injuries

## Surgery

Pressure ulcers continue to pose major challenges to the social and medical community, with the nurse practitioners, pediatric and plastic surgeons at the vanguard of the multidisciplinary management of these wounds. Both pediatric and adult population suffer from these sores. However there are many important differences to take into account in children.

For instance, the surgical management of adult pressure ulcers is disconcerted by high recurrence rates, from 45% up to 70% as reported in literature. In contrast reported outcomes in surgically treated children suggest that recurrence rates are significantly lower (less than 10%). A possible explanation for this is in part due to the best and meticulous selection of pediatric candidates admitted to a surgical program.

Grade I and II Pressure ulcers are often treated conservatively but grade III and IV usually require more aggressive treatment in the form of debridement (sharp type) and possibly flap closure. A major question that each treating surgeon must answer is when should conservative local wound care and debridements be stopped in favor of a covering reconstruction. We believe the ideal candidate for surgery is a compliant child with a wound that is well cared for but has reached a steady-state and is failing to improve: the so called “no-more healing” lesion.

Other pediatric lesions suitable for surgery are represented by: (1) persistent painful wounds which heavily interfere with social activities; (2) severe disabilities complicated from large sores close to the anal region and responsible for a full-day contamination; (3) pressure ulcers over and over again infected by a polymicrobial mutiresistant flora.

These surgical wounds could have different aspects. A bell-shaped lesion with a small external opening and a large internal pseudobursa over an exposed bony prominence.

Alternatively large cavities are seen, similar to a crater, whose parietal walls are entirely covered with a mucosal-like tissue and with a fragile, pale and immature granulation tissue present in different areas of the wound.

We try to avoid doing surgery on wounds that show signs of contracting or on easily manageable wounds with a disk shape. We also try to avoid flaps in patients with poor short-term and long-term prognosis, palliated children, patients with multiple previous flaps and children/caregivers who do not yet seem to understand their role in wound care and pressure relief. Co-operation between sanitary and parents is mandatory for the final goal: healing.

Basically, surgery means: **(a)** excision of the ulcer, surrounding scar tissues, heterotopic calcifications, edge callosities, underlying and branched pocket; **(b)** partial or complete ostectomy to remove the bony prominence when required, otherwise a bone biopsy If needed; **(c)** deep tissues sampling for microbiological purposes and postoperative therapies; **(d)** closure of the wound, which includes filling dead space with fascia, or muscle and skin flaps that can provide durable coverage over the wound with a long-term favorable follow-up and no recurrences. The final result in children must be evaluated after a 6 mos period of follow-up. The stability of tissues

covering the defect and the absence of recurrent infections are the most important goals to achieve.

Children with pressure ulcers have a significant risk of developing hematomas postoperatively. Bleeding from minor vessels should be carefully controlled with gauze dressing soaked with an H<sub>2</sub>O<sub>2</sub> and isotonic saline 50% solution loosely applied in the cavity before its definitive closure.

---

## SACRAL Pressure Ulcer: More Frequently Reported Options

1. Treatment of undermining plus NPWT
2. Treatment of bottom and edges plus NPWT
3. Primary closure (reserved to few selected cases, less than 5% in our series. Very few pressure ulcers are suitable for direct closure and only when a negative pressure wound therapy failed or If a fast treatment is advisable because of the underlying pathological serious disease).
4. Skin graft.
5. Flap (muscolocutaneous flap/fascio-myo-cutaneous flap, with or without bone partial resection in IV staged wounds).
6. Sensory island flap (neurovascular island flap. This technique is use to bring sensations to the sacral area, for example, in young paraplegics. These flaps have the potential for an increase of the reinnervation and could be performed in a single stage without microsurgery in children aged more than 10 years).
7. Intercostal island flap (a surgical flap in which the pedicle consists solely of the supplying blood vessels). Perforator flap (these flaps )accomplished the need to minimize donor-site morbidity from cosmetic, functional and psychological perspectives. The Superior Gluteal Artery Perforator Flap (SGAP) is based on the superior gluteal artery and venae via perforators through the gluteus maximus muscle. The vessels at their exit from the pelvis are 1.5–4 mm in size depending on the patient's age. The Inferior Gluteal Artery Perforator Flap (IGAP) is supported by the inferior gluteal artery).

**Technique:** flaps based on the gluteus maximus remain the selected choice for sacral areas. These flaps are versatile and can include muscle or muscle and skin. They could be based superiorly or inferiorly.

Part or all of the muscle can be included in the design and may be rotated, advanced (V-Y) or turned over. Skin incision done, we made a dissection through the gluteus maximus muscle, beginning at the superior and lateral border, near the trochanter. The later portion of the muscle is divided, followed by division of the inferior portion of the muscle. The muscle is then elevated in a medial to lateral direction off of the sacrotuberous ligament. The two vascular pedicle are identified and the flap, completely mobilized easily covers the sacrum. In children an alternative is represented by the perforator flaps because they preserve the gluteus maximus muscle for future use if required, are less invasive and time-consuming procedures and are a first option, when feasible a voiding possible atrophies of the GMmuscle.

---

## ISCHIATIC Pressure Ulcer: More Frequently Reported Options

1. Treatment of undermining plus NPWT.
2. Treatment of bottom and edges plus NPWT.
3. Myocutaneous flap closure. Muscle's choice: gluteus maximus, tensor fascia lata, gracilis, semimembranosus, semitendinosus.
4. Rectus abdominis musculocutaneous flap
5. Free Tissue Transfer Flaps (with this technique, tissues, along with their blood supply, are freed from the anatomical location ("donor site") and then transferred to another location ("recipient site"), corresponding to the pressure ulcer site. This is in contrast to a "pedicled" flap in which tissue is left attached to the donor site and simply transposed to a new location via various technique of mobilization. The "pedicle" is kept intact as a conduit to supply the tissue with blood.

*Technique:* after the gluteal muscle mobilization we have to divide it from its posterior and lateral insertion to allow for medial movements and obliteration of the cavity over the ischium.

---

## The Caregiver

Wound treatment and pressure ulcer prevention in pediatric patients need to focus on a clear goal of specific and individual needs of each patient. It is highly recommended that specialists for pediatric wound treatment be advised in chronic wounds in children in children with unclear wound healing and in children in critical life conditions with skin lesions and wounds.

Doctors, Surgeons and nurses need to define the goals of wound treatment in each situation and then therefore act in the way to do the best performance for the child and his family for today and future. Wound treatment in children must always consider the effect that pediatric patients are still growing and wounds and scarring can affect functional and cosmetic outcomes in the future. Interdisciplinary wound care teams taking into account these special needs in pediatric patients are mandatory.

---

## Palliative Wound Care

During the last 5 years, more than 400 children were wound-cared and 35% of them had a neurological primary system dysfunction with a subsequent moderate to severe disability. These children were treated also because of pulmonary (55%) gastrointestinal (38%) and cardiovascular (28%) conditions.

Palliative medicine is appropriate for children in all disease stages, including those undergoing treatment for curable illnesses and those living with chronic diseases, as well as patients who are nearing the end of life.

Palliative care/cure utilizes a multidisciplinary approach to child treatment, relying on input from physicians, nurses, psychologists in formulating a plan of care to relieve suffering from neonatal age to adolescence. The optimal result is work as a

team and not as a “one man show”: alleviation of symptoms or curing the collateral diseases associated to the main condition is as difficult as a major operation.

Palliative wound care promote wound healing, controlling pain, managing infection, odor, bleeding, exudate and maintaining a good quality of life for the child and caregiver.

Improving mobility in otherwise immobile children is a tremendous effort: however, improving or relieving pain permit a more comfortable assistance and if the child cooperate a double good result is achieved: (1) to make him responsible of his movements: even if he is not able to move the absence of pain facilitate the turn-over of different not dangerous positions of the body, relieving undue pressure and the child is therefore active in this process; (2) No pain means healing and the child classifies this caring time as useful for future improvements of its condition.

There's an enormous relationship between wound healing and psychosocial factors.

And that's why most relevant to the medical setting are the extended-family members in the caregiving role. The definition of family caregiver varies: this role include the informal and unpaid care provided by devoted figures that goes beyond usual and normative social support provided in social relationship. Counselling the family and caregivers is an integral part of treating the chronic wound. Supporting the dressing changes with a solid and warm (not only technical) medical action improves the wound care.

The best palliation for a wound that impairs quality of life is to provide to the “Triad Complex” any information necessary to understand how and why the wound is getting better: a daily diary stress both the healing process and the active consequences produced by this palliative action: a painless wound, infection-free, without a foul smell and a good tissue repair and regeneration limits the parental distress, makes more accepted the child by other patients, he can start again to play with them and the mother should mark on the Diary when his sun become to walk again for the first time after a long time.

---

## References

1. Anthony D, Willock J, Baharestani M. A comparison of Braden Q, Garvin and Glamorgan risk assessment scales in pediatrics. *J Tissue Viability*. 2010;19:98–105.
2. Ciprandi G. The critical area and pressure ulcers. New concepts. In Workshop on Pediatric Wound Care, Ciprandi G, Miguens C, Quesada C. European Wound Management Association Conference, Lisboa, Portugal, 14-16 May, 2008.
3. Escher Neidig JR, Kleiber C, Oppliger RA. Risk factors associated with pressure ulcers in the pediatric patient following open-heart surgery. *Prog Cardiovasc Nurs*. 1989;4:99–106.
4. Hoegeling M, Fardin SR, Frieden IJ, Wargon O. Forehead pressure necrosis in neonates following continuous positive airway pressure. *Pediatr Dermatol*. 2011;29:45–8.
5. McNulty AK, Schmidt M, Feeley T, et al. Effects of negative pressure wound therapy on cellular energetics in fibroblasts grown in a provisional wound (fibrin) matrix. *Wound Repair Regen*. 2009;17(3):192–9.
6. Rodriguez-Key M, Alonzi A. Nutrition, skin integrity and pressure ulcer healing in chronically ill children: an overview. *Ostomy Wound Manage*. 2007;53:56–66.



7. Saxena V, Hwang C-W, Huang S, et al. Vacuum-assisted closure: microdeformations of wounds and cell proliferation. *Plast Reconstr Surg*. 2004;114(5):1086–96. discussion 1097–8.
8. Schlüer AB, Schols JMGA, Halfens RJ. Risk and associated factors of pressure ulcers in hospitalized children over 1 year of age. Submitted to the *Journal for Specialists in Pediatric Nursing*. 2013b.
9. Van Landuyt K, Hamdi M, Blondeel P, Tonnard P, Verpaele A, Monstrey S. Reconstructive, lower extremity free perforator flaps in children. *Plastic Reconstr Surg*. 2005;116:159–69.
10. Kottner J, Wilborn D, Dassen T. Frequency of pressure ulcers in the pediatric population: a literature review and new empirical data. *Int J Nurs Stud*. 2010;47:1330–40.
11. Noonan C, Quigley S, Curley MA. Using the Braden Q scale to predict pressure ulcer risk in pediatric patients. *J Pediatr Nurs*. 2011;26:566–75.
12. Ciprandi G, Romanelli M, Durante CM, Baharestani M, Meuli M. Both skill and sensitivity are needed for paediatric patients. Guest editorial. *Wounds Int*. 2012;3(1):5.
13. National Pressure Ulcer Advisory Panel (NPUAP) and European Pressure Ulcer Advisory Panel (EPUAP). Prevention and treatment of pressure ulcers: clinical practice guideline. Washington, DC: National Pressure Ulcer Advisory Panel; 2009.
14. Baharestani MM, Ratliff CR. Pressure ulcers in neonates and children: an NPUAP white paper. *Adv Skin Wound Care*. 2007;20:208–20.
15. Ciprandi G. Preventing paediatric pressure ulcers. [www.hospitalhealthcare.com/hhe](http://www.hospitalhealthcare.com/hhe). *Pharm Ther*. 2012;2:1–4.
16. Defloor T. The risk of pressure ulcer sores: a conceptual scheme. *J Clin Nurs*. 1999;8:206–16.
17. Kottner J. Was sind Dekubitus? In: Schröder G, Kottner J, editors. *Dekubitus und Dekubitusprophylaxe*. Bern: Hans Huber; 2012.
18. Willock J, Askew C, Bolland R, Maciver H, James N. Multicenter research: lessons from the field. *Pediatr Nurs*. 2005;17:31–3.
19. Curley MA, Quigley SM, Lin M. Pressure ulcers in pediatric intensive care: incidence and associated factors. *Pediatr Crit Care Med*. 2003;4:284–90.
20. Schindler CA, Mikhailov TA, Fischer K, Lukasiewicz G, Kuhn EM, Duncan L. Skin integrity in critically ill and injured children. *Am J Crit Care*. 2007;16:568–74.
21. Dixon M, Ratliff C. Pediatric pressure ulcer prevalence- one hospital's experience. *Ostomy Wound Manage*. 2005;51:44–6. 48–50.
22. Parnham A. Pressure ulcer risk assessment and prevention in children. *Nurs Child Young People*. 2012;24:24–9.
23. Waterlow J. Pressure sore risk assessment in children. *Pediatr Nurs*. 1997;9:21–4.
24. Boesch RP, Myers C, Garrett T, Nie A, Thomas N, Chima A, McPhail GL, Ednick M, Rutter MJ, Dressman K. Prevention of tracheostomy-related pressure ulcers in children. *Pediatrics*. 2012;129:e792–7.
25. McCord S, McElvain V, Sachdeva R, Schartz P, Jefferson LS. Risk factors associated with pressure ulcers in the pediatric intensive care unit. *J Wound Ostomy Cont*. 2004;31:179–83.
26. Schlüer AB, Halfens RJ, Schols JMGA. Pediatric pressure ulcer prevalence: a multicenter, cross-sectional, point prevalence study in Switzerland. *Ostomy Wound Manage*. 2012;58:18–31.
27. Schlüer AB, Cignacco E, Müller M, Halfens R. The prevalence of pressure ulcers in four pediatric institutions. *J Clin Nurs*. 2009;18:3244–52.
28. Schlüer AB, Halfens RJ, Schols JMGA. Pressure ulcers in hospitalized neonates and infants; prevalence, risk factors, preventive measures. Submitted to the *Journal Nursing in Critical Care*. 2013c.
29. Kottner J, Hauss A, Schlüer AB, Dassen T. Validation and clinical impact of pediatric pressure ulcer risk assessment scales: a systematic review. *Int J Nurs Stud*. 2013;50:807–18.
30. Law J. Transair paediatric mattress replacement system evaluation. *Br J Nurs*. 2002;11:343–6.
31. McLane KM, Bookout K, McCord S, McCain J, Jefferson LS. The 2003 national pediatric pressure ulcer and skin breakdown prevalence survey. *J Wound Ostomy Cont*. 2004;31:168–78.

32. Groeneveld A, Anderson M, Allen S, Bressmer S, Golberg M, Magee B. The prevalence of pressure ulcers in a tertiary care pediatric and adult hospital. *J Wound Ostomy Cont.* 2004;31:108–22.
33. Halfens RJ, Bours GJ, Bronner CM. The impact of assessing the prevalence of pressure ulcers on the willingness of health care institutions to plan and implement activities to reduce the prevalence. *J Adv Nurs.* 2001;36:617–25.
34. Coleman S, Gorecki C, Nelson EA, Closs SJ, Defloor T, Halfens R, Farrin A, Brown J, Schoonhoven L, Nixon J. Patient risk factors for pressure ulcer development: systematic review. *Int J Nurs Stud.* 2013;50:974–1003.
35. Ciprandi G. Complex wounds in paediatric patients: new trends and refinements. Key Session. Friday 15 May, 2015. London, UK. 25th Conference of the European Wound Management Association (EWMA); 2015.
36. Baharestani MM. An overview of neonatal and pediatric wound care knowledge and considerations. *Ostomy Wound Manage.* 2007;53:34–6. 38, 40.
37. Cisler-Cahill L. A protocol for the use of amorphous hydrogel to support wound healing in neonatal patients: an adjunct to nursing skin care. *Neonatal Netw.* 2006;25:267–73.



# Pressure Ulcers After Epidural Anaesthesia

# 11

Agata Janowska, Valentina Dini, Marilena Pradal,  
Giulia Davini, and Francesco Uccelli

---

## Introduction

Control of pain with epidural anaesthesia represents a major advance in the care of delivery and it is a part of standard gynecologic surgery. Side effects of this procedure are motor block, hypotension, rarely lower limb paralysis, hypothermia, and vertebral canal haematomas. Modern epidural techniques aim to give maximal sensory block with minimal motor blockade. Furthermore fetal monitoring, intravenous infusions can reduce the mobility.

Most pressure ulcers occur in older, debilitated, incontinent, bedridden patient, however epidural anaesthesia is associated with a low risk of pressure ulcers in young and mobile patients. The combination of pressure, share and friction causes a pressure ulcer development [1, 2].

Current management in obstetrics and gynecology encourages women to be mobile and the absence of pain reduces the patient movements. The patients should be alert to the potential problem of epidural analgesia and pressure ulcer prevention is a basic nursing practice [3].

---

## Epidemiology

A literature search identified a few articles by different authors about pressure ulcers in women with gynecological disorders and in pregnant women.

Shah examined three normal weight young patients (average age 40 years) with early stages of cervix and vulvar cancer. The patients were supine for about 120 min and 20 mL of 0.25% bupivacaine was used for pain relief. These patients developed ulcers

---

A. Janowska (✉) · V. Dini · M. Pradal · G. Davini · F. Uccelli  
Department of Dermatology, Santa Chiara Hospital, University of Pisa, Pisa, Italy

in 1 to 3 weeks. The ulcers healed in about 4 months. The patients didn't have any ulcers predisposition and the development of wounds was related to the lack of continuous monitoring, to the lack of adequate equipment and to anaesthesia motor block [4].

Alfirevich A et al. examined a case of pregnant overweight 28 years old woman. A total of 10 mL of 0.125% bupivacaine with fentanyl and epinephrine was used during the childbirth. After the increase in concentration to 0.25% bupivacaine, the patient remained motionless and approximately 20–24 h afterwards developed a blister on left heel and on the sacrum. Heel blister enlarged and became painful. The patient was discharged with continuous care of the heel lesion. At follow-up, the patient's heel ulcer decreased in size and there were no areas of necrotic tissue. The prolonged position during the delivery and the overweight contributed to the development of the pressure ulcer [5].

Naruse S et al. examined a case of normal weight 34 years old patient. Epidural anaesthesia occurred for severe and persistent contraction. The patient was supine for 20 h. At child birth, a pressure ulcer was present in the intertrochanteric part of the right femur. Insufficient knowledge of medical staff about the risk of pressure ulcer during epidural anaesthesia caused the development of the ulcers [6].

Takahashi E et al. investigated two normal weight young patients (average age 32 years), with a uterine leiomyoma. These patients were supine during the surgery for about 70 min. 0.2% ropivacaine at the rate of 4 mL/h was used for epidural anaesthesia. In second case the epidural anaesthesia was extended for 12 h after surgery. The pressure ulcer developed during the first day after surgery and it was characterized by erythema, induration, and persistent local pain. Also in these cases the pressure ulcers were not related to age, physical status, surgical procedure, type of disease, surgical position or nursing care, but to effect of prolonged epidural anaesthesia [7]. According to published evidence the incidence of pressure ulceration during gynecologic surgery appears low but lack a specific incidence monitoring in maternity units. Ulcers may heal during the surgery follow up and often the injuries are unreported (Figs. 11.1 and 11.2).

---

## Pathophysiology and Clinical Features

Prolonged pressure, friction and shear are known cause of the development of pressure ulcers. Pressure is inversely proportional to the area and it is highest next to the bone like spines, coccyx, hips, heels, and elbows. A constant pressure for more than 2 h produces tissue ischaemia, occlusion of the vascular network in underlying tissues and irreversible tissue damage. Shear is caused by lateral or rotational forces which occur frequently in deep tissues. Friction and share are increased by inadequate incontinence pads, mattress and other devices. Furthermore the amniotic fluid, blood and incontinence when in contact with the skin for prolonged time can alterate the skin homeostasis. The patients risk factors include age, weight, continence, malnutrition, hypoproteinemia, skin hydration, anemia, infection, congenital hip abnormalities, gestational proteinuric hypertension and more. This combination may cause damage in a few minutes in some cases and all these risk factors are worsened in the presence of reduced sensory perception [8, 9].

**Fig. 11.1** Stage 1 pressure lesion 24 h after delivery with epidural anaesthesia



Clinical aspects of pressure ulcers are now classified according to the European Pressure Ulcer Advisory Panel (EPUAP) staging system [10].

Differential diagnosis of early stage pressure ulcers includes contact dermatitis and burns from heating pads.

---

## Risk Assessment

Managing risk is a fundamental part of clinical practice and preventive measures are required in epidural anaesthesia.

It is important to avoid analgesia with motor and profound sensory block, and any motor block should be reduced to the immediate postsurgery. The goal is to reduce the concentration of local anesthetic needed to obtain analgesia without motor blockade, avoid exposure to the cause of the injury and cover and protect the area. During the first night after the operation, the analgesic treatment should be changed to systemic treatment like morphine and in cases of prolonged motor block, patients should be treated as paraplegic. Frequency of repositioning should be increased.

It is essential to proceed to a clinical evaluation of the level of mobility and the state of skin integrity. This inspection should be carried out at the patient's

**Fig. 11.2** Stage 2 pressure lesion 12 h after delivery with epidural anaesthesia



hospitalisation (within 8 h) and should be continued daily to identify the presence of erythema, temperature and any other features of the skin [11, 12].

Sometimes lesions may appear even a few days after surgery, so a re-evaluation should be made at the time of the discharge from the hospital.

One of the first preventive strategies is to ensure a continuous change of position of patients at risk. All those aspect must be done by ensuring the patient's comfort, hygiene, and the preservation of functional ability.

The frequency of repositioning should be made by considering the tissue tolerance, level of activity and mobility, clinical and skin features.

Repositioning must be made regularly until the total motor function and sensibility return is completed.

The nursing/obstetric trained staff should also educate patients, identified as at risk, in adopting behaviors and positions that should prevent their onset.

A Wound Care Team should also be involved, in order to identify, in collaboration with the nurse/obstetrician, the right procedures of monitoring, evaluating, preventing and treating.

Standard prevention of pressure ulcers consists of changing position every 2 h, good patient care, which is often provided by family members and hospital staff [12, 13].

In identifying the population at risk of developing pressure injuries, it is essential to use a risk assessment scale when a patient is admitted to hospital [14]. At the end

of the surgery and during the time of hospitalization, a periodic risk re-evaluation should be carried out or in any case of significant changes in clinical conditions. These assessments allow the staff to monitor and develop a detailed and personalized risk prevention plan. It is essential also to check the effectiveness, the quality and the safety of the delivery and surgery equipment.

Mattress covers are often robust to prevent contamination of the foam core and to control the amount of body fluid, however robust foams produces areas of high pressure.

Then the quality of the mattress, the cover integrity and absorbent pads are of great importance for pressure redistribution, women should wear heel pads and be repositioned regularly [15].

## Wound Bed Preparation and Advanced Dressings

Treatment of pressure ulcers requires a targeted and comprehensive approach that will provide adequate wound bed preparation that aims at natural healing and tends to get the most benefits from the currently available advanced products.

The TIME acronym was introduced as a method to identify the elements to improve and to control the wound tissue, the infection or inflammation, the moisture balance and the epithelial advancement [16].

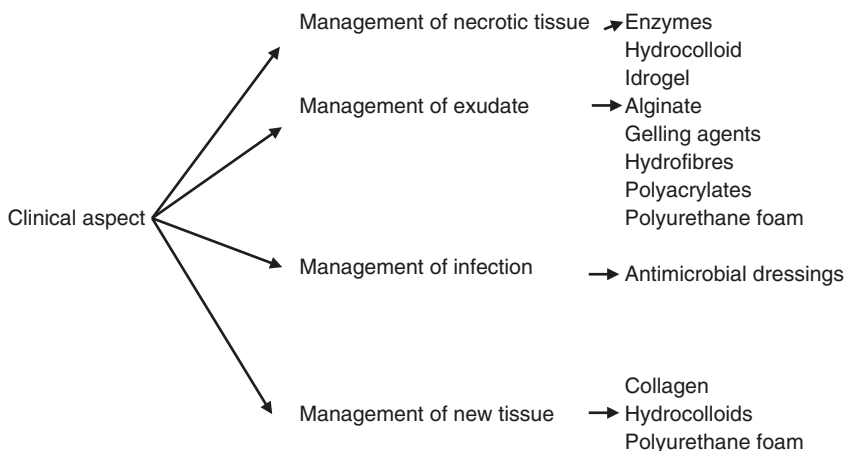
Wound bed preparation is a prerequisite for every technique and every therapeutic approach and is a model that allows the clinical staff to analyze the factors that contribute to healing wounds [17].

To choice of the right dressing should be considered according to the characteristics of the wound.

This evaluation results in the choice of the most suitable dressing (Table 11.1).

Careful cleansing of the wound bed must be performed at each dressing change, and must be followed by a new wound assessment. Before applying a dressing,

**Table 11.1** Wound dressing selection according to healing phases



always consider some aspects such as microclimate, ease of application and removal, skin evaluation, dressing size and comfortability. Advanced dressings can be used for preventive and treatment purposes. If dressing is used for prevention, it will be necessary to continue with the preventive techniques previously described.

In treating the wound bed, especially in highly exudative lesions, evaluate and protect the periwound skin with barrier products [18].

---

### Conclusion

Epidural anaesthesia and technological developments have important health benefits but, they have resulted in reduced mobility and in an increase of the potential for pressure ulcers development in healthy women. Managing risk is a fundamental part of clinical practice and it is essential that equipment used is appropriate to the situation. A prolonged anaesthetic effect for postoperative pain relief, can be a primary risk factor.

Developing a training and educational program specifically targeting the problems is relevant for all the female patients and hospital multidisciplinary team. It is mandatory to early identify the specific risk factors and continuously perform the risk assessment.

It is essential that all women are assessed for risk of pressure damage; this should be included as part of their care plan. Women must be informed of the risks and encouraged to participate in their own care. It should be recognised that epidural anaesthesia may create a risk of pressure damage.

In conclusion there is a real need for all hospital teams to implement guidelines on prevention, surveillance and to monitor activities during the delivery and during the standard gynecological surgical procedures.

---

### References

1. Wiedermann FJ, Lingnau W, Innerhofer P. Postoperative pressure sores after epidural anaesthesia. Good nursing care should prevent pressure sores. *BMJ*. 2001;322(7288):732–3.
2. Wildsmith JA. Postoperative pressure sores after epidural anaesthesia. Informed nursing care is needed. *BMJ*. 2001;322(7288):733.
3. Hughes C. Obstetric care. Is there risk of pressure damage after epidural anaesthesia? *J Tissue Viability*. 2001;11(2):56–8.
4. Shah JL. Lesson of the week: postoperative pressure sores after epidural anaesthesia. *BMJ*. 2000;321(7266):941–2.
5. Alfirevic A, Argalious M, Tetzlaff JE. Pressure sore as a complication of labor epidural analgesia. *Anesth Analg*. 2004;98(6):1783–4.
6. Naruse S, Uchizaki S, Mimura S, Taniguchi M, Akinaga C, Sato S. Pressure ulcer caused by long-term keeping of the same body position during epidural labour analgesia. *Masui*. 2016;65(6):643–5.
7. Takahashi E, Isonishi S, Suzuki M, Ogura A, Kunito S, Hiramata M, Shoji H, Ochiai K, Tanaka T. Two cases of epidural anesthesia-associated postoperative decubitus. *J Obstet Gynaecol Res*. 2008;34(4 Pt 2):763–6.
8. Hoogendoorn I, Reenalda J, Koopman BFJM, Rietman JS. The effect of pressure and shear on tissue viability of human skin in relation to the development of pressure ulcers: a systematic review. *J Tissue Viability*. 2017;26(3):157–71.



9. Stausberg J, Kiefer E. Classification of pressure ulcers: a systematic literature review. *Stud Health Technol Inform.* 2009;146:511–5.
10. Beeckman D, Schoonhoven L, Fletcher J, Furtado K, Gunningberg L, Heyman H, Lindholm C, Paquay L, Verdú J, Defloor T. EPUAP classification system for pressure ulcers: European reliability study. *J Adv Nurs.* 2007;60(6):682–91.
11. Offori EM, Popham P. Decubitus ulcers after instituting epidural analgesia for pain relief in labour. *Anaesthesia.* 2000;55(2):194.
12. Jury CS. Postoperative pressure sores after epidural anaesthesia. Staff needs to recognise patients are at risk. *BMJ.* 2001;322(7288):733–4.
13. Aljezawi M, Al Qadire M, Tubaishat A. Pressure ulcers in long-term care: a point prevalence study in Jordan. *Br J Nurs.* 2014;23(6):S4, S6, S8, S10–1
14. Valiani V, Chen Z, Lipori G, Pahor M, Sabbá C, Manini TM. Prognostic value of braden activity subscale for mobility status in hospitalized older adults. *J Hosp Med.* 2017;12(6):396–401.
15. Siman AG, Brito MJM. Changes in nursing practice to improve patient safety. *Rev Gaucha Enferm.* 2017;37(spe):e68271.
16. Ayello EA, Dowsett C, Schultz GS, Sibbald RG, Falanga V, Harding K, Romanelli M, Stacey M, Teot L, Vanscheidt W. TIME heals all wounds. *Nursing.* 2004;34(4):36–41. quiz, 41–2.
17. Schultz GS, Sibbald RG, Falanga V, Ayello EA, Dowsett C, Harding K, Romanelli M, Stacey MC, Teot L, Vanscheidt W. Wound bed preparation: a systematic approach to wound management. *Wound Repair Regen.* 2003;11(Suppl 1):S1–28.
18. Westby MJ, Dumville JC, Soares MO, Stubbs N, Norman G. Dressings and topical agents for treating pressure ulcers. *Cochrane Database Syst Rev.* 2017;6:1–201.



Agata Janowska, Michela Macchia, and Battistino Paggi

## Introduction

The management of pressure ulcers has a major impact on health. We are now increasingly focused on an “overall feel good” approach as a reference model. This involves not only an attitude toward healing, but also a propensity to reduce pain and improve quality of life for patients. Therefore a treatment that should not only protect and promote healing, but also reduce the complications and implications, where possible, seems to be key to a concrete prevention. Speaking of medications may appear simplistic if we consider only the quality of these technologies, but more significant if we carefully manage each stage of the process of taking care of patients with ulcers. This appears to be the only certain aspect in an approach to the treatment of pressure ulcers. Bibliographic reviews have highlighted the fact that there is still insufficient evidence to support dressings (Vermeulen et al. [1], Chaby et al. [2], MeReC Bulletin [3]), while recognizing a different ability to manage individual steps in the process of healing. If the approach to the clinical stage is a model to follow in choosing the most appropriate medication, we have to start with the classification of pressure ulcers that has a broad consensus in the scientific community. The current classification of pressure ulcers is the NPUAP-EPUAP-PPPIA of 2014, which divides skin ulcers into four categories/stages, completed by two clinical situations that do not allow a real categorization or staging [4]. There are also other factors that influence the management of a skin wound (Fig. 12.1), including the patient’s general condition, the condition of the wound and the experience of the medical team.

---

A. Janowska (✉)

Department of Dermatology, Santa Chiara Hospital, University of Pisa, Pisa, Italy

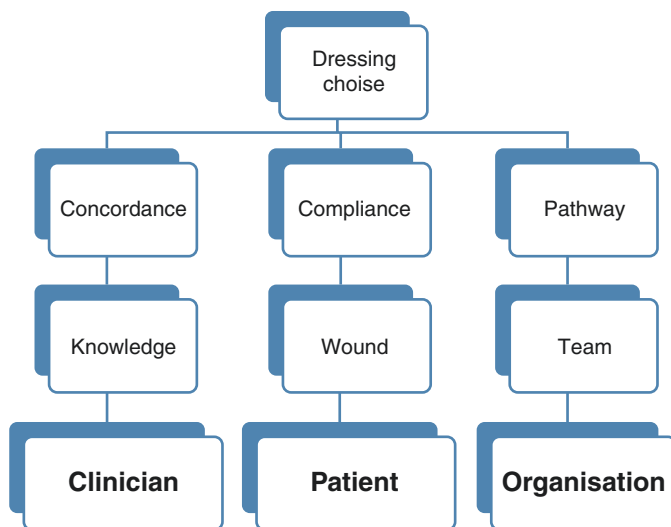
M. Macchia

Department of Dermatology, Santa Chiara Hospital, Pisa, Italy

B. Paggi

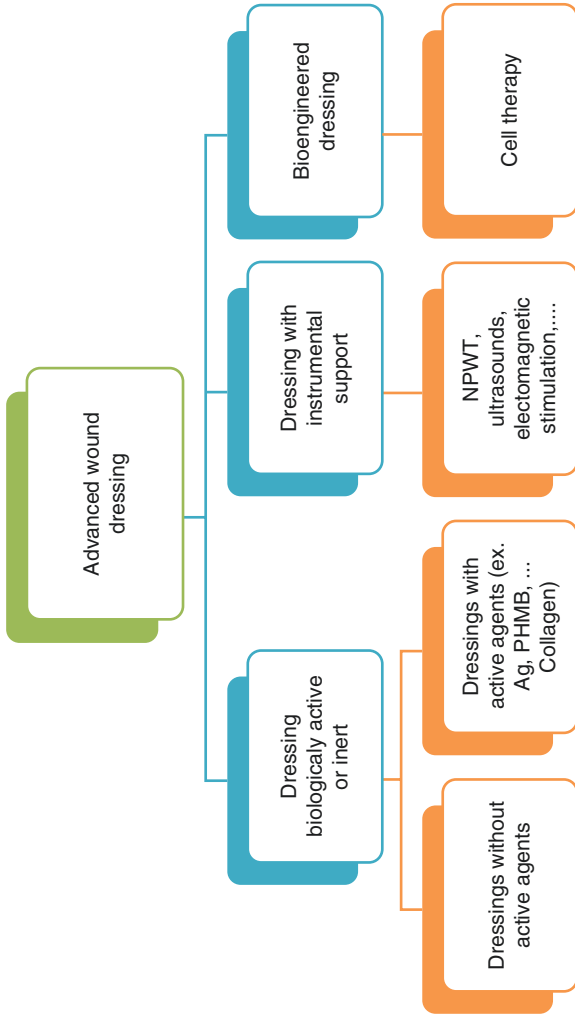
HeKa s.c.s., Biella, Italy

**Fig. 12.1** Dressing pathway

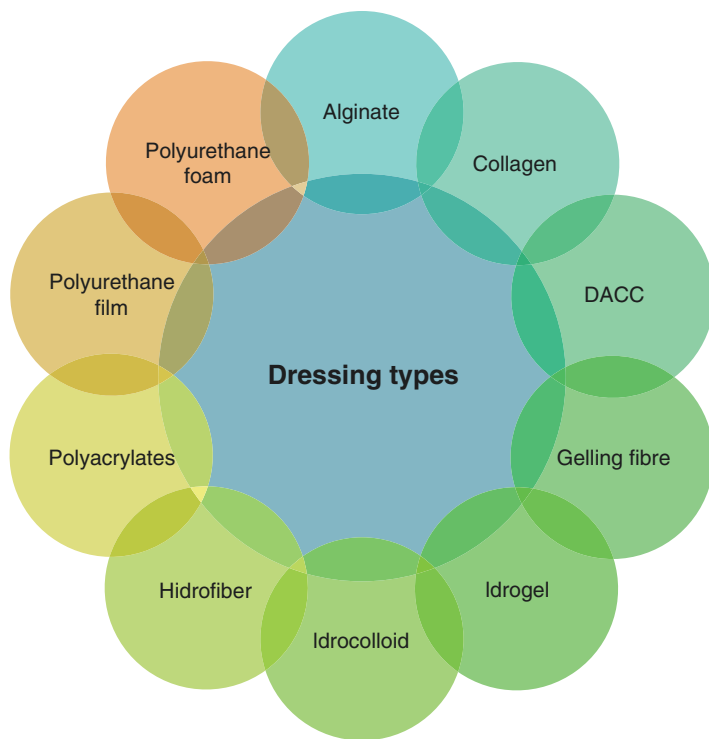


One of the main problems for clinicians is related to the choice of the most appropriate medication and the clinical situation. Dressings are now divided into traditional and advanced dressings. The purpose of this article is to provide the reader with a brief guide to the process of taking charge of the patient, through the various phases of treatment, while providing reflection on the most appropriate choices. Currently available treatment options include traditional and advanced dressing, with biocompatible and/or bioactivity characteristics that manage the moist wound healing well. Such medications can be associated with devices (e.g. NPTW) or with other bioengineering products (Fig. 12.2). During the treatment of pressure, friction or slipping wounds, a suitable and personalized nutrition support should be associated, completed by the use of prevention devices (surfaces) and mobilization. Dressings, both advanced and traditional, are intended to protect the wound, to promote healing, to absorb exudate and stop bleeding, reduce odor, promote the growth of new tissue, avoid trauma during removal on the wound bed and on the perilesional skin. Today, it is conceivable to think of the classification of medications according to the composition (Fig. 12.3), the mechanism of action of each (Fig. 12.4), and the clinical situation (Fig. 12.5). The characteristics of an ideal dressing have been described for many years and are well known: permeable for fluid and gas but not for bacteria; thermal insulation; comfort; reduction of the frequency of application; pain management during dressing or during dressing removal, due to their non-adherence to the wound bed [5–7].

In our opinion, characteristics typically linked to the mechanism of action by which the dressings fulfill their function should be added to the list of characteristics of an ideal dressing. Not all materials behave in the same way on the wound bed. Technological developments in the basic materials (polyurethane, alginate, carboxymethylcellulose, etc.) have allowed clinicians to have constantly better performing dressings that meet the clinical needs of the patient and the wound. The materials are combined in different ways with each other and with antimicrobial agents or anti-adherent agents (including petroleum jelly, petrolatum, silicone, etc.);

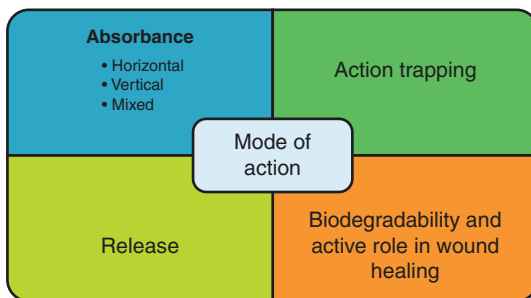


**Fig. 12.2** The evolution of advanced medication



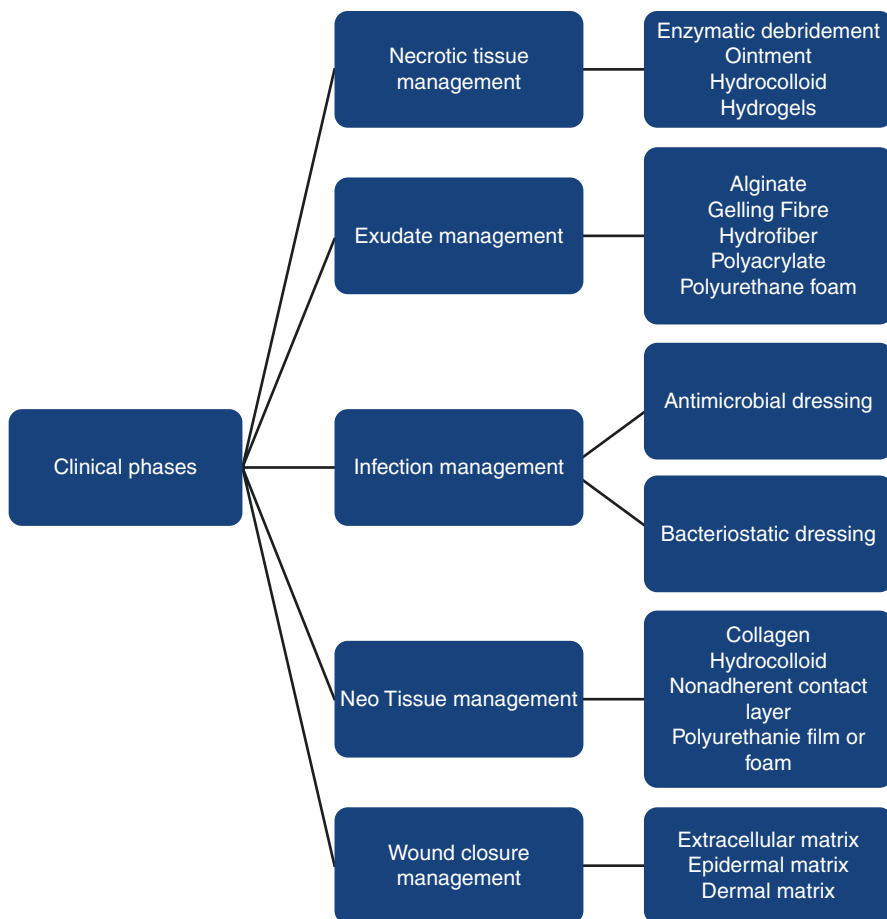
**Fig. 12.3** Dressings according to composition

**Fig. 12.4** Mechanism of action (MoA)



their basic properties, however, remained unchanged: degradation of necrotic tissue, exudate management, protection of the new tissue, development of ECM.

Dressing characteristics are particularly relevant where they actively participate in the repair process or in management of bacteria. In the repair process they promote the action of factors through their degradation (e.g., the large amount of water made with hydrogel induces the lysis of necrotic tissue; moreover, it supports the establishment of the new extracellular matrix); healing is enhanced by biodigestion and by collagen deposits that interact well with repair cells. Most dressings are used in wound exudate management; the different types of foams,



**Fig. 12.5** Dressings compared to the clinical situation

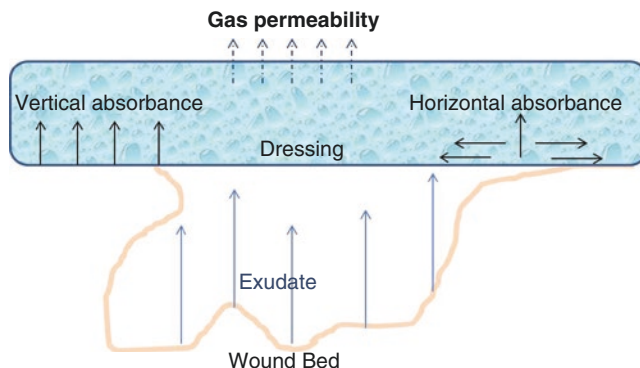
alginates, fibers, gelling agents, hydrofibres and polyacrylates have been compared over time in terms of their capacity, absorption and management. Several articles have been written on the difference between the absorption of vertical exudates, horizontal exudates, and various combinations, as well as on the quantities they are capable of holding (Fig. 12.6) [8–10].

Antimicrobial dressings act through two mechanisms: the incorporation of bacteria and exudate in the dressing, and the release of the antimicrobial dressing scaffold contents (Figs. 12.7 and 12.8) [11].

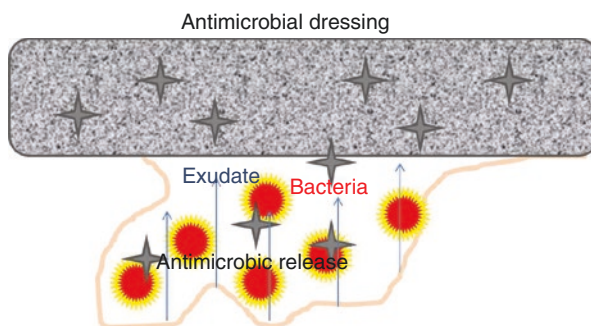
One of the criteria that allows the proper use of medications involves considering the clinical stage according to the application of the principles of TIME [12]. The following figure helps to explain this concept.

In a context of treatment guided by the best clinical actions, it is necessary to learn and choose the medication materials that meet the needs of effective action, both clinical and technological.

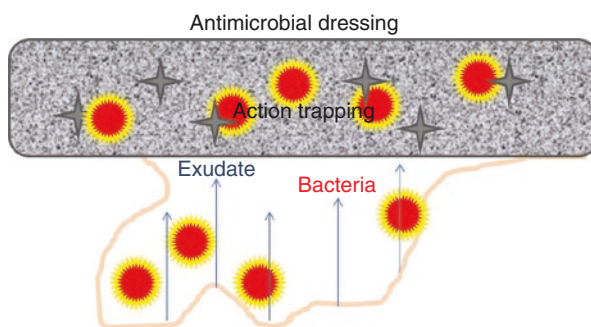
**Fig. 12.6** Absorption capacity



**Fig. 12.7** Antimicrobial effect on the wound bed



**Fig. 12.8** Antimicrobial action within the dressing



## Dressings for Pressure Ulcers

### Non-Adherent

These dressings are made up of a single layer of non-adherent mesh and a structure of polyester, polyamid, cotton or rayon-viscose. Non-adhesiveness is ensured by the presence of vaseline, paraffin, polysaccharides, glycerol, petrolatum and silicone. Such dressings protect the wound from traumatic dressing changes and may be used for small exudative ulcers [6, 7, 13]. [EVIDENCE = C].

## Absorbent

These dressings are polyacrylates, have an absorbent action and can be used as primary or secondary dressings. Some formulations need to be impregnated or wetted with Ringer lactate or saline to facilitate the absorption of exudates and bacteria. Some dressings contain saline gel, which is useful for debridement of fibrin and necrosis. They cannot be cut to prevent the escape of polyacrylate from the wound bed [6, 7, 14].

## Advanced Dressings

### Alginate

Derived from brown algae, these dressings have an absorbing action up to 20 times their weight and adapt perfectly to the shape of the wound. The high absorbency of this medication and the ability to adapt to the wound bed facilitate the removal of the bacterial residues that are captured by the gelification of the matrix, where there is carboxymethylcellulose [EVIDENZA = B]. Through their action they allow for the absorption and the reduced lysis of layers of slough and fibrin. They come in the form of calcium-alginate, sodium-alginate or in combination with collagen. They are indicated for wounds with moderate to high exudate and interact with the dressing material to **form a gel**. Alginates with calcium ions are indicated for bleeding lesions because they facilitate clotting after surgery. The removal can be carried out directly or by instillation of saline, causing an autolytic debridement. Absorption is increased if the alginate is associated with a layer of viscous [EVIDENCE = C]. These dressing are not recommended for low exuding wounds or dry eschar, as they are non-selective, absorbing every watery element and bringing about the dehydration of the wound bed [6, 7, 15, 16].

### Foam Dressing

This dressing normally contains hydrophilic polyurethane foam and absorbs exudate, while keeping the wound moist and maintaining thermal insulation [EVIDENZA = B]. They are of various thicknesses and shapes, depending on the area of application (ex. the sacrum, heel and cavitory lesions with possible associations with secondary dressings); also, they do not cause any trauma at dressing change. They are indicated as primary or secondary dressings in partial thickness or full thickness wounds or under compression or negative pressure. They are not used in the case of dry eschar. They are indicated in category II and III ulcers [EVIDENCE = B]. We recommend a more frequent dressing change in the presence of high exudate, to prevent perilesional maceration [EVIDENCE = C] [6, 13, 14]. Bale et al. [19] introduced the use of hydrocolloid dressings with polyurethane foam and they concluded that foam was the most effective in the control of exudate, but did not have significant difference in terms of wear time [17–19].



### **Carboxymethylcellulose**

This dressing contains sodium carboxymethyl cellulose fibers and in some cases alginate fibers. It has an action similar to that of alginates, but with improved resistance to flaking. The indications are ulcers with moderate or high exudate. The medication interacts with the exudate and turns it into a cohesive gel, which creates a moist environment and helps to control bacteria. There are types of dressings for undermined and tunneling wounds [20, 21].

### **Absorbent Polymers**

These have a high capacity to absorb and incorporate exudate. They promote an association with a cleaning agent (ringer lactate), an osmotic action that cleanses and controls moist wound environments.

### **Hydrogel Dressings**

These are made of insoluble cross-linked polymers (carboxymethyl cellulose) in association with water. Their action depends on the level of hydration and absorption of exudate or rehydration of the wound [EVIDENCE = C] and they are indicated in painful ulcers [EVIDENCE = C]. They are a form of amorphous hydrogel or flat sheets or beads [22].

### **Hydrogels**

These are amorphous gels mostly made up of water and agents of various nature (glycerin, glycol-ethylene, etc.), that favor the rehydration of dry tissues. They are also effective in maintaining moist wound-healing environments, bringing about an autolytic debridement, granulation, epithelialization and pain reduction. They also can be used in cavity wounds [EVIDENCE = C]. There are formulations containing sodium chloride that facilitate and cause debridement of the lesion. Hydrogels may be used as primary or secondary dressings in the form of gauze. Use is not recommended in high-exuding lesions, because of the excessive maceration, or in infected wounds, because of their occlusive action and bacterial growth [EVIDENZA = C] [22]. Matzen et al. [23] compared this gel with saline gauze and reported a reduction in the volume of the wound and the necrotic component [23].

### **Hydrocolloids**

These are semi-occlusive dressings, consisting of gelatin, pectin and carboxymethylcellulose, and bring about an autolytic debridement. Hydrocolloids are primary or secondary dressings and may be used on pressure ulcers in all categories [EVIDENCE = B]), low exuding with necrosis and eschar. They are adhesive, easily malleable, limiting the leakage of gas from the wound bed and preventing the penetration of bacteria and other contaminants, because they are waterproof. The exudate interacts with the dressing material to form a gel, which prevents the adhesion of the dressing. Use should be limited in infected lesions or altered perilesional skin [EVIDENCE = B]. Evidence of the use of hydrocolloids in the treatment of pressure ulcers comes from three meta-analyses, which assessed the impact of hydrocolloids

vs. dressings with paraffin gauze or vs wet to dry, which is significant for a better rate of healing in treated wounds [5, 6, 23–25].

### **Foam Films**

These are permeable to water vapor and oxygen but not to water and bacteria. They can be used as primary and secondary dressings, to prevent or treat category I pressure ulcers. They may bring about autolysis if used with hydrogels on necrotic lesions or eschars [EVIDENCE = C]. They are not used on infected lesions or on moderate-high exuding wounds, because they do not have absorbent properties [EVIDENCE = C]. Use carefully in areas of skin fragility. [EVIDENZA = C] [23] WOCNS (Wound Ostomy and Continence Nurses Society) and AHCPR (Agency for Health Care Policy and Research) have indicated that their use may promote autolytic debridement [26–28].

### **Enzymes**

These consist mainly of collagenase or non-specific proteases, but also exist in the form of fibrinolysis, deoxyribonuclease, papain and equine catalase. They act on the necrosis of protein deposits on the wound bed. The collagenase acts mainly on collagen bridges, elastin, and necrosis, whereas the papain acts on fibrin and fibronectin. The correct application of the product should be limited to the wound bed to prevent maceration and the alteration of the perilesional skin. Simultaneous use during the dressing of antiseptics and chemical products containing metal ions can, if not properly removed, cancel the action of the product [28, 29].

## **Antimicrobial Dressings**

### **Silver Dressings**

These are effective in reducing bacteria and preparing the wound bed. They are composed of silver and various types of substrates. They are indicated in infected or highly colonized pressure ulcers [EVIDENCE = B]. These dressings inhibit the proliferation of bacteria with a slow release, which reduces the histolesivity induced by a high concentration of ions. Vermeulen [30] confirmed by a Cochrane review that the use of this category of dressings induced a reduction in the area of the treated wounds [30]. Observed a reduction of bacteria in the comparison of an alginate with silver ions against alginate without silver ions [31].

### **Iodine Dressings**

This medication releases iodine ions when in contact with exudate and brings about an antiseptic action [32].

### **Biguanide Dressings**

These exist in various forms: post-surgical dressings, in water balance and interface in treatment with negative pressure. This is the only antimicrobial molecule that acts on biofilm [33].

### **Chlorhexidine Impregnated Dressings**

These are made up of a weave gauze enriched with a percentage of chlorhexidine (0.5%) and paraffin. They are indicated for smaller wounds and are non-adherent [6, 7].

### **Honey Dressings**

These have an anti-microbial and anti-inflammatory action and can be used for category II and III pressure ulcers. [EVIDENCE = C] [34].

### **Dressings with Bacterial Binding Action**

These are inert dressings, made up of a synthetic tissue with high hydrophobic capacity, which is able to capture and remove bacteria and other microorganisms from the infected and colonized wound bed. The mechanism of action exploits the tendency to aggregate on the part of the hydrophobic particles [35].

## **Other**

### **Dressings with Silicone**

There are various different types of materials that have been enriched with a layer of silicone. These are useful in promoting non-traumatic adherence at the wound bed and the prevention of perilesional skin damage [EVIDENCE B]. Compared polyurethane foams with or without silicone on category II ulcers [13]. The dressings with silicone were less traumatic for the perilesional skin. [EVIDENCE B].

### **Collagen**

This is a material with high biocompatibility. The biological dressing is indicated in non-healing pressure ulcers of Category/stage III and IV. [EVIDENCE C].

### **Charcoal Activated Dressings**

These dressings have a good absorbent capacity and the charcoal absorbs odor from the wound bed [36].

### **Hypertonic Dressings**





These contain a high quantity of sodium chloride, which induces an osmotic action on the wound bed and promotes the dilution of pus, bacteria and slough colliquation [37].

### **MMP Modulating Dressings**

These modulate or inhibit metalloproteinases, which are often present in chronic wounds. They may be in collagen dressings or combined with secondary dressings. These dressings are very expensive [38].




We suggest a list of dressings to choose from, based on the NPUAP—EPUAP—PPPIA criteria of 2014, depending on the situation of the wound bed and the perilesional skin [4] (Table 12.1).

**Table 12.1** Cleansing and dressings in pressure ulcers

Category	Cleansing	Dressing	Frequency of dressing changes
	Saline or ringer lactate	Foam film, hydrocolloids extra thin or film barrier	Twice a week
	Saline or ringer lactate	<b>LOW EXUDATE (with fibrin)</b>	Twice a week
		Hydrocolloids, hydrogel	
		<b>LOW EXUDATE (with granulation tissue)</b>	
		MMP modulating dressings, collagen, non-adherent dressings	Twice a week
		<b>MEDIUM EXUDATE</b>	
	Antiseptic solution (PHMB, Chlorexidine, sodium hypochloride)	Carboxymethylcellulose (CMC), foam dressings, alginates	
		<b>WITH INFECTION</b>	3 times per week
		Silver dressings, iodine dressings, Chlorexidine impregnated dressings, Biguanide dressings, honey dressings	
	Saline or ringer lactate	Foam dressing or carboxymethylcellulose	3 times per week
		<b>FIBRIN-NECROTIC TISSUE</b>	
		Hydrogel + foam dressing with silicone interface or film foam, absorbent polymer	
		<b>TUNNELING</b>	
	Antiseptic solution	Ribbon dressings (CMC or foam dressing), cavity dressings	
	<b>WITH INFECTION</b>	Daily	
	Foam dressings with silver, CMC with silver, charcoal activated dressings, dressing with bacterial binding action		
		3 times per week	

(continued)

**Table 12.1** (continued)

Category	Cleansing	Dressing	Frequency of dressing changes
	Saline or ringer lactate or antiseptic solution	Hydrogel with hydrocolloide, CMC with or without foam dressing	Daily
			2–3 times per week
		Foam dressing or cavity dressings or alginate, absorbent polymer	
		<b>WITH INFECTION</b>	2–3 times per week
	Antiseptic solution	Dressing foam with silver, CMC with silver, charcoal activated dressing, dressing with bacterial binding action	
	Saline or ringer lactate	Enzymes, hydrogel with film foam, hydrocolloids, non-adherent dressings	Daily
<b>DEEP TISSUE</b> 	Skin cleansing with skin care products	Pressure relief, constant mobilization. Inspection and reevaluation	Daily

The classification of pressure ulcers is divided into 4 categories/stages, with the addition of an unclassifiable stage and deep tissue injury.

- **Category/stage I:** Non-blanchable erythema.
- **Category/stage II:** Partial thickness loss of dermis.
- **Category/stage III:** Full thickness tissue loss. Bone, tendon and muscle are not exposed.
- **Category/stage IV:** Full thickness tissue loss. Bone, tendon and/or muscle are exposed.
- **Unstageable:** Full thickness tissue loss. The depth of the ulcer is completely covered by slough and/or eschar.
- **Deep tissue injury:** This is a discolored intact skin area or blood-filled blister. Deep tissue injury is caused by pressure and/or shear and friction. The wound may evolve and be covered by thin eschar.

## Conclusions

The aim in the use of each product currently available for the treatment of skin ulcers is the formation of an adequate wound bed. Preparation of the wound bed is essential in order to accelerate endogenous healing or to promote the effectiveness of other therapeutic measures when the skin lesion does not heal spontaneously. Advanced medications should be used in an appropriate manner not only by medical specialists and medical personnel, but also by general doctors. Cost reduction and dissemination of use of these dressings must pass this first step. A UK study estimated that dressings and such materials account for 17–22% of the total cost of wound care [39]. In patients with pressure ulcers it is difficult to assess the outcome, such as improving the quality of life, control of exudate, pain and healing time, because of the precarious conditions and numerous comorbidities of the patient. The treatment chosen does not directly affect the duration of survival, so it is difficult to develop an analysis of cost effectiveness or cost benefit. The correct choice of medication is oriented towards clinical and morphological criteria that identify the most obvious signs within the wound bed or perilesional skin. The clinician must know the main and secondary functions of the dressing in order to obtain maximum efficiency in the management of wounds. From the literature it is clear that the proper use (best practice) of dressings and adequate prevention result in a reduction of frequency of application and a optimization of the dedicated health personnel, reducing both healing time and costs.

## References

1. Vermeulen H, Ubbink D, Goossens A, de Vos R, Legemate D. Dressings and topical agents for surgical wounds healing by secondary intention. *Cochrane Database Syst Rev.* 2004;(2):CD003554. Review.
2. Chaby G, Senet P, Vaneau M, Martel P, Guillaume JC, Meaume S, Téot L, Debure C, Dompmartin A, Bachelet H, Carsin H, Matz V, Richard JL, Rochet JM, Sales-Aussias N, Zagnoli A, Denis C, Guillot B, Chosidow O. Dressings for acute and chronic wounds: a systematic review. *Arch Dermatol.* 2007;143(10):1297–304. Review.
3. MeReC Bulletin evidence-based prescribing of advanced wound dressings for chronic wounds in primary care. 2010;21:01.
4. Dunk AM, Carville K. The international clinical practice guideline for prevention and treatment of pressure ulcers/injuries. *J Adv Nurs.* 2015.
5. Bradley M, Cullum N, Nelson EA, Petticrew M, Sheldon T, Torgerson D. Systematic reviews of wound care management: dressings and topical agents used in the healing of chronic wounds. *Health Technol Assess.* 1999;3(17 Pt 2):1–35.
6. Bouza C, Muñoz A, Amate JM. Efficacy of advanced dressings in the treatment of leg ulcers: a systematic review. *Wound Repair Regen.* 2005;13(3):218–29. Review.
7. Dini V, Bertone M, Romanelli M. Prevention and management of pressure ulcers. *Dermatol Ther.* 2006;19(6):356–64.
8. World Union of Wound Healing Societies. Principles of best practice: wound exudate and the role of dressings: a consensus document. London: MEP Ltd; 2007.
9. Thomas S, Fear M, Humphreys J, et al. The effect of dressings on the production of exudates from venous leg ulcers. *Wounds.* 1996;8(5):145–50.

10. Vowden P, Bond E, Meuleneire F. Managing high viscosity exudate. *Wounds Int.* 2015;6(1):14–9.
11. Finnegan S, Percival SL. EDTA: an antimicrobial and antibiofilm agent for use in wound care. *Adv Wound Care (New Rochelle)*. 2015;4(7):415–21. Review.
12. Schultz GS, Sibbald RG, Falanga V, et al. Wound bed preparation: a systematic approach to wound management. *Wound Repair Regen.* 2003;11(2):Suppl S1–28.
13. Maume S, Van De Looerbosch D, Heyman H, Romanelli M, Ciangherotti A, Charpin S. A study to compare a new self-adherent soft silicone dressing with a self-adherent polymer dressing in stage II pressure ulcers. *Ostomy Wound Manage.* 2003;49(9):44–51.
14. Brown-Etris M, Milne C, Orsted H, Gates JL, Netsch D, Punchello M, Couture N, Albert M, Attrell E, Freyberg J. A prospective, randomized, multisite clinical evaluation of a transparent absorbent acrylic dressing and a hydrocolloid dressing in the management of Stage II and shallow Stage III pressure ulcers. *Adv Skin Wound Care.* 2008;21(4):169–74.
15. Belmin J, Meaume S, Rabus MT, Bohbot S. Investigators of the sequential treatment of the elderly with pressure sores (STEPS) trial. Sequential treatment with calcium alginate dressings and hydrocolloid dressings accelerates pressure ulcer healing in older subjects: a multicenter randomized trial of sequential versus nonsequential treatment with hydrocolloid dressings alone. *J Am Geriatr Soc.* 2002;50(2):269–74.
16. Sayag J, Meaume S, Bohbot S. Healing properties of calcium alginate dressings. *J Wound Care.* 1996;5(8):357–62.
17. Parish LC, Dryjski M, Cadden S, Versiva XC, Pressure Ulcer Study Group. Prospective clinical study of a new adhesive gelling foam dressing in pressure ulcers. *Int Wound J.* 2008;5(1):60–7.
18. Guillén-Solà M, Soler Mieras A, Tomàs-Vidal AM, GAUPP-Expert Panel. A multi-center, randomized, clinical trial comparing adhesive polyurethane foam dressing and adhesive hydrocolloid dressing in patients with grade II pressure ulcers in primary care and nursing homes. *BMC Fam Pract.* 2013;14:196.
19. Bale S, Squires D, Varnot T, Walker A, Benbow M, Harding KG. A comparison of two dressings in pressure sore management. *J Wound Care.* 1997;6(10):463–6.
20. Philbin S. Pressure ulcer management using sodium carboxymethylcellulose hydrofiber® foam dressings. *Ostomy Wound Manage.* 2013;59(3):10–2.
21. Tickle J. Effective management of exudate with AQUACEL extra. *Br J Community Nurs.* 2012;Suppl:S38. S40–6.
22. Dumville JC, Stubbs N, Keogh SJ, Walker RM, Liu Z. Hydrogel dressings for treating pressure ulcers. *Cochrane Database Syst Rev.* 2015;(2). <https://doi.org/10.1002/14651858.CD011226.pub2>.
23. Matzen S, Peschardt A, Alsbjørn B. A new amorphous hydrocolloid for the treatment of pressure sores: a randomised controlled study. *Scand J Plast Reconstr Surg Hand Surg.* 1999;33(1):13–5.
24. Baxter H. A comparison of two hydrocolloid sheet dressings. *Br J Community Nurs.* 2000;5(11):572. 574, 576–7
25. Singh A, Halder S, Menon GR, Chumber S, Misra MC, Sharma LK, Srivastava A. Meta-analysis of randomized controlled trials on hydrocolloid occlusive dressing versus conventional gauze dressing in the healing of chronic wounds. *Asian J Surg.* 2004;27(4):326–32.
26. Dutra RA, Salomé GM, Alves JR, Pereira VO, Miranda FD, Vallim VB, de Brito MJ, Ferreira LM. Using transparent polyurethane film and hydrocolloid dressings to prevent pressure ulcers. *J Wound Care.* 2015;24(6):268. 270–1, 273–5
27. Bergman-Evans B, Cuddigan J, Bergstrom N. Clinical practice guidelines: prediction and prevention of pressure ulcers. *Today's OR Nurse.* 1994;16(6):33–40.
28. Ratliff CR, Tomaselli N. WOCN update on evidence-based guideline for pressure ulcers. *J Wound Ostomy Continence Nurs.* 2010;37(5):459–60.
29. Waycaster C, Milne C. Economic and clinical benefit of collagenase ointment compared to a hydrogel dressing for pressure ulcer debridement in a long-term care setting. *Wounds.* 2013;25(6):141–7.

30. Vermeulen H, van Hattem JM, Storm-Versloot MN, Ubbink DT. Topical silver for treating infected wounds. *Cochrane Database Syst Rev.* 2007;(1):CD005486.
31. Trial C, Darbas H, Lavigne JP, Sotto A, Simoneau G, Tillet Y, Téot L. Assessment of the antimicrobial effectiveness of a new silver alginate wound dressing: a RCT. *J Wound Care.* 2010;19(1):20–6.
32. Leaper DJ, Durani P. Topical antimicrobial therapy of chronic wounds healing by secondary intention using iodine products. *Int Wound J.* 2008;5(2):361–8.
33. Sibbald RG, Coutts P, Woo KY. Reduction of bacterial burden and pain in chronic wounds using a new polyhexamethylenebiguanide antimicrobial foam dressing-clinical trial results. *Adv Skin Wound Care.* 2011;24(2):78–84.
34. Yapucu Güneş U, Eşer I. Effectiveness of a honey dressing for healing pressure ulcers. *J Wound Ostomy Continence Nurs.* 2007;34(2):184–90.
35. Cutting K, McGuire J. In vitro and clinical experience of Cutimed Sorbact: the evidence base. *J Wound Care.* 2015;24(Suppl 5a):S6–S30.
36. Sornakumar L, Kalarani M, Srinivas CR. Activated charcoal dressing in malodorous leg ulcers. *Indian J Lepr.* 2010;82(3):147–8.
37. Xakellis GC, Chrischilles EA. Hydrocolloid versus saline-gauze dressings in treating pressure ulcers: a cost-effectiveness analysis. *Arch Phys Med Rehabil.* 1992;73(5):463–9.
38. Nisi G, Brandi C, Grimaldi L, Calabrò M, D’Aniello C. Use of a protease-modulating matrix in the treatment of pressure sores. *Chir Ital.* 2005;57(4):465–8.
39. Drew P, Posnett J, Rusling L, Wound Care Audit Team. The cost of wound care for a local population in England. *Int Wound J.* 2007;4(2):149–55.





Jakub Taradaj and Elia Ricci

---

## Introduction

Standard care and management of pressure ulcers involves relieving risk factors, improving nutrition and skin hygiene, treating infections, removing necrotic tissues, and applying the appropriate dressings. However, some cases are not responsive to the above treatment. This fact clearly demonstrates that, well-documented, promising, and inexpensive methods from adjunctive therapies are still necessary.

According to the newest “National Pressure Ulcer Advisory Panel, European Pressure Ulcer Advisory Panel and Pan Pacific Pressure Injury Alliance. Prevention and Treatment of Pressure Ulcers: Clinical Practice Guideline” [1] published in 2014 a few forms of biophysical agents have been examined for healing pressure ulcers.

---

## Electrical Stimulation

One of the proposed adjunctive method in this document is electrical stimulation with the strongest evidence (grade A—Table 13.1) and with the highest recommendation level.

The first report of electrical stimulation in the medical field is 63AC Scribonius Largus a greek chief physician uses an electric fish for pain control. Roman takes the torpedoes in the treatment of non healing (torpid) ulcers. In 1843,

---

J. Taradaj (✉)

Department of Physiotherapy Basics at Academy School of Physical Education,  
Katowice, Poland

College of Rehabilitation Sciences at University of Manitoba, Winnipeg, Canada  
e-mail: [j.taradaj@awf.katowice.pl](mailto:j.taradaj@awf.katowice.pl)

E. Ricci

Difficult Wound Healing Unit, St. Luca’s Clinic, Pecetto Torinese, Italy

**Table 13.1** Strength of evidence according to NPUAP, EPUAP and PPIIA guideline [1]**A grade**

The recommendation is supported by direct scientific evidence from properly designed and implemented controlled trials on pressure ulcers in humans (or humans at risk for pressure ulcers), providing statistical results that consistently support the recommendation

**B grade**

The recommendation is supported by direct scientific evidence from properly designed and implemented clinical series on pressure ulcers in humans (or humans at risk for pressure ulcers) providing statistical results that consistently support the recommendation

**C grade**

The recommendation is supported by indirect evidence (studies in healthy humans, humans with other types of chronic wounds, animal models) and/or expert opinion

**Table 13.2** Activity of ESTIM from literature

Function	Result
Chemotaxis	Increase
Incretions of GF (VEGF)	Increase
Blood flow	Increase
Small vessels (granulation tissue)	Increase
Macrophages activity	Increase
Fibroblast activity	Increase
Muscular tropisms	Increase
Wound contraction	Increase
Scar elasticity	Increase
Pain	Reduction
Bacterial growth (in vitro)	Reduction

Dubois-Reymond reported a current of an intensity of 1-mA exiting human skin wounds. It was later confirmed that wounds create a surrounding electric field, the “current of injury,” which was found to be of an intensity less than 1 mA. In 1885 Guillaume Duchenne notes that the alternating current is more effective in inducing muscle contractions.

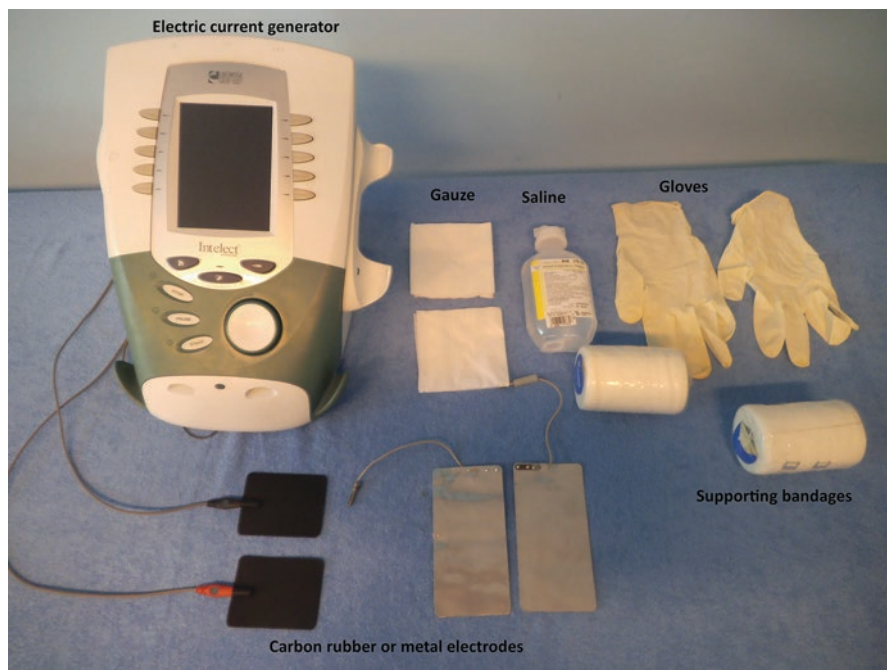
The mechanisms [2, 3] that explain how electric current promotes wound healing based on evidence from many animal studies and very few controlled studies conducted in humans. It has been shown that electrical stimulation induces cellular actions in almost every phase of the wound healing cascade, including the stimulation of several fibroblast activities, such as enhanced collagen and deoxyribonucleic acid synthesis, adenosine triphosphate production and calcium influx, and an increased number of growth factor receptor sites. The *in vitro* studies on macrophages, epithelial cells, and fibroblasts have demonstrated that stimulation promotes the migration and activation of key cells within the wound site. Additionally, *in vivo* studies involving animal models have shown that electric stimulation results in more collagen deposition, enhanced angiogenesis, greater wound tensile strength, and a faster wound contraction rate. Electric current has also been shown to improve tissue perfusion and reduce edema formation, indirectly stimulating healing by improving oxygen delivery to the tissue. However the activity of ESTIM are known (Table 13.2), but the modality of action are not so certainly defined, Afargan propose

a role of brain stimulation but it is based on stochastic type of Estim [4], Kloth that work mainly on DC suggest e role on cell migration and activation.

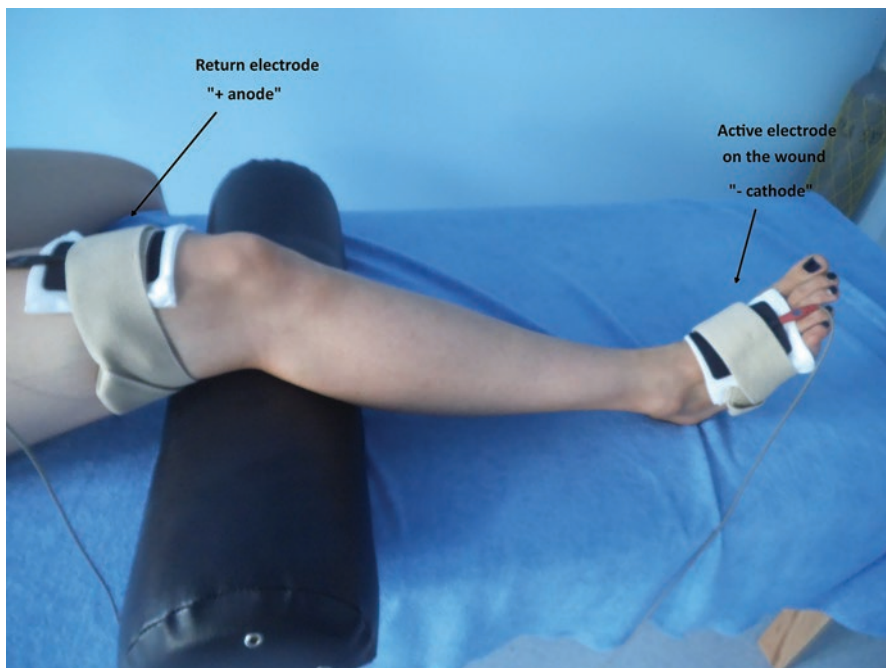
The recommendation from the NPUAP, EPUAP an PPIIA guideline [1] is supported by six randomized controlled clinical trials.

The article from 2011 published in *Wounds* [5] showed significant progress in the healing of pressure ulcers of stage I–III in 29 participants treated with electrical stimulation. The mean area and the mean duration of pressure ulcers were 4.45 cm<sup>2</sup> and 3.17 months respectively in electrical stimulation group and 4.93 cm<sup>2</sup> and 2.80 months in the control. All patients received the same standard wound care (SWC). After six weeks the mean surface wound area decreased significantly in both groups ( $p < 0.001$  in stimulated group and  $p = 0.002$  in control group). In the electrical stimulation group eight of 29 pressure ulcers closed versus only four of 29 ulcers in the control group. A mean decrease in surface wound area was 85.38% in stimulated group versus only 40.08% in control group ( $p < 0.001$ ). The obtained results were supported by our another clinical study investigating electrical stimulation compared with SWC for treating 50 patients with pressure ulcers in stage II–III [6].

To perform the electrical stimulation procedure in pressure ulcers special device and equipment is needed (Fig. 13.1). Electrodes should be made of silver or conductive carbon rubber. Usually, the active electrode size ought to be matched to the wound size, and placed on saline soaked gauze (3–5 mm thickness) directly into the wound. The return electrode should be positioned on intact periwound skin. The exempld placement of electrodes is presented in Fig. 13.2.



**Fig. 13.1** Equipment for electrotherapy in pressure ulcers



**Fig. 13.2** Sample electrode placement in pressure ulcers

**Table 13.3** Different type of current

Current		Wave	Energy
Pulsed	Monophasic		
	Biphasic	Symmetrical	
		Asymmetrical	Balanced
			Unbalanced
Alternated		Symmetrical	
		Asymmetrical	Balanced
			Unbalanced
Direct			

ESTIM is a definition that collect different type of current, with different level of target and action, in Table 13.3 are summarized the different current applied in Human body.

Some time is difficult for clinicians well understand the “electrical concept”, but we have to consider that electricity is in the Human body, and it determine our activity at every level through nerve transmission. Collins [7] well define the different type of treatment with ESTIM (Table 13.4).

At this state of art (Table 13.5) two electrical procedures with Direct Current are the most recommended in pressure ulcer therapy:

1. High Voltage Peaks Current (HVPC)—Table 13.6,
2. Low Voltage Monophasic Peaks Current (LVMPC)—Table 13.7.

**Table 13.4** Different typology of ESTIM from Collins modified

Type	Acronyms
Low intensity direct current	LIDC
Low intensity pulsed direct current	LIDPC
High voltage pulsed current	HVPC
Decubitus direct current treatment	DDTC
Simulated biphasic ES	SSES
Asymmetric biphasic electrical stimulation	ABES
Simmetric biphasic electrical stimulation	SBES
Frequency rhythmic electrical modulation system	FREMS

**Table 13.5** Electrical stimulation dosage range in pressure ulcer healing**IMPORTANT!**

According to newest estimations [19] an electrical stimulation seems to be efficient in pressure ulcer therapy, when the dosage range is **<sup>a</sup>250–500  $\mu\text{C/s}$** , which represents a small window of electrical energy that has been shown to produce very favorable wound healing results

<sup>a</sup>Electric charge is a physical property of matter (e.g., wound tissue with endogenous electric field) that causes it to experience a force when near other electrically charged matter. Charge is measured in units called coulombs (C), representing a specific quantity of electrons, that is, electrically energy. The dosage or charge delivered into wound tissues through a treatment electrode to enhance healing is in the  $\mu\text{C}$  range, which flows in time (per seconds)

**Table 13.6** Characteristics of HVPC**PRACTICAL MESSAGE—How to prepare a therapy!**

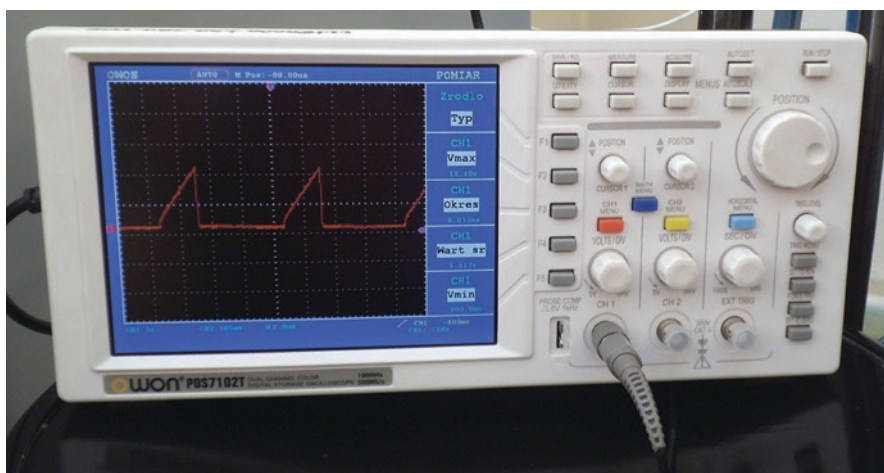
1. Waveform: monophasic, double-peaked spike impulses
2. Frequency: 100 pps
3. Voltage: 100 V
4. Impulse duration: 100  $\mu\text{s}$
5. Current amplitude: with the intensity on sensory level, below the level of muscle contractions (usually from 20 to 40 mA, patient should only feel a mild tingling sensation)
6. Electrode placement and polarization: cathode “–” on the wound, anode “+” as a return electrode (usually in a distance of 30–50 cm from the ulcer)
7. Methods: 50–60 min a day, five times a week (from Monday to Friday)

The HVPC represents usually the electric charge from 250 to 350  $\mu\text{C/s}$ . The LVPDC delivers the dosage range 300–500  $\mu\text{C/s}$ . Both are useful in pressure ulcer healing, only if the generated by electric device parameters are precisely correct. The helpful for verification of signal characteristics is an oscilloscope. The oscilloscope is an instrument that can be used to identify and verify the characteristics of electrical signals that are produced by generator. The oscilloscope is useful in identifying signal characteristics, because it can reliably display a wide band of frequency ranges and a large range of amplitude. The oscilloscope can be used to verify that the voltage and frequencies that a stimulator applies to the patients' wound are in the expected range (Fig. 13.3).

There are also some contraindications to electrical stimulation in patients with pressure ulcers (Table 13.8), which wound therapist should always consider during the treatment process.

**Table 13.7** Characteristics of LVMPIC**PRACTICAL MESSAGE—How to prepare a therapy!**

1. Waveform: monophasic, single rectangular impulses
2. Frequency: 64 or 128 pps
3. Voltage: 20–35 V
4. Impulse duration: 132  $\mu$ s
5. Current amplitude: with the intensity on sensory level, below the level of muscle contractions (usually from 20 to 40 mA, patient should only feel a mild tingling sensation)
6. Electrode placement and polarization: cathode “–” on the wound, anode “+” as a return electrode (usually in a distance of a few centimeters from the ulcer). In some cases it allowed alternate polarity (+/–) at least every week, based on stage of healing.
7. Methods: 50–60 min a day, five times a week (from Monday to Friday)

**Fig. 13.3** An oscilloscope for electrical device calibration**Table 13.8** Contraindications for electrotherapy**WARNING!**

REMEMBER, NOT TO apply to the thoracic area (or transthoracically) of a patient with arrhythmia, congestive heart failure, recent myocardial infarction, and other heart conditions

REMEMBER, NOT TO apply anywhere on the body of a patient with a demand-type implanted cardiac pacemaker or defibrillator or deep brain stimulator

REMEMBER, NOT TO apply through the carotid sinus area (at the bifurcation of the common carotid artery); it may cause a rise in blood pressure, reflex vasodilatation and slow the heart rate

REMEMBER, NOT TO apply transcranially (thru the head) at a milliamp level because it may cause changes in brainwave patterns. EXCEPTION: Only, microcurrent can be applied transcranially

REMEMBER, NOT TO apply through cancerous (malignant) tissue

REMEMBER, NOT NOT apply near or touching protruding metal such as surgical surface staples or external pins because they are excellent conductors of electricity

REMEMBER, NOT TO use on any patient who reacts very negatively to the experience or to the sensation of stimulation

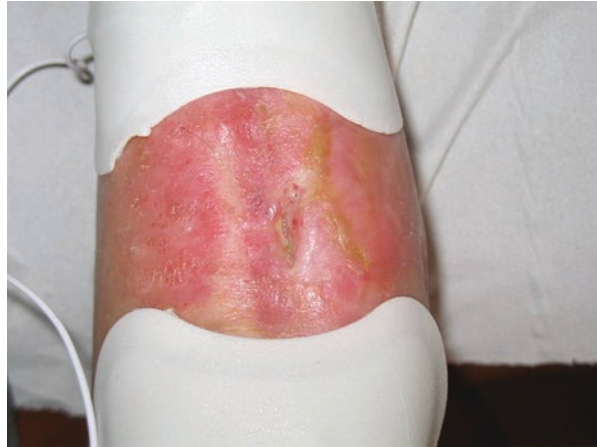
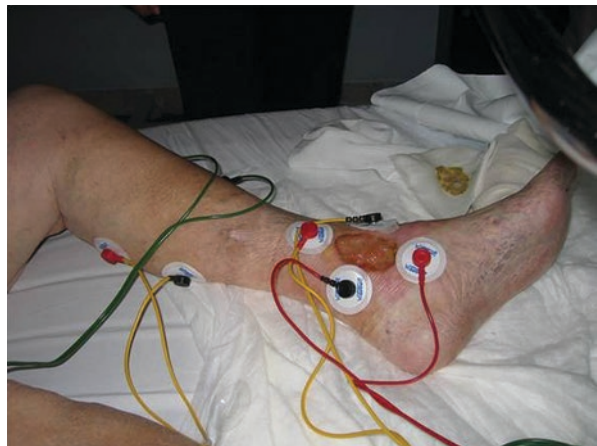
REMEMBER, NOT TO apply to patients who cannot provide adequate feedback concerning the level of stimulation (infants, individuals with mental disorders)

The HVPC and LVMP are supported by literature, but the scientists all over the world still have been looking for another new electrical procedures in wound healing [8]. In recent years, newer technologies are miniaturized, disposable bioelectric dressing-like devices with imbedded electrical circuitry that have been cleared by healthcare regulatory agencies for wound healing in the European Union and for an antibacterial effect on wounds in the United States. The former battery-powered dressing device, Posifec stimulator delivers micro-amperage electric current. The latter bioelectric dressing device, Procellera is powered by 25 micro-batteries that when activated by wound moisture deliver from 0.6 to 0.7 V at 10  $\mu$ A to the wound surface. Further studies are still needed.

At present, the extremely interesting experiment is conducted in China too. Zhang et al. [9] evaluate the effectiveness of electroacupuncture for the treatment of patients with pressure ulcers. This study consists of a randomized controlled trial with two parallel arms: a control group and an acupuncture group. Both groups will receive standard wound care (including changing position, using mattresses and cushions, and a good diet) of five sessions per week for a total of 40 sessions during the 8-week treatment period. In addition to standard wound care, all participants in the treatment group will receive electroacupuncture treatment. Hanyi needles (0.17  $\times$  7 mm) and a Micro Plus transcutaneous electrical nerve stimulator (TENS) will be used in the trial. Two needles will be punctured into the skin of the local wound. One needle will be inserted into the wound center with a 90° angle and connected with the negative pole, while the other needle will be punctured in the normal skin 0.5 cm away from the ulcer margin with a 45° angle and connected with the positive pole. Both needles will be applied without lifting, thrusting, or rotating. The electric stimulator will be turned on with 500  $\mu$ A, 0.5 Hz, 30 min each time, for five sessions per week for 8 weeks. The following outcome measurements will be used in examination of participants: wound surface area (WSA), visual analogue scale (VAS), and the proportion of ulcers healed within trial period (PUHTP). All the outcomes will be evaluated at the start of the study, at the end of the fourth week, at 2 months after randomization, and 4 weeks after treatment cessation.

The DDCT wave-form has been processed from electrical activity that was observed and measured around healing wounds. The type of ESTIM is a stochastic signal close to the signal present in human body [10]. Electrodes are placed on healthy skin surrounding the wound (Fig. 13.4), time treatment is 30 min, 2 session a day. Adunski and Ory, [11] in an RCT reported an increase in healing rate and speediness in treated group vs control group. Afargan suggested a role of nerve system. The Fremis is another type of stochastic E-STIM, based on a predefined asymmetrical wave, determine an increase of blood flow (vasomotion) and an increase of healing rate (Fig. 13.5).

In conclusion the electrical stimulation seems to be the most efficient therapy in alternative methods with the strongest evidence. However, there are some other interesting biophysical agents, but at this moment with much smaller recommendation level (laser stimulation, extracorporeal shock wave therapy or hyperbaric oxygen treatment).

**Fig. 13.4** BST method**Fig. 13.5** FREMS method

## Laser Therapy

Laser therapy has been used to accelerate wound healing since the late 1960s, but its results are still controversial. Due to current insufficiency of evidence to support or refute the use of laser irradiation in the treatment of pressure ulcers, laser therapy is recommended in newest guideline [1] with only relatively poor grade “C”.

Woodruff et al. [12] performed a metaanalysis of 24 animal and clinical studies on the effectiveness of laser (including infrared-based units) on wound healing in variety of ulcer on both animals and humans. They concluded that laser therapy studies had numerous methodological limitations.

In view of the absence of randomized studies with sufficiently large sample sizes, our research team assessed the efficacy of lasers for treating pressure ulcers. Taradaj et al. [13] performed in 2013 a prospective, single-blinded, and randomized



clinical trial to assess the effect of laser therapy as a potential alternative to standard care. We wanted to compare a few common wavelengths in pressure ulcer therapy in a well-prepared and well-planned research program. The primary endpoint in this trial included both the percentage reduction of the ulcer surface area and the percentage of completely healed wounds after one month of therapy (ulcer healing rate). The secondary endpoint was the ulcer healing rate at the follow-up evaluation (3 months after the end of the study). In total, 72 patients with stage II and III pressure ulcers received laser therapy once daily, 5 times per week for 1 month using a (GaAlAs) diode laser with a maximum output power of 50 mW and continuous radiation emission. Three separate wavelengths were used for the laser treatment: 940 nm (group I), 808 nm (group II), and 658 nm (group III). An average dose of 4 J/cm<sup>2</sup> was applied. In group IV, a placebo was applied (laser device was turned off). The results of our study showed that the wavelength of the laser beam is extremely important during the wound-healing process (and perhaps this is one reason for the many controversies). In this trial, we found no evidence that justifies using laser therapy at wavelengths of 940 and 808 nm as an adjuvant to the future consensus pressure ulcer treatment. However, in our opinion the wavelength of 658 nm (dose 4 J/cm<sup>2</sup>, 5 times a week, once daily) is interesting adjunctive therapy and efficient in pressure ulcer healing (the sample results before and after monthly therapy is presented in Figs. 13.6 and 13.7).

**Fig. 13.6** Pressure ulcer before laser therapy



**Fig. 13.7** Pressure ulcer after 4 wks of treatment



## Extracorporeal Shock Wave Therapy

Extracorporeal shock wave therapy (ESWT) is a modern, adjunct medical procedure aimed to improve the skin condition of patients with chronic and acute soft tissue wounds. ESWT is defined as a sequence of biphasic, high-energy acoustic pulses that generate transient pressure disturbance and propagate rapidly in three-dimensional space; this therapy is associated with a sudden rise of pressure applied directly into tissues without any damaging effect.

ESWT utilizes two basic types of generators: radial and focused. They differ in terms of shock wave propagation and the physical characteristics of the energy. Radial ESWT is produced by pneumatic devices located inside the generator that create linear pressure with low energy values. The energy is produced by the pressure wave, while compressed air accelerates the cartridge strikes at the top of the applicator. The energy generated by the pressure wave is absorbed into the skin approximately 3 cm deep and spreads a wider beam to a larger target area. Focused ESWT is generated by electromagnetic, electrohydraulic, and piezoelectric sources. Pressure pulses rise rapidly in range of 10–100 MPa and concentrate the acoustic energy beam with a penetration depth of approximately 12 cm.

Our research team [14] described a third type of defocused ESWT: an acoustic planar wave generated by electromagnetic and electrohydraulic devices. It is characterized by lower energy values delivered into the soft tissues and a superficial and quite large (3–5 cm<sup>2</sup>) impact zone. ESWT types have been differentiated on the basis of the level of energy applied at the focal point per one pulse during treatment session—i.e., energy flux density (EFD), which is determined as low energy when <0.12 mJ/mm<sup>2</sup> and high energy when >0.12 mJ/mm<sup>2</sup>. The following type of ESWT seems to be very attractive for wound healing and is a serious chance for a new promising therapy in pressure ulcers.

ESWT is not indexed in NPUAP, EPUAP an PPIIA guideline [1], because it is very new biophysics agent. Probably, it will be discussed in updated 2019 edition of the guideline. At this stage the recommended parameters of ESWT in pressure ulcers are:

- Type of generator: defocused
- Frequency: 5–10 Hz
- EFD: 0.1 mJ/cm<sup>2</sup>
- Number of pulses: 100/cm<sup>2</sup>
- Methods: three sessions (3–4 days interval between treatments)

**Table 13.9** Modality to administer oxygen in wound treatment

Type		Oxygen	
Hyperbaric oxygen therapy	HBOT	2.4 atmosphere intermittent	
Topical oxygen therapy	TOT	1.03 atmosphere intermittent, 6 LPM, intermittent	TOCT TWO2
Transdermal continuous oxygen therapy	TCOT	1 atmosphere, > 2 mL/h, continuous	Natrox (15 mL/h) Epiflo (3 mL/h)

**Table 13.10** Comparison between different wound oxygen therapies

	Hyperbaric	Local perfusion	TOCT
Local oxygen levels at wound during treatment	1800	800	350
Daily oxygen exposure	1.5 h	5 h	23 h
Average oxygen levels over a week	114	183	336

## Topical Oxygen Therapy

A continuous supply of oxygen is required for any aspect of life and obviously also for wound healing. The needs of oxygen during the healing process increase 50 times, it works as substrate, but also as signal, reduce bacterial growth and increase collagen deposition.

Oxygen therapy can be administered in different ways (Table 13.9), with different amounts (Table 13.10). There is not a clear evidence on use of Oxygen in wound [15]. The HBOT is well defined in treatment of diabetic foot [16], in other wounds, we can obtain some indication from the ECHM-ETRS guideline 2006 [17], but level of evidence is not so strong. Wild et al. [18], in a review on topical Oxygen Treatment conclude: “*The effectiveness of Topical Wound Oxygen (TWO2) has been shown in a significant number of studies. However, there is a clear need for well designed RCT to measure the true advantage of TWO2 compared to other modalities like Hyperbaric Oxygen or advanced wound care*”. At this moment, new devices are available, and results will be evaluated in the future. Figure 13.8 shows the device Natrox put in place.

**Fig. 13.8** A TOCT device positioned on a wound with foam as a secondary dressing



---

## Summary

The electrical stimulation is the most recommended adjunctive therapy of pressure ulcers. At present, this biophysics agent is an algorithm for wound healing, which is strongly supported by literature. There are also other promising therapies, like HBO, laser irradiation or acoustic waves as EWST. Future studies are provided, which assess their usefulness in pressure ulcer care.

---

## References

1. National Pressure Ulcer Advisory Panel, European Pressure Ulcer Advisory Panel and Pan Pacific Pressure Injury Alliance. Prevention and Treatment of Pressure Ulcers: Clinical Practice Guideline. In: Haesler E, editor. Osborne Park, WA: Cambridge Media; 2014.
2. Houghton PE, Campbell KE, Fraser CH, Harris C, Keast DH, Potter PJ, et al. Electrical stimulation therapy increases rate of healing of pressure ulcers in community-dwelling people with spinal cord injury. *Arch Phys Med Rehabil.* 2010;91(5):669–78.
3. Regan MA, Teasell RW, Wolfe DL, Keast D, Mortenson WB, Aubut JL. A systematic review of therapeutic interventions for pressure ulcers after spinal cord injury. *Arch Phys Med Rehabil.* 2009;90(2):213–31.

4. Ricci E, Afargan M. The effect of stochastic electrical noise on hard-to-heal wounds. *J Wound Care*. 2010;19(3):96–103.
5. Franek A, Kostur R, Taradaj J, Blaszczyk E, Szlachta Z, Dolibog P, et al. Effect of high voltage monophasic stimulation on pressure ulcer healing: results from a randomized controlled trial. *Wounds*. 2011;23(1):15–23.
6. Franek A, Kostur R, Polak A, Taradaj J, Szlachta Z, Blaszczyk E, et al. Using high-voltage electrical stimulation in the treatment of recalcitrant pressure ulcers: results of a randomized, controlled clinical study. *Ostomy Wound Manage*. 2012;58(3):30–44.
7. Collins C, Roberts G, Zhao M, Mani R. The use of electrical stimulation of chronic wounds: a review of the evidence. *JWT*. 2009;6:10–9.
8. Koel G, Houghton PE. Electrostimulation: current status, strength of evidence guidelines, and meta-analysis. *Adv Wound Care*. 2014;3(2):118–26.
9. Zhang QH, Yue JH, Sun ZR. Electroacupuncture for pressure ulcer: a study protocol for a randomized controlled pilot trial. *Trials*. 2014;6(15):7.
10. Collins JJ, Imhoff TT, Grigg P. Noise enhanced tactile sensation. *Nature*. 1996;383:770.
11. Adunsky A, Ory A. Decubitus direct current treatment (DDCT) of pressure ulcers: results of a randomized double-blinded placebo controlled study. *Arch Gerontol Geriatr*. 2005;41:261–9.
12. Woodruff LD, Bounkeo JM, Brannon WM, Dawes KS, Barham CD, Waddell DL, et al. The efficacy of laser therapy in wound repair: a meta-analysis of the literature. *Photomed Laser Surg*. 2004;22(3):241–7.
13. Taradaj J, Halski T, Kucharzewski M, Urbanek T, Halska U, Kucio C. Effect of laser irradiation at different wavelengths (940, 808, and 658 nm) on pressure ulcer healing: results from a clinical study. *Evid Based Complement Alternat Med*. 2013;960240:1–7.
14. Dymarek R, Halski T, Ptaszkowski K, Slupska L, Rosinczuk J, Taradaj J. Extracorporeal shock wave therapy as an adjunct wound treatment: a systematic review of the literature. *Ostomy Wound Manage*. 2014;60(7):26–39.
15. Gottrup F, Hunt TK, Hopf WT. Role of oxygen in wound healing and infection. *JWT*. 2010;9:6–11.
16. Kranke P, Bennett M, Roeckl-Wiedmann I, Debus S. Hyperbaric oxygen therapy for chronic wounds (review). *Chocrane Libr*. 2005;3.
17. ECHM ETRS Consensus document, 2006 Ravenna.
18. Wild T, Eberlein T, Frye C. Review of evidence of topical oxygen therapy and chronic wounds. *JWT*. 2010;9:22–7.
19. Kloth LC. Electrical stimulation technologies for wound healing. *Adv Wound Care (New Rochelle)*. 2014;3(2):81–90.



# Negative Pressure Wound Therapy in the Management of Pressure Ulcers

# 14

Valentina Dini, Salvatore Panduri, and Marco Romanelli

## Introduction

Negative pressure wound therapy (NPWT) is defined as the controlled application of sub-atmospheric pressure across a wound to create an environment that promotes wound healing by secondary or tertiary (delayed primary) intention [1]. A suction pump provides continuous negative pressure that allows removal of fluid from the wound bed [1]. Some of the first studies using NPWT used “cupping” (with cup-shaped devices) as a way to remove toxins from wounds [2], which evolved into closed-suction treatment techniques that allowed for true sub-atmospheric pressure over the wound [3, 4].

In 1993, Fleischmann et al. [5] reported on their use of NPWT in 15 of their patients with open fractures. Drainage tubes were inserted into a polyvinyl foam and connected to a suction device to deliver negative pressure. A transparent polyurethane dressing also covered the foam. Their results showed improved healing with granulation tissue formation in all 15 patients [5].

The use of negative pressure generated by simple suction wall units or by portable suction units may have problems in terms of achievement, control and maintenance of desired levels of negative pressure. In 1997, the first commercialized NPWT system, developed by Argenta and Morykwas [6, 7], became available and was licensed to Kinetic Concepts, Inc. as VACUUM ASSISTED CLOSURE™ Therapy (V.A.C.® Therapy). The Food and Drug Administration (FDA) cleared the V.A.C.® Therapy System as a device that is intended to create an environment that promotes wound healing by secondary or tertiary (delayed primary) intention by preparing the wound bed for closure, reducing edema, promoting granulation tissue formation and perfusion, and by removing exudate and infectious material. The device is indicated for patients with chronic, acute, traumatic, subacute and dehisced

---

V. Dini · S. Panduri · M. Romanelli (✉)

Department of Dermatology, Santa Chiara Hospital, University of Pisa, Pisa, Italy

**Table 14.1** General indications for NPWT

1. Acute wounds
2. Chronic wounds
3. Traumatic wounds
4. Partial—thickness burns
5. Dehisced wounds
6. Diabetic ulcer
7. Pressure ulcer
8. Venous ulcer
9. Flaps
10. Grafts

**Table 14.2** Contraindications for NPWT

1. Malignancy in the wound
2. Untreated osteomyelitis
3. Nonenteric and unexplored fistulas
4. Necrotic tissue with eschar present
5. Placement over exposed blood vessels, anastomotic sites, organs, or nerves

wounds, partial-thickness burns, ulcers (such as diabetic, pressure, or venous insufficiency), flaps, and grafts (Table 14.1). Table 14.2 lists the contraindications for NPWT.

The NPWT system consists of a reticulated open cell foam (ROCF) dressing, a pressure-sensing pad, evacuation tubing, a collection canister for fluid, and a computerized therapy unit with adjustable settings that generates negative pressure. The ROCF dressing is placed into the wound cavity and able to adapt to the shape of wound. The dressing is covered by a thin adhesive film, creating a closed system. After the wound is sealed, the evacuation tube is attached to an effluent connecting canister, and the canister is connected to the adjustable vacuum pump that generates a continuous or intermittent pressure ranging from  $-50$  to  $-200$  mmHg, depending on the nature of the wound [7].

## Mechanisms of Action

The exact mechanisms of action of NPWT are unknown. Some hypotheses include: removal of excess fluid and improving wound bed circulation, reducing bacterial load, promoting cell proliferation and synthesis, increasing the level of angiogenic and stimulatory cytokines, and endothelial cell mobilization [8–15]. Furthermore, the ROCF dressing used with NPWT plays a key role in allowing a uniform distribution of pressure over the wound surface. To help promote healing, NPWT provides mechanical forces at the tissue level to create macrostrain and microstrain. Macrostrain causes the ROCF to contract under a controlled negative pressure setting, drawing the wound edges together, reducing the overall wound area and allowing for granulation tissue to fill in, leading to improved wound healing. Microstrain is the transduction of pressure to tissue surfaces, resulting in cell surface deformation as the tissue is being pulled up into the pores (tissue stretch) and the

compression of tissue at the struts. This microstrain leads to cellular proliferation, which promotes granulation tissue formation [16–19]. These effects, as predicated by the adequate delivery of negative pressure to the wound site, are translated into clinical outcomes such as improved tissue perfusion [20], reduced tissue edema [21], and increased granulation tissue formation [22]. The scientific foundation for NPWT forms the basis for the improved patient outcomes observed in the published clinical literature and supports its use for temporizing wounds and protecting them from external contamination during long-term care.

Recently, other dressings, such as medical gauze, have been used with NPWT. One study reported that NPWT with gauze showed similar reductions in wound volume compared to published data from foam-based systems [23]. Both ROCF and gauze dressings are currently used with NPWT for the treatment of wounds and promote healing by providing a moist wound environment and acting on the removal of exudates. However, due to the differences in dressing interactions, gauze may not offer the same level of granulation tissue formation that is affected through macrostrain and microstrain with ROCF dressings [6, 16–19].

---

## NPWT Guidelines for the Management of Pressure Ulcers

A consensus panel of experienced wound care practitioners initially met in 2004 to develop an algorithm to assist physicians and clinicians regarding the use of NPWT in pressure ulcer treatment [24]. Two years later, another consensus panel met to expand upon the 2004 guidelines and further define the treatment algorithms for integrating the use of NPWT in patients with Stage III and Stage IV pressure ulcers [25]. Additionally, other guidelines exist for the use of NPWT in pressure ulcer management [26, 27].

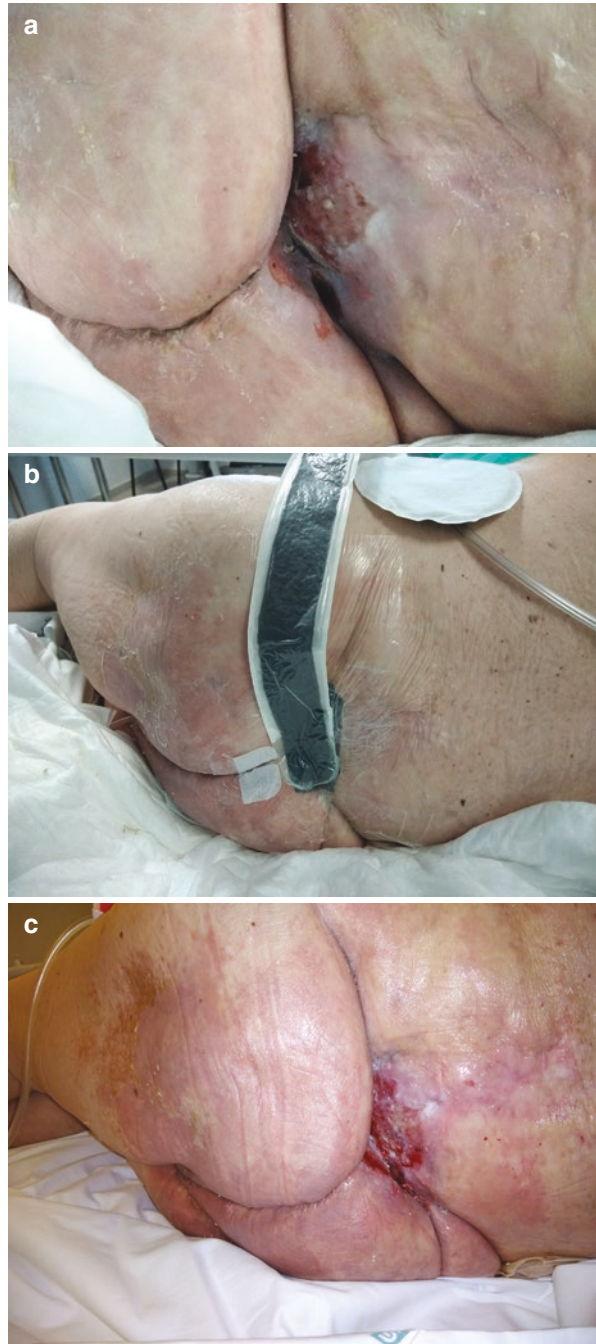
NPWT should be used in full-thickness skin defects: Stage III and Stage IV pressure ulcers (Fig. 14.1a–c). The dimension of the wound should be enough to allow an adequate contact between the ROCF dressing and wound bed and for safe removal of the ROCF. The decision to use NPWT is not necessarily determined by the depth of wound. Notably, NPWT may be used in either shallow or deep pressure ulcers, when the granulation tissue is poor or inadequate, and when there is a heavy exudate. NPWT can also be used with wounds that have undermining or tunneling. In addition to the contraindications listed in Table 14.2, the initial 2004 consensus panel established that the following wound characteristics would not be appropriate for NPWT use: wounds with inadequate beds, small wounds that do not allow the ROCF dressing to come in direct contact with the wound bed, freshly debrided wounds without adequate hemostasis, wounds with eschar, wounds with inadequate circulation, fibrotic wounds, and desiccated wounds [24].

Furthermore, NPWT must be used in pressure ulcers free of necrotic tissue; therefore, NPWT should begin after debridement. NPWT can be applied only in appropriate patients and should not be used with the following patient:

- untreated malnutrition
- patients who cannot tolerate pain that may be caused by NPWT treatment



**Fig. 14.1** Stage 3 pressure ulcer in the sacral area (**a**) before application, (**b**) with NPWT and (**c**) after 2 weeks of NPWT



- allergy or tissue intolerance to the adhesive in the drape used to seal the foam dressing
- patients who are unable to adhere to the treatment protocol
- patients with conditions as uncontrollable incontinence, hyperhidrosis or certain anatomic characteristics (e.g., creases or folds in body tissue) that make impossible to achieve a seal
- patients with bleeding disorders (e.g., platelet dysfunction)

Pressure ulcers managed with NPWT should be monitored at every dressing change [28]. Generally, dressing changes can be done every 48 h and can be extended up to 72 h (3 times a week), but in the presence of infection, the dressing change should be done every 12–24 h. Ultimately, dressing changes intervals should be based on manufacturer guidelines and clinician discretion.

Optimal negative pressure levels are not well established, but the typical range is between  $-75$  and  $-125$  mmHg. The optimal setting of NPWT in pressure ulcer is  $-125$  mmHg using the black foam and  $-125$  to  $-175$  mmHg using the white foam. In the case of pain, the pressure can be reduced in  $-25$  mmHg intervals, with a minimum pressure level of  $-75$  mmHg. In a patient who is of advanced age, emaciated, or taking an anticoagulant such as warfarin, the initial baseline pressure of  $-75$  or  $-100$  mmHg is recommended. If these pressure levels are tolerated, it is possible to increase the pressure to up to  $-125$  mmHg. Continuous negative pressure mode should be used for the first 48 h of treatment and can then be switched to intermittent negative pressure mode (5 min on, 2 min off) for the remainder of therapy [29]. In certain wound conditions, it is necessary to utilize the continuous negative pressure mode longer than 48 h or even for the duration of therapy. The patients or the conditions, in which the use of NPWT using the continuous mode longer than 48 h or for the duration of therapy are:

- discomfort with the use of intermittent mode
- anatomic issue (e.g., creases or folds in the skin) or wounds in difficult areas (e.g., perineal or toe wounds) that make difficult to maintain an airtight seal
- wounds with undermined areas or tunneling (in these wounds, the continuous negative pressure modes helps in the closure of the ulcer)
- wounds with heavy drainage after 48 h

The black foam could be used to stimulate granulation tissue while assisting in wound contraction. The utilization of white foam dressing is more appropriate for epithelialization, for protection of structure, for control of granulation tissue growth into the foam, for tunneled or undermined areas, and for patients who cannot tolerate the black foam due to the pain.

If the patient feels pain, the following are some strategies to reduce pain:

- switch from the black foam dressing to the white foam dressing
- use the continuous negative pressure mode in place of intermittent mode
- interpose a non-adherent meshed interface between the wound and the foam dressing
- use a protection skin product around the dermal wound margin
- use appropriate topical anesthetics or systemic analgesics
- moisten the foam dressing before removal

NPWT can be discontinued when the patient's wound is ready for a skin graft. If wounds do not progress or become worse, surgical reconstruction of the pressure ulcer may be necessary or another adjunctive modality can be used. NPWT can be used to help with the healing of flaps and to decrease the volume of the wound until the ulcer is superficial, using another dressing that can achieve a stable reepithelization. If after 2–4 weeks the pressure ulcer does not improve or deteriorates, the clinicians must evaluate the appropriateness of NPWT.

---

## Evidence on NPWT

Deva et al. [30] have shown that NPWT reduces the depth of pressure ulcers when compared to traditional forms of topical therapies [30]. This result is supported by a randomized clinical trial (RCT) by Joseph et al. [31] who reported that compared to wet-to-moist dressings, NPWT had a significantly higher percent change in pressure ulcer depth, width, and volume [31]. In contrast, a prospective randomized trial by Wanner et al. [32] found no significant difference between NPWT and wet-to-dry dressing in time-to-reach a 50% reduction of wound volume and formation of granulation tissue [32]. Nevertheless, a comparative retrospective study of 281 patients with pressure ulcers showed significantly better wound response, satisfactory wound closure, and time-to-reach closure with NPWT versus alginate or hydrocolloid dressing [33]. In a RCT comparing the efficiency of NPWT ( $n = 5$ ) or redon drain ( $n = 5$ ) to assist wound healing of stage III/IV pressure ulcers, Wild et al. [34] reported that the automated NPWT system provided significantly superior support. After an average of 8.5 days of treatment, the NPWT mean percent of granulation coverage of the wound bed was 60% higher than that of the redon drain group. Whereas the NPWT group showed a 27% reduction in fibrin tissue at the wound base, the redon group showed a 22% increase. Despite an initial plan to include 17 patients in each group, the study was terminated early due to the drastic difference in outcome. Additionally, NPWT required fewer dressing changes and was better equipped to maintain a steady negative pressure without leakage [34].

In 2011, de Laat et al. evaluated the reduction of wound volume using NPWT versus sodium hypochlorite dressings [35]. This study demonstrated a 50% reduction in the median treatment time in the NPWT group compared to group of patients treated with sodium hypochlorite dressing. Several studies have supported the use of

NPWT in conjunction with systemic antibiotics to treat patients with infected pressure ulcers. Isago et al. [36] reported a consistent reduction in wound depth and surface area after NPWT treatment of 10 patients with stage IV chronic pressure ulcers (mean 61.2% and 55.1 reduction, respectively) [36]. All wounds tested positive for bacterial contamination prior to treatment, and although only 3 wounds were deemed microbiologically clean after 4–7 weeks of treatment, all had substantially reduced in size. In a RCT comparing NPWT to a hydrogel wound dressing, the NPWT group had a higher percent reduction in ulcer volume and a decreased proliferation of inflammatory cells [37]. Ulcers treated with NPWT also exhibited improvement despite the presence of underlying osteomyelitis. A study by Yao et al. (2014) [38] that included patients with different ulcers of the lower extremity (diabetic foot ulcers, arterial ulcers, venous insufficiency ulcer and pressure ulcers) reported a greater healing rate in group of NPWT compared the control group.

Recently, NPWT with instillation and a dwell time (NPWTi-d; V.A.C. VERAFLOR<sup>TM</sup> Therapy, KCI, an Acelyty Company, San Antonio, TX) using an ROCF dressing with through holes (ROCF-CC; V.A.C. VERAFLOR CLEANSE CHOICE DRESSING; KCI, an Acelyty Company, San Antonio, TX) has been used in the management of pressure ulcers [39, 40]. Teot et al. [39] described their experience using NPWTi-d with ROCF-CC in patients with complex wounds, including pressure ulcers, that had viscous wound exudate and areas of devitalized tissue. Results showed that after 3 days of adjunctive use of NPWTi-d with ROCF-CC, the majority of the thick exudate and slough was removed from the during therapy [39]/ Fernandez et al. [40] reported on their initial experience using NPWTi-d with ROCF-cc in 5 pressure ulcer patients. The authors concluded that NPWTi-d with ROCF-CC “provided effective and rapid removal of thick exudate and infectious materials and promoted excellent development of underlying granulation tissue” [40]. Additional studies should be performed on larger patient populations to determine the efficacy of this therapy for pressure ulcer management.

---

## Economic Impact

Pressure ulcers are a serious health issue and can have a significant economic impact. The major cost drivers for wound care include time to healing, staff time, hospital stay, number of dressings, rate of infections and long waiting time from diagnosis to treatment [41]. Only a small portion of costs involve technical requirements to treat the wound. For instance, the cost of materials (e.g., dressings) typically accounts for 10–20% of the total cost of treating a patient [41, 42]. An initial study by Philbeck et al. [43] examined the cost effectiveness of NPWT as compared to standard therapy based on the total cost to heal a pressure ulcer of size. The authors found that it would take 97 days and cost \$14,456 to heal a typical 22.2 cm<sup>2</sup> trunk or trochanter wound with NPWT compared to 247 days and a cost of \$23,465 to heal the same size wound using standard therapy (i.e., saline-soaked gauze; based on the outcomes of Ferrel et al.) [44]. Multiple studies have suggested that use of NPWT for pressure ulcers may shorten the length of care and reduce healthcare

costs. A comparative retrospective study demonstrated that pressure ulcer patients treated with NPWT experienced lower rates of hospitalization and emergent care encounters compared to other treatment plans, providing an estimated cost savings of \$4209 per episode [45]. Research has also emerged indicating that early implementation is important to receive the full benefit of NPWT. In a retrospective analysis of 98 Stage III/IV pressure ulcer patients, the median length of home health agency (HHA) stay in the NPWT early initiation (within 30 days of start of HHA care) group was 85 days, as opposed to the 166-day median length of stay for the late initiation (longer than 30 days after start of HHA care) group. A greater percentage of patients in the early adoption group (42%) were discharged from home care during their first episode versus 3% in the late group. After controlling for patient demographic variables, regression analysis indicated that for each day NPWT was delayed, almost 1 day was added to the total length of stay [46]. Larger randomized studies are necessary to determine the cost effectiveness of NPWT compared to other wound therapies for the treatment of pressure ulcers.

---

### Conclusions

The literature suggests that NPWT is a valid option for the management of Stage III and IV pressure ulcers, but it is important to note that pressure ulcers require a multimodal approach. Rhee et al. [47] have performed a systematic review to evaluate the efficacy and safety of NPWT for the treatment of chronic wounds in the home setting. Although the authors found a paucity of well-designed and well-conducted studies, they concluded that “standardization of wound care research protocols, such as providing consistency in comparator groups, robust randomized study designs, larger trials, and common definitions of outcomes, would be helpful in providing evidence to inform decisions about the use of NPWT” [47]. In conclusion, further randomized clinical studies will be important to evaluate the efficacy and safety of NPWT in pressure ulcers.

---

### References

1. Banwell P, Musgrave M. Topical negative pressure (TNP) therapy: mechanisms and indications. In: Banwell P, Teot L, editors. 1st International Topical Negative Pressure (TNP) Therapy Focus Group Meeting, Proceedings London, UK 2003. London: European Tissue Repair Society; 2003. p. 73–88.
2. Porter R. Surgery. In: Porter R, editor. Blood and guts: a short history of medicine. 1st ed. London: Allen Lane/Penguin Books; 2002. p. 109–34.
3. Fox JW, Golden GT. The use of drains in subcutaneous surgical procedures. *Am J Surg.* 1976;132:673–4.
4. Fay MF. Drainage systems. Their role in wound healing. *AORN J.* 1987;46:442–55.
5. Fleischmann W, Strecker W, Bombelli M, Kinzl L. Vacuum sealing as treatment of soft tissue damage in open fractures. *Unfallchirurg.* 1993;96:488–92.
6. Argenta LC, Morykwas MJ. Vacuum-assisted closure: a new method for wound control and treatment: clinical experience. *Ann Plast Surg.* 1997;38:563–76.
7. Morykwas MJ, Argenta LC, Shelton-Brown EI, McGuirt W. Vacuum-assisted closure: a new method for wound control and treatment: animal studies and basic foundation. *Ann Plast Surg.* 1997;38:553–62.

8. Niezgoda JA, Mendez-Eastman S. The effective management of pressure ulcers. *Adv Skin Wound Care*. 2006;19:3–15.
9. Plikaitis CM, Molnar JA. Subatmospheric pressure wound therapy and the vacuum-assisted closure device: basic science and current clinical successes. *Expert Rev Med Devices*. 2006;3:175–84.
10. Schintler MV. Negative pressure therapy: theory and practice. *Diabetes Metab Res Rev*. 2012;28:72–7.
11. Scherer SS, Pietramaggiore G, Mathews JC, Prsa MJ, Huang S, Orgill DP. The mechanism of action of the vacuum-assisted closure device. *Plast Reconstr Surg*. 2008;122:786–97.
12. Erba P, Ogawa R, Ackermann M, et al. Angiogenesis in wounds treated by microdeformational wound therapy. *Ann Surg*. 2011;253:402–9.
13. Seo SG, Yeo JH, Kim JH, Kim JB, Cho TJ, Lee DY. Negative-pressure wound therapy induces endothelial progenitor cell mobilization in diabetic patients with foot infection or skin defects. *Exp Mol Med*. 2013;45:e62.
14. Orgill DP, Manders EK, Sumpio BE, et al. The mechanisms of action of vacuum assisted closure: more to learn. *Surgery*. 2009;146:40–51.
15. Lu F, Ogawa R, Nguyen DT, et al. Microdeformation of three-dimensional cultured fibroblasts induces gene expression and morphological changes. *Ann Plast Surg*. 2011;66:296–300.
16. Saxena V, Hwang CW, Huang S, Eichbaum Q, Ingber D, Orgill DP. Vacuum-assisted closure: microdeformations of wounds and cell proliferation. *Plast Reconstr Surg*. 2004;114:1086–96.
17. McNulty AK, Schmidt M, Feeley T, Kieswetter K. Effects of negative pressure wound therapy on fibroblast viability, chemotactic signaling, and proliferation in a provisional wound (fibrin) matrix. *Wound Repair Regen*. 2007;15:838–46.
18. McNulty AK, Schmidt M, Feeley T, Villanueva P, Kieswetter K. Effects of negative pressure wound therapy on cellular energetics in fibroblasts grown in a provisional wound (fibrin) matrix. *Wound Repair Regen*. 2009;17:192–9.
19. Morykwas MJ, Simpson J, Pungert K, Argenta A, Kremers L, Argenta J. Vacuum-assisted closure: state of basic research and physiologic foundation. *Plast Reconstr Surg*. 2006;117:121S–6S.
20. Wackenfors A, Sjogren J, Algotsson L, Gustafsson R, Ingemansson R, Malmstro M. The effect of vacuum-assisted closure therapy on the pig femoral artery vasomotor responses. *Wound Repair Regen*. 2004;12:244–51.
21. Kamolz LP, Andel H, Haslik W, Winter W, Meissl G, Frey M. Use of subatmospheric pressure therapy to prevent burn wound progression in human: first experiences. *Burns*. 2004;30:253–8.
22. Blume PA, Walters J, Payne W, Ayala J, Lantis J. Comparison of negative pressure wound therapy using vacuum-assisted closure with advanced moist wound therapy in the treatment of diabetic foot ulcers: a multicenter randomized controlled trial. *Diabetes Care*. 2008;31:631–6.
23. Campbell PE, Smith GS, Smith JM. Retrospective clinical evaluation of gauze-based negative pressure wound therapy. *Int Wound J*. 2008;5:280–6.
24. Gupta S, Baharestani M, Baranoski S, et al. Guidelines for managing pressure ulcers with negative pressure wound therapy. *Adv Skin Wound Care*. 2004;17:1–16.
25. Baharestani M, de Leon J, Mendez-Eastman S, et al. Consensus statement: a practical guide for managing pressure ulcers with negative pressure utilizing vacuum-assisted closure- understanding the treatment algorithm. *Adv Skin Wound Care*. 2008;21:1–20.
26. Whitney J, Phillips L, Aslam R, et al. Guidelines for the treatment of pressure ulcers. *Wound Repair Regen*. 2006;14:663–79.
27. National Pressure Ulcer Advisory Panel, European Pressure Ulcer Advisory Panel, Pan Pacific Pressure Injury Alliance. Prevention and treatment of pressure ulcers: quick reference guide. In: Haesler E, editor. Perth: Cambridge Media; 2014. p. 1–72. Ref Type: Report.
28. Wound Ostomy and Continence Nurses Society (WOCN). Guideline for prevention and management of pressure ulcers. 2. 1-1-2003. Glenview: Wound, Ostomy and Continence Nurses Society. WOCN Clinical Practice Guideline Series. Ref Type: Report.
29. V.A.C. Therapy Clinical Guidelines: a reference source for clinicians. 2004. San Antonio: Kinetic Concepts, Inc. Ref Type: Pamphlet.

30. Deva AK, Buckland GH, Fisher E, et al. Topical negative pressure in wound management. *Med J Aust.* 2000;173:128–31.
31. Joseph E, Hamori CA, Bergman S, Roaf E, Swann NF, Anastasi GW. A prospective, randomized trial of vacuum-assisted closure versus standard therapy of chronic nonhealing wounds. *Wounds.* 2000;12:60–7.
32. Wanner MB, Schwarzl F, Strub B, Zaech GA, Pierer G. Vacuum-assisted wound closure for cheaper and more comfortable healing of pressure sores: a prospective study. *Scand J Plast Reconstr Surg Hand Surg.* 2003;37:28–33.
33. Smith N. The benefits of VAC therapy in the management of pressure ulcers. *Br J Nurs.* 2004;13:1359–65.
34. Wild T, Stremitzer S, Hoelzenbein T, Ludwig C, Ohrenberger G. Definition of efficiency in vacuum therapy—a randomized controlled trial comparing Redon drains with V.A.C. Therapy. *Int Wound J.* 2008;5:641–7.
35. de Laat EH, van den Boogaard M, Spauwen PH, van Kuppevelt DH, van Goor H, Schoonhoven L. Faster wound healing with topical negative pressure therapy in difficult-to-heal wounds: a prospective randomized controlled trial. *Ann Plast Surg.* 2011;67:626–31.
36. Isago T, Nozaki M, Kikuchi Y, Honda T, Nakazawa H. Negative-pressure dressings in the treatment of pressure ulcers. *J Dermatol.* 2003;30:299–305.
37. Ford CN, Reinhard ER, Yeh D, et al. Interim analysis of a prospective, randomized trial of vacuum-assisted closure versus the healthpoint system in the management of pressure ulcers. *Ann Plast Surg.* 2002;49:55–61.
38. Yao M, Fabbri M, Hayashi H, et al. A retrospective cohort study evaluating efficacy in high-risk patients with chronic lower extremity ulcers treated with negative pressure wound therapy. *Int Wound J.* 2014;11:483–8.
39. Teot L, Boissiere F, Fluieraru S. Novel foam dressing using negative pressure wound therapy with instillation to remove thick exudate. *Int Wound J.* 2017;14:842–8.
40. Fernandez L, Ellman C, Jackson P. Initial experience using a novel reticulated open cell foam dressing with through holes during negative pressure wound therapy with instillation for management of pressure ulcers. *J Trauma Treat.* 2017;6(5):410.
41. Jencks SF, Williams MV, Coleman EA. Rehospitalizations among patients in the Medicare fee-for-service program. *N Engl J Med.* 2009;360:1418–28.
42. Centers for Medicare and Medicaid Services (CMS). MedCAC Meetings 3/29/2005—Usual care of chronic wounds. 3-29-2005. Baltimore: Centers for Medicare and Medicaid Services. Ref Type: Report.
43. Philbeck TE, Whittington KT, Millsap MH, Briones RB, Wight DG, Schroeder WJ. The clinical and cost effectiveness of externally applied negative pressure wound therapy in the treatment of wounds in home healthcare Medicare patients. *Ostomy Wound Manage.* 1999;45:41–50.
44. Ferrell BA, Osterweil D, Christenson P. A randomized trial of low-air-loss beds for treatment of pressure ulcers. *J Am Med Assoc.* 1993;269:494–7.
45. Schvien T, Gilbert J, Lang C. Pressure ulcer prevalence and the role of negative pressure wound therapy in home health quality outcomes. *Ostomy Wound Manage.* 2005;51:47–60.
46. Baharestani MM, Houliston-Otto DB, Barnes S. Early versus late initiation of negative pressure wound therapy: examining the impact on home care length of stay. *Ostomy Wound Manage.* 2008;54:48–53.
47. Rhee SM, Valle MF, Wilson LM, Lazarus G, Zenilman JM, Robinson KA. Negative pressure wound therapy technologies for chronic wound care in the home setting: a systematic review. *Wound Repair Regen.* 2015;23:506–17.



Alessandro Scalise, Caterina Tartaglione, Marina Pierangeli, Vania Recchi, Matteo Torresetti, and Luc Téot

The occurrence of pressure ulcers has an important influence on the patient's quality of life [1].

They cause significant pain and additional costs.

A chronic pressure sore is the result of various and interrelated factors that can not achieve a healing despite appropriate medical treatment.

The approach to the patient is multidisciplinary, with a primary systemic clinical evaluation aimed to correct any comorbidities and risk factors.

The surgical treatment of pressure sores allows to reduce the healing time and could be a challenging and therapeutic approach in case of failure of conservative treatment, especially in stage III and IV ulcers with the presence of infectious complications such as osteomyelitis or sepsis.

For this reason, the surgery time could have an important role but not always free from failures, complications and recurrences.

Therefore the treatment of pressure ulcers should be a multistep process where the surgical approach represents the final and resolute action [2].

---

## Definition of Pressure Ulcer

A skin lesion sprouts when there is tissue hypoxia causing a condition of reduced partial oxygen pressure. This condition brings to a vicious self-powered circle leading to the formation of a chronic wound.

---

A. Scalise (✉) · C. Tartaglione · M. Pierangeli · V. Recchi · M. Torresetti  
Department of Plastic and Reconstructive Surgery, Marche Politechnical University,  
Ancona, Italy  
e-mail: [chiplast@univpm.it](mailto:chiplast@univpm.it)

L. Téot  
Wound Healing Unit, Pôle EMMBRUN, Department of Surgery, Montpellier University  
Hospital, Montpellier, France



Skin microcirculation undergoes anatomical and functional abnormalities that involve cellular components of blood vessels and growth factors.

Ulcers have underlying ischemic mechanism possibly linked to an insufficient blood supply to a large tissutal area (arterial ulcer), or an obstructive disease of the small vessels due to immunological phenomena, or phlebostasis (venous ulcers), or ischemia due to compression of the blood vessels (pressure ulcers).

In case of pressure sores, pressure is the most important local factor as a cause of injury.

Studies conducted by Landis in the 30s reported that the pressure in the distal arteriolar capillary finger was 32 mmHg.

Incorrectly this pressure value could be able to collapse the capillaries with consequent tissue ischemia.

However later researches have confirmed that the pressure required to cause tissue hypoxia varies considerably according to the age of patients, the lesion site, and patient comorbidities [3].

The European Pressure Ulcer Advisory Panel (EPUAP) and American National Pressure Ulcer Advisory Panel (NPUAP) define the pressure ulcer as:

*“Lesion localized to the skin and / or to the underlying layers, generally in correspondence with a prominence, as a result of pressure, or pressure in combination with shear forces. A number of contributing or confounding factors are associated with pressure ulcers; the significance of these factors has yet to be elucidated”*[4].

---

## Staging of Pressure Ulcers

Pressure sores are classified [4] in stages according to their severity:

### I Stage: Nonblanchable Erythema

The skin is still intact but presents a nonblanchable erythema over a bony prominence.

The area affected by the lesion may be painful, hard, soft, warmer or cooler than the surrounding tissue.

This stage is the signal heralding ulceration unless appropriate preventive measures are taken (Fig. 15.1).

### II Stage: Partial Thickness

In this stage it detects a loss of partial thickness of the dermis.

The lesion may look like a vesicle intact or open / ruptured serum-filled or serum and blood-filled.

More often, however, it seems like a shallow open ulcer, the bottom appears pink, without slough or bruising.

In this category injuries that can be caused by stripping skin lacerations (*skin tears*), chemical burns patch, incontinence associated dermatitis, maceration or excoriation are not included.

### III Stage: Loss of Full-Thickness Skin

It 'a full-thickness ulcer with exposure of the subcutaneous adipose tissue, however, bone, tendon or muscle are *not* exposed.

Slough may be present, but does not hide the real depth of tissue loss.

The pressure ulcer stage III may include traits undermined and tunneling.

The depth of this category of lesions depends on the anatomical position: for example a lesion of stage III in the occiput (where there is no adipose tissue) may appear very superficial, while a lesion of Stage III at the ischial region can be very deep (Fig. 15.2).

**Fig. 15.1** I stage  
(black arrow) II stage  
(red arrow) ulcers



**Fig. 15.2** III stage ulcer

## IV Stage: Full Thickness Tissue Loss

It presents as an ulcerative lesion with full thickness tissue loss exposing bone, tendon or muscle.

It may be apparent slough or eschar, and often are undermining and tunnelling. The depth varies according to the anatomical site.

The exposure of support structures such as fascias, tendons, joint capsules or bones makes possible the establishment of an osteitis or osteomyelitis as a complication of the lesion to pressure (Fig. 15.3).

It describes an additional category of pressure sores [4], which we can classify as:

## V Stage. Not Stadiabile\Not Classifiable: Loss of Full-Thickness Skin or Tissue: Unknown Depth

In this category we can include lesions with ulcer depth completely hidden by slough (yellow in color, beige, gray, green or brown) and \ or eschar (beige, brown or black) in the wound bed.

The lesion can be classified more precisely only after the removal of slough and \ or eschar: it will determine the classification of the ulcer in stage III or IV.

In the case in which there is stable eschar (dry, adherent, intact without erythema or fluctuation) in calcaneal pressure sores, it should not be removed as it has the function of “natural (biological) body cover” (Fig. 15.4).

## Pre-Operative Phase

In this phase we have to consider different aspects of patient care, the general clinical evaluation, wound staging, the assessment of risk factors for LDP.



**Fig. 15.3** IV stage ulcer

**Fig. 15.4** V stage ulcer

### **Assessment of Risk Factors for Pressure Ulcers and General Clinical Evaluation**

The patient general clinical evaluation has to determine any possible comorbidity for the anaesthesiologic and surgical risk (ASA score).

Regarding the anaesthesiologic risk it is important to remember that in spine injured patients we could have some important peri-operative dangers, such as dysreflexia, bradycardia, hypotension, respiratory inadequacy and muscle spasms.

General anaesthesia of sufficient depth is effective in controlling spasms and autonomic dysreflexia but hypotension and respiratory dysfunctions are risks [5].

Therefore there is a growing consensus that, like in our experience, local anaesthesia with sedation is safe, effective and technically simple to perform.

From the general clinical point of view we have to consider:

- Age

Elderly patients are more susceptible to damage, especially due to pressure, because the aging skin is very thin with the presence of less subcutaneous adipose tissue, and with a reduced fibrotic / elastic support of soft tissues (50% reduced, compared to young patients).

In elderly patients there is also a lower perception of pain, which causes possible changes of spontaneous posture, especially at night, predisposing to the ulceration.

On the contrary, in older people, lesions tend to heal more slowly even in the presence of optimal diets and a good state of health because the ability to regenerate cells decreases.

Epidemiological data report that advanced age, if associated with pressure sores and infection, leading to an increase mortality rate (38% vs. 27% of death in the elderly patients, due to cardiovascular diseases, respiratory or cancer) [6].

- Immobility

In the bedridden patients there is a higher incidence of pressure ulcers, due to many risk factors involved in their pathogenesis.

Generally the bedridden patient is not-self-sufficient, resulting into difficult patient care, with several problems in his postural changes.

This complication exposes him to the same prolonged position with excessive pressure load on prominences bones, causing significant microcirculation distress.

In the particular case of bedridden patients with spinal cord injuries, in addition to immobility, we have nervous deficits involving vasomotor vessels control.

We should consider this peculiar feature during surgery because it could cause more bleeding due to less vasoconstriction, resulting in a higher risk of complication of flap vitality (Fig. 15.5).

- Haematological parameters,

Through the examination of the haematocrit and the haemoglobin value.

The possible anemic condition must be considered in case of blood loss associated with surgery.

On the other side, hypercoagulable conditions should be corrected as they can cause thrombosis and vascular damage of the microcirculation, triggering processes that culminate with limb ischemia [7].

Coagulation deficit instead are a problem for any excessive bleeding, both during the surgery itself and post-operatively, with the risk of bleeding and bruising [7].

- Nutritional parameters

A poor nutritional status determinate a major risk to develop pressure ulcers because the malnutrition leads to tissue atrophy with a reduction of the layers that serve as protective cushion in correspondence of bony prominence.

Also a proper nutritional regimen is essential to ultimate a successful surgery of pressure sores.

It has been shown that in malnourished patients there will have an increased percentage of morbidity and mortality, and, on the contrary, it has also been proven that a good nutritional status promotes reduction in the rate of complications.

Clinical parameter that objective a state of malnutrition is albumin (normal range 3.3–4.8 mg/dL; moderate malnutrition: 2.5–3.2 mg/dL; severe malnutrition <2.5 mg/dL) [7].



**Fig. 15.5** Entrapment syndrome typical patient with several and systemic risk factors

Patients who are in a condition of malnutrition must undertake a high protein diet so that they arrive at positive nitrogen balance with albumin value in the normal range [7].

Protein diet that can be implemented through simple additions to the daily diet (minerals, vitamins) or, in severe cases, such as patients unable to feed, through the use of parenteral and / or enteral supplements [7, 8].

When we evaluate the total caloric requirements, we have to consider the co-presence of febrile states, because all the conditions of hyperthermia increase the caloric requirements of 10% for each extra degree.

In the meantime we correct the nutritional aspect, we can better prepare the ulcer to surgery through conservative treatments [7].

- Kidney functions

The condition of renal failure, particularly in cases of terminal failure undergoing dialysis, requires careful evaluation of the sodium, potassium and water balance, especially if we have to take an intravenous therapy and / or parenteral nutrition.

In addition to that, we have always to consider the renal function if a high protein diet has to be started.

Highly enriched protein diet is a risk factor for metabolic acidosis, especially in patients with kidney disease.

We can monitor renal function through creatinine and azotemia values; if the patient is catheterized is useful to monitor urine output of the 24 h.

- Urinal infection and incontinence

The urinary tract infection should be handled and disposed before surgery, as a major risk of ulcer contamination.

It could be useful the catheterization of urinary tract, in addition to a specific antibiotic therapy and urine culture [9].

Urinal tract infection becomes a important point to manage in spinal cord injured patients, bedridden patients, elderly patients, because in this kind of patients is common urinary incontinence that is a important risk factor to infections of the surgical site.

- Pelvic Rx

It is performed to assess the presence of infectious processes in the bones of the pelvis and femur.

It is an important element to be evaluated preoperatively, and that will then guide osteotomies during surgery.

- Gastrointestinal functions

As well as urine, feces are one of the major source of contamination of the ulcers, in particular if coexist a faecal incontinence coexists.

It is important to make a bowel preparation during days before surgery [9].

It should be considered, according to the patient compliance, a temporary colostomy, a procedure that simplifies the management of the patient in the postoperative period.

- Systemic inflammatory diseases

As reported, many rheumatologic diseases are sources of important comorbidities.

In many cases the disease has a vasculitic component affecting the microcirculation, triggering tissue ischemia and hindering flap vitality.

Rheumatologic diseases therapy frequently requires the use of corticosteroids and / or immunosuppressive drugs.

It is well documented that immunosuppressors agents increased the surgical site susceptibility to infections, quickly evolving in more severe conditions.

The corticosteroids create a state of immune deficiency and hinder the wound healing through their catabolic tissue.

It should be remembered that all the immunocompromised conditions (HIV, hematologic patients, transplant patients) are particularly susceptible to infectious complications that can possibly compromise flap viability and patients clinical conditions.

### **Injury Assessment**

Various aspects to consider: localization of the lesion, dimensions of the lesion (clinical examination with the support of imaging) and infections of the wound.

In this context it is essential to:

- Try to solve eventual infection [10], with specific antibiotic therapy and advanced dressings and/or antiseptic agents.
- Prepare the wound bed to surgery through the debridement of necrotic tissue, (possible source of infection) and better define the actual size of the lesion to plan an adequate reconstructive treatment [11].
- Attempt to reduce the ulcer dimension through conservative treatment, using advanced dressing and NPWT.

### **Infective Assessment**

Numerous studies have reported that all chronic wounds are colonized by bacteria, usually present in most species and various strain.

The colonization does not hinder the process of tissue repair, which instead is more slowed or prevented by infections clinically overt [2].

The presence of infection clinically overt is mainly present in stage III and IV lesions, but it can be also found at the level of closed injuries (loculated abscess).

In 30% of cases, these are polymicrobial infections, and bacteria can include anaerobic (ex. *Bacterioides fragilis*) and Gram-negative (ex. *E. coli*, *Proteus mirabilis*, *Klebsiella* and *Pseudomonas aeruginosa*).

Infection is a risk of increased mortality in patients suffering from pressure sores (50% of patients in a nursing home suffering from wound plus infection undergoes death, compared with 27% of those suffering only from wound) [6, 12].

Currently there is no gold standard for the diagnosis of infection.

Therefore a specific clinical evidence in addition to a semiquantitative swab, followed by bacterial culture and sensitivity testing, according to Levine technique, is considered the best method [2].

It is known the importance of sensitivity testing because a not-specific antibiotic therapy (either topical or systemic treatment) increases only the risk of drug-resistance [2].

This resistance seems not to affect the advanced dressings with antiseptics agents.

In contrast, the antiseptic dressings may be affected by phenomena of cytotoxicity against the cell populations responsible for tissue repair.

The cytotoxicity is directly proportional to the amount of antiseptic necessary to perform stasis / bacterial killing [2].

Therefore antiseptics agents can be a complementary treatment to the specific antibiotic therapies to control the infections and bacterial growth [2].

The main agents are: silver, iodine, PHMB derivatives and hypochlorite derivatives.

They all have wide-spectrum activity, also against viruses and mycetes.

The use of silver dressings is especially recommended by the guidelines for the treatment of pressure ulcers with a higher risk of developing infections.

Actually, some systematic reviews documented that there are no indications for routine use of silver dressings to prevent infection.

The high cytotoxicity and irritating effect on tissues have decreased and discouraged the use, until few years ago, when they appeared on the market as 0.05% isotonic solution; they can exert a powerful antiseptic function (about 5–10 min), without any side effects.

They do not cause any imbalance in terms of the systemic sodium concentration and they can be used in colonized / infected wounds with remarkable results.

## Wound Bed Preparation

The removal of necrotic tissue techniques are: [2, 11, 13, 14].

- Autolytic debridement
- Enzymatic debridement
- Mechanical debridement
- Biological debridement
- Surgical debridement and “debridement with sharp”
- Technological debridement

### Autolytic Debridement

The autolytic debridement is a physiological process present in all types of wound that is supported through by a management in a wet environment.

It is a selective debridement of necrotic tissue, mediated by lysosomal enzymes present in the wound exudate.

Moist wound environment is maintained efficiently through the use of advanced dressings [11].

An “advanced dressing “is defined as the covering material having characteristics of biocompatibility and which ensures the creation of a moist environment at the interface between the wound and dressing. (Interaction of the medication with the tissue that originates a specific response) [2].

The role of advanced dressing is carried out by restoring and maintain the ideal conditions of the microenvironment.

Advanced medications have different actions: [2].



- Isolation from outside
  - Keep the temperature constant
  - Avoid contamination with bacteria outside
- The trigger autolysis necrosis
  - It is painless, but slow
  - It is permitted by the presence of lysosomal enzymes in ‘exudate
  - It may be favored by the addition of exogenous enzymes (e.g. Collagenase)
- Infection Control
  - Avoid further contamination with the external environment
  - The microenvironment created by dressing keeps under control the proliferation of bacteria
  - Dressings can be used with antiseptic agents
- Control of exudate
 

The exudate may contain multiple substances, including water, electrolytes, nutrients, mediators of inflammation, leukocytes, proteolytic enzymes (e.g. Matrix metalloproteinases—MMPs), growth factors and waste materials.

The MMPs break down the extracellular matrix to support cells, acting against the process of tissue repair.

In wound healing, exudate appears to promote healing in different ways, stimulating cell proliferation and the MMPs are generally present in an inactive form. In non-healing wounds (chronic wounds), exudate seems to have the opposite effect and contains high concentrations of inflammatory mediators and activated MMPs.

### **Enzymatic Debridement [11]**

The enzymatic debridement uses the action of lytic enzymes exogenous, applied topically in the form of ointments and/or gels.

This procedure can be complementary and adjuvant to autolytic debridement and it is indicated in patients who can not be subjected to a mechanical and surgical debridement, such as patients on anticoagulation therapy.

### **Mechanical Debridement [11]**

This kind of debridement uses:

- Dry gauze
- Wet-to-dry
- Impregnated gauzes
- Dressings monofilament fibers

### **Biological Debridement: Biosurgery [11]**

This method uses fly larvae (bred in sterile conditions) that selectively remove necrotic tissue.

### **Surgical Debridement and Sharp Debridement [11, 13, 14]**

Sharp debridement refers to an ambulatory procedure, with the term “surgical” we mean a procedure in the surgery room.

The surgical approach can be followed directly by the surgical phase of excision, osteotomy and reconstruction.

The indication for this approach is the presence of a major and compact necrotic tissue, and serious infections that can benefit from a rapid debridement.

The speed and effectiveness are the benefits of this aggressive approach, compared to the submentioned types of debridement.

We can yet notice an increase of invasiveness, pain, risk of bleeding.

We can point up that in clinical practice, surgical debridement / with sharp debridement is usually the first approach, followed or supplemented by a more conservative treatment.

### **Technological Debridement [11]**

In this procedures we use technologies classified into:

- DDT: direct debridement technologies
- IDT: indirect debridement technologies

The main technologies are:

- Negative Pressure – NPWT [11]

It is an IDT therapy which uses devices capable of applying a sub-atmospheric pressure above the lesion.

It allows to remove exudate, to reduce edema surrounding skin, bacterial contamination and to contract the injury.

Among all technological debridement methods, NPWT is particularly indicated in the pre-operative phase, for its capacity to reduce the lesion size, one of determinants of surgical reconstructive choice.

In case of infected wounds, it is recommended to use devices capable of instilling an antiseptic solution achieving an important antimicrobial effect in the microenvironment.

The subatmospheric pressure applied to the lesion is an important parameter in the use of NPWT.

In literature is infact reported that a negative pressures (not above 150 mmHg) applied in an intermittent way allows to reach the best effects on the lesion.

- Hydrosurgery debridment [11]

It is a DDT and it uses jets of solution at high pressure to remove necrotic tissue; we can use antiseptic solutions, with an important advantage for the lesions.

- High frequency ultrasound debridement [11]

It is a DDT procedure that uses high frequency ultrasound (1–3 MHz).

They can be used on any type of tissues.

---

## **Surgical Phase**

The surgical procedure consists of three phases:

- Removal of the ulcers
- Osteotomy
- Reconstruction

## Removal of the Ulcer [10]

- Swab taken inside and on the bottom of the lesion. (Useful for specific postoperative antibiotic therapy)
- Infiltration of the ulcer with the methylene blue, to mark the walls of' ulcer, facilitating its complete removal.
- Excision of the wound, to reach a radical removal of all walls including the bottom.

At this step we clean up the site of the lesion outlining the actual size of dead space to fill.

The purpose of the excision is to have a cavity with healthy and vascularized walls.

Pathologic examination of the ulcer removed is recommended, because among the complications less frequent but no less significant, we must also consider the carcinomatous degeneration of the lesion to pressure, described in 1820 by Marjolin.

About 0.5% of all chronic wounds degenerates into a squamous cell skin cancer. Generally the latency time is very long (about 22 years), but then its evolution is very rapid with 2-year mortality of 80% of the cases [12, 15] (Fig. 15.6).

## Osteotomy [10]

We can remove any bony prominences and possibly infected bone portions; it is essential to have the pre-operative radiological examination .

The bone removal depends on different cases, if we have minimal bone infection without any evident osteomyelitis, we just remove the necrotic cortical bone until we reach the vital bone; when it is an important osteomyelitis we need to practice more massive osteotomies.



**Fig. 15.6** Neoplastic degeneration of the ulcers

Complications of osteotomies:

- Excessive bleeding
- A skeletal instability
- Muscle deficit (trochanter resection)
- Changes in the distribution of body weight (coccygectomy altering the weight distribution during sitting posture, encouraging relapses)

## Reconstruction

The reconstructive choice must be carried out according to various criteria:

- Localization and size
- Regional vascularization
- Performance status of the patient
- Previous surgery

It is also important to consider the less traumatic option and best outcomes. Our available choices are:

- **Direct Closure (rarely used for LDP)**  
It is rarely indicated in patients with pressure sores, as it requires healthy, abundant and vital tissue to have lesion resolution. Despite being a fast and a traumatic method, that does not invalidate any re-interventions, it is restricted by the limited availability of tissue, intrinsic feature of a pressure sore. Moreover, even if we can perform a direct closure, it is an increased risk of relapse [9].
- **Grafts**  
From a surgical point of view this procedure is quick and easy. Usually in patients with pressure sores we have abundant donor sites. However, the scarcity of tissue thickness let this technique leaves the only complementary role during interventions using muscle flaps.
- **Flaps**  
In the surgery of pressure sores the most useful flaps are:
  - **Fasciocutaneous flaps**  
They consist of a muscle fascia, overlying skin and subcutaneous tissue. This kind of flaps is very resistant to ischemic conditions [11]. Another advantage is that muscles are not involved, so we do not eliminate any future reconstructive options using muscle flaps. They are indicated in those patients without spinal cord injuries because they does not cause injury to muscles [10]. However, they have the disadvantage of being low mobility flaps.

They are frequently used in ulcers that do not require excessive thicknesses of tissue, preferably without osteomyelitis and not subjected to high pressure [9].

– **Miocutaneous flaps**

They consist of a single anatomic myo-cutaneous unit, where the skin overlying the muscle receives blood from the underlying muscle portion [10].

The advantages of such flaps are the intake of large amount of vascularised tissue, useful in those lesions with lot of tissue loss and high pressure load [9–11]. On the contrary, these solutions are more susceptible to ischemia and muscle atrophy [11].

We also could, partially or totally, compromise the muscle function, factor to be considered if the patient is young, still deambulatory or without spinal cord damage [9–11].

In addition to that the donor area is subjected at risk of relapse for reduction of the “cushioning effect” [11].

The indications are important extension of dead space, presence of osteomyelitis, anatomical areas subjected to significant pressure loads and require thicknesses of tissue to distribute this load [9].

– **Muscle flaps**

They are only made of muscle, and require a skin graft to complete the coverage of the ulcer.

Their use is limited to cases where they are the only possibility to close the lesion [9].

– **Perforator flaps**

“A perforator flap is a flap Consisting of skin and / or subcutaneous fat. That the vessels supply blood to the flap are isolated perforator (s). Perforators These may either pass through or between the deep tissues (mostly muscle)” [16]

The advantages of this technique is the minimal donor site morbidity, being a muscle-sparing technique, compared to a very good outcome in the long term.

The second advantage is the excellent mobility, guaranteed by the vascular pedicle, which therefore allows a good ulcer coverage [17].

In the approach to flap surgery, there are some important recommendations: [11].

- Draw the flap providing the supply of composite tissue to improve reliability, but without violating the adjacent angiosome to preserve future reconstructive options.
- Use large flaps with sutures localized away from ulcer excision and from areas of pressure load, with minimal tension, considering possible functional losses and the possible of postoperative rehabilitative recoveries.
- Prepare an alternative flap option in case of problems during surgery

---

## Sacral Ulcers

### 1. Random fasciocutaneous flaps [10].

They have not specific vascularization but an excellent resistance to ischemia; they are based on the vascular plexus arising from the fascia and goes in the subcutaneous tissue and in the overlying skin. However they show a reduced mobility.

**Fig. 15.7** Random fascioscutaneous flaps



They are generally rotation flaps, drawn without any particular rules (Fig. 15.7).

2. Myo-cutaneous flap of the Gluteus Maximus [10].

In the early 70s first publications on the use of muscle and myo-cutaneous flaps based on Gluteus Maximus appeared.

**Anatomy—Vascularization.**

The Gluteus Maximus connects the pelvis to the femur. It is a voluminous mass of superficial gluteal region.

It has numerous heads of origin, the iliac crest, the posterior gluteal line, side surfaces of the sacrum and coccyx.

The muscle bundles are directed sideways below the gluteal tuberosity of the femur.

Vascularization is permitted by 2 pedicles

- Superior Gluteal Artery
- Inferior Gluteal Artery

They emerge respectively from the top and from the bottom edge of the piriformis muscle.

We can raise the flap involving only a single portion, superior or inferior, or both.

**Surface Landmarks—Surgical Technique.**

The mio-cutaneous flap of gluteus maximus can be raised as rotation flap for ischial wounds and as an advancement flap (with VY technique) for sacral wounds.

In case of extended sacral wounds it is possible to raise a bilateral flaps.

In the preoperative planning the draw of the border of the flap is performed with the patient in the prone position.

We draw a triangle that has the ulcer as base and the apex is laterally.

The design of the skin island is placed in the upper or lower half or lower of Gluteus Maximus, depending on the portion of muscle we decide to use.

It involves the skin, the subcutaneous tissue and the fascial layer until the muscle, that are separated in the same direction without including the Middle Gluteus.

We then cut the sacral and femoral muscle insertions.

At this point, the flap is advanced and the donor area is closed with the VY technique.

If we have to perform a bilateral flap, the procedure is carried out on the opposite Gluteus Maximus.

### 3. Transverse flap of the back [10].

It is an axial, fascio-cutaneous flap, therefore it does not involve muscles, being a valid option in patients with high functional demand.

However, it has the disadvantage of requiring a graft to close the donor area, which can be important in size and particularly visible on the back.

Vascularization is based on lumbar and intercostal perforators vessels.

#### **Surgical Technique—Surface Landmark.**

It is an axial skin flap, with a transverse orientation in the lumbar region, immediately cranial to the wound.

The base is placed on one side, at the level of muscle erector spinae.

The flap can have a ratio of length to width of 2:1.

The lateral margins can be extended to the posterior axillary line.

Once raised the flap, the ulcer is covered through a rotation movement; the donor area is closed using a skin graft.

### 4. SGAP [10, 18].

This flap, prepared for the first time by Allen Tucker in 1993 and published in 1995, includes the use of adipo-cutaneous tissue supplied by a branch of superior gluteal artery perforator without the sacrifice of the underlying structures.

The function and the mass of the gluteus maximus muscle remain well preserved.

It was also recognized that the more the dissection of the vascular structures proceeded through the muscle, the more the length of the pedicle significantly increased, making the flap movements easier or performing vascular anastomosis in case of free flap.

It is indicated for the coverage of ischiatic and sacral pressure sores.

#### **Anatomy—Vascularization.**

The superior gluteal artery is the branch of the posterior division of internal iliac artery.

It is the most massive of the branches.

He leaves the pelvis at the upper edge of the piriformis muscle and enters into the buttock where it divides into a *superficial branch* and a *deep branch*.

#### **Surgical technique—Surface Landmark.**

The preoperative drawings are usually made the day before surgery with the patient in the prone position.

The posterior superior iliac spine and the greater trochanter are marked, and a line joining these two points is drawn, which is approximately the upper edge of the piriformis muscle.

The superficial branch of superior gluteal artery emerges in proximity of the junction of the proximal third and the middle third of this line.

The vessels are indicated using a Doppler probe, and we draw the flap planning around them.

The flap has an ellipsoidal shape, with dimensions of about  $22 \times 8$  cm.

Potentially the length of the vascular pedicle is about 10 cm, if the dissection is set up to the Superior gluteal artery.

The donor area of the flap is properly with a direct closure.

It is useful to position one or more drains in the most lateral incision to decrease postoperative discomfort of the patient (Fig. 15.8).

The most important anatomical structures we encounter in the gluteal region during dissection are:

- The sciatic nerve
- The inferior gluteal artery
- The internal pudendal artery
- The posterior femoral cutaneous nerve.

They emerge from piriformis muscle; they require attention during the dissection procedures to prevent iatrogenic injuries.

The sciatic nerve is the most frequently damaged when traction is applied on the piriformis muscle to expose the superior buttocks vessels.

If the retractile force is transmitted to the sciatic nerve, the patient will complain paresthesia for several days.

#### 5. IGAP [19].

Allen and Tucker in 1993 used the same technique initially applied to the flap S-GAP also for the lower gluteal artery to realize the I-GAP flap.



**Fig. 15.8** SGAP with V-Y technique for the direct closure of the donor area



Among the advantages of the latter it is to report the location of the scar, cosmetically acceptable, reliable anatomy, a donor site with good volume, a solid consistency of the adipose tissue.

For the anatomical proximity they are ideal reconstructions for sacral and ischiatic wounds.

**Anatomy—Vascularization.**

The IGA is the largest division of the branches of the anterior trunk of internal iliac artery.

It descends between the greater trochanter and the ischial tuberosity, together with the sciatic nerve and femoral cutaneous nerve, covered by the gluteus maximus muscle.

Then come into the buttock and resolves in the terminal branches.

**Surgical technique—Surface Landmark.**

The draws are made with the patient in the prone position.

The lateral margin of the sacred, the greater trochanter, and the ischial tuberosity are marked. These drawings respectively identify the origin, insertion and bottom edge of the gluteus maximus muscle.

We draw a horizontal skin lozenge of about 4 cm above the lower gluteal fold.

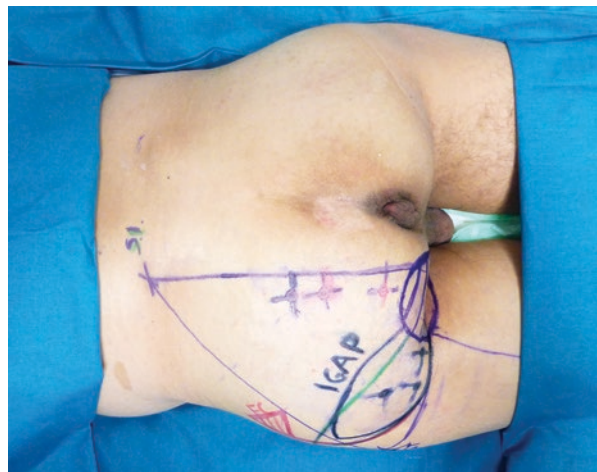
The flap width should be from 10 to 12 cm; it can provide closing of the donor area without tension.

The length of the flap is usually from 20 to 26 cm, and extends from the ischial tuberosity, medially, to the greater trochanter, laterally.

Potentially the length of the vascular pedicle may be about 10 cm, if the dissection continues until the inferior gluteal artery and vein (Fig. 15.9).

The donor area of the flap can be closed with a direct closure.

One ore more drainages are positioned in the most lateral incision to decrease the discomfort of the patient in the postoperative.



**Fig. 15.9** IGAP pre-operative draw

The most important anatomical structures we encounter during dissection are:

- Sciatic nerve
- Inferior gluteal artery
- internal pudendal artery
- femoral cutaneous nerve

They emerge from piriformis muscle and they require attention during the procedure to prevent iatrogenic injuries.

---

## Trochanteric Ulcers

Approaching trochanteric ulcers we should remember:

- The trochanter is an important anchor point muscle, so we must pay attention to any osteotomies
- Presence of bursae that can be possible site of infection and / or calcifications, which must eventually be removed.

### 1. Tensor fascia lata Mio-cutaneous flap [10].

#### **Anatomy—Vascularization.**

M. Tensor Fascia Lata originates from the iliac crest and continues in the ilio-tibial tract.

Vascularization of the muscle is given by lateral circumflex femoral artery which gives origins to the perforator vessels.

Perforator vessels breakthrough the medial muscle flap to a point localized at 8–10 cm from the anterior superior iliac spine (ASIS).

#### **Surface Landmarks—Surgical Technique.**

For the flap planning we initially mark, on the skin, the perforator's reference point, located about 8–10 cm inferiorly to ASIS.

The limits of the flaps are:

- Anteriorly, a line from the ASIS to the lateral condyle of the knee.
- Posteriorly, a vertical line passing through the greater trochanter
- Inferiorly, a line extends up to approximately 7–8 cm from the knee (Fig. 15.10).

The flap raising proceeds in a distal-proximal direction and includes muscular fascia.

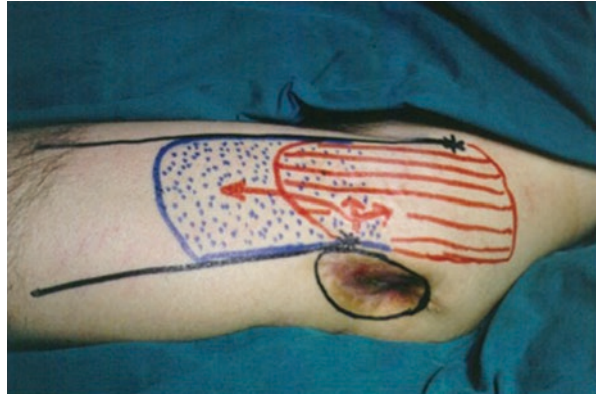
Once located the reference point of cutaneous vessels, the flap is rotated to cover the trochanteric ulcer.

In this case it necessarily forms a “dog ear” which requires a second remodelling surgery.

It is possible to raise it as an island flap, avoiding the formation of the “dog ear”.

### 2. Vastus Lateralis Muscle flap [10].

**Fig. 15.10** Tensor fascia lata Myo-cutaneous flap pre-operative draw



### **Anatomy—Vascularization.**

The vastus lateralis of the quadriceps femoris extends from the greater trochanter and the gluteal tuberosity to the patella.

The muscle is located deeply to the fascia lata, important surgical consideration.

The overlying skin is supplied by the fascia lata vascularization and it is independent of the vastus lateralis; therefore this flap is only a muscle flap.

Vastus lateralis is an expendable extensor muscle of the leg that could be replaced by the quadriceps.

Vascularization of the muscle is provided by:

- Descending branch of the lateral femoral circumflex artery
- Large artery in the vastus lateralis (originating from both the lateral circumflex that the profunda femoris artery)

The vessels reperi point in the skin surface is about 10 cm from SIAS.

### **Surface Landmarks—Surgical Technique.**

The incision from the trochanteric margin of the ulcer extends obliquely towards the patella, remaining 10–15 cm distal to the ASIS.

It is made through the fascia lata and until the vastus lateralis and the rectus femoris, between with a definite cleavage plane between two muscles.

The dissection proceeds in distal-proximal direction, going to cut the distal insertions of vastus lateralis, to mobilize the muscle.

At this point, the flap can be rotated to cover the lesion.

It can also be raised as an island flap, dissecting even the proximal insertions of the muscle.

The advantage of the island variant is to allow a greater range of motion, useful in difficult rotation coverages.

After that we have to proceed to closure using a skin graft.

3. PFAP (described in the section of the ischial ulcers).
4. LCFA—Tensor Fascia Lata Perforator Flap [20].

**Anatomy—Vascularization.**

The lateral femoral circumflex artery vascularizes a large area of the thigh.

It is divided into three branches: the ascending, transverse and descending, which carry blood to the superolateral, anterior and anterolateral skin of the thigh.

The lateral circumflex artery runs deep to the sartorius muscle and the rectus femoris and at this level divides into its three branches: ascending, transverse and descending one.

The descending branch is useful for the preparation of the perforator flap, it originates medially to the vastus lateralis of the femur.

**Surface Landmarks—Surgical Technique.**

The flap may extend from the iliac crest (proximally) to the lateral condyle of the femur (distally).

The cutaneous territory of this flap is localized over the vastus lateralis of the femur, delimited at the front (medially) from the rectum of the femur and posteriorly (laterally) from iliotibial tract.

Vessel must be researched in the plane between the rectum and the vastus lateralis.

The patient is placed in the supine position and we draw a line from ASIS to the lateral border of the patella; it coincides with the septum between the vastus lateralis and the rectus femoris.

We draw a circular area of about 6 cm, having the largest number of perforators, in the middle of this line.

The size of flap obtainable using a single perforator is about 22 cm length and 8–9 cm width.

If we need a greater amount of skin it is advised to include more than one perforators during the flap raising.

The incision is made along the medial outline, until the muscle fascia.

The dissection proceeds superficially to the fascia, until the isolation of the perforator vessel previously reported with the Doppler probe.

Once we find the perforator, we cut the lateral margins of the flap, and then we detach it medially until we reach the perforator in order to raise the island flap.

Then we proceed to skeletonization of the perforator, which can be settocutaneous or musculocutaneous.

Potentially, the vascular pedicle can be 8–12 cm long.

---

**Ischial Ulcers**

1. Myocutaneous flap of Gluteus Maximus (described in sacral ulcers).
2. Myocutaneous flap of m. Biceps Femoris [10, 21].

**Anatomy—Vascularization.**

The biceps femori originates from ischial tuberosity (long head) and linea aspera (short head) and takes insertion in the fibula and lateral condyle of the tibia.

Vascularization comes from the perforators of the Profunda Femoris Artery, emerging in the the space between the Biceps Muscle and medial muscles of the thigh, in the upper half of the flap.

It can be raised both as miofasciocutaneous and fasciocutaneous, depending on the amount of tissue to cover the ulcer.

**Surface Landmark—Surgical Technique.**

The preparation of the fasciocutaneous flap can be performed with the VY technique or as an advancement / rotation flap.

- The advancement flap with the VY technique

The flap is prepared in the posterior thigh, starting from the bottom edge of the ulcer; it involves the skin and fascia covering the muscle biceps femoris proceeding in the medial-lateral direction and then is advanced to cover the ischiatic lesion with VY technique

- Fasciocutaneous advancement / rotation flap with medial vascular pedicle

The incision proceeds from the lower margin of the ulcer in the lateral portion of the thigh to the distal edge of the designed flap.

We then proceed with the subfascial dissection extending to the semimembranosus and semitendinosus muscles.

Finally the flap is advanced / rotated to cover the wound.

The mio-fascio-cutaneous variant of the flap is always performed from the bottom side of the ulcers, to continue in the lateral portion of the thigh to the distal region of it.

It is then cutted the distal insertion of the biceps femoris muscle and the dissection proceeds in a distal-proximal direction, up to about 10 cm from the origin of the ischial tuberosity, preserving the proximal pedicles.

Once dissection is completed the flap is raised and overturned on itself to fill the ischiatic defect.

Subsequently, the fasciocutaneous flap is advanced / rotated over it to cover everything.

3. Gracilis Muscle flap [10].

**Anatomy—Vascularization.**

The Gracilis muscle origins near the pubic symphysis at the front face of the ischiopubic ramus.

It takes insertion on the medial aspect of the tibia and its distal tendon, together with those of the semitendinosus and sartorius muscle, form the “goosefoot”.

The dominant vascular pedicle arises from the medial circumflex femoral artery (branch of profunda femoris artery) that enters the muscle, in its proximal third, 10 cm below the pubic symphysis.

We have also a secondary pedicles from the obturator artery and the superficial femoral artery.

The main pedicle gives a safe supply to all the muscles and allows a wide arc of rotation especially if the muscle is removed from its proximal insertion.

The flap can be used as a muscle flap (and thus it requires a graft to complete the coverage) or as a myocutaneous flap.

If we use the miocutaneous variant, we must take a skin area going 2–3 cm beyond the margins of the muscle, in its proximal portion.

**Surface Landmark—Surgical Technique.**

The muscle is located just posterior to a line joining the pubic symphysis to the medial condyle of the tibia; we have to cut in the distal 2/3 of that line, isolating the Gracile muscle tendon.

The muscle is raised in a distal-proximal direction, going to search the vascular pedicle in the 1/3 proximal of it.

The flap is then transposed into the lesion to be filled.

4. Hamstring Flap [10, 21].

**Anatomy—Vascularization.**

The flap of Hamstring is a myocutaneous flap of the posterior thigh.

The muscles of the posterior thigh are also known as the Hamstring muscles.

From lateral to medial these muscles are:

- biceps femoris
  - origin: ischial tuberosity (long head) and line aspera (short head)
  - end: fibula and lateral condyle of tibia
- semitendinosus
  - origin: ischial tuberosity
  - end: medial surface of the body of the tibia
- semimembranosus
  - origin: Ischial tuberosity
  - end: medial condyle of the tibia

The main source of cutaneous vascularization comes from the profunda femoris artery (PFA) perforators.

It is important to remember that each Perforators of PFA gives a posterior ad a lateral branch.

The posterior branches supply the Hamstring musculature and overlying skin.

**Surface Landmark—Surgical Technique.**

This triangular flap is raised on the posterior aspect of the thigh, with the base coincident with the edge of the caudal ulcer.

The muscles of the flap are removed proximally and distally to facilitate its mobilization, its proximal advancement and its suture to the edge of the Maximus Gluteus .

The donor area is closed directly with the VY technique.

5. PFAP -1 and – 2 [21].

The thigh has become a rich source of .perforator flaps perfused by the medial and the lateral femoral circumflex arteries.

A first perforator flap coming from this region was performed in 1984 by Song et al.

The knowledge of various fasciocutaneous flaps in the posterior region of the thigh together with the knowledge of the vascular anatomy of this area allows us to recognize many perforator flaps.

**Anatomy—Vascularization.**

The profunda femoris artery originates from the lateral surface of the femoral artery approximately 3.5 cm below the inguinal ligament from the bifurcation of the common femoral artery.

Its main collateral branches are:

- Medial femoral circumflex artery
- Lateral femoral circumflex artery
- 6 perforators vessels

The main source of cutaneous vascularization of the posterior lateral surface of the leg is provided by the first and second profunda femoris artery perforators (PFAP-1, PFAP-2).

The medium-posterior surface of the thigh is vascularized by the medial femoral circumflex artery, by the musculocutaneous perforators, by the first branch of the medial profunda femoris artery, and, distally, by the fourth branch of the profunda femoris artery (PFAP-4).

The median posterior surface of the thigh is vascularized by a branch of the inferior gluteal artery, by a branch of the third perforator of the profunda femoris artery (PFAP-3) and, distally, by a perforator of the popliteal artery.

In the raising of perforator flaps we have to refer to perforator vessels, directed through the adductor muscles to the skin of the lateral thigh, where they originate the suprafascial plexus.

Typically these flaps are arranged on the first and the second perforator of the profunda femoris femoral artery, because of their calibers and usually Doppler valid signal.

**Surface landmark—Surgical technique.**

We draw the flap with patient in the prone position.

The perforators are to be checked through Doppler probe.

The first perforator of PFA pierces the deep fascia of the thigh approximately one third of the distance from the greater trochanter to the lateral condyle.

The PFAP-2 usually is the largest; it enters the surface 4 to 6 cm below the ischial tuberosity.

Once the perforator are localized, we perform an elliptic drawing including the perforators.

The major axis of the flap has to be oriented along the femoral axis and it should have a length of about 15–20 cm and a width of 8 cm (depending on the tissue laxity) to allow the direct closure of the donor site .

As the flap is raised it should be preserved the largest perforator among PFAP-1 and PFAP-2.

We have to remember that in some particular case we use the Propeller variant, which consists in a 180° rotation of the flap around its pedicle.

This technique represents a valid and reliable alternative for coverage of complex, large, late-grade ischiatic pressure sores because of its possibility to rotate as

a propeller and its vascular safeness, using the posterior region of the thigh as the donor site, which is a suitable area for its vascular and integumentary aspects.

The key point consists on a skeletonized vascular pedicle of sufficient length to avoid kinking of the perforator, resulting in ischemic flap [17].

#### 6. PFAP—am [21].

This flap, also known as adductor flap, can also be used as pedicled flap for ischiatic or perineal lesions .

The perforator the flap is based on is the musculocutaneous perforator artery, among the largest of the human body (0.8–1.1 mm).

It originates about 8 cm below the inguinal fold and 2 cm posterior to gracilis muscle.

It allows the use of a large amount of tissue (up to 25 × 10 cm) with the problem of donor area closure by skin graft. The max length of the vascular pedicle is 8–9 cm.

The “frog legs” patient position could be useful during the pre-operative drawing, to accentuate the gracilis muscle.

---

## Post-Operative—Treatment

In the post-operative care must be taken of two aspects of patient care:

- General clinical conditions
- Flap care

### General Clinical Condition

In the acute phase it is important to monitor patient parameters that may indicate an excessive blood loss, such as hematocrit, hemoglobin and blood pressure.

Check the drainage is also important to monitoring the post-operative bleeding [9].

A high-protein and high-calorie diet is recommended, especially in elderly and malnourished patient.

The positive nitrogen balance is important for the wound healing.

Protein diet that can be implemented through simple additions to the daily diet, or in severe cases as in patients unable to feed themselves, through the use of supplements parenteral and / or enteral [7, 9, 22].

Always consider whether the patient is in chronic renal failure.

It is important to remember the usefulness of bladder catheterization that allows us to avoid contamination of the surgical site with the urine and at the same time allows us to assess the kidney function [7].

It is recommended to start a systemic antibiotic therapy in order to follow the result of the swab performed in the intra-operative phase, on indication of the antibiogram.



## Flap Care

To maximize the chance of engraftment is necessary to avoid the load and the mechanical stress of the flap [9].

The discharge is implemented through the adoption of fluidized beds [2, 9, 22].

Generally it is maintained for 2–3–4 weeks [2, 9].

It is recommended to keep the wound clean, avoiding the possible contamination with urine and feces [23, 24].

For this purpose it is useful catheterization and adopting a diet with low fiber intake [9].

It should be taken into account, according to patient compliance a temporary colostomy, a procedure that simplifies the management of the patient postoperatively.

Acute charged to the flap that can occur are:

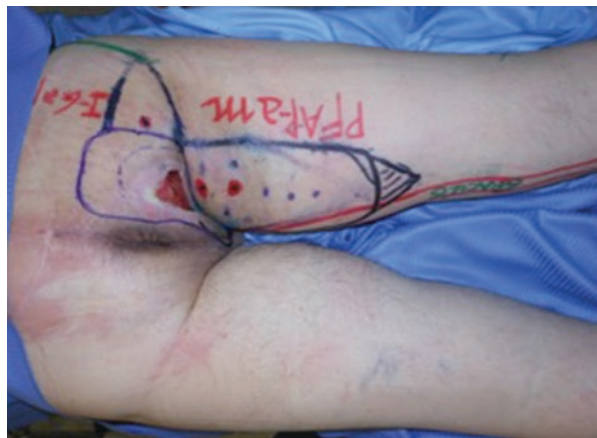
- Seromas
- Hematomas
- Ischemic distress

To avoid the formation of seroma and hematoma it is important the position and maintenance in place of one or more drainages [22], which are kept in place for more time compared with normal surgical procedures, for approximately 10–15 days post-operative.

If there are formations of fluid accumulation not evacuated from the drainages, it is recommended a quick action to remove them.

Because a collection can become infected and/or cause dehiscence of the surgical incision [9] (Figs. 15.11 and 15.12).

The therapy with hyperbaric oxygen (HBO) is indicated if it is found a suffering ischemic area and in those cases where ischemia is linked to vascular problems that reduce the microvasculature.



**Fig. 15.11** Dehiscence of the surgical reconstruction: Pre-operative PFAP-am flap drawing

**Fig. 15.12** Several and major complication in the post-operative



The start of therapy to prevent and minimize ischemic lesions should be started as soon as the first sign of ischemia appear, or within the first 36 h.

The treatment protocol involves 20 sessions to 2.0–2.5 ATA 60 min each. (ata = absolute atmosphere) [11].

The rationale underlying the HBO are: [11].

- Vasoconstrictor action in the normal tissue with redistribution of blood supply to hypoxic tissues
- Antiedema action which enhances the trophism of the traumatized tissues
- Protective effect against damage by ischemia / reperfusion
- Activation of cell populations deputies to the phenomena of angiogenesis and wound healing
- Direct and indirect antiseptic and antibacterial effects

After the phase of acuzia it is recommended to start the rehabilitation program, which must be made compatibly with the possibilities of the patient; we have also to try to gradually restore the normal habits [9].

The recovery of the sitting position in bedridden patient and in outpatients should be gradually resumed, because it constitutes a significant mechanical stress on the flap.

It is recommending:

- 10 min a day for 3 times / day, the first week
- 20 min a day for 3 times / day, the second week
- and so on, +10 min a day a week, until the eighth week.

Another part of the rehabilitation process is delegated to physiotherapy; it becomes imperative in preventing recurrences [9].

It is also essential to adopt continually medium-high risk antidecubitus mattresses [2, 9], such as elements interchangeable mattresses with computerized management of air in order to eliminate every risk factors in bedridden patients.

The staff who take care of patient has the responsibility to follow as close as possible all the prevention recommendations.

All the staff members are responsible to teach patients to take responsibility for their own training and pressure sore prevention [9].

Finally, in order to provide an adequate patient care, it is recommended a clinical follow up. In our experience, we carry out regular outpatient follow up at 1 week, 2 weeks, 1 month, 2 months, 4 months, 6 months and 1 year.

---

## **Pressure Ulcer Surgery What Is New?**

### **Negative Pressure Therapy and Pressure Ulcers**

The introduction of negative pressure therapy and specifically VAC instill has contributed to the development of new modes of approaches in covering strategies and management of osteomyelitis of ischial and sacral PU in paraplegic patients. . The sequential approach includes an initial debridement with a bone and tissular biopsies, followed by 4 weeks of negative pressure therapy, followed by a rotation skin flap branched on perforators or more classical flaps already revealed in this chapter [25].

During this period of negative pressure therapy, an adapted antibiotherapy is administered systematically.

The results presented in the first published series show a reduction in recurrence rates and postoperative complications.

### **Flap Coverage Using Cutaneous Flaps and Perforator Flaps**

Recently studies comparing myocutaneous flaps and cutaneous flaps showed similar results [26]. The need for severing large buttock muscles should be more put in perspective with the large perioperative blood loss induced by these techniques, the length of operative room occupation and the real benefits of carrying on a technique developed at a time when the muscle was considered as a benefit in term of bacterial decontamination; the present technologies and particularly the negative pressure therapy used previous to the flap realisation, the need for large complicated techniques seems less evident.

The recent development of perforator flaps diminishes the use of random flaps branched on anatomically based pedicles . The perop use of doppler allows the surgeon to know which vessel is present, and determines a ratio with the skin surface transposable.

Supercharged flaps, [27] consists in microsurgically suturing a vein or an artery on one edge of this perforator flap. This technique enhances the flap vascularisation by increasing the chance of postop flap viability.

### **Prevention of Recurrence After Flaps Using Fat Grafting**

Regenerative surgery is based on the capacity of adipocyte stem cells to improve the softness of the recipient area, and creating a mattress effect when injected in pressure sore area. The first series recently presented tend to demonstrate an improvement in the local situation and a reduction of recurrence [28, 29].

## References

1. Helvi H. Pressure ulcer patients' quality of life from nurse's perspective. In: Romanelli M, Clark M, Cherry G, Colin D, Defloor T, editors. *Science and practice of pressure ulcers management*. London: Springer; 2006. p. 7–9.
2. Scalise A, Tartaglione C, Bolletta E, Di Benedetto G. Medicazioni avanzate e trattamenti specifici. In: Scalise A, editor. *Lesioni cutanee croniche. Gestione e trattamento*. Milano: Edra Elsevier; 2015. p. 153–203.
3. Galleazzi M, Scalise MT, Ippolito AM. *Bedsore. Prevention and treatment*. Turin: Minerva Medica; 2012.
4. European Pressure Ulcer Advisory Panel and National Pressure Ulcer Advisory Panel. *Prevention and treatment of pressure ulcers: quick reference guide*. Washington, DC: National Pressure Ulcer Advisory Panel; 2009.
5. Hambly PR, Martin B. Anaesthesia for chronic spinal cord lesions. *Anaesthesia*. 1998;53(3):273–89.
6. *Prevention and treatment of pressure ulcers. Guidelines*. Zanetti E, Al Calosso editors. Milan: Lauri; 2000.
7. Ahuja NK, Russavage JM. Timing of reconstruction. In: Téot L, Granick MS, editors. *Surgical wound healing and management*. London: Informa Healthcare; 2012. p. 75–83.
8. Provinciali M, Cirioni O, Orlando F, Pierpaoli E, Barucca A, Silvestri C, Ghiselli R, Scalise A, Brescini L, Guerrieri M, Giacometti A. Vitamin E improves the in vivo efficacy of tige-cycline and daptomycin in an animal model of wounds infected with meticillin-resistant *Staphylococcus aureus*. *J Med Microbiol*. 2011;60(Pt 12):1806–12. <https://doi.org/10.1099/jmm.0.032516-0>.
9. Sørensen JL, Lubbers MJ, Gottrup F. Surgical management of pressure ulcers. In: Romanelli M, Clark M, Cherry G, Colin D, Defloor T, editors. *Science and practice of pressure ulcers management*. London: Springer; 2006. p. 119–27.
10. Mazzoleni F, Schiavon M. Terapia chirurgica delle ulcere da decubito. In: Furlan S, editor. *Trattato di tecnica chirurgica—chirurgia plastica ricostruttiva ed estetica*. Padova: Piccin; 2003. p. 1633–96.
11. Scalise A, Pierangeli M. Preparazione del fondo della ferita. In: Scalise A, editor. *Lesioni cutanee croniche. Gestione e trattamento*. Milano: Edra Elsevier; 2015. p. 109–52.
12. Ricci E, Cassino R. *Piaghe da decubito*. Torino: Minerva Medica; 2004.
13. Dolynchuk KN. Debridement. In: Krasner DL, Rodeheaver GT, Sibbald RG, editors. *Chronic wound care: a clinical source book for healthcare professionals*. 3rd ed. Malvern: HPN Communication; 2001. p. 385–90.
14. Mahoney J, Ward J. Surgical debridement. In: Téot L, Ziegler UE, Banwell PE, editors. *Surgery in wound*. London: Springer; 2004. p. 67–71.
15. Scalise A, Tartaglione C, Pierangeli M, Bolletta E, Fraccalvieri M, Grassetto L, Ottonello M, Nicoletti G, Massone A, Di Benedetto G. Paraplegia in a patient with Von Hippel Lindau syndrome: surgical and reconstructive treatment of Marjolin's ulcer. A case report. *Spinal Cord*. 2014;52(Suppl 3):S1–3. <https://doi.org/10.1038/sc.2014.111>.
16. Blondeel PN, KHI VL, SJM M, Hamdi M, Matton GE, Allen RJ, Dupin C, Feller A, Koshima I, Kostakoglu N, Wei F. The “Gent” consensus on perforator flap terminology: preliminary definitions. *Plast Reconstr Surg*. 2003;112(5):1378–83. <https://doi.org/10.1097/01.PRS.0000081071.83805.B6>.
17. Scalise A, Tartaglione C, Bolletta E, Pierangeli M, Di Benedetto G. Profunda femoris artery perforator propeller flap: a valid method to cover complicated ischiatic pressure sores. *Plast Reconstr Surg Glob Open*. 2015;3(8):e487. <https://doi.org/10.1097/GOX.0000000000000432>.
18. Allen RJ, Guerra AB, Erhard HA, Levine JL. Superior gluteal artery perforator flap. In: Blondeel PN, editor. *Perforator flaps: anatomy, technique, & clinical applications*. Chiacago: Quality Medical Pub; 2006. p. 485–98.
19. Guerra AB, Allen RJ, Levine JL, Erhard HA. Inferior gluteal artery perforator flap. In: Blondeel PN, editor. *Perforator flaps: anatomy, technique, & clinical applications*. Chicago: Quality Medical Pub; 2006. p. 499–512.

20. Lipa JE. Posterior thigh flaps. In: Blondeel PN, editor. *Perforator flaps: anatomy, technique, & clinical applications*. Chicago: Quality Medical Pub; 2006. p. 597–616.
21. Mardini S, Lin CH, Wei FC. Lateral circumflex artery-vastus lateralis perforator flap. In: Blondeel PN, editor. *Perforator flaps: anatomy, technique, & clinical applications*. Chicago: Quality Medical Pub; 2006. p. 617–34.
22. Akita S. Surgical management of pressure ulcers. In: Téot L, Granick MS, editors. *Surgical wound healing and management*. London: Informa Healthcare; 2012. p. 143–54.
23. Scalise A, Calamita R, Tartaglione C, Pierangeli M, Bolletta E, Gioacchini M, Gesuita R, Di Benedetto G. Improving wound healing and preventing surgical site complications of closed surgical incisions: a possible role of Incisional Negative Pressure Wound Therapy. A systematic review of the literature. *Int Wound J*. 2015;13(6):1260–81. <https://doi.org/10.1111/iwj.12492>.
24. Scalise A, Tartaglione C, Bolletta E, Calamita R, Nicoletti G, Pierangeli M, Grasseti L, Di Benedetto G. The enhanced healing of a high-risk, clean, sutured surgical incision by prophylactic negative pressure wound therapy as delivered by Prevena™ Customizable™: cosmetic and therapeutic results. *Int Wound J*. 2015;12(2):218–23. <https://doi.org/10.1111/iwj.12370>.
25. Brunel AS, Lamy B, Cyteval C, Perrochia H, Téot L, Masson R, Bertet H, Bourdon A, Morquin D, Reynes J, Le Moing V, on behalf of the OSTEAR Study Group. Diagnosing pelvic osteomyelitis beneath pressure ulcers: a prospective study. *Clin Microbiol Infect*. 2016;22(3):267.e1–8.
26. Thiessen FE, Andrades P, Blondeel PN, Hamdi M, Roche N, Stillaert F, Van Landuyt K, Monstrey S. Flap surgery for pressure sores: should the underlying muscle be transferred or not? *J Plast Reconstr Aesthet Surg*. 2011;64(1):84–90. <https://doi.org/10.1016/j.bjps.2010.03.049>.
27. Vinh VQ, Van Anh T, Tien NG, Hyakusoku H, Ogawa R. Bipedicled “Superthin” free perforator flaps for facial burn scar reconstruction: expanded scope of superthin flaps: a case series. *Plast Reconstr Surg Glob Open*. 2015;3(8):e493. <https://doi.org/10.1097/GOX.0000000000000449>. eCollection 2015 Au.
28. Téot L, Leaper D, Paggi B, Compton GA, Orsted H, Ockenfels HM. Growth factors and interactive dressings in wound repair. *EWMA J*. 2002;2(2 Fall):17–24.
29. National Health Council. *National Health Italian Guidelines on pressure ulcers: prevention and treatment*. Washington, DC: National Health Council; 2016.



# The Stop Pressure Ulcer Day and Other Initiatives by EPUAP

# 16

Christina Lindholm, Michael Clark, and Zita Kis Dadara

Pressure ulcers are not only a cost-driver for health care systems around the world, but can also result in significant morbidity and even death. The prevalence of pressure ulcers ranges between 8.8 and 29.9% in nursing homes and between 7.3 and 23% in hospitals throughout Europe and North America [1]. These wounds are associated with major problems for patients, their relatives and for care-givers. Reductions in quality of life including pain, changed body image, increased immobility, discomfort, loss of independence and self-control have been reported [2]. The general consensus is that most pressure ulcers could have been prevented. Despite the potential for health gains and reduced costs through effective pressure ulcer prevention there is still an overall lack of awareness of this condition among policy makers and the public. One example of this lack of awareness lies in the continued general use of 'bedsore' to describe these wounds rather than 'pressure ulcer'. This chapter sets out how the EPUAP has contributed to raising the awareness of pressure ulcers throughout Europe.

EPUAP has over the 20 years of its existence launched several initiatives aimed at improving the focus upon effective prevention and healing of pressure ulcers in Europe. In the early days of EPUAP, a minimum data-sheet was developed to serve as a basic protocol in pressure ulcer prevalence studies [3]. This protocol has become the template for many of today's prevalence studies. A multi-center study on pressure ulcers in patients with hip fractures was designed, sponsored

---

C. Lindholm (✉)  
Sophiahemmet University, Stockholm, Sweden  
e-mail: [c.lindholm@telia.com](mailto:c.lindholm@telia.com)

M. Clark  
Welsh Wound Innovation Centre, Rhondda Cynon Taf, Wales, UK  
e-mail: [ClarkM@cf.ac.uk](mailto:ClarkM@cf.ac.uk)

Z. K. Dadara  
Barmherzige Brüder Austria, Vienna, Austria

and run by EPUAP-members in six countries [4]. Over the past years, initiatives have been taken to cooperate with sister organizations internationally. This has resulted in the EPUAP/NPUAP evidence-based guidelines for prevention and treatment of pressure ulcers, released in 2009, and with an extended partnership with the Pan Pacific Pressure Injury Alliance in 2014 [5]. Another EPUAP initiative has been the PUCLAS interactive classification educational programme, first developed by the late Professor Tom Defloor, and later further developed and updated by Professor Dimitri Beeckman [6]. These initiatives have had a profound impact on implementation of evidence-based pressure ulcer classification, prevention and treatment. The annual EPUAP conferences have also been an important contributor to the attempts to make pressure ulcers visible and to present recent research.

However, it is frequently realised that authorities such as politicians and administrators as well as the public lack fundamental knowledge about pressure ulcers. Little public attention has been given to this common condition. The misery of pressure ulcers occasionally comes to the attention of policy makers and the public through media stories after poor care delivery. The recent Flynn report on deaths after pressure ulcer development in nursing and care homes in South Wales makes challenging reading for those who might think poor quality pressure ulcer care has been eradicated. The report can be found at: <http://gov.wales/topics/health/publications/socialcare/reports/accountability/?lang=en>

---

## The Stop Pressure Ulcer Day Initiative

In an attempt to draw more attention to pressure ulcers, representatives from Spain, Portugal and Italy met with colleagues from Central and South America some years ago to promote joint collaboration to increase the visibility of pressure ulcers to the public and policy makers. This interaction created the ‘Declaration of Rio’ setting out what each of us should anticipate from pressure ulcer care. This Declaration is shown below.

### **Declaration of Rio De Janeiro on Pressure Ulcers Prevention as a Universal Human Right (October 2011)**

Considering that:

1. States are responsible to guarantee people right to life and health.
2. Pressure ulcers are a major health problem, which affects millions of people worldwide, deteriorates their health and quality of life, and, eventually, can lead to disability and death.
3. Pressure ulcers produce high costs for Healthcare systems and could lead to serious ethical consequences and legal issues for professionals.
4. Scientific knowledge currently available has proved that these lesions could be almost completely avoided (at least at 95%).
5. Pressure ulcers are an adverse event and it must be considered as a major threat for patients’ safety both in Healthcare systems and in the Community

In order to deal with this problem it is necessary:

1. To achieve a strong commitment for the development and implementation of determined policies aimed to prevent this important public health problem.
2. To assure that people have an equitable and universal access to high quality technical and human resources to prevent and treat these lesions.
3. To guarantee use of quality and scientific evidence-based criteria, not just economic ones, when preventive and therapy resources are selected.
4. To improve both basic and post-basic education for Healthcare professionals about caring for people with or at risk of suffering these lesions, using an interdisciplinary and integral approach.
5. To promote research, development and innovation for making progress in the knowledge about caring for people with these problems.
6. To promote the creation of wound-care specialized clinical settings, with a clear interdisciplinary approach, and the availability of expert consultants in every community and healthcare setting.
7. To reinforce the Nursing leadership for caring people [sic] with pressure ulcers, because nurses are the professionals with the most suitable education and most adequate position in Healthcare systems to do this.

This declaration have been promoted by:

GNEAUPP (Spanish National Group for the Study and Advise on Pressure Ulcers and chronic wounds)

SILAHUE (Ibero-Latin-American Society on Wounds)

Flowing from the new Declaration the concept developed that there should be one-day a year when there was enhanced focus upon pressure ulcers—this became the STOP Pressure Ulcer Day adopted initially within the countries that helped generate the Declaration of Rio and since 2012 more widely across Europe following adoption of the STOP Pressure Ulcer Day by the EPUAP. This special day, set as the third Thursday each November, was seen by the EPUAP as a long-term campaign to increase knowledge and focus upon pressure ulcers. In the first year EPUAP designed it's logo for the campaign (Fig. 16.1) and produced a short video on pressure ulcer prevention to help capture the minds and hearts of all who saw the video on YouTube <https://youtu.be/RcQR1ICjckk> . The captions on the video have been translated into nine languages. Figure 16.2a–c show photos of screens from the video with captions in English). With help from commercial partners the EPUAP was also able to develop factsheets, lapel stickers and posters to promote pressure ulcer prevention with all this material available on the EPUAP web-site ([www.epuap.org](http://www.epuap.org)) while many national wound organizations host the material in local languages on their web-sites.

Four years later the STOP PRESSURE ULCER day is well recognised and respected across Europe and is a highlight of the EPUAP year. The initial view was that the first STOP Pressure Ulcer Day would help EPUAP form a template of activities that would become the basis for each country's involvement with the campaign. Development of this template never happened as it quickly became apparent that the idea of a STOP Pressure Ulcer day kick-started great creativity across Europe and each country has taken different approaches, many quite spectacular



**Fig. 16.1** EPUAP logo for the STOP pressure ulcers day campaign



**Fig. 16.2** (a, b, and c) Screen shots from EPUAP video on pressure ulcer prevention



**Fig. 16.2** (continued)

and these are discussed later in the chapter. It is challenging to show the objective success of the STOP Pressure Ulcer Day in terms of reduced numbers of people with these wounds but the wide-spread raising of awareness must help create a climate where pressure ulcer prevention and treatment is better recognised as an important health priority across Europe.

### **Examples of Activities During the Stop Pressure Ulcer Day**

Some STOP Pressure Ulcer day events have taken the form of lectures and conferences aimed at health professionals. Within care organizations posters have been developed to share pressure ulcer information—this has expanded in many locations to the hosting of small information stands in hospitals, sport arenas and supermarkets

through to appearances on radio and television. Many competitions and local quizzes have been held to help attract the public to pressure ulcer events. In Ireland one STOP Pressure Ulcer Day promotional event saw a wound healing commercial organization re-brand their fleet of commercial vehicles with the STOP Pressure Ulcer day logo bringing the campaign immediately to the attention of the public. Within the commercial sector there has been great support of the STOP Pressure Ulcer day both for philanthropic reasons and the opportunity to showcase how they contribute to effective pressure ulcer prevention and treatment. Throughout all these activities it quickly became apparent across Europe that the term ‘pressure ulcer’ meant little to the public but all recognised ‘bedsore’—this presents a challenge for the campaign as should we use words that resonate with the public or maintain the correct technical description of these wounds?

Sports personalities have been generous supporters of the campaign particularly in Wales where the Welsh Rugby Union allowed distribution of STOP Pressure Ulcer Day label stickers during a rugby match that took place on one STOP Pressure Ulcer Day. The Welsh Rugby Union have also supported the campaign by inviting international players to be photographed wearing t-shirts branded with the campaign logo (Fig. 16.3). In 2015 international footballer Aaron Ramsey (Arsenal and Wales) was also photographed with the campaign t-shirt that has been signed and will be a prize in a STOP Pressure Ulcer day activity in 2015. The creativity of EPUAP trustees and health care providers were numerous. Examples from the Finnish and Swedish campaigns in 2015 are shown in Figs. 16.4, 16.5 and 16.6.



**Fig. 16.3** Welsh Rugby Union members wearing the STOP pressure ulcer campaign t-shirt

**Fig. 16.4** An example of a promotional item from the Finnish STOP pressure ulcer campaign



**Fig. 16.5** An example of a promotional item from the Swedish STOP pressure ulcer campaign



**Fig. 16.6** Turku, Finland the authorities illuminated a bridge on Stop Pressure Ulcer Day. Photo: Maarit Ahtiala



The STOP PRESSURE ULCER DAY is now firmly fixed as an annual event with the objective of making as many people as possible aware about pressure ulcers and how to prevent and treat these wounds. Much work is still to be done, but the experiences from the international STOP PRESSURE ULCER day have helped forge local, national and international interactions that keep pressure ulcers in mind not just on the STOP Pressure Ulcer Day but throughout the year.

---

## References

1. Beeckman D, Mathei C, Van Lancker A, et al. Een nationale richtlijn voor Decubituspreventie. Good Clinical Practice (GCP). Brussel: Federaal Kenniscentrum voor de Gezondheidszorg (KCE); 2012. Reports 193AD/2012/10.273/95.
2. Beeckman D. The 2014 International Stop Pressure Ulcer Day: EPUAP needs you. *Br J Nurs*. 2014;23(20):16.
3. Vanderwee K, Clark M, Dealey C, Gunningberg L, Defloor T. Pressure ulcer prevalence in Europe: a pilot study. *J Eval Clin Pract*. 2007;13(2):227–35.
4. Lindholm C, Sterner E, Romanelli M, Pina E, Torra y Bou J, Hietanen H, Iivanainen A, Gunningberg L, Hommel A, Klang B, Dealey C. Hip fracture and pressure ulcers—The Pan-European Pressure Ulcer Study—*intrinsic and extrinsic factors*. *Int Wound J*. 2008;5(2):315–28.
5. National Pressure Ulcer Advisory Panel, European Pressure Ulcer Advisory Panel and Pan Pacific Pressure Injury Alliance. In: Haesler E, editor. *Prevention and treatment of pressure ulcers: quick reference guide*. Perth: Cambridge Media; 2014.
6. Beeckman D, Schoonhoven L, Fletcher J, Furtado K, Heyman H, Paquay L, De Bacquer D, Defloor T. Pressure ulcers and incontinence-associated dermatitis: effectiveness of Pressure Ulcer Classification education tool on classification for nurses. *Qual Saf Health Care*. 2010;19(5):e3. <https://doi.org/10.1136/qshc.2008.028415>. Epubl 2010 20.



# Innovation in Pressure Ulcer Prevention and Treatment

# 17

Keith Harding and Michael Clark

---

## Introduction

‘Innovation’ is one of the most over used words in recent years, almost every advertisement appears to promote products and services not simply as being ‘new’ but more importantly as being ‘innovative’. However, the definition of innovation is not simple with over 30 different ways to define this concept [1], of these definitions the one that may best reflect innovation in health care is ‘Innovation is the creation of something that improves the way we live our lives’ [2]. President Obama’s definition of innovation conveys two important concepts—that innovation involves new activities (be these products, services or systems for delivering care) that create value (improved health both for individual patients and for our wider society).

Accepting that innovation combines two key aspects—doing something new that adds value to individuals and society—it becomes easier to distinguish between ‘invention’, ‘innovation’ and ‘improvement’. Invention is the creation of the ‘something new’ while improvement entails doing established practices better. This chapter will not focus upon continuous practice improvements in pressure ulcer prevention and treatment nor will it discuss specific inventions in detail rather it will focus upon recent innovations in both the prevention and treatment of pressure ulcers. Throughout this book frequent reference is made to the 2014 version of the International Pressure Ulcer Guidelines [3] and the processes involved in creating these guidelines mark how innovation in communications technology allowed the worldwide pressure ulcer research and clinical communities to better work together.

---

K. Harding · M. Clark (✉)  
Welsh Wound Innovation Centre, Rhondda Cynon Taf, Wales, UK  
e-mail: [Keith.Harding@wwic.wales](mailto:Keith.Harding@wwic.wales); [Michael.Clark@wwic.wales](mailto:Michael.Clark@wwic.wales)

---

## **Innovation in Guideline Development**

Between 2005 and 2009 the European Pressure Ulcer Advisory Panel (EPUAP) and the US National Pressure Ulcer Advisory Panel (NPUAP) worked together to create the first edition of the International Pressure Ulcer Guidelines [4]. While the collaboration between two regional associations brought together for the first time the collective expertise of multiple clinicians and researchers engaged in pressure ulcer research, the process of creating the guidelines was quite traditional with working groups meeting in various locations across Europe and the US with one association (EPUAP) predominantly working on pressure ulcer prevention and the second (NPUAP) on treatment issues.

During the planning of the 2014 second edition of the International Pressure Ulcer guidelines, a third association joined the development team (Pan Pacific Pressure Injury Alliance) and the original model of one group working on prevention and another on treatment was no longer appropriate. True collaborative working between groups physically located in North America, across Europe and the Pacific region (Australia, Hong Kong, New Zealand and Singapore) was enabled by recent developments in web based video conferencing which allowed inexpensive frequent virtual meetings of the 27 working groups who came together to create the content of the guidelines and the Guideline Development Group who managed the process. Without innovation in communications technology it would not have been possible for the 105 contributors to the guidelines to work together to create this summary of current knowledge upon pressure ulcer prevention and treatment.

---

## **New Perspectives on Pressure Ulcer Aetiology**

The second edition of the International Pressure Ulcer Guidelines summarizes several innovative studies that have added value to our understanding of pressure ulcer aetiology. For many years attention was focused upon trying to understand the forces applied to the skin surface be these direct pressure or shear, while these studies provided some useful data they were limited to what happens strictly at the skin surface. Recent innovations in imaging technology along with the ready availability of powerful computers have allowed measurement and modeling of the amount of deformation skin and underlying soft tissues undergo when loaded. Changing from concepts of measuring pressure to measuring strain (the amount of deformation experienced by soft tissue) has provided new insights into the nature of the relationship between load and the time of its application to create tissue damage [5–7] which may ultimately assist product developers to realize surfaces that minimize strain and so better protect patients from harm.

---

## **Innovation in Public Health Systems?**

While the key risk factors for pressure ulcer development reflect limitations on activity and mobility and the status of the skin (presence of current pressure damage

or a history of previous pressure ulcers) there are other factors where successful management may require changes in the behaviour of society as a whole. Poor nutritional status and reduced perfusion and oxygenation are also cited by the International Pressure Ulcer Guidelines as relevant risk factors for pressure ulcer development—current trends towards obesity and the growing incidence of diabetes suggest many countries may be creating conditions ripe for pressure ulcer development as their population ages. Innovations in public health therefore have the potential to have effects downstream on the future incidence of pressure ulcers.

---

## **Innovation in Clinical Services**

Innovation in the design and delivery of clinical services will also impact upon the numbers of people who experience pressure ulcers. Remote monitoring of skin and wound status either through tele-medicine and perhaps the future application of novel sensor technologies incorporated into clothing may allow vulnerable individuals to be identified much earlier and for challenging wounds to be rapidly assessed by experienced clinicians. One UK innovation in the delivery of care was the introduction of the SKIN bundle model initially in Wales in 2009 [8] and then more recently in most parts of the country. The SKIN bundle focuses upon four areas of practice—the support surface, repositioning and mobility, incontinence and nutrition, often supplemented with skin status (the SSKIN bundle). A plan of care is developed for each individual around these four (or five) items with regular checks on their continued implementation recorded throughout the day and night. The success of the initiative is then shown at ward level using a ‘safety cross’ marking the number of days pressure ulcer free each month along with days where pressure ulcers developed, or a patient was admitted with established pressure damage. While there are reports of the success of SKIN bundle introduction on reducing pressure ulcer incidence [9–11] to date no controlled study of this innovation has been undertaken. While not discussed specifically within the second edition of the International Pressure Ulcer Guidelines the SKIN bundle model does meet a number of the recommendations upon implementation of high quality pressure ulcer prevention including standardization of preventive measures, regular monitoring and reporting of pressure ulcer occurrence and standardized documentation and repositioning regimens.

---

## **Innovation in Emerging Therapies**

Developments in the products used in pressure ulcer prevention and treatment are often described as being innovative but often simply reflect minor changes intended to improve established devices. The International Pressure Ulcer Guidelines explored emerging therapies for pressure ulcer prevention and highlighted four areas of innovation

Microclimate control  
Prophylactic dressings



## Fabrics and Textiles

### Electrical stimulation of muscle.

Microclimate control is considered in detail within another chapter of this book and will not be discussed here. Electrical stimulation of the gluteal and hamstring muscles in individuals with spinal cord injury has been reported in two studies [12, 13] with reduced maximum interface pressure and also diminished gradients of pressure between the ischial tuberosities and surrounding skin. When pressure ulcer clinicians and researchers considered whether this intervention would do more good than harm to individuals the trade-off between risk and benefit was unclear and no specific recommendation was offered on whether the use of electrical stimulation in people with spinal cord injury would be beneficial [3].

Use of silk-like fabrics rather than cotton to reduce shear and friction was considered to deliver benefits to patients [3]. The introduction of new textiles and fabrics into undergarments and socks may reflect a simple innovation that delivers benefit to patients particularly if future developments could also incorporate sensors to monitor temperature, moisture or friction.

The use of wound dressings to help prevent damage to the skin from shear and friction is not new having been reported for almost 30 years [14] however interest in this approach to pressure ulcer prevention has been revived in recent years and has growing popularity in the United States and other locations. Since 2014 there have been several published studies ranging from case series to randomized controlled trials and economic analyses that have reported reductions in pressure ulcer incidence and cost where a variety of dressing materials have been used within pressure ulcer prevention highlighting the current focus upon this aspect of pressure ulcer prevention [15–20].

---

## Next Steps for New Innovations in Pressure Ulcer Care?

Perhaps one new innovation would be for the 2019 third edition of the International Pressure Ulcer guidelines to be available in formats other than print! The full guideline document in 2014 was 292 pages long with a summary document at 60 pages in length. This makes the document unlikely to be used in day-to-day practice restricting this important summary of the available evidence to a text book to be referred to on occasion. Alternative delivery in the form of perhaps an app might allow engagement with the guideline at the bedside and engage the reader with multiple media including video, audio as well as text.

If innovation equals doing something new that adds value to patients and to society then the value added by the innovation must be elucidated and where possible quantified. Innovations such as the SKIN bundle and the use of prophylactic dressings in pressure ulcer prevention may spread widely in clinical practice before the value to be gained from these innovations has been established. Greater attention should be focused upon the evaluation of innovations to ensure valuable new systems, services and products are not delayed while new changes that don't deliver gains are not widely introduced.

Innovation has been defined in this chapter as the performance of something new that adds value to individual patients and to society. One leading example of such innovation is the Welsh Wound Innovation Centre (WWIC) created in 2014 to provide leadership to wound prevention and healing in Wales. WWIC is the first National Wound Healing centre world-wide and has already begun to demonstrate its value to Wales and the NHS through inward investment that has created at least 80 new jobs and the performance of national wound audits [21], education and training. WWIC considers that a system approach to value based wound care could have significant impact across the health economy through a focus upon three key areas—improved wound prevention, early intervention and optimisation of care and finally access to specialist care through WWIC [22]. Through the spread of centres based upon the WWIC model may we see pressure ulcer prevention and treatment become even more innovative over the coming years.

---

## References

1. <https://www.freshconsulting.com/what-is-innovation/>. Accessed 3 Mar 2018.
2. Obama B. Business week's "In" subsection. 2007. p. 6. <https://www.degruyter.com/downloadpdf/j/rem.2016.8.issue-1/rem-2016-0001/rem-2016-0001.pdf>. Accessed 3 Mar 2018.
3. National Pressure Ulcer Advisory Panel, European Pressure Ulcer Advisory Panel and Pan Pacific Pressure Injury Alliance. In: Haesler E, editor. Prevention and treatment of pressure ulcers: quick reference guide. Osborne Park: Cambridge Media; 2014.
4. European Pressure Ulcer Advisory Panel and National Pressure Ulcer Advisory Panel. Prevention and treatment of pressure ulcers: quick reference guide. Washington, DC: National Pressure Ulcer Advisory Panel; 2009.
5. Linder-Ganz E, Engelberg S, Scheinowitz M, Gefen A. Pressure-time cell death threshold for albino rat skeletal muscles as related to pressure sore biomechanics. *J Biomech*. 2006;39(14):2725–32.
6. Stekelenburg A, Strijkers GJ, Parusel H, Bader DL, Nicolay K, Oomens CW. Role of ischaemia and deformation in the onset of compression-induced deep tissue injury: MRI-based studies in a rat model. *J Appl Physiol*. 2007;102(5):2002–11.
7. Gefen A, van Nierop B, Bader DL, Oomens CW. Strain-time cell-death threshold for skeletal muscle in a tissue-engineered model system for deep tissue injury. *J Biomech*. 2008;41(9):2003–12.
8. <http://www.wales.nhs.uk/sitesplus/863/page/65480>. Accessed 3 Mar 2018.
9. Parnham A, Pankhurst S, Dabell W. Reducing avoidable pressure ulcers in the community. *Nurs Stand*. 2015;29(26):62–70.
10. Lin WL, Tseng CH, Chung YJ, Chuang HC, Lin YL, Chang PH. The effectiveness of care bundles in maintaining the skin integrity and reducing the incidence density of pressure ulcers in lung cancer inpatients. *Hu Li Za Zhi*. 2014;61(2 Suppl):S85–94.
11. Chaboyer W, Gillespie BM. Understanding nurses' views on a pressure ulcer prevention care bundle: a first step towards successful implementation. *J Clin Nurs*. 2014;23(23–24):3415–23.
12. Janssen T, de Koning A, Legemate K, Smit C. Electrical stimulation-induced gluteal and hamstring muscle activation can reduce sitting pressure in individual with a spinal cord injury. *Assist Technol Res Ser*. 2010:332–4.
13. Smit C, Haverkamp G, de Groot S, Stolwijk-Swuste J, Janssen T. Effects of electrical stimulation-induced gluteal versus gluteal and hamstring muscles activation on sitting pressure distribution in persons with a spinal cord injury. *Spinal Cord*. 2012;50(8):590–4.
14. Clark M. The effect of a pressure-relieving wound dressing on the interface pressures applied to the trochanter. *Decubitus*. 1990;3:43–6.

15. Santamaria N, Liu W, Gerdtz M, Sage S, McCann J, Freeman A, Vassiliou T, DeVincintis S, Ng AW, Manias E, Knott J, Liew D. The cost-benefit of using soft silicone multi-layered foam dressings to prevent sacral and heel pressure ulcers in trauma and critically ill patients: a within-trial analysis of the Border Trial. *Int Wound J*. 2015;12(3):344–50.
16. Santamaria N, Santamaria H. An estimate of the potential budget impact of using prophylactic dressings to prevent hospital-acquired Pus in Australia. *J Wound Care*. 2014;23(11):583–4, 586, 588–9.
17. Dutra RA, Salome GM, Alves JR, Pereira VO, Miranda FD, Vallim VB, de Brito MJ, Ferreira LM. Using transparent polyurethane film and hydrocolloid dressings to prevent pressure ulcers. *J Wound Care*. 2015;24(6):268, 270–1, 273–5.
18. Santamaria N, Gerdtz M, Liu W, Rakis S, Sage S, Ng AW, Tudor H, McCann J, Vassiliou T, Morrow F. Clinical effectiveness of a silicone foam dressing for the prevention of heel pressure ulcers in critically ill patients: Border II Trial. *J Wound Care*. 2015;24(8):340–5.
19. Otero DP, Dominguez DV, Fernandez LH, Margarino AS, Gonzalez VJ, Klepzing JV, Montesinos JV. Preventing facila pressure ulcers in patients under non-invasive mechanical ventilation: a randomised controlled trial. *J Wound Care*. 2017;26(3):128–36.
20. Forni C, D’Alessandro F, Gallerani P, Genco R, Bolzon A, Bombino C, Mini S, Rocchegiani L, Notarnicola T, Vitulli A, Amodeo A, Celli G, Taddia P. Effectiveness of using a new polyurethane foam multi-layer dressing in the sacral area to prevent the onset of pressure ulcer in the elderly with hip fractures: A pragmatic, randomised controlled trial. *Int Wound J*. 2018. <https://doi.org/10.1111/iwj.12875>.
21. Clark M, Semple MJ, Ivins N, Mahoney K, Harding KG. National audit of pressure ulcers and incontinence-associated dermatitis in hospitals across Wales: a cross-sectional study. *BMJ Open*. 2017;7:e015616. <https://doi.org/10.1136/bmjopen-2016-015616>.
22. Clark M, Fallon M, Harding KG. Innovating wound care. *Health Europa Quarterly*. 2018. <https://www.healtheuropa.eu/health-europa-quarterly-04/83792/>. Accessed 3 Mar 2018.

# Index

## A

- Absorbent polymers, 166
- Acute injury, 18
- Adjunctive therapies, 179, 181
  - current, types, 178
  - electrical stimulation
    - DDCT wave-form, 181
    - electroacupuncture treatment, 181
    - HVPC, 179
    - LVMP, 179
  - electrode placement, 178
  - electrotherapy, 177
  - ESTIM, typology, 176, 179
  - ESWT, 184
  - laser therapy, 182–184
  - topical oxygen therapy, 185
- Adjustable skin protection seat cushions, 24, 27
- Advanced wound dressings
  - absorbent polymers, 165, 166
  - absorption capacity, 164
  - antimicrobial effects, wound bed, 164
  - foam dressing, 165
  - foam films, 167
  - frequency of dressing change, 169–170
  - hydrocolloids, 166–167
  - hydrogels, 166
  - non-adherent, 164
  - silicone dressings, 168
  - traditional and advanced dressing, 160
  - wound exudate management, 162
- Aetiology, pressure ulcers, 103
  - humidity, 104, 105, 107, 108
  - skin temperature, 104–107
- Agency for Health Care Policy and Research (ACHPR), 118
- Air-cell-based (ACB) cushion, 19, 21, 25
- Alginate advanced dressing, 165
- Alternating pressure air mattress (APAMs), 2

- Antimicrobial dressings
  - bacterial binding action, 168
  - biguanide dressings, 167
  - charcoal activated dressings, 168
  - honey dressings, 168
  - iodine dressings, 167
  - silver dressings, 167
- Arginine enriched oral nutritional supplements, 52
- Autolytic debridement (AD), 139

## B

- Biguanide dressings, 167
- Bioengineering solutions, 2
- Biofeedback tool, 2
- Biomarkers, 3, 12
  - defined, 3
  - research motivation, 3
- Blood-to-sweat partition pathways, 9
- Body mass index (BMI), 48
- Bone adaptation (BA), 23
- Bottom up injury, 96
- Braden Q scale, 62, 66–70
- BST method, 182
- Buttocks, 18
  - immersion and envelopments, 22
  - mechanical properties, 19

## C

- Calorie intake, 49
- Candida Albicans*, 94
- Carboxymethylcellulose, 166
- Cardiac care unit (CCU), 34
- Charcoal activated dressings, 168
- Chlorhexidine impregnated dressings, 168
- Chronic ulcers, 82
- Chronic wounds, 59, 79, 122

- Cleansing agents, skin, 118  
 Collagen, 115, 168  
 Coronary and vascular disease, 3  
 Coulombs (C), 179  
 C-reactive protein (CRP), 3, 10  
 Crude (point) prevalence, 35  
 Cubbin scale, 65, 66  
 Cumulative incidence, 36  
   vs. incidence density, 37  
 Cutaneous vascularization, 222  
 Cystic fibrosis (CF), 6  
 Cytokine release, 5, 6
- D**
- Decubitus ulcers, 120  
 Deep tissue injuries (DTI), , 9, 17  
 Delphi method, 59  
 Denominators, 35  
 Dermis, 114, 115  
 Device health policy, 136  
 Diaper rash, 90  
 Dressings, for wounds, 121  
 Dry skin, 104
- E**
- Elastin, 115  
 Electrical stimulation, of muscle, 240  
 Electroacupuncture treatment, 181  
 Electrotherapy, contraindications, 180  
 Endotherms, 104  
 Energy flux density (EFD), 184  
 Energy intake, 49  
 Entrapment syndrome, 204  
 Enzymatic debridement (ED), 139  
 Enzymes, 167  
 Epidemiology  
   defined, 33  
   numerators and denominators, 34–36  
 Epidermal markers, 4, 6  
 Epidermis, 95, 113  
 Epidural anaesthesia  
   clinical features, 152  
   epidemiology, 151–152  
   modern techniques, 151  
   pathophysiology, 152  
   risk assessment, 153–155  
   side effects, 151  
   stage 1 and stage 2 lesions, 153  
   wound bed preparation and advanced  
     dressing, 155  
   wound dressing selection, 155  
 Erythema, 94
- European Pressure Ulcer Advisory Panel  
 (EPUAP), 69, 72, 103, 229, 238  
 Extracorporeal membrane oxygenation  
 (ECMO), 126  
 Extracorporeal shock wave therapy  
 (ESWT), 184  
 Extremely low birth weight (ELBW), 128
- F**
- Facility-acquired prevalence, 36  
 Facility acquired PU (FAPU), 34  
 Fat infiltration (FI), 18  
 Fecal incontinence, 89, 117  
 Finite element (FE) method, 19  
 Foam dressing, 165  
 Foam films, 167  
 Food and Drug Administration (FDA), 189  
 FREMS method, 182  
 Full thickness tissue loss, 202  
 Full-thickness skin defects, 191
- G**
- Gastrointestinal functions, 205  
 Gel cushions, 26  
 Gosnell scale, 63, 64  
 Granulation tissue stimulation, 193
- H**
- Health belief model, 80  
 Health related quality of life (HRQOL), 79  
   education, 84  
   financial implications, 83  
   health belief models, 80  
   measurement, 80  
   organisations, 84  
   pressure ulceration impacts, 81, 82  
 Healthcare professionals, 83, 90  
 Healthcare providers, 82  
 Healthy skin, 111  
 Heart-type fat acid binding protein  
 (H-FABP), 10  
 High-resolution NMR spectroscopy, 8  
 High voltage peaks current  
 (HVPC), 178  
   characteristics, 179  
 Home health agency (HHA), 196  
 Honey dressings, 168  
 Hospital-acquired pressure injuries  
 (HAPI), 120  
 Hospital-acquired PU (HAPU), 34  
 HRQOL, *see* Health related quality of life

Hydration, 49, 52  
 Hydrocolloids, 166  
 Hydrogels, 166  
 Hyperbaric oxygen (HBO), 224  
 Hypercatabolic 'shock' response, 19  
 Hyperemia, 61  
 Hyperhydration, 92, 93  
 Hypertonic dressings, 168

**I**

IAD, *see* Incontinence-associated dermatitis  
 Incidence density, 36  
 Incontinence, 116  
   dermatitis, 117, 118  
 Incontinence-associated dermatitis (IAD), 89,  
   91–93  
   defined, 90  
   etiology, 91, 92  
   external factors, 93  
   management, 97–99  
   observation of, 94, 95  
   pathophysiology, 91  
   and pressure ulcers, 95–97  
   prevalence and incidence, 93  
   risk assessment factors, 93  
   skin  
     barrier function, 91  
     pH, 92, 93  
     stratum corneum, 91  
 Inferior gluteal artery perforator flap  
   (IGAP), 146  
 Integrated PU care, 46  
 Intensive care units (ICUs), 34, 60, 107  
 Intermediate intensive care units  
   (IICUs), 70  
 International Pressure Ulcer guidelines, 103  
 International Statistical Classification of  
   Diseases and Related Health  
   Problems, 90  
 Intramuscular adipose depots, 18  
 Iodine dressings, 167  
 Ischaemia-reperfusion (I/R), 7  
 Ischial tuberosities (ITs), 18, 19, 27, 28, 240  
 Ischial ulcers, 223–226  
   gracilis muscle flap, 220  
   Hamstring flap, 221  
   myocutaneous flap  
     gluteus maximus, 219  
     m. biceps femoris, 219, 220  
   post-operative treatment  
     flap care, 224–226  
     general clinical conditions, 223  
 ISO wheelchair seating working group, 26

**J**

Jackson scale, 65, 66

**K**

Keratinocytes, 113

**L**

Laser Doppler fluxmetry, 2  
 Laser therapy, 182  
 Leg ulcers, 82  
 Liquid chromatography-mass spectrometry  
   (LC-MS), 8  
 Long lasting surgical procedures (LLSPs), 128  
 Loss of full-thickness skin, 201  
 Low birth weight (LBW), 128  
 Low voltage monophasic peaks current  
   (LVMPC), 178  
   characteristics, 180

**M**

Maceration, 117, 120  
 Macronutrients, 52  
 Malnutrition, 121  
 Mechanical-induced ischaemia, 7, 8  
 Mechanism of action (MoA), 162  
 Metabolic rate, 104  
 Microclimate control, 239  
 Microclimate management, 107, 108  
 Microdialysis, 11, 12  
 Microsurgical debridement (MD), 140–141  
 MMP modulating dressings, 168–170  
 Mobility, 66  
 Moisture-associated skin damage  
   (MASD), 90  
 Muscle atrophy (MA), 18, 23  
 Muscle spasms, 23  
 Myocutaneous flap closure, 147  
 Myoglobin concentrations, 10

**N**

National Association of Neonatal Nurses  
   (NANN), 71  
 National Pressure Ulcer Advisory Panel  
   (NPUAP), 69, 72  
 Natural moisturising factor (NMF), 91  
 Necrotic tissues, 122  
 Negative predictive value (NPV), 62  
 Negative pressure wound therapy (NPWT)  
   in appropriate patients, 191  
   contraindications, 190

- Negative pressure wound therapy  
 (NPWT) (*cont.*)  
 cupping, 189  
 economic impacts, 195–196  
 evidence in, 194–195  
 general indications, 190  
 guidelines, pressure ulcer management,  
 191–194  
 Ilizarov's like system, 141  
 mechanism of action, 190–191  
 ROCF dressing, 191  
 simplified-canysterless device, 142  
 sub-atmospheric pressure, 189
- Neonatal intensive care unit (NICU), 126
- Neonatal Skin Condition Scale (NSCS), 71
- Neonatal Skin Risk Assessment Scale  
 (NSRAS), 71
- Newborn screening (NBS), 6
- Nonadjustable skin protection seat cushions,  
 27
- Nonblanchable erythema, 200
- Non-invasive method, 5
- Normal skin, 111, 112, 117
- Normal-shaped intracellular  
 organules, 142
- North American Nursing Diagnosis  
 Association (NANDA), 90
- Norton scale, 62, 63
- Not stadiabile/not classifiable pressure ulcer,  
 202
- Numerators, 34
- Nutrition in Pressure Ulcer Prevention and  
 Treatment, 50–51
- Nutritional intervention strategy, 48
- Nutritional status, 41, 43, 44  
 arginine enriched oral nutritional  
 supplements, 52  
 arginine, zinc and antioxidants, 53  
 carbohydrate, protein, and fat supply, 44  
 cycle, 46  
 energy intake, 49  
 hydration, 52  
 in-depth nutritional assessment, 47, 48  
 nutritional intervention, 48  
 pressure ulcers, 42, 43  
 prevention, 43  
 risk assessment, 43  
 tissue power and wound healing, 44  
 treatment, 43  
 protein and amino acids, 45  
 protein intake, 51  
 screening of, 46, 47  
 vitamins and minerals, 45, 52  
 water, 45
- O**
- Oligo-Element Sore Trail (OEST), 54
- Oral nutritional supplements  
 (ONS), 49, 51
- Overflow incontinence, 116
- Oxygen, wound treatments, 185
- P**
- Pain, 79, 81  
 control, 122
- Palliative wound care, 147–150
- Pan Pacific Pressure Injury Alliance  
 (PPPIA), 69, 72
- Patient reported outcome measures  
 (PROMs), 80, 84
- Pediatric intensive care units (PICUs), 132
- Pediatric patients, pressure ulcers, 131–135,  
 139–142, 144, 146, 147  
 anatomophysiological features, 131  
 cases, 126–127  
 complex wounds, in children, 139  
 debridement, 139  
 definitions, 130  
 device-related preventive strategies, 135  
 ischiatic pressures  
 myocutaneous flap closure, 147  
 techniques, 147  
 localization, 138  
 negative-pressure wound therapy  
 Ilizarov's like system, 141  
 pediatric wound, dressing, 144  
 simplified-canysterless device, 142  
 3C system, 141  
 painful serial sharp debridements, 140  
 pediatric heterogeneous age, 128  
 pediatric wound care, dressing, 144  
 prevalence and incidence, 137–138  
 prevention and rehabilitation  
 dermal capillaries reduction, 134  
 multifaceted skills, 134  
 dermal capillaries reduction, 134  
 total skin assessment, 135  
 risk factors and risk assessment scales  
 immobility, 131  
 mechanical ventilation support devices,  
 132, 133  
 skin sensitivity, 131  
 tissue tolerance, 131  
 skin pediatrics, from fetus to  
 newborn, 128
- SACRAL, skin graft, 146
- skin developmental stages, 129
- skin features, neonatal ages, 129

skin host defence, neonatal ages, 129  
 skin pediatrics, 131  
 surgery, 145–146  
   wound treatment, 138  
 Pediatric scales, 69  
 Pelvic Rx, 205  
 Perilesional maceration, 121  
 Perinuclear fine chromatin dispersion, 142  
 Peri-wound skin protection, 119, 120  
 pH, 92  
 Point-of-care diagnostic sensors, 12  
 Positive predictive value (PPV), 62  
 Potential biomarkers, 4  
 Pressure ulcers (PUs), 17, 34  
   aetiology, 103  
   biomarker characteristics, 3  
   cost-of-illness, 42  
   epidemiology, 33, 34, 37  
   extrinsic risk factors, 42  
   flap coverage, cutaneous flaps and  
     perforator flaps, 226  
   good nursing care, 58  
   healthcare professionals, 82, 83  
   HRQOL, 81  
   incidence, 33  
   incontinence-associated  
     dermatitis, 95, 96  
   methodological issues, 37  
   microclimate, 103  
   negative pressure therapy, 226  
   pressure, 58  
   prevalence, 33, 37  
   prevention declaration, 230, 231  
   spinal cord injury population, 18, 19  
 Pressure ulcer risk assessment scores  
   (PURAS), 72  
 Prevention and treatment, innovation  
   clinical service innovation, 239  
   emerging therapies, 239–240  
   guideline developments, 238  
   pressure ulcer aetiology, 238  
   pressure ulcer care, 240–242  
   public health systems, 238  
 Profunda femoris artery perforators (PFAP),  
   221–223  
 Prophylactic dressings, 240  
 Proportion of ulcers healed within trial period  
   (PUHTP), 181  
 Protein-caloric dehydration, 121  
 Protein intake, 49, 51

## Q

Quality of life, 79, 107

## R

Rectus abdominis musculocutaneous flap, 147  
 Regenerative surgery, 226  
 Reticulated open cell foam (ROCF)  
   dressing, 190  
 Risk Assessment Pressure Sore (RAPS), 68  
 Risk assessment scales (RAS), 1  
 Risk assessment tools (RAT), 72  
 Risk assessment, pressure ulcers, 57–59,  
   62–71  
   assessment tools, 61, 62  
   Braden scale, 66–69  
   Cubbin and Jackson scale, 65, 66  
   Gosnell scale, 63, 64  
   Northern scale, 62, 63  
   Waterlow scale, 64, 65  
   development factors, 58  
   extrinsic, 58  
   intrinsic, 58  
   pediatric scales, 69  
   Braden Q scale, 69–71  
   Neonatal Skin Condition Scale, 71  
   Neonatal Skin Risk Assessment Scale, 71  
   theoretical models, 60  
 Risk group prevalence, 36

## S

Sacral ulcers, 214–216  
   IGAP  
     flap S-GAP, 215  
     pre-operative draw, 216  
     surgical technique, 216  
   myo-cutaneous flap of gluteus maximus,  
     213, 214  
   random fasciocutaneous flaps, 212  
   SGAP  
     adipo-cutaneous tissue, 214  
     anatomical structure, 215  
     surgical technique, 214  
     V-Y technique, 215  
     transverse flap of back, 214  
 Sensitivity, defined, 62  
 Sensory island flaps, 146  
 Shape adaptation, 18  
 Silicone dressings, 168  
 Silver dressings, 167  
 Sitting-acquired PUs, 18  
 Skin  
   humidity, 107, 108  
   moisture/dryness, 104  
   protectants, 98  
   protection cushion, 27, 28  
   surface temperature, 105, 106



- Skin care, 111, 119, 121  
 damage, 115, 116  
 dermis layer, 114, 115  
 elements of, 118  
 at end of life, 120, 121  
 epidermis layer, 113  
 fecal incontinence, 117  
 incontinence dermatitis, 117  
 maceration, 117  
 normal, 112  
 peri-wound skin protection, 119, 120  
 pressure injuries, 120  
 protection, 112  
 reduction of fatty layers and drying, 115  
 sensation, 112  
 thermal regulation, 113  
 thinning and loss of elasticity, 115  
 urinary incontinence, 116  
 use of soap and water, 117, 118  
 use of specialized skin-care products, 118  
 vitamin D, 112  
 wound healing, 121  
   dressing of, 121  
   prevention and treatment, 121  
   repair, 119
- Soft tissues, 1, 2
- Spinal cord injury (SCI), 9  
   buttocks, computational modeling, 20
- Standard wound care (SWC), 177
- Stop pressure ulcer day, 229–236  
   activities, 233–232  
   initiatives, 230–233
- Stratification, 35
- Stratum corneum (SC), 91
- Stress incontinence, 116
- Superior gluteal artery perforator flap (SGAP), 146
- Surgical debridement (SD), 140  
   sharp debridement, 208
- Surgical management, 200–202, 204, 206–207, 210–211  
   pressure ulcer stages, 200–202  
   risk factor assessments  
     haematological parameters, 204  
     infective assessment, 206–207  
     injury assessment, 206  
     nutritional parameters, 204  
   surgical phases, 211, 212  
     fasciocutaneous flaps, 211  
     miocutaneous flaps, 212  
     osteotomy, 210–211  
     reconstruction  
     ulcer removal, 210
- Sweat markers, 6, 7
- Systemic biomarkers, 9
- Systemic inflammatory diseases, 205, 206
- T**
- Thermal neutral zone (TNZ), 104
- Thermally-induced sweat, 7
- Top down injury, 96
- Topical oxygen therapy (TWO), 185
- Total amounts of protein (TP), 6
- Transcutaneous electrical nerve stimulator (TENS), 181
- Transepidermal water loss (TEWL), 115
- Transparent polyurethane dressing, 189
- Trochanteric ulcers  
   LCFA, tensor fascia lata perforator flap, 218–219  
   tensor fascia lata mio-cutaneous flap, 217  
   vastus lateralis muscle flap, 218
- Tumor necrosis factor alpha (TNF- $\alpha$ ), 107
- U**
- Undernutrition, 49
- Urge incontinence, 116
- Urinary incontinence, 89, 116–118
- US National Pressure Ulcer Advisory Panel (NPUAP), 238
- V**
- VACUUM ASSISTED CLOSURE™  
   Therapy, 189
- Very low birth weight (VLBW), 128
- Visual analogue scale (VAS), 181
- Vitamin D, 112
- Vitamins and minerals, 52
- W**
- Ward acquired PU (WAPU), 34
- Waterlow scale, 62, 64, 65
- Welsh Wound Innovation Centre (WWIC), 241
- Wheelchair cushions  
   adaptability to movement and activities, 24  
   adjustability at initial sitting, 22, 23  
   adjustability to individual, 24, 26  
   characteristics, 21  
   computational techniques, 19, 21  
   durability, 26, 27  
   immersion and envelopments, 22

- 
- World Health Organization, Working Group  
on Quality of Life (WHOQoL), 79
- Wound bed preparation, 155
- autolytic debridement, 207–208
  - biological debridement, 208
  - enzymatic debridement, 208
  - mechanical debridement, 208
  - technological debridement, 209
- Wound odour, 82
- Wound oxygen therapies, 185
- Wound repair, 119
- Wound surface area (WSA), 181
- X**
- XSensor pressure mapping system, 24