

---

**INTERNATIONAL HANDBOOK OF  
VIRTUAL LEARNING ENVIRONMENTS**

---

 Springer

---

THE INTERNATIONAL HANDBOOK OF VIRTUAL  
LEARNING ENVIRONMENTS

# The International Handbook of Virtual Learning Environments

Volume I

*Edited by*

Joel Weiss

*University of Toronto, Canada*

Jason Nolan

*Ryerson University, Canada*

Jeremy Hunsinger

*Virginia Tech, USA*

Peter Trifonas

*University of Toronto, Canada*

 Springer

A C.I.P. Catalogue record for this book is available from the Library of Congress

---

ISBN-10 1-4020-3802-X(HB)  
ISBN-13 978-1-4020-3802-0(HB)

---

Published by Springer,  
P.O. Box 17, 3300 AA Dordrecht, The Netherlands.

*www.springer.com*

*Printed on acid-free paper*

All Rights Reserved

© 2006 Springer

No part of this work may be reproduced, stored in a retrieval system, or transmitted in any form or by any means, electronic, mechanical, photocopying, microfilming, recording or otherwise, without written permission from the Publisher, with the exception of any material supplied specifically for the purpose of being entered and executed on a computer system, for exclusive use by the purchaser of the work.

Printed in the Netherlands.

## Table of Contents

<i>Abstract</i>	<i>xi</i>
<i>Biographies of Editors and Contributors</i>	<i>xiii</i>
<b>Introduction: Virtual Learning and Learning Virtually</b> <i>Joel Weiss</i>	<b>1</b>
<b>I Foundations of Virtual Learning Environments</b>	
<b>1 Rethinking the Virtual</b> <i>Nicholas C. Burbules</i>	<b>37</b>
<b>2 A History of E-learning: Shift Happened</b> <i>Linda Harasim</i>	<b>59</b>
<b>3 Towards Philosophy of Technology in Education: Mapping the Field</b> <i>Michael A. Peters</i>	<b>95</b>
<b>4 A Cyborg Manifesto: Science, Technology, and Socialist-Feminism in the Late 20th Century</b> <i>Donna Haraway</i>	<b>117</b>
<b>5 Teaching and Transformation: Donna Haraway’s “A Manifesto for Cyborgs” and Its Influence in Computer-Supported Composition Classrooms</b> <i>Erin Smith and Cynthia L. Selfe</i>	<b>159</b>
<b>6 The Political Economy of the Internet: Contesting Capitalism, the Spirit of Informationalism, and Virtual Learning Environments</b> <i>Jeremy Hunsinger</i>	<b>189</b>
<b>7 The Influence of ASCII on the Construction of Internet-Based Knowledge</b> <i>Jason Nolan</i>	<b>207</b>
<b>8 Interaction, Collusion, and the Human–Machine Interface</b> <i>Mizuko Ito</i>	<b>221</b>
<b>9 Technological Transformation, Multiple Literacies, and the Re-visioning of Education</b> <i>Douglas Kellner</i>	<b>241</b>

<b>10 Cyberpedagogy</b>	<b>269</b>
<i>Carmen Luke</i>	
<b>11 Re-situating Constructionism</b>	<b>279</b>
<i>John W. Maxwell</i>	
 <b>II Schooling, Professional Learning and Knowledge Management</b>	
<b>12 Realizing the Internet’s Educational Potential</b>	<b>301</b>
<i>J. W. Schofield</i>	
<b>13 Virtual Schools: Reflections on Key Issues</b>	<b>329</b>
<i>Glenn Russell</i>	
<b>14 Time, Space, and Virtuality: The Role of Virtual Learning Environments in Time and Spatial Structuring</b>	<b>345</b>
<i>Robert S. Brown and Joel Weiss</i>	
<b>15 Motivational Perspectives on Students’ Responses to Learning in Virtual Learning Environments</b>	<b>365</b>
<i>Mary Ainley and Christine Armatas</i>	
<b>16 User Adaptation in Supporting Exploration Tasks in Virtual Learning Environments</b>	<b>395</b>
<i>Kinshuk, Taiyu Lin and Ashok Patel</i>	
<b>17 Collaborative Text-Based Virtual Learning Environments</b>	<b>425</b>
<i>Rhonna J. Robbins-Sponaas and Jason Nolan</i>	
<b>18 Designing Virtual Learning Environments for Academic Language Development</b>	<b>441</b>
<i>Eleni Skourtou, Vasilika Kourti-Kazoullis, and Jim Cummins</i>	
<b>19 Inclusive E-learning</b>	<b>469</b>
<i>Jutta Treviranus and Vera Roberts</i>	
<b>20 Displacing Student–Teacher Equilibrium in Virtual Learning Environments</b>	<b>497</b>
<i>Joanna Black</i>	

<b>21 Rural South African Teachers “Move Home” in an Online Ecology</b>	<b>525</b>
<i>Elizabeth Henning</i>	
<b>22 Virtual Communities of Practice</b>	<b>563</b>
<i>Kathryn Hibbert and Sharon Rich</i>	
<b>23 Increasing the Democratic Value of Research through Professional Virtual Learning Environments (VLEs)</b>	<b>581</b>
<i>Lisa Korteweg and Jane Mitchell</i>	
<b>24 Virtual Learning Environments in Higher Education “Down Under”</b>	<b>609</b>
<i>Brian Pauling</i>	
<b>25 Technology and Culture in Online Education: Critical Reflections on a Decade of Distance Learning</b>	<b>653</b>
<i>Tim W. Luke</i>	
<b>26 A Global Perspective on Political Definitions of E-learning: Commonalities and Differences in National Educational Technology Strategy Discourses</b>	<b>673</b>
<i>Yong Zhao, Jing Lei, and Paul F. Conway</i>	
<b>27 An Overview of Virtual Learning Environments in the Asia-Pacific: Provisos, Issues, and Tensions</b>	<b>699</b>
<i>David Hung, Der-Thanq Chen, and Angela F. L. Wong</i>	
<b>28 Global Online Education</b>	<b>723</b>
<i>Steve McCarty, Begum Ibrahim, Boris Sedunov, and Ramesh Sharma</i>	
<b>29 Global Virtual Organizations for Online Educator Empowerment</b>	<b>789</b>
<i>Nick Bowskill, Robert Luke, and Steve McCarty</i>	
<b>30 An Online Journal as a Virtual Learning Environment: The Case of the <i>Teachers College Record</i></b>	<b>821</b>
<i>Gary Natriello and Michael Rennick</i>	
<b>31 Professional Development &amp; Knowledge Management via Virtual Spaces</b>	<b>849</b>
<i>Noriko Hara and Rob Kling</i>	

### III Out-Of-School Virtual Learning Environments

- 32 Cemeteries, Oak Trees, and Black and White Cows: Newcomers' Understandings of the Networked World** 873  
*Vicki L. O'Day, Mizuko Ito, Annette Adler, Charlotte Linde, and Elizabeth D. Mynatt*
- 33 The eLibrary and Learning** 895  
*Peter Brophy*
- 34 Beyond Museum Walls: An Exploration of the Origins and Futures of Web-Based, Museum Education Outreach** 915  
*Kevin Sumption*
- 35 Genealogical Education: Finding Internet-Based Educational Content for Hobbyist Genealogists** 939  
*Kylie Veale*
- 36 Downtime on the Net: The Rise of Virtual Leisure Industries** 961  
*Jackie Cook*
- 37 Education, Gaming, and Serious Play** 999  
*Suzanne De Castell and Jennifer Jenson*
- 38 E-learning Environments for Health Care: Advantages, Risks, and Implications** 1019  
*Monica Murero and Giuseppe D'Ancona*
- 39 E-Democracy: Media-Liminal Space in the Era of Age Compression** 1039  
*Mark Balnaves, Lucas Walsh, and Brian Shoesmith*
- 40 SonicMemorial.org—The Virtual Memorial as a Vehicle for Rethinking Virtual Learning Environments** 1055  
*Mark Shepard*
- 41 “Why don't We Trade Places . . .”: Some Issues Relevant for the Analysis of Diasporic Web Communities as Learning Spaces** 1067  
*Vera Nincic*
- 42 Exploring the Production of Race Through Virtual Learning Environments** 1089  
*Melissa Altman and Radhika Gajjala*



<b>43 Engaging the Disney Effect: The Cultural Production of Escapism and Utopia in Media</b>	<b>1107</b>
<i>Peter Pericles Trifonas</i>	
<b>44 “A Small World After All”: L. M. Montgomery’s Imagined Avonlea as Virtual Landscape</b>	<b>1121</b>
<i>Benjamin Lefebvre</i>	
<b>45 Slash Fiction/Fanfiction</b>	<b>1141</b>
<i>Rochelle Mazar</i>	
<b>46 A Critical Eye for the Queer Text: Reading and Writing Slash Fiction on (the) Line</b>	<b>1151</b>
<i>Rhiannon Bury</i>	
<b>IV Challenges for Virtual Learning Environments</b>	
<b>47 Chromosoft Mirrors</b>	<b>1171</b>
<i>Jeff Noon</i>	
<b>48 Net: Geography Fieldwork Frequently Asked Questions</b>	<b>1175</b>
<i>Martin Dodge and Rob Kitchin</i>	
<b>49 Hacktivism: The How and Why of Activism for the Digital Age</b>	<b>1203</b>
<i>Michelle Levesque</i>	
<b>50 Weblogs and Collaborative Web Publishing as Learning Spaces</b>	<b>1215</b>
<i>Alexander C. Halavais</i>	
<b>51 Procedural Discourse Networks: Weblogs, Self-organizations and Successive Models for Academic Peer Review</b>	<b>1237</b>
<i>Brandon Barr</i>	
<b>52 Wikis: Collaborative Virtual Learning Environments</b>	<b>1251</b>
<i>Naomi Augar, Ruth Raitman, and Wanlei Zhou</i>	
<b>53 Partying Like it’s 1999: On the Napsterization of Cultural Artifacts Via Peer-to-Peer Networks</b>	<b>1271</b>
<i>John Logie</i>	

<b>54 Virtual Harlem as a Collaborative Learning Environment: A Project of the University of Illinois at Chicago’s Electronic Visualization Lab</b>	<b>1289</b>
<i>Jim Sosnoski, Steve Jones, Bryan Carter, Ken McAllister, Ryan Moeller, and Ronen Mir</i>	
<b>55 Video-as-Data and Digital Video Manipulation Techniques for Transforming Learning Sciences Research, Education, and Other Cultural Practices</b>	<b>1321</b>
<i>Roy D. Pea</i>	
<b>56 ePresence Interactive Media and Webforum 2001: An Accidental Case Study on the Use of Webcasting as a VLE for Early Child Development</b>	<b>1395</b>
<i>Anita Zijdemans, Gale Moore, Ron Baecker, and Daniel P. Keating</i>	
<b>57 Networked Scholarship</b>	<b>1429</b>
<i>Barry Wellman, Emmanuel Koku, and Jeremy Hunsinger</i>	
<b>58 Analysis of Log File Data to Understand Behavior and Learning in an Online Community</b>	<b>1449</b>
<i>Amy Bruckman</i>	
<b>59 Reconstructing the Fables: Women on the Educational Cyberfrontier</b>	<b>1467</b>
<i>James S. Dwight, Megan Boler, and Pris Sears</i>	
<b>60 (Inorganic) Community Design Models and the Place of (In)appropriate Technology in International Development—What if More Than “Half the World” Wants Internet Access?</b>	<b>1495</b>
<i>Julia Dicum</i>	
<b>61 Broadband Technologies, Techno-Optimism and the “Hopeful” Citizen</b>	<b>1525</b>
<i>Matthew Allen</i>	
<b>62 The Matrix, or, the Two Sides of Perversion</b>	<b>1549</b>
<i>Slavoj Žižek</i>	
<b>63 Learning by Being: Thirty Years of Cyborg Existemology</b>	<b>1571</b>
<i>Steve Mann</i>	
<i>Subject Index</i>	<b>1593</b>

## Abstract

What is virtual reality and how do we conceptualize, create, use, and inquire into learning settings that capture the possibilities of virtual life? The International Handbook of Virtual Learning Environments was developed to explore Virtual Learning Environments (VLE's), and their relationships with digital, in real life and virtual worlds.

Three issues are explored and used as organizers for The Handbook. First, a distinction is made between virtual learning and learning virtually. Second, since the focus is on learning, an educational framework is developed as a means of bringing coherence to the available literature. Third, learning is defined broadly as a process of knowledge creation for transforming experience to reflect different facets of “the curriculum of life”.

To reflect these issues The Handbook is divided into four sections: **Foundations of Virtual Learning Environments; Schooling, Professional Learning and Knowledge Management; Out-of-School Learning Environments; and Challenges for Virtual Learning Environments.** A variety of chapters representing different academic and professional fields are included. These chapters cover topics ranging from philosophical perspectives, historical, sociological, political and educational analyses, case studies from practical and research settings, as well as several provocative ‘classics’ originally published in other settings.

## Biographies of the Editors and Contributors

### EDITORS

**Jeremy Hunsinger** manages the Center for Digital Discourse and Culture at Virginia Tech where he is also completing his Ph.D. in Science and Technology Studies. He is an instructor of political science and teaches courses centered on political theory, political economy, and information/research/education policy. He is supposed to be writing his dissertation on the political economy of the Internet, but more often than not is working on a myriad of other projects related to his job, research, and teaching interests in online environments. He has also worked as Director of VTOnline, a university-wide e-learning project, and has worked on the award winning On-Line M.A. in Political Science.

**Jason Nolan** is an Assistant Professor with the School of Early Childhood Education at Ryerson University in Toronto. His research interests include the pedagogy of technology, critical and reflective practice, and learning technologies for very young children. He is co-editor of the journal *Learning Inquiry*, and serves in an editorial capacity with *Canadian Children's Literature*, *the Journal of Dracula Studies*, and *The Harrow*.

**Peter Pericles Trifonas** is a Professor of Education at OISE/UT. He has published extensively in the areas of philosophy, cultural studies, and media.

**Joel Weiss** is the first Senior Fellow at the Knowledge Media Design Institute (KMDI) of the University of Toronto (UT), and was a long-time faculty member at the Ontario Institute for Studies in Education (OISE/UT). His background in chemistry and social science research procedures, as well as his appreciation of curriculum and learning issues in formal, non-formal and informal situations, provides interesting vantage points for his recent conversion to the virtual world. He was the Founding Editor of *Curriculum Inquiry*, and held several positions in Division B (Curriculum Studies) of the American Educational Research Association (AERA). His publications include chapters in Building virtual communities: Learning and change in cyberspace and AERA's Second handbook of research on teaching, and its Review of research in education. His next publishing venture will be serving as Editor-in-Chief of The encyclopedia of learning. As the Chair of the Educational Advisory Committee of The Toronto Zoo, Joel has facilitated the development of an International Learning Centre, and The City of Toronto's UN sponsored Regional Centre of Expertise for Education for Sustainable Development.

## CONTRIBUTORS

**Annette Adler** is a Research Manager at Agilent Labs. She manages the multidisciplinary Systems Biology Program which includes four projects: Proteomics, Metabolomics, Primary Data Analysis and Systems Informatics, with an interdisciplinary team of analytical chemists, biologists, and computer scientists. She is an anthropologist whose early experience was studying the historical development and current dynamics of social identities in the context of plantation economies and slavery. After leaving academics, she spent many years as a researcher looking at interactions between people and technologies, with a particular interest in technology-mediated collaboration, online communities and systems architecture designed to accommodate people as users. She has brought this interest to Agilent in how her project approaches understanding its end-users and develops its work accordingly.

**Associate Professor Matthew Allen** runs the Internet Studies program at Curtin University of Technology in Perth, Australia. Matthew had published 2 books and a dozen papers, and had a background in history, cultural theory and epistemology before turning to Internet Studies. He currently supervises several doctoral students in Internet Studies, is the in-coming President of the Association of Internet Researchers and is researching how broadband technologies are changing cultural and economic understandings of the Internet.

**Melissa Altman** is interested in critical understandings of meaning-making at the intersection of virtual and real environments. She is working on her Ph.D. in American Culture Studies at Bowling Green State University and is doing research on production of subjectivity, postcolonial feminisms, virtual learning environments, and other critical investigations of everyday meaning-making.

**Christine Armatas** is currently working as a researcher in the Human Factors group at Telstra Research Laboratories in Melbourne, Australia. Previously she was a Senior Lecturer in the School of Psychology, at Deakin University, Geelong. During her time there, she was involved in developing courses for delivery in fully online and mixed delivery modes. As part of this work, she has published a number of papers on how using computer-mediated technologies to deliver learning material affects the quality of the student learning experience. Her current research interests include the use of mobile technologies to enhance teaching and learning.

**Ms. Naomi Augar** completed her Bachelor of Computing (Applied Computing) with Honours in 2002 at Deakin University, Melbourne, Australia. Presently she is a Ph.D. candidate in the School of Information Technology at Deakin University. Her Ph.D. research focuses on Virtual Learning

Communities. Her research interests include issues related to constructing an online identity, virtual communication and e-learning.

**Ronald Baecker** is Professor of Computer Science, Bell University Laboratories Chair in Human-Computer Interaction, and founder and Chief Scientist of the Knowledge Media Design Institute at the University of Toronto. He is also Affiliate Scientist with the Kunin-Lunenfeld Applied Research Unit of the Baycrest Centre for Geriatric Care. He has been named a Computer Graphics Pioneer by ACM SIGGRAPH, has been elected to the CHI Academy by ACM SIGCHI, and has been given the Canadian Human Computer Communications Society Achievement Award. Baecker is an active researcher, lecturer, and consultant on human-computer interaction and user-interface design, cognitive prostheses, software visualization, multimedia, computer-supported cooperative work and learning, and software entrepreneurship. He has published over 100 papers and articles, is author or co-author of four books and co-holder of two patents, and has founded and run two software companies. His B.Sc., M.Sc., and Ph.D. are from M.I.T.

**Professor Mark Balnaves** is Chair of New Media, School of Communications and Multimedia, at Edith Cowan University, Perth, Western Australia. He co-authored The Penguin atlas of media and information and the University of Queensland Press' Mobilising the audience. He is an expert in audience research and new media.

**Brandon Barr** is an advertising copywriter who lives in Rochester, NY. He holds an M.A. in English Literature from the University of Rochester and remains interested in the poetics of new media—in the arts, in video games, in TV & radio, and in advertising. His current art projects and writing are available at his website, [texturl.net](http://texturl.net).

**Dr. Joanna Black** is an Assistant Professor of Art Education in the Faculty of Education at the University of Manitoba in Manitoba, Canada. She teaches visual arts and new media education. Her research interests and published works are on the subjects of the virtual arts classroom, the relationship dynamics between teachers and students in digital arts classrooms, new media integration in arts curriculum and teacher training, and model digital visual arts schools. Dr. Black has worked as an art director, curator, museum art educator and K-12 teacher in public and alternative school settings.

**Megan Boler** is an Associate Professor at the University of Toronto and earned her Ph.D. at the History of Consciousness Program at the University of California Santa Cruz. Her book Feeling power: Emotions and education was published by Routledge in 1999, and she recently published an edited collection, Dialogue in education: Troubling speech, disturbing silences (Peter Lang,

2004). Her research and graduate courses address critical theory, media literacy, feminist theory, and philosophy of technology. Her essays have been published in such journals as *Hypatia*, *Educational Theory*, and *Cultural Studies*. Her multimedia website [Critical Media Literacy in Times of War](http://www.tandl.vt.edu/Foundations/mediaproject) (www.tandl.vt.edu/Foundations/mediaproject) is widely used; she is producing a study guide to accompany the 2003 documentary [The Corporation](#); and her current research focus is on how web-based multimedia political satire influences the public sphere.

**Nicholas Bowskill** is an e-learning consultant currently working with The University of Sheffield, UK as an e-tutor in a self-employed role. In addition, he is also working with Lancaster University on the eChina Project. This has involved him in visits to Chinese Universities and online involvement across the eChina Project consortium. Nicholas is providing tutoring and technical support. His interests include informal learning in online environments and podcasting. He has a good research background and a record of research publications over the past 10 years of his involvement in e-learning.

**Peter Brophy** is Director of the Centre for Research in Library & Information Management (CERLIM) at the Manchester Metropolitan University, UK and holds the Chair in Information Management at that University. He has directed a number of international research projects, many funded by the European Commission's Telematics/Information Society Technologies Programmes, and has a particular interest in the integration of networked information systems and eLearning. He is the author of [The library in the twenty-first century](#) (Facet Publishing, 2001) and [The academic library](#) (Facet, 2nd ed., 2005).

**Robert S. Brown** has been in the field of applied research for twenty years. Before joining the Toronto Board's research department in 1991, he worked as a media analyst at TVOntario and as a research consultant in private market research. He is currently a project coordinator in Research and Information Services of the Toronto District School Board and is a past president of AERO (the Association of Educational Researchers of Ontario). Publications include "Psychological needs of post-war children in Kosovo: A preliminary analysis," with Ester Cole (*School Psychology International*, 2002, Vol. 23, no. 2), and Telling tales over time: Constructing and deconstructing the school calendar" with Joel Weiss (*Teachers College Record*, 2003, Vol. 105, no. 9).

**Amy Bruckman** is an Associate Professor at the College of Computing at Georgia Tech, and a member of the Graphics, Visualization, and Usability (GVU) Center. She received her Ph.D. from the Epistemology and Learning Group at the MIT Media Lab in 1997, and her B.A. in physics from Harvard University in 1987. She does research on online communities and education,

and is the founder of the Electronic Learning Communities (ELC) research group.

**Nicholas C. Burbules** is Professor of Educational Policy Studies in the College of Education at the University of Illinois. He is the editor of *Educational Theory*. His recent articles have appeared in *Access*, *Philosophy of Education*, and the *Electronic Journal of Sociology*.

**Rhiannon Bury** received her Ph.D. from the University of Toronto (Ontario Institute for Studies in Education) in 2000. She is Assistant Professor and Acting Director of Women's Studies at the University of Waterloo, Ontario, Canada. Her work on women, fan culture and cyberspace has appeared in a number of journals and edited collections including *Convergence: The Journal of Media Technologies*; *Popular Communication*; *Resources for Feminist Research*; and *The Post-Subcultures Reader*, edited by D. Muggleton & R. Weinzierl.

**Bryan Carter** is an assistant professor of literature at Central Missouri State University, specializing in African American literature of the 20th Century with a primary focus on the Harlem Renaissance and a secondary emphasis on visual culture. He has published numerous articles on Virtual Harlem and has presented it at locations around the world. In the spring of 2004, he served as Professeur Invité at the University of Paris IV-Sorbonne where he taught Digital Communications and Cultural Studies. Dr. Carter has recently incorporated desktop videoconferencing, podcasting, Internet radio broadcasts and blogging into each of his courses.

**Suzanne de Castell** is a Professor of Education at Simon Fraser University specializing in multi-modal literacies, new media studies and educational technologies. Her research focuses on epistemic implications of representational tools. She is currently studying informal learning environments, and specifically the impacts of computer-supported play on the development of new 'economies' of attention.

**Dr. Der-Thang Chen** is a Senior Lecturer in the University Centre for Teaching and Learning at the University of Canterbury. He currently leads various e-learning initiatives at the University and lectures in courses in instructional design and interactive multimedia design. His areas of research interest include online learning communities and the design of socio-technological architecture for learning.

**Dr. Paul F. Conway** is a College Lecturer in the Education Department, National University of Ireland (NUI), Cork and has also been a Visiting Professor in the College of Education, Michigan State University since 2000.



Prior to that he was Assistant Professor of Educational Psychology and Human Development at Cleveland State University, Ohio, USA. He is currently Co-editor of *Irish Educational Studies* (published by Routledge). His publications have appeared in the following journals: *Teachers College Record*, *Journal of Applied Developmental Psychology*, *Teaching and Teacher Education* among others. Research interests include learning theories, ICT policies in education in the context of globalisation, teacher education, and international and comparative education.

**Dr. Jackie Cook** teaches new media in graduate programs at the University of South Australia's School of Communication, Information and New Media in Adelaide, and also in the University's off-shore graduate degrees in Hong Kong, Singapore and Kuala Lumpur. She has just completed a five-year secondment into the University's Journalism programs, and is moving to a new focus promoting publication and media promotion of doctoral student research. She is a regular broadcaster on Australian radio, specialising in analytical commentary on new media culture.

**Jim Cummins** received his Ph.D. in 1974 from the University of Alberta in the area of educational psychology. He is currently a professor in the Department of Curriculum, Teaching, Learning in the Ontario Institute for Studies in Education of the University of Toronto. His research has focused on the nature of language proficiency and second language acquisition with particular emphasis on the social and educational barriers that limit academic success for culturally diverse students. He has served as a consultant on language planning in education to numerous international agencies.

**Dr. Giuseppe D'Ancona** is an internationally well-known cardiac surgeon—working at the present in the Republic of Ireland—who has published more than 100 articles in peer-reviewed international journals, with topics ranging from surgical treatment of cardiovascular pathology, new technologies in surgery (i.e. robotics), doctors' medical education, and interdisciplinary approach to patients' e-education and internet behaviour. He is the author and co-author of 3 highly diffused surgical manuals (Blackwell, Futura publishers) aimed at educating colleague surgeons in the innovative fields of cardiac surgery and perioperative evaluation of coronary surgery results. Dr. D'Ancona has participated to numerous international conferences in the interdisciplinary field of e-health. He has dedicated his medical career to both clinical activity and scientific research in the field of innovations in cardiac surgery and medicine. He collaborated with institutions such as State University of New York (SUNY) at Buffalo (USA), the Erasmus Academic Hospital in Rotterdam (NL), and the University of Florence (IT).

**Julia Dicum** is a doctoral candidate in OISE/UT's Collaborative Program in Comparative International Development Education and a Research Associate at York University's Centre for Refugee Studies, where her work is funded by a Social Science Humanities Research Council doctoral fellowship. An experienced aid worker, her primary research interests in education are innovation in learning delivery for marginalised communities in war-torn countries, critical theory, and sustainable ICTs as community development tools in less developed countries.

**Martin Dodge** works at University College London as a researcher in the Centre for Advanced Spatial Analysis and lecturer in the Department of Geography. He has a degree in geography and computing, an M.Sc. in geographical information systems and is currently completing his Ph.D. His work has been primarily concerned with developing a new research area of the geography of cyberspace, focusing in large part on the ways to map and visualise the Internet and the Web. He is the curator of a web-based [Atlas of cyberspace](http://www.cybergeography.org/atlas) ([www.cybergeography.org/atlas](http://www.cybergeography.org/atlas)) and has co-authored two books, *Mapping cyberspace* (Routledge, 2000) and *Atlas of cyberspace* (Addison-Wesley 2001).

**Jim Dwight** is an assistant professor at Millersville University, specializing in the Cultural Foundations of Education, Philosophy of Education, and Instructional Technology. His particular interest resides in intersections of e-learning and the metaphysics of presence and this intersection's subsequent effects on educational policies. His interests have led him to formulate a theory of hyperpedagogy that seeks ways in which e-learning can deny traditional metaphysical theories and thereby better address the concerns of historically marginalized learners.

**Radhika Gajjala (Ph.D., University of Pittsburgh, 1998)** is Associate Professor in Interpersonal Communication/Communication Studies at Bowling Green State University, Ohio. Her research interests include information communication technologies (ICTs) and globalization and production of race in cyberspace and virtual learning environments. Her work has appeared in journals such as *Feminist Media Studies*, *International and Intercultural Annual*, *Contemporary South Asia* and *Works and Days*, and in books such as *Technospaces: Inside the new media* (2001) and *Domain errors! Cyberfeminist practices* (2003). Her book *Cyberselves: Feminist ethnographies of South Asian women* was recently published by Altamira Press.

**Alexander Halavais** is an Assistant Professor of Communication and Graduate Director of the School of Informatics at The State University of New

York (SUNY) at Buffalo. His research explores the interactions between the structure of technical and social systems. He has published on the political implications of the hyperlinked structure of the World Wide Web, and on the impact of blogging on society.

**Noriko Hara** is an Assistant Professor of Information Science at Indiana University and a Fellow of the Rob Kling Center for Social Informatics. She held a position as a National Science Foundation (NSF) Postdoctoral Research Fellow in the School of Information and Library Science, University of North Carolina at Chapel Hill, before joining the faculty of the School of Library and Information Science, Indiana University in 2002. Her research focuses on studying collective behaviors with information technologies, including online learning, communities of practice, and online activism. Dr. Hara holds a Ph.D. in Instructional Systems Technology from Indiana University.

**Linda Harasim** Professor at Simon Fraser University holds a Ph.D. in Educational Theory from the University of Toronto and has been active for over a decade in researching educational applications of computer networking. She has designed, implemented, and evaluated networking applications in Canada, the U.S., and Latin America. She is also leading the Virtual-U Project, one of the first networked multimedia learning systems in the world that is customized for course delivery and course enhancement at all levels of education.

**Donna Haraway** is a Professor in the History of Consciousness Department at the University of California at Santa Cruz, where she teaches feminist theory, science studies, and animal studies. She earned her Ph.D. in Biology at Yale in 1972 and has taught biology at the University of Hawaii and the history of science at The Johns Hopkins University. Haraway is the author of Crystals, fabrics, and fields: Metaphors that shape embryos (Berkeley: North Atlantic Books, 2004, originally Yale University Press, 1976); Primate visions: Gender, race, and nature in the world of modern science (New York: Routledge, 1989); Simians, cyborgs, and women: The reinvention of nature (Routledge, 1991); Modest\_Witness@Second\_Millennium.FemaleMan© Meets OncoMouse™ (New York: Routledge, 1997); and The companion species manifesto: Dogs, people, and significant otherness (Chicago: Prickly Paradigm Press, 2003).

**Elizabeth Henning** is Special Professor of Qualitative Research Methodology in the Faculty of Education at the University of Johannesburg. She is currently the Chair of an international UNESCO UNITWIN research project on Values in Education, lead researcher in a National Research Foundation project on Educational ICT in South Africa and also lead researcher in a research project of the South African Netherlands Research Programme for Alternatives in Development. She was awarded a Spencer Post Doctoral Fellowship

by the National Academy of Education in the USA for research on teacher development in schools in informal settlements in 1995.

**Kathryn M. Hibbert**, after teaching for sixteen years completed a doctoral dissertation, Examining ‘enunciative space’ in an online community of practice. The study looked at how practicing teachers in a virtual Reading course understood that their literacy practices, and subsequently their teaching, lives through online dialogue in a supportive community of professional practice. Her research interests include; teaching and learning in the virtual world, teacher professional development in a culture of standards and efficiency, and the power of online dialogue for developing a scholarship of teaching. She has presented at both national and international conferences, with recent publications in *The Reading Teacher*, *The Journal for Adult and Adolescent Literacy*, as well as conference proceedings of *IADIS: The International Conference e-Society* (Avila, Spain) and the *20th Annual Conference on Distance Teaching and Learning*, (Madison, Wisconsin). She recently participated as a guest researcher in Etienne Wenger’s online forum, *CPSquare*. Currently, Kathy is the Distance Education Coordinator at the Faculty of Education, University of Western Ontario.

**Dr. David Hung** is currently Head of the Learning Sciences and Technologies academic department at the National Institute of Education, Nanyang Technological University. He is also a key initiator and member of the Learning Sciences Lab engaged in research in IT and learning within social-cultural contexts. Currently an associate professor, his interests span situated cognition, communities of practice, activity theory, neuroscience, and how technologies support meaningful and engageful learning. He publishes regularly in journals across instructional systems design and the learning sciences. He is a Contributing Editor to *Educational Technology* and Associate Editor for the *International Journal of Learning Technologies*.

**Dr. (Ms.) Ahbul Zailani Begum Mohamed Ibrahim** began her career as a Science Officer at the Science University of Malaysia (USM). She then migrated to teaching English as a Second Language (ESL) and served in the Northern University of Malaysia before joining the Mara University of Technology. Although teaching ESL is her forte, Begum has been watching the growth of online learning technologies closely; hence her participation in the World Association for Online Education ([www.waoe.org](http://www.waoe.org)). She is a firm believer in the importance of learner autonomy in language learning and finds that virtual learning provides an amazing avenue for capitalizing on this potential.

**Mizuko (Mimi) Ito** is a cultural anthropologist of technology use, focusing on children and youth’s changing relationships to media and communications.

She has been conducting ongoing research on kids' technoculture in Japan and the US, and is co-editor of, Personal, portable, pedestrian: Mobile phones in Japanese life. She is a Research Scientist at the Annenberg Center for Communication and a Visiting Associate Professor at Keio University in Japan.

**Jennifer Jensen** is Assistant Professor of Pedagogy and Technology in the Faculty of Education at York University. She has published on gender and technology, cultural studies of technology and technology in education. Her current interests include gender, education and digital game play.

**Steve Jones** is Professor of Communication, Research Associate in the Electronic Visualization Laboratory, Adjunct Professor of Art & Design at the University of Illinois—Chicago, and Adjunct Research Professor in the Institute of Communications Research at the University of Illinois at Urbana-Champaign. He holds the Ph.D. in Communication from the Institute of Communications Research, University of Illinois at Urbana-Champaign. Jones is author and editor of numerous books, including Society Online, CyberSociety, Virtual culture; Doing internet research; CyberSociety 2.0; The encyclopedia of new media; Rock formation: Technology, music and mass communication (all published by Sage); The Internet for educators and homeschoolers (ETC Publications); and Pop music & the press (Temple University Press). He was first President and co-founder of the Association of Internet Researchers and serves as Senior Research Fellow at the Pew Internet & American Life Project.

**Daniel P. Keating** is Research Professor and Director of the Center for Human Growth and Development, and Professor of Psychology, Psychiatry, and Pediatrics at the University of Michigan. He is a Fellow of the Canadian Institute for Advanced Research.

**Douglas Kellner** is George Kneller Chair in the Philosophy of Education at UCLA and is author of many books on social theory, politics, history, and culture, including (with Michael Ryan) Camera politica: The politics and ideology of contemporary Hollywood film; Critical theory, Marxism, and modernity; Jean Baudrillard: From Marxism to postmodernism and beyond; (with Steven Best) Postmodern theory: Critical interrogations; Television and the crisis of democracy; the Persian Gulf TV war; (with Steven Best) Media culture, and The postmodern turn.

**Kinshuk** is Director of the Advanced Learning Technology Research Centre and Associate Professor of Information Systems at Massey University, New Zealand. He has been involved in large-scale research projects for exploration based adaptive educational environments and has published over 150 research

papers in international refereed journals, conferences and book chapters. He is Chair of the IEEE Technical Committee on Learning Technology and International Forum of Educational Technology & Society. He is also Editor of the SSCI indexed *Journal of Educational Technology & Society* (ISSN 1436-4522).

**Rob Kitchin** is Director of the National Institute of Regional and Spatial Analysis (NIRSA) at the National University of Ireland, Maynooth. He is the Managing Editor of the journal *Social and Cultural Geography* and author/editor of twelve books, including Mapping cyberspace and Atlas of cyberspace, both written with Martin Dodge.

**Rob Kling** was Professor of Information Science and Information Systems at Indiana University, where he directed the Center for Social Informatics, an interdisciplinary research center, and was Editor-in-Chief of *The Information Society*. Since the early 1970s Dr. Kling had studied the social opportunities and dilemmas of computerization for managers, professionals, workers, and the public. Computerization and controversy: Value conflicts & social choices, perhaps his best-known work, examined the consequences and effects of computerization in organizations and social life, focusing on issues of productivity, work life, personal privacy, risks, and ethics. He passed away unexpectedly on May 15th, 2003.

**Emmanuel Koku** is a visiting Assistant Professor of Sociology at Temple University. His research and applied interests lie in the areas of social network analysis, research methods and statistics, virtual organizations, the structure of online and offline communities, and social epidemiology. His current research investigates consultation and advice-seeking networks among scholars and other knowledge workers, and their use of computer-mediated communication media. In addition, he is currently examining the links between sexual behaviors, sexual/social networks, HIV transmission and prevention. He recently received his Ph.D. in Sociology from University of Toronto, Canada.

**Lisa Korteweg** is a tenure-track faculty member at Lakehead University, Ontario, Canada. Her Ph.D. dissertation, Portals, practitioners, and public knowledge: A sociotechnical analysis of digital teacher education (University of British Columbia, 2005), explored the issues of online teacher education portals and the possibilities of a digital epistemic community of practitioners and researchers.

**Vasilias Kourtis-Kazoullis** received her Ph.D. from the Department of Primary Education, University of the Aegean. The topic of her Ph.D. was DiaLogos: Bilingualism and second language learning on the Internet.

She received a M.Ed. from the University of Wales, Swansea and a B.A. in English Literature and Linguistics from Youngstown State University, U.S.A. She has been teaching English in the Greek Public School System, Secondary Education, since 1990 and has also taught English at the Department of Preschool Education and Educational Design, University of the Aegean. She now teaches courses related to language learning and new technologies at the Department of Mediterranean Studies, and in the Master's Program at the Department of Primary Education, University of the Aegean.

**Miss Elicia Lanham** received her B.Computing (Information Management) and B. Computing (Honours) degrees from Deakin University, Melbourne, Australia in 2001 and 2002, respectively, and a Certificate II in Small Business Management from the Vocational and Educational Training Accreditation Board (VETAB), Australia, 2000. She is currently a Ph.D. Candidate in the School of Information Technology, Deakin University, Melbourne, Australia. Her research interests include practical and cultural issues of Internet education, cross-cultural learning styles and e-learning.

**Benjamin Lefebvre** is writing his doctoral dissertation in English at McMaster University on ideology and child protagonists in Canadian and Québécois fiction. He recently guest-edited a double issue of *Canadian Children's Literature/Littérature canadienne pour la jeunesse* on "Reassessments of L.M. Montgomery" (2004). His latest academic contributions have appeared or are forthcoming in *Children's Literature Association Quarterly*, *English Studies in Canada*, *Children's Literature*, *Voix plurielles*, and *The Oxford Encyclopedia of children's literature*, edited by Jack Zipes (Oxford University Press, 2006).

**Jing Lei** is a doctoral candidate in the Learning, Technology, and Culture Program in the College of Education at Michigan State University. Her dissertation concerns conditions for effective technology use by students.

**Michelle Levesque** is currently studying Computer Science at the University of Toronto. She also spends her time working at the Citizen Lab, where she designs and implements programs to enumerate and circumvent state-imposed Internet content filtering.

**Taiyu Lin** is a doctoral student in the Advanced Learning Technology Research Centre at Massey University, New Zealand. His research interests include cognitive profiling of the learners.

**Dr. Charlotte Linde** is a Senior Research Scientist at NASA Ames Research Center, working on issues of narrative and institutional memory, knowledge management, human-centered computing, and work systems design and

evaluation. She holds a doctorate in linguistics from Columbia University, and is the author of a book on the use of narrative in the social negotiation of the self (Life stories: The creation of coherence, Oxford University Press).

**John Logie** is an Assistant Professor of Rhetoric at the University of Minnesota. His scholarship addresses authorship and rhetorical invention, with a particular emphasis on the implications of digital media for these practices. His articles have appeared in *First Monday*, *Rhetoric Society Quarterly*, *Rhetoric Review*, *Computers & Composition*, *KB Journal*, and a number of anthologies. He is currently completing a book-length project on the rhetoric of the peer-to-peer debates, to be published by Parlor Press.

**Carmen Luke** is Professor at the University of Queensland in Australia. Her work has been in the areas of media literacy and new media, feminist studies, globalization and higher education. Her principal research focus has been on young people's relationships to 'old' and 'new' media, new technologies and popular culture, and the role of schooling in providing critical media and ICT skills. Her current theoretical interests are in cultural globalization theory and cosmopolitan 'democracy', and she is currently conducting research on the future of public education and public archives of knowledge in the context of globalization and commercialization of knowledge.

**Robert Luke, Ph.D.**, is the Manager of Educational Informatics, Department of Radiation Oncology, Princess Margaret Hospital at the University Health Network, University of Toronto. He studies community learning networks, with an emphasis on learning environments for health and education. This includes work on online interprofessional education for healthcare teams, as well as for patient learning. He is actively involved in the development of standards and technologies that assist people with various abilities and learning styles. This is explored through community informatics and the design of information and communications technology systems that enhance community health, social, economic, and political development.

**Timothy W. Luke** is University Distinguished Professor of Political Science at Virginia Polytechnic Institute and State University in Blacksburg, Virginia. He also is the Program Chair for Government and International Affairs in the School of Public and International Affairs, and he serves as Director of the Center for Digital Discourse and Culture in the College of Liberal Arts and Human Sciences at Virginia Tech. From 1997 through 2002, he was Executive Director of the Institute for Distance and Distributed Learning, which is the university's main on-line learning environment. His recent books are Capitalism, democracy, and ecology: Departing from Marx (University of Illinois Press, 1999); The politics of cyberspace, ed. with Chris Toulouse (Routledge, 1998); and Ecocritique: Contesting the politics



of nature, economy, and culture (University of Minnesota Press, 1997). His latest book, Museum politics: Powerplays at the exhibition, was published in 2002 with the University of Minnesota Press.

**Steve Mann** has written more than 200 research publications and has been the keynote speaker at more than 25 scholarly and industry symposia and conferences and has also been an invited speaker at more than 50 university Distinguished Lecture Series and Colloquia. He received his Ph.D. degree from MIT in 1997 for work including the invention of Humanistic Intelligence. He is also inventor of the Chirplet Transform, a new mathematical framework for signal processing, of Comparametric Equations, a new mathematical framework for computer mediated reality, and of the FUNtain fluid user interface. He is currently a tenured faculty member at the University of Toronto.

**John W. Maxwell** is a faculty member of the Master of Publishing Program at Simon Fraser University in Vancouver, where his focus is on the impact of digital technology in the cultural sector. His research interests include the history of computing and new media, and contemporary myth-making in the face of digital media.

**Rochelle Mazar** has a B.A. in English, a masters degree in Theological Studies, and spent a couple of years in a Ph.D. program in History before seeing the light and going to library school. Currently she is an Instructional Technology Liaison Librarian at the University of Toronto at Mississauga. She has been involved in online educational environments since 1993, and likes to write fiction in her spare time.

**Ken S. McAllister** is an Associate Professor of Rhetoric at the University of Arizona and the Co-Director of the Learning Games Initiative (<http://lgi.mesmernet.org>), an international research organization that studies, teaches with, and builds computer games. He also runs the Arizona Chapter of Alternative Educational Environments, which works with teachers, scientists, inventors, artists, and humanities scholars to develop innovative instructional technologies and contexts for learning.

**Steve McCarty** is a Professor at Osaka Jogakuin College in Japan. Since 1998 he has been re-elected President of the World Association for Online Education ([www.waoe.org](http://www.waoe.org)). He teaches English as a Foreign Language (EFL) through topics such as current events, human rights and bilingualism. His college was the first in the world, before Duke University, where all entering students receive iPods with listening materials. Born in Boston, he specialized in Japan at the University of Hawaii. His Website of online publications received a

four-star rating, very useful for research, in 1997, 2001 and 2005 from the Asian Studies WWW Virtual Library.

**Dr. Ronen Mir** is the Executive Director of SciTech Hands On Museum in Aurora, Illinois and a guest scientist at the Fermi National Accelerator Laboratory. Dr. Mir focuses on Science Education for the public, helping to develop Science Centers in the US, South America and Israel. He received his Ph.D. in Physics from the Weizmann Institute of Science, Israel, and a Museology Certificate from Tel Aviv University, Israel. He and his wife, Dr. Debby Mir, are the parents of Shlomi (18), Adva (16) and Julia (12).

**Jane Mitchell** is a senior lecturer in the Faculty of Education at Monash University (Australia). Her research interests focus on curriculum and pedagogy in teacher education. A particular aspect of her research is concerned with the design and analysis of new learning spaces using web-based technology.

**Ryan M. Moeller** is an assistant professor in the Department of English at Utah State University. He teaches courses in professional writing, rhetorical theory, and the rhetorics of technology. His research is focused on the relationships among technique, technology, and rhetorical agency. His work has appeared in *Technical Communication Quarterly*, *Kairos*, *Works and Days*, and in book chapters. He is currently working on a book manuscript that examines the rhetoric of consumer electronics through political economy analysis.

**Gale Moore** is the Director of the Knowledge Media Design Institute (KMDI), an interdisciplinary research and teaching institute and intellectual incubator at the University of Toronto, and a professor in the Department of Sociology. As sociologist-designer, her primary interests for the past 15 years have been the social impacts of ICTs in everyday life, and on bringing an understanding of peoples' experience and practice into the design of new technologies. As a sociologist of work and organisations, her interests have been in understanding collaboration as a nexus of people, practice and technology, and in interdisciplinarity and innovation in the contemporary university. Moore is a co-inventor of ePresence Interactive Media.

**Monica Murero** is the Director of the E-Life International Institute, and Professor in Communication and Media Integration at the Center of Excellence MICC (Media Integration and Communication), University of Florence in Italy. She is a consultant working for the European Commission, and she is the Treasurer of the International Association of Internet Researchers (aoir.org). In 2002 she founded the International Network of Excellence in E-Health Research (INoEHR) with Susannah Fox (Pew Internet). Her interdisciplinary work has appeared in several international journals, publications and television

programs. Prof. Murero has received several international awards and grants, including the “Rientro Cervelli”—the most prestigious Italian award granted to distinguished scientists working in the international community—and has authored and co-edited three books. Her next book, with R. E. Rice, projected for 2006 is Internet and health care: Theory, research and practices, Lawrence Erlbaum Associates.

**Elizabeth D. Mynatt** is the GVM Center Director, the HCC Ph.D. Program Faculty Coordinator and an Associate Professor in the College of Computing at the Georgia Institute of Technology. There, she directs the research program in Everyday Computing—examining the human-computer interface implications of having computation continuously present in many aspects of everyday life. Themes in her research include supporting informal collaboration and awareness in office environments, enabling creative work and visual communication, and augmenting social processes for managing personal information. Dr. Mynatt is one of the principal researchers in the Aware Home Research Initiative which is investigating the design of future home technologies, especially those that enable older adults to continue living independently as opposed to moving to an institutional care setting.

**Gary Natriello** is the Gottesman Professor of Educational Research and Professor of Sociology and Education at Teachers College, Columbia University. Professor Natriello’s work has focused on the education of at-risk youth, the evaluation of student performance, the social organization of schools, and the sociology of online learning. He is a past Editor of the *American Educational Research Journal* and the current Executive Editor of the *Teachers College Record*.

**Vera Nincic** received her Ph.D. from the Ontario Institute for Studies in Education at the University of Toronto. Her research explores the intersections of immigration, language, and computer technologies, and her dissertation focused in particular on the uses of computer technologies by nonnative English speaking students in academic contexts. She is now the Research Coordinator of a major research project in the Faculty of Nursing, University of Toronto.

**Jeff Noon** was born in 1957, in Manchester, England. He was trained in the visual arts, and was musically active in the punk scene, before starting to write plays for the theatre. Since his first novel, Vurt, published in 1993, he has concentrated on finding new ways of writing, suitable for portraying the modern world in all its complexity, taking ideas and methods from musical composition and applying them to narrative. His other books include Automated Alice, Pixel Juice, Needle in the Groove and Falling Out Of Cars. His plays include Woundings, The Modernists and Dead Code.

**Vicki O'Day** is a doctoral student in cultural anthropology at U.C. Santa Cruz. She is currently studying the uses of computational materials and ideas in biological research, particularly in the context of research into age-related genes and new models of human aging. Before returning to student life, she worked in several research labs in Silicon Valley, where she designed software and studied technology use in offices, schools, and libraries. Her earlier work addressed problems in information access, collaborative work, and online communities for senior citizens and children. She is the author (with Bonnie A. Nardi) of Information ecologies: Using technology with heart.

**Ashok Patel** is Director of CAL Research at De Montfort University, United Kingdom. A professional accountant, his research interests have expanded to intelligent tutoring and adaptive learning. He is Co-Editor of the SSCI indexed *Journal of Educational Technology & Society* (ISSN 1436-4522) and executive committee member of the IEEE Technical Committee on Learning Technology.

**Brian Pauling's** employment background spans many years of working in radio, television, bookselling, publishing, community education, adult education and tertiary education in New Zealand. He is a regular broadcaster and has published and presented, nationally and internationally, on media and education issues. He was also responsible for the establishment of the first independent community access radio station, PLAINSFM, which began intermittent broadcasting in 1984 and full-time broadcasting in 1987. He has a particular interest in the educational theories of capability learning, cooperative education, immersion learning and independent learning, all of which inform the qualifications and the teaching practices of the School. His current research involves a study of the impact of converging technologies (television, telecommunications and computers) on the delivery of teaching and learning. He is media consultant for a number of regional and national organisations. Brian began the broadcasting programme at CPIT in 1983 and was the first Head of School.

**Roy Pea** is Stanford University Professor of the Learning Sciences and Director of the Stanford Center for Innovations in Learning. He has published 120 chapters and articles on such topics as distributed cognition, learning and education fostered by advanced technologies including scientific visualization, on-line communities, digital video collaboratories, and wireless handheld computers. He was co-author of the National Academy Press's How people learn. Dr. Pea is a Fellow of the National Academy of Education, American Psychological Society, and the Center for Advanced Study in the Behavioral Sciences. He received his doctorate in developmental psychology from Oxford as a Rhodes Scholar.

**Michael A. Peters** is Professor of Education at the University of Illinois. He held a chair as Professor of Education in the Department of Educational Studies at the University of Glasgow (2000–2005) as well as positions as Adjunct Professor at the University of Auckland and the Auckland University of Technology. He is the author or editor of over twenty-five books and the editor of Educational Philosophy and Theory, Policy Futures in Education and E-Learning. His research interests include educational philosophy, education and public policy, social and political theory.

**Ruth Raitman** received her BSc (Mathematics) and BComputing (Honours) degrees from Deakin University, Australia in 2000 and 2001, respectively, and is currently a Ph.D. candidate in the same university, soon to complete all requirements. She is the HDR Representative of the Faculty of Science and Technology School of Information Technology School Board at Deakin and also acts as an online facilitator and tutor for several units. Her research interests include e-learning, online collaboration and the employment of wikis in the virtual environment.

**Michael Rennick** is the Director of Online Publishing for the *Teachers College Record* at Teachers College, Columbia University and a doctoral student in the interdisciplinary program in education. His research interests include constructivist approaches to education, and social interaction in online environments.

**Sharon J. Rich** is a Professor and Dean of Education at the University of New Brunswick in Canada. She has published several papers about teaching and learning in the virtual environment. Together with her team of collaborators she was responsible for developing the online continuing teacher education program at the University of Western Ontario. Her research interests include the development of online community.

**Rhonna J. Robbins-Sponaas** earned her Master's in English (Creative Writing) from The Florida State University, and is working toward a doctoral defense in American Literature. Currently residing in Norway, she teaches writing and literature to Norwegian and American students at the university level, both online and face-to-face, and teaches English (ESOL) to Norwegian students. Rhonna is a member of the enCore Consortium, has served as executive director for an academic MOO, and as editor-in-chief for a recognized online literary journal. Current projects include a book on Norway for junior readers, and another about teaching writing online for higher education students.

**Vera Roberts** is a researcher at the University of Toronto's Adaptive Technology Resource Centre where her primary interests are inclusive design,

software usability, inclusive usability testing methods, as well as ways to use the capability of new technology to enhance new media so that it is fully accessible. At the ATRC, Vera has been involved in many projects including Barrier-Free Access to Broadband Education (<http://barrierfree.ca>), The Inclusive Learning Exchange ([www.inclusivelearning.ca](http://www.inclusivelearning.ca)) and The Canadian Network for Inclusive Cultural Exchange ([www.cnice.utoronto.ca](http://www.cnice.utoronto.ca)). As part of her research, Vera has developed and tested a usability testing method (gestural think-aloud protocol) for individuals who are deaf and communicate with American Sign Language.

**Dr. Glenn Russell** has had more than thirty years experience teaching in Australian schools and universities. He currently lectures in ICTE (information and communications technology in education) in the Faculty of Education at Monash University. He has an international reputation in virtual schooling, cyberspace, and educational uses of hypertext. His current research involves ethical uses of information and communications technology in school education, virtual schools, and future trends in instructional technology and school education.

**Janet Ward Schofield** is a Professor of Psychology and a Senior Scientist at the Learning Research and Development Center at the University of Pittsburgh. Her research focuses on two areas—the social psychology of educational technology use, and race relations. She has published over ninety papers and four books including Black and white in school, Computers and classroom culture, and Bringing the Internet to school. She has served as a consultant to local, state and national governments, as a member of boards and committees at the U.S. National Academy of Sciences, and as an elected member of the American Psychological Association's governing body, the Council of Representatives.

**Pris Sears** is currently the Network Administrator for the Department of Horticulture at Virginia Tech. Her recently taught courses addressed web site design and development, semiotic theory, and graphic design. She earned her M.A. in the Instructional Technology Program at Virginia Tech. Previous publications include "HTML origins, owners, good practices," in WWW: Beyond the basics, and "Preparing tomorrow's teachers to be socially and ethically aware producers and consumers of interactive technologies," in Contemporary issues in technology and teacher education.

**Boris I. Sedunov** is Deputy Rector of the Moscow State Institute of Business Administration and the leader of its International Virtual University project. Born in Eastern Siberia, he received a Master of Science degree in Engineering-Physics and a doctorate in Physics-Math Sciences from the Moscow Institute of Physics and Technology. He instructs courses on general,

strategic and innovation management, presentation techniques, and modern concepts of natural physics for managers. He developed and promoted the methodology on how to effectively involve English-speaking business teachers from the United States in the current educational process. He has created new theories in statistical physics and the philosophy of management.

**Cynthia L. Selfe** is Humanities Distinguished Professor in the Department of English at The Ohio State University, and the co-editor, with Gail Hawisher, of *Computers and Composition: An International Journal*. In 1996, Selfe was recognized as an EDUCOM Medal award winner for innovative computer use in higher education—the first woman and the first English teacher ever to receive this award. In 2000, Selfe and her long-time collaborator, Gail Hawisher, were presented with the ‘Outstanding Technology Innovator Award’ by the CCCC Committee on Computers. Selfe has served as the Chair of the Conference on College Composition and Communication and the Chair of the College Section of the National Council of Teachers of English. She is the author of numerous articles and books on literacy and computers.

**Dr. Ramesh Sharma** holds a Ph.D. in Education in the area of Educational Technology and since 1996 has been working as Regional Director in Indira Gandhi National Open University (IGNOU). Before joining IGNOU, he was with a Teacher Training College for nearly ten years and has taught Educational Technology, Educational Research and Statistics, Educational Measurement and Evaluation, Psychodynamics of Mental Health Courses for the B.Ed. and M.Ed. Programmes. He has conducted training programmes for the in- and pre-service teachers on the use of multimedia in teaching and instruction, and established a Centre of ICT in the College. His interests include the areas of open and distance learning, ICT applications, on-line learning, and teacher education.

**Mark Shepard** is an artist and architect whose cross-disciplinary practice draws on architecture, film, and new media in addressing new social spaces and signifying structures of emergent digital cultures. He is a founding member dotsperinch—a collaborative network of artists, architects, technologists, and programmers developing new media environments for the arts, museum, design, and education communities. Mark holds an M.S. in Advanced Architectural Design from Columbia University; an MFA in Combined Media from Hunter College, CUNY; and a BArch from Cornell University. He is an Assistant Professor of Architecture and Media Study at the State University of New York (SUNY), Buffalo.

**Professor Brian Shoemith** is Adjunct Professor, School of Communications and Multimedia at Edith Cowan University, Perth, Australia. He has conducted extensive research in Asian media and digital culture. His recent

publications have focused on the emergence of digital culture in international contexts and the different interventions that new media have on different societies.

**Dr. Eleni Skourtou** is Assistant Professor at the University of the Aegean, Department of Primary Education. Her research areas are: bilingualism and bilingual education, orality/literacy/multiliteracies, bilingualism and language contact, bilingualism and second language learning/teaching in an electronic environment.

**Erin Smith** is an Assistant Professor of New Media at Michigan Technological University. She has published on literacy in relationship to video games and other new media. The focus of her current research is on data-base driven writing systems and literacy.

**James J. Sosnoski** is the author of Token professionals and master critics; Modern Skeletons in postmodern closets and essays on instructional technology. He co-edited The geography of cyberspace; Conversations in honor of James Berlin; and The TicToc conversations. He directed the Society for Critical Exchange, the GRIP and TicToc projects. He coordinated the Virtual Harlem project and co-edited Teaching history and configuring virtual worlds: Virtual Harlem and the VERITAS studies. He is writing Configuring: The art of understanding virtual worlds, on the role of virtual experiences in interpersonal understanding.

**Kevin Sumption** is the Associate Director of Knowledge and Information Management at Australia's largest science museum, the Powerhouse Museum. For 15 years he worked as both a science and social history curator and for much of this time has focused his research energies on the creation of computer-based education programs and regularly publishes articles re online learning. Kevin is also a lecturer in Design Theory and History at the University of Technology, Sydney and has been an invited speaker at conferences in the UK, France, USA and Japan. He has also worked for UNESCO on a range of cultural informatics projects in central Asia.

**Jutta Treviranus** is the coordinator of The Inclusive Learning Exchange (TILE) project, and also coordinated the now completed Barrierfree project. Jutta established and directs the Adaptive Technology Resource Centre at the University of Toronto, a centre of expertise on barrierfree access to information technology. She directs the Resource Centre for Academic Technology and is the chair of international interoperability specification working groups in the World Wide Web Consortium and the IMS Global Learning Consortium. Status faculty appointments are held in the Faculty of Medicine, and the Knowledge Media Design Institute, University of Toronto.



**Kylie Veale** is a Ph.D. candidate in Media and Information at Curtin University of Technology, Australia, and has recently graduated from the Master of Internet Studies programme. Her current research interests revolve around environments of use within online communities, and the balance of online activities among publishing, transacting, interacting, and collaborating. Her Ph.D. research programme combines her academic interest in the Internet with a long-time hobby—genealogy—by investigating a broad set of interactions of the online genealogical community, as a case in point for hobbyist usage of the Internet.

**Dr. Lucas Walsh** is currently a postdoctoral research fellow within the School of Communications and Multimedia at Edith Cowan University, where he is engaged in research on democracy and interactive environments. He is also a Fellow of the Department of Learning and Educational Development at the University of Melbourne, in Australia.

**Prof. Barry Wellman** leads the NetLab at the University of Toronto, studying the intersection of computer, communication, and social networks in the communities (the “Connected Lives” project) and organizations (“Transnational Immigrant Entrepreneurs”; “Media Use in Organizations”). He’s the founder of the International Network for Social Network Analysis, the chair of the Communication and Information Technologies section of the American Sociological Association, and the chair-emeritus of the ASA’s Community and Urban Sociology section. Prof. Wellman has co-authored more than 200 articles and is the co-editor of Social structures: A network approach (1988); Networks in the global village (1999), and The Internet in everyday life (2002).

**Dr. Angela F.L. Wong** is an Associate Professor with the Learning Sciences and Technologies Academic Group, National Institute of Education (NIE), Nanyang Technological University, Singapore. She is also the Associate Dean for Practicum and School Matters in the Foundation Programmes Office. The practicum is the teaching practice component of all initial teacher-training programmes at NIE. She currently lectures in instructional technology and classroom management modules. Her research interests include learning environments, science education, instructional technology and practicum-related issues in teacher education.

**Yong Zhao** is Professor of Educational Psychology and Educational Technology at College of Education, Michigan State University. He is also the founding director of the Center for Teaching and Technology as well as the US-China Center for Research on Educational Excellence. His research interests include educational uses of technology, school adoption of technology,

and international education. Zhao received his Ph.D in Education from the University of Illinois at Urbana-Champaign.

**Professor Wanlei Zhou** received the B.Eng and M.Eng degrees from Harbin Institute of Technology, Harbin, China in 1982 and 1984, respectively, and the Ph.D. degree from The Australian National University, Canberra, Australia, in 1991. He is currently the Chair Professor of IT and the Head of the School of Information Technology, Deakin University, Melbourne, Australia. Before joining Deakin University, Professor Zhou had been a programmer in Apollo/HP in Massachusetts, USA; a Chief Software Engineer in High-Tech Computers in Sydney, Australia; a Lecturer in the National University of Singapore; and a Lecturer in Monash University, Melbourne, Australia. His research interests include theory and practical issues of building distributed systems, Internet computing and security, and e-learning. Professor Zhou is a member of the IEEE and IEEE Computer Society.

**Anita Zijdemans** is a doctoral candidate in Applied Cognitive Science in the Department of Human Development and Applied Psychology at OISE/UT. Her interests lie in fostering and supporting communities of learning in diverse contexts and settings, through the creation of virtual environments based on design principles informed by human development & education, learning & technology, sociology, and human/computer interaction. Anita holds an Honours degree in English/French, a Bachelor of Education from York University, and a Master of Arts degree in Human Development and Applied Psychology from the University of Toronto.

**Slavoj Zizek** is a Slovenian sociologist, philosopher and cultural critic. Zizek was born in Ljubljana, Slovenia (then part of Yugoslavia). He received a Ph.D. in Philosophy in Ljubljana, studied Psychoanalysis at the University of Paris, is currently a professor at the European Graduate School and a senior researcher at the Institute of Sociology, University of Ljubljana, Slovenia. He is a visiting professor at Columbia, Princeton, New School for Social Research, New York, and the University of Michigan.

# Introduction: Virtual Learning and Learning Virtually<sup>1</sup>

JOEL WEISS

... imagine for one full day what life would be like without access to current technologies such as computers, cell phones, handheld devices, DVD's, the internet, data systems, or e-mail. (Bromfield, 2005, 1)

This is a description of a recent internet-based school curriculum initiative for students, teachers and parents to imagine life without modern technologies. While the context is North American schooling, the implications are far-reaching for all. Regardless of our location on the planet, and the cultural and language spaces in which we work and live, computers and other technological innovations influence our lives to a greater extent all the time. As computers take on a more visible role in our lives, moving from government and research institutions into our communities, schools, and homes, we become more aware of how these are both mediators of, and in themselves, learning settings.

Created learning environments are as old as societies' first attempts at socializing its young, and these settings have taken a variety of forms ranging from the concrete literal to the creative imaginary. The relatively recent development of the digital age has spawned interest in what has come to be called 'virtual reality' and in delineating what this means for learning and the creation of 'virtual learning environments'. This Handbook was created to explore features of virtual worlds and the relationships with diverse learning settings. Since the concept of, and discourse surrounding, virtual learning environments are not well developed in the literature, a deliberate strategy has been to be expansive in choosing contributions. We sought out numerous contributors representing multiple discourses with the aim of creating some coherence in a complex field.

The resultant inclusion of sixty-three chapters requires creating some advanced organizers by which to view the project. First, what is meant by

<sup>1</sup> The International Handbook of Virtual Learning Environments has been quite the transformative experience. Jason Nolan has been his usual provocative self, pushing me in new directions throughout the various stages of the Handbook's development. Jeremy Hunsinger added some new directions when he joined us two years ago to replace Peter Trifonas who took on other professional responsibilities. Vera Nincic's skills in the virtual world enriched the project. From the beginning, Michel Lokhorst, a former Senior Editor at Springer, encouraged us to make this an enjoyable, worthwhile professional experience.

technology and does 'virtual' always, implicitly or explicitly, require modern technology ushered in by the 'computer age'? Second, what view of learning allows for the broad spectrum of possible situations that people interact with in their complicated lives? Third, since the editors are primarily educators, is there an educational framework that provides a useful form of coherence for the topic of virtual learning environments? What follows immediately are sections which discuss technology and its relationship with virtual learning, a delineation of views about learning and an educational framework that relies upon perspectives on curriculum. Following that is a section on The Curriculum of the Handbook, including a description of its structure and each of the included chapters, and some thoughts about future activities.

#### TECHNOLOGY AND THE VIRTUAL WORLD

Technology is a complex construction: "It includes activities as well as a body of knowledge, structures as well as the act of structuring." (Franklin, 1990, 14) Its complexity has been evident throughout the history of considering the so-called real world. When we turn to a consideration of cyberspace, this complexity is no less evident. Technology helps to create, and is also the site for, virtual learning environments. It's both part of the process and is also a product.

It has become commonplace to describe the learning environments mediated by computers and digital technologies as virtual learning environments (VLEs) in order to separate them from the real world learning environments that have been with us since individuals came together to form communities and societies at the dawn of our various cultures. However, as Burbules points out in the first chapter of this volume, virtual can be an illusory concept, one with multiple meanings. A learning environment doesn't necessarily have to involve digital technologies in order for it to be considered a virtual learning environment. People over the centuries, especially through the arts, have developed learning settings where individuals need to use their imagination, often including the realm of fantasy, thus creating VLE's.

I believe the confusing element in the virtual equation is the view that only computer technology is both the necessary and sufficient criterion for a virtual learning environment. It is a misunderstanding of technology that is clearly enunciated by Ursula Franklin in *The Real World of Technology* (1990). She describes technology: as 'a practice' and her description of what it is not is informative for this discussion. She writes: "Technology is not the sum of the artifacts, of the wheels and gears, of the rails and electronic transmitters. Technology is a *system*. . . . Technology involves organization, procedures, symbols, new words, equations, and most of all, a mindset." (12) It is the idea of mindset that suggests that the virtual is a concept of the

imagination, the power of constructing possible models of human experience (Fry, 1969).

There are a variety of media for imaginative learning environments including oral speech, writing, print, movement, photographic, electronic as well as digital. Educators of a variety of backgrounds from formal, informal and non-formal groups, including parents, media specialists and artists have used a variety of practices for stirring the imagination of learners. Who hasn't experienced, for example, literature, creative writing, music, role-playing as settings for learning? This presumes a more historically focused long-term perspective on technology, which includes such examples as the development of the printing press, the use of pen and ink, photographic process, film, radio, television and the like.

In order to indicate that there are many types of virtual experiences, I make a distinction between virtual learning and learning virtually. Virtual learning is reserved for digital/ computer-based learning environments. Learning virtually is a much broader term signifying any context that allows for imaginative possibilities. It includes environments utilizing a broad array of traditional media and contexts for meaning making. For example, the use of settings employing literature (in its various forms) engenders a process of interpretation by a learner, leading to the creation of virtual, different from actual, texts (Bruner, 1986). The process of creating a virtual text can be seen as initiating a learning journey that uses previous experiences and images as markers in, and of, the creation. Bruner suggests that features of discourse enable readers to create their own virtual worlds through making implicit interpretations, depicting reality through a lens of the consciousness of characters, and often filtering the world through multiple interpretive screens. He also presents concrete comparisons between a reader's created virtual, and the actual, text (Bruner, 1986, 161–171). Learning virtually is possible with other settings that enable learners to make imaginative interpretations. Interactions with other objects (paintings, prints, photographs, musical and dramatic presentations) and media (radio, movies, television, television) are but a few of the possibilities for creating virtual texts.

Where the two terms merge is where digital representations of learning environments use procedures that existed prior to the computer age. Examples of VLE's that are primarily complex transformations of activities that exist in the real world without computers include writing an essay or sending a message by e-mail, viewing a page of text or an image, perhaps reading an e-book, or undertaking some teaching or training activity. Other VLEs are more fully realized virtual experiences for which no analog exists outside of the computer; the ability to create new worlds, new topologies, new people, and experience them, embody them, transform them in collaboration with individuals from around the globe is truly a virtual experience. However, from an educational perspective, both types of learning environments are subject to similar criteria for success in whatever is supposed to be learned. Some

criteria may be more appropriate for some environments than for others, but it's not so clear as to whether virtual learning requires substantially different ones than other types of learning environments. Perhaps the imaginative use of technology creates differences of kind as opposed to type.

Often, the rhetoric surrounding any important innovation can be fraught with hyperbole. With more and more changes in technology and applications associated with the technology becoming mainstream, there is the real concern that expectations for what virtual life means for learning and the creation of learning settings outstrips the capability. The existence of an application does not necessarily guarantee success as intended. Technology and associated applications start with potential, but there are many features that guide the direction of where and how that potential becomes realized. The application of technology cannot be considered in the abstract- it requires an understanding of the educational landscape in which it is considered. The next section provides the view of learning that helped to frame choices included in the Handbook. I also present an educational framework from a curricular perspective that has been useful in analyzing the rich complexities of VLE's.

#### LEARNING, CURRICULUM AND VIRTUAL LEARNING ENVIRONMENTS

The view of learning that informs our work is an amalgam of traditions best summarized by Kolb as “. . . learning is the process whereby knowledge is created through the transformation of experience’ (1984, 41). The importance of learning in all facets of our lives, and our experience with the world around us, can be seen as the participation in an interconnected series of learning environments. Some we engage with as part of social, educational and economic interactions, and some as personal and spiritual experiences. In reality, these experiences are located in, and mediated through, learning environments. These environments should not be viewed as belonging exclusively to the formal educational sector. There are plentiful informal and non-formal contexts that are potential situations for ‘learning moments’. Our encounters with the natural environment provided the impetus for the ‘romantic ‘view of learning espoused by Rousseau. For the most part, however, we usually consider creating settings for maximizing the possibilities of ‘learning moments’. These settings may differ depending upon specific cultural arrangements that help to describe the practices of any particular society. However, there are situations common to all societies where learning is necessary. Such examples include childrearing, physical and emotional survival, work, spiritual activities, leisure time pursuits, and life ritual situations of birth, coming of age, procreation and dying. Later, I discuss the concept of the curriculum of life that includes these, and other potential learning settings.

In searching for a perspective for the Handbook, there's both an embarrassment of riches, as well as a paucity of material related to VLE's. There is

no shortage of writing about the virtual world. Beyond Marshall McLuhan, William Gibson, Bruce Sterling and other writers of science fiction and future worlds, there has been an explosion of both popular and academic material. Many fields of study and disciplines have important contributions to make about this world. Several come to mind- political science and politics; anthropology; history; sociology; cultural studies and media; literature and English studies; computer science; communication; feminist studies; medicine, law, architecture, engineering, design and other professional fields; geography; psychology and cognitive science. People trained in the field of education have made their own contributions, especially in computer studies, higher education, teacher education and learning networks. While all of these areas have contributed to our understanding of virtual worlds, I suggest that our knowledge of virtual learning environments is still somewhat opaque and requires more clarity. Because the editors of this Handbook have approached this project from an educational stance, it is incumbent upon us to further clarify how an educational stance is one perspective by which to develop discourse on virtual learning and virtual learning environments. This perspective assumes a broad reach on what education is and who is an educator. Although many of the contributors in this volume would not self-identify as trained in education, we have assumed that regardless of their background, they are educators in an important sense-interested in communicating and involved in the teaching/ learning process. Thus, from our perspective, they're all engaged in a curriculum-making activity.

I have chosen to use some of the discourses surrounding the concept of curriculum as an approach to elucidate aspects of virtual learning environments. This provides a metaphoric compass, enabling some boundaries to be placed on analyzing the multiple discourses that are found in the literature of virtual learning environments.

### **Curriculum Commonplaces**

The term "curriculum" is deliberately used as something broader than its usual location as an aspect of schooling, because curriculum is something that provides scaffolding for learning in any setting. A conceptual tool for understanding this structure is a set of commonplace terms containing a minimum required for describing any curricular situation (Weiss, 1989). These include 'learner', 'teacher', 'subject matter', and 'milieu' in which these other concepts function. I view these commonplaces as a generative metaphor (Schon, 1979) representing a pervasive tacit image that influences actions, such as development and policy activities. Since curriculum is a value-laden concept, each of the commonplaces represents the potential for different points of view, and potential action. As an example, there are different perspectives on "the learner", ranging from an empty vessel receiving information, to a

stimulus-seeking, curiosity driven person constructing his/her own sense of the world. Notions of “the teacher” are representations of different approaches to pedagogy including people, machines and other forms of technology used to engage learners. Every curricular engagement deals with learning/teaching about content, the commonplace of “subject matter”. This represents a wide spectrum of possibilities including school subject matter, information for our personal life, such as medical or travel possibilities, or even processes involved in exposure to that setting. “Milieu” refers to the variety of conditions under which the learner, teacher and subject matter interact. This includes the specific conditions, such as setting, materials used, time of day, and the like. It also includes the broader historical, political, social and economic factors that shape the context for any particular learning engagement. Any curriculum “moment” is a distillation of the complex interactions among the commonplaces.

#### **Hidden and Null Curricula**

The field of curriculum continually wrestles with the dilemma of what language to use in characterizing its structure. Jackson (1992) presents an extensive discussion of the various terminologies used over the years to describe what counts as “curriculum”. Generally, it is defined in terms of the outcomes of a complex teaching-learning context. However, two contrasting sets of outcomes, characterized as positive or negative, frame the discussion so that two separate curricula have become the norm in curriculum discourse. One is explicitly endorsed, while the other is not. Labels attached to this dichotomy include: intended/unintended, accomplished/unaccomplished, written/unwritten, delivered/received or experienced. The most popular representation of the negative curriculum is the ‘hidden curriculum’. The term was coined by Jackson in *Life in Classrooms* (1968) and has assumed mantra-like importance to critics of educational structures and institutions (Apple, 1980; Vallance, 1977). The concept has been useful in exposing the values, attitudes and structural mechanisms underlying curriculum decision-making and activities and may provide a way to look at what’s transpiring in creating and maintaining VLE’s.

A related aspect of the hidden curriculum is the notion of the ‘null curriculum’ (Eisner, 1979; Flinders, Noddings, and Thornton, 1986). This concept is based on the recognition that learning involves both opportunities and lost opportunities; that every choice may exclude other possibilities. The underlying issue of the null curriculum is the opportunity to learn, or more appropriately, lost learning opportunity. This is similar to what economists refer to as opportunity costs. In the context of formal learning environments, the null curriculum may be in operation when basic skills are chosen over the arts as an explicit indicator of setting priorities. But on a systemic level, the null



curriculum is more problematic. Content, language, and evaluative structures that privilege one culture, gender or language group over another represents the outcomes of a null curriculum that limits opportunities for some learners while providing advantages for others. At a deeper level, funding strategies that privilege different social groups or place restrictions on the scope and choice of available learning environments influence what kinds of things *can* be learned. These examples are not necessarily hidden, but they are often ignored for what they are, and are taken for granted as factors effecting the creation of learning environments by educators, parents, students and policy makers. For example, in the context of the internet, there are numerous examples of such lost opportunities, ones in which individuals make conscious choices of what to attend to, and those which are structured so that there is little or no choice in one's activities. The latter is where the hidden and null curricula intersect.

The hidden curriculum represents the barriers that cannot be easily identified and rendered problematic. What people think they are experiencing and participating in *is* the curriculum and often the hidden curriculum is what ensures the maintenance of the null curriculum. Encountering both involves unpacking these curricula by identifying the 'taken for granted' features and to suggest strategies for finding the complexities and values that are not explicit. This helps to direct what and how we can learn.

Just as there was a real person manipulating events behind the screen in "The Wizard of Oz", so there are people making curriculum decisions behind the technology in learning environments. Whoever is behind the screen, such as teacher or software developer, makes value choices from among competing perspectives about the various commonplaces. Choices made about obvious categories of the learner, such as age, gender, language competence, social background are grounded in images of these characteristics. These competing images can be represented as questions of choice. Are learners seen as being active or passive, flexible or rigid, knowledge constructor or empty vessel? How much experience have they acquired with settings that require imagination and fantasy? Is there a particular modality, or familiarity with media/technology favored within the setting? Is there interest in individual learners or with a community of learners? Questions related to choices made about the nature of knowledge might be: What kinds of previous knowledge and skills must be accounted for in creating a learning environment? Is it assumed that knowledge is personal or general? How valid is the information that is found on a particular website? Are there conflicts among various groups and/or individuals as to what is acceptable for people to know? How do you negotiate between process and substance considerations? Are the materials and/or settings novel or familiar to learners?

What views of teaching inform the structure of the learning engagement? Is it structured as an information provider solely, or as enabling a more constructivist approach? Does the use of sophisticated technology make a difference

to the underlying approach? To what extent do learners encounter in real life people (parents, teachers, friends, professionals) as well as those behind the screen?

How much of the learning encounter is framed by the technology so that learners interact in ways that differ from more traditional settings? Are materials readily available or does the setting encourage learners to shape the conditions for learning? What are the limits for technology to shape vicarious experiences? Is technology viewed as a neutral tool, a variable kept under control, or as a socially situated setting where technologies serve as mediators? How much does the reality of the digital divide influence the larger picture of access to resources? How do policies and programs from governments, the private sector and non-governmental organizations (NGO's) influence the conditions for learning virtually and virtual learning?

#### **Curriculum of Virtual Community**

Some of these features of curriculum discourse have facilitated an understanding of virtual learning environments. In a book devoted to an exploration of the concept of virtual community, Nolan and Weiss (2002) conceptualized a Curriculum of Virtual Community to explore some of their learning features. They posited three broad locations for learning: Initiation and Governance; Access; and Membership. There is the location associated with first initiating and then maintaining the locus of interaction, The Curriculum of Initiation and Governance is associated with the learning required for initiating and maintaining the site of a virtual community. Curriculum of Access is associated with accessing and becoming socialized to virtual community itself, which includes what is required to become a member: learning about the site, how to access it, and the rules that govern membership. Finally, there is the Curriculum of Membership that relates the actual engagements in the community, the purposes for which the site was constructed and the gains people expect from it.

Many features of virtual community may translate to the larger community of the internet. This meta-community comprises almost limitless numbers of communities, and information nodes and networks devoted to among other things: commerce, education, governance, and social life. The internet requires interactions among five key industries: telecommunication, software, internet service providers, search engine providers, and web content providers.

Much of what transpires *on* the internet is largely opaque, often seen as value neutral. Weiss and Nolan (2001) expanded their conception of the Curriculum of Virtual Community to discuss some of the learning features of the internet. Using the concepts of curriculum commonplaces, null curriculum and hidden curriculum, they analyzed some of the taken for granted structural

features of the internet. Since that time, there have been a number of developments that have impacted our knowledge base of the internet, rendering it as a more transparent structure. For example, while its early development had been dominated by contributions of white Western males, now much of the technology and use has become more widespread, witness the contributions from India, China, other Asian countries, as well as those from the Spanish-speaking world. Clearly, there are now many more contributions being made by females. Perhaps the most visible sign of the changes is the creation of the World Summit on the Information Society, and the very open process being conducted by the Working Group on Internet Governance (WGIG) whose tasks were to: “develop a working definition of Internet Governance; identify the public policy issues that are relevant to Internet Governance”. The results of this activity have been disseminated for worldwide discussion by making information available in numerous languages and in several formats (<http://www.wgig.org/>).

Other examples of changes in the internet can be found in the ways that individuals and groups have become involved in more open-ended, empowering formats. The process of blogging has become an important, often creative, activity in many peoples’ lives, touching upon the personal, political, social and the aesthetic. It has had serious impact upon the conduct of the media, governments and the political process. Another prominent example of the empowering nature of the internet is the development of Wikipedia, a web-based, multi-language, free content encyclopedia ([en.wikipedia.org](http://en.wikipedia.org)). It is written by volunteers and sponsored by a not-for profit foundation, Wikimedia Foundation. It has been created and distributed as a free encyclopedia in over two hundred languages, and has become one of the most popular internet reference sites. It differs from the conventional encyclopedia first developed by Diderot because anyone can contribute, regardless of any claim to authority on a subject. It is interactive since readers can edit an entry and have it instantaneously recorded online. Editorial policies are derived through consensus and occasional vote. Wikipedia has served as a model set of procedures for other groups to create their own communities of use. There are any number of curricular issues highlighted by this endeavor, especially ones related to views on the nature of knowledge, characteristics of learners, and issues of power and control.

These are but a few examples of many more complex issues and situations in which a curricular perspective might allow useful analyses. My purpose has been to provide a brief elucidation of some of the concepts that have helped me to unpack some of the features of a virtual learning environment. A number of the issues represented here are part of the stories told, in their own terms, by many of the authors in this Handbook. With this in mind, I now turn to a more focused description of this Handbook.

Any text should be seen as a set of curriculum materials, developed by some individuals for the use of others. This requires a set of intentions by the developers, in this case the Editors, through choices dictated by their views on the curriculum commonplaces around the topic of virtual learning environments. The Editors' backgrounds have driven the choices made of the framework, the medium, and the various represented topics. This translated into decisions about authors and genres. At one level, the Editors and authors provide the *teacher* aspect of the commonplaces. These decisions were determined with a view of the audience, the potential *learners*.

The *subject matter* of this project has been to describe the wide landscape of possibilities for discussing, conceptualizing, creating and inquiring into, virtual learning environments. The approach has been to consider a spectrum of discourses and the choice of authors and chapters attests to that accomplishment. This broad framework includes locating some of the historical narratives of various features and milestones of VLE development; exploring the differing conceptions of what VLEs were, are and might be; discussing issues surrounding the construction and governance of VLEs, including curricular and pedagogical features; describing case studies of created virtual learning environments in a variety of formal and informal parts of our everyday lives; and inquiring into the conceptions and forms of educational research that shed light on the development and application of VLEs in various social contexts and cultures.

Part of the story is told by recounting important parts of the past as well as the present scene. We have viewed learning in a diversity of environments to which people are exposed. Consistent with our framework, a curriculum of life was a useful organizer for the types of settings discussed by many of the contributors. We divided this curriculum into two broad categories: one concerned with more traditional aspects of schooling, professional learning and knowledge management; and the other with many of the other important learning settings in people's lives.

The content is divided into four sections: 1. Foundations of Virtual Learning Environments; 2. Schooling, Professional Learning and Knowledge Management; 3. Out-of-School Virtual Learning Environments; and 4. Challenges for Virtual Learning Environments.

Given its topicality, there is potential interest in this subject matter for a variety of audiences (*learners*). Most of the contributors are academics deliberately chosen for their expertise and often, their provocative views on their topic. Since so many different disciplines and fields are represented, we hope that readers will not only seek out material from their own areas, but will benefit from an understanding presented from other perspectives. Any piece of curricular material should have the potential for a learner creating

new knowledge through transforming experiences. We also hope that a wide spectrum of practitioners in a variety of educational settings, such as schools, libraries, museums, health care, leisure industries, communities and others will find some of the material appropriate for their practices.

In considerations of *milieu*, our choice of a two-dimensional text medium is admittedly traditional for investigating virtual worlds. In part, this reflects the political economy of publishing in spite of the rise of e-books and possibilities for the Net. However, we like to think that many of the contributions provide the possibility for learning virtually, that is, they stimulate the imagination and suggest a sense of fantasy. This point is elegantly made by Burbules in our first chapter: “. . . an academic article can also be a virtual environment—one that you complement through your own interest, involvement, imagination and interaction.” We also decided to reprint several provocative pieces originally published for audiences different in many ways from the present context. This includes Donna Haraway’s classic “Cyborg manifesto”; Slavoj Žižek’s “The Matrix, or, the two sides of perversion”, an analysis of the influential film to develop important theoretical formulations; and Jeff Noon’s “Chromosoft mirrors”, a pithy description of the dark side of virtual worlds. While a few in our audience may be familiar with one or more of these imaginative pieces, we believe that the wider audience should be exposed to their ideas. We especially wanted educators to visit, and in some cases, re-visit Haraway’s ideas through the prism of relevance to classroom teaching/learning. Another contribution that should engage the reader with concrete manifestations of the fantasy world of cyberspace is found in Steve Mann’s intriguing description of this engineer’s life as a virtual learning environment.

Any presentation of the story of an important topic needs not only content from past and present, but also a sense of future issues. This requires a rendering of ideas developed out of relevant inquiry and of considered thought on potential possibilities/constraints. No less than other areas, virtual learning environments require a strong basis for inquiry to investigate the myriad claims made for education in cyberspace. How salient will exciting technological innovations be for changing the learning equation?

### **Section One: Foundations of Virtual Learning**

The opening section of the Handbook, **Foundations of Virtual Learning Environments**, provides a number of perspectives for an understanding of the virtual world and learning. The idea of the virtual is laid bare in the introductory chapter by Burbules. He questions the several different interpretations placed on the concept and sets the stage by suggesting that virtual learning is closely linked with learning virtually through the “as if” experience. Digital technology is not viewed as necessary and sufficient criteria for learning in a virtual way.

However, the topic of technology can be seen as leitmotif for several of the other contributions in this section. Harasim's extensive history of e-learning traces the role of technology and discusses its impact on a shift in the calculus of learning. For her, this shift represents an optimistic future for the digital world to be influential in creating more relevant learning environments. Other contributors take a more nuanced view of the role of technology in learning. Peters believes that our philosophical knowledge base about technology is not well formed and suggests that a theoretical discussion on technologies would equip us to better understand the issues at hand. He analyzes several approaches to technology for their implications for a knowledge economy. Such a mapping strategy is an attempt to move beyond economic theories and technological innovations in order to shape public policy and create new fields of knowledge and research. Haraway's original contribution, "The Cyborg Manifesto", was a demonstration of political activism in using the concept of the cyborg to show how humans are implicated in technological systems. Working from feminist and socially conscious frameworks, she opened up the discourse about classroom technology issues and pedagogy in computer-mediated settings. She discussed a number of signifying practices in efforts at meaning making, cultural coding and social system construction, and has had great impact on academics in a number of areas, but especially those teaching composition and feminist studies. Selfe and Smith provide a discussion of the impact of "The Cyborg Manifesto" on both academics and practitioners and suggest that this work permanently joined class, race, sexuality and gender to technology discourse. An important part of the Selfe and Smith contribution is a global history of the importance of technology from a political economy perspective.

Hunsinger also addresses technology through issues of power relationships as embedded in informational capitalism. He suggests that there is a need to understand underlying biases, values and ideological positions embedded in the milieu as part of the responsibility toward technology's usages. By rejecting conformation to the business model, and treating education as a public good, he suggests that VLE's can be transformative regarding learning and the world. (This is in direct contrast to the argument made earlier by Davis and Botkin (1994) that schools have become irrelevant in the learning society.) Issues of resistance and transformation are also topics discussed by Nolan and by Kellner. The former looks at what is happening in the Net as a means of engaging "... the deep structure of hegemony of digital technology revolution". Nolan goes well beyond my earlier remarks on the curriculum of the internet, by providing a history of its foundation and genesis and by suggesting several technologies of resistance, such as consumers acting as prosumers, for learning to be a transformative experience. Kellner challenges educators to make changes in order to cultivate the multiple literacies required for technological and multicultural societies. Like John Dewey and Ivan Illich, he believes that education is a necessary ingredient in bringing about true democracy. Whereas

he believes that Dewey failed in that objective, he suggests that pragmatic experimentation regarding technology and multiculturalism should lead to a re-visioning of education. Carmen Luke also wants to transform education in the fluid and mobile 'wired society' that has reconfigured our notions of time and space. She believes that the current challenge is to "...devise flexible, innovative, analytical tools with which to track the fluidity and mobility of 'travel' across the semioscape of links, knowledge fields, web pages, chat rooms, e-mail routes, inter-subjective and intercultural relationships".

Ito goes beyond the screen to investigate the human-machine interface. She looked at how young children interact with the software of games and determined that whatever the intentions of the software developers, learners can have a sense of agency in what they do and how they engage in the setting. By calling attention to the sociality of the interactions, she suggests that we have to question our prior understandings of social structures co-constituted by people and machines encountering one another across an increasingly complex set of interface conventions, as well as the relations of production and consumption that bring these actors together. The final contribution in this section by Maxwell addresses the important concept of constructionism, which has been featured in the discourse and practice of the digital age, for discussions about the nature of learning. He traces the pioneering work by Papert, Turkle and others in the Epistemology and Learning Group at MIT's Media Lab that articulated that 'learning happens best when children are engaged in creating personally meaningful objects and sharing them with their peers'. Maxwell re-examines the concept in terms of other ideas from situated learning, media theory and science and technology studies (STS), and suggests a new approach, "distributed constructionism". His work should stimulate reflection on past ideas as well as provide a provocative way to introduce an ecological perspective on the topic.

## **Section Two: Schooling, Professional Learning and Knowledge Management**

The second section of the Handbook, **Schooling, Professional Learning and Knowledge Management** represents more traditional settings for VLE's. However, the authors develop their ideas in important ways, and in some cases explore unmarked terrain. This includes chapters that discuss various aspects of schooling including issues related to school culture and organization, learner considerations, specific classroom related practices in language development, inclusive learning, and applications of virtual environments. Discussion about schooling and virtual learning requires attention to the teacher in this learning equation. It comes as no surprise that teachers are required to be learners in an environment where many have little background. Three chapters provide material on different aspects: student/teacher interaction in the virtual learning setting; narrative inquiry about how rural African teachers engage

the digital world with few resources; how teachers create virtual communities of practice; and VLE's in teacher education. There is probably no formal educational location that is changing more rapidly in the digital age than is Higher Education. Several chapters address the history as well as personal observations about this important site. Much has been written about the global effects of the digital age on education systems and educators. Contributions on this topic include viewing national educational technology plans, VLE's in the Asia-Pacific region, and global online education and organizations for online educator activities. Academic publishing is an area that has been greatly influenced by the digital revolution, and we present a chapter that provides a fascinating case study of the conversion of a mainstream journal into an online professional learning environment. The last contribution discusses the interface of forms of professional development and knowledge management strategies in the virtual environment.

This section starts with a realistic appraisal of the use of the internet in the school setting. While no one questions the internet as an important innovation, Schofield's research indicates that its existence alone doesn't guarantee success. The culture of schooling contains many complex processes and activities and this contribution analyzes four factors inhibiting the use of the internet. The optimism for virtual learning in schools has led to some believing that a school can be transformed into a virtual school. Russell explores some of the important issues surrounding background, features of online school environments, how they compare with traditional schooling, research possibilities and musings on the future of this concept. Brown and Weiss question the rhetoric surrounding the claims made for virtual schools. They discuss the concept relative to time and space issues surrounding the organizational arrangement of the school calendar, and the bricks and mortar components of most so-called virtual schools.

Ainley and Armatas provide an extensive overview of issues related to learners, and learning in the virtual environment. They discuss useful information about the impact of both situational and individual factors in the learning setting, introduce research evidence from comparisons between traditional and virtual settings, and suggest that our knowledge base about learning is enhanced by studying the virtual environment. Kinshuk and colleagues offer some ideas from cognitive science to issues about user adaptation in virtual learning environments. They describe the development of learner modeling techniques for monitoring and measuring various attributes, such as working memory capacity, inductive reasoning skill, domain experiences as well as setting complexity. They suggest that such information would be useful for curriculum developers of virtual learning environments. Underlying their approach is a view of technology as a neutral set of practices in the learning context.

From the use of pens and chalkboards to more current innovations, the application of technology in school settings is potentially limitless. Numerous



examples of technology usage has indicated mixed results, not a surprising result given the complexities of curricular work. We have included several contributions that illustrate either an important application, setting or subject matter area. Sponaas-Robbins and Nolan present a topic that might be included almost anywhere in the Handbook because of its widespread history and application to different parts of life. However, because MOO's represent polychronous collaborative virtual environments and have had applications in the classroom setting, it seemed appropriate for this section. The application derives from Multi-User Domain (MUD) that is Object Oriented, hence the term MOO. It is a text-based online setting that allows users to be creative in developing representations of people, places and things (the objects) to be shared with one another. This is a good example of a convergence between virtual learning and learning virtually, and the authors have addressed the topic with a critical eye. Since language text is usually the edifice upon which learning is built, it made sense to include a contribution about virtual learning environments for this area. Skourtu, Kourtis-Kazoullis and Cummins discuss their experiences in designing VLE's for academic language development. They discuss the use of Instructional Technology (IT) within a Habermasian framework of three different pedagogical approaches: transmission-oriented, social-constructionist and transformative. The important message from their work is that IT may be more meaningfully employed with certain forms of pedagogy than with others. Their findings suggest that more progressive approaches than the transmission model are more efficacious in learning academic language, problem-solving, thinking and imaginative skills, and affirmation of self-identity. The important concepts of disability and inclusive E-learning are extensively discussed in the chapter by Trevarinus and Roberts. Their approach turns disability from just considering the commonplace of a learner's personal characteristic into the relationship between the learner and the broader educational environment. This suggests a truly inclusive perspective about learning that defines accessibility as the need for educational systems and personnel to adjust to all learners, and is in keeping with the Handbook's orientation which defines learning as the transformation of experience for the creation of new knowledge. These authors present material that indicates that computer-mediated learning can benefit marginalized students or those who do poorly in more traditional learning environments.

The role of teaching in any setting is complex, and especially in the virtual learning environment. Black provides a fascinating account of the topsy-turvy situation where teachers and their students reverse roles. Because so many students are often highly skilled with technology and many teachers lack their students' skills in virtual settings, students become the expert in the classroom. How teachers cope with the role of learner to their student's role as expert presents an unusual, but increasingly familiar setting for understanding issues of power in the classroom. Henning presents a very different setting for teachers in her country of South Africa. In addition to a recognition of

how the digital divide operates in nonprivileged settings where even access to phones, let alone computers, is difficult she provides a narrative inquiry of six teachers' experiences in the wired world. It's an excellent illustration of how the use of technology education necessitated the development of spontaneously developed informal learning groups. In the much more privileged environment of a major Canadian university, Hibbert and Rich explore the purposes of VLE's in professional development. They contrast two types of environments, one that prepares teachers as disseminators, and the other as knowledge constructors. They suggest that the latter leads to virtual communities of practice as the preferred setting for creating articulated space for participants to learn and grow and re-energize. Otherwise, technological saturation and fatigue may result. A related aspect of virtual life in professional development is the issue of how teachers and researchers communicate with each other using web tools. Korteweg and Mitchell discuss the interface between teachers and teacher educators through their use of technology. They look at how researchers and teachers communicate through the use of web tools, and their research suggests, once again, that the efficacious use of a virtual learning environment depends more on non-technological events and social situations than on technology itself.

One level of education that has been much influenced by the digital age is Higher Education. There are some who are suggesting that the traditional university will become obsolete in favour of the "virtual university", and there's no question that universities are in a change state. We present two views on the impact of technology on this institution: one from a small country, New Zealand, and the other from an American perspective. Both view the events in Higher Education through the lens of increasing globalization in the knowledge business through corporations and media institutions. Pauling provides an extensive background history of developments in New Zealand and some of the ways that technology is impacting its' system. He opines as to whether trends in competition, globalization and media concentration are threatening to the indigenous nature of his country's Higher Education system, or the possibility that a newer socially positive institution will emerge. Luke provides some critical observations on a decade of digital impact on distance learning. He provides an extensive case study of his own university's efforts, including resistance to these efforts, and discusses the realities of unintended outcomes and aspects of a hidden curriculum. He too sees two possible outcomes of these efforts, and suggests that both positions have to be more clearly articulated and understood.

The world-wide situation of embracing the concept of global competition in the digital age has influenced the rhetoric and some of the practices of national education systems. But what do we actually know about the policies and practices of different countries related to the provision of virtual learning environments, especially given the bias in the literature toward information from North America? Zhao, Lei and Conway complement their past research by

providing information from a variety of countries on their national technology plans.

Information on virtual learning environments in the Asia-Pacific region (Hong Kong, Taiwan, China, Korea, Japan, Singapore, Australia and New Zealand) is contributed by Hung, Der-Thanq and Wong. In addition to descriptive detail about activities in each country, they raise important issues, such as the influence of Western culture on Eastern culture, especially around views on the curriculum commonplaces; the dominance of the English language; how flexibility and accessibility may contribute to a furthering of the digital divide (ironically, flexibility may enhance the null curriculum); and confusion over adopting standards for learning objects and web pages.

The importance of virtual learning environments providing opportunities for professional development and networking in a non-institutional context is the subject of the last chapters in this section. This includes contributions that discuss how academics have developed and use a global online network, how electronic journals enhance the possibilities for more interactive learning for professionals, and issues surrounding professional development and knowledge management in virtual spaces.

A group of educators from around the world have demonstrated how the internet is transforming ways in which academics can network both for research and professional development. It was not long ago that academics of like interests created “invisible colleges” that were limited to a small number of individuals, and communication about this work was generally tightly controlled (Price, 1961). The World Association for Online Education (WAOE) is an academic guild, or network, that was developed to go beyond governments and individual institutions so that educators from around the world could work co-operatively. We have included two examples of the activities of WAOE. McCarty and several colleagues, representing the diverse geographic regions of Japan, Malaysia, Russia and India, report on a multidimensional investigation of the educational impact of the internet. This includes the framing of some of the issues through the use of a Global Online Education Questionnaire, conceptualizing important issues about online education for developing countries, and presenting in-depth case studies. Although each author spoke the language of their region which was useful for their case study activity, all of the other communications were in English. Their results highlight important issues surrounding the intersection of context with the other curriculum commonplaces. From a process perspective, their work is an interesting example of online international collaborative projects and their intercultural significance. Another example of those involved with WAOE is the chapter by Bowskill and colleagues who, like Hibbert and Rich in the previous section, specifically frame their work in terms of communities of practice. Two themes permeate their work: online informal learning as an approach to professional development, and the concept of transfer into self as a process for empowering participants. They believe that such a community of practice can

function in a distributed environment to support learning about learning, and learning about learning online. Their approach to the process of transfer into self relates directly to transfer into practice in a context supporting diversity of culture in a global environment.

A very different milieu for online professional development is described by Natriello and Rennick. They discuss the case study of the recent conversion of a major established education journal of over one hundred years, **Teachers College Record**, from print to online format. The creation of online journals is but one important aspect of the impact of the digital age on the field of publishing. This impact is felt in the various processes of solicitation of manuscripts, to their development and production, as well as marketing and distribution. In addition to the creation of e-books and electronic versions of reference works, publishers now produce hundreds of online journals and sell bundles of them to tailor the needs of specific libraries in the academy and other institutional settings. This case study details the process of original resistance from the editorial board to their subsequent conversion to the exciting learning possibilities provided by the online format. This format provides an interactive professional development environment for teachers and other educators that has led to increased readership and with more flexibility in how the journal is organized and what supplementary “curriculum materials” readers can access.

The last contribution about professional development expands our horizons about the broader applications of its role in knowledge management through virtual spaces. Norika Hara and the late Rob Kling discuss the various discourses about professional development and knowledge management through applications of IT. They provide case study data from four different contexts and determine that knowledge management through solely technical means is too narrow to support the view of learning we’re using in this Handbook, the creation of new knowledge. This contribution reinforces one of the themes that emerges from many of the chapters: to be effective, virtual learning must seriously include the milieu of the social system.

### **Section Three: Out-of-School Learning Environments**

Section Three of The Handbook, **Out-of-School Learning Environments**, moves to a consideration of other environments for virtual learning. This addresses the broader representation of the curriculum of life, diverse settings which often define our relationships with institutions and others, as well as our sense of ourselves. Because virtual life has infused so much of society we don’t presume to cover all possible settings. However, we have included a number of life’s areas in order to provide some of its diversity. The first contribution represents interesting observations about initiation to the virtual world by novices, seniors who represent a population usually considered

uncomfortable in the networked society. We then discuss how some of the important traditional societal institutions (libraries, museums, and healthcare) adapt to the digital age. One of the hallmarks of contemporary society is how much of our lives are spent in leisure activities. The impact on some aspects of leisure time is discussed for hobby genealogy, gaming, and the virtual leisure industries related to sports and sex. The intertwining of political and social aspects of our lives has been impacted by the virtual world. We have included chapters that touch on issues in e-democracy, virtual memorialization, diaspora in virtual spaces, and how virtual environments may be implicated in producing racial identity. Another area that touches upon both virtual learning and learning virtually is the realm of popular culture. Several chapters analyze the political economies associated with two of our cherished icons, Disney and Anne of Green Gables. Additionally, we've included chapters that discuss the importance of virtual life in the development of the genre of slash fiction, an increasingly influential aspect of popular culture.

In "Cemeteries, oak trees, and black and white cows: Newcomers' understandings of the networked world", O'Day and colleagues address important issues about novice learners to the wired world. They chose to study seniors' introduction to the internet, since they are a group most likely to be unsophisticated about modern technologies and the associated complex social practices. This interactive study of the questions generated by the learners about their online experiences provided useful information about often assumed views about identity on the internet, the boundaries and scope of both personal computers and the internet, and about how the networked world is organized.

The digital age has had important effects upon a number of societal institutions that have served as learning contexts. Brophy discusses the development of e-libraries, the response of this field to utilize technology for facilitating learners' engagements with the global information universe. While libraries are usually known as places to learn content, whether it be reference material or reading for pleasure, they are also social contexts where people socialize and engage with techniques for finding materials. Computer classes are popular with those who may not otherwise have wired accessibility, such as seniors and students, and thus have become places for reducing the digital divide. In spite of the importance of technology, librarians act as facilitators for a wide range of learning styles within a range of pedagogical frameworks. Brophy sees future libraries as making incremental changes, with the e-library coexisting along with more traditional features.

Sumption presents interesting observations about the impact of the digital age on the traditional, artefactually-oriented learning environment of museums. He presents some interesting historical developments about learning in the museum setting and the possibilities of developing interactive, multimedia, computer-based learning environments. The challenges are formidable for an institution where learners have been immersed one on one with objects in the 'sacred grove', and which relies upon in-real-life attendance figures for

justifying their existence. Sumption provides useful illustrative information from his own museum in Australia as to how the World Wide Web can be instrumental in helping learners move beyond collections, and at the same time, alleviate some of the political economic pressures on the institution.

There is probably no aspect of the “curriculum of life” that has been more influenced by modern technology than that of healthcare. It is an environment which includes important sites where learners may work together to support the use of a variety of tools and information resources to pursue critical learning goals and problem-solving activities. Internet-mediated learning environments provide possibilities for overcoming traditional boundaries characterizing learning experiences regarding medical education and the profession itself. It provides opportunities to help educate patients and those seeking health-related content. Just as Black has suggested that computer technologies have provided the basis for topsy-turvy learning relationships between teachers and students in the formal school setting, so the internet enables those seeking medical information to engage with health professionals far more knowledgeably than ever before. In some cases, patients may have more information than the professionals because of their ability to search for information that otherwise might have been difficult to obtain. Of course, part of the problem may be that novices may have difficulty determining the validity of information available through the internet.

The digital age has certainly impacted upon how we spend our time away from work. The concept of leisure time has had an interesting history in its linkage to changes in the workplace setting, the development of the weekend (Rybczynski, 1991), the advent of new technologies, and medical advances lengthening life expectancies. With more supposed “free time” available, people have turned to a variety of activities to occupy their time. Computer technology has made accessible a number of opportunities for amusement and for learning new information and to develop new skills in political, social, economic and personal areas of people’s lives.

As people have more time available, they often turn to activities that relate to their family and other personal interests. One of the fascinating uses of the internet has been the increasing interest in amateur genealogy, the practice of studying family origins, in order to create family trees and pedigree charts. Veale presents a chapter in which she discusses the various ways in which the internet is an environment for learning genealogical methods. As part of her inquiry, she obtained fifteen million websites in response to her Google exploration of the topic. Her survey disclosed three emerging themes in the employment of the internet for genealogical purposes. The *scholarly* theme is represented by formal courses run by various groups—for example, the University of Toronto, in conjunction with National Institute of Genealogical Studies, offers the oldest web-based certificate program. The *topical* theme is represented by companies and individuals offering less scholarly, often more topical stand-alone web pages. This material may include libraries of articles

or webpages and tutorials for novices to the area. The *ad hoc* theme includes mailing lists, online forums, newsgroups, and presentations of personal situations and advice asking appear with little pre-planned structure. Veale believes that too much of the online curriculum in this area uses pre-internet traditional instructional methods and she suggests a variety of approaches that would more readily take advantage of the Internet's possibilities, especially to teach problem-solving.

De Castell and Jensen present observations about the importance of the learner's attention in any learning context, and focus on its relevance to the digital milieu. They discuss the significance of childrens' frames of perception in the conjunction of the entertainment and education settings by concentrating on the important area of gaming. They believe that the ability of video games to capture and hold attention has theoretical implications for the impact of newer technologies on structures and forms of knowledge. The tasks, puzzles and questions associated with games has both commercial and intellectual merits. The educational implications are to look to play to influence pleasure, choice and immersion, speed and efficiency of learning, meaningfulness of topics, subject matter and the learners' experiences.

Cook suggests that even though there has been an enormous impact of the digital world on leisure life, there hasn't been commensurate inquiry about virtual leisure industries. Although her chapter discusses issues in teaching about leisure industries at the university level (potentially suggesting placement in the previous section dealing with schooling) she incorporates an incredible array of information about their importance to self expression, popular culture and social life. Some of these areas involve sport participation and fan activity, organized travel and tourism, gambling, sex, shopping, fashion and design, food and hospitality, and computer games. She includes two in-depth examples of sport and online sex-pornography and the sex industries-from her online curriculum. In the process, she raises some interesting curricular value issues around contradictory themes of public acceptance/censorship (based on moral or legal criteria), public knowledge/ private information, production/consumption. An important observation is the suggestion that the internet (and the social order producing it) is a space for contestations, re-articulations and convergences.

Digital technology offers possibilities for creating intriguing learning settings for shaping political and social identities. Balnaves and his colleagues suggest that the decline in traditional civic participation can be countered by using participatory technologies in the form of interactive media as part of an e-democracy movement. They see media as a liminal space for encouraging both individual and collaborative learning and for mobilizing digital resources. For example, internet and interactive TV are being used for citizen polling, electronic town meetings and televoting for mass decision-making. These authors raise an interesting contradiction, one that suggests a disconnect between the explicit and hidden curricula around e-democracy. How can the

digital world reduce differences between representational government structures and the voter-citizen when the internet is controlled by political forces? The curriculum of these new learning environments is seen as a complex triangulation among medium, the learning environments in which people learn to use the medium, and the reality of how a medium is used. One result could be a more independent citizenship learner who participates in civil disobedience through hacktivism. This is in keeping with seeing it as a very positive activity, a very different view than one ordinarily associated with hacktivism, as enunciated in a later chapter by Levesque.

An activity practiced by all societies is memorialization, the process of formulating and reformulating images of valued cultural practices and icons. This generally conjures up images of statues and other time and space related memorial settings. One recent event that has shaken the world was the destruction of The World Trade Center in NYC, and there have been many attempts at trying to memorialize this horrific event. Shepard's chapter on the Sonic Memorial provides an opportunity to re-think conventions of memorial-making that are locked into concrete time/space/place considerations and to suggest the efficacy of creating three-dimensional virtual learning environments for nuanced, meditative, non-linear learning moments. He describes the process of developing a site which used incredibly diverse material contributed by individuals from around the world to create sound artifacts, where this sense becomes the learner's compass. The site has three purposes; to continue building an archive through online web interface; to create a catalogue (curriculum materials) for future use; and create a place of remembrance recreating before, during and after 9/11. This virtual learning site is the creation of a distinct space/place, it allows learners to drive the curriculum, offers multiple points of entry, engages the learner as a participant and fosters social collaboration.

Another potential social collaborative environment is the development of diasporic web communities as learning spaces. Over the centuries, individuals and whole groups of people have been forced or have voluntarily migrated to other locations, potentially creating difficulties in the new setting and at the same time with potential loss of features of the homeland. Virtual learning sites have been developed for individuals to learn and possibly re-learn what it means to be an immigrant, how to understand and interpret immigrant experience, and to imagine a relationship between homeland and host-land. Nincic's chapter questions the subject matter of what diaspora is, and suggests the investigation of discourses around cyberspace, diaspora-related themes and their particular configurations. She dispels the myth, a form of the hidden curriculum, of the homogeneity of the image of diaspora. In questioning the romantic notion of the memory of homeland, she posits the view of a complex community that is influenced by local economic, social and political conditions in both the homeland and the host-land.

Another identity issue is how VLE's provide a setting for the production of racial identity. Altman and Gajjala see this as part of the larger platform



of the online production of self, a curriculum of the interaction of the production of cultural experiences and the materiality of virtuality. They point out that meaning-making is made through doing, the acts of coding, programming, typing oneself into existence and building objects of self. Their research suggests that in order to understand this curriculum of meaning-making, researchers have to be engaged in production of culture and subjectivity. In particular, it is important to understand how features of the technological milieu of VLE's engage with IRL environments, and to focus on learners' cultural competencies and literacies.

What we choose to identify with is a function of exposure to various forms of popular culture. Our fantasy lives are products of cultural production and reproduction brought about through a combination of what we choose or not choose to engage with (null curriculum) and the curriculum (mostly hidden) of corporations and other entities engaged in the manufacture of popular cultural images. Perhaps the most well known icons are associated with the Disney world, a land that uses fantasy to create virtual learning environments without necessarily using digital technology. In his chapter, Trifonas reprises his review of Giroux's *The Mouse That Roared* (1999) and believes that corporations use media as a pedagogical device for engaging the public in real moments of miseducative teaching/learning of cultural reproduction. In his view, Disney represents possible worlds with ideology, which appeals to common sense while actually shaping political policies and programs that serve corporate interests. It is important to reclaim the space of public memory by determining how to read the text and to understand the significance of the signs of the 'squeaky clean image, false happiness and cartoonish social imagery'. Another cultural icon that has had world-wide appeal is the imagined community of Avonlea in Canada developed by Lucy Maud Montgomery who wrote about Anne of Green Gables in books and short stories. Lefebvre describes the Avonlea site as constructed from the real and imagined in Montgomery's life, controlled by heirs and trademarks, so that she has become a cultural ideological commodity separate from the individual. Like Disney, this icon has been constructed as fiction, representing a copy of an original that didn't exist. This chapter discusses the simulated online communities that have formed that represent a "regional idyll", a genre of that time which provided sentimental relief from increasing urbanization and industrialization. Internet users of these virtual sites engage in, and with, replicas that are free of context, history, nation, religion and culture. These virtual learning environments allow other peoples to populate this milieu, and in borrowing from the Disney construction, Lefebvre suggests that this helps to conflate Montgomery's world into 'a small world after all'.

If the Disney and Montgomery examples suggest popular culture virtual learning environments where learners are in milieus manipulated by external forces, fan fiction and slash fiction represent milieus created by and contributed to, learners themselves. Mazur discusses how the internet is a rich

environment for fan fiction, which is virtual unauthorized writing of stories with bootlegged characters and settings from a variety of media. For example, Fanfiction.net is a site containing hundreds of categories with thousands of stories mostly written by women for the love of: the story, the process of writing, particular characters, and community. It represents one big writing workshop allowing for interactive feedback, and is a contradictory learning environment born from plagiarism but with built-in detectors for standards of writing. This site suggests useful examples of how learners can engage with the various Curricula of the internet (Initiation, Governance, Access, Membership). Slash fiction represents a subset of fan fiction using same sex romantic pairings. Bury's chapter discusses the complex process of making meanings and pleasures within this virtual genre, best understood as 'queer romance'. There are parallels with virtual learning environments, since a learner's cultural and linguistic resources are literally on the line, there is engagement with canonical text and issues of legitimate interpretation, and there is the tension of keeping standards, especially for groups often seen as outsiders. The chapter devotes space mapping out the performance of gender, sexuality and class on an e-mailing list of fans of a Canadian TV series, *Due South*, where action takes place in Canada and the U.S. She suggests that pleasures of those engaged with this virtual site go beyond 'queer desire' but to issues of high standards of writing and adherence to the canon of the primary text. Slash fiction represents just one of many ways in which gender issues get played out in the virtual world (Turkle, 1995).

#### **Section Four: Challenges for Virtual Learning Environments**

The previous material represented contributions suggesting a range of discourses about virtual learning environments. The last part of the Handbook, **Section Four, Challenges for Virtual Learning Environments**, looks at a variety of issues generated by ways of engaging with the internet, innovative forms and technical advances, new roles and settings, and research about virtual learning environments. The expectation is that this will stimulate an expansion of perspectives and highlight challenges for the future. In orienting these challenges and issues, I take editorial license with Gadamer's view that "... all understanding is a fusion of horizons" (Gadamer, 1960, 302). Since he suggested that this fusion includes all that can be seen from a particular perspective, I choose to define horizon as that which fuses past, present and future. The preconceptions of the past are constantly helping to shape the present which together form predispositions to future understandings and actions. Although previous entries have touched upon material from the past, the present and even the future, this section of the Handbook deliberately contains chapters that bring in perspectives from all three considerations in taking up some of the challenges and possibilities for VLE's.

Fantasy provides the leitmotif for the beginning and penultimate contributions to this section. The contributions by Noon and Zizek represent two pieces that illustrate the importance of past images in the fusion of horizons. Noon's brief literary gem provocatively illustrates what many have considered to be the dark side of the world of virtual reality; an image that often influences feelings of mistrust in what technology may have wrought. The development of a thought recognition system coupled with a usable feedback loop created an imaginary about dreams that leads to the most extreme mis-educative experience, the destruction of mind. This science fiction image of virtual life has implications for how we view the roles of business and government in shaping future virtual learning settings. Zizek's contribution serves as the introduction to the final chapter.

Previous material in the Handbook discussed several features of the structure of the internet. However, these discussions are at a conceptual level suggesting an outline for a Curriculum of the internet. More concrete procedures are needed for users to realistically understand its politics and implications. Dodge and Kitchin describe a geographic guide for internet exploration and mapping. They see it as a set of techniques and tools for people to cope with several features of the internet, including dealing with worms and viruses and developments in search engine capabilities. They also point to potential difficulties that may lie ahead in the expansion of internet technologies. NET: GEOGRAPHY FAQ provides a useful set of virtual learning tools for interrogating the media that supports virtual learning itself.

Another example of providing curriculum material about the internet is found in Levesque's chapter on hacktivism. Discussion about hacking and hackers has been an important part of the story of the internet, and she clarifies the distinction between crackers, those who break in for destructive ends, and hackers who use their skills to invent, modify and refine systems. Often, hacker activity brings about unintended consequences from the original aims for a system. The origins of hacktivism derive from the blending of this work with those who believe that people should have free access to this virtual learning environment. Hacktivists believe that the internet is a site of contestation, and their efforts are an attempt to flush out the hidden curriculum as a reaction to perceived oppressive use of laws and technologies by private corporations and governments for monitor and control issues. Levesque provides useful content about issues and techniques associated with censorship and surveillance. One of the interesting contradictions is that some of this effort may be illegal, but seen to be supportive of broader principles of human rights.

There have been several recent innovative developments in ways that the internet is used for web publishing purposes. Central to this work is the development of weblogs and wikis, which allow for flexible opportunities for individuals and groups. These opportunities potentially enable much more control of the internet through personal expression and by making the technology openly available to all interested parties. Halavais discusses web-based logs,

or blogs, and wikis as important learning environments in student-centered education. He discusses his personal experiences in determining that students should not only learn about the technology but the social practices that are so much a part of these sites. Weblogs present challenges to educators because they should be used in a milieu emphasizing a constructionist view of learning where different discourses and perspectives interact with one another, in a spirit of co-learning. Halevais suggests that each of the curriculum commonplaces need to be addressed in re-formulating traditional views of educational environments. A very different milieu for blog application is how digital media are helping to re-shape both text and professional life in the academic world. Barr discusses how weblogs have potential for changing procedures in academic publishing that have relied upon gatekeeper, blind peer-reviewed publications as the currency for evaluating performance. He suggests that the procedural organization of blogs may more readily accomplish the goal of evaluating a researcher's professional success. This potential change in the milieu of the academy has vast implications for the curriculum associated with becoming an academic researcher.

Another fully editable website is the wiki, previously discussed in the description of Wikipedia. Augar and her colleagues present a description of wikis, how they work, how their features make them highly suitable as virtual learning environments, and present examples of practical application and research situations. What makes them desirable as useful collaborative sites is their flexibility for different purposes: they can support a simple edit style that uses an editing toolbar, or for more sophisticated purposes, knowledge of wiki syntax. For teaching and learning online, more complex features such as authentication and tracking are necessary for tracing edits back to an author that allows for an assessment process, and also securing content against possible misuse. Wiki sites offer useful information for novices in the Curricula of Initiation and Membership.

Peer-to-peer networking represents an important use for virtual learning environments. Logie presents a fascinating account of the Napster music story weaving past, present and future themes about a site that became in 1999 the most popular file-transfer service on the internet at the time and many users' initiation into virtual learning environments. The story demonstrates the importance of larger social, political and economic influences on the Curriculum of the Net. A history of legal and political events moved this concept from free to pay-for-play, peer-to-peer networking, and the story became a two-dimensional characterization of a battle between 'pirates' and "property-holders". It has led to a free site, Kazaa Media Desktop, which has become one of the most downloaded software in internet history. Additionally, it has led to the "napsterization" of other cultural artifacts (film, video, photographic files). Logie believes that 'partying like it's still 1999', that is, downloading without compunction, can't be sustained and that the academy has to provide useful procedures and examples of virtual learning environments.

An important activity in any knowledge-oriented endeavor is the ability to incorporate inquiry into its landscape. With all the activities associated with developments in virtual learning environments it is appropriate that research should assume an important role in looking at challenges and future considerations. Several chapters have been included to represent some recent research work that provides a sense of the diversity in the application of technologies to collaborative learning settings. Sosnoski and colleagues present a fascinating description of the development of “Virtual Harlem”, a collaborative learning environment that models the subject of life in the Harlem, NY of the 1920’s and 1930’s. It represents an achievement of a variety of scholars in the sciences and arts that has salience for both teaching and research purposes. Its importance lies in the development of a networked environment whose ongoing research utilizes video, audio and database technologies to provide collaborative learning environments for design, interactive art and data visualization. It’s an excellent example of a curriculum in action, one that brings together an integration of the curriculum commonplaces. Pea’s work specifically concentrates on the development of a digital video collaboration for research communities. He describes some of the theoretical and technological considerations in creating the Diver Project, a unique software system for capturing, annotating and sharing perspectives (which he labels as dives) on activities video-recorded IRL. In the world of virtual learning environments, this represents a movement away from a broadcast-centric and asymmetric use of video and has important implications for elaborating knowledge building in the life sciences from application of video sources and for practical consumer video communication applications. Both possibilities address a constructivist vision of future learners moving from the role of consumer to one of active participation.

A different example of the integration of technology with social activity is the development of ePresence Interactive Media System, a virtual learning environment created through application of webcasting. Zijdemans and her colleagues describe an early example of its use in supporting live interactions of experts and others in an early childhood education forum. ePresence demonstrates how knowledge media differs from traditional media in the ability to make major modifications in the medium through reasonably non-complicated software changes. Several changes in the technology have made its use as a VLE much more user and research friendly. Among these characteristics is ability for attendees at an event to participate with remote viewers, using Voice Over Internet Protocol (VOIP) that allows for voice contributions from remote viewers, sophisticated archive searching after the event, and linking online course settings with the live events and archives, an invaluable teaching-learning tool.

Previous mention was made of the concept of the “invisible college”, a limited community of scholars, and how the digital age has been transforming the communication patterns of academia. Wellman and his colleagues provide

useful information about previous research of networked scholarship in academic communities. They discuss how the application of social network analysis procedures to computer-supported networks: determine how different kinds of relationships interrelate, detect structural patterns, and analyze the implications of these structural patterns for behaviors of network members. They include a research analysis of TechNet, a scholarly network that has developed into a community of practice for academics from the humanities, sciences and social sciences. An important future implication of this work is that curriculum designers of online educational communities and other forms of virtual learning environments should consider the social networks of community members, and how various media usage and network structures impact upon mutual peer-to-peer learning.

Bruckman offers a very different example of research into the behaviors of users in online communities. What is special about her work is that she collected physical data on the actual activities that users engaged in while online. The virtual learning environment she studied, MOOSE Crossing, a text-based MUD, offered the opportunity to collect log file data, a comprehensive record of all commands typed by users. This raises the question of the kinds of data and methods of data collection that are most compatible with trying to inquire into the digital world. Much of the previous research has been similar to that conducted using procedures from real-life settings, such as the use of face-to face interviews. Are there features of the digital world which require different types of data and data collection procedures in order to learn as much about life “in the screen” as life “on the screen”? Bruckman’s research offers data procedures collected on the interaction between the user and the computer screen. She blends both quantitative and qualitative techniques, uses both manual and automated methods of analysis, and recognizes the importance of ethical considerations in recording and analyzing log file data. Issues of potential invasion of privacy and rights of human subjects research is an important curriculum area that needs to be more fully developed for researchers investigating virtual learning environments.

The issue of the digital divide, disparities in who has access to the virtual world, is a refrain that cuts across past, present and future moments. Each of the next three chapters presents diverse approaches to discussing and inquiring into aspects of this divide. Very different classes of learners are discussed: women, those from developing countries, and ordinary citizens in a democracy. Dwight, Boler and Sears contribute an imaginative piece looking at the visual images that shape our interpretations leading to myths about the ways in which women are perceived to be disadvantaged in the digital world. They inquire into the ways that the popular discourses generated by advertising and Hollywood shape the public imaginary of cultural stereotypes around gender and power in education and technology. Rather than accepting these ‘taken-for-granted’ stereotypes, their work demonstrates alternative possibilities for how women inhabit and re-define cyberspace through

the development of creative spaces. This has very important implications for the curriculum about virtual learning for educators, and how representations of alternative imaginaries should be infused into the curriculum of their students.

Dicum offers an important discussion of the expectations for the developed world's digital technology as an ingredient in ameliorating the digital divide represented in less and least developed areas of the world. Using information from several examples of the use of such technology in community development projects in these areas, she reports that not enough attention has been paid to local ecological issues. The centralizing tendency of globalization efforts in the use of the internet needs to consider discourses about the important theories, principles and knowledge gleaned from the "development" field. If the internet and other technologies are to have a positive influence on these areas, respect must be given to the needs, resources and other factors that help to define a local community's reality. This requires that assumptions from the developed world be questioned, and that consideration be given to complex curriculum interactions of learner, milieu, type of pedagogy and the nature of the required content in less and least developed communities.

A different issue about the digital divide is discussed in Allen's chapter. It concerns the potential impact of the development of broadband technology on Australian citizens. The issue is how the audience for this technology is being shaped, often well before the technology is either developed or available. This addresses the possible creation of a digital divide between those who may, and those who may not, have access to this technology. Allen looks beneath the proposed claims for a broadband future that allows for distributed, audiovisually enhanced rich virtual learning environments and demonstrates the importance of understanding the setting for such developments. He illustrates the influence of political, economic and social forces to create an "imaginary" about a technology and its perceived future usefulness. This raises important questions about how forces in a setting may help to shape images of the learner.

Zizek's "The Matrix, or, the two sides of perversion" is deliberately placed as the penultimate contribution to this section, and indeed, *The Handbook*. His exploration of the real and the virtual juxtaposes the complexities of the mind/body relationship. This provides a dramatic introduction to the final contribution, Mann's description of the reality of the individual as cyborg. He describes his experiences of constructing himself as a computer-based learning environment over a thirty-year period as an inventor, builder and user of several wearable computing and personal technological systems. The importance of this life's work is in a conception of "being" at one with technology, developing an epistemology of choice, "existemology", and constructing an in-real-life curriculum for students to transform themselves into virtual learning environments. In addition to the imagery offered by Zizek, readers may also interpret this extreme view of virtual learning environments through the prisms offered by other authors in this *Handbook*. We have come full circle in

The Handbook: from Burbules who questions the concept of virtual learning to Mann who has become a VLE.

It also makes one wonder about how much we have traveled since the Allegory of the Cave:

Will he not fancy that the shadows which he formerly saw are truer than the objects which are now shown to him? (Plato, 1963, 547)

#### SOME FINAL THOUGHTS BEFORE BEGINNING

This volume represents a kaleidoscope of ideas, topics, points of view- brought together as one way of providing coherence to the evolving concept of virtual learning environments. My brief introduction is but a mere sketch compared with the richness of the words and worlds of the authors, both individually and collectively that the reader will engage with in the following chapters. Although many perspectives are included, The Handbook has been created through a particular prism of interpretation, one that emanates from educational and curriculum discourses. However, any prism offers a narrow range, one subject to the concept of the null curriculum. By including this set of material, we obviously have excluded other worthy possibilities for expanding our elucidation of this area. Our expectation is that the current project will stimulate others to contribute their voices in that quest.

To that end, I will offer a few suggestions that emanate from a consideration of both the actual, and the null curricula, of The Handbook. First, if there is merit in using a learning and curriculum prism, perhaps others will re-work it to include ideas and perspectives not necessarily included in my current vision. Other prisms could be used to explore other facets of the kaleidoscope of virtual learning environments. This may require a transdisciplinary approach, one that honors eclecticism in bringing together viewpoints regarding knowledge, media, design from the arts, humanities, social sciences and sciences. (A good example already exists in pioneering work by Turkle (1984, 1995) on looking at issues of the self and identity in the computer age.) There should be recognition that issues of learning require dialogue involving the theoretical and practical arts.

A second consideration is that the examples and references to technology included in this project are but a tip of the iceberg of past and present developments, let alone a future imaginary of what may be possible. Developments in the wired and wireless worlds, and the ways that different technologies can and may be integrated only hint at the possibilities for learning environments. Thus, some of this present and future technology should be creatively developed within the concept of the VLE. However, if there is one theme that emerges as a constant refrain from our authors, and represents a third, and crucial, suggestion, is that the technical is inextricably integrated with



the social milieu. Since technology doesn't operate in a vacuum, the social context in all its complexity is an essential ingredient in any technological considerations in the virtual learning environment equation.

As a fourth consideration, the curriculum commonplaces suggest that this VLE equation represents a set of complex interactions among images of the learner, content, teaching strategy, and the milieu. The importance of the learner and its' interactions with the others should be highlighted in future work, and might include a more detailed delineation from a constructivist perspective of the many roles possible for learners (student, teacher, developer, researcher, citizen) in all facets of virtual learning. This is especially so if the digital age is to bring about a sense of agency in dealing with issues arising from hidden curricula. Finding innovative ways for learners to participate in the various curricula of virtual learning environments might be a useful strategy for bridging the many digital divides.

A fifth suggestion is the exploration of the implications of the conceptual distinction between virtual learning and learning virtually for an understanding of the roles of fantasy, imagination and creativity in developing learning environments. What can we learn from the best practices of learning virtually that provides examples for how the digital environment should go beyond the fairly traditional, indeed pedestrian, applications that just mimic rote learning models? Equally as well, can exemplary forms of newer technology enhance the more successful visions of learning virtually?

Progress in any field is enriched and transformed by the appropriate application of procedures of inquiry. A sixth consideration is how research in, and about, virtual learning environments can be transformative. How can research guide the determination of appropriate questions to formulate, especially for the different locations of IRL, digital and virtual? Does the virtual world require methods of inquiry different from in-real-life situations? Although there is excellent material available about research in this setting (for example, Jones, 1998) most of the studies have been conducted IRL, typically using face-to-face procedures. How can we develop and use procedures for looking at the digital location of computer-mediated interactions between the user and the computer screen? Even more ambitious would be the development and use of procedures for VLE's in virtual locations, such as MOO's and Massive Role-Playing Games (MRPG), where life is constructed in the screen itself. In addition to the important issues about techniques and their applications, attention must be paid to the daunting ethical challenges that arise in creating and studying VLE's in both digital and virtual locations.

A final suggestion (but by no means exhaustive of many more possible) relates to the larger milieu of how our many worlds will continue to change as a result of the virtual environment. What previously had been relatively impermeable, socially constructed boundaries in our lives (work, home, school, play) has radically been altered in many cultures so that the screens surrounding role, space, place and activity have become quite porous. This has important

implications for how the various, previously segmented learning environments which we inhabit have shifted to a more holistic, larger unit of ‘the curriculum of life’. This potentially alters how we conceive of, construct and re-construct learning environments for personal, family, institutional, local community, national and global levels. What possibilities hold for developing VLE’s for crafting public and personal imaginaries for all facets of life, that are just and fair, and enable learners to create diverse forms of knowledge through the transformation of their experiences?

...transcendence, the conscious experience of hierarchic integration where what was before our whole world is transformed into but one of a multidimensional array of worlds to experience. (Kolb, 1984, 222)

#### REFERENCES

- Apple, M. (1980). The other side of the hidden curriculum: Correspondence theories and the labor process. *Journal of Education*, 162, 47–66.
- Brumfield, R. (2005). Imagine: A day without technology. *eSchool News Online*. Retrieved 4/25/05 from the World Wide Web: <http://eschoolnews.com/news/showStoryts.cfm?ArticleID=5622&page=1>
- Bruner, J. (1986). *Actual Minds, Possible Worlds*. Cambridge, Mass.: Harvard University Press.
- Davis, S. & Botkin, J. (1994). *The Monster Under the Bed: How Business is Mastering the Opportunity of Knowledge for Profit*. New York: Simon & Schuster.
- Eisner, E. (1985). *The Educational Imagination*. (2d ed.). New York: MacMillan.
- Flinders, D, Noddings, N. & Thornton, S. (1986) The null curriculum: Its theoretical basis and practical implications. *Curriculum Inquiry*, 16:1, 33–42.
- Franklin, U. (1990). *The Real World of Technology*. Toronto: CBC Enterprises.
- Frye, N. (1969). *The Educated Imagination*. Bloomington: Indiana University Press.
- Giroux, H. (1999). *The Mouse That Roared: Disney and the End of Innocence*. Lanham, MD: Rowman and Littlefield, 1999.
- Jackson, P. (1992). Conceptual and methodological perspectives. In: Jackson, P. (Ed). *Handbook of Research on Curriculum*. New York: Macmillan. 3–40.
- Kolb, D. (1984). *Experiential Learning*. Englewood Cliffs, N.J.: Prentice-Hall.
- Nolan, J., & Weiss, J. (2002). Learning cyberspace: An educational view of virtual community. In Renninger, K. & Shumar, W. (Eds.) *Building Virtual Communities: Learning and Change in Cyberspace*. Cambridge: Cambridge University Press. 293–320.
- Plato. (1963). The Republic VII. (B. Jewett, Trans.). In S. Buchanan (Ed). *The Portable Plato*. New York: Viking.
- Price, D. (1961). *Science Since Babylon*. New Haven: Yale University Press.
- Rybczynski, W. (1991). *Waiting for the Weekend*. New York: Viking Penguin.
- Schon, D. (1979). Generative metaphor: A perspective on problem-setting in social policy. In Ortony, A. (Ed), *Metaphor In Thought*. Cambridge: Cambridge University Press, 254–283.
- Turkle, S. (1984). *The Second Self: Computers and the Human Spirit*. New York: Simon & Schuster.
- \_\_\_\_\_ (1995). *Life on the Screen: Identity in the Age of the Internet*. New York: Simon & Schuster.
- Vallance, E. (1977). The landscape of the “Great Plains Experience. An application of curriculum criticism.” *Curriculum Inquiry*, 7:2, 87–105.

- Weiss, J. (1989). Evaluation as subversive educational activity. In Milburn, G., Goodson, I. & Clark, R. (Eds.). *Re-interpreting Curriculum Research: Images and Arguments*. Philadelphia: Falmer Press, 121–131.
- Weiss, J. & Nolan, J. (2001). Internet literate: the hidden and null curricula of the Internet. Paper presented at Teaching as if the World Matters, 2nd Annual Conference (<http://www.utoronto.ca/baitworm/>), University of Toronto, May 11–15.

# **Part I**

## **Foundations of Virtual Learning Environments**

# Chapter 1: Rethinking the Virtual

NICHOLAS C. BURBULES

*Department of Education Policy Studies, University of Illinois, Urbana/Champaign*

## 1. THE VIRTUAL

The term “virtual reality” (VR) was reputedly first coined by Jaron Lanier, head of Virtual Programming Language, Inc.<sup>1</sup> It is usually taken to refer to a computer-mediated simulation that is three-dimensional, multisensory, and interactive, so that the user’s experience is “as if” inhabiting and acting within an external environment. A few typical definitions emphasize these main elements:

The illusion of participation in a synthetic environment . . . VR relies on three-dimensional, stereoscopic, head-tracked display, hand-body tracking, and binaural sound.<sup>2</sup>

A combination of computer and interface devices (goggles, gloves, etc.) that present a user with the illusion of being in a three-dimensional world of computer-generated objects.<sup>3</sup>

VR is minimally defined as a computer-generated experience consisting of stereoscopic, real-time, viewer-centered computer graphics. A VR experience may be further and significantly enriched by the inclusion of spatially located sound, haptics, and smell.<sup>4</sup>

A computer system used to create an artificial world in which the user has the impression of being in that world and with the ability to navigate through the world and manipulate objects in the world.<sup>5</sup>

A VR is a computer world that tricks the senses or mind.<sup>6</sup>

There are two main characteristics revealed by these definitions, which, I will argue, inhibit a deeper understanding of “virtuality” or “the virtual” (terms I will prefer here to “VR”). The first assumption is to put the matter of technology at the forefront: VR is computer generated; it involves the use of goggles, gloves, or head-tracking devices, etc. *Yet the key feature of the virtual is not the particular technology that produces the sense of immersion, but the sense of immersion itself (whatever might bring it about), which gives the virtual its phenomenological quality of an “as if” experience*<sup>7</sup>. When we think of the virtual in this way, we see that all sorts of things can create this sense of “as if”: watching a film, reading a book, listening to music, or just being caught up in a reverie or conversation, for example; all of these can trigger engrossing experiences of multisensory worlds which, when we are immersed in them, fill our experiential horizons. There is nothing necessarily

computer-based about such immersive experiences: some writers characterize science fiction literature as a VR; others, shopping malls.<sup>8</sup>

The second assumption of most of these definitions is to characterize VR as a substitute for reality, as an “illusion” or a “trick”. Terms often used in place of “VR” include “simulated reality” or “artificial reality”. The problem with this view is that it assumes an overly sharp separation between the “virtual” and the “real”—the real seems to be a simple, unproblematic given that we perceive and interact with directly while the virtual means something more like “synthetic” or “illusory”.<sup>9</sup> Yet any reality we inhabit is to some extent actively filtered, interpreted, constructed, or *made*; it is not merely an unproblematic given while the virtual is not merely imaginary. *The virtual should not be understood as a simulated reality exposed to us, which we passively observe, but a context where our own active response and involvement are part of what gives the experience its veracity and meaningfulness.* Hence, the virtual is better seen as a *medial* concept, neither real nor imaginary, or better, both real and imaginary. In this sense “VR” is a misnomer.

For many critics of technology, this contrasting of the “synthetic” world with a more immediately sensible “real” or “authentic” world begins with arguments derived from Martin Heidegger’s “The Question Concerning Technology”.<sup>10</sup> Heidegger contrasts two ways of interacting with the natural world. From the technological standpoint, nature is revealed as a “standing reserve” (*Bestand*) a potential resource for humans to control, reshape, and exploit for their purposes. In this context, “technology” is not a thing, but an attitude toward and relation to the world. We regard natural things in terms of what we can do with them: a river is a potential source of electrical power; a tree is a potential table; a canyon a potential tourist attraction. This attitude and relation, this “enframing” (*Gestell*), in Heidegger’s phenomenology, already transforms the world, even prior to any actions: the tree is changed into a thing-that-can-be-used and is never again simply a tree, a thing-in-itself. A canyon that you have to pay to go see is in an important sense no longer the same canyon that it was before. On this highly influential view, “technology” is something intrinsically damaging, even insidious, because it robs us of the capacity to apprehend and appreciate the world simply as it is. This inverts the understanding of technology as something useful and beneficial—even if it may have dangerous side effects (pollution, say)—to something inevitably destructive. On this view, it is an all-consuming, all-inclusive mindset that attempts to draw everything into its utilitarian frame of reference. Heidegger’s anti-technological views, although not referring to computers at all, have been widely cited in the work of those suspicious of the rise of digital culture.<sup>11</sup>

Heidegger contrasts with the technological attitude a more direct, immediate, and in some ways almost mystical engagement with the natural world, in which its being becomes apparent to us on its own terms, not on ours. The world that presents itself *to* us, not as a potential object *for* us, is the authentic,

natural reality that grounds all being. Here again, we see an influential idea that has shaped environmental movements and other back-to-nature trends—and at a broad level, the dichotomy Heidegger is drawing makes some sense: we know that there are real-estate developers who look over a wooded valley and see it only as a potential site for a new sub-division; or engineers who boat down rivers looking only for a good place to build a dam. We have seen the decimation that occurs when society begins consuming non-renewable natural resources, when humans regard the world as a domain somehow given to them for their exclusive use, as opposed to an ecological system of which humans, like all natural beings, are a part, and to which we must be ultimately responsible.

At the same time, it must be said, this dichotomy is overdrawn. Heidegger's view of technology is too encompassing, too deterministic, and his view of nature too romantic. The origin of human culture is itself grounded in the first tools, the first attempts to harvest and later to grow food, the first attempts to build shelter. If this is inherently an assault on nature, then there never was a pure, authentic engagement with it—nor ever could be (because on this view, the “technological” attitude is just as much expressed in “renewable” resource use, low-energy-consuming lifestyles, the adoption of “natural” foods and fibers, etc.). On the other side, whenever Heidegger does try to explain what a non-technological engagement with nature would look like, his language becomes allusive and quasi-mystical. Nearly all of us have a sense of those moments when a sunset, a surging river, a breathtaking vista, overwhelm us with their purity and power, but presumably even real-estate developers and engineers can experience these too (and then get back to work planning their next ground-breaking).

In the context of computers and digital culture, this bifurcation of the synthetic and the real has obscured a deeper understanding of what is changing in the ways that we make and explore our worlds, mediated by and through new technologies. Very rarely, if ever, is there a “direct perception” of anything; we actively observe, select, filter, and interpret our experiences in all sorts of ways that construct distinct and sometimes idiosyncratic versions of the world. Some of these mediations are overtly technological in nature: eyeglasses, cameras, telescopes—or, more subtly, concepts, categories, theories, and assumptions. The world we perceive is always already a world we “make” to some extent.<sup>12</sup> This understanding, then, complicates the picture expressed in quotes like, “the more completely ‘virtual’, the more completely ‘made’ our lives become, the more obsessively we search to rediscover something simply given, something authentic”.<sup>13</sup> There is something to this view, of course; but matters are not so simple. As I noted, the virtual is a *medial* concept, between the patently made and the apparently real.

I do not think I need to review here all the recent theoretical work that challenges the easy distinction between representation and reality.<sup>14</sup> The boundaries of our “real” selves, “real” lives, “real” experiences are already fluid

and contingent. An excellent discussion of some of these issues in the context of new technologies is Sherry Turkle's book, *Life on the Screen*, published in 1995.<sup>15</sup> For many of the people she interviewed, the internet is a place they inhabit, not simply a tool they use; some users spend so much of their day working, playing, interacting, exploring, and creating online that this becomes their primary mode of existence—what we call “ordinary life” or “real life” is not what is most important or “real” to them. Plugged in, logged on, immersed in what they are doing for hours at a stretch, for these folks it is no exaggeration to say that they *live* in a virtual world. What is most striking in reading these accounts is how these people report their *preference* for the online world; they say it is more “real” to them, more important to them, and where they feel their authentic selves get expressed. One important dimension of this change is how people inhabit the virtual space; often by constructing online identities (“avatars”) that are different—sometimes dramatically different—from their ordinary selves (a man representing himself as a woman; a shy woman representing herself as sexually aggressive; a black person “passing” as white, or vice versa; a soft-spoken dweeb posing as a heavily muscled superhero). These are not in any simple sense “substitutes” for their “real” selves—performances, fantasies, or role playing—because these people often say that they *prefer* their online selves, and even say that these avatars are *more truly* who they are, or feel themselves to be, than their apparent identities. As Turkle notes, this trend is part and parcel of broader social and cultural trends that highlight the constructed and non-essentialist nature of personal identity.<sup>16</sup> Either one can discount these people's views as deluded or pathological, or one must acknowledge that something new and different is happening for them. I will return to this theme later.

In this chapter, I build theoretically off this conception of the virtual, through a series of steps. First, I explore four processes of engagement through which immersion happens (interest, involvement, imagination, and interaction); these will prove especially important for understanding the educational potential of virtuality. Second, I apply this conception of the virtual to a discussion of virtual space and time, suggesting that as virtual spaces become familiar and significant, they become virtual *places*. Two ways in which this transformation can take place are *architecture* and *mapping*, and I suggest that in educational contexts these processes broadly relate to the perspectives of teacher and learner, respectively. Architecture and mapping represent the structures or design elements in which the four aspects of immersion are guided toward learning goals; when these structures are successful, the process of immersion involves students strongly in the activities of learning. In this sense, then, it is not an exaggeration to suggest that all successful learning environments are, to some extent, “virtual”. One way to think of this project is as an attempt to rethink virtuality outside of an exclusively technological domain, and to see it as a central *educational* concept.



## 2. FOUR ASPECTS OF IMMERSION

It needs to be explained *how* the virtual sustains the sense of “as if”—what some call telepresence, and what I am calling here immersion.<sup>17</sup> I gave several examples previously of experiences that can sustain a sense of immersion—and which are to this extent *virtual experiences*: watching a film, reading a book, listening to music, or being caught up in a reverie or a conversation. What gives such virtual experiences this quality of immersion? I define four inter-related factors at work here: interest, involvement, imagination, and interaction.<sup>18</sup>

An experience is *interesting* to us when it is complex enough to allow us to pick out new elements, even with repeated encounters. We can shift focus and notice things we had not noticed before. An interesting experience presents a kind of puzzle that is challenging enough to engage us in actively trying to work out what is going on. Even rereading a book or hearing a piece of music that is very familiar can have the capacity to interest us anew if there is enough to it that we can pick out something that we had not noticed before, allowing us to appreciate it or understand it in a new way. Interest is one of the qualities that can sustain the sort of engrossment that makes us immersed in a virtual experience. But, of course, interest is not an intrinsic quality of experiences; what is interesting to me may not be interesting to you. Something that lacks interest cannot sustain a truly immersive experience.

An experience is *involving* when we have a reason to care about what we are experiencing: we pay attention to it because it concerns us in some way. Perhaps there is a narrative structure involved, or a goal or aim that *matters* to us, even if the goal or aim is not intrinsically valuable (games can be like this, for example, as we lose ourselves in the playing of them). In some cases, there may be an esthetic component to involvement, because we enjoy the experience and this is what makes us care—at other times, the experience may not be particularly enjoyable, but it involves us because it is important for other reasons (hearing a sad story recounted by a friend, for example).

An experience engages our *imagination* when we can interpolate or extrapolate new details and add to the experience through our own contributions. We may be interpreting what is going on, making guesses about things that are not immediately present to us (visualizing the face of a character in a novel, wondering what her inner thoughts might be; conjuring a mental image to go along with a piece of music we are hearing; thinking about what the unseen interior of a house we see in a painting might look like); or we may be anticipating what will happen next in some sequence or development. Actively going beyond the given is part of what engages us deeply in it.

An experience is *interactive* when it provides us with opportunities to participate in it, not only perceptually or intellectually, but also through embodied action and responses. Many theorists put interactivity at the forefront of what makes “VR” so vivid and plausible, where we are able to act

upon an environment, see the effects of our actions, and react to them. This deeper engagement of our body's movement, activity, and sensations triggers unconscious responses that make us *feel* "this is really happening", below the level of conscious analysis (for example, how the perceptual field of a technological "VR" environment moves as you move your head wearing goggles or a helmet). But, again, it is a mistake to think of this as a factor only in such technological "VR" environments. When watching a film or hearing a story, our posture, body tension, and startle responses—or, to take another example, our relaxation, rhythmic movement, and kinesthetic sensations listening to music—are a key dimension of the quality of immersion that makes the virtual seem or feel "real" to us at the moment it is happening.

These four qualities, as described here, are not meant to be exhaustive of all the factors that constitute the virtual; and they are not entirely discrete from each other—one could consider imagination in the sense defined here as a kind of interactivity; interest and involvement clearly can have a lot to do with one another. But I think they are helpful in clarifying the processes through which immersion happens, and they help us understand why immersion can be such a powerful mode of response. They push our understanding of the virtual beyond simply thinking of it in terms of vividness or verisimilitude ("it seems so real!"); and they decouple what makes the virtual, virtual, from the issue of technology and the specific media through which engagement happens. All of these qualities (interest, involvement, imagination, and interactivity) could be true, for example, of an intense conversation with a friend recounting a traumatic event, say, an accident or an assault: for long stretches, the conversation could sustain an immersive, virtual experience, in which we are not only listening, but actively engaged with what they are telling us; all four of the factors described here could be involved as we identify with the event and even, in some sense, virtually re-experience it with them—we may even *feel* as if it were happening to us (we may feel a sympathetic ache, for example). These four factors are outgrowths of the *relation* between observer and observed: qualities of response to an experience (in this they might be characterized in John Dewey's terms as *transactional* elements).<sup>19</sup> While grounded in characteristics and qualities of the virtual environment, this analysis makes clear that immersion is a consequence of our active response and engagement with them—it is not something that happens "to" us.

This analysis also makes it possible to see some of the ways in which virtuality can be abused: as a method of deception or manipulation, for instance. I have already described people who state that they *prefer* their virtual experiences and identities, consider them "more real", as far as they are concerned. For some of these people, it may truly be a concern that they become addicted to virtual experiences or can no longer differentiate the virtual from other modes of experience. Countless science fiction stories and films (most recently, and perhaps most famously, *The Matrix*) have been premised on the idea that a person may permanently inhabit the virtual and lose awareness

of the context that gives the virtual experience its boundaries. Here, the illusion/reality dichotomy seems to re-emerge, but in my view, it is more accurate to say that these are different kinds of realities, made worlds, some of which are more susceptible to questioning about how and why they are made the way that they are (a vivid memory that may or may not recall an event which really happened; an historical text versus a “truthful” fiction; and so on). It is the lack of an ability to ask such questions, to regard the context of any experience as potentially problematic, that is a concern here. The whole point of “immersion” is that for periods of time we forget that we are watching a film, wearing goggles, sitting in a symphony hall, etc. But if we *perpetually* forget this, abuses and dangers can arise.

On the other hand, turning this question around, I would argue that this analysis of immersion, and how it happens, has strong positive implications for the design of educational environments and experiences. Interest, involvement, imagination, and interactivity, as I have defined them here, are essential educational resources if we mean to engage and motivate active student learning: in this sense, any truly educational experience is immersive, or in other words, *virtual*. A virtual learning environment is not necessarily a technologically based one, I have stressed, and other modes of teaching can promote the quality of immersion. But I do mean to upset the assumption that face-to-face classroom interactions are necessarily more authentic, more meaningful, or more educationally productive than technologically mediated ones. For a digital generation, the qualities of interest, involvement, imagination, and interactivity are to some extent shaped by their engagements with technology and the media (computer games, videos, cell phones and handheld PDAs, etc.) and educators seeking to attract and retain student attention will have to learn from what makes those environments so immersive for youth. Yet neither am I arguing the superiority of the technological over the face-to-face. Each domain has its own unique qualities and advantages; for this reason, the question, to me, is not a matter of “Which is better?” or which should substitute for the other, but, “What is the distinct capability of each to support immersive learning experiences?” (For example, in my experience, based on several online courses, there often is more, and more varied, student interaction and participation in online discussions than in many regular classroom seminars—and for particular students a great deal more.) The virtual, as I am describing it here, is not a new fad or a gimmick, but a very concrete way of rethinking the nature of learning spaces—spaces where creativity, problem-solving, communication, collaboration, experimentation, and inquiry can happen.

### 3. VIRTUAL SPACE AND TIME<sup>20</sup>

People tend to think about the online environment as a *medium*; a path of point-to-point communication. People use the network like a telephone or

mail system to exchange messages or to retrieve and download documents, web pages, and other resources. To the extent that it is a medium or pathway, however, it is not *neutral*—it affects the form of information and the communication that occur within it. As many have noted, online text-based communication has features of both writing and speech; it is written, of course, but it is often spontaneous and unedited, like speech. Online communication is affected by whether it is synchronous or asynchronous and is shaped also by the degree of anonymity provided by not being in immediate, face-to-face contact with one another. It can make people more frank and honest, perhaps, but also less sensitive to the effects of what they say upon others. This degree of impersonality can also make participants oblivious to irony, sarcasm, or intended humor. In all of these ways, the online medium is not a neutral medium.

But it is also useful, and more directly relevant to my purposes here, to think of the online environment as a *space*, a place where people spend time, interact, and *do* things—for example, collaborating with others on a shared project. The fact that they inhabit a shared space is essential for this collaboration to work. I do not mean the medium/space distinction as a sharp or overly broad dichotomy; different technologies are designed with one or the other sort of purpose predominantly in mind. But to the extent that this is a useful distinction, it helps us see that the online, networked environment supports community-building, communication, and the sharing of resources in ways that are impossible to explain simply as a series of point-to-point exchanges. When this online environment is seen as a space people occupy, and through which they *move*, new ways of thinking about it come to the fore.

First, start with the idea of mobility itself: movement defines, and is defined by, both space and time, transiting distance  $d$  in length of time  $t$ . Online mobility has a different character, since what “moves” are electrons through cables, chips, wires, and screens—but what they carry (voices, images, information, etc.) has the quality of *virtual movement* that defines, and is defined by, *virtual space and time*. This is why “distance education”, for example, is becoming an anachronism: distance is not a primary factor in how such teaching and learning are accessed and experienced. The symbol “@”—normally transliterated as “at”—is colloquially used as both a spatial (“meet Bob @ café”) and temporal (“meet Bob @ 2:00”) shorthand. But in the online environment, such as an e-mail address, “@” does not necessarily mean “at”: my e-mail address may appear to be “at University of Illinois”; but someone else is not in the same sense “at yahoo.com” (*where is “yahoo.com”?*)<sup>21</sup>

The nature of our experience in networked environments is frequently of a *kind* of movement: the most obvious example is exploring the World Wide Web.<sup>22</sup> In following hyperlinks, we do have a sense of moving across different semantic spaces: we can trace a kind of trail or pattern to our path; sometimes, we may feel lost. We might wonder, How did I get here? It is

interesting, and significant in my view, that these links and pathways have both semantic as well as navigational characteristics.<sup>23</sup> Here, I want to foreground the question of mobility: we interact with these networked environments with the language, the subjective sensibility, and sometimes even the embodied feeling of movement.

This is dramatically true of certain technological VR systems: a room-sized VR space at my university called “the Cave” features a virtual roller coaster ride. I have seen people almost fall over while “riding” it, even though they are standing upright in an empty, unmoving room, two feet firmly planted on the floor. (I have not personally seen instances of how this simulation earned its colloquial name, “Vomit Mountain”.) I will return later to the nature of embodiment in such contexts, but I want to reiterate that this embodied sense of movement is not unique to VR settings; we might experience something similar, and just as powerful, listening to music, watching a film, or surfing a series of websites. Are we “really moving”? The question of virtuality wants us to see that question in a new light: *we are really moving through virtual space and time*. You ride the roller coaster and sway, stumble, and feel dizzy and nauseous. Is that “real” enough for you? The experience of movement is one of the primary dimensions underlying the sense of immersion which, I have suggested, defines the “virtual”.

But this roller coaster example puts a rather negative spin on the virtual (though people do seem to like riding roller coasters, even when it terrifies them or makes them feel dizzy and nauseous). In many networked settings, this experience of movement is part of the pleasure of discovery. (Why else do we label web browsers with intrepid names like “Explorer”, “Navigator”, and “Safari”?) It is not just that one can be a virtual tourist and go visit websites featuring the sights and sounds of sub-Saharan Africa; it is that even in looking for good barbecue recipes or checking sport scores or sending birthday greetings to a cousin or reading an e-book there is a fluidity and flexibility and “timelessness” to the way one can browse sites, or meander through texts, that feels liberating (Note: I am not saying here that space, time, or embodiment—of the “real” varieties—disappear or become irrelevant when we are in virtual environments; but they do not constitute fundamental constraints on how we inhabit and explore such environments).

Second, online mobility is related to certain things that we can do in virtual space (and time): we can communicate, interact, observe, and even act upon objects “from a distance”. The virtual, Paul Virilio writes, has the quality of simultaneity.<sup>24</sup> This idea of the extension of our senses and physical capabilities suggests, to some, the emergence of a “cyborg” self, a “human+technology” entity that is both more and less than the fully enclosed and self-sufficient human self. This is not my main concern here, though I would point out that prostheses, pace-makers—or for that matter eyeglasses and telescopes—carried us over this bridge a long time ago. I am concerned with the experience of this extension as a transformation of space and time.

These transformations are not only matters of distance; in the Cave at the University of Illinois, you can observe the development of a fertilized chick embryo in an egg, *from the inside*. When we look at a web-cam, watching our child at play in pre-school or checking the current weather in Lillehammer, Norway; when we turn off our coffee maker with a coded beep from our cell phone while we are driving toward work two miles away; when we have a synchronous (“real time”, we like to say) conversation with a colleague from halfway around the world, discussing and simultaneously revising a draft book chapter we have posted in a shared writing space, we are, as I said earlier, doing more than just sending and receiving a series of electronic messages back and forth. We are inhabiting and doing things as actors in a virtual space (and time), and our *expectations*, our *habits*, our *relationships*, and our *values* are reshaped by the fact that we are actors in virtual space and time. “Real” space and time do not disappear or become irrelevant. For one thing, they provide the experiences and the vocabulary that we carry over to the virtual domain as a way of making sense of it. Furthermore, they provide a context that gives the sense of movement within virtual space and time part of its force (the fact that we *know* the colleague is halfway around the world; that the websites we move between have been developed by people who never will meet each other; that we can “fast forward” the stages of development of the chick embryo, etc.). But it is also true that for many people, their activities in virtual space and time provide a set of experiences and vocabulary for how they make sense of “real” space and time too.

Third, our engagement with virtual space and time is linked to the fact of our embodiment.<sup>25</sup> We may have virtual identities and experiences, but these are not set against our “real” embodied identities and experiences; on the contrary, by basing the concept of the virtual on *immersion*, and showing how our embodied selves, in interaction with a situation or set of experiences, are *part of* what creates this sense of immersion, what makes it seem or feel “real” to us (for example, *that* the field of view shifts as we turn our heads), the two domains cannot be understood apart from each other, or even less in opposition to each other.

Another way in which our bodies do not disappear or become irrelevant is that while their internal “clocks”, their needs for rest and for food, may move into the background of our awareness when we are in an immersive experience, these needs have a way of intruding themselves upon us whether we like it or not—and, of course, without attention to such “real” needs none of the rest would matter anyway.

One might even say that our bodied selves are the sites on which the real and the virtual play off each other (for instance, it is the disjunct between what our eyes seem to be telling us and the feedback from our own inner ears that makes the roller coaster ride in the Cave so disorienting). We feel an interaction with a virtual world because we *feel* it; immersion is, revealingly, itself a bodily metaphor.

This intimate connection is even more apparent with the growing interest in *haptics*: the use of touch and feel as the basis for a human/machine interface. Control gloves were one of the first areas explored in this domain: one can, wearing a glove containing sensors, move, pick up, and manipulate objects in a virtual world (remember the scene in the movie *Disclosure* where the character is rifling through folders in a digital file drawer); or to control robotic machines that translate one's movements into a distant location. One dimension of haptics is to strengthen the sense of "action at a distance": imagine being able to pick up a rock on the lunar surface, heft its weight, feel its texture, and so on.<sup>26</sup> Another dimension of haptics is to exploit the particular sensitivity of our sense of touch as the locus of experiencing a virtual domain, providing feedback not just through visual and aural cues but through a tap on the shoulder, a vibration or change in temperature, or, for example, through a seat that allows us to "move" through a virtual domain through movements of our body or shifts of our weight, while communicating back to us a subtle sense of movement or location that provides us with a way of orienting ourselves within a complex domain. Here again our embodied selves do not become irrelevant, quite the contrary.

Finally, there are questions of embodiment and identity, which I introduced earlier in discussing Turkle's *Life on the Screen*. For Turkle, the internet is a zone of enormous creativity and experimentation in forming virtual identities. Decoupled from the apparent one-to-one association of body and identity, participants online are exploring identities, perspectives, and modes of interaction that are not constrained by their "real" selves: pretending to be a character of the opposite gender in a chat room, putting out provocative opinions that are not necessarily one's own, just to see where the discussion will take them, and so on. For many people, these can be tremendously liberating experiments. These are not necessarily *false* identities; they may in fact involve exploring aspects or extrapolations of one's actual identity that cannot be enacted without disapproval, harm, or other consequences in one's ordinary life. So, again, "real" versus "false" identities is too neat a dichotomy, which does not capture the ways in which these can be different *versions* of one's identity. People sometimes say that these virtual identities are in fact more truly who they feel themselves to be. These identities often become the basis on which *interaction* and *involvement* take place in virtual contexts; and they support a sense of significance related to how *interest* and *imagination* get triggered. Hence, they can be fundamental to the process of how immersion takes place.

To be sure, these experiments in identity can be subject to abuses—where playing with an alternative identity can become impersonation or deception (the legendary "Alex" affair, in which a male psychiatrist posed in a women-only chat room as a character named Joan),<sup>27</sup> or where playful online interactions can have dire real-world consequences (a rape in cyberspace),<sup>28</sup> or where participants cannot integrate their various selves into a coherent

identity (that is, a form of schizophrenia), or where they can no longer differentiate between the real and the virtual.<sup>29</sup>

An MCI commercial once said, when you're online, there is no race, no gender, no disability. This is not really true: all of these factors clearly impinge on who is participating online, who is not (the digital divide), and on how those who are online interact with each other—many claim they can identify gender just by others' speech patterns, for example. People do not *lose* their embodied identities when they act anonymously or pretend to be other than they are. But the relative anonymity of online interaction can suppress the effects of prejudice or discrimination. Others are forced to deal more with the content of what one says or does, not necessarily with what one looks like. It is important to remember that the embodied experience for many people is seriously limited: by disability, infirmity, illness, chronic pain, isolation, or a physical appearance that leads others to prejudge, ignore, or despise them. For many of these people, their virtual identities expand their opportunities and sense of efficacy. Here as elsewhere in these sorts of arguments, claims about which mode of interaction is "better" must always be tempered by asking, "better for whom?"<sup>30</sup>

In the end, it is not the existence of new technologies that has raised questions about the necessity of our bodies for our sense of identity; it is a much larger cultural shift that foregrounds the "performative" rather than "essential" character of our embodied selves. Every day people play at other roles in relation to gender, race, sexuality, etc., regardless of their "bodily" facts. For others, I have tried to make clear, the embodied self is seen as an artificial constraint, falsely prioritizing *one* dimension of identity (which is itself a changeable social construction) over others. For the different, the hybrid, the disabled, and others, it is experienced as tremendously liberating *not* to allow an embodied physical "fact" to be so determining; and the virtual is proving a fascinating zone of experimentation in how people can move beyond these embodied physical facts, not necessarily for the sake of "escaping" them or denying them, but for *changing what they mean to themselves and to others*.

In this section I have been asking, If immersion is the basis of virtual experience, what are we immersed "in"? The dynamics of interaction, imagination, interest, and involvement that create the sense of immersion in virtual space and time, I have argued, are closely tied to experiences of mobility, inhabitation, action at a distance, haptic sensitivity, and performative identities that each, in various ways, engage our embodied selves. In this context, it is important to see, *virtual* movement, *virtual* identities, *virtual* action at a distance, and so on are not simulated or illusory experiences: they are real in the context of virtual space and time—as real as can be. And their sense of veracity, their "as if" quality, is intimately tied to the fact that these experiences are implicated in our actual embodied selves, and vice versa; they should not be seen as separate from or in opposition to them.



But there is another stage of transformation. Eventually, the sense of inhabitation, familiarity, and comfort people feel in virtual space and time—especially when these are experienced in conjunction with the similar engagements of other people—achieve a further qualitative shift: from virtual *spaces* to virtual *places*.

#### 4. VIRTUAL PLACES

Calling the online environment a space captures the idea of movement and activity within it, the possibility of discovering meaningful connections between elements found there; but it does not capture the distinctive ways in which people can make a space familiar, make it *their* space—make it a *place*. This shift from thinking in terms of spaces to places reflects an important theoretical and practical difference. A place is a socially or subjectively meaningful space. It has an objective, locational dimension: people can look for a place, find it, move within it. But it also *means* something important to a person or a group of people, and this latter, more subjective, dimension may or may not be communicable to others. When people are in a *place*, they know where they are, and what it means to be there. Place also has an important temporal dimension, because places emerge, change, and develop diachronically: a space may be a place at one point in time, but not earlier or later; or it may become a different kind of place.<sup>31</sup>

The transactional elements of interest, involvement, interaction, and imagination, as I have defined them here, are not just qualities of response to an experience: they actively shape and change the experience. We might not just visit a space; after a while we move in, start to rearrange the furniture, so to speak, and make it comfy. Spaces are transformed by such activities. And, as I have mentioned, this is not necessarily an individual endeavor, but can be a collective one—indeed, it is often the quality of a space as a *shared space* that plays a crucial role in its development into a *place*. Things happen there, memorable things (whether pleasant or unpleasant, but *important*), which mark the space as a place (“this is where it happened”). Places become familiar, acclimated to us as we are to them. They become marked by various social conventions (rules, norms, customs, vocabularies). They become, in many cases, a locus of community. In all of these respects, a relatively objective space and time, a pre-transformative given, becomes something marked, signified, *important*: and in this both the space and those inhabiting it are changed in relation to each other. A place is a special, important kind of space; but those occupying it also stand in a different relation to the space, and to each other, because they are there. In this description, I have purposely not emphasized whether these must be *virtual* spaces becoming *virtual* places; this dynamic is true of spaces and places generally (a crossroads, a battlefield, a classroom, a lovers lane). Or perhaps it is more accurate to say that insofar

as spaces become places, there is *always* an element of the virtual to them (in other words, there is a quality of immersion, supported by the elements of interest, involvement, interaction, and imagination).

It is possible to theorize more broadly what is going on here. There are two distinctive ways in which we turn spaces into places.<sup>32</sup> One is by *mapping*: by developing schemata that represent the space, identify important points within it, and facilitate movement within it. A map is never an exact replica (as the story goes, the only map that would be identical would be an exact copy of the original, which would be useless as a map)—a map always simplifies, selects, and schematizes the original, and it is the particular way in which this simplification, selection, and schematization occur that makes this version of the space a place. These are pragmatic activities; we make certain, and not other, choices because they allow us to do things in the space that are meaningful and important to us. There can be multiple maps, and in this sense they constitute different *places*, even when they refer to the same space.

There are also maps that represent patterns of use. Trails that are worn by many feet tramping through forests, or across campus greens, are maps of a sort. Again, they simplify, select, and schematize a space: they identify what is important to people, they mark out key places, they facilitate movement. They also indicate another important characteristic of maps: how their use can also shape and transform the space they represent. This can be seen at work in the World Wide Web, for example, through frequency indicators: page counters, for example, as well as ratings of “most frequently visited” sites. Such representations tend to influence patterns of future use, because they influence how search engines pick out and identify sites, which sites get selected for indexes, and so on. Viewed pragmatically, the representation is not discrete from the thing represented; it acts upon and is acted upon by it.

Yet another kind of map is one showing relations of relative centrality and relative periphery, from some point or points of reference. The repetitiveness of “relative” here is not accidental: there can be no absolute center of a space that is any more necessary than any other—in fact, it is as true to say that a center is *defined* by the map, as to say that the map begins from a center. And a more rhizomic map may have no single center at all. But a map of relative centrality and periphery can still provide a way of simplifying, selecting, and schematizing the pragmatic relation of what is more or less useful or relevant to a given purpose, or set of purposes. This sort of endeavor can be highly useful even though there is nothing necessary about this particular mapping, even if others would map it differently—indeed, we should expect this to be true in order for such maps of relative centrality and periphery to be useful to different people (because their purposes and criteria will differ).

In sum, a map does two things as once: it marks significant places, and it makes places significant by marking them. To return again to the four elements of immersion: mapping is a process that makes manifest our *involvement* with

a space, the places we care about; it is an expression of *interest*, as mapping is a kind of problem-solving (how do we find our way about); it entails an act of *imagination*, because mapping is a process of selecting what is judged to be significant enough to include, and of adding a structure of association and organization for what is selected (in other words, it is both less and more than the original); and finally, mapping is a process of *interaction*, changing what is mapped, from space to place, in the process of trying to describe it.

The second distinctive way in which spaces become places is through *architecture*. A space becomes a place when we build into it enduring structures. Often, we live in these structures, work in them, observe or admire them. We are changed by these things we create as we change them—the relation runs both ways. Architecture here is not only the initial design or building, but also the transformation of it over time; in this sense, we always help build the structures we occupy, and the structures are not fully finished until they have been used for a while (in one sense, then, they are never “finished”). Here, I do not mean architecture only in the literal sense of buildings and bridges; there are architectures also of language, of customs, of complex practices and activities (games, for example); all of these can play a role in transforming a space into a place.

Architectures transform not only a space, but also the patterns of activity for those who occupy them. I think that these patterns can be viewed along five polarities:

- (1) movement/stasis;
- (2) interaction/isolation;
- (3) publicity/privacy;
- (4) visibility/hiddenness;
- (5) enclosure/exclusion.

These inter-related dynamics shape the ways in which participants operate within a space, and the particular constellation of them gives a space its distinctive character as a certain kind of place: for example, structures along the polarity of isolation, hiddenness, and privacy, versus those emphasizing visibility, interaction, and publicity.

(1) Architectures facilitate, direct, or inhibit movement. They anticipate the way in which people are likely to navigate a space, but by making this assumption they also tend to direct it. In an art museum, for example, this is reflected in choices such as what exhibits to put near each other, and where to put doorways. Where will people want to pause, and which paintings will they want to linger over? Yet there are substantive assumptions at work here as well: say one wants to learn about historical periods in art, but finds that the rooms have been organized by subject matter or styles of painting; all the information is there the visitor might want, but not in a pattern that supports the inferences he or she is trying to make. Which room to start with? Where to go next? The visitor's confusion and uncertainty may also be a kind of

paralysis, even though the design of the museum is, on its own terms, quite clear and easily navigated.

(2) The design of spaces also communicates assumptions and expectations about social interaction. Architectures, by directing movement, create avenues to bring people together or barriers to keep them apart. Where will crowds tend to congregate, for example? Architectures also make assumptions about the kinds of things people will be doing in a space, and whether they want to be doing it with others or alone. Again, these assumptions also shape behaviors: if a telephone booth is only big enough for one person, three girl friends cannot all talk to their friend at the same time; they have to decide who gets to talk first, which may start an argument.

(3) Publicity and privacy constitute a slightly different issue, which is the extent to which an architecture allows or inhibits the disclosure of the participants' selves, their activities, and not only their words and ideas, to others (and vice versa). Are walls transparent; or are there walls at all? Can you be seen, or do you always know you might be seen, and how does this tend to encourage or discourage certain things you might do? Can you *choose* when you can be seen, and when you do not want to be?

(4) Visibility and hiddenness, here, refer to the transparency of architectures, to what they disclose or conceal within, and to what they disclose or conceal about themselves. This is not quite the same as publicity and privacy, because here what is exposed or hidden are characteristics of the architecture itself. Does a wall close off a room that only some people know how to get to? Where does this doorway lead, and who is allowed through it?

(5) Architectures also operate through enclosure and exclusion; what (or who) is counted in and what is counted out. Some structures are intended to define a community made special in its own eyes by its privileged access and made to feel safe so that others viewed as less worthy will not interfere. The very attractions of such a partitioned space give rise to its limitations: the risk of complacency and numbing homogeneity. If we assume that certain kinds of change and development can only come from encounters with new and challenging ideas, this architecture of enclosure and exclusion may seem less like a protective shell, and more like a self-built prison.

There is much more to be said about architecture and the dynamics of shaping spaces into places; but here again, I want to return to the dynamics of virtuality. I have tried to indicate how specific design features express assumptions about social dynamics, values, knowledge, and substantive subject matter; in this, I have tried to enlarge the concept of "architecture" to mean much more than just the design of rooms and buildings. Architectures reveal and conceal; they facilitate and discourage; they welcome and exclude; they direct and redirect and inhibit certain choices. In all this, architectures assume particular modes of interest, involvement, interaction, and imagination—and in these assumptions tend to bring them about (or to suppress other modes).

In summary, I have explained two different ways in which spaces become places. The first is mapping, which is in some ways a more reactive process; a process of representing a space in order to be able to move and work within it. A mapped space takes on the character of a place for those who understand and can use the map. The second way in which spaces become places is through architectures; enduring structures that reconfigure spaces. This is in some ways a more active process, in which the space is not only represented (mapped), but also transformed. There are at least five ways, I have suggested, in which this transformation affects not only the configuration of space, but also the activities and the persons who operate within it. These dimensions determine the kind of place it is. I do not mean to argue that the activities of mapping and architecture are utterly unrelated or dichotomous: sometimes a map is prefatory to designing a structure (a blueprint is a kind of map, in fact); sometimes a large, complex architectural layout includes maps or directional markers within it as a way of helping people get around; trails, as I describe them here, have features of both. But the ways in which mapping and architecture influence navigation and meaning-making are different; and they suggest something important, I think, about virtual learning environments.

## 5. VIRTUAL LEARNING ENVIRONMENTS

Earlier, I described virtual learning environments as spaces where creativity, problemsolving, communication, collaboration, experimentation, and inquiry can happen.<sup>33</sup> But now we can give greater specificity to how they happen. Let me suggest that mapping indicates, on the whole, the perspective of the learner while architecture indicates more the perspective of the teacher (though again, I am not trying to separate these entirely). A learner is asking, How do I find my way about? A teacher is asking, How do I design this learning space in such a way that my students will explore and use it in the way I intend for them to? Mapping and architecture are both ways of turning spaces into places, generally; but in the context of this chapter, I am interested in how they turn virtual spaces into virtual places—and more specifically, virtual *learning* spaces into meaningful, hospitable virtual learning places. They do this by guiding the dynamics of interest, involvement, imagination, and interaction in ways that are judged to be productive (in this case, educationally productive); when they are successful, the learning space becomes immersive—the learner is engaged, actively relating to the subject matter, seeing (and I will add here *feeling*) its importance. As I mentioned before, a place (as opposed to a space) always entails, to some extent, the quality of the virtual; and so in this sense it is no exaggeration to say that a successful learning space, as it becomes a learning place, is in a wider sense *by definition* virtual.

Now, I think you can see the larger purpose of my discussion here: to remove the virtual from a fundamentally technological domain and situate

it at the core of educational theory and practice. How do we make learning *immersive*? What role do interest, involvement, imagination, and interaction play as dimensions of active engagement between a learner and a learning environment? In what ways are these activities linked with *mapping*? How can we theorize teaching as the design of *architectures* of learning spaces—architectures that allow learners to inhabit and experience them as places of interest and familiarity? How do these structures of the virtual express (and thereby reinforce) deeper assumptions about social community, value, equity, and the nature of knowledge? Do they assume standardized models of engagement, or tolerate, even encourage, the expression and exploration of alternative identities? Each of these important questions needs to be elaborated in further studies.

This rethinking of the virtual as an educational concept<sup>34</sup> poses a sharp contrast to much current practice: in highlighting the centrality of choice, decision, and exploration as important dimensions of learning; in thinking in terms of learning spaces (learning places), rather than “delivery systems”; in seeing these learning places as potential sites of collaboration and communities of learners, and not just individual achievement; and in recognizing that the face-to-face classroom, as it is currently constituted, is by no means necessarily more humane or authentic than alternative learning spaces. One can see these issues arising in how new information and communication technologies are being thought about and used in schools—but as should be apparent they raise much larger questions about the ways that we think about teaching and learning in general.

I hope to have laid the groundwork for a reconception of the virtual, and to have engaged in an exercise in virtuality here: beginning the design of a theoretical architecture that invites engagement and exploration. If I have been successful in some measure, you have moved into this space yourself and begun to make it a place of your own. It may not be the same as mine. But an academic article can also be a virtual environment—one that you complement through your own interest, involvement, imagination, and interaction.

#### ACKNOWLEDGMENTS

Previous versions of some parts of this chapter were presented in “Dialogue in Virtual Spaces” at the Didactics and Technology Conference, Lillehammer University (Norway); in “Virtual Spaces as Places of Teaching and Learning” at Ohio State University, Columbus Ohio; and in “On Virtual Learning Environments” at the Wisconsin Library Association, Milwaukee, Wisconsin. The manuscript was completed during a sabbatical hosted at the American College of Thessaloniki, and has been supported in part by the endowment of the Grayce Wicall Gauthier Professorship. I want to thank Megan Boler and Vincent Müller for helpful feedback on earlier drafts.

## ENDNOTES

1. <http://www.fourthwavegroup.com/fwg/lexicon/1725w1.htm> [last accessed March 14, 2004]. However, Michael Heim argues that “the father of virtual reality” was Myron Kreuger, writing in the 1960’s: Heim (1993).
2. <http://ism.ferris.edu/students/m/maqboolt/Paper10.htm> [last accessed May 26, 2001].
3. <http://www.euro.net/mark-space.glosVirtualReality.html> [last accessed May 26, 2001].
4. [http://www.openchannelsoftware.org/discipline/Visualization\\_and\\_Virtual\\_Reality](http://www.openchannelsoftware.org/discipline/Visualization_and_Virtual_Reality) [last accessed March 14, 2004].
5. <http://w1.2691.telia.com/~u269100246/vr/vrhi0f98/whatisvr/What1.html> [last accessed May 26, 2001].
6. <http://www.euro.net/mark-space.glosVirtualReality.html> [last accessed May 26, 2001].
7. On this sense of immersion, I have been influenced by the ideas of Alan B. Craig and William R. Sherman, National Center for Supercomputing Applications, University of Illinois. See, for example, Sherman and Craig (1995).
8. Kneale (1999) and Light (1999).
9. See, for example, Rheingold (1991). For contrasting views that do not dichotomize the virtual and the real, see Levy (1998). Myron Krueger in the preface to Heim (?); Castells (?); and Imken (?), who calls this exaggerated dichotomy “cyperbole”.
10. Heidegger (1977).
11. For an excellent critical discussion of Heidegger’s legacy in this context, see Feenberg (1999).
12. For one version of this account, see Goodman (1978).
13. Herman and Mandell (2000). [http://www.firstmonday.dk/issues/issue5\\_10/herman/index.html](http://www.firstmonday.dk/issues/issue5_10/herman/index.html) [last accessed January 9, 2002].
14. A good overview of this work, focusing especially on the ideas of Baudrillard and Derrida, can be found in Poster (2001). See Baudrillard (1993, 1995, 1996). In Baudrillard (1996), the “perfect crime” refers to a deception so perfect it is never seen as such: “The virtual illusion is contrary to that of appearances. Nothing hides itself there, no secret, no absence. Its aim is the cloning of reality, the cloning of the real by the hyper-real, and the extermination of the real by its double”. For more on Baudrillard, see Doel and Clarke (?).
15. Turkle (1995).
16. See my contribution to an exchange with Hubert Dreyfus on Turkle’s ideas: Burbules (2002a, b).
17. On telepresence, see for example, Steuer (?).
18. There are some similarities between my account here and that provided by Heim (1993) and especially in Heim (1998). In Heim (1998), he

even proposes his own “3 i’s” (immersion, interaction, and information intensity) (pp. 6–7). He also stresses in both books the quality of “as if”; but my account is quite different from his, and in any event I encountered these books after developing the ideas here.

19. Dewey (1938).
20. This argument is developed and expanded from a keynote address given at Lillehammer University, in Norway, and published in Fritze et al. (2003).
21. This issue is explored very perceptively in Kawash (1997). I write more about this in the last chapter of Burbules and Callister (2000).
22. Burbules (2000).
23. Burbules (1997, 2002a, b).
24. Virilio, P. (1997). *Open Sky*. London: Verso.
25. See also Boler, M. *The New Digital Cartesianism: Bodies and Spaces in Online Education*, in review, *New Media and Society*.
26. This description may trouble some readers: “*You* aren’t picking it up, but directing a robotic arm to do so in another location.” Apparently so. But imagine lots of cases that blur this distinction: what if I am using my prosthetic arm; what if I am using a clamp in my hand to pick something up that is hot—in such cases, do we not say “I picked it up”?
27. Turkle (?), pp. 228–230.
28. Turkle (?), pp. 250–254.
29. Turkle (?), pp. 258–262.
30. For an insightful analysis of this same MCI commercial, see Boler (2001).
31. On “place” as an educational concept, see, for example, Gruenewald (2003), which includes an excellent bibliography; McKie (2000); and Kolb (2000).
32. Some of these ideas were first explored in the last chapter of Burbules and Callister (2000). See also Dodge and Kitchin (2001).
33. Some more concrete educational implications of this analysis can be found in Burbules (forthcoming).
34. For some contrasting views, see Inkpen (?), Osberg (?), Russell (?), Schwienhorst (?), and Herman and Mandell (2000).

## REFERENCES

- Baudrillard, J. (1993). *The Perfect Crime*. Available from the website of the European Graduate School of Media and Communications: <http://www.egs.edu/faculty/audrillard/audrillard-the-perfect-crime.html> [last accessed March 11, 2004].
- Baudrillard, J. (1995). The virtual illusion. *Theory Culture and Society* 12, 97–107.
- Baudrillard, J. (1996). *The Perfect Crime*. London: Verso.



- Boler, M. (2001). Bodies and Space in Cyberculture. *Philosophy of Education Society Annual Meeting*, March.
- Burbules, N. C. (1997). Rhetorics of the web: hyperreading and critical literacy. In: Snyder, I. (Ed.) *Page to Screen: Taking Literacy Into the Electronic Era*. New South Wales: Allen and Unwin, 102–122.
- Burbules, N. C. (2000). Aporias, webs, and passages: doubt as an opportunity to learn. *Curriculum Inquiry* 30(2), 171–187.
- Burbules, N. C. (2002a). Like a version: playing with online identities. *Educational Philosophy and Theory* 34(4), 387–393.
- Burbules, N. C. (2002b). The web as a rhetorical place. In: Snyder, I. (Ed.). *Silicon Literacies*. London: Routledge, 75–84.
- Burbules, N. C. (forthcoming). Navigating the advantages and disadvantages of online pedagogy. In: Haythornthwaite, C. and Kazmer, M. M. (Eds.) *Learning, Culture, and Community: Multiple Perspectives and Practices in Online Education*. Peter Lang.
- Burbules, N. C. & Callister, T. A., Jr. (2000). *Watch IT: The Promises and Risks of Information Technologies for Education*. Boulder, Colorado: Westview Press.
- Castells, M. The virtual not as copy or representation but as alternative. (quoted In: Crang, Crang, and May (Eds.) *Virtual Geographies*, 7.
- Dewey, J. (1938). *Experience and Education*. New York: Macmillan.
- Dodge, M. & Kitchin, R. (2001). *Mapping Cyberspace*. New York: Routledge.
- Doel, M. & Clarke, D. B. Virtual worlds. In: Crang, Crang, and May (Eds.) *Virtual Geographies*, 277–280.
- Feenberg, A. (1999). *Questioning Technology*. New York: Routledge.
- Fritze, Y., Haugsbakk, G., and Nordkvelle, Y. (Eds.) (2003). Dialogue in virtual spaces. *Dialog og Naerhet: Ikt og Undervisning*. Kristiansand, Norway: Norwegian Academic Press, 19–28.
- Goodman, N. (1978). Highly influential *Ways of Worldmaking*. Indianapolis: Hackett Publishing.
- Gruenewald, D. (2003). Foundations of place: a multidisciplinary framework for place-conscious education. *American Educational Research Journal* 40(3), 619–654.
- Heidegger, M. (1977). The question concerning technology. In: Krell, D. (Ed.) *Basic Writings*. New York: Harper and Row, 283–317.
- Heim, M. (1993). *The Metaphysics of Virtual Reality*. New York: Oxford, 115–116.
- Heim, M. (1998). *Virtual Realism*. New York: Oxford University Press, 6–7.
- Heim, M. Virtual reality constitutes a new form of human experience. *The Metaphysics of Virtual Reality*, vii.
- Herman, L. & Mandell, A. (2000). The given and the made: authenticity and nature in virtual education. *First Monday* 5/10.
- Imken, O. The convergence of the virtual and the actual in the global matrix. In: Crang, Crang, and May (Eds.) *Virtual Geographies*, 92–106.
- Inkpen S. Virtual Reality and Education. Available at: <http://www.oise.utoronto.ca/~sinkpen/VRED.html.gz> [last accessed March 14, 2004].
- Kawash, S. (1997). “@, or being on line”. *Theory and Event* 1(2). Also online at: [http://muse.jhu.edu/journals/theory\\_&\\_event/v001/1.2kawash.html](http://muse.jhu.edu/journals/theory_&_event/v001/1.2kawash.html).
- Kneale, J. (1999). The virtual realities of technology and fiction. In: Crang, M., Crang, P., and May, J. (Eds.) *Virtual Geographies: Bodies, Spaces, and Relations*. New York: Routledge, 205–221.
- Kolb, D. (2000). Learning places: building dwelling thinking online. *Journal of Philosophy of Education* 34(1), 121–133.
- Levy, P. (1998). The virtual is by no means the opposite of the real. *Becoming Virtual: Reality in the Digital Age*, trans. Robert Bononno. New York: Plenum, 16. Light, J. S. (1999). From

- city space to cyberspace. In: Crang, M., Crang, P., and May, J. (Eds.) *Virtual Geographies: Bodies, Spaces, and Relations*. New York: Routledge, 109–130.
- McKie, J. (2000). Conjuring notions of place. *Journal of Philosophy of Education* 34(1), 111–120.
- Osberg K. Virtual Reality and Education: A Look at Both Sides of the Sword. Available at: <http://www.hitl.washington.edu/publications/r-93-7/> [last accessed March 14, 2004].
- Poster, M. (2001). Theorizing the virtual. *What's the Matter with the Internet?* Minneapolis: University of Minnesota Press.
- Rheingold, H. (1991). Artificial experience. *Virtual Reality*. London: Mandarin, 46.
- Russell G. *Computer-Mediated School Education and the Web*. Available at: [http://firstmonday.org/issues/issue6\\_11/russell/index.html](http://firstmonday.org/issues/issue6_11/russell/index.html) and [http://firstmonday.org/issues/issue6\\_11/russell/index.html](http://firstmonday.org/issues/issue6_11/russell/index.html).
- Schwiehorst, K. (1998). The third place—virtual reality applications for second language learning. *ReCALL* 10(1), 118–126.
- Sherman, W. R. & Craig, A. B. (1995). Literacy in virtual reality: A New Medium, *Computer Graphics* 29(4).
- Steuer, J. *Defining Virtual Reality: Dimensions Determining Telepresence*. Available at: <http://www.cyborganic.com/People/jonathan/Academia/Papers/Web/defining-vr1.html> and <http://www.cyborganic.com/People/jonathan/Academia/Papers/Web/defining-vr2.html> [last accessed May 26, 2001].
- Turkle, S. (1995). *Life on the Screen: Identity in the Age of the Internet*. New York: Simon and Schuster.
- Turkle, *Life on the Screen* 228–230; 250–254; 258–262.

## Chapter 2: A History of E-learning: Shift Happened

LINDA HARASIM

*School of Communication, Simon Fraser University, Vancouver, BC, Canada*

However, the very genesis of e-learning as based on human collaboration in knowledge work and innovation, can be traced to the development of network communication in the late 1960s, with the invention of e-mail and computer conferencing over packet-switched networks in 1971. Historically, these technological innovations introduced an unprecedented opportunity whereby people could communicate and collaborate despite differences in time and place, and they became key to a social, economic, and especially educational paradigmatic shift.

The telecommunications revolution both enabled and required fundamentally new forms of societal and economic activity, leading to the knowledge economy. The resultant demands and opportunities impacted and transformed education.

The 1980s and 1990s represented a period of intense innovation and expansion in e-learning and networking throughout public schooling as well as in tertiary, professional, workplace, and adult education. The 21st century thus unfolded with new attitudes toward e-learning, and the emergence of new pedagogical models, technological affordances, and mindsets. A paradigm shift became apparent, subtle yet ultimately profound. A fundamental shift in understanding of the very nature of learning and hence the definition, design, and delivery of education characterized the late 1990s and early 21st century, and this shift became civilizational and global as educators and learners worldwide adopted networked e-learning.

This chapter addresses that paradigmatic shift. It begins by presenting an overview of the history of online education as a context and framework for understanding the state of the art of e-learning today, especially the use of network technologies for collaborative learning. The chapter outlines how the early pioneers contributed to the educational paradigm change and how the theory and practice of learning has been advanced into new learning theories and models, modes of delivery, instructional roles, instructional designs, and learning processes and outcomes. The goal of the chapter is to provide an overview of the highlights of the early days of e-learning, a sense of the accomplishments, the challenges, and the adventure. The author recognizes that there are many more dots to be added and linked into creating a comprehensive history. I apologize to the many individuals, teams, and projects omitted. Let us keep working at documenting our history. The field and its future deserve it.

## 1. HISTORY AND OVERVIEW

The Communication Revolution launched in the late 19th century with the invention of the telegraph (1861) and the telephone (1876) and advanced in the 20th century with the Network Revolution (1969–) has fundamentally impacted our social, economic, cultural, and personal lives, ultimately on a planetary level.

Large-scale adoption of telecommunication technologies invented over the past 150 years have created a world profoundly different in terms of human collaboration and communication than was hitherto ever conceivable. Up until the mid-1800s, telecommunications had been the same for millennia: non-existent except for highest levels of royal or religious use. Queen Victoria had available to her basically the same means of communication as did the Egyptian Pharaohs: mail carried by beast (horse, camel, etc.) or by ship. The village was a closed unit, with communication limited to local face-to-face conversation, or transmitted by peddler/traveler passing through, or by such technologies as smoke signal or talking drum. By the 18th century, mail carriages and variations of the Pony Express enabled some distance communications by the public.

It was the invention of the telegraph and then the telephone in the late 19th century, however, that opened the floodgates of public telecommunications. And the Network Revolution, launched in the mid-20th century with the invention of the Net, e-mail, the internet, the web, etc. triggered a global revolution in human communications, community, and especially their application to education.

The timeline below (Figure 1) identifies key moments in the development of e-learning modalities, which typically employed peer communication and interaction. This chapter focuses on e-learning based on online collaborative learning (OCL) which was the dominant form until the 1990s when the invention of the internet made online distance education (ODE) more viable, and in 1993 when the web made online computer-based training (OCBT) more publicly accessible. Nonetheless, historically, the invention and dissemination of e-learning has been largely based on collaborative learning approaches.

Below is a brief timeline of the history of e-learning.

## 2. HISTORY OF THE FIELD OF E-LEARNING

Educational adoption of computer networking began in the mid-1970s, following closely upon the very invention of packet-switched networks in 1969 and of e-mail and computer conferencing in 1971 (Hafner & Lyon, 1996; Hiltz & Turoff, 1978). Many of the scientific researchers involved in early networking

YEAR	EXAMPLE	
1861	<i>Telegraph is Invented</i>	
1876	<i>Telephone is Invented</i>	
1969	<i>Computer data networking is Invented (ARPANET)</i>	DARPANET/ARPANET
1971	<i>Email is Invented</i>	
1971	<i>Computer Conferencing is Invented</i>	1971
Mid 70's	University Courses are Supplemented by Email and Conferencing	
Mid 70's	Virtual Communities of Practice	Scientists use EIES to collaborate
1981	First Totally Online Courses (Nonformal, Adult Education)	The Source; EIES
1982	First Online Program (Executive Education)	• WBSI Executive Education (EIES)
1983	Networked Classroom Model Emerges (Primary and Secondary Schools)	• ICLN Research Project in 4 Countries • RAPPI: Canada X-Cultural Project I Countries • SITP (1990)
1986	First Totally Online Undergraduate Classroom	• Virtual Classroom (NJIT)
1985	First Totally Online Graduate Courses	• Connect-Ed (New School of Social Research) • OISE (University of Toronto)
1985	First Totally Online Labour Education Network	• Solinet (Canadian Union of Public Employees)
1986	First Online Degree Program	• Connect-ED (1986) • 1989 University of Phoenix
1986	Online Professional Development Communities Emerge	• OISE Ontario Educators Online Courses
1989	<i>Internet launched</i>	
1989	First Large Scale Online Courses	• Open University (U.K)
1992	<i>World Wide Web is invented</i>	• CERN (Switzerland)
1993	First National Educational Networks	• 1993 SchoolNet (Canada) •
1996	First Large-Scale Online Education Field Trials	• Virtual-U Research Project

Figure 1. Brief history of e-learning.

experiments were also academics. As these faculty introduced e-mail and computer conferencing into their academic curricula, they discovered expanded opportunities for student communication, interaction, and collaboration. Beyond what anyone anticipated, a sea change in education would emerge.

It is difficult to convey the *tabula rasa* that early e-learning pioneers confronted in conceptualizing their vision of educational applications of computer communications. The technology was unprecedented: What was e-mail? What was computer conferencing? How to use one or the other technology? How to value them? Design them for education? Turoff (and cohorts such as Jacques

Vallee) played an immense role in both inventing and championing computer conferencing as a group communication system, in contrast to e-mail, which is a one-to-one or one-to-many communication mode (Vallee, 1982). What role did group interaction play in education? Was there any value added at all? These were not only mind-boggling questions but coming in the shadow of the disappointments and criticisms of educational television, any application of technology or computers in education was greeted with skepticism at best and derision most often.

Nonetheless, scattered throughout the U.S.A., Canada, and the U.K., handfuls of individuals and small teams pursued their vision of online educational applications. While many e-learning early adopters in the 1980s focused on electronic mail (e-mail), computer conferencing increasingly became recognized as key to facilitating collaboration and interaction in educational discourse and teamwork.

What follows is a sample of some of the highlights and key contributions, and selected exemplars.<sup>1</sup> The accounts are organized by type of education and level of education—and by educational application. Some specific technological advances are noted but the intent is to focus on the *educational* rather than the *technological* transformation.

## **2.1. Organization of the Content: Definitions and Categories**

This section defines key educational terms that have come to be associated with e-learning, and which are used to organize the content of the chapter. Three different categories, each with three sub-categories, are identified.

The first set of terms or definitions is that of the Educational Approach: how is the e-learning application designed in terms of pedagogical model? The Educational Approach emphasized in this chapter is that of OCL, which was historically the first and remains the major approach to e-learning.

### *2.1.1. Educational Approach (Pedagogy)*

Educational Approach refers to the pedagogical models that an application is based on. E-learning has in recent years come to represent a myriad of different even contradictory educational approaches. The term e-learning is often applied without differentiation by the news media, and even by vendors to any use of online activity, regardless of educational model. This confounds research results related to e-learning and confuses the practitioners. Here, we provide a brief definition of three major models (Harasim, 2003):

- a) *Online collaborative learning* emphasizes the use of collaborative discourse and group projects (such as debates, simulations, role plays, case analyses) in the online activities. OCL is the educational approach emphasized in this chapter.
- b) *Online distance education* refers to the use of e-mail rather than postal mail for the mailing and receipt of distance education materials and assignments. Pedagogically, it relies predominantly on the traditional correspondence or one-to-one, one-to-many model.
- c) *Online computer-based training* refers to the use of the web for access to online courseware or individualized learning modules. There is typically neither peer collaboration nor communication with an instructor or tutor; the major interaction occurs between the learner and the software.

It should also be stated that the applications in this chapter refer to asynchronous types of e-learning (use of e-mail, computer conferencing, forums), and not synchronous (i.e., real-time chats, videoconferencing, etc.) e-learning.

#### 2.1.2. Educational Form

In order to understand the design and implementation of e-learning, it is essential to recognize the types of education likely to occur in various settings. Educators and researchers have increasingly come to distinguish among three types of education: formal, non-formal, and informal settings first described by Coombs and Ahmed (1974) that proposed to equate learning and education.

Coombs and Ahmed define these educational types as follows:

- formal education is the “institutionalized, chronologically graded, and hierarchically structured educational system, spanning lower primary school and the upper reaches of university”;
- non-formal education is “any organized, systematic, educational activity carried on outside the framework of the formal system to provide selected types of learning to particular sub-groups of the population, adults as well as children”; whereas
- informal education is “the lifelong process by which every person acquires and accumulates knowledge, skills attitudes and insights from daily experiences, and exposure to the environment”.

A major difference between the first two processes and the third is that the deliberate instructional and programmatic emphases in formal and non-formal education are absent in informal education. Hence, given the very experiential and amorphous nature of informal education, it will not be discussed in this chapter.

### 2.1.3. Educational Mode

Various applications of e-learning, regardless of discipline, can also be organized along quantity/quality dimensions (Harasim, 1993). Three key categories are

- a) *Adjunct mode*: In which online networking is used to supplement a traditional face-to-face classroom or distance education approach.
- b) *Mixed (blended) mode*: In which online networking is used as a significant component of the curriculum and course grade.
- c) *Totally online mode*: In which online networking is the major form of discourse and course delivery (although other formats such as text books, phone calls) may be used to supplement the course.

## 2.2. History of E-Learning Applications

This section of the chapter explores the emergence and development of e-learning applications in the 1970s, 1980s, and 1990s. The applications are categorized by Educational Form/Type (non-formal, formal); the formal categories are further sub-categorized by Educational Mode (Adjunct, Mixed, and Totally Online Mode) in the order below:

1. Non-formal education applications
  - a. Virtual communities of practice (first launched in mid-1970s)
  - b. Executive education (first launched in 1982)
  - c. Labor education (1985)
  - d. Teacher networking and professional development (1986)
2. Formal education post-secondary applications
  - a. Adjunct mode course delivery (mid-1970s)
  - b. Totally online undergraduate course delivery (1984)
  - c. Totally online graduate course delivery (1985)
  - d. Totally online program delivery (1985, 1989)
3. Formal education K-12 school applications
  - a. Adjunct mode applications (networked classrooms) (1983)
  - b. Mixed mode applications (1990)
4. E-learning research: communities, projects, and theory

### 2.2.1. Non-Formal Education Applications

#### 2.2.1.1. First Virtual Communities of Practice

Murray Turoff, credited as the father of computer conferencing, designed the first computer conferencing system in 1971 as a Delphi System (EMISARI). By 1974 he was at New Jersey Institute of Technology, following his “dream



of developing and evaluating computer mediated communication technology to facilitate group decisions so that groups might act with their collective intelligence instead of the lowest common denominator” (Turoff, 1999: 39). There he created the Electronic Information Exchange System (EIES) for scientific research communities.

In the early 1970’s the research group I direct at NJIT started an R&D program in the area of Computer Mediated Communication, conceived as the use of computers to facilitate group communications by tailoring the communication structure and protocol to fit the nature of both the application and the group. Our first effort, sponsored by the National Science Foundation, was dedicated to the study of scientific communications and the working of “invisible colleges” or research communities. We were also looking at decision support applications and the use of the technology to facilitate project groups developing software. In 1976 we went online across the nation with the first version of EIES, the Electronic Information Exchange System. We were using Telenet as well as Arpanet and grew our user population to many hundreds of professional users in a short space of time. By the mid eighties we had a few thousand users in one system.

(Turoff, 1999: 39)

The book, *Network Nation: Human Communication via Computer* (Hiltz and Turoff, 1978) is highly recommended reading as a thorough overview of the state of the art of online communication in the mid-1970s, and the authors’ vision of the use of technology to support “invisible colleges” of scientists building knowledge together and applying “collective intelligence” to decision making and problem solving, the catalysts that resulted in the first Virtual Communities of Practice, linking scientists via computer conferencing.

#### 2.2.1.2. Executive Education (1982–)

In 1982, the Western Behavioral Sciences Institute (WBSI), based in La Jolla, California, launched an innovative educational program to deliver online courses, taught by prominent university faculty, to highly placed executives. WBSI targeted executives who needed access to state-of-the-art intelligence and discourse but who could not afford to leave their jobs for long periods of time. It was a 2-year program of four six-month sessions online, with an initial face-to-face seminar.

The real problems began when the participants returned home. Since no one had ever been taught on a computer network before, there were no models. The first courses consisted of either professorial monologues

that made interesting reading but were unsatisfactory as computer conferences or telegraphic questions followed by days of inactivity while the teachers waited for responses. Meanwhile, various technical problems inhibited the participants from joining in the conversation, such as it was.

Recall that these were the early days of the personal computer. We used modified Apple IIE's with 48K of RAM and 300 baud Hayes modems—donated by Dennis Hayes who was himself a participant—to access the Electronic Information exchange System (EIES) network at the New Jersey Institute of Technology. . . . This setup was so complex, it took a full page of instructions just to sign on and many more pages to list the basic EIES commands.

(Feenberg, 1993: 187)

Feenberg reports that “WBSI’s first attempts at online teaching were disastrous. Great teachers were helpless in front of a class of sympathetic but skeptical students scattered between Caracas, Philadelphia, and San Francisco”. (*ibid.*: 191). Yet despite the problems, student numbers grew. Students engaged in a “frontier solidarity” that increased their engagement to the program and to building a virtual support community. Moreover, the WBSI program offered participants a unique opportunity to extend their intellectual reach: “where else could they hope to find professors from Harvard, Yale, and the University of California, a Jonas Salk, a Carl Rogers and a Steward Brand, all available in an information-age setting?” (*ibid.*: 187).

Through trial and effort the WBSI program faculty, students, and consultants (especially consultants Peter and Trudy Johnson-Lenz) worked through various pedagogical approaches to ultimately settle on the online group discussion model.

#### 2.2.1.3. Labor Education (1985–)

SoliNet (Canada’s Solidarity Network) began in 1985, launched by Marc Belanger originally for the members of the Canadian Union of Public Employees. As a technology organizer he was responsible for “the installation of Canada’s first Local Area Network (LAN) and the development of the country’s first national, bilingual, computer conferencing system (note all the qualifiers there). The conferencing system, SoliNet, was the first labor-education computer communications system in the world” (Belanger, 1999: 58).

Belanger defines his role (and that of other e-learning pioneers) as “technology organizing”: “the bringing together of people and tools to create new forms of technology. Like community organizing it encourages people to take charge of their situation and use what is at hand to increase their social,

political, and economic influence. It squeezes out of the technical maelstrom democratic possibilities". (*ibid.*: 58).

The curiosity and drive to "squeeze" democratic possibilities out of the new communications technologies led Belanger to explore the early uses of microcomputers and, in 1983, to find a technician who helped install the first LAN in Canada (with the assistance of a small Utah firm called Novell). Belanger pursued new online communication opportunities:

But if microcomputers could be used to communicate within a building why could they not be used by other unionists to communicate nationally, even internationally? Couldn't we use microcomputers to involve unionists in online educational activities? I thought that it would be possible but was completely baffled about how it could be done. Then I read an ad in the New York Times. An organization called Connected Education, headed by Paul Levinson, was teaching online courses in conjunction with the New School for Social Research in New York. I enrolled and Paul taught me the basics of computer conferencing and how to use the medium for educational purposes. . . . I was able to earn a Master's in Media Studies completely online. There had to be a way, I hoped, to provide the same sort of educational opportunities to working people who could not afford to leave their jobs or take the time away from their families to attend night classes.

(*Ibid.*: 58–59)

Around 1983, the University of Guelph in Canada was developing the CoSy conferencing system, and a few faculty were involved in using it for course applications. As CUPE required a bilingual (English/French) system, Belanger worked with the CoSy team to produce a French and English interface for CoSy. The system, SoliNet, was opened to the labor community in 1985. The pedagogical model was based on collaborative learning: group discussions, seminars, and workshops.

SoliNet was used to teach courses and conduct workshops. These included conferences on technological change, pay equity, employment equity, health and safety, shop stewarding and other labour-oriented subjects. In 1991 SoliNet became the first labour-conferencing system to teach university credit courses. . . .

One of the conferences on SoliNet was called the Lounge. It was the central conference, which people could use to chat about anything on their minds. Early in SoliNet's history I tried to shut down the Lounge and steer people to a number of topic-specific conferences. Big mistake. My e-mail in-box was filled with messages objecting to what I was

proposing and my office was picketed! (Unionists are not shy people).  
It was then I realized that SoliNet had grown into a real community.  
(*Ibid.*: 59)

#### 2.2.1.4. Teacher Networking and Professional Development: (1983–)

This author's own involvement with e-learning began in the early 1980s, through research and the implementation of several projects that built on my previous efforts and commitment to collaborative learning and building knowledge communities globally (albeit in face-to-face contexts). Writing my doctoral dissertation at the Ontario Institute for Studies in Education (OISE) (the Graduate School of Education at the University of Toronto), I began to use e-mail in the 1970s and computer conferencing in the early 1980s. In 1983, I was hired to design and implement training for Ontario educators using the Canadian educational computer, the ICON. The ICON was a networked computer and enabled computer communications among the local users. These experiences showed me that teachers valued the opportunity to communicate, interact, and share ideas and resources beyond the classroom walls. And that computer networking suggested powerful potential for teacher professional development. How to design and apply computer networking for educational purposes was still very unclear, although the experiences with the networked ICON computers provided rudimentary promise.

The literature on e-learning was non-existent. Any book or article on networking that I could find focused on "networking" as the linking of one's computer to the printer—but nothing at all about linking users with other users.

In 1984, I obtained funding to study the potential of educational networking for teachers from the Ontario Ministry of Education. This project enabled me to research the literature, conduct needs assessment with teachers regarding their professional communication and networking problems and interests, obtain information on computer conferencing, and thereby to develop a framework for how computer networking could be used to advance educator needs and effectiveness (Harasim and Johnson, 1986). It also helped me to begin making connections in the fledgling area of educational computer networking and conferencing.

That year I also discovered the book *Network Nation* by Hiltz and Turoff (1978) while browsing in a Toronto bookstore. Reading it was a pivotal experience. I found substantiation, experience, history, and applications that directly addressed my interests in the potential for human communication and collaboration via computer networks.

(Harasim, 1999: 25)

In late 1984, Dr. Dorothy Smith and I undertook a project with the Ontario Ministry of Education, entitled: “Research into Developing Computer Networks for Women Educators”. Building on this research, in 1985 I sought and obtained funding from the Federation of Women Teachers Associations of Ontario (the FWTAO) to develop and implement “The Ontario Women Educators’ Computer Network: Online Participatory Research Project”.

The first Teacher Network project was launched in January 1986. Twenty female teachers from all the regions of Ontario (to respect geographical equity, even at a time when packet-switched networks did not) were selected by the teachers’ union to participate in a 12-week totally online course, together with 20 graduate students from OISE. The network of 20 teachers represents the first or one of the first online teacher and professional development networks.

Dorothy Smith collaborated with me on the design and implementation. My interest in collaborative learning complemented her own commitment to feminist pedagogy, and the first online non-formal course was based on a variety of small and large group activities such as discussion groups, plenary sessions, small project teams, and debates.

The results were very positive: both the teachers and the graduate students participated actively and regularly. Moreover, the distribution of communications was surprisingly evenly distributed: most people participated, and they participated more or less equitably. There was little or no domination by a few individuals. And potential differences (such as those between students taking the course for credit while teachers did not receive credit) did not create an imbalance in engagement, participation, or completing tasks. All participants were active 7 days a week, 24 hours a day. We used 150 or 300 bps modems. Today it sounds extremely primitive, but then it felt like rocket science (especially as one by one, each teacher decoded the bizarre formula for linking to the data network which was then still not public advertised or accessible). Nonetheless, even teachers living in remote regions of Ontario persevered, gained access and were highly active, with participants each sending at least five messages per week.

It was a tremendous learning experience for all involved, and helped to build credibility for online course delivery at the Institute. And in this case, the technological innovation was designed, launched, conducted, and employed by female educators.

### *2.2.2. Formal Education: Post-Secondary*

#### *2.2.2.1. Enhanced or Adjunct Mode Application*

Around the mid-1970s, soon after the invention of e-mail and of computer conferencing, DARPA and NSF scientists—including Murray

Turoff—began introducing these technologies into their university classrooms as part of the subject matter. But they soon discovered the potential value of CMC as not only content but also educational process.

Because we had the technology in operation a few of us who were involved with the research decided to use it to improve communications with our face-to-face classes. Much to our amazement we found that the technology allowed us to have insightful, reflective, and fascinating discussions with our classes that had never been possible in the face-to-face classroom. We were teaching technical courses in the areas of Computer Science and Information Systems. There was always so much to cover in lectures that very little discussion time was available. Furthermore, it was always the same, small percentage of the class that spoke up. Even though these are technical courses there is a great deal of pragmatic content in many of the upper division and graduate courses that deal with design tradeoffs. We found that when every student had a chance to reflect on their views and to compose their thoughts, the resulting discussion was fairly equally distributed.

(Turoff, 1999: 39)

Enhanced or adjunct mode e-learning (the use of the Net to enhance conventional f2f or distance education) was historically the first use of educational computer communications (e-mail and conferencing), and remains today the most typical entry point for faculty adopting e-learning.

Starr Roxanne Hiltz notes that a decade of experimentation with EIES as enhancement to the traditional classroom (TC) prefaced her work on the Virtual Classroom (VC) project in 1986 as a totally online course delivery application. “Before this formal field trial, we experimented with the use of computer conferences and messages to enhance the delivery of college-level courses, but ‘mixed’ it with 25% to 75% of the usual face-to-face classes”. (Hiltz, 1994: xvii).

#### 2.2.2.2. First Totally Online Undergraduate Courses

Starr Roxanne Hiltz, a pioneer of e-learning in post-secondary education, describes how she first came to visualizing and then realizing the VC.

The term (now trademarked by the New Jersey Institute of Technology) and the concept was first a gleam in its creator’s eye during a graduate seminar on the Sociology of Architecture, led by Professor Suzanne Keller at Princeton University in 1977. The final assignment was to design ‘an ideal classroom’ for the 21st century. First I sat down and started sketching a set of inter-connected physical spaces for different forums of interaction among people and knowledge resources. In this imagined learning environment there was a multi-media lecture hall, where

the Professor pronounces words of Truth and Knowledge, and students try to absorb this and take notes. In a sumptuously furnished circular “conversation pit” with leather couches and marble coffee tables, the Professor as Discussion Leader and Socrates would conduct seminar-type sessions, moderating discussions and presentations in which the majority of the talking was done by students. There was also a “learning resources” area, with reference materials, computer hardware and software, and perhaps laboratory equipment, where individuals and small groups of students might do research and prepare their assignments. There were obvious problems. How could you create a comfortable, upholstered discussion space for say, 30 people, without having to put in microphones so that participants could be heard across the huge circle without shouting? How could you possibly provide an adequate amount of computer and other resources, so that they would always be available to students in assignments, whenever they wanted them, without the endowment of a Princeton or Harvard?

Suddenly it came to me. A teaching and learning environment did not have to be built of bricks and boards. It could be constructed in software. It could be Virtual! In an era when many teachers and students have their own computers, it was no longer necessary for them to travel to a classroom. . . . The classroom could come to them. Over their telephone lines and through their computer.

(Hiltz, 1999: 31)

#### 2.2.2.3. First Totally Online Graduate Courses

Our efforts in online graduate course delivery at OISE (University of Toronto) occurred without knowledge of or collaboration with Hiltz’s VC activities or Levinson’s Connected Education efforts. Recall that e-learning activities in the early- to mid-1980s were very much independent and isolated efforts. There was unfortunately little or no educational confirmation, evidence or interest in educational computer networking, except by a few. One exception was a handful of researchers and faculty at OISE, working in different areas and on different perspectives of networking, who ultimately contributed major perspectives in educational networking.<sup>2</sup>

In launching the first graduate courses in 1985, there was neither literature nor models available. With one exception: I was able to find and invite Ward Deutschmann, then a Dean at New York Institute of Technology who had in 1984 integrated computer conferencing as adjunct mode into distance education courses. I invited Prof. Deutschmann to visit OISE in late 1985; a snowstorm reduced his visit to a few hours in the afternoon, but one major consequence was his enthusiasm for educational networking. Educational design of totally online courses was still unclear. But Deutschmann’s presentation

offered his professional judgement and experience that online education had value, which further fueled our resolve to explore and experiment with this new modality. One of the major outcomes and contributions was focus on our online delivery of graduate courses at OISE (rather than adjunct mode as in the NYIT example), and, in my own case, an totally continue emphasis on the design of learning activities and online environments to support various collaborative learning pedagogies.

The design of the online educational applications into different virtual spaces, each with specific functions and characteristics to support collaborative learning activities is one of the achievements that has been associated with my own theory and practice. I write this in hindsight based on feedback from other researchers and practitioners.

The online courses that I first designed and implemented in 1985, until today, use a variety of activities based on collaborative learning. For example, a totally online course may start and end with a set of plenary activities, to build the sense of group identity and community. Seminars, small group discussions, and small group assignments might comprise the core curriculum, each lasting for one online week or for a set number of online weeks. Courses designed and offered in the mid- to late 1980s at the OISE, illustrate this approach (Harasim, 1993). The courses were graduate level credit courses, with a limit of about 25 students to a course (although some were considerably smaller and a few significantly larger). The first activities were plenary group discussions. Topics included a conference for “Self-introductions”, a conference for setting personal and class “Learning Objectives”, and a conference for engaging in a “Great Debate”. And there was also the very important “Café” for socializing and a conference entitled “Mutual Assist” for peer technical help. The graduate courses employed the following types of group learning activities: Seminars (plenary and small group); Dyads; and Project Teams. The 12-week course was organized into 4 weeks of seminar activity, followed by 2 weeks of a dyad assignment; 4 weeks of project work and class presentations and concluded with 2 weeks of debates structured around dyad interaction. Between 35 and 60 computer conferences and sub-conferences were used to create the environment. The shape of the environment changed each week, as some topical conferences were closed, while new ones were opened.

*Learning Task.* The tasks and the groups changed, from plenaries to dyads to small group activities. The online course environment included perhaps 10 conferences for core discussions (plenary and small group); 10 for small work group presentations (with an equal number of work spaces); 10–15 conferences for dyad presentations (with an equal number of work spaces); 10–15 conferences for debating teams; and 6–10 spaces for informal conferences.

*Group Size.* Conference spaces were also defined by the size of learning group. The graduate courses that I designed and taught employed a fairly complex instructional design, involving plenaries, seminars, dyads, and small group activity. Plenary (full class) sessions were employed for group building,



especially for initial and concluding course activities. All the informal conferences were also designed as plenaries, to enable the entire course to “meet”. In a large-sized class (more than 20 students) or where there were distinct special interest or work groups, small group discussions helped manage the volume of online discussion. A conference for small group discussion typically had 8–15 students each; seminars might have 18–22 students. Group assignments and tasks were organized around small groups, usually with two to four persons per group. Dyads or learning partnerships are another design for online group work. In this design, two students are partnered either for a specific task/assignment or for peer support. Users were active in generating ideas and information: analysis of the online courses at OISE shows that graduate students averaged between 5 and 10 conference messages per week per person (electronic mail notes were not tracked, but were prolific). Thousands of messages were generated in the conferences over the 12 weeks online, representing a significant database of ideas and perspectives on various topics.

The online courses were distinguished by active peer-to-peer discussion and exchange. In the OISE online courses, students contributed 85–90% of messages, a level of student participation and interaction high even for face-to-face graduate seminars. The collaborative nature of the conferences is illustrated not only by the quantity of participation but by the quality of the interaction as well. Analysis of selected contents of the online courses indicates that learners formulated positions and responded to their peers with active questioning, elaboration, and/or debate. Transcript analysis of online seminars and small group activities showed that students build on one another’s ideas by posing and answering questions, clarifying ideas, expanding on or debating points raised by others. Message map analysis of interaction patterns in selected online discussions demonstrated that students refer to one another’s messages, adding on and building to the ideas posed (Winkelmans, 1988). Peer interaction, in which students are exposed to multiple perspectives on a particular topic as well as to being challenged by a question or expansion of their own ideas, offered a valuable opportunity for knowledge building and developing critical thinking skills (webb, 1989). Online activities facilitate such collegial exchange. Online interaction thus displayed fewer of the extremes typical of face-to-face class activity such as excessive or dominating input by a few and little or no participation by everyone else in the class. Online environments such as educational computer conferencing do not entirely eliminate domination by a few more vocal participants. What is new and different is that conferencing ensures that dominance by a few does not exclude the ability of others to have their say.

*Post-secondary Totally Online Programs (UoPhoenix Online).* Terri Hedegaard-Bishop was the major force behind putting complete degree programs online.<sup>3</sup> In the 1980s her employer, the University of Phoenix (UOP), began searching for new methods of providing greater access to education for its growing population of working adult students. The search was for new

pedagogical methods of distance delivery that were both institutionally altruistic (preserving the UOP model of highly collaborative and interactive learning and small class size), as well as enabling increasing access, outreach, and growth. In 1987, she encountered OCL.

As the new Vice President for Curriculum and Product Development, the search for an appropriate distance-learning model fell to me. I had rejected a series of technologies available at the time (satellite, video, CDROM), either because they were not cost-effective over the short shelf life of our courses, or because they were supportive of primarily didactic teaching methods. It was important to me and others that the University preserve its highly collaborative and interactive learning model, which included small class sizes and the extensive use of study-groups.

Sitting in a hotel room in Detroit Michigan while on a business trip, I received a call from my boss—the founder of the University of Phoenix Dr. John Sperling. He had heard about a person doing pioneering research on the use of computer mediated communication for educational delivery and he thought that I should take a flight up to Ontario, Canada “while I was in the neighborhood” and talk to this person. I called Linda Harasim and arranged to see her at the University of Toronto (Ontario Institute for Studies in Education) the very next day, having no idea of what I was about to discover.

(Hedegaard-Bishop, 1999: 20)

Hedegaard notes that while waiting for our meeting, she began to read my research papers.

So I sat there and began reading about the work she had been doing teaching graduate students using online computer mediated communication and found myself growing increasingly intrigued. I immediately recognized the strong convergence between UOP’s adult collaborative teaching/learning model and Linda’s online education model. Over lunch I fired question after question at Linda, searching for a “loop hole” or some indication that this learning model wouldn’t work on a larger scale. However, her confidence was contagious and convincing. It appeared to be the perfect match for the University of Phoenix.

(*Ibid.*)

As a next step, in 1988, Hedegaard formed a committee to design the online learning project,<sup>4</sup> exploring the concept, selecting a software program, designing the curriculum model, and testing theories by experimenting with the new online learning system. She introduced several innovations in her 1989 program, which still remain valuable lessons for the field:

- a) The degree program should be entirely online, not simply piece meal as in individual courses or parts of courses.
- b) Focus on and emphasize what is pedagogically possible and important. Some aspects of the f2f program, such as focus on oral presentation skills, were abandoned. “I didn’t see how it could be done in a truly effective way. The decision was to remove the objective entirely rather than doing it poorly”. (*Ibid.*: 20).

Hedegaard was a pioneer in her vision of quality education and student needs, taking difficult but important decisions regarding what she considered to be most possible, and most effective in online educational delivery. She committed to effective change, educational transformation, and success regardless of rocking the traditional academic boat. Her commitment was based on pedagogical principles, such as active collaborative learning, rather than the tradition of one-many (lecture hall or correspondence) education, a new pedagogical and programmatic model, which ultimately succeeded.

### 2.2.3. Formal Education: K-12 School Applications

#### 2.2.3.1. Enhanced Mode Applications (Networked Classrooms)

In the early 1980s, scarcely a decade after the invention of e-mail and of computer conferencing, teachers and students in public schools began to experiment with these exciting but still very complex telecommunications innovations. Their efforts resulted in a new modality of learning that can be termed the “Networked Classroom”, in which educational applications of computer networking are used to enhance the course curriculum.

In 1983, at the Versailles Economic Summit in France, Canada proposed to create an educational conferencing project linking selected public schools in Canada, the U.S.A., England, France, and Italy into online discussion groups related to geography, history, social and cultural issues, etc. The project, called RAPPI, was a breakthrough and success in that for the first time in human history classrooms (local, national, and international) were linked by computer communications, and online student relationships and group projects were facilitated. Electronic pen pals between schools and countries were created. A few classroom-to-classroom collaborations were also initiated. Some linkages were better than others, whereas several failed to materialize. Interestingly, among the most successful were linkages between schools in Canada and in Italy.

Reasons for the success are not clear. Since RAPPI was not a research project there was unfortunately little analysis or even documentation of the activities or their implications. My own casual observation of some of the

activities suggests that success stories resulted from significant teacher commitment and pedagogical structure. The development of “class projects” with clear goals and structures (such as group projects that involved class-based questionnaires or interviews, or structured history projects) seemed to characterize the most successful efforts.

In 1983, a group at the University of California, San Diego, began to use university networking equipment to link schools in various locations to form the InterCultural Learning Network.<sup>5</sup> “The goal was to explore how computer networking could be used to create new contexts for learning for elementary and secondary students and their teachers. The communication systems we used were difficult, expensive, and incredibly slow”. (Riel, 1999: 54). The ICLN was not linked in any way to RAPPI and neither group knew of the other. However, they each encountered similar challenges (as well as success) with the electronic pen pal approach.

Like many others, our first notions of how to use telecommunications in the classroom was to match students in one-to-one writing pairs with distant “computer-pals”. This task was difficult to manage with unequal numbers of students in each class in different locations. It was time consuming and frustrating as some, but not all, students heard from their partners. Most importantly, these friendly exchanges did not have extensive or sustained educational benefits. Personal communication did not stretch students capabilities and most letters, even from very distant places, carried very similar content. The few messages that did contain insightful views, cultural contrasts or valuable learning were narrowly directed to a single student. Telelearning needed educational structure.

(Riel, 1999: 54)

The lessons experienced by RAPPI reverberated in the ICLN activities and subsequent classroom network applications. Electronic pen pals were an interesting but naïve approach. They were certainly the major application that many teachers and schools attempted when first adopting e-learning during the 1980s and the early 1990s. Nonetheless, the complexity of the technology, the tremendous organizational effort required, and the ultimately disappointing outcomes of geographically distributed dyads led to the demise of this approach as a major educational application.

The ICLN began to incorporate a clearly defined educational research component and thus generated more clearly articulated lessons from the front lines of public school computer networking. Riel writes

We wanted to design models of cross-classroom communication that would help students participate in learning and teaching, sharing their diverse experiences, and reflect on both similarities and differences.

Learning tasks would have to integrate with differences in curriculum, fit into different school schedules, and work with students of different ages. Struggling with these constraints, we began to structure teaching and learning environments that made use of cross-classroom collaboration and group-to-group communication.

[1999: 54]

The ICLN activities began creating a newswire service, The Computer Chronicles, to which students could contribute and retrieve stories. Classrooms were able to contribute to an international school newspaper, with stories written on location around the world. The focus of the ICLN activities and research studied the value of an audience for student writing and a communicative purpose for writing.

Early research on this writing and editing process demonstrated remarkable student gains as a result of cross-classroom collaboration. These findings appeared on holistic scoring of writing and on standardized tests of reading and writing. We had found a meaningful context for promoting language art instruction. We also found that it provided for teachers a rich network of professional peers for thinking about different instructional practices and educational theories often in relation to the use of technology.

(Riel, 1999: 54)

#### 2.2.3.2. Mixed Mode Applications: The Southern Interior Telecommunications Project

Mixed mode (or blended mode) applications of e-learning refer to the integration of networking as a significant component of Traditional Classroom (or distance) education. The Southern Interior Telecommunications Project (SITP) of British Columbia, Canada, was designed to integrate computer networking with the school curriculum, rather than provide it as an “add-on activity”. The SITP project was launched in 1990 to link teachers and students in 50 primary and secondary schools of the Southern Interior of British Columbia. At that time the web did not yet exist and communication was done via text-only asynchronous conferencing. Teachers in primary and secondary schools integrated their curriculum with teachers in other schools, creating a networked classroom expanded over a wide geographical area. Students participating in the networked classroom did assignments and projects together, all related to the school curriculum and grade structure.

Among some of the exemplary networked classroom projects created by SITP teachers were the “Salmonids Online” and “Legal Beagles”. In these projects new ideas for online curriculum integration were explored, reformulating face-to-face pedagogical formats such as mentorship, cognitive

apprenticeship, ask-an-expert, peer interaction, role play, and collaborative learning into new e-learning processes.

The SITP project introduced new pedagogic and scientific approaches to classroom learning. The Salmonids Online project, for example, used peer interaction and “ask-an-expert” formats to expand the science of classroom salmon hatcheries in which students raised salmon eggs to the fry stage of development, and released them in the spring. The project was organized into three phases, fall, winter, and spring, following the natural salmonid activities that occur in the southern interior area. Through regular access to salmonid experts such as “Dr. Fish” (a world expert who volunteered his time and energy) and engagement in online peer conferences for sharing and analysis of data, student-based discussions such as *Salmon Around the World*, *Idea Spawning Bed*, and *Salmonid Chums* encouraged and enabled students to participate in high level scientific discourse and debate. A significant portion of the course grade was related to this online project.

A related but somewhat different approach to mixed mode e-learning was that of the Law 12 (Civic Education) course offered to Grade 12 students in the southern interior of BC. This course created the *Legal Beagle* space, designing online environments as settings for a variety of key class-related collaborative activities: online seminars, debates, and role plays (i.e., online trials, in which students were assigned roles such as judge, plaintiff, witness, etc.). Students were supported by a team of three lawyers who volunteered to assist the online project. What is of especial interest is that the online component, involving student collaboration and legal experts, was employed to compensate for the lack of a legal textbook for the course, thus providing a new model for student interaction and knowledge building with the knowledge community (Teles and Duxbury, 1991, 1992).

It is historically noteworthy that the SITP experiences and reports also served as the model for one of the first national educational networks. The SITP networked classroom models and reports were subsequently used to launch Canada’s Schoolnet project to connect all schools in Canada in 1993 (<http://www.schoolnet.ca>).

### 3. E-LEARNING RESEARCH: COMMUNITIES, PROJECTS, AND THEORY

#### 3.1. Research Communities

A key characteristic of e-learning practice, since the beginning of this new field, has been investment in research. The field moved from obscurity in the 1980s to skeptical recognition in the 1990s, to rapid acceptance in the 2000s. A significant contribution to e-learning’s growth, credibility, adoption, and general success has been the evidence base that grew out of the research that accompanied its emergence.

E-learning pioneers and practitioners by and large were active in the study and research of this new paradigm and educational domain. And this investment has provided a powerful and essential base of educational evidence for what works, what does not, for whom, and under what circumstances. Certainly e-learning is not a panacea; but then no e-learning pioneer has ever claimed as much. Traditional education (lecture halls, classrooms) has never fully addressed the effectiveness issue and there is little baseline evidence regarding learning processes, intellectual progress, or collaborative interaction and cognitive change in the f2f classroom or lecture hall.

The creation of e-learning research communities was a critical component to building the field, both in terms of providing the relevant evidence, the methodologies, and also in developing the knowledge community of experts. E-learning research has also made major contributions to learning theory and practice. Below are examples of early initiatives that helped to build a community of researchers and specialists in e-learning, particularly those focusing on post-secondary education.

#### *3.1.1. Guelph Symposia on Computer Conferences*

One of the earliest contributions to building a research base and community on computer conferencing was the Guelph Symposia on Computer Conferences. Three major Conferences in the 1980s attracted an international gathering of researchers, developers, educators, philosophers, and scientists from fields such as computer sciences, social sciences, and learning sciences. Participants came from Canada, the U.S.A, and Europe, catalyzing an incredibly vibrant and interdisciplinary “meeting of minds” in terms of the exposure to new communication approaches, technologies, disciplines, and perspectives. Participants had an opportunity to listen to and meet with the gurus in the field, as well as to encounter state-of-the-art experiments or work in very different fields.

The University of Guelph was a pioneer in computer conferencing, having built the CoSy (COnferencing SYstem) in 1983, and then promoting the sharing of technical, theoretical, research, and practical knowledge in the field. Three major conferences were held: the First Guelph Symposium on Computer Conferences (January, 1985); the Second Guelph Symposium on Computer Conferencing (June, 1987); and the Third Guelph Symposium on Computer-Mediated Communications (May, 1990).

#### *3.1.2. American Educational Research Association*

A major venue for e-learning research was the American Educational Research Association (AERA). Beginning in the mid-1980s, a small

number of educational researchers dedicated to e-learning [under such titles as educational computer-mediated communication (CMC), educational computer conferencing, network learning, etc.] began to present their research at the annual AERA conferences and soon formed a community. These sessions were initially small panel and poster presentations, mostly to kindred spirits. During the 1980s those of us in e-learning were by and large lone rangers who encountered colleagues and relevant data at these venues. We came to know one another, and to create a mental map [and connection to] researchers and implementers of e-learning in K-12 and [to a lesser extent, post-secondary] environments in North America and Europe.

It may seem surprising, but in the mid- to late 1980s it was possible to know about most of the e-learning experiments and efforts in the U.S.A., Canada, and Europe. We were so few in number, that when a group came together, between those present and their own connections, it was possible to map out many if not most of the e-learning activities in existence.

### 3.1.3. *Online Education: Perspectives on a New Environment*

In the mid-1980s, this author recognized the need to advance the field of online education “by presenting theoretical, design, and methodological perspectives that can help us to better understand, use, and benefit from computer-mediated communication (CMC). Online education already exists as a field of practice; there is an urgent need, now, to build a research discipline and knowledge base to guide research, practical and technical developments in the new field”. (Harasim, 1990, xv).

The need to establish and set down foundations was clear. The mechanism identified was to develop an online community of e-learning experts, who would each lead an online seminar on a topic of their expertise which would then form the kernel of a chapter for an edited book: *Online Education: Perspectives on a New Environment*, published in 1990.

*Online Education* is itself the product of an online educational collaboration. The need to build a scholarly community and discipline for studying, developing, and promoting online education was acknowledged in 1986–87 in the “Online Educational Research Workshop,” which brought “together,” on a computer conferencing system, twenty educators from Canada, the United States, and the United Kingdom. Over a period of almost three months, participants explored and developed ten perspectives on online education. These ten topics have been refined into the chapters that make up this book.”

(Harasim, 1990: xv)



The book was published and another link in the community was established. The community did not remain an ongoing set of online seminars, but for many of us became an important professional and social network that continued to share and to communicate and to help build the field, using online and face-to-face conferences and meetings.

#### 3.1.4. *Mindweave: Communication, Computers, and Distance Education*

An initiative that was somewhat similar to the *Online Education* seminars and book was the face-to-face conference on CMC in Distance Education, organized at the British Open University's main campus in Milton Keynes, launched in October 1988. The result was a book (*Mindweave*) based on the plenary presentations and the poster sessions. And also a further building of the community and the field. Half of the chapter authors from Harasim's *Online Education*, were again featured in Mason and Kaye's *Mindweave*, further building the community and the dialogues/debates.

A quote from *Mindweave* evinces the newness of the field and the need for community and both theoretical and practical analyses. The book addresses both existing practitioners, but especially those new to the field. Consider the infancy of the field when an asynchronous conversation among five learners is highlighted.

For those readers who are wondering why we believe computer-mediated communication will have such an important role to play in distance education, we recommend the Prologue. This is a transcript of a 'conversation' on the Open University's CoSy conferencing system between five of the most enthusiastic users of CMC on this course—students based respectively in London, Cambridge, Birmingham, Preston, and Troon (in Scotland). Without CoSy, they would never have met each other, 'electronically' or otherwise. We believe they are among the pioneers in the use of this technology for learning at a distance. *Mindweave* is dedicated to an exploration of the ways in which benefits of computer-mediated communication, as experienced by these students, can be made more widely available to adult distance learners.

(Kaye and Mason, 1989: vii)

### 3.2. Research Projects

Beginning in the 1980s, a handful of major research projects were launched that helped to scope out the field and to provide a knowledge base, and a landscape of data that could influence policy, contribute to practitioner knowledge

transfer, and help to build the field. While many conferences and research activities began to populate the field, here we identify three key examples.

### *3.2.1. Virtual Classroom Project (1986–1987; 1987–1992)*

The Virtual Classroom (VC) research project was the first set of significant large studies of e-learning, especially in post-secondary education. And as such it provided an important touchstone for e-learning researchers and practitioners. The project offered valuable methodological contributions to the study of e-learning: at that time, the need to “prove” that the VC was “as good as” the Traditional Classroom (TC) for mastery of facts and information called for a traditional evaluation based on experimental and quasi-experimental design (comparing courses matched with the same teacher, texts, and tests in VC and TC modes) (Hiltz, 1994). In addition, the evaluation instruments were made available to other investigators. The project also contributed valuable data about e-learning software and teaching techniques, providing a base of empirical evidence that significantly helped to advance the field.

It is perhaps surprising to recall that as recently as late 1980s, the big question was whether it was even possible to use computer communication for educational access and effectiveness. In 1990, Hiltz, the VC Project Leader, wrote

The primary goal of the project “Tools for the Enhancement and Evaluation of a Virtual Classroom” is to explore whether it is possible to use communication systems to improve access to and effectiveness of postsecondary educational delivery. The most important “product” of the project is knowledge about the advantages and disadvantages of this new technology, as they may be influenced by variations in student characteristics and implementation techniques and settings. Evaluation is as important as software development for the Virtual Classroom project. The two key questions are the following:

1. Is the Virtual Classroom a viable option for educational delivery? That is, are outcomes, on the whole, at least as good as outcomes for traditional face-to-face courses?
2. What variables are associated with especially good and especially poor outcomes in this new teaching and learning environment?

(Hiltz, 1990: 133)

### *3.2.2. Virtual University Project, TeleLearning Network of Centers of Excellence (1996–2002)*

The Virtual-U field trials were the first large-scale field studies of online post-secondary education. Over 1500 students, 250 faculty and 500 totally online

and mixed mode courses were involved in the study of e-learning in Canadian, American, and European universities who adopted the Virtual-U LMS system between 1996 and 2002. The focus was on the pedagogical implications rather than specific technological features.

The results of these field studies provided a profile or overview of the state of the art in the post-secondary e-learning in the late 1990s and the early 2000s. Data on levels of participation, interaction, completion, learner and faculty satisfaction, pedagogic approaches employed, assessment strategies used, and academic disciplines helped to create a kind of map of e-learning: who was doing it? How were they doing it? And what were the results?

The results of these field studies offered a glimpse into the new online world that was unfolding in education, and contributed to knowledge about what it was about. Not in a great deal of granularity but nonetheless, as in the 15th century maps of China and Europe, the Virtual-U field studies began to identify some of the e-learning landscape that might lay ahead and thus provide educators, administrators, and policy makers with some navigational landmarks and tools. And like other pioneering efforts, helped to demonstrate that the world was not flat.

### 3.2.3. Sloan-C

The Alfred P. Sloan Foundation became active in promoting the adoption and advancing the effectiveness of e-learning in 1992, with its program in Learning Outside the Classroom. One of the major mechanisms has been the Sloan Consortium (also known as Sloan-C) and the provision of large grants to institutions to catalyze the adoption of e-learning [or in their terms Asynchronous Learning Networks (ALN)] as well as providing financial support for e-learning research and dissemination of results. Since 1999, a series of case studies and empirical research by selected faculty and researchers has been published in a special set of monographs (that present the case studies plus peer reviews) and also in special issues of the *Journal of Asynchronous Learning Networks*. Research is conducted within what Mayadas, the Sloan Program Director identifies as the “Five Pillars of ALN” (<http://www.aln.org/publications/books>):

- Learning effectiveness
- Faculty satisfaction
- Student satisfaction
- Cost effectiveness
- Access

In addition, the Sloan Foundation funded the [WebCenter for Learning Networks Effectiveness Research](http://www.alnresearch.org/index.jsp) (<http://www.alnresearch.org/index.jsp>), a

series of online knowledge bases available to researchers, faculty, the press, and the public. The goal of this research program has been to increase the quality, quantity, and dissemination of results of research on the effectiveness of ALN. It does this by synthesizing existing knowledge and creating new knowledge about the methods and findings of research on the determinants of effectiveness of ALN. A secondary goal of the site is to build and strengthen the ALN evaluation research community to create and share improved research methods, theoretical frameworks, and instrumentation for assessing the outcomes of online learning.

### **3.3. Research Theory**

The principle of collaborative learning may be the single most important factor for online networked learning, since it is this principle which provides the strong socio-affective and cognitive power of learning on the web. It may be argued that the online asynchronous environment of the web both enables and requires collaborative learning: collaboration provides the motivation and social glue of a community that engages learners and encourages them to participate and contribute to common goals. Instructional models where faculty “present” or publish information on the web are less engaging and have resulted in higher drop out rates.

Educational applications of computer networking have led to major insights in collaborative learning, knowledge communities, and knowledge construction. Hiltz and Turoff (1978) pioneered the use of computer conferencing and networking in linking communities of scientists into online discussion and workgroups. By the early 1980s, educational networking based on collaborative learning was launched and became the basis for future models: totally online short courses, networked classrooms in schools, online programs for executives, online university courses, virtual classrooms, online training programs, etc. (Harasim et al., 1995). Related fields such as online communities of practice (Lave & Wenger, 1991), computer-supported co-operative work and collaborative learning (Koschmann, 1996), knowledge building networks (Scardamalia and Bereiter, 1993), virtual classrooms (Hiltz, 1994), and learning networks (Harasim et al., 1995) have flourished.

Online network models tend to be constructional or conversational, with discourse and teamwork motivating a sense of commitment. Engaging learners in a co-operative pursuit of knowledge requires new instructor roles. Cognitive growth and the development of problem-solving skills depend on epistemic conflict, that is, the collision of adverse opinion. Students encounter opportunities to experience and resolve academic controversies in the online discourse environment.

Bruffe (1999) describes collaborative learning as a process that helps students become members of knowledge communities, where by they

learn to construct knowledge as it is constructed in the knowledge communities they hope to join after attending colleges and universities: the knowledge communities of industry, business, finance, government, academic disciplines, and public professions such as medicine, accounting and public law. With no loss of respect for the value of expertise, they learn to depend on one another rather than depending exclusively on the authority of experts and teachers. Most important, in collaborative learning students learn the craft of interdependence.

(Bruffee, 1999: xiii)

Harasim's (1990, 2002) model of conceptual change focuses on collaborative learning in the online (web-based) discourse environment, identifying three processes/phases that describe the path from divergent to convergent thinking. Collaboration is viewed as a key process in conceptual change. Although identified and developed in the online context, it resonates with Bruffee's theoretical position that intellectual convergence through collaborative discourse is key and suggests a framework for understanding discourse in online seminars.

The three cognitive phases involved in intellectual development and collaborative learning are

- 1) *Idea generating*: Idea generating implies divergent thinking, brainstorming, verbalization, and thus sharing of ideas and positions. Participants engage and contribute. Indicators include verbalization, offering input, generating information, and generally democratic participation. It involves multiple monologs as each participant presents her or his view on the topic.
- 2) *Idea linking*: The second process, idea linking, provides evidence of conceptual change and intellectual progress as new or different ideas become clarified, identified, and clustered into various positions (agreement/disagreement; questioning/elaboration), based on access to resources linked to the knowledge community such as the readings and/or input from the instructor. This is an early form of convergence, a mutual contribution to and construction of shared knowledge and understanding advancing from opinions to the use of analytical concepts. This phase involves organizing and elaborating various ideas into intellectual positions or clusters, demonstrating intellectual progress through recognizing multiple perspectives and how these relate or not to one another.
- 3) *Intellectual convergence*: The third phase, intellectual convergence, is typically reflected in shared understanding (including agreeing to disagree) and is especially evident in co-production, whether the product is a theory, a publication, an assignment, a work of art, or a similar output authored by the group or sub-group. Idea structuring, through gradual convergence, reaches a level of intellectual synthesis, understanding and consensus, and employs and applies the analytical framework of the knowledge community on that topic

These three phases can also be applied as categories for the study of learning and intellectual progress in online discourse. Transcript analysis of student discourse in online courses can study the existence of intellectual progress and conceptual change over time, and under particular conditions (pedagogical design? role of the instructor? etc.). A major and unprecedented advantage of e-learning is the existence of the verbatim archive of student discourse (especially in totally online courses) which is an artifact of student understanding. Over the course of an online course, it is expected that students would progress from individual opinions (Phase 1) to begin to grasp and apply the theoretical and analytical terms when discussing problems (Phase 2), to actually applying these analytical terms in problem solving or knowledge building of new solutions (Phase 3) (Harasim, 1990).

#### 4. LESSONS LEARNED: EMERGENT MODES AND MODELS

One of the major “lessons learned” through the first three decades of e-learning is its potential to be more than “as good as” TC learning but to provide far superior quality of learning. Well designed and implemented collaborative e-learning represents powerful gains in key indicators such as learning effectiveness, educational access, satisfaction by instructors and learners, completion rates, and institutional and workplace innovation.

##### 4.1. Learning Effectiveness

A common approach to examine the quality of learning effectiveness is whether the quality of learning in the e-learning environment has been demonstrated and perceived to be *at the same level of quality or better* than non-e-learning (i.e., TC or distance education) environments. Certainly the goal is that e-learning would provide a better environment for learning (Mayadas, 2002). Hence, a key research question is what are the indicators of success for e-learning environments? What does a knowledge economy require in terms of learning processes and outcomes? Clearly an e-learning environment should be designed to be *more effective*, not less, than what is traditionally available. Traditional success indicators have included such measures as data on completion rates, grades, faculty reports, and learner reports. And as major research studies have reported, the findings have been very positive.

New indicators such as level, volume, and patterns of interactivity and participation are illuminating patterns of participation, under various contexts (pedagogic approaches, disciplines, instructor roles, etc.), and over time.

Potentially more powerful are the insights into advanced learning effectiveness and intellectual progress generated by analyses of transcripts of student

discourse in online seminars and group activities whereby researchers and instructors can study conceptual change and improvement over time by individual and group participants. Transcript analysis enables scientific study of what occurs, both to deepen learning sciences, and to provide feedback on intellectual progress under various conditions and contexts. Moreover, analyses of usage data/participation records provide additional empirical evidence of such indicators as active reading, active writing, level of participation and interaction, distribution of communication, referencing other messages, etc.

#### 4.2. Access: Geographical and Temporal

Student access is a critical goal of education and has a number of aspects. One aspect is geographical: here e-learning has shown a tremendous advantage. Today the internet is available virtually worldwide, although politics more than economics remains a challenge to equitable access. One important goal or indicator of e-learning success is that all students who are able and motivated can obtain a course and/or degree program in their area of choice online.

Another key aspect is temporal or asynchronous access. Asynchronous (24/7) access enables a number of benefits for effective learning, enabling mindful composition of input, access to references, ability to reflect on or reread messages, and a more equitable distribution of communication since everyone has access to the air time that they need. Students do in fact access the learning activities 24 hours a day, 7 days a week.

This leads to highly active participation and interaction. An analysis of 64 courses in the Virtual-U field trials found that:

- 77% of the classes had active students, who log in at least 10 times per week on average;
- 85% of the students in all classes logged in regularly, at least five times per week; and
- 81% of the students in all classes posted regularly, writing at least three messages per week.

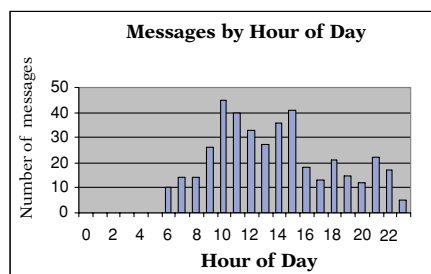
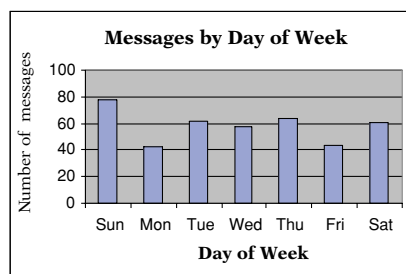

#### **4.3. Satisfaction Rates: Faculty and Learners**

Faculty satisfaction refers to experiences of faculty who engage in e-learning: do they feel engaged and more involved as a result of this experience? Do they experience increased fulfillment as educators? Would they continue to teach online? Will they incorporate e-learning approaches into their f2f classes? Encourage other educators to become e-learning faculty? A recent study of 255 faculty using collaborative e-learning in 31 colleges in the State University of New York system examined the effects of conceptualizing, developing, and teaching a complete online course and found:

- 96% of faculty expressed general satisfaction;
- 74% believed that learning online is equivalent to or better than in other modes;
- 88% believe that interaction among students was equivalent or higher online; and
- 62% believe that they know their students as well or better online. (Shea et al., 2002: 103).

There is frequently a change in instructional approaches and roles by instructors who begin to teach online. Many begin to adopt collaborative learning approaches. In a study of 100 online courses in the Virtual-U field trials (offered by universities in Canada, Europe, and the U.S.A.), it was found that 100% of the instructors had introduced some form of collaborative learning activity (typically group discussions or group projects or both) into their course. Many instructors reported that teaching online improved their teaching approaches in f2f classes as well, and that the positive experiences in online teaching lead to “teacher revitalization”.

Students are very positive about online courses with collaborative learning approaches: in the Virtual-U trials, 85% of students in 32 totally online classes reported that the learning experience offered by online courses was as positive or more positive than the classroom experience (Harasim, 2000).

#### **4.4. Completion Rates**

Completion rates are viewed as one, very strong indicator of academic success, of user satisfaction, and of the quality of the education offered, particularly in post-secondary (university and college) and corporate training. Research has identified high completion rates of e-learning based on OCL, at all educational levels and sectors. At the post-secondary level, the Virtual-U field studies identified completion rates of 92% completion rates in the 64 online courses studied (Harasim, 2000); Pace University reports 90% completion (Sachs, 2003), and the larger Sloan-C Post-secondary Consortium has 85% completion rates for e-learning courses (Sloan-C). E-learning



delivery of post-secondary degrees to the workplace (NACTEL) resulted in 96% completion rates (Sachs, 2003). The Concord Consortium Virtual High School (VHS) notes an 80% completion rate, with the following qualitative comments:

VHS students consistently report feeling closer to and better acquainted with their online teachers than with their local teachers. I have heard similar reports from higher education faculty who teach online courses. We also have had reports that VHS has kept potential dropouts interested in school. VHS teachers say that their online teaching experiences have positively affected their face-to-face teaching. On the other hand, asynchronous course delivery, which is the VHS model, consistently has a 20% dropout rate which needs to be investigated.

(Rose, 1999)

In contrast, the use of online networks to facilitate correspondence education (ODE) results in completion rates of around 60%, while the use of the OCBT model typically results in a completion rate of 20–30% (Carr, 2000; Diaz, 2002).

#### **4.5. Pedagogical, Institutional and Workplace Innovation**

A key lesson regards the encouragement of pedagogical renewal and enhancement through the introduction of networked technologies, to provide students and faculty with opportunities for 21st century skills like knowledge work, collaborative learning, etc. E-learning is already becoming such an enabler in Canada, the U.S.A., Europe, and Latin America. The Minister of Education, Mexico, referred to e-learning as a “Trojan Horse”: faculty who adopted e-learning become motivated to adopt new pedagogical practices, and as a result of this experience, transform their curriculum from knowledge transmission (lecture mode) to collaborative learning and knowledge work modes.

The introduction of new technologies and new educational practices also provides important opportunities for institutional renewal, which will be critical to maintaining its reputation and for survival in an increasingly competitive marketplace.

#### **CONCLUSION: SHIFT HAPPENED**

This chapter has provided a brief overview of the early history of e-learning, identifying some highlights and experiences of this period and outlining the

changing educational paradigm as the use of computer networking shifted from being experimental to becoming the educational NORM.

E-learning was invented in the mid- to late 1970s, a few short years after the development of packet-switched e-mail and computer conferencing. Within two decades, profound transformations in the field of education itself were evident as e-learning became not only a new educational option to that of TC or distance education, but was also integrated into these traditional forms of education, thereby transforming the entire field. Some examples of the shift.

*1. Changing Educational Models: Passive Competitive to Active Collaborative.* The invention or emergence of e-learning has transformed the basic model of education, emphasizing new educational principles, and practice based on *active, collaborative learning*. The educational models of the 19th and 20th century, based on *principles of passive and competitive approaches* to education have been transformed into models of *active collaborative learning* where students engage in group discourse and team projects. The traditional model of *knowledge transmission*, in which the instructor is seen as the sole or primary font of knowledge that is to be transmitted to the students (didactic approaches), is now being replaced by a *knowledge building model* in which learners engage in problem solving and decision making to innovate new solutions. Learners are increasingly encouraged to learn by participating in small and large group discussions, to employ the terms and analytical methods of their chosen fields to solving problems and making decisions increasingly akin to the methods of their knowledge community. The role of the professor is to not simply ensure student memorization of the analytical terms and approach, but the ability to apply these appropriately, thereby facilitating the student's membership in the knowledge community of his/her choice. Furthermore, learner-centered educational models and pedagogies are thus replacing the teacher-centered models of the past.

*2. Changing Educational Environments: Closed Individualized to Open Networked.* A second transformation or shift is a major change in the educational "environment" that learners and educators inhabit. The introduction of networking technologies into the public sphere, globally, has transformed personal, social, and economic reality. And has transformed education from the traditional *closed community* of the classroom or lecture hall (or the individualized workspace for distance learners) into a porous interactive *knowledge network*, where online resources, expertise, and peers are routinely sought.

Moreover, *e-learning environments* (also referred to as Learning Management Systems) that explicitly support new educational models and principles, are being developed to provide frameworks, tools, scaffolds, etc. to support and/or assess collaborative learning, knowledge building, problem solving, intellectual progress, etc. A relatively recent technological innovation, *Open*

*Source*, is contributing to the development of a new range of learning environments and tools that are free and which encourage ongoing development and refinement by the open availability of the source code to all users. Such initiatives have the potential to offer the educational community with much needed new tools and resources, as well as encourage innovation and input from users worldwide.

3. *Changing Educational Role: Supplementary to Integral*. The educational role of e-learning shifted dramatically during its early decades, moving from being viewed and used as supplementary (at best) to becoming an integral component of all or most learning activities.

Despite the pioneering applications of totally online classrooms for undergraduate, graduate, executive, and labor education in the 1980s, the vast majority of e-learning applications in the 1980s and 1990s could be classified as “adjunct (enhanced) mode”. School-based applications emphasized such e-learning activities as “electronic pen pals”, electronic field trips, “ask-an-expert”, and Q&A forums. University applications tended to focus on student e-mail to professors, online submission of assignments, web searches for research data, online quizzes, or grade books.

By the late 1990s, the use of e-learning had matured from *supplementary* to being *an integral part* of the course or program curriculum. The use of networking is increasingly a significant portion of the curriculum and grade, and most importantly, the use of e-learning moved from being the effort of a single professor or teacher (a lone ranger) to the institutionalization of e-learning, involving online courses, online degree or professional programs, and virtual universities in which the educational administration allocates a permanent budget line for training, software, and support, thereby representing an institutional commitment to quality e-learning.

4. *Changing Societal Role: Peripheral to Mainstream*. The major shift has occurred in e-learning’s changing societal role and status. E-learning has moved from a position on the periphery of social recognition, which it occupied in the 1980s and 1990s, to mainstream acceptance and demand. Indeed, the availability of e-learning pedagogies and technologies is becoming an indicator of state-of-the-art education. Students, parents, professionals, and educators have come to view the level and commitment to e-learning as an indicator of success for educational providers.

Today, e-learning impacts all educational sectors, from formal (primary, secondary, and tertiary education) to non-formal (professional development, workplace training, corporate education) and increasingly informal lifelong experiential learning.

E-learning has become an integral, valuable, and highly valued component of education, and standard-bearer for state-of-the-art learning and teaching as we advance into the 21st century.

As a recent study of e-learning in the United States reported

From the Ivy League to tiny community colleges, a majority of institutes of higher education say online learning is just as good as traditional, face-to-face classroom instruction. Nearly three out of four academic leaders say learning online may be better within three years. A comprehensive survey . . . concludes that online learning is at historically high levels and will continue to grow at a rate of nearly 20%.

(Allen and Seaman, 2003: <http://www.aln.org/resources/survey.asp>)

The 2003 Sloan Survey of Online Learning polled academic leaders and was weighted to allow for inferences about all degree-granting institutions open to the public. When asked to compare the online learning outcomes with those of face-to-face instruction a majority said they are equal. Two out of every three also responded that online learning is critical to their long-term strategy.

The field of e-learning, born a mere 25 years ago in the mid- to late 1970s with the very invention of computer networking and communications has become a major force in education and society, engaging over 10% of post-secondary education students in the U.S.A. It is in the midst of transforming education, shifting the educational paradigm, as we have known it for the past three centuries.

As recently as 10–15 years ago, e-learning was unknown or dismissed. Today it is transcending the goal of being “as good as” traditional education to demonstrating the possibility and effectiveness of educational approaches and processes far better and beyond what has hitherto been possible or anticipated.

#### ENDNOTES

1. The chapter highlights some of the key pioneering applications in elearning. The author is grateful for suggestions on missing links.
2. This included cutting edge research and practice in online graduate level course delivery (Harasim and Smith, Davie), as well as online hypertextual design (Wolfe, 1990), and knowledge building (Scardamalia and Bereiter, 1993).
3. Paul Levinson’s Master’s program, Connected Education, begun in 1985 and offered through the New School of Social Research, was the first totally online graduate program. The program however was small in student numbers and relatively short lived.
4. Initial team members were Eileen Aranda, Beth Aguiar, Gerry Bedore, Linda Harasim, and Richard Housley.
5. The ICLN researchers included Margaret Riel (USA), Jim Levin (USA), Moshe Cohen (Israel), and Naomi Miyake (Japan), each of whom were studying/working at UCSD at that time.

## REFERENCES

- Allen, I. E. & Seaman, J. (2003). *Sizing the Opportunity: The Quality and Extent of Online Education in the US, 2002 and 2003*. Needham, MA: Sloan-C and Sloan Center for OnLine Education (SCOLE), <http://www.aln.org/resources/survey.asp>.
- Belanger, M. (1999). Worker education pioneers: technology organizing in Canada. In: Harasim, L. (Ed.) *Wisdom and Wizardry: Celebrating the Pioneers of Online Education*. Vancouver, Canada: TeleLearning Network of Centers of Excellence, 57–60.
- Bruffee, K. A. (1999). *Collaborative Learning: Higher Education, Interdependence, and the Authority of Knowledge*, 2nd ed. Baltimore, MD: John Hopkins University Press.
- Carr, S. (2000). As distance education comes of age, the challenge is keeping the students: Colleges are using online courses to raise enrollment, but retaining it is another matter. *Chronicle of Higher Education, Information Technology*.
- Coombs, P. H. & Ahmed, M. (1974). *Attacking Rural Poverty: How Nonformal Education Can Help*. Baltimore: Johns Hopkins University Press.
- Diaz, D. P. (May/June 2002). Online Drop Rates Revisited. The Technology Source. <http://ts.mivu.org/default.asp?show=article&id=981>.
- Feenberg, A. (1993). Building a global network: the WBSI executive education experience. In: Harasim, L. (Ed.) *Global Networks: Computers and International Communication*. Cambridge: MIT Press.
- Hafner, K. & Lyon, M. (1996). *Where Wizards Stay up Late: The Origins of the Internet*. New York, NY: Simon and Schuster.
- Harasim, L. (1990). Online education: an environment for collaboration and intellectual amplification. In: Harasim, L. (Ed.) *Online Education: Perspectives on a New Environment*. New York: Praeger, 39–66.
- Harasim, L. (1993). Collaborating in cyberspace: using computer conferences as a group learning environment. *Interactive Learning Environments* 3(2):119–130.
- Harasim, L. (1999). Pioneers in post-secondary online education. In: Harasim, L. (Ed.) *Wisdom and Wizardry: Celebrating the Pioneers of Online Education* Vancouver, Canada: TeleLearning Network of Centers of Excellence, 23–28.
- Harasim, L. (2002). What makes online learning communities successful? The role of collaborative learning in social and intellectual development. In: Vrasidas, C. and Glass, G. V. (Eds.) *Distance Education and Distributed Learning: Current Perspectives on Applied Information Technology Series*. Greenwich, CT: Information Age Publishers, 181–200.
- Harasim, L. (2003). The case for online collaborative learning. *Proceedings of the Korean Society of Educational Technology*, June, Seoul, Korea.
- Harasim, L., Hiltz, R., Teles, L., & Turoff, M. (1995). *Learning Networks: A Field Guide to Teaching and Learning Online*. Cambridge, MA: MIT Press.
- Harasim, L. & Johnson, M. E. (1986). *Research on the Educational Applications of Computer Networks for Teachers/Trainers in Ontario*.
- Hedegaard-Bishop, T. (1999). Clearing the path for putting complete degree programs online. In: Harasim, L. (Ed.) *Wisdom and Wizardry: Celebrating the Pioneers of Online Education*. Vancouver, Canada: TeleLearning Network of Centers of Excellence, 19–22.
- Hiltz, S. R. (1990). Evaluating the virtual classroom. In: Harasim, L. (Ed.) *Online Education: Perspectives on a New Environment*, New York: Praeger Press, 133–183.
- Hiltz, S. R. (1994). *The Virtual Classroom: Learning without Limits via Computer Networks*. Norwood, NJ: Ablex Publishing.
- Hiltz, S. R. (1999). Visions of virtual classrooms. In: Harasim, L. (Ed.) *Wisdom and Wizardry: Celebrating the Pioneers of Online Education*. Vancouver, Canada: TeleLearning Network of Centers of Excellence, 29–32.

- Hiltz, S. R. & Turoff, M. (1978). *The Network Nation: Human Communication via Computer*. Reading, MA: Addison-Wesley Publishing Co, Inc.
- Kaye, A. & Mason, R. (1989). Prologue: students 'conversing' about computer-mediated communication. In: Mason, R. and Kaye, A. (Eds.) *Mindweave: Communication, Computers and Distance Education*. Oxford: Pergamon Press.
- Koschmann, T. (1996). *CSCL: Theory and Practice of an Emerging Paradigm*. Mahwah, New Jersey: Lawrence Erlbaum.
- Lave, J. & Wenger, E. (1991). *Situated Learning: Legitimate Peripheral Participation*. Cambridge: University of Cambridge Press.
- Mayadas, F., Bourne, J., & Janet, M. (2002). Introduction. In: Bourne, J. and Moore, J. (Eds.) *Elements of Quality Online Education*. Vol. 3c.
- Riel, M. (1999). Looking back and moving forward—stories from the field. In: Harasim, L. (Ed.) *Wisdom and Wizardry: Celebrating the Pioneers of Online Education*. Vancouver, Canada: TeleLearning Network of Centers of Excellence, 54–56.
- Roschelleo, J. (1996). Learning by collaborating: convergent conceptual change. In: Koschmann, T. (Ed.) *CSCL: Theory and practice of an emerging paradigm*. Mahwah: Lawrence Erlbaum Associates, 209–248.
- Rose, R. (1999). Speaking up for online education. Pressure grows in education to define what it is and what it isn't. Available Online: <<http://www.concord.org/newsletter/1999spring/speakingup.html>><http://www.concord.org/newsletter/1999spring/speakingup.html>.
- Sachs, D. (2003). Pace university focus on student satisfaction with student services in online education. *Journal of Asynchronous Learning*, 7:2.
- Scardamalia, M. & Bereiter, C. (1993). Technologies for knowledge-building discourse. *Communications of the ACM* 36(5), 37–41.
- Shea, P. J., Pelz, W., Fredericksen, E., & Pickett, A. M. (2002). Online teaching as a catalyst for classroom-based instructional transformation. In: Bourne, J. and Moore, J. (Eds.) *Elements of Quality Online Education*, Vol. 3. Needham, MA: Sloan Center for OnLine Education (SCOLE).
- Teles, L. & Duxbury, N. (1991). *The Networked Classroom: An Assessment of the Southern Interior Telecommunications Project*. Canada: Faculty of Education, Simon Fraser University.
- Teles, L. & Duxbury, N. (1992). *The Networked Classroom: Creating and Online Environment for K-12 Education*. Canada: Faculty of Education, Simon Fraser University.
- Turoff, M. (1999). The question determines the answer! A historical perspective. In: Harasim, L. (Ed.) *Wisdom & Wizardry: Celebrating the Pioneers of Online Education*. Vancouver, Canada: TeleLearning Network of Centers of Excellence, 39–44.
- Vallee, J. (1982). *The Network Revolution*. Berkeley, California: And/Or Press.
- Winkelmans, T. (1988). *Educational Computer Conferencing: An Application of Analysis Methodologies to a Structured Small Group Activity*. Unpublished MA Thesis, University of Toronto.
- Wolfe, R. (1990). Hypertextual perspectives on educational computer conferencing. In: Harasim, L. M. (Ed.) *Online Education: Perspectives on a New Environment*. New York: Praeger Press, 215–228.

## Chapter 3: Towards Philosophy of Technology in Education: Mapping the Field

MICHAEL A. PETERS

*Department of Educational Policy Studies, University of Illinois at Urbana-Champaign, 360 Educational Building, 1310 South Sixth Street, Champaign, IL 61820*

### 1. INTRODUCTION

Technology has become the new star ship in the policy fleet for governments around the world. While often conceptually inchoate and ill-defined, technology studies figures as a new subject in national curricula, often as part of the new core. Also technology as a subject is promoted in higher education, including teacher education programmes, as part of a thrust to develop links with industry and business in a series of new venture partnerships. The emphasis on technology in education also accords with initiatives to promote greater entrepreneurial skills and activity within so-called national systems of innovation. What is more, technology planning often is now part of national knowledge foresight programmes and science policy, designed to promote sunrise industries and knowledge and technology transfer. In short, technology is seen to be a key driver towards the knowledge economy.<sup>1</sup>

The public policy focus on technology, in part, reflects a growing consensus in macroeconomics of “new growth” or “endogenous growth theory”, based on the work of Solow, Lucas, and Romer, that the driving force behind economic growth is technological change (i.e., improvements in knowledge about how we transform inputs into outputs in the production process). On this model technological change is *endogenous*, “being determined by the deliberate activities of economic agents acting largely in response to financial incentive” (Snowdon & Vane, 1999: 79). The neo-classical growth model developed by Solow assumed technology to be exogenous and therefore available without limitation across the globe. Romer’s endogenous growth model, by contrast, demonstrates that technology is not a pure public good for while ideas are *non-rivalrous* they are also partially *excludable* through the legal system and patents. The policy implication is twofold: knowledge about technology and levels of information flow are critical for economic development and can account for differential growth patterns. Knowledge gaps and information deficiencies can retard growth prospects of poor countries, while technology transfer policies can greatly enhance long-term growth rates and living standards.<sup>2</sup>

My purpose is not to explain the recent increase in the public profile of technology in economic and education policy, but rather to begin to develop

a mapping of the field of philosophy of technology and its significance for education.<sup>3</sup> At a general level, this is important because philosophy of technology addresses general questions concerning the nature of technology, its impact on society and, for the purposes of this paper, specifically on education. Philosophy of technology, therefore, promises the possibility of an understanding of technology that may be important not only to public policy but also in helping to conceptualize intellectual approaches to the study of technology and, indeed, to shaping new fields of knowledge and research. These approaches to the study of technology, clearly, have a significant role to play in curricularizing technology at all levels. Philosophy of technology may also have a role to play in relation not only to structuring a largely disparate and inchoate field but also more directly in teaching and learning about technology. These are only promissory notes to be redeemed, if at all, at the end of the paper after our investigation.

We might make even grander claims for philosophy of technology. Just as economic growth theory now postulates an endogenous model where technology is considered as a factor intrinsic to development, in society and education the notion that technology is an autonomous system operating neutrally has come under increasing scrutiny. Rather than considering technology as something separate from daily life and from society at large, philosophers and sociologists now contemplate the way in which technology structures our institutions and impacts upon all aspects of our existence. Clearly, technology has permanently altered the labour process and our conception of labour in post-industrial service-oriented societies and it continues to transform our notions of intellectual labour. With the environmental movement, as Feenberg (1999) comments, technology entered the charmed circle of democracy. The very technical transformation of government and democracy is a subject in its infancy, with various thinkers beginning to explore the possibilities of joined-up-government and cyberdemocracy (e.g., Poster, 1995). The technological revolution demands new types of media and multimedia literacies, just as print technology transformed the public sphere, and makes possible the radical restructuring of education as a key to democracy and active citizenship within the global economy (Kellner, 2001). With the discoveries of biotechnology and the prospects of the human genome project, the very stuff of life and its reproduction, is now a matter of urgent ethical and political concern. The possibilities for dealing with so-called learning disabilities genetically or as part of biological planning and regulatory regimes is as yet unrealized. Furthermore, advances in information and communications technologies and in related telecommunications technologies have already transformed our practices of reading and writing, of communicating, of viewing, and of the transmission, storage and retrieval of information, thereby, also changing the nature of our knowledge practices and institutions (Peters & Roberts, 1998). New information and communication technologies raise complex ontological, epistemological, ethical, and identity issues; they at one and



the same time present exciting educational possibilities but also grave dangers (Burbules, 2001).<sup>4</sup> At the experimental psychological level, it is obvious that the computer has stimulated the development of models of the mind, providing not only a computational analogue for the brain but also research programmes for the so-called revolution in cognitive psychology now in its third generation (Bruner, 1996; Harré & Gillet, 1994). Philosophy of technology is a field that defines what it is to be human in terms of technology; in short, technologies shape and produce our subjectivities.

Yet as a field, philosophy of technology is both a recent and a poor cousin to philosophy of science. Philosophy of science has had little time for either technology or the relation between science and technology. Technology was not seen as philosophically interesting. Traditionally, in standard accounts, technology often has been seen as synonymous with industrial technology that came into existence on the back of Enlightenment science and flourished in the 19th century to develop exponentially and in a myriad of different directions in the 20th century. On this conception it was seen as the handmaiden of science, a kind of applied knowledge that put into practice the pure theory of science. This standard liberal “engineering” account is now being questioned, modified, refined, and alternative theories are being developed. Some scholars who read the present situation critically want to talk of the conglomeration “technoscience”, indicating a dramatic historical shift in the nature of knowledge (e.g., Lyotard, 1984); others contemplate reversing the traditional relationship, suggesting that technology is the ground out of which science came to be and that modern technology rather than science is the all embracing and pervading ethos defining the modern *zeitgeist* (Heidegger, 1977).

## 2. WAYS OF MAPPING THE FIELD

Carl Mitcham (1994) makes a distinction in *Thinking Through Technology* between an engineering and humanities tradition. The former takes technology as a good or positive value and is oriented to technological development, whereas the latter interprets technology more broadly in relation to culture and history. Where the former tends towards a kind of technicity and materiality, the latter views technology as something more than material, embodying cultural practices and symbolic forms. The former tends to treat political and ethical aspects of technology, insofar as these questions arise, only retroactively as a way of responding to the worst excesses of technology, whereas the latter treat them as central. The engineering tradition is indebted to nineteenth German philosophy (neo-Kantians and neo-Hegelians, and especially Marx, Kapp, and Dessauer, although is not restricted to them. See also Pitt, 2000). The humanities tradition in the 20th century owes its shape to Mumford, Ortega, Dewey, Jonas, Heidegger, and Ellul who turn to cultural critique and tend to investigate the interface between technology and culture, emphasizing

the instrumental nature of technology and its essence in control and efficiency functions.<sup>5</sup>

For the sake of this essay I shall be focusing on the humanities tradition and what has been called the classical philosophy of technology (Achterhuis, 2001) and, in particular, mainly I shall be considering what I call the Heideggerian research programme in philosophy of technology, construed Lakatosian terms, even although without empirical testing it is difficult to know what might constitute a progressive as opposed to a degenerating problem-shift. I consider in terms of the Heideggerian programme not only Heidegger himself, beginning with his famous late essay *The Question Concerning Technology* (1977), but also Herbert Marcuse, Heidegger's student, and his major work *One-Dimensional Man* (1964), Michel Foucault and his *Technologies of Self* (1977), and, finally Hubert Dreyfus, especially his latest work *On the internet* (2001). When I use the term "programme" I do not mean to suggest that subsequent thinkers slavishly imitate Heidegger or even subscribe to the same basic ontological commitments. Rather I mean to suggest that each of these thinkers in their own way have developed out of Heidegger's work their own distinctive orientations. Against these thinkers indebted to the Heideggerian programme, as I put it, I will offer two contrasts, the socialist feminist programme developed by Donna Haraway and the social constructivist programme offered by Andrew Feenberg. I offer the work of Haraway because, first, she is one of the few theorists working in philosophy of technology who takes questions of gender seriously, and, second, she focuses on the twin fields of communications and biotechnologies. I refer to Feenberg because he takes the constructivist programme the further than any other thinker.

Before embarking on this task, let me suggest, first, that it is possible to carry through similar programme for Marx, Dewey, Mumford, Ortega, Jonas, and Ellul. A full mapping of the field would at least configure the main contours of each programme, sourcing main texts and noting major theorists. It would be an additional endeavour then to indicate where these programmes have been picked up and developed in relation to education. Second, I should make it clear that I do not believe that this is the only way to map the field. Indeed, there are other useful ways of proceeding, including what we might call the approach through national traditions. Here we might talk of the British empiricist tradition beginning with Francis Bacon's *Novum Organum*, or the German tradition, including many of the classical approaches from Marx to Heidegger, or the recent Dutch tradition, focusing on Hans Achterhuis and his colleagues, who published *De maat van de techniek (The Matter of Technology)* in 1993, followed by *Van stoommachine tot cyborg: denken over techniek in de nieuwe wereld (From the Steam Engine to Cyborg: Thinking Through Technology in the New World)* in 1997. Achterhuis' (2001) recent *American Philosophy of Technology: The Empirical Turn* clearly fits into this category, with pen nail sketches of the work of Albert Borgmann, Hubert Dreyfus, Andrew Feenberg, Donna Haraway, Don Ihde, and Langdon Winner.

As an example of this approach, Achterhuis (2001: 3) distinguishes between the classical thinkers of technology and the American philosophers of technology, maintaining

The classical philosophers of technology occupied themselves more with the historical and transcendental conditions that made modern technology possible than with the real changes accompanying the development of technological culture.

Achterhuis (2001) suggests that American philosophy of technology can be broadly characterized by an empirical turn that took a constructivist direction that opened up the black box, analyzing the formation of technological processes and describing the social forces acting upon them. Technology was no longer considered autonomous or monolithic but rather comprised of many distinct technologies that needed to be analyzed separately. Rather like the empirical turn that philosophy of science took after Kuhn, so too American philosophers of technology began to investigate in actual contexts the ways in which technology and society influence one another. The terms “technoculture” and “technosociety” on the one hand speak to the way classical philosophers had disembedded processes of technology, while on the other, recognizing how technology itself is a social activity, which is given a particular cultural form. American philosophy of technology also distinguishes itself from classical philosophy in their approach to nature, no longer necessarily holding to the technological disenchantment of nature subscribed to by Jonas, Ellul, and Heidegger but exhibiting a greater sensitivity to ideological constructions of nature.

Finally, I should mention a conceptual approach to distinguishing varieties of theory in technology developed by Andrew Feenberg. Figure 1, as Feenberg (1999: 9) indicates, sets out the theoretical variety that has unfolded over time according to two axes:

The theories differ with respect to the role of human action in the technical sphere, and the neutrality of technical means. Common sense assumes both the possibility of human control and the neutrality of technology. Deterministic theories, such as traditional Marxism, minimize our power to control technical development, but consider technical means to be neutral insofar as they merely fulfil natural needs. Substantivism share determinist scepticism regarding human agency but denies the neutrality thesis. Ellul, for example, considers ends to be so implicated in the technical means employed to realize them that it makes no sense to distinguish means from ends. Critical theories, such as Marcuse and Foucault’s left dystopianism, affirm human agency while rejecting the neutrality of technology. Means and ends are linked in systems subject to our ultimate control.

<b>Technology is:</b>	<i>Autonomous</i>	<i>Humanly Controlled</i>
<b>Neutral</b>  (complete separation of means and ends)	<b>Determinism</b>  (e.g. traditional Marxism)	<b>Instrumentalism</b>  (liberal faith in progress)
<b>Value-laden</b>  (means form a way of life that includes ends)	<b>Substantivism</b>  (means and ends linked in systems)	<b>Critical Theory</b>  (choice of alternative means-ends system)

Figure 1. *The varieties of theory.* Source: Feenberg (1999).

David Blacker's (1994) discussion of the ontologies underlying various ways in which technology is discussed in a representative sampling of the education literature indicates how these conceptual distinctions might work. Yet he only employs two implicit ontologies—the substantive and the instrumental, i.e., only two squares of Feenberg's grid. Yet within these categories he suggests we might talk of "pro" and "con" attitudes. For example, he labels the work of C. A. Bowers (1982, 1988) as an educational theorist that proposes a form of substantivism. For Bowers the "technological mindset" is so pervasive that every school reform and aspect of contemporary pedagogy is unwittingly contained within it. It is the Herculean task of a radical pedagogy to step outside this enframing to recover what is truly human. As Blacker (1994) comments a subtler version of this view derives from the Frankfurt's critique of instrumental reason and is evident in the educational theory of Broughton (1985). Educational substantivist or what Blacker calls "radical instructional design" (RID) theory—the computer romanticists—constitute the pro-technology lobby, holding that technology holds the key to effective learning and successful school reform (e.g., Heinrich, 1984, 1985; McClintock, 1988; see also Winn, 1989).

There is also an educational pro-technology that takes the form of instrumentalism. The most celebrated example of this way of thinking, Blacker claims, is the work of Seymour Papert (1980) whose *Mindstorms* lay the pattern for a computer instrumentalism that argued that LOGO (and other computer programmes) offer children "powerful ideas" for problem-solving (see also Davy, 1985; Franz and Papert, 1985; Papert, 1987). Educational

anti-technology instrumentalism often takes a Marxist form or a form of socio-political critique evident in critical theory of technology, stated most carefully by Feenberg. In education this position is ascribed to Bowles' and Gintis' (1976) *Schooling in Capitalist America*, where the guiding idea for educational reform is the necessary transformation of social relations rather than a new technology.

Blacker (1994) argues that a proper theory of technology in education ought to take account of both positions and he begins to outline such a theory in terms of an appeal to the thought of Dewey and the early Heidegger. It might be called "double aspect" theory of technology for on this theory technology is both concealing and revealing (see also Blacker, 1993).

The advantage of Feenberg's and Blacker's approach is that it provides a way of classifying theories of technology according to their underlying theoretical commitments, but as can be seen from my discussion (below) it is clearly the case that a programme may cut across these lines, so that the Heideggerian programme, for instance, can run across forms of substantivism (Heidegger) and critical theory (Marcuse and Foucault). Feenberg's position is that of critical theory, although he works it out somewhat differently.

### 3. OUTLINING THE HEIDEGGERIAN PROGRAMME: HEIDEGGER, MARCUSE, FOUCAULT, DREYFUS

#### 3.1. Heidegger

Heidegger delivered four lectures comprising *The Question Concerning Technology* in 1949—over 50 years ago. It remains one of the most profound statements concerning technology that has been made and established a tradition of thought, remaining an important source of inspiration for a generation of philosophers writing of the nature of technology. Heidegger (1977: 4) poses the question quite forthrightly:

According to ancient doctrine, the essence of a thing is considered to be what the thing is. We ask the question concerning technology when we ask what it is. Everyone knows the two statements that answer our question. One says: Technology is a means to an end. The other says: Technology is a human activity.

Two definitions: the instrumental and the anthropological. Heidegger goes on to question the instrumental and the will to mastery that such a conception entails. This is the source, in part, for the notion of instrumental rationality, a

purely technical reason, that the Frankfurt School contrast strongly to practical reason.

For Heidegger, “technology’s essence is nothing technological” (1977: 4). It is a system—*Gestell*—an all-encompassing view that describes a mode of human existence. Heidegger’s account relates technology back to a critique of the Western metaphysical tradition and focuses upon the way *machinic* technology can alter our mode of being, distorting our actions and aspirations.

In terms of the received view technology is something that stands in a subsidiary, instrumental, and temporal relation with modern science. Modern physical science begins in the 17th century, historically it is seen as achieving a kind of take-off by 1750, and its institutionalization through royal societies and universities also dates from that period. *Machinic* technology, by contrast, chronologically speaking, begins in the 18th century and comes to fruition in the 19th century. It is pictured essentially as the “handmaiden” to science and it is regarded as an application of “pure” science or applied science.

Heidegger reverses the chronological order of the received view. He distinguishes technology in its various manifestations from its essence that is not technological and describes this essence by returning to the Greek concept of *techné*, which relates not only to the activities and skills of the artisan but also to the arts of the mind and fine arts. *Techné* is a word linked to *episteme*. It is a form of knowing in the widest sense. The essence of technology, Heidegger maintains, is a *poiesis* or “bringing forth” which is grounded in revealing (*aletheia*). He writes: “Technology is a mode of revealing. Technology comes to presence in the realm where revealing and unconcealment take place, where *aletheia*, truth, happens” (Heidegger, 1977: 13).

Heidegger distinguishes modern technology from its ancient form: “The essence of modern technology shows itself in what we call Enframing . . . It is the way in which the real reveals itself as standing-reserve” (Heidegger, 1977: 23). He observes: “The revealing that rules in modern technology is a *challenging*, which puts to nature the unreasonable demand that it supply energy that can be extracted and stored as such” (Heidegger, 1977: 14). Heidegger describes this *challenging* as a demand and a *setting upon*. As he indicates: “modern technology sets upon nature challenging forth the energies of nature, unlocking and exposing them but always directed toward furthering something else (maximum yield at the minimum expense)” (Heidegger, 1977: 15). Heidegger uses the term *setting-in-order* and suggests: “Everywhere everything is ordered to stand by, to be immediately at hand, indeed to stand there just so that it may be on call for a further ordering. Whatever is ordered about in this way has its own standing. We call it the standing-reserve [*Bestand*]” (Heidegger, 1977: 17). Enframing endangers “man” in his relationship to himself and to everything that exists. Its destiny is to banish humankind into a kind of revealing which is an ordering and where this ordering holds sway, it drives out every other possibility of revealing. Thus, Enframing conceals that

form of “revealing which, in the sense of *poiesis*, lets what presences come forth into appearance” (Heidegger, 1977: 27).

Modern technology thus is seen in terms of “productionist metaphysics” where the concept of “standing reserve” refers to resources, which are stored in anticipation of consumption. Ingrid Scheibler (1993: 116) explains that modern technology, for Heidegger, “is linked to a particular mode of conceiving our relation to the world—of bringing forth—through a process that objectifies the world”. For Heidegger the essence of technology is part of the broader project of understanding the relation of this mode of objectifying experience to the tradition of Western metaphysics, which means that the question concerning modern technology cannot be thought apart from the critique of Western metaphysics or, indeed, the critique of modernity.

Heidegger’s account of technology has been criticized on a number of grounds. First, it is “essentialist” in that it ascribes an *essence* to technology and thus cannot differentiate among different types or levels of technology. It can only describe technology as part of an evolving cultural system that becomes ever more efficient in ordering the world. While Heidegger acknowledges, quoting Hölderlin, that where the danger is, so too lies the “saving power” it is not clear in what the “saving power” consists. It may consist in a kind of poetic reflection which characterized an ethos and aesthetic sensibility in early Greece that was *techné*—“a single, manifold revealing” that revealed the true nature of things that exist and was responsible for “the safekeeping of truth” (Heidegger, 1977: 34). As he writes: “The poetical thoroughly pervades every art, every revealing of coming to presence into the beautiful” (Heidegger, 1977: 34). Second, therefore, Heidegger’s essentialism is aimed at a kind of primordially only recoverable, it seems, by returning to early Greek aesthetic sensibility. This sensibility that is the possible basis of a spiritual renewal is, for some, too abstract and too theological to inform a new technological practice. In short, it offers us no guidelines for reform of technology in the present era. Third, by ontologizing technology in the way that he does and by linking it to the critique of Western metaphysics and especially the critique of modernity (via Nietzsche) he leaves no room for a future-oriented practice of reform or human agency reforming or changing or democratizing the apparently autonomous cultural system of ordering that modern technology has become.

### 3.2. Marcuse

Heidegger’s commitments stand in marked contrast on these points to Marcuse, Foucault, and Dreyfus. Marcuse, who was Heidegger’s student, in *One-Dimensional Man* (1964) runs together a humanist Marxism—the young “re-discovered” Marx of the *Economic and Philosophical Manuscripts*—with a Heideggerian thesis. He clearly continues the Heideggerian programme in

insisting that technology is the source of most of the difficulties that advanced industrial societies face. Indeed, technology and technological rationality (which has become a form of political rationality) has contained social change, especially progress that comes from the struggle of classes, and extends a system of domination that co-opts all possibility of protest. He also carries through Heidegger's argument that technology can no longer be regarded as neutral:

In the face of the totalitarian features of this society, the traditional notion of the "neutrality" of technology can no longer be maintained. Technology as such cannot be isolated from the use to which it is put; the technological society is a system of domination which operates already in the concept and construction of techniques.

(Marcuse, 1964: xvi)

Yet as he argues in *One-Dimensional Man* (1964) while advanced industrial society is capable of containing qualitative change there are "forces and tendencies exist which may break this containment and explode the society" (p. xv). Here, Marcuse, under the influence of a humanist Marxism, departs from Heidegger to emphasize historical theory and practice, the possibilities of transformation, and historical alternatives based on subversive tendencies and forces. Marcuse borrows a Marxist utopianism based on a concept of human collective agency, although he is quick to point out that the kind of struggles will no longer be necessarily class-based because technical progress has "abolished labour" and transcended the realm of necessity, where it serves as an instrument of domination, to become "subject to the free play of faculties in the struggle for the pacification of nature and society" (p. 16). He still holds on to the thesis that the processes of production transform labouring classes but in advanced industrial society mechanization and occupational stratification has led to a change in attitude and consciousness of labourers, weakening the negative position of the working class and rendering them docile. As he argues in Marxist theory "the social mode of production, not technics is the basic historical factor. However, when technics becomes the universal form of material production, it circumscribes an entire culture; it projects a historical totality—a 'world'" (Marcuse, 1964: 154). It is not surprising that Marcuse became the hero of the New Left and student movement in the 1960s and 1970s. In a highly prophetic way he had anticipated the political significance of new social movements and their railing against technological enframing.

### 3.3. Foucault

Foucault learns from both Heidegger and Marcuse. Like Marcuse, he departs from Heidegger's essentialism to focus on historical ontologies established



through Nietzschean genealogical investigations. For him there are no universal necessities in human nature but only different *technologies* through which the subject is created or by which (s)he creates him- or herself. Following both Nietzsche and the later Heidegger, Foucault rails against the phenomenological and humanist subject to emphasize modes of subjectivation and the way that human beings become subjects. Thus, he transforms Heidegger's essentialism into an historical inquiry and he distances himself from Heidegger's universalism. From Heidegger he accepts the relationship between subjectivity and technology, although he gives it an historical cast. With Marcuse, he wants to locate questions of power at the centre of his inquiry, but this is not a Marxist notion of power, construed either individually or collectively. Rather it is a kind of power that springs directly from the will to knowledge and truth—a conception of power as positive, productive, and capillary, very different from either Marxist or liberal accounts.

Foucault had spoken of a new book in “Technologies of the Self”, shortly before his death, based on a seminar presented at University of Vermont in 1982. Throughout his work Foucault had been concerned with technologies of power and domination, whereby the self had been objectified through scientific inquiry. By 1981, he became interested in how a human being turns him- or herself into a subject. In particular, he became interested in those practices whereby individuals, by their means or with the help of others, acted on their own bodies, souls, thoughts, conduct, and way of being in order to transform themselves and attain a certain state of perfection or happiness. At this late period of his life he became interested in the Kantian question “what are we today” and, he indicates that his project on the self was suggested by Christopher Lash's *Culture of Narcissism* (1978). In particular, he became interested in techniques of self-formation and how the roots of the modern concept of the self could be located in 1st and 2nd century Greco-Roman philosophy and in 4th and 5th century Christian spirituality. As he says in the interview “Truth, Power, Self”: “All my analyses are directed against the idea of universal necessities in human existence. They show the arbitrariness of institutions and show which space of freedom we still can enjoy and how changes can still be made” (p. 11).

Foucault may be disappointing for philosophers of technology who are looking for an account of technology per se for he emphasizes the relation between technique and subjectivity or self-development rather than investigates anything about the nature of technology. And yet what Foucault does is to draw our attention to the ways in which technologies have always been part of culture and society and instrumental in questions of self-formation. In his essay “Technologies of the Self” he aims

to sketch a history of the different ways in our culture that humans develop knowledge about themselves . . . [and] to analyze these so-called

sciences as very specific “truth games” related to specific techniques that human beings use to understand themselves (p. 17).

He then outlines four major types of technologies, “each a matrix of practical reason”:

- (1) technologies of production, which permit us to produce, transform, or manipulate things;
- (2) technologies of signs systems, which permit us to use signs, meanings, symbols, or signification;
- (3) technologies of power, which determine the conduct of individuals and submit them to certain ends or domination, an objectivizing of the subject;
- (4) technologies of the self, which permit individuals to effect by their own means or with the help of others a certain number of operations on their own bodies and souls, thoughts, conduct, and way of being, so as to transform themselves in order to attain a certain state of happiness, purity, wisdom, perfection, or immortality (p. 18).

Foucault explains that in antiquity there were two major ethical principles—“know yourself” and “take care of yourself”. The former came to displace and obscure the latter because the tradition of Christian morality made self-renunciation the condition for salvation. By contrast, taking care of oneself became presented as an immorality. Also, knowledge of the self, as Foucault explains “takes on an ever-increasing importance as the first step in the theory of knowledge” (p. 22). Foucault then proceeds to investigate the theme of “taking care of oneself” in Antiquity, focusing first on Plato’s *Alcibides 1* and second, on the Hellenistic period and the Stoics, four to five centuries later, including Seneca and Plutarch. He investigates techniques employed by the Stoics—the disclosure of the self through letters to friends and the examination of self and conscience—and the truth games of early Christianity, that led finally to the whole apparatus of confession.

#### 3.4. Dreyfus

Hubert Dreyfus is influenced strongly by Heidegger’s work (Dreyfus, 1991) and, in addition, he has written and drawn on the work of Merleau-Ponty (Dreyfus, 1998) and Foucault (Dreyfus & Rabinow, 1983).<sup>6</sup> Beginning with *What Computers Can’t Do* (Dreyfus, 1972) first published over 20 years ago, Dreyfus develops a non-reductionist account of the relation between minds and brains at a point historically when the computer-mind analogy has dominated for decades. He has been an early and consistent critic of artificial intelligence (AI). As Phillip Brey (2001: 39) notes:

A remarkable aspect of Dreyfu's critiques is that they are motivated by a philosophical tradition—phenomenology—which at the same time was not often associated with science and technology and seemingly far removed in its concerns. Phenomenology, as it appears in the work of Martin Heidegger and Maurice Merleau-Ponty, applies itself to describing the interrelationships between human beings and the world, and uses the first-person experiences of human beings as a point of departure. And while Heidegger, Merleau-Ponty, and other phenomenologists have quite specific things to say about the nature of human perception, thinking and behavior, their pronouncements about science and technology tend to be rather general and abstract. Dreyfus, however, was able to apply their ideas skilfully in his critique of AI to reach quite specific and concrete conclusions.

It is precisely this orientation and his non-reductive account of the relation between minds and brains that makes his work of the first order of importance to educational thought and to educational philosophy. It should come as no surprise that the intersection of his interests in psychology, cognitive science, ethics, entrepreneurship, and expert systems, should profile Dreyfus as one of the most important and yet unrecognized philosophers who speaks to educational questions. In *Mind over Machine* (1982), written with Stuart Dreyfus, Dreyfus provided a detailed account of the phenomenology of skill acquisition; an approach utilized and developed in a series of papers, including most recently, "Intelligence without Representation—Merleau-Ponty's Critique of Mental Representation: The Relevance of Phenomenology to Scientific Explanation" (Dreyfus, 1998), where Dreyfus outlines in summary the stages of an adult acquiring skill by instruction from the novice, through advanced beginner, competence, and proficiency, to expertise.

*On the internet* (2001), in a sense, represents the culmination and synthesis of much of his work with direct application to education, bringing together, as it does his interests in Nietzsche, Merleau-Ponty, Heidegger, and Kierkegaard as their work impacts on contemporary questions concerning the body, self, and skill acquisition. He begins: "The internet is not just a new technological innovation; it is a new type of technological innovation; one that brings out the very essence of technology" (p. 1), and ends: "as long as we continue to affirm our bodies, the Net can be useful to us in spite of its tendency to offer the worst of a series of asymmetrical trade-offs: economy over efficiency in education, the virtual over the real in our relation to things and people, and anonymity over commitment in our lives. But, in using it, we have to remember that our culture has already fallen twice for the Platonic/Christian temptation to try to get rid of our vulnerable bodies, and has ended in nihilism" (p. 106) (see Peters, 2002).

#### 4. HARAWAY'S *MANIFESTO FOR CYBORGS* AND FEENBERG'S CONSTRUCTIVISM

##### 4.1. Haraway

Donna Haraway's project is distinctive of the socialist tradition and marked by its concern for feminist issues in relation to technology. I include Haraway here partly because the question of the gendered nature of technology is not a topic that has been taken up by male theorists. The feminist emphasis alone warrants her inclusion. Yet Haraway is also a highly original thinker who brings her analysis to bear on information and reproductive technologies. Like all the theorists so far discussed Haraway wants to question the alleged neutrality of technology, especially its alleged neutrality in the face of gender. Haraway sees not only technology and technological rationality as gendered but also what Foucault calls technologies of the self. Indeed, the very concept of "biopower" is gendered.

Haraway is professor in the History of Consciousness department at the University of Santa Cruz where she teaches feminist theory and science studies. She is the author of *Crystals, Fabrics and Fields: Metaphors of Organicism in Twentieth-Century Biology* (1976), her PhD thesis, *Primate Visions: Gender, race, and Nature in the World of Modern Science* (1989), *Simians, Cyborgs, and Women: The Reinvention of Nature* (1991) and *Modest\_Witness@Second\_Millennium.FemalMan©MeetsOncoMouseTM* (1997). For the purposes of this essay I shall focus briefly on her most famous essay "Manifesto for Cyborgs" that originally appeared in *Socialist Review* in 1985. An early version, from which I shall work is entitled "The Ironic Dream of a Common Language for Women in the Integrated Circuit: Science, Technology, and Socialist feminism in the 1980s or a Socialist Feminist Manifesto for Cyborgs". The complete version appears in Haraway (1991). In the paper Haraway looks at electronics and biotechnology "to suggest the scope of social reformations which socialist feminists and other progressive groups must face". She goes on to write:

I want to be able to show how we can generate new political imaginations and practices that might empower us in the permanently fractured, reconstituted world in which we are placed and place ourselves. My traditional and starting point of the partial but rich ground of socialist, especially Marxist, feminism . . . Without arguing for a theoretical or practical hierarchy among class, race, or sex . . . how might a politics proceed which aims for our material and imaginative empowerment in the social relations produced by and producing science and technology? (p. 2).

Haraway characterizes the emerging world system "as a movement from an organic, industrial society to a polymorphous, information system" (*pace*

Heidegger) and she examines “women in the integrated circuit” in relation to two universes of science and technology: communications technologies, and biotechnologies. These technologies are “tools for recrafting our bodies”; they “embody social relations” and are “instruments for enforcing meanings”. Haraway maintains that boundaries are very fluid between tool and myth, instrument and concept, social relations and anatomies of possible bodies (p. 2). She argues:

Communications sciences and modern biologies are constructed by a common move—the translation of the world into a problem of coding, a search for a common language in terms of the common coin through which all resistance to instrumental control disappears and all heterogeneity can be submitted to disassembly, reassembly, investment and exchange. I like to term the logic of this kind of knowledge and practice an informatics of domination. The world become a game plan; everything is only a move; to win is to stay in the game; to persist is to communicate successfully, to reproduce favourably, to replicate faithfully enough (p. 3).

Immediately one can pick up the resonances to the work of Heidegger and Foucault, especially the ways in which they point us toward the complex relations between technology and subjectivity, between technologies and identities. Yet at the same time there are clear echoes of Marx and Marcuse. Yet the tools for analysis that we might use—Marxist, psychoanalytic, and feminist—are all problematic. Humanist Marxism asserts an essentialism that suggests we can only come to know the subject through labor. It thus relies on a Western sense of self and erases the polyvocal and inassimilable difference made visible in anti-colonial discourse. Psychoanalysis, at least the Freudian and Lacanian discourses, rely on the category of women as other, that is unable to escape the familial narrative or the birth of the “self” drama. Feminism imposes a false unity whereas there is nothing about being female that naturally unites women.

It is for these reasons that Haraway chooses the figure of the cyborg. As she writes:

A cyborg is a cybernetic organism, a hybrid of machine and organism, a creature of social reality as well as a creature of fiction. Social reality is lived social relations, our most important political construction, a world-changing fiction. The international women’s movements have constructed “women’s experience”, as well as uncovered or discovered this crucial collective object. This experience is a fiction and fact of the most crucial, political kind. Liberation rests on the construction of the consciousness, the imaginative apprehension, of oppression, and so of possibility. The cyborg is a matter of fiction and lived experience that

changes what counts as women's experience in the late twentieth century. This is a struggle over life and death, but the boundary between science fiction and social reality is an optical illusion . . .

By the late twentieth century, our time, a mythic time, we are all chimeras, theorized and fabricated hybrids of machine and organism; in short, we are cyborgs. The cyborg is our ontology; it gives us our politics. The cyborg is a condensed image of both imagination and material reality, the two joined centres structuring any possibility of historical transformation. In the traditions of "Western" science and politics—the tradition of racist, male-dominant capitalism; the tradition of progress; the tradition of the appropriation of nature as resource for the productions of culture; the tradition of reproduction of the self from the reflections of the other—the relation between organism and machine has been a border war. The stakes in the border war have been the territories of production, reproduction, and imagination.

(Haraway, 1991: 140–150)

"Cyborg replication is uncoupled from organic reproduction" (p. 150); "The cyborg does not dream of community on the model of the organic family" (p. 151). It does not aspire to "organic wholeness" and "is not afraid of joint kinship with animals and machines . . . of permanently partial identities and contradictory standpoints" (p. 154). As Carolyn Keen (2002: 1–2) observes:

The cyborg thus evades traditional humanist concepts of women as child-bearer and raiser, of individuality and individual wholeness, the heterosexual marriage-nuclear family, transcendentalism and Biblical narrative, the great chain of being (god/man/animal etc.), fear of death, fear of automatism, insistency of consistency and completeness. It evades the Freudian family drama, the Lacanian m/other, and "natural" affiliation and unity. It attempts to complicate binary oppositions, which have been "systematic to the logics and practices of domination of women, people of color, nature, workers, animals" (177).

The cyborg, then, becomes the figure by which Haraway investigates the creation myth of genetic engineering and the relations among genetic engineering, sex, and reproduction.

#### 4.2. Feenberg

Feenberg's (1999) *Questioning Technology* is, perhaps, the most comprehensive introductory text in philosophy of technology. It is the third book in a trilogy dealing with technology, including *Critical Theory of Technology* (1991)

and *Alternative Modernity* (1995). In *Questioning Technology* Feenberg takes the constructivist turn against all forms of essentialism. As he writes:

The “essence” of actual technology, as we encounter it in all its complexity, is not simply an orientation toward efficiency. Its many roles in our lives cannot be captured so simply. This is the burden of constructivist sociology of technology, which affirms the social and historical specificity of technological systems, the relativity of technical design and use to the culture and strategies of a variety of technological actors. Constructivism, in short, has introduced difference into the question of technology.

(Feenberg, 1999: x)

Feenberg argues against both essentialism and its cousin—determinism—to put forward a political theory of technology which embraces the social dimensions of technological systems, including their impact on the environment and workers’ skills and their role on the distribution of power. Feenberg wants to encompass the technical dimension of our lives and to provide a social account of the essence of technology which enlarges our democratic concerns.<sup>7</sup> Feenberg suggests that his philosophy of technology comprises four major elements, which I have abridged for the purposes of this essay.

1. *Hermeneutic Constructivism*. Technology is not the product of a unique technical rationality but of a combination of technical and social factors. The study of these factors must include not only the empirical methods of social science but also the interpretive methods of the humanities in order to get at the underlying meaning of technical objects and activities for participants. Meaning is critically important insofar as technical objects are socially defined.
2. *Historicism*. In recent years technology studies has benefited greatly from the adoption of a historicist approach derived from the work of Thomas Kuhn in the history of science. Instead of regarding technological progress as a deterministic sequence of developments, we have learned to see it as a contingent process that could lead in many different directions.
3. *Technical Democracy*. A technological society requires a democratic public sphere sensitive to technical affairs. But it is difficult to conceive the enlargement of democracy to technology through procedures such as voting . . . Nevertheless, local publics do become involved in protests over technical developments that concern them. Hence the widespread recourse to protests and public hearings in domains such as environmentalism . . . we are witnessing the slow emergence of a technical public sphere but that it has been largely overlooked because of its unfamiliar concerns and fragmented form.

4. *Meta-Theory of Technology*. There have been many attempts in philosophy to define the essence of technology and to distinguish the specific difference of modern and premodern technologies . . . these various theories are unilateral and fail to grasp the full complexity of their object. I distinguish two levels of technical “instrumentalization” . . . At the primary level technology reifies its objects, i.e., decontextualizes them and manipulates them. At the secondary level various compensations are introduced to recontextualize technical objects once again, for example, by providing them with ethical and aesthetic dimensions (<http://www-rohan.sdsu.edu/faculty/feenberg/Method1.htm>).

#### CONCLUDING NOTE

In this paper I have been concerned to map approaches in philosophy of technology, focusing on how we might address this question, and also the importance of the field for education. I mapped the humanities versus the engineering traditions and within the former, indicated what the Heideggerian programme might look like through the work of Heidegger, Marcuse, Foucault, and Dreyfus. There is a question of how we determine a research programme in philosophy, left unresolved, and whether, in fact, it is correct to construe Marcuse, Foucault, and Dreyfus as Heideggerian, especially when they all jettison Heidegger’s essentialism and his post-humanism. I then contrasted the Heideggerian programme with Haraway’s socialist–feminism project and Feenberg’s sociological constructivism. Philosophy of technology is an exciting emerging field of interest. It has crucial significance for education for education is not only a discipline often conceived as the study of education with an accent on its improvement, it is also a giant enterprise, increasing the centre of the knowledge economy, where such improvements are now driven by both economic theories concerning the importance of technology and technical innovations touted to transform its development. In relation to the economic and technical transformation of education I believe that the humanities tradition and, in particular, the Heideggerian programme of philosophy of technology offers a necessary corrective and critique to theories of educational modernity.

#### ENDNOTES

1. See, for instance, the US National Academies 1997 report in the series *Preparing for the 21st Century*, “Technology and the Nation’s Future” at <http://www.nas.edu/21st/technology/>; see also the report in the same series “The Educational Imperative” at <http://www.nas.edu/21st/technology/>. For a European perspective see the OECD’s science and



technology policy at [http://www1.oecd.org/dsti/sti/s\\_t/index.htm](http://www1.oecd.org/dsti/sti/s_t/index.htm). See also *Research and Knowledge Transfer in Scotland*, Report of the Scottish Higher Education Funding Council and Scottish Enterprise Joint Task Group (2002) available at <http://www.shefc.ac.uk>.

2. Neoclassical economics does not specify how knowledge accumulation occurs. As a result there is no mention of human capital and there is no direct role for education. Further, in the neo-classical model there is no income “left over” (all output is paid to either capital or labour) to act as a reward or incentive for knowledge accumulation. Accordingly, there are no externalities to knowledge accumulation. By contrast, new growth theory has highlighted the role of education in the creation of human capital and in the production of new knowledge. On the basis it has explored the possibilities of education-related externalities. In short, while the evidence is far from conclusive at this stage there is a consensus emerging that education is important for successful research activities (e.g., by producing scientists and engineers) which are, in turn, important for productivity growth, and; education creates human capital, which directly affects knowledge accumulation and therefore productivity growth. (See Report 8, “Externalities in Higher Education”, *The Dearing Report*, 1997).
3. My interest was initially stimulated by reading Heidegger’s work (see Peters, 2002). In 2001 I organized and taught a graduate level course entitled “Technology, Culture and Value” across two institutions in New Zealand: the University of Auckland (AU) and Auckland University of Technology (AUT). I held the course for explicit reasons as I wanted to institutionalize philosophy of technology as a pedagogical intervention at AUT. Any university of technology needs to reflect on the nature of technology as part of its fundamental mission. The course of twelve 3-hour lectures, with 4 of the 12 taught by staff from AUT, focused on Heidegger, Marcuse, Foucault, and Haraway, before focusing on issues (including the political technology of freedom, virtual learning, and technologized cultures) and disciplinary approaches (architecture, visual arts, higher education, media studies). See the website at: ([http://www.aut.ac.nz/faculties/arts/summer\\_school/about.shtml](http://www.aut.ac.nz/faculties/arts/summer_school/about.shtml)), especially the links to theorists, web resources, essays, and journals.
4. Burbules (2001) mentions as exciting possibilities new opportunities for learning involving constructivist, problem-oriented, social learning as well as the benefits of visualization and virtualization, simulations, and distance education. He mentions five dangers: the creation of an information caste society; commercialization of education as a for-profit enterprise; the rise of edutainment and other hybrid products; the deregulation and decentralization of public education; and the greater interpenetration of public/private spheres; and finally deinstitutionalization of education leading to the demise of a public schooling system.

5. One might also attempt an institutional analysis of philosophy of technology, an approach implicitly suggested by Don Ihde (1996) in providing a retrospective of the Society for Phenomenology and Existential Philosophy (SPEP), founded in 1962, the Society for Women in Philosophy (SWIP) and the Society for Philosophy and Technology (SPT), whose origins date from the same time.
6. Dreyfus has a new book *Heidegger and Foucault on the Ordering of Things*, forthcoming from University of California Press.
7. For symposia on Feenberg's latest book see his homepage at (<http://www-rohan.sdsu.edu/faculty/feenberg/symposia.html>), including the article by Iain Thomson "From the Question Concerning Technology to the Quest for a Democratic Technology: Heidegger, Marcuse, Feenberg" that also appears in Peters (2002). See also his list of publications and comments on distance education and online community.

#### REFERENCES

- Achterhuis, H. (Ed.) (2001). *American Philosophy of Technology: The Empirical Turn* (trans. R. P. Crease). Bloomington and Indianapolis: Indiana University Press.
- Blacker, D. (1993). 'Allowing Educational Technologies to Reveal: A Deweyan Perspective,' *Educational Theory* 43, no. 2 (Spring).
- Blacker, D. (1994). 'Philosophy Of Technology And Education: An Invitation To Inquiry', PES Yearbook, available at: [http://www.ed.uiuc.edu/EPS/PES-Yearbook/94\\_docs/BLACKER.HTM](http://www.ed.uiuc.edu/EPS/PES-Yearbook/94_docs/BLACKER.HTM) (accessed 27/7/05).
- Bowers, C. A. (1982). The reproduction of technological consciousness: locating the ideological foundations of a radical pedagogy. *Teachers College Record* 83(4).
- Bowers, C. A. (1988). *The Cultural Dimensions of Educational Computing: Understanding the Non-Neutrality of Technology*. New York: Teachers College Press.
- Bowles, S. and Gintis, H. (1976). *Schooling in Capitalist America: Educational Reform and the Contradictions of Economic Life*. New York, Basic Books.
- Brey, P. (2001). Hubert Dreyfus: humans versus computers. In: Achterhuis, H. (Ed.) *American Philosophy of Technology: The Empirical Turn*. Bloomington and Indianapolis: Indiana University Press.
- Broughton, R. (1985). The surrender of control: computer literacy as political socialization of the child. In Sloan, D. (Ed.) *The Computer in Education: A Critical Perspective*. New York: Teachers College Press.
- Bruner, J. (1996). *The Culture of Education*. Cambridge, MA, Harvard.
- Burbules, N. (2001). Why philosophers of education should care about technology issues. In: Stone, L. (Ed.) *Philosophy of Education 2000*. Urbana, IL: Philosophy of Education Society, 37–41.
- Davy, J. (1985). Mindstorms in the lamplight. In: Sloan, D. (Ed.) *The Computer in Education: A Critical Perspective*. New York: Teachers College Press.
- Dreyfus, H. (1972). *What Computers Can't Do: The Limits of Artificial Intelligence*. New York, HarperCollins.
- Dreyfus, S. & Dreyfus, H. (1986). *Mind Over Machine: The Power of Human Intuition and Expertise in the Era of the Computer*. New York, The Free Press.

- Dreyfus, H. (1991). *Being-in-the-World: A Commentary on Heidegger's Being and Time*, Division I, M.I.T. Press.
- Dreyfus, H. (1998). 'Merleau-Ponty's Critique of Mental Representation: The Relevance of Phenomenology to Scientific Explanation', available at: <http://www.hfac.uh.edu/cogsci/dreyfus.html> (accessed 27/7/05).
- Dreyfus, H. (2001). *On the Internet*. New York, Routledge.
- Feenberg, A. (1999). *Questioning Technology*. London and New York: Routledge, 9.
- Foucault (Dreyfus, H. & Rabinow, P.) (1983). *Michel Foucault: beyond Structuralism and Hermeneutics*. Chicago, University of Chicago Press.
- Franz, G., & Papert, S. (1985). Computers as materials: messing about with time. *The Computer in Education* 65.
- Haraway, D. (1976). *Crystals, Fabrics, and Fields: Metaphors of Organicism in 20th Century Developmental Biology*. New Haven, Conn., Yale University Press.
- Haraway, D. (1990). *Primate Visions: Gender, Race, and Nature in the World of Modern Science*. New York & London, Routledge.
- Haraway, D. (1991). 'A Cyborg Manifesto: Science, Technology, and Socialist-Feminism in the Late Twentieth Century,' in *Simians, Cyborgs and Women: The Reinvention of Nature*, New York, Routledge, pp. 149–181. Also available at: <http://www.stanford.edu/dept/HPS/Haraway/CyborgManifesto.html> (accessed 27/7/05).
- Haraway, D. (1996). *Modest\_Witness@Second\_Millennium. FemaleMan©\_Meets\_Oncomouse™*. New York, Routledge.
- Harre, R. & Gillet, G. (1994). *The Discursive Mind*. London, Sage.
- Heidegger, M. (1977). *The Question Concerning Technology and Other Essays*. Trans. William Lovitt. New York, Harper Torchbooks.
- Heinich, R. (1984). The proper study of instructional technology. *Education Communication and Technology Journal* 32(2) (Summer 1984).
- Heinich, R. (1985). Instructional technology and the structure of education. *Education Communication and Technology Journal* 33(1) (Spring 1985).
- Ihde, D. (1996). Philosophy of technology, 1975–1995. *Techne* 1(1–2), 1–6.
- Keen, C. (2002). 'Carolyn Keen on Haraway, "Cyborg Manifesto"' available at <http://www.koni.ch/cyborg/keen2.html> (accessed 27/7/05).
- Kellner, D. (2001). New Technologies/new literacies: reconstructing education for the new millenium. In: Stone, L. (Ed.) Urbana, IL: Philosophy of Education Society, 21–36.
- Liotard, J.-F. (1984). *The Postmodern condition: A Report on Knowledge*. Trans. from the French by Geoff Bennington and Brian Massumi. Minneapolis: University of Minnesota Press.
- Marcuse, H. (1964). *One Dimensional Man: Studies in the Ideology of Advanced Industrial Society*. Boston, Beacon Press.
- McClintock, R. (1988). Introduction: marking the second frontier. In Robert O. McClintock (Ed.) *Computing and Education: The Second Frontier*. New York: Teachers College Press.
- Mitcham, C. (1994). *Thinking Through Technology: The Path Between Engineering and Philosophy*. Chicago and London: University of Chicago Press.
- Papert, S. (1980). *Mindstorms: Children, Computers and Powerful Ideas*. New York: Basic Books.
- Papert, S. (1987). Computer criticism vs. technocentric thinking. *Educational Researcher* 16(1) (January–February).
- Peters, M. A. (Ed.) (2002). *Heidegger, Education and Modernity*. Lanham: Rowman & Littlefield.
- Peters, M. A. & Roberts, P. (1998) (Eds.) *Virtual Technologies and Tertiary Education*. Palmerston North (NZ), Dunmore Press.
- Pitt, J. (2000). What engineers know. *Techne* 5(3), 1–11.

- Poster, M. (1995) 'CyberDemocracy: Internet and the Public Sphere'. Available at: <http://www.hnet.uci.edu/mposter/writings/democ.html> (accessed 27/7/05).
- Snowden, B., & Vane, H. (1999). Interpreting modern macroeconomics: from Tobin to Romer. In: Snowden, B. and Vane, H. (Eds.) *Conversations with Leading Economists*. Cheltenham, UK: Edward Elgar.
- Winn, W. (1989). Toward a rationale and a theoretical basis for educational technology. *Educational Technology Research and Development* 37(1).

## Chapter 4: A Cyborg Manifesto: Science, Technology, and Socialist-Feminism in the Late 20th Century\*

DONNA HARAWAY

*History of Consciousness Program, University of California, at Santa Cruz*

### 1. AN IRONIC DREAM OF A COMMON LANGUAGE FOR WOMEN IN THE INTEGRATED CIRCUIT

This chapter is an effort to build an ironic political myth faithful to feminism, socialism, and materialism. Perhaps more faithful as blasphemy is faithful, than as reverent worship and identification. Blasphemy has always seemed to require taking things very seriously. I know no better stance to adopt from within the secular-religious, evangelical traditions of United States politics, including the politics of socialist-feminism. Blasphemy protects one from the moral majority within, while still insisting on the need for community. Blasphemy is not apostasy. Irony is about contradictions that do not resolve into larger wholes, even dialectically, about the tension of holding incompatible things together because both or all are necessary and true. Irony is about humor and serious play. It is also a rhetorical strategy and a political method, one I would like to see more honoured within socialist-feminism. At the center of my ironic faith, my blasphemy, is the image of the cyborg.

A cyborg is a cybernetic organism, a hybrid of machine and organism, a creature of social reality as well as a creature of fiction. Social reality is lived social relations, our most important political construction, a world-changing fiction. The international women's movements have constructed "women's experience", as well as uncovered or discovered this crucial collective object. This experience is a fiction and fact of the most crucial, political kind. Liberation rests on the construction of the consciousness, the imaginative apprehension, of oppression, and so of possibility. The cyborg is a matter of fiction and lived experience that changes what counts as women's experience in the late 20th century. This is a struggle over life and death, but the boundary between science fiction and social reality is an optical illusion.

Contemporary science fiction is full of cyborgs—creatures simultaneously animal and machine, who populate worlds ambiguously natural and crafted. Modern medicine is also full of cyborgs, of couplings between organism and machine, each conceived as coded devices, in an intimacy and with a power that was not generated in the history of sexuality. Cyborg "sex" restores some of the lovely replicative baroque of ferns and invertebrates (such nice

\* Originally published as Manifesto for cyborgs: science, technology, and socialist feminism in the 1980s. *Socialist Review*, no. 80 (1985): 65–108. Reprinted with permission of the author.

organic prophylactics against heterosexism). Cyborg replication is uncoupled from organic reproduction. Modern production seems like a dream of cyborg colonization work, a dream that makes the nightmare of Taylorism seem idyllic. And modern war is a cyborg orgy, coded by C3I, command-control-communication-intelligence, an \$84 billion item in 1984s US defence budget. I am making an argument for the cyborg as a fiction mapping our social and bodily reality and as an imaginative resource suggesting some very fruitful couplings. Michael Foucault's biopolitics is a flaccid pre-monition of cyborg politics, a very open field.

By the late 20th century, our time, a mythic time, we are all chimeras, theorized, and fabricated hybrids of machine and organism; in short, we are cyborgs. This cyborg is our ontology; it gives us our politics. The cyborg is a condensed image of both imagination and material reality, the two joined centers structuring any possibility of historical transformation. In the traditions of "Western" science and politics—the tradition of racist, male-dominant capitalism; the tradition of progress; the tradition of the appropriation of nature as resource for the productions of culture; the tradition of reproduction of the self from the reflections of the other—the relation between organism and machine has been a border war. The stakes in the border war have been the territories of production, reproduction, and imagination. This chapter is an argument for pleasure in the confusion of boundaries and for responsibility in their construction. It is also an effort to contribute to socialist-feminist culture and theory in a post-modernist, non-naturalist mode and in the utopian tradition of imagining a world without gender, which is perhaps a world without genesis, but maybe also a world without end. The cyborg incarnation is outside salvation history. Nor does it mark time on an oral symbiotic utopia or post-oedipal apocalypse. As Zoe Sofoulis argues in her unpublished manuscript on Jacques Lacan, Melanie Klein, and nuclear culture, Lacklein, the most terrible and perhaps the most promising monsters in cyborg worlds are embodied in non-oedipal narratives with a different logic of repression, which we need to understand for our survival.

The cyborg is a creature in a post-gender world; it has no truck with bisexuality, pre-oedipal symbiosis, unalienated labor, or other seductions to organic wholeness through a final appropriation of all the powers of the parts into a higher unity. In a sense, the cyborg has no origin story in the Western sense—a "final" irony since the cyborg is also the awful apocalyptic *telos* of the "West's" escalating dominations of abstract individuation, an ultimate self untied at last from all dependency, a man in space. An origin story in the "Western", humanist sense depends on the myth of original unity, fullness, bliss, and terror, represented by the phallic mother from whom all humans must separate, the task of individual development and of history, the twin potent myths inscribed most powerfully for us in psychoanalysis and Marxism. Hilary Klein (1989) has argued that both Marxism and psychoanalysis, in their concepts of labor and of individuation and gender formation, depend on the plot of original

unity out of which difference must be produced and enlisted in a drama of escalating domination of woman/nature. The cyborg skips the step of original unity, of identification with nature in the Western sense. This is an illegitimate promise that might lead to subversion of its teleology as star wars.

The cyborg is resolutely committed to partiality, irony, intimacy, and perversity. It is oppositional, utopian, and completely without innocence. No longer structured by the polarity of public and private, the cyborg defines a technological *polis* based partly on a revolution of social relations in the *oikos*, the household. Nature and culture are reworked; the one can no longer be the resource for appropriation or incorporation by the other. The relationships for forming wholes from parts, including those of polarity and hierarchical domination, are at issue in the cyborg world. Unlike the hopes of Frankenstein's monster, the cyborg does not expect its father to save it through a restoration of the garden; that is, through the fabrication of a heterosexual mate, through its completion in a finished whole, a city and cosmos. The cyborg does not dream of community on the model of the organic family, this time without the oedipal project. The cyborg would not recognize the Garden of Eden; it is not made of mud and cannot dream of returning to dust. Perhaps that is why I want to see if cyborgs can subvert the apocalypse of returning to nuclear dust in the manic compulsion to name the Enemy. Cyborgs are not reverent; they do not remember the cosmos. They are wary of holism, but needy for connection—they seem to have a natural feel for united front politics, but without the vanguard party. The main trouble with cyborgs, of course, is that they are the illegitimate offspring of militarism and patriarchal capitalism, not to mention state socialism. But illegitimate offspring are often exceedingly unfaithful to their origins. Their fathers, after all, are inessential.

I want to signal three crucial boundary breakdowns that make the following political-fictional (political-scientific) analysis possible. By the late 20th century in United States scientific culture, the boundary between human and animal is thoroughly breached. The last beachheads of uniqueness have been polluted if not turned into amusement parks—language, tool use, social behavior, mental events, nothing really convincingly settles the separation of human and animal. And many people no longer feel the need for such a separation; indeed, many branches of feminist culture affirm the pleasure of connection of human and other living creatures. Movements for animal rights are not irrational denials of human uniqueness; they are a clear-sighted recognition of connection across the discredited breach of nature and culture. Biology and evolutionary theory over the last two centuries have simultaneously produced modern organisms as objects of knowledge and reduced the line between humans and animals to a faint trace re-etched in ideological struggle or professional disputes between life and social science. Within this framework, teaching modern Christian creationism should be fought as a form of child abuse.

Biological-determinist ideology is only one position opened up in scientific culture for arguing the meanings of human animality. There is much

room for radical political people to contest the meanings of the breached boundary.<sup>1</sup> The cyborg appears in myth precisely where the boundary between human and animal is transgressed. Far from signaling a walling off of people from other living beings, cyborgs signal disturbingly and pleasurably tight coupling. Bestiality has a new status in this cycle of marriage exchange.

The second leaky distinction is between animal-human (organism) and machine. Pre-cybernetic machines could be haunted; there was always the spectre of the ghost in the machine. This dualism structured the dialogue between materialism and idealism that was settled by a dialectical progeny, called spirit or history, according to taste. But basically machines were not self-moving, self-designing, autonomous. They could not achieve man's dream, only mock it. They were not man, an author himself, but only a caricature of that masculinist reproductive dream. To think they were otherwise was paranoid. Now we are not so sure. Late 20th-century machines have made thoroughly ambiguous the difference between natural and artificial, mind and body, self-developing and externally designed, and many other distinctions that used to apply to organisms and machines. Our machines are disturbingly lively, and we ourselves frighteningly inert.

Technological determination is only one ideological space opened up by the reconceptions of machine and organism as coded texts through which we engage in the play of writing and reading the world.<sup>2</sup> "Textualization" of everything in post-structuralist, post-modernist theory has been damned by Marxists and socialist-feminists for its utopian disregard for the lived relations of domination that ground the "play" of arbitrary reading.<sup>3</sup> It is certainly true that post-modernist strategies, like my cyborg myth, subvert myriad organic wholes (for example, the poem, the primitive culture, the biological organism). In short, the certainty of what counts as nature—a source of insight and promise of innocence—is undermined, probably fatally. The transcendent authorization of interpretation is lost, and with it the ontology grounding "Western" epistemology. But the alternative is not cynicism or faithlessness, that is, some version of abstract existence, like the accounts of technological determinism destroying "man" by the "machine" or "meaningful political action" by the "text". Who cyborgs will be is a radical question; the answers are a matter of survival. Both chimpanzees and artifacts have politics, so why shouldn't we? (de Waal, 1982; Winner, 1980).

The third distinction is a subset of the second: The boundary between physical and non-physical is very imprecise for us. Pop physics books on the consequences of quantum theory and the indeterminacy principle are a kind of popular scientific equivalent to Harlequin romances as a marker of radical change in American white heterosexuality: They get it wrong, but they are on the right subject. Modern machines are quintessentially microelectronic devices: They are everywhere and they are invisible. Modern machinery is an irreverent upstart god, mocking the Father's ubiquity and spirituality. The



silicon chip is a surface for writing; it is etched in molecular scales disturbed only by atomic noise, the ultimate interference for nuclear scores. Writing, power, and technology are old partners in Western stories of the origin of civilization, but miniaturization has changed our experience of mechanism. Miniaturization has turned out to be about power; small is not so much beautiful as pre-eminently dangerous, as in cruise missiles. Contrast the TV sets of the 1950s or the news cameras of the 1970s with the TV wrist bands or hand-sized video cameras now advertised. Our best machines are made of sunshine; they are all light and clean because they are nothing but signals, electromagnetic waves, a section of a spectrum, and these machines are eminently portable, mobile—a matter of immense human pain in Detroit and Singapore. People are nowhere near so fluid, being both material and opaque. Cyborgs are ether, quintessence.

The ubiquity and invisibility of cyborgs is precisely why these sunshine-belt machines are so deadly. They are as hard to see politically as materially. They are about consciousness—or its simulation.<sup>4</sup> They are floating signifiers moving in pickup trucks across Europe, blocked more effectively by the witch-weavings of the displaced and so unnatural Greenham women, who read the cyborg webs of power so very well, than by the militant labor of older masculinist politics, whose natural constituency needs defence jobs. Ultimately the “hardest” science is about the realm of greatest boundary confusion, the realm of pure number, pure spirit, C<sup>3</sup>I, cryptography, and the preservation of potent secrets. The new machines are so clean and light. Their engineers are sun-worshippers mediating a new scientific revolution associated with the night dream of post-industrial society. The diseases evoked by these clean machines are “no more” than the minuscule coding changes of an antigen in the immune system, “no more” than the experience of stress. The nimble fingers of “Oriental” women, the old fascination of little Anglo-Saxon Victorian girls with doll’s houses, women’s enforced attention to the small take on quite new dimensions in this world. There might be a cyborg Alice taking account of these new dimensions. Ironically, it might be the unnatural cyborg women making chips in Asia and spiral dancing in Santa Rita jail<sup>5</sup> whose constructed unities will guide effective oppositional strategies.

So my cyborg myth is about transgressed boundaries, potent fusions, and dangerous possibilities which progressive people might explore as one part of needed political work. One of my premises is that most American socialists and feminists see deepened dualisms of mind and body, animal and machine, idealism and materialism in the social practices, symbolic formulations, and physical artifacts associated with “high technology” and scientific culture. From *One-Dimensional Man* (Marcuse, 1964) to *The Death of Nature* (Merchant, 1980), the analytic resources developed by progressives have insisted on the necessary domination of technics and recalled us to an imagined organic body to integrate our resistance. Another of my premises is that the need for unity of people trying to resist worldwide intensification of

domination has never been more acute. But a slightly perverse shift of perspective might better enable us to contest for meanings, as well as for other forms of power and pleasure in technologically mediated societies.

From one perspective, a cyborg world is about the final imposition of a grid of control on the planet, about the final abstraction embodied in a Star Wars apocalypse waged in the name of defence, about the final appropriation of women's bodies in a masculinist orgy of war (Sofia, 1984). From another perspective, a cyborg world might be about lived social and bodily realities in which people are not afraid of their joint kinship with animals and machines, not afraid of permanently partial identities and contradictory standpoints. The political struggle is to see from both perspectives at once because each reveals both dominations and possibilities unimaginable from the other vantage point. Single vision produces worse illusions than double vision or many-headed monsters. Cyborg unities are monstrous and illegitimate; in our present political circumstances, we could hardly hope for more potent myths for resistance and recoupling. I like to imagine LAG, the Livermore Action Group, as a kind of cyborg society, dedicated to realistically converting the laboratories that most fiercely embody and spew out the tools of technological apocalypse, and committed to building a political form that actually manages to hold together witches, engineers, elders, perverts, Christians, mothers, and Leninists long enough to disarm the state. Fission Impossible is the name of the affinity group in my town. (Affinity: Related not by blood but by choice, the appeal of one chemical nuclear group for another, avidity.)<sup>6</sup>

## 2. FRACTURED IDENTITIES

It has become difficult to name one's feminism by a single adjective—or even to insist in every circumstance upon the noun. Consciousness of exclusion through naming is acute. Identities seem contradictory, partial, and strategic. With the hard-won recognition of their social and historical constitution, gender, race, and class cannot provide the basis for belief in “essential” unity. There is nothing about being “female” that naturally binds women. There is not even such a state as “being” female, itself a highly complex category constructed in contested sexual scientific discourses and other social practices. Gender, race, or class-consciousness is an achievement forced on us by the terrible historical experience of the contradictory social realities of patriarchy, colonialism, and capitalism. And who counts as “us” in my own rhetoric? Which identities are available to ground such a potent political myth called “us”, and what could motivate enlistment in this collectivity? Painful fragmentation among feminists (not to mention among women) along every possible fault line has made the concept of *woman* elusive, an excuse for the matrix of women's dominations of each other. For me—and for many who share a similar historical location in white, professional middle-class, female,

radical, North American, mid-adult bodies—the sources of a crisis in political identity are legion. The recent history for much of the US left and US feminism has been a response to this kind of crisis by endless splitting and searches for a new essential unity. But there has also been a growing recognition of another response through coalition—affinity, not identity.<sup>7</sup>

Chela Sandoval (n.d., 1984), from a consideration of specific historical moments in the formation of the new political voice called women of color, has theorized a hopeful model of political identity called “oppositional consciousness”, born of the skills for reading webs of power by those refused stable membership in the social categories of race, sex, or class. “Women of color”, a name contested at its origins by those whom it would incorporate, as well as a historical consciousness marking systematic breakdown of all the signs of Man in “Western” traditions, constructs a kind of post-modernist identity out of otherness, difference, and specificity. This post-modernist identity is fully political, whatever might be said about other possible post-modernisms. Sandoval’s oppositional consciousness is about contradictory locations and heterochronic calendars, not about relativisms and pluralisms.

Sandoval emphasizes the lack of any essential criterion for identifying who is a woman of color. She notes that the definition of a group has been by conscious appropriation of negation. For example, a Chicana or US black woman has not been able to speak as a woman or as a black person or as a Chicano. Thus, she was at the bottom of a cascade of negative identities, left out of even the privileged oppressed authorial categories called “women and blacks”, who claimed to make the important revolutions. The category “woman” negated all non-white women; “black” negated all non-black people, as well as all black women. But there was also no “she”, no singularity, but a sea of differences among US women who have affirmed their historical identity as US women of color. This identity marks out a self-consciously constructed space that cannot affirm the capacity to act on the basis of natural identification, but only on the basis of conscious coalition, of affinity, of political kinship.<sup>8</sup> Unlike the “woman” of some streams of the white women’s movement in the United States, there is no naturalization of the matrix, or at least this is what Sandoval argues is uniquely available through the power of oppositional consciousness.

Sandoval’s argument has to be seen as one potent formulation for feminists out of the worldwide development of anti-colonialist discourse; that is to say, discourse dissolving the “West” and its highest product—the one who is not animal, barbarian, or woman; man, that is, the author of a cosmos called history. As orientalism is deconstructed politically and semiotically, the identities of the occident destabilize, including those of feminists.<sup>9</sup> Sandoval argues that “women of colour” have a chance to build an effective unity that does not replicate the imperializing, totalizing revolutionary subjects of previous Marxisms and feminisms which had not faced the consequences of the disorderly polyphony emerging from decolonization.

Katie King has emphasized the limits of identification and the political/poetic mechanics of identification built into reading “the poem”, that generative core of *cultural* feminism. King criticizes the persistent tendency among contemporary feminists from different “moments” or “conversations” in feminist practice to taxonomize the women’s movement to make one’s own political tendencies appear to be the *telos* of the whole. These taxonomies tend to remake feminist history so that it appears to be an ideological struggle among coherent types persisting over time, especially those typical units called radical, liberal, and socialist-feminist. Literally, all other feminisms are either incorporated or marginalized, usually by building an explicit ontology and epistemology.<sup>10</sup> Taxonomies of feminism produce epistemologies to police deviation from official women’s experience. And of course, “women’s culture”, like women of color, is consciously created by mechanisms inducing affinity. The rituals of poetry, music, and certain forms of academic practice have been pre-eminent. The politics of race and culture in the US women’s movements are intimately interwoven. The common achievement of King and Sandoval is learning how to craft a poetic/political unity without relying on a logic of appropriation, incorporation, and taxonomic identification.

The theoretical and practical struggle against unity-through-domination or unity-through-incorporation ironically not only undermines the justifications for patriarchy, colonialism, humanism, positivism, essentialism, scientism, and other unlamented -isms, but *all* claims for an organic or natural standpoint. I think that radical and socialist/Marxist-feminisms have also undermined their/our own epistemological strategies and that this is a crucially valuable step in imagining possible unities. It remains to be seen whether all “epistemologies” as Western political people have known them fail us in the task to build effective affinities.

It is important to note that the effort to construct revolutionary standpoints, epistemologies as achievements of people committed to changing the world, has been part of the process showing the limits of identification. The acid tools of post-modernist theory and the constructive tools of ontological discourse about revolutionary subjects might be seen as ironic allies in dissolving Western selves in the interests of survival. We are excruciatingly conscious of what it means to have a historically constituted body. But with the loss of innocence in our origin, there is no expulsion from the Garden either. Our politics lose the indulgence of guilt with the *naiveté* of innocence. But what would another political myth for socialist-feminism look like? What kind of politics could embrace partial, contradictory, permanently unclosed constructions of personal and collective selves and still be faithful, effective—and, ironically, socialist-feminist?

I do not know of any other time in history when there was greater need for political unity to confront effectively the dominations of “race”, “gender”, “sexuality”, and “class”. I also do not know of any other time when the kind of unity we might help build could have been possible. None of “us” have

any longer the symbolic or material capability of dictating the shape of reality to any of “them”. Or at least “we” cannot claim innocence from practicing such dominations. White women, including socialist-feminists, discovered the non-innocence of the category “woman”. That consciousness changes the geography of all previous categories; it denatures them as heat denatures a fragile protein. Cyborg feminists have to argue that “we” do not want any more natural matrix of unity and that no construction is whole. Innocence, and the corollary insistence on victimhood as the only ground for insight, has done enough damage. But the constructed revolutionary subject must give late 20th-century people pause as well. In the fraying of identities and in the reflexive strategies for constructing them, the possibility opens up for weaving something other than a shroud for the day after the apocalypse that so prophetically ends salvation history.

Both Marxist/socialist-feminisms and radical feminisms have simultaneously naturalized and denatured the category “woman” and consciousness of the social lives of “women”. Perhaps a schematic caricature can highlight both kinds of moves. Marxian-socialism is rooted in an analysis of wage labor which reveals class structure. The consequence of the wage relationship is systematic alienation, as the worker is dissociated from his [*sic*] product. Abstraction and illusion rule in knowledge, domination rules in practice. Labor is the pre-eminently privileged category enabling the Marxist to overcome illusion and find that point of view which is necessary for changing the world. Labor is the humanizing activity that makes man; labor is an ontological category permitting the knowledge of a subject, and so the knowledge of subjugation and alienation.

In faithful filiation, socialist-feminism is advanced by allying itself with the basic analytic strategies of Marxism. The main achievement of both Marxist-feminists and socialist-feminists was to expand the category of labor to accommodate what (some) women did, even when the wage relation was subordinated to a more comprehensive view of labor under capitalist patriarchy. In particular, women’s labor in the household and women’s activity as mothers generally (that is, reproduction in the socialist-feminist sense), entered theory on the authority of analogy to the Marxian concept of labor. The unity of women here rests on an epistemology based on the ontological structure of “labor”. Marxist/socialist-feminism does not “naturalize” unity; it is a possible achievement based on a possible standpoint rooted in social relations. The essentializing move is in the ontological structure of labor or of its analogue, women’s activity.<sup>11</sup> The inheritance of Marxian-humanism, with its pre-eminently Western self, is the difficulty for me. The contribution from these formulations has been the emphasis on the daily responsibility of real women to build unities, rather than to naturalize them.

Catherine MacKinnon’s (1982, 1987) version of radical feminism is itself a caricature of the appropriating, incorporating, totalizing tendencies of Western theories of identity grounding action.<sup>12</sup> It is factually and politically wrong to

assimilate all of the diverse “moments” or “conversations” in recent women’s politics named radical feminism to MacKinnon’s version. But the teleological logic of her theory shows how an epistemology and ontology—including their negations—erase or police difference. Only one of the effects of MacKinnon’s theory is the rewriting of the history of the polymorphous field called radical feminism. The major effect is the production of a theory of experience, of women’s identity, that is a kind of apocalypse for all revolutionary standpoints. That is, the totalization built into this tale of radical feminism achieves its end—the unity of women—by enforcing the experience of and testimony to radical non-being. As for the Marxist/socialist-feminist, consciousness is an achievement, not a natural fact. And MacKinnon’s theory eliminates some of the difficulties built into humanist revolutionary subjects, but at the cost of radical reductionism.

MacKinnon argues that feminism necessarily adopted a different analytical strategy from Marxism, looking first not at the structure of class, but at the structure of sex/gender and its generative relationship, men’s constitution and appropriation of women sexually. Ironically, MacKinnon’s “ontology” constructs a non-subject, a non-being. Another’s desire, not the self’s labor, is the origin of “woman”. She therefore develops a theory of consciousness that enforces what can count as “women’s” experience—anything that names sexual violation, indeed, sex itself as far as “women” can be concerned. Feminist practice is the construction of this form of consciousness; that is, the self-knowledge of a self-who-is-not.

Perversely, sexual appropriation in this feminism still has the epistemological status of labor; that is to say, the point from which an analysis able to contribute to changing the world must flow. But sexual objectification, not alienation, is the consequence of the structure of sex/gender. In the realm of knowledge, the result of sexual objectification is illusion and abstraction. However, a woman is not simply alienated from her product, but in a deep sense does not exist as a subject, or even potential subject, since she owes her existence as a woman to sexual appropriation. To be constituted by another’s desire is not the same thing as to be alienated in the violent separation of the laborer from his product.

MacKinnon’s radical theory of experience is totalizing in the extreme; it does not so much marginalize as obliterate the authority of any other women’s political speech and action. It is a totalization producing what Western patriarchy itself never succeeded in doing—feminists’ consciousness of the non-existence of women, except as products of men’s desire. I think MacKinnon correctly argues that no Marxian version of identity can firmly ground women’s unity. But in solving the problem of the contradictions of any Western revolutionary subject for feminist purposes, she develops an even more authoritarian doctrine of experience. If my complaint about socialist/Marxian standpoints is their unintended erasure of polyvocal, unassimilable, radical difference made visible in anti-colonial discourse and practice,

MacKinnon's intentional erasure of all difference through the device of the "essential" non-existence of women is not reassuring.

In my taxonomy, which like any other taxonomy is a re-inscription of history, radical feminism can accommodate all the activities of women named by socialist feminists as forms of labor only if the activity can somehow be sexualized. Reproduction had different tones of meanings for the two tendencies, one rooted in labor, one in sex, both calling the consequences of domination and ignorance of social and personal reality "false consciousness".

Beyond either the difficulties or the contributions in the argument of any one author, neither Marxist nor radical feminist points of view have tended to embrace the status of a partial explanation; both were regularly constituted as totalities. Western explanation has demanded as much; how else could the "Western" author incorporate its others? Each tried to annex other forms of domination by expanding its basic categories through analogy, simple listing, or addition. Embarrassed silence about race among white radical and socialist-feminists was one major, devastating political consequence. History and polyvocality disappear into political taxonomies that try to establish genealogies. There was no structural room for race (or for much else) in theory claiming to reveal the construction of the category woman and social group women as a unified or totalizable whole. The structure of my caricature looks like this: Socialist-feminism—structure of class // wage labor // alienation labor, by analogy reproduction, by extension sex, by addition race radical feminism—structure of gender // sexual appropriation // objectification sex, by analogy labor, by extension reproduction, by addition race.

In another context, the French theorist, Julia Kristeva, claimed women appeared as a historical group after the Second World War, along with groups like youth. Her dates are doubtful; but we are now accustomed to remembering that as objects of knowledge and as historical actors, "race" did not always exist, "class" has a historical genesis, and "homosexuals" are quite junior. It is no accident that the symbolic system of the family of man—and so the essence of woman—breaks up at the same moment that networks of connection among people on the planet are unprecedentedly multiple, pregnant, and complex. "Advanced capitalism" is inadequate to convey the structure of this historical moment. In the "Western" sense, the end of man is at stake. It is no accident that woman disintegrates into women in our time. Perhaps socialist feminists were not substantially guilty of producing essentialist theory that suppressed women's particularity and contradictory interests. I think we have been, at least through unreflective participation in the logics, languages, and practices of white humanism and through searching for a single ground of domination to secure our revolutionary voice. Now we have less excuse. But in the consciousness of our failures, we risk lapsing into boundless difference and giving up on the confusing task of making partial, real connection. Some differences are playful; some are poles of world historical systems of domination. "Epistemology" is about knowing the difference.

### 3. THE INFORMATICS OF DOMINATION

In this attempt at an epistemological and political position, I would like to sketch a picture of possible unity, a picture indebted to socialist and feminist principles of design. The frame for my sketch is set by the extent and importance of rearrangements in worldwide social relations tied to science and technology. I argue for a politics rooted in claims about fundamental changes in the nature of class, race, and gender in an emerging system of world order analogous in its novelty and scope to that created by industrial capitalism; we are living through a movement from an organic, industrial society to a polymorphous, information system—from all work to all play, a deadly game. Simultaneously material and ideological, the dichotomies may be expressed in the following chart of transitions from the comfortable old hierarchical dominations to the scary new networks I have called the informatics of domination:

Representation	Simulation
Bourgeois novel, realism	Science fiction, post-modernism
Organism	Biotic Component
Depth, integrity	Surface, boundary
Heat	Noise
Biology as clinical practice	Biology as inscription
Physiology	Communications engineering
Small group	Subsystem
Perfection	Optimization
Eugenics	Population Control
Decadence, Magic Mountain	Obsolescence, <i>Future Shock</i>
Hygiene	Stress Management
Microbiology, tuberculosis	Immunology, AIDS
Organic division of labor	Ergonomics/cybernetics of labor
Functional specialization	Modular construction
Reproduction	Replication
Organic sex role specialization	Optimal genetic strategies
Biological determinism	Evolutionary inertia, constraints
Community ecology	Ecosystem
Racial chain of being	Neo-imperialism, United Nations humanism
Scientific management in home/factory	Global factory/Electronic cottage
Family/Market/Factory	Women in the Integrated Circuit
Family wage	Comparable worth
Public/private	Cyborg citizenship
Nature/culture	Fields of difference
Co-operation	Communications enhancement
Freud	Lacan



Sex	Genetic engineering
Labor	Robotics
Mind	Artificial Intelligence
Second World War	Star Wars
White Capitalist Patriarchy	Informatics of Domination

This list suggests several interesting things.<sup>13</sup> First, the objects on the right-hand side cannot be coded as “natural”, a realization that subverts naturalistic coding for the left-hand side as well. We cannot go back ideologically or materially. It’s not just that “god” is dead; so is the “goddess”. Or both are revived in the worlds charged with microelectronic and biotechnological politics. In relation to objects like biotic components, one must not think in terms of essential properties, but in terms of design, boundary constraints, rates of flows, systems logics, costs of lowering constraints. Sexual reproduction is one kind of reproductive strategy among many, with costs and benefits as a function of the system environment. Ideologies of sexual reproduction can no longer reasonably call on notions of sex and sex role as organic aspects in natural objects like organisms and families. Such reasoning will be unmasked as irrational, and ironically corporate executives reading *Playboy* and anti-porn radical feminists will make strange bedfellows in jointly unmasking the irrationalism.

Likewise for race, ideologies about human diversity have to be formulated in terms of frequencies of parameters, like blood groups or intelligence scores. It is “irrational” to invoke concepts like primitive and civilized. For liberals and radicals, the search for integrated social systems gives way to a new practice called “experimental ethnography” in which an organic object dissipates in attention to the play of writing. At the level of ideology, we see translations of racism and colonialism into languages of development and under-development, rates and constraints of modernization. Any objects or persons can be reasonably thought of in terms of disassembly and reassembly; no “natural” architectures constrain system design. The financial districts in all the world’s cities, as well as the export-processing and free-trade zones, proclaim this elementary fact of “late capitalism”. The entire universe of objects that can be known scientifically must be formulated as problems in communications engineering (for the managers) or theories of the text (for those who would resist). Both are cyborg semiologies.

One should expect control strategies to concentrate on boundary conditions and interfaces, on rates of flow across boundaries—and not on the integrity of natural objects. “Integrity” or “sincerity” of the Western self gives way to decision procedures and expert systems. For example, control strategies applied to women’s capacities to give birth to new human beings will be developed in the languages of population control and maximization of goal achievement for individual decision-makers. Control strategies will be formulated in terms of rates, costs of constraints, degrees of freedom. Human beings, like

any other component or subsystem, must be localized in a system architecture whose basic modes of operation are probabilistic, statistical. No objects, spaces, or bodies are sacred in themselves; any component can be interfaced with any other if the proper standard, the proper code, can be constructed for processing signals in a common language. Exchange in this world transcends the universal translation effected by capitalist markets that Marx analyzed so well. The privileged pathology affecting all kinds of components in this universe is stress—communications breakdown (Hogness, 1983). The cyborg is not subject to Foucault's biopolitics; the cyborg simulates politics, a much more potent field of operations.

This kind of analysis of scientific and cultural objects of knowledge which have appeared historically since the Second World War prepares us to notice some important inadequacies in feminist analysis which has proceeded as if the organic, hierarchical dualisms ordering discourse in "the West" since Aristotle still ruled. They have been cannibalized, or as Zoe Sofia (Sofoulis) might put it, they have been "techno-digested". The dichotomies between mind and body, animal and human, organism and machine, public and private, nature and culture, men and women, primitive and civilized are all in question ideologically. The actual situation of women is their integration/exploitation into a world system of production/reproduction and communication called the informatics of domination. The home, workplace, market, public arena, the body itself—all can be dispersed and interfaced in nearly infinite, polymorphous ways, with large consequences for women and others—consequences that themselves are very different for different people and which make potent oppositional international movements difficult to imagine and essential for survival. One important route for reconstructing socialist-feminist politics is through theory and practice addressed to the social relations of science and technology, including crucially the systems of myth and meanings structuring our imaginations. The cyborg is a kind of disassembled and reassembled, post-modern collective and personal self. This is the self feminists must code.

Communications technologies and biotechnologies are the crucial tools re-crafting our bodies. These tools embody and enforce new social relations for women world-wide. Technologies and scientific discourses can be partially understood as formalizations, i.e., as frozen moments, of the fluid social interactions constituting them, but they should also be viewed as instruments for enforcing meanings. The boundary is permeable between tool and myth, instrument and concept, historical systems of social relations and historical anatomies of possible bodies, including objects of knowledge. Indeed, myth and tool mutually constitute each other.

Furthermore, communications sciences and modern biologies are constructed by a common move—the *translation of the world into a problem of coding*, a search for a common language in which all resistance to instrumental control disappears and all heterogeneity can be submitted to disassembly, reassembly, investment, and exchange.

In communications sciences, the translation of the world into a problem in coding can be illustrated by looking at cybernetic (feedback-controlled) systems theories applied to telephone technology, computer design, weapons deployment, or data base construction and maintenance. In each case, solution to the key questions rests on a theory of language and control; the key operation is determining the rates, directions, and probabilities of flow of a quantity called information. The world is subdivided by boundaries differentially permeable to information. Information is just that kind of quantifiable element (unit, basis of unity) which allows universal translation, and so unhindered instrumental power (called effective communication). The biggest threat to such power is interruption of communication. Any system breakdown is a function of stress. The fundamentals of this technology can be condensed into the metaphor C<sup>3</sup>I, command-control-communication-intelligence, the military's symbol for its operations theory.

In modern biologies, the translation of the world into a problem in coding can be illustrated by molecular genetics, ecology, sociobiological evolutionary theory, and immunobiology. The organism has been translated into problems of genetic coding and read-out. Biotechnology, a writing technology, informs research broadly.<sup>14</sup> In a sense, organisms have ceased to exist as objects of knowledge, giving way to biotic components, i.e., special kinds of information-processing devices. The analogous moves in ecology could be examined by probing the history and utility of the concept of the ecosystem. Immunobiology and associated medical practices are rich exemplars of the privilege of coding and recognition systems as objects of knowledge, as constructions of bodily reality for us. Biology here is a kind of cryptography. Research is necessarily a kind of intelligence activity. Ironies abound. A stressed system goes awry; its communication processes break down; it fails to recognize the difference between self and other. Human babies with baboon hearts evoke national ethical perplexity—for animal rights activists at least as much as for the guardians of human purity. In the US gay men and intravenous drug users are the “privileged” victims of an awful immune system disease that marks (inscribes on the body) confusion of boundaries and moral pollution (Treichler, 1987).

But these excursions into communications sciences and biology have been at a rarefied level; there is a mundane, largely economic reality to support my claim that these sciences and technologies indicate fundamental transformations in the structure of the world for us. Communications technologies depend on electronics. Modern states, multinational corporations, military power, welfare state apparatuses, satellite systems, political processes, fabrication of our imaginations, labor-control systems, medical constructions of our bodies, commercial pornography, the international division of labor, and religious evangelism depend intimately upon electronics. Micro-electronics is the technical basis of simulacra; that is, of copies without originals.

Microelectronics mediates the translations of labor into robotics and word processing, sex into genetic engineering and reproductive technologies, and mind into artificial intelligence and decision procedures. The new biotechnologies concern more than human reproduction. Biology as a powerful engineering science for redesigning materials and processes has revolutionary implications for industry, perhaps most obvious today in areas of fermentation, agriculture, and energy. Communications sciences and biology are constructions of natural-technical objects of knowledge in which the difference between machine and organism is thoroughly blurred; mind, body, and tool are on very intimate terms. The “multinational” material organization of the production and reproduction of daily life and the symbolic organization of the production and reproduction of culture and imagination seem equally implicated. The boundary-maintaining images of base and superstructure, public and private, or material and ideal never seemed more feeble.

I have used Rachel Grossman’s (1980) image of women in the integrated circuit to name the situation of women in a world so intimately restructured through the social relations of science and technology.<sup>15</sup> I used the odd circumlocution, “the social relations of science and technology”, to indicate that we are not dealing with a technological determinism, but with a historical system depending upon structured relations among people. But the phrase should also indicate that science and technology provide fresh sources of power, that we need fresh sources of analysis and political action (Latour, 1984). Some of the rearrangements of race, sex, and class rooted in high-tech-facilitated social relations can make socialist-feminism more relevant to effective progressive politics.

### **3.1. The “Homework Economy” Outside “The Home”**

The “New Industrial Revolution” is producing a new worldwide working class, as well as new sexualities and ethnicities. The extreme mobility of capital and the emerging international division of labor are intertwined with the emergence of new collectivities, and the weakening of familiar groupings. These developments are neither gender- nor race-neutral. White men in advanced industrial societies have become newly vulnerable to permanent job loss, and women are not disappearing from the job rolls at the same rates as men. It is not simply that women in Third World countries are the preferred labor force for the science-based multinationals in the export-processing sectors, particularly in electronics. The picture is more systematic and involves reproduction, sexuality, culture, consumption, and production. In the prototypical Silicon Valley, many women’s lives have been structured around employment in electronics-dependent jobs, and their intimate realities include serial heterosexual monogamy, negotiating childcare, distance from extended kin or most other forms of traditional community, a high likelihood of loneliness and

extreme economic vulnerability as they age. The ethnic and racial diversity of women in Silicon Valley structures a microcosm of conflicting differences in culture, family, religion, education, and language.

Richard Gordon has called this new situation the “homework economy”.<sup>16</sup> Although he includes the phenomenon of literal homework emerging in connection with electronics assembly, Gordon intends “homework economy” to name a restructuring of work that broadly has the characteristics formerly ascribed to female jobs, jobs literally done only by women. Work is being redefined as both literally female and feminized, whether performed by men or women. To be feminized means to be made extremely vulnerable; able to be disassembled, reassembled, exploited as a reserve labor force; seen less as workers than as servers; subjected to time arrangements on and off the paid job that make a mockery of a limited work day; leading an existence that always borders on being obscene, out of place, and reducible to sex. Deskilling is an old strategy newly applicable to formerly privileged workers. However, the homework economy does not refer only to large-scale deskilling, nor does it deny that new areas of high skill are emerging, even for women and men previously excluded from skilled employment. Rather, the concept indicates that factory, home, and market are integrated on a new scale and that the places of women are crucial—and need to be analyzed for differences among women and for meanings for relations between men and women in various situations.

The homework economy as a world capitalist organizational structure is made possible by (not caused by) the new technologies. The success of the attack on relatively privileged, mostly white, men’s unionized jobs is tied to the power of the new communications technologies to integrate and control labor despite extensive dispersion and decentralization. The consequences of the new technologies are felt by women both in the loss of the family (male) wage (if they ever had access to this white privilege) and in the character of their own jobs, which are becoming capital-intensive; for example, office work and nursing.

The new economic and technological arrangements are also related to the collapsing welfare state and the ensuing intensification of demands on women to sustain daily life for themselves as well as for men, children, and old people. The feminization of poverty—generated by dismantling the welfare state, by the homework economy where stable jobs become the exception, and sustained by the expectation that women’s wages will not be matched by a male income for the support of children—has become an urgent focus. The causes of various women-headed households are a function of race, class, or sexuality; but their increasing generality is a ground for coalitions of women on many issues. That women regularly sustain daily life partly as a function of their enforced status as mothers is hardly new; the kind of integration with the overall capitalist and progressively war-based economy is new. The particular pressure, for example, on US black women, who have achieved an escape from (barely) paid domestic service and who now hold clerical and similar jobs in large numbers,

has large implications for continued enforced black poverty *with* employment. Teenage women in industrializing areas of the Third World increasingly find themselves the sole or major source of a cash wage for their families, while access to land is ever more problematic. These developments must have major consequences in the psychodynamics and politics of gender and race.

Within the framework of three major stages of capitalism (commercial/early industrial, monopoly, multinational)—tied to nationalism, imperialism, and multinationalism, and related to Jameson's three dominant aesthetic periods of realism, modernism, and post-modernism—I would argue that specific forms of families dialectically relate to forms of capital and to its political and cultural concomitants. Although lived problematically and unequally, ideal forms of these families might be schematized as (1) the patriarchal nuclear family, structured by the dichotomy between public and private and accompanied by the white bourgeois ideology of separate spheres and 19th-century Anglo-American bourgeois feminism; (2) the modern family mediated (or enforced) by the welfare state and institutions like the family wage, with a flowering of a-feminist heterosexual ideologies, including their radical versions represented in Greenwich Village around the First World War; and (3) the "family" of the homework economy with its oxymoronic structure of women-headed households and its explosion of feminisms and the paradoxical intensification and erosion of gender itself.

This is the context in which the projections for worldwide structural unemployment stemming from the new technologies are part of the picture of the homework economy. As robotics and related technologies put men out of work in "developed" countries and exacerbate failure to generate male jobs in Third World "development", and as the automated office becomes the rule even in labor-surplus countries, the feminization of work intensifies. Black women in the United States have long known what it looks like to face the structural underemployment ("feminization") of black men, as well as their own highly vulnerable position in the wage economy. It is no longer a secret that sexuality, reproduction, family, and community life are interwoven with this economic structure in myriad ways which have also differentiated the situations of white and black women. Many more women and men will contend with similar situations, which will make cross-gender and race alliances on issues of basic life support (with or without jobs) necessary, not just nice.

The new technologies also have a profound effect on hunger and on food production for subsistence world-wide. Rae Lessor Blumberg (1983) estimates that women produce about 50% of the world's subsistence food.<sup>17</sup> Women are excluded generally from benefiting from the increased high-tech commodification of food and energy crops, their days are made more arduous because their responsibilities to provide food do not diminish, and their reproductive situations are made more complex. Green Revolution technologies interact with other high-tech industrial production to alter gender divisions of labor and differential gender migration patterns.

The new technologies seem deeply involved in the forms of “privatization” that Ros Petchesky (1981) has analyzed, in which militarization, right-wing family ideologies and policies, and intensified definitions of corporate (and state) property as private synergistically interact.<sup>18</sup> The new communications technologies are fundamental to the eradication of “public life” for everyone. This facilitates the mushrooming of a permanent high-tech military establishment at the cultural and economic expense of most people, but especially of women. Technologies like video games and highly miniaturized televisions seem crucial to production of modern forms of “private life”. The culture of video games is heavily orientated to individual competition and extraterrestrial warfare. High-tech, gendered imaginations are produced here, imaginations that can contemplate destruction of the planet and a science fiction escape from its consequences. More than our imaginations is militarized; and the other realities of electronic and nuclear warfare are inescapable. These are the technologies that promise ultimate mobility and perfect exchange—and incidentally enable tourism, that perfect practice of mobility and exchange, to emerge as one of the world’s largest single industries.

The new technologies affect the social relations of both sexuality and of reproduction, and not always in the same ways. The close ties of sexuality and instrumentality, of views of the body as a kind of private satisfaction- and utility-maximizing machine, are described nicely in sociobiological origin stories that stress a genetic calculus and explain the inevitable dialectic of domination of male and female gender roles.<sup>19</sup> These sociobiological stories depend on a high-tech view of the body as a biotic component or cybernetic communications system. Among the many transformations of reproductive situations is the medical one, where women’s bodies have boundaries newly permeable to both “visualization” and “intervention”. Of course, who controls the interpretation of bodily boundaries in medical hermeneutics is a major feminist issue. The speculum served as an icon of women’s claiming their bodies in the 1970S; that handcraft tool is inadequate to express our needed body politics in the negotiation of reality in the practices of cyborg reproduction. Self-help is not enough. The technologies of visualization recall the important cultural practice of hunting with the camera and the deeply predatory nature of a photographic consciousness.<sup>20</sup> Sex, sexuality, and reproduction are central actors in high-tech myth systems structuring our imaginations of personal and social possibility.

Another critical aspect of the social relations of the new technologies is the reformulation of expectations, culture, work, and reproduction for the large scientific and technical work-force. A major social and political danger is the formation of a strongly bimodal social structure, with the masses of women and men of all ethnic groups, but especially people of color, confined to a homework economy, illiteracy of several varieties, and general redundancy and impotence, controlled by high-tech repressive apparatuses ranging from entertainment to surveillance and disappearance. An adequate

socialist-feminist politics should address women in the privileged occupational categories, and particularly in the production of science and technology that constructs scientific-technical discourses, processes, and objects.<sup>21</sup>

This issue is only one aspect of enquiry into the possibility of a feminist science, but it is important. What kind of constitutive role in the production of knowledge, imagination, and practice can new groups doing science have? How can these groups be allied with progressive social and political movements? What kind of political accountability can be constructed to the women together across the scientific-technical hierarchies separating us? Might there be ways of developing feminist science/technology politics in alliance with and-military science facility conversion action groups? Many scientific and technical workers in Silicon Valley, the high-tech cowboys included, do not want to work on military science.<sup>22</sup> Can these personal preferences and cultural tendencies be welded into progressive politics among this professional middle class in which women, including women of color, are coming to be fairly numerous?

#### 4. WOMEN IN THE INTEGRATED CIRCUIT

Let me summarize the picture of women's historical locations in advanced industrial societies, as these positions have been restructured partly through the social relations of science and technology. If it was ever possible ideologically to characterize women's lives by the distinction of public and private domains—suggested by images of the division of working-class life into factory and home, of bourgeois life into market and home, and of gender existence into personal and political realms—it is now a totally misleading ideology, even to show how both terms of these dichotomies construct each other in practice and in theory. I prefer a network ideological image, suggesting the profusion of spaces and identities and the permeability of boundaries in the personal body and in the body politic. “Networking” is both a feminist practice and a multinational corporate strategy—weaving is for oppositional cyborgs.

So let me return to the earlier image of the informatics of domination and trace one vision of women's “place” in the integrated circuit, touching only a few idealized social locations seen primarily from the point of view of advanced capitalist societies: Home, Market, Paid Work Place, State, School, Clinic-Hospital, and Church. Each of these idealized spaces is logically and practically implied in every other locus, perhaps analogous to a holographic photograph. I want to suggest the impact of the social relations mediated and enforced by the new technologies in order to help formulate needed analysis and practical work. However, there is no “place” for women in these networks, only geometries of difference and contradiction crucial to women's cyborg identities. If we learn how to read these webs of power and social life, we might learn new couplings, new coalitions. There is no way to read the following list



from a standpoint of “identification”, of a unitary self. The issue is dispersion. The task is to survive in the diaspora.

*Home:* Women-headed households, serial monogamy, flight of men, old women alone, technology of domestic work, paid homework, re-emergence of home sweat-shops, home-based businesses and telecommuting, electronic cottage, urban homelessness, migration, module architecture, reinforced (simulated) nuclear family, intense domestic violence.

*Market:* Women’s continuing consumption work, newly targeted to buy the profusion of new production from the new technologies (especially as the competitive race among industrialized and industrializing nations to avoid dangerous mass unemployment necessitates finding ever bigger new markets for ever less clearly needed commodities); bimodal buying power, coupled with advertising targeting of the numerous affluent groups and neglect of the previous mass markets; growing importance of informal markets in labour and commodities parallel to high-tech, affluent market structures; surveillance systems through electronic funds transfer; intensified market abstraction (commodification) of experience, resulting in ineffective utopian or equivalent cynical theories of community; extreme mobility (abstraction) of marketing/financing systems; inter-penetration of sexual and labour markets; intensified sexualization of abstracted and alienated consumption.

*Paid Work Place:* Continued intense sexual and racial division of labour, but considerable growth of membership in privileged occupational categories for many white women and people of colour; impact of new technologies on women’s work in clerical, service, manufacturing (especially textiles), agriculture, electronics; international restructuring of the working classes; development of new time arrangements to facilitate the homework economy (flex-time, part-time, over-time, no time); homework and out work; increased pressures for two-tiered wage structures; significant numbers of people in cash-dependent populations worldwide with no experience or no further hope of stable employment; most labour “marginal” or “feminized”.

*State:* Continued erosion of the welfare state; decentralizations with increased surveillance and control; citizenship by telematics; imperialism and political power broadly in the form of information rich/information poor differentiation; increased high-tech militarization increasingly opposed by many social groups; reduction of civil service jobs as a result of the growing capital intensification of office work, with implications for occupational mobility for women of colour; growing privatization

of material and ideological life and culture; close integration of privatization and militarization, the high-tech forms of bourgeois capitalist personal and public life; invisibility of different social groups to each other, linked to psychological mechanisms of belief in abstract enemies.

*School:* Deepening coupling of high-tech capital needs and public education at all levels, differentiated by race, class, and gender; managerial classes involved in educational reform and refunding at the cost of remaining progressive educational democratic structures for children and teachers; education for mass ignorance and repression in technocratic and militarized culture; growing and-science mystery cults in dissenting and radical political movements; continued relative scientific illiteracy among white women and people of colour; growing industrial direction of education (especially higher education) by science-based multinationals (particularly in electronics- and biotechnology-dependent companies); highly educated, numerous elites in a progressively bimodal society.

*Clinic-hospital:* Intensified machine-body relations; renegotiations of public metaphors which channel personal experience of the body, particularly in relation to reproduction, immune system functions, and “stress” phenomena; intensification of reproductive politics in response to world historical implications of women’s unrealized, potential control of their relation to reproduction; emergence of new, historically specific diseases; struggles over meanings and means of health in environments pervaded by high technology products and processes; continuing feminization of health work; intensified struggle over state responsibility for health; continued ideological role of popular health movements as a major form of American politics.

*Church:* Electronic fundamentalist “super-saver” preachers solemnizing the union of electronic capital and automated fetish gods; intensified importance of churches in resisting the militarized state; central struggle over women’s meanings and authority in religion; continued relevance of spirituality, intertwined with sex and health, in political struggle.

The only way to characterize the informatics of domination is as a massive intensification of insecurity and cultural impoverishment, with common failure of subsistence networks for the most vulnerable. Since much of this picture interweaves with the social relations of science and technology, the urgency of a socialist-feminist politics addressed to science and technology is plain. There is much now being done, and the grounds for political work are rich. For example, the efforts to develop forms of collective struggle for women in paid work, like SEIU’s District 925 (Service Employees International Union’s

office worker's organization in the US), should be a high priority for all of us. These efforts are profoundly tied to technical restructuring of labor processes and reformations of working classes. These efforts also are providing understanding of a more comprehensive kind of labor organization, involving community, sexuality, and family issues never privileged in the largely white male industrial unions.

The structural rearrangements related to the social relations of science and technology evoke strong ambivalence. But it is not necessary to be ultimately depressed by the implications of late 20th-century women's relation to all aspects of work, culture, production of knowledge, sexuality, and reproduction. For excellent reasons, most Marxisms see domination best and have trouble understanding what can only look like false consciousness and people's complicity in their own domination in late capitalism. It is crucial to remember that what is lost, perhaps especially from women's points of view, is often virulent forms of oppression, nostalgically naturalized in the face of current violation. Ambivalence towards the disrupted unities mediated by high-tech culture requires not sorting consciousness into categories of clear-sighted critique grounding a solid political epistemology' versus "manipulated false consciousness", but subtle understanding of emerging pleasures, experiences, and powers with serious potential for changing the rules of the game.

There are grounds for hope in the emerging bases for new kinds of unity across race, gender, and class, as these elementary units of socialist-feminist analysis themselves suffer protean transformations. Intensifications of hardship experienced worldwide in connection with the social relations of science and technology are severe. But what people are experiencing is not transparently clear, and we lack sufficiently subtle connections for collectively building effective theories of experience. Present efforts—Marxist, psychoanalytic, feminist, anthropological—to clarify even "our" experience are rudimentary.

I am conscious of the odd perspective provided by my historical position—a PhD in biology for an Irish Catholic girl was made possible by Sputnik's impact on US national science-education policy. I have a body and mind as much constructed by the post-Second World War arms race and cold war as by the women's movements. There are more grounds for hope in focusing on the contradictory effects of politics designed to produce loyal American technocrats, which also produced large numbers of dissidents, than in focusing on the present defeats.

The permanent partiality of feminist points of view has consequences for our expectations of forms of political organization and participation. We do not need a totality in order to work well. The feminist dream of a common language, like all dreams for a perfectly true language, of perfectly faithful naming of experience, is a totalizing and imperialist one. In that sense, dialectics too is a dream language, longing to resolve contradiction. Perhaps, ironically, we can learn from our fusions with animals and machines how not to be Man, the embodiment of Western logos. From the point of view of

pleasure in these potent and taboo fusions, made inevitable by the social relations of science and technology, there might indeed be a feminist science.

## 5. CYBORGS: A MYTH OF POLITICAL IDENTITY

I want to conclude with a myth about identity and boundaries which might inform late 20th-century political imaginations. I am indebted in this story to writers like Joanna Russ, Samuel R. Delany, John Varley, James Tiptree, Jr., Octavia Butler, Monique Wittig, and Vonda McIntyre.<sup>23</sup> These are our storytellers exploring what it means to be embodied in high-tech worlds. They are theorists for cyborgs. Exploring conceptions of bodily boundaries and social order, the anthropologist Mary Douglas (1966, 1970) should be credited with helping us to consciousness about how fundamental body imagery is to world view, and so to political language.

French feminists like Luce Irigaray and Monique Wittig, for all their differences, know how to write the body; how to weave eroticism, cosmology, and politics from imagery of embodiment, and especially for Wittig, from imagery of fragmentation and reconstitution of bodies.<sup>24</sup>

American radical feminists like Susan Griffon, Audre Lorde, and Adrienne Rich have profoundly affected our political imaginations—and perhaps restricted too much what we allow as a friendly body and political language.<sup>25</sup> They insist on the organic, opposing it to the technological. But their symbolic systems and the related positions of ecofeminism and feminist paganism, replete with organicisms, can only be understood in Sandoval's terms as oppositional ideologies fitting the late 20th century. They would simply bewilder anyone not pre-occupied with the machines and consciousness of late capitalism. In that sense they are part of the cyborg world. But there are also great riches for feminists in explicitly embracing the possibilities inherent in the breakdown of clean distinctions between organism and machine and similar distinctions structuring the Western self. It is the simultaneity of breakdowns that cracks the matrices of domination and opens geometric possibilities. What might be learned from personal and political “technological” pollution? I look briefly at two overlapping groups of texts for their insight into the construction of a potentially helpful cyborg myth: Constructions of women of color and monstrous selves in feminist science fiction.

Earlier I suggested that “women of colour” might be understood as a cyborg identity, a potent subjectivity synthesized from fusions of outsider identities and, in the complex political-historical layerings of her “biomythography”, *Zami* (Lorde, 1982; King, 1987a, 1987b). There are material and cultural grids mapping this potential. Audre Lorde (1984) captures the tone in the title of her *Sister Outsider*. In my political myth, Sister Outsider is the offshore woman, whom US workers, female and feminized, are supposed to regard as the enemy preventing their solidarity, threatening their security. Onshore,

inside the boundary of the United States, Sister Outsider is a potential amidst the races and ethnic identities of women manipulated for division, competition, and exploitation in the same industries. “Women of colour” are the preferred labor force for the science-based industries, the real women for whom the worldwide sexual market, labor market, and politics of reproduction kaleidoscope into daily life. Young Korean women hired in the sex industry and in electronics assembly are recruited from high schools, educated for the integrated circuit. Literacy, especially in English, distinguishes the “cheap” female labor so attractive to the multinationals.

Contrary to orientalist stereotypes of the “oral primitive”, literacy is a special mark of women of color, acquired by US black women as well as men through a history of risking death to learn and to teach reading and writing. Writing has a special significance for all colonized groups. Writing has been crucial to the Western myth of the distinction between oral and written cultures, primitive and civilized mentalities, and more recently to the erosion of that distinction in “post-modernist” theories attacking the phallogocentrism of the West, with its worship of the monotheistic, phallic, authoritative, and singular work, the unique and perfect name.<sup>26</sup> Contests for the meanings of writing are a major form of contemporary political struggle. Releasing the play of writing is deadly serious. The poetry and stories of US women of color are repeatedly about writing, about access to the power to signify; but this time that power must be neither phallic nor innocent. Cyborg writing must not be about the Fall, the imagination of a once-upon-a-time wholeness before language, before writing, before Man. Cyborg writing is about the power to survive, not on the basis of original innocence, but on the basis of seizing the tools to mark the world that marked them as other.

The tools are often stories, retold stories, versions that reverse and displace the hierarchical dualisms of naturalized identities. In retelling origin stories, cyborg authors subvert the central myths of origin of Western culture. We have all been colonized by those origin myths, with their longing for fulfilment in apocalypse. The phallogocentric origin stories most crucial for feminist cyborgs are built into the literal technologies—technologies that write the world, biotechnology and microelectronics—that have recently textualized our bodies as code problems on the grid of C<sup>3</sup>I. Feminist cyborg stories have the task of recoding communication and intelligence to subvert command and control.

Figuratively and literally, language politics pervade the struggles of women of color; and stories about language have a special power in the rich contemporary writing by US women of color. For example, retellings of the story of the indigenous woman Malinche, mother of the mesdzo “bastard” race of the new world, master of languages, and mistress of Cortes, carry special meaning for Chicana constructions of identity. Cherríe Moraga (1983) in *Loving in the War Years* explores the themes of identity when one never possessed the original language, never told the original story, never resided in the harmony of

legitimate heterosexuality in the garden of culture, and so cannot base identity on a myth or a fall from innocence and right to natural names, mother's or father's.<sup>27</sup> Moraga's writing, her superb literacy, is presented in her poetry as the same kind of violation as Malinche's mastery of the conqueror's language—a violation, an illegitimate production, that allows survival. Moraga's language is not “whole”; it is self-consciously spliced, a chimera of English and Spanish, both conqueror's languages. But it is this chimeric monster, without claim to an original language before violation, that crafts the erotic, competent, potent identities of women of color. Sister Outsider hints at the possibility of world survival not because of her innocence, but because of her ability to live on the boundaries, to write without the founding myth of original wholeness, with its inescapable apocalypse of final return to a deathly oneness that Man has imagined to be the innocent and all-powerful Mother, freed at the End from another spiral of appropriation by her son. Writing marks Moraga's body, affirms it as the body of a woman of color, against the possibility of passing into the unmarked category of the Anglo father or into the orientalist myth of “original illiteracy” of a mother that never was. Malinche was mother here, not Eve before eating the forbidden fruit. Writing affirms Sister Outsider, not the Woman-before-the-Fall-into-Writing needed by the phallogocentric Family of Man.

Writing is pre-eminently the technology of cyborgs, etched surfaces of the late 20th century. Cyborg politics is the struggle for language and the struggle against perfect communication, against the one code that translates all meaning perfectly, the central dogma of phallogocentrism. That is why cyborg politics insist on noise and advocate pollution, rejoicing in the illegitimate fusions of animal and machine. These are the couplings which make Man and Woman so problematic, subverting the structure of desire, the force imagined to generate language and gender, and so subverting the structure and modes of reproduction of “Western” identity, of nature and culture, of mirror and eye, slave and master, body and mind. “We” did not originally choose to be cyborgs, but choice grounds a liberal politics and epistemology that imagines the reproduction of individuals before the wider replications of “texts”.

From the perspective of cyborgs, freed of the need to ground politics in “our” privileged position of the oppression that incorporates all other dominations, the innocence of the merely violated, the ground of those closer to nature, we can see powerful possibilities. Feminisms and Marxisms have run aground on Western epistemological imperatives to construct a revolutionary subject from the perspective of a hierarchy of oppressions and/or a latent position of moral superiority, innocence, and greater closeness to nature. With no available original dream of a common language or original symbiosis promising protection from hostile “masculine” separation, but written into the play of a text that has no finally privileged reading or salvation history, to recognize “oneself” as fully implicated in the world, frees us of the need to root politics in identification, vanguard parties, purity, and mothering. Stripped of identity,

the bastard race teaches about the power of the margins and the importance of a mother like Malinche. Women of color have transformed her from the evil mother of masculinist fear into the originally literate mother who teaches survival.

This is not just literary deconstruction, but liminal transformation. Every story that begins with original innocence and privileges the return to wholeness imagines the drama of life to be individuation, separation, the birth of the self, the tragedy of autonomy, the fall into writing, alienation; that is, war, tempered by imaginary respite in the bosom of the other. These plots are ruled by a reproductive politics—rebirth without flaw, perfection, abstraction. In this plot women are imagined either better or worse off, but all agree they have less selfhood, weaker individuation, more fusion to the oral, to Mother, less at stake in masculine autonomy. But there is another route to having less at stake in masculine autonomy, a route that does not pass through woman, primitive, zero, the mirror stage and its imaginary. It passes through women and other present-tense, illegitimate cyborgs, not of Woman born, who refuse the ideological resources of victimization so as to have a real life. These cyborgs are the people who refuse to disappear on cue, no matter how many times a “western” commentator remarks on the sad passing of another primitive, another organic group done in by “Western” technology, by writing.<sup>28</sup> These real-life cyborgs (for example, the Southeast Asian village women workers in Japanese and US electronics firms described by Aihwa Ong) are actively rewriting the texts of their bodies and societies. Survival is the stakes in this play of readings.

To recapitulate, certain dualisms have been persistent in Western traditions; they have all been systemic to the logics and practices of domination of women, people of colour, nature, workers, animals—in short, domination of all constituted as others, whose task is to mirror the self. Chief among these troubling dualisms are self/other, mind/body, culture/nature, male/female, civilized/primitive, reality/appearance, whole/part, agent/resource, maker/made, active/passive, right/wrong, truth/illusion, total/partial, God/man. The self is the One who is not dominated, who knows that by the service of the other, the other is the one who holds the future, who knows that by the experience of domination, which gives the lie to the autonomy of the self. To be One is to be autonomous, to be powerful, to be God; but to be One is to be an illusion, and so to be involved in a dialectic of apocalypse with the other. Yet to be other is to be multiple, without clear boundary, frayed, insubstantial. One is too few, but two are too many.

High-tech culture challenges these dualisms in intriguing ways. It is not clear who makes and who is made in the relation between human and machine. It is not clear what is mind and what body in machines that resolve into coding practices. In so far as we know ourselves in both formal discourse (for example, biology) and in daily practice (for example, the homework economy in the integrated circuit), we find ourselves to be cyborgs, hybrids, mosaics, and

chimeras. Biological organisms have become biotic systems, communications devices like others. There is no fundamental, ontological separation in our formal knowledge of machine and organism, of technical and organic. The replicant Rachel in the Ridley Scott film *Blade Runner* stands as the image of a cyborg culture's fear, love, and confusion.

One consequence is that our sense of connection to our tools is heightened. The trance state experienced by many computer users has become a staple of science-fiction film and cultural jokes. Perhaps paraplegics and other severely handicapped people can (and sometimes do) have the most intense experiences of complex hybridization with other communication devices.<sup>29</sup> Anne McCaffrey's pre-feminist *The Ship Who Sang* (1969) explored the consciousness of a cyborg, hybrid of girl's brain and complex machinery, formed after the birth of a severely handicapped child. Gender, sexuality, embodiment, skill: All were reconstituted in the story. Why should our bodies end at the skin, or include at best other beings encapsulated by skin? From the 17th century till now, machines could be animated—given ghostly souls to make them speak or move or to account for their orderly development and mental capacities. Or organisms could be mechanized—reduced to body understood as resource of mind. These machine/organism relationships are obsolete, unnecessary. For us, in imagination and in other practice, machines can be prosthetic devices, intimate components, friendly selves. We don't need organic holism to give impermeable wholeness, the total woman and her feminist variants (mutants?). Let me conclude this point by a very partial reading of the logic of the cyborg monsters of my second group of texts, feminist science fiction.

The cyborgs populating feminist science fiction make very problematic the statuses of man or woman, human, artifact, member of a race, individual entity, or body. Katie King clarifies how pleasure in reading these fictions is not largely based on identification. Students facing Joanna Russ for the first time, students who have learned to take modernist writers like James Joyce or Virginia Woolf without flinching, do not know what to make of *The Adventures of Alyx* or *The Female Man*, where characters refuse the reader's search for innocent wholeness while granting the wish for heroic quests, exuberant eroticism, and serious politics. *The Female Man* is the story of four versions of one genotype, all of whom meet, but even taken together do not make a whole, resolve the dilemmas of violent moral action, or remove the growing scandal of gender. The feminist science fiction of Samuel R. Delany, especially *Tales of Neveyon*, mocks stories of origin by redoing the neolithic revolution, replaying the founding moves of Western civilization to subvert their plausibility. James Tiptree, Jr., an author whose fiction was regarded as particularly manly until her "true" gender was revealed, tells tales of reproduction based on non-mammalian technologies like alternation of generations of male brood pouches and male nurturing. John Varley constructs a supreme cyborg in his arch-feminist exploration of Gaea, a mad goddess-planet-trickster-old woman-technological device on whose surface an extraordinary array of



post-cyborg symbioses are spawned. Octavia Butler writes of an African sorceress pitting her powers of transformation against the genetic manipulations of her rival (*Wild Seed*), of time warps that bring a modern US black woman into slavery where her actions in relation to her white master-ancestor determine the possibility of her own birth (*Kindred*), and of the illegitimate insights into identity and community of an adopted cross-species child who came to know the enemy as self (*Survivor*). In *Dawn* (1987), the first instalment of a series called *Xenogenesis*, Butler tells the story of Lilith Iyapo, whose personal name recalls Adam's first and repudiated wife and whose family name marks her status as the widow of the son of Nigerian immigrants to the US. A black woman and a mother whose child is dead, Lilith mediates the transformation of humanity through genetic exchange with extra-terrestrial lovers/rescuers/destroyers/genetic engineers, who reform earth's habitats after the nuclear holocaust and coerce surviving humans into intimate fusion with them. It is a novel that interrogates reproductive, linguistic, and nuclear politics in a mythic field structured by late 20th-century race and gender.

Because it is particularly rich in boundary transgressions, Vonda McIntyre's *Superluminal* can close this truncated catalogue of promising and dangerous monsters who help redefine the pleasures and politics of embodiment and feminist writing. In a fiction where no character is "simply" human, human status is highly problematic. Orca, a genetically altered diver, can speak with killer whales and survive deep ocean conditions, but she longs to explore space as a pilot, necessitating bionic implants jeopardizing her kinship with the divers and cetaceans. Transformations are effected by virus vectors carrying a new developmental code, by transplant surgery, by implants of microelectronic devices, by analogue doubles, and other means. Lacnea becomes a pilot by accepting a heart implant and a host of other alterations allowing survival in transit at speeds exceeding that of light. Radu Dracul survives a virus-caused plague in his outerworld planet to find himself with a time sense that changes the boundaries of spatial perception for the whole species. All the characters explore the limits of language; the dream of communicating experience; and the necessity of limitation, partiality, and intimacy even in this world of protean transformation and connection. *Superluminal* stands also for the defining contradictions of a cyborg world in another sense; it embodies textually the intersection of feminist theory and colonial discourse in the science fiction I have alluded to in this chapter. This is a conjunction with a long history that many "First World" feminists have tried to repress, including myself in my readings of *Superluminal* before being called to account by Zoe Sofoulis, whose different location in the world system's informatics of domination made her acutely alert to the imperialist moment of all science fiction cultures, including women's science fiction. From an Australian feminist sensitivity, Sofoulis remembered more readily McIntyre's role as writer of the adventures of Captain Kirk and Spock in TV's *Star Trek* series than her rewriting the romance in *Superluminal*.

Monsters have always defined the limits of community in Western imaginations. The Centaurs and Amazons of ancient Greece established the limits of the centered polis of the Greek male human by their disruption of marriage and boundary pollutions of the warrior with animality and woman. Unseparated twins and hermaphrodites were the confused human material in early modern France who grounded discourse on the natural and supernatural, medical and legal, portents and diseases—all crucial to establishing modern identity.<sup>30</sup> The evolutionary and behavioral sciences of monkeys and apes have marked the multiple boundaries of late 20th-century industrial identities. Cyborg monsters in feminist science fiction define quite different political possibilities and limits from those proposed by the mundane fiction of Man and Woman.

There are several consequences to taking seriously the imagery of cyborgs as other than our enemies. Our bodies, ourselves; bodies are maps of power and identity. Cyborgs are no exception. A cyborg body is not innocent; it was not born in a garden; it does not seek unitary identity and so generate antagonistic dualisms without end (or until the world ends); it takes irony for granted. One is too few, and two is only one possibility. Intense pleasure in skill, machine skill, ceases to be a sin, but an aspect of embodiment. The machine is not an *it* to be animated, worshipped, and dominated. The machine is us, our processes, an aspect of our embodiment. We can be responsible for machines; *they* do not dominate or threaten us. We are responsible for boundaries; we are they. Up till now (once upon a time), female embodiment seemed to be given, organic, necessary; and female embodiment seemed to mean skill in mothering and its metaphoric extensions. Only by being out of place could we take intense pleasure in machines, and then with excuses that this was organic activity after all, appropriate to females. Cyborgs might consider more seriously the partial, fluid, sometimes aspect of sex and sexual embodiment. Gender might not be global identity after all, even if it has profound historical breadth and depth.

The ideologically charged question of what counts as daily activity, as experience, can be approached by exploiting the cyborg image. Feminists have recently claimed that women are given to dailiness, that women more than men somehow sustain daily life, and so have a privileged epistemological position potentially. There is a compelling aspect to this claim, one that makes visible unvalued female activity and names it as the ground of life. But *the* ground of life? What about all the ignorance of women, all the exclusions and failures of knowledge and skill? What about men's access to daily competence, to knowing how to build things, to take them apart, to play? What about other embodiments? Cyborg gender is a local possibility taking a global vengeance. Race, gender, and capital require a cyborg theory of wholes and parts. There is no drive in cyborgs to produce total theory, but there is an intimate experience of boundaries, their construction, and deconstruction. There is a myth system waiting to become a political language to ground one way of looking at science and technology and challenging the informatics of domination—in order to act potently.

One last image organisms and organismic, holistic politics depend on metaphors of rebirth and invariably call on the resources of reproductive sex. I would suggest that cyborgs have more to do with regeneration and are suspicious of the reproductive matrix and of most birthing. For salamanders, regeneration after injury, such as the loss of a limb, involves regrowth of structure and restoration of function with the constant possibility of twinning or other odd topographical productions at the site of former injury. The regrown limb can be monstrous, duplicated, potent. We have all been injured, profoundly. We require regeneration, not rebirth, and the possibilities for our reconstitution include the utopian dream of the hope for a monstrous world without gender.

Cyborg imagery can help express two crucial arguments in this essay: First, the production of universal, totalizing theory is a major mistake that misses most of reality, probably always, but certainly now; and second, taking responsibility for the social relations of science and technology means refusing an anti-science metaphysics, a demonology of technology, and so means embracing the skilful task of reconstructing the boundaries of daily life, in partial connection with others, in communication with all of our parts. It is not just that science and technology are possible means of great human satisfaction, as well as a matrix of complex dominations. Cyborg imagery can suggest a way out of the maze of dualisms in which we have explained our bodies and our tools to ourselves. This is a dream not of a common language, but of a powerful infidel heteroglossia. It is an imagination of a feminist speaking in tongues to strike fear into the circuits of the supersavers of the new right. It means both building and destroying machines, identities, categories, relationships, space stories. Though both are bound in the spiral dance, I would rather be a cyborg than a goddess.

#### ENDNOTES

1. Useful references to left and/or feminist radical science movements and theory and to biological/biotechnical issues include: Bleier (1984, 1986), Fausto-Sterling (1985), Gould (1981), Harding (1986), Hubbard et al. (1982), Keller (1985), Lewontin et al. (1984), *Radical Science* journal (became *Science as Culture* in 1987), 26 Freegrove Road, London N7 9RQ; *Science for the People*, 897 Main St, Cambridge, MA 02139.
2. Starting points for left and/or feminist approaches to technology and politics include: Athanasiou (1987), Cohn (1987a, b), Cowan (1983), Edwards (1985), Rothschild (1983), Traweek (1988), Weizenbaum (1976), Winner (1977, 1986), Winograd and Flores (1986), Young and Levitow (1981, 1985), Zimmerman (1983). *Global Electronics Newsletter*, 867 West Dana St, no. 204, Mountain View, CA 94041; *Processed World*, 55 Sutter St, San Francisco, CA 94104.

3. A provocative, comprehensive argument about the politics and theories of “postmodernism” is made by Fredric Jameson (1984), who argues that postmodernism is not an option, a style among others, but a cultural dominant requiring radical reinvention of left politics from within; there is no longer any place from without that gives meaning to the comforting fiction of critical distance. Jameson also makes clear why one cannot be for or against postmodernism, an essentially moralist move. My position is that feminists (and others) need continuous cultural reinvention, post-modernist critique, and historical materialism; only a cyborg would have a chance. The old dominations of white capitalist patriarchy seem nostalgically innocent now: they normalized heterogeneity, into man and woman, white and black, for example. “Advanced capitalism” and post-modernism release heterogeneity without a norm, and we are flattened, without subjectivity, which requires depth, even unfriendly and drowning depths. It is time to write *The Death of the Clinic*. The clinics methods required bodies and works; we have texts and surfaces. Our dominations don’t work by medicalization and normalization any more; they work by networking, communications re-design, stress management. Normalization gives way to automation, utter redundancy. Michel Foucault’s *Birth of the Clinic* (1963), *History of Sexuality* (1976), and *Discipline and Punish* (1975) name a form of power at its moment of implosion. The discourse of biopolitics gives way to technobabble, the language of the spliced substantive; no noun is left whole by the multinationals. These are their names, listed from one issue of *Science*: Tech-Knowledge, Genentech, Allergen, Hybritech, Compu-pro, Genen-cor, Syntex, Allelix, Agrigenetics Corp., Syntro, Codon, Repligen, MicroAngelo from Scion Corp., Pencom Data, Inter Systems, Cyborg Corp., Statcom Corp., Intertec. If we are imprisoned by language, then escape from that prison-house requires language poets, a kind of cultural restriction enzyme to cut the code; cyborg heteroglossia is one form of radical cultural politics. For cyborg poetry, see Perloff (1984); Fraser (1984). For feminist modernist/postmodernist “cyborg” writing, see HOW(ever), 871 Corbett Ave, San Francisco, CA 94131.
4. Baudrillard (1983). Jameson (1984: 66) points out that Plato’s definition of the simulacrum is the copy for which there is no original, i.e., the world of advanced capitalism, of pure exchange. See *Discourse 9* (Spring/Summer 1987) for a special issue on technology (cybernetics, ecology, and the post-modern imagination).
5. A practice at once both spiritual and political that linked guards and arrested anti-nuclear demonstrators in the Alameda County jail in California in the early 1980s.
6. For ethnographic accounts and political evaluations, see Epstein (1993); Sturgeon (1986). Without explicit irony, adopting the spaceship

earth/whole earth logo of the planet photographed from space, set off by the slogan “Love Your Mother”, the May 1987 Mothers and Others Day action at the nuclear weapons testing facility in Nevada none the less took account of the tragic contradictions of views of the earth. Demonstrators applied for official permits to be on the land from officers of the Western Shoshone tribe, whose territory was invaded by the US government when it built the nuclear weapons test ground in the 1950s. Arrested for trespassing, the demonstrators argued that the police and weapons facility personnel, without authorization from the proper officials, were the trespassers. One affinity group at the women’s action called themselves the Surrogate Others; and in solidarity with the creatures forced to tunnel in the same ground with the bomb, they enacted a cyborgian emergence from the constructed body of a large, non-heterosexual desert worm.

7. Powerful developments of coalition politics emerge from “Third World” speakers, speaking from nowhere, the displaced centre of the universe, earth: “We live on the third planet from the sun”—*Sun Poem* by Jamaican writer, Edward Kamau Braithwaite, review by Mackey (1984). Contributors to Smith (1983) ironically subvert naturalized identities precisely while constructing a place from which to speak called home. See especially Reagon (in Smith 1983: 356–68). Trinh T. Minh-ha (1986–87).
8. Hooks (1981, 1984); Hull *et al.* (1982). Bambara (1981) wrote an extraordinary novel in which the women of color theatre group, The Seven Sisters, explores a form of unity. See analysis by Butler-Evans (1987).
9. On orientalism in feminist works and elsewhere, see Lowe (1986); Mohanty (1984); Said (1978); Many Voices, *One Chant: Black Feminist Perspectives* (1984).
10. Katie King (1986, 1987a) has developed a theoretically sensitive treatment of the workings of feminist taxonomies as genealogies of power in feminist ideology and polemic. King examines Jaggar’s (1983) problematic example of taxonomizing feminisms to make a little machine producing the desired final position. My caricature here of socialist and radical feminism is also an example.
11. The central role of object relations versions of psychoanalysis and related strong universalizing moves in discussing reproduction, caring work and mothering in many approaches to epistemology underline their authors’ resistance to what I am calling postmodernism. For me, both the universalizing moves and these versions of psychoanalysis make analysis of “women’s place in the integrated circuit” difficult and lead to systematic difficulties in accounting for or even seeing major aspects of the construction of gender and gendered social life. The feminist standpoint argument has been developed by: Flax (1983), Harding (1986), Harding and Hintikka (1983), Hartsock (1983a, b), O’Brien (1981), Rose (1983),

- Smith (1974, 1979). For rethinking theories of feminist materialism and feminist standpoints in response to criticism, see Harding (1986, pp. 163-96), Hartsock (1987) and H. Rose (1986).
12. I make an argumentative category error in “modifying” MacKinnon’s positions with the qualifier “radical”, thereby generating my own reductive critique of extremely heterogeneous writing, which does explicitly use that label, by my taxonomically interested argument about writing which does not use the modifier and which brooks no limits and thereby adds to the various dreams of a common, in the sense of univocal, language for feminism. My category error was occasioned by an assignment to write from a particular taxonomic position which itself has a heterogeneous history, socialist-feminism, for *Socialist Review*. A critique indebted to MacKinnon, but without the reductionism and with an elegant feminist account of Foucault’s paradoxical conservatism on sexual violence (rape), is de Lauretis (1985; see also 1986a, b, pp. 1–19). A theoretically elegant feminist social-historical examination of family violence, that insists on women’s, men’s and children’s complex agency without losing sight of the material structures of male domination, race and class, is Gordon (1988).
  13. This chart was published in 1985. My previous efforts to understand biology as a cybernetic command-control discourse and organisms as “natural-technical objects of knowledge” were Haraway (1979, 1983, 1984). The 1979 version of this dichotomous chart appears in Haraway (1991), Ch. 3; for a 1989 version, see Ch. 10. The differences indicate shifts in argument.
  14. For progressive analyses and action on the biotechnology debates: *GeneWatch, A Bulletin of the Committee for Responsible Genetics*, 5 Doane St, 4th Floor, Boston, MA 02109; Genetic Screening Study Group (formerly the Sociobiology Study Group of Science for the People), Cambridge, MA; Wright (1982, 1986); Yoxen (1983).
  15. Starting references for “women in the integrated circuit”: D’Onofrio-Flores and Pfafflin (1982), Fernandez-Kelly (1983), Fuentes and Ehrenreich (1983), Grossman (1980), Nash and Fernandez-Kelly (1983), Ong (1987), Science Policy Research Unit (1982).
  16. For the “homework economy outside the home” and related arguments: Burr (1982); Collins (1982); Gordon (1983); Gordon and Kimball (1985); Gregory and Nussbaum (1982); Microelectronics Group (1980); Piven and Coward (1982); Reskin and Hartmann (1986); Stacey (1987); S. Rose (1986); Stallard et al. (1983); *Women and Poverty* (1984), which includes a useful organization and resource list.
  17. The conjunction of the Green Revolution’s social relations with biotechnologies like plant genetic engineering makes the pressures on land in the Third World increasingly intense. AID’s estimates (*New York Times*,

- 14 October 1984) used at the 1984 World Food Day are that in Africa, women produce about 90% of rural food supplies, about 60–80% in Asia, and provide 40% of agricultural labor in the Near East and Latin America. Blumberg charges that world organizations' agricultural politics, as well as those of multinationals and national governments in the Third World, generally ignore fundamental issues in the sexual division of labor. The present tragedy of famine in Africa might owe as much to male supremacy as to capitalism, colonialism and rain patterns. More accurately, capitalism and racism are usually structurally male dominant. See also Bird (1984); Blumberg (1981); Busch and Lacy (1983); Hacker (1984); Hacker and Bovit (1981); International Fund for Agricultural Development (1985); Sachs (1983); Wilfred (1982).
18. See also Enloe (1983a, b).
  19. For a feminist version of this logic, see Hardy (1981). For an analysis of scientific women's story-telling practices, especially in relation to sociobiology in evolutionary debates around child abuse and infanticide, see Haraway (1991), Ch. 5.
  20. For the moment of transition of hunting with guns to hunting with cameras in the construction of popular meanings of nature for an American urban immigrant public, see Haraway (1984–5, 1989b), Nash (1979), Preston (1984), Sontag (1977).
  21. For guidance for thinking about the political/cultural/racial implications of the history of women doing science in the US see: Haas and Perucci (1984); Hacker (1981); Haraway (1989); Keller (1983); National Science Foundation (1988); Rossiter (1982); Schiebinger (1987).
  22. Markoff and Siegel (1983). High Technology Professionals for Peace and Computer Professionals for Social Responsibility are promising organizations.
  23. An abbreviated list of feminist science fiction underlying themes of this essay: Octavia Butler, *Wild Seed*, *Mind of My Mind*, *Kindred*, *Survivor*; Suzy McKee Charnas, *Motherliness*; Samuel R. Delany, the Nevèrÿon series; Anne McCaffery, *The Ship Who Sang*, *Dinosaur Planet*; Vonda McIntyre, *Superluminal*, *Dreamsnake*; Joanna Russ, *Adventures of Alix*, *The Female Man*; James Tiptree, Jr, *Star Songs of an Old Primate*, *Up the Walls of the World*; John Varley, *Titan*, *Wizard*, *Demon*.
  24. French feminisms contribute to cyborg heteroglossia. Burke (1981); Duchon (1986); Irigaray (1977, 1979); Marks and de Courtivron (1980); *Signs* (Autumn 1981); Wittig (1973). For English translation of some currents of francophone feminism see *Feminist Issues: A Journal of Feminist Social and Political Theory*, 1980.
  25. But all these poets are very complex, not least in their treatment of themes of lying and erotic, decentred collective and personal identities. Griffin (1978), Lorde (1984), Rich (1978).

26. Derrida (1976, especially part 11); Lévi-Strauss (1961, especially “The Writing Lesson”); Gates (1985); Kahn and Neumaier (1985); Ong (1982); Kramarae and Treichler (1985).
27. The sharp relation of women of color to writing as theme and politics can be approached through: Program for “The Black Woman and the Diaspora: Hidden Connections and Extended Acknowledgements”, An International Literary Conference, Michigan State University, October 1985; Carby (1987); Christian (1985); Evans (1984); Fisher (1980); *Frontiers* (1980, 1983); Giddings (1985); Kingston (1977); Lerner (1973); Moraga and Anzaldúa (1981); Morgan (1984). Anglophone European and Euro-American women have also crafted special relations to their writing as a potent sign: Gilbert and Gubar (1979), Russ (1983).
28. The convention of ideologically taming militarized high technology by publicizing its applications to speech and motion problems of the disabled/differently abled takes on a special irony in monotheistic, patriarchal, and frequently anti-semitic culture when computer-generated speech allows a boy with no voice to chant the Haftorah at his bar mitzvah. See Sussman (1986). Making the always context-relative social definitions of “ableness” particularly clear, military high-tech has a way of making human beings disabled by definition, a perverse aspect of much automated battlefield and Star Wars R & D. See Welford (1 July 1986).
29. James Clifford (1985, 1988) argues persuasively for recognition of continuous cultural reinvention, the stubborn non-disappearance of those “marked” by Western imperializing practices.
30. DuBois (1982), Daston and Park (n.d.), Park and Daston (1981). The noun monster shares its root with the verb *to demonstrate*.

#### REFERENCES

- Athanasiou, T. (1987). High-tech politics: the case of artificial intelligence. *Socialist Review* 92, 7–35.
- Bambara, T. C. (1981). *The Salt Eaters*, New York: Vintage/Random House.
- Baudrillard, J. (1983). *Simulations*, trans., P. Foss, P. Patton, P. Beitchman, New York: Semiotext[e].
- Bird, E. (1984). Green Revolution imperialism, I & II, Papers Delivered at the University of California, Santa Cruz.
- Bleier, R. (1984). *Science and Gender: A Critique of Biology and its Themes on Women*, New York: Pergamon.
- Bleier, R. (Ed.) (1986). *Feminist Approaches to Science*, New York: Pergamon.
- Blumberg, R. L. (1981). *Stratification: Socioeconomic and Sexual Inequality*, Boston: Brown.
- Blumberg, R. L. (1983). A general theory of sex stratification and its application to the positions of women in today’s world economy. Paper Delivered to Sociology Board, University of California at Santa Cruz.



- Burke, C. (1981). Irigaray through the looking glass. *Feminist Studies* 7(2), 288–306.
- Burr, S. G. (1982). Women and work. In: Haber, B. K. (Ed.) *The Women's Annual*, 1981. Boston: G.K. Hall.
- Busch, L., & Lacy, W. (1983). *Science, Agriculture, and the Politics of Research*, Boulder, CO: Westview.
- Butler-Evans, E. (1987). Race, gender and desire: narrative strategies and the production of ideology in the fiction of Tony Cade Bambara, Toni Morrison and Alice Walker. University of California at Santa Cruz, PhD thesis.
- Carby, H. (1987). *Reconstructing Womanhood: The Emergence of the Afro-American Woman Novelist*. New York: Oxford University Press.
- Christian, B. (1985). *Black Feminist Criticism: Perspectives on Black Women Writers*, New York: Pergamon.
- Clifford, J. (1985). On ethnographic allegory. In: Clifford J. and Marcus G. (Eds.) *Writing Culture: The Poetics and Politics of Ethnography*, Berkeley: University of California Press.
- Clifford, J. (1988). *The Predicament of Culture: Twentieth-Century Ethnography, Literature, and Art*, Cambridge, MA: Harvard University Press.
- Cohn, C. (1987a). Nuclear language and how we learned to pat the bomb. *Bulletin of Atomic Scientists*, 17–24.
- Cohn, C. (1987b). Sex and death in the rational world of defense intellectuals. *Signs* 12(4), 687–718.
- Collins, P. H. (1982). Third world women in America. In: Haber, B. K. (Ed.) *The Women's Annual*, 1981, Boston: G.K. Hall.
- Cowan, R. S. (1983). *More Work for Mother: The Ironies of Household Technology from the Open Hearth to the Microwave*, New York: Basic.
- Daston, L., & Park, K. (n.d.). Hermaphrodites in renaissance France, Unpublished Paper.
- de Lauretis, T. (1985). The violence of rhetoric: considerations on representation and gender. *Semiotica* 54, 11–31.
- de Lauretis, T. (1986a). Feminist studies/critical studies: issues, terms, and contexts, in de Lauretis (1986b), 1–19.
- de Lauretis, T. (Ed.) (1986b). *Feminist Studies/Critical Studies*, Bloomington: Indiana University Press.
- de Waal, F. (1982). *Chimpanzee Politics: Power and Sex among the Apes*, New York: Harper & Row.
- Derrida, J. (1976). *Of Grammatology*, trans. and introd. G.C. Spivak, Baltimore: Johns Hopkins University Press.
- D'Onofrio-Flores, P., & Pfafflin, S. M. (Eds.) (1982). *Scientific-Technological Change and the Role of Women in Development*, Boulder: Westview.
- Douglas, M. (1966). *Purity and Danger*. London: Routledge & Kegan Paul.
- Douglas, M. (1970). *Natural Symbols*. London: Cresset Press.
- DuBois, P. (1982). *Centaur and Amazons*. Ann Arbor: University of Michigan Press.
- Duchen, C. (1986). *Feminism in France from May '68 to Mitterrand*. London: Routledge & Kegan Paul.
- Edwards, P. (1985). Border wars: the science and politics of artificial intelligence. *Radical America* 19(6), 39–52.
- Enloe, C. (1983a). In: Nash, J. and Fernandez-Kelly, M. P. *Women Textile Workers in the Militarization of Southeast Asia*, 407–25.
- Enloe, C. (1983b). *Does Khaki Become You? The Militarization of Women's Lives*. Boston: South End.
- Epstein, B. (1993). *Political Protest and Cultural Revolution: Nonviolent Direct Action in the Seventies and Eighties*. Berkeley: University of California Press.

- Evans, M. (Ed.) (1984). *Black Women Writers: A Critical Evaluation*. Garden City, NY: Doubleday/Anchor.
- Fausto-Sterling, A. (1985). *Myths of Gender: Biological Theories about Women and Men*. New York: Basic.
- Fernandez-Kelly, M. P. (1983). *For We Are Sold, I and My People*. Albany: State University of New York Press.
- Fisher, D. (Ed.) (1980). *The Third Woman: Minority Women Writers of the United States*. Boston: Houghton Mifflin.
- Flax, J. (1983). In: Harding S. and Hintikka M. *Political Philosophy and the Patriarchal Unconscious: A Psychoanalytic Perspective on Epistemology and Metaphysics*, 245–82.
- Foucault, M. (1963). *The Birth of the Clinic: An Archaeology of Medical Perception*, trans. A.M. Smith, New York: Vintage, 1975.
- Foucault, M. (1975). *Discipline and Punish: The Birth of the Prison*, trans. S. Alan, New York: Vintage, 1979.
- Foucault, M. (1976). *The History of Sexuality, Vol. 1: An Introduction*, trans. R. Hurley, New York: Pantheon, 1978.
- Fraser, K. (1984). *Something. Even Human Voices. In the Foreground, a Lake*, Berkeley, CA: Kelsey St Press.
- Fuentes, A., & Ehrenreich, B. (1983) *Women in the Global Factory*. Boston: South End.
- Gates, H. L. (1985). Writing race and the difference it makes. In: *Race, Writing, and Difference*, Special Issue, *Critical Inquiry* 12(1), 1–20.
- Giddings, P. (1985). *When and Where I Enter: The Impact of Black Women on Race and Sex in America*. Toronto: Bantam.
- Gilbert, S. M., & Gubar, S. (1979). *The Madwoman in the Attic: The Woman Writer and the Nineteenth Century Literary Imagination*. New Haven, CT: Yale University Press.
- Gordon, L. (1988). *Heroes of Their Own Lives. The Politics and History of Family Violence, Boston 1880–1960*, New York: Viking Penguin.
- Gordon, R. (1983). The computerization of daily life, the sexual division of labor, and the homework economy, Silicon Valley Workshop Conference, University of California at Santa Cruz.
- Gordon, R., & Kimball, L. (1985). High-technology, employment and the challenges of education, Silicon Valley Research Project, Working Paper, no. 1.
- Gould, S. J. (1981). *Mismeasure of Man*. New York: Norton.
- Gregory, J., & Nussbaum, K. (1982). Race against time: automation of the office. *Office: Technology and People* 1, 197–236.
- Griffin, S. (1978). *Woman and Nature: The Roaring Inside Her*. New York: Harper & Row.
- Grossman, R. (1980). Women's place in the integrated circuit. *Radical America* 14(1), 29–50.
- Haas, V., & Perucci, C. (Eds.) (1984). *Women in Scientific and Engineering Professions*. Ann Arbor: University of Michigan Press.
- Hacker, S. (1981). The culture of engineering: women, workplace, and machine. *Women's Studies International Quarterly* 4(3), 341–53.
- Hacker, S. (1984). Doing it the hard way: ethnographic studies in the agribusiness and engineering classroom. Paper Delivered at the California America Studies Association, Pomona.
- Hacker, S., & Bovit, L. (1981). Agriculture to agribusiness: technical imperatives and changing roles, Paper Delivered at the Society for the History of Technology, Milwaukee.
- Haraway, D. J. (1979). The biological enterprise: sex, mind, and profit and human engineering to sociobiology. *Radical History Review* 20, 206–37.
- Haraway, D. J. (1983). Signs of dominance: from a physiology to a cybernetics of primate society. *Studies in History of Biology* 6, 129–219.

- Haraway, D. J. (1984). In: Haas, V. and Perucci, C. (Ed.) *Class, Race, Sex, Scientific Objects of Knowledge: A Socialist-Feminist Perspective on the Social Construction of Productive Knowledge and Some Political Consequences*, 212–229.
- Haraway, D. J. (1984–5). Teddy bear patriarchy: taxidermy in the Garden of Eden, New York City, 1908–36, *Social Text* 11, 20–64.
- Haraway, D. J. (1989). *Primate Visions: Gender, Race, and Nature in the World of Modern Science*. New York: Routledge.
- Haraway, D. J. (1991). *Simians, Cyborgs, and Women: The Reinvention of Nature*. London: Free Association Press.
- Harding, S. (1986). *The Science Question in Feminism*. Ithaca: Cornell University Press.
- Hartsock, N. (1983a). The feminist standpoint: developing the ground for a specifically feminist historical materialism. In Harding, S. and Hintikka, M. (Ed.) (1983), 283–310.
- Harding, S., & Hintikka, M. (Eds.) (1983). *Discovering Reality: Feminist Perspectives on Epistemology, Metaphysics, Methodology, and Philosophy of Science*. Dordrecht: Reidel.
- Hartsock, N. (1983b). *Money, Sex, and Power*. New York: Longman; Boston: Northeastern University Press, 1984.
- Hartsock, N. (1987). Rethinking modernism: minority and majority theories. *Cultural Critique* 7, 187–206.
- Hogness, E. R. (1983). Why stress? A look at the making of stress, 1936–56, Unpublished Paper Available from the Author, 4437 Mill Creek Rd, Healdsburg, CA 95448.
- Hooks, B. (1981). *Ain't I a Woman*. Boston: South End.
- Hooks, B. (1984). *Feminist Theory: From Margin to Center*. Boston: South End.
- Hardy, S. B. (1981). *The Woman that Never Evolved*. Cambridge, MA: Harvard University Press.
- Hubbard, R. (Ed.) (1982). *Biological Woman, the Convenient Myth*. Cambridge, MA: Schenkman.
- Hull, G., Scott, P. B., & Smith, B. (Eds.) (1982). *All the Women are White, All the Men are Black, But Some of Us are Brave*. Old Westbury: The Feminist Press.
- International Fund for Agricultural Development (1985). *IFAD Experience Relating to Rural Women, 1977–84*. Rome: IFAD, 37.
- Irigaray, L. (1977). *Ce sexe qui n'en est pas un*. Paris: Minuit.
- Irigaray, L. (1979). *Et l'une ne bouge pas sans l'autre*. Paris: Minuit.
- Jagger, A. (1983). *Feminist Politics and Human Nature*. Totowa, NJ: Roman & Allenheld.
- Jameson, F. (1984). Post-modernism, or the cultural logic of late capitalism. *New Left Review* 146, 53–92.
- Kahn, D., & Neumaier, D. (Eds.) (1985). *Cultures in Contention*. Seattle: Real Comet.
- Keller, E. F. (1983). *A Feeling for the Organism*. San Francisco: Freeman.
- Keller, E. F. (1985). *Reflections on Gender and Science*. New Haven: Yale University Press.
- King, K. (1984). 'The pleasure of repetition and the limits of identification in feminist science fiction: reimaginings of the body after the cyborg', Paper Delivered at the California American Studies Association, Pomona.
- King, K. (1986). The situation of lesbianism as feminism's magical sign: contests for meaning and the U.S. women's movement, 1968–72, *Communication* 9(1), 65–92.
- King, K. (1987a). Canons without innocence. University of California at Santa Cruz, PhD thesis.
- King, K. (1987b). *The Passing Dreams of Choice . . . Once Before and After: Andre Lorde and the Apparatus of Literary Production*. Book Prospectus, University of Maryland at College Park.
- Kingston, M. H. (1977). *China Men*. New York: Knopf.

- Klein, H. (1989). Marxism, psychoanalysis, and mother nature. *Feminist Studies* 15(2), 255–78.
- Kramarae, C., & Treichler, P. (1985). *A Feminist Dictionary*. Boston: Pandora.
- Latour, B. (1984). *Les Microbes, Guerre et paix, Suivi des irréductions*. Paris: Métailie.
- Lerner, G. (Ed.) (1973). *Black Women in White America: A Documentary History*. New York: Vintage.
- Lewontin, R. C., Rose, S., & Kamin, L. J. (1984). *Not in Our Genes: Biology, Ideology, and Human Nature*. New York: Pantheon.
- Lorde, A. (1982). *Zami, a New Spelling of My Name*. Trumansberg, NY: Crossing, 1983.
- Lorde, A. (1984). *Sister Outsider*. Trumansberg, NY: Crossing.
- Lowe, L. (1986). French literary orientalism: the representation of “others” in the texts of Montesquieu, Flaubert, and Kristeva, University of California at Santa Cruz, PhD thesis.
- Mackey, N. (1984). Review. *Sulfur* 2: 200–5.
- MacKinnon, C. (1982). Feminism, marxism, method, and the state: an agenda for theory. *Signs* 7(3), 515–4.
- MacKinnon, C. (1987). *Feminism Unmodified: Discourses on Life and Law*. Cambridge, MA: Harvard University Press.
- Marcuse, H. (1964). *One-Dimensional Man: Studies in the Ideology of Advanced Industrial Society*. Boston: Beacon.
- Markoff, J., & Siegel, L. (1983). Military micros, Paper Presented at Silicon Valley Research Project Conference, University of California at Santa Cruz.
- Marks, E., & de Courtivron, L. (Eds.) (1980). *New French Feminisms*. Amherst: University of Massachusetts Press.
- McCaffrey, A. (1969). *The Ship Who Sang*. New York: Ballantine.
- Merchant, C. (1980). *The Death of Nature: Women, Ecology, and the Scientific Revolution*. New York: Harper & Row.
- Microelectronics Group (1980). *Microelectronics: Capitalist Technology and the Working Class*. London: CSE.
- Mohanty, C. T. (1984). Under western eyes: feminist scholarship and colonial discourse, *Boundary* 2, 3 (12/13): 333–58.
- Moraga, C. (1983). *Loving in the War Years: to que nunca pasó por sus labios*, Boston: South End.
- Moraga, C., & Anzaldúa, G. (Eds.) (1981). *This Bridge Called My Back: Writings by Radical Women of Color*. Watertown: Persephone.
- Morgan, R. (Ed.) (1984). *Sisterhood is Global*. Garden City, NY: Anchor/ Doubleday.
- Nash, J., & Fernandez-Kelly, M. P. (Eds.) (1983). *Women and Men and the International Division of Labor*. Albany: State University of New York Press.
- Nash, R. (1979). The exporting and importing of nature: nature-appreciation as a commodity, 1850–1980, *Perspectives in American History* 3, 517–60.
- National Science Foundation (1988). *Women and Minorities in Science and Engineering*. Washington: NSF.
- O’Brien, M. (1981). *The Politics of Reproduction*. New York: Routledge & Kegan Paul.
- Ong, A. (1987). *Spirits of Resistance and Capitalist Discipline: Factory Workers in Malaysia*. Albany: State University of New York Press.
- Ong, W. (1982). *Orality and Literacy: The Technologizing of the Word*. New York: Methuen.
- Park, K., & Daston, L. J. (1981). Unnatural conceptions: the study of monsters in sixteenth- and seventeenth-century France and England. *Past and Present* 92, 20–54.
- Perloff, M. (1984). Dirty language and scramble systems. *Sulfur* 11, 178–183.
- Petchesky, R. P. (1981). Abortion, anti-feminism and the rise of the New Right. *Feminist Studies* 7(2), 206–246.

- Piven, F. F., & Cloward, R. (1982). *The New Class War: Reagan's Attack on the Welfare State and its Consequences*. New York: Pantheon.
- Preston, D. (1984). Shooting in paradise. *Natural History* 93(12), 14–19.
- Reskin, B. F., & Hartmann, H. (Eds.) (1986). *Women's Work, Men's Work*. Washington: National Academy of Sciences.
- Rich, A. (1978). *The Dream of a Common Language*. New York: Norton.
- Rose, H. (1983) Hand, brain, and heart: a feminist epistemology for the natural sciences. *Signs* 9(1), 73–90.
- Rose, H. (1986) Women's work: women's knowledge. In: Mitchell, J. and Oakley, A. (Eds.) *What is Feminism? A Re-Examination*. New York: Pantheon, 161–183.
- Rose, S. (1986). *The American Profile Poster: Who Owns What, Who Makes How Much, Who Works Where, and no Lives with Whom?* New York: Pantheon.
- Rossiter, M. (1982). *Women Scientists in America*. Baltimore: Johns Hopkins University Press.
- Rothschild, J. (Ed.) (1983). *Machina ex Den: Feminist Perspectives on Technology*. New York: Pergamon.
- Russ, J. (1983). *How to Suppress Women's Writing*. Austin: University of Texas Press.
- Sachs, C. (1983). *The Invisible Farmers: Women in Agricultural Production*. Totowa: Rowman & Allenheld.
- Said, E. (1978). *Orientalism*. New York: Pantheon.
- Sandoval, C. (1984). Dis-illusionment and the poetry of the future: the making of oppositional consciousness, University of California at Santa Cruz, PhD Qualifying Essay.
- Sandoval, C. (n.d.) Yours in struggle: women respond to racism, *A Report on the National Women's Studies Association*. Oakland, CA: Center for Third World Organizing.
- Schiebinger, L. (1987). The history and philosophy of women in science: a review essay. *Signs* 12(2), 305–332.
- Science Policy Research Unit (1982). *Microelectronics and Women's Employment in Britain*. University of Sussex.
- Smith, B. (Ed.) (1983). *Home Girls: A Black Feminist Anthology*. New York: Kitchen Table, Women of Color Press.
- Smith, D. (1974). Women's perspective as a radical critique of sociology. *Sociological Inquiry*, 44.
- Smith, D. (1979). A sociology of women. In: Sherman, J. and Beck, E. T. (Eds.) *The Prism of Sex*. Madison: University of Wisconsin Press.
- Sofia, Z. (also Z. Sofoulis) (1984). Exterminating fetuses: abortion, disarmament, and the sex-osemiotics of extra-terrestrialism. *Diacritics* 14(2), 47–59.
- Sontag, S. (1977). *On Photography*. New York: Dell.
- Stacey, J. (1987). Sexism by a subtler name? Postindustrial conditions and postfeminist consciousness. *Socialist Review* 96, 7–28.
- Stallard, K., Ehrenreich, B., & Sklar, H. (1983). *Poverty in the American Dream*. Boston: South End.
- Sturgeon, N. (1986). Feminism, anarchism, and non-violent direct action politics. University of California at Santa Cruz, PhD Qualifying Essay.
- Sussman, V. (1986). Personal tech. Technology lends a hand, *The Washington Post Magazine*, 9 November, 45–56.
- Traweek, S. (1988). *Beamtimes and Lifetimes: The World of High Energy Physics*. Cambridge, MA: Harvard University Press.
- Treichler, P. (1987) AIDS, homophobia, and biomedical discourse: an epidemic of signification, *October* 43. 31–70.
- Trinh T. Minh-ha (1986–7). Introduction, and difference: a special third world women issue. *Discourse: Journal for Theoretical Studies in Media and Culture* 8, 3–38.

- Weizenbaum, J. (1976). *Computer Power and Human Reason*. San Francisco: Freeman.
- Welford, J. N. (1986) Pilot's helmet helps interpret high speed world, *New York Times* (1 July), 21, 24.
- Willfred, D. (1982). Capital and agriculture, a review of Marxian problematics. *Studies in Political Economy* 7, 127–S4.
- Winner, L. (1977). *Autonomous Technology: Technics out of Control as a Theme in Political Thought*. Cambridge, MA: MIT Press.
- Winner, L. (1980). Do artifacts have politics? *Daedalus* 109(1), 121–136.
- Winner, L. (1986). *The Whale and the Reactor*. Chicago: University of Chicago Press.
- Winograd, T., & Flores, F. (1986). *Understanding Computers and Cognition: A New Foundation for Design*. Norwood, NJ: Ablex.
- Wittig, M. (1973) *The Lesbian Body*, trans. D. LeVay, New York: Avon, 1975 (*Le corps lesbien*, 1973).
- Wittig, M. (1984) Women and Poverty, Special Issue, *Signs* 10(2).
- Wright, S. (1982, July/August) Recombinant DNA: the status of hazards and controls, *Environment* 24(6), 12–20, 51–53.
- Wright, S. (1986). Recombinant DNA technology and its social transformation, 1972–82, *Osiris*, 2nd series 2, 303–360.
- Young, R. M. and Levidow, L. (Eds.) (1981, 1985) *Science, Technology and the Labour Process*, 2 Vols. London: CSE and Free Association Books.
- Yoxen, E. (1983). *The Gene Business*. New York: Harper & Row.
- Zimmerman, J. (Ed.) (1983). *The Technological Woman: Interfacing with Tomorrow*. New York: Praeger.

## Chapter 5: Teaching and Transformation: Donna Haraway's "A Manifesto for Cyborgs" and Its Influence in Computer-Supported Composition Classrooms

ERIN SMITH AND CYNTHIA L. SELFE

*Department of Humanities, Michigan Technological University, Houghton, MI, U.S.A.*

In an increasingly global and post-modern world marked by rapid technological, political, and social change, teachers at all levels face the difficult if not impossible challenge of preparing a coming generation for a world that they, themselves, have never seen or experienced (Mead, 1970). Within this context, Donna Haraway's "Manifesto for Cyborgs" has offered a broad range of humanist teachers and scholars a challenge and the possibility of hope.

In part, it is Haraway's interdisciplinary background in philosophy, biology, and English that has made her work so important to such a wide range of scholars. She earned her Ph.D. in biology from Yale in 1976 and has since helped to articulate and explore the interconnections among language, science, and technology both as a scholar and as a teacher in the History of Consciousness program at the University of California Santa Cruz. Her major works include *Crystals, Fabrics and Fields: Metaphors of Organicism in Twentieth-Century Developmental Biology* (1976), *Primate Visions: Gender, Race, and Nature in the World of Modern Science* (1989/1992), *Simians, Cyborgs, and Women: The Reinvention of Nature* (1991a), and *Modest\_Witness@Second\_Millennium.FemaleMan@MeetsOncoMouse<sup>TM</sup>* (1997). Haraway's theory of "situated knowledges" (1991b), however, has also proven instrumental to feminist, post-colonial, and technology studies, emphasizing an approach to scientific inquiry that assigns agency to our "objects of knowledge" and refuses to view them as "a screen or ground or a resource, never finally as slave to the master that closes off the dialectic" (1991b: 198). Her critique of objectivity has extended to Marxist/socialist feminist and cultural theories that provide totalizing or essentializing explanations of self and society. For Haraway, "partiality" as opposed to "universality" (1991b: 195), ambiguity as opposed to certainty, provide more productive ground for both feminist theory and epistemology.

Although Haraway's scholarship has been *broadly* influential in the humanities, however, there is no discipline it has shaped more *specifically*, and more fundamentally than that of computers and composition studies as it is practiced in the United States. Part of what has made Haraway's work so appealing to teachers and scholars in this area is her preoccupation with language and the

skillful deployment of metaphor. She writes “Like all neuroses, mine is rooted in the problem of metaphor, that is, the problem of the relation of bodies and language” (1991b: 185). This focus made both Haraway’s approach and her insights of particular interest to composition scholars and literacy colleagues who began to grapple in the early 1980s with helping students communicate responsibly and effectively in digital contexts. Importantly, however, Haraway’s work—and the work of scholars she influenced—challenged many of the nascent approaches to computer-supported composition in the United States, especially those that employed computers simply to teach skill and drills, but did not adequately address the critical dimensions of new technology or its possibilities to support more broadly transformative social and communicative relationships. For those scholars and teachers who imagined more radical possibilities for composing and communicating within electronic environments, Haraway’s debt to the liberatory literacy work of Paulo Freire, “the inescapable ancestor” proved inspiring. As she noted, “I think of him as one of my fathers, or one of my brothers. I inherited his work; *we* who try to link writing and freedom projects inherited his work, collectively” (Olson, 1996).

For all of the teachers and scholars who read Haraway’s germinal work—both in the specific area of computers and composition studies, as well as in the broader disciplines of social sciences and English—“*A Manifesto for Cyborgs: Science, Technology, and Socialist Feminism in the 1980s*” (1985) presented the challenge of recognizing and honoring the contradictory nature of cyborgs, to participate in building and sustaining an “ironic, political myth” (p. 65), a blasphemic, socialist-feminist identity that resists many of the negative influences of contemporary technological society and, instead, embraces “partial, contradictory, permanently unclosed constructions of personal and collective selves” (p. 75). As “a hybrid of machine and organism, a creature of social reality as well as a creature of fiction” (1985: 65) Haraway’s cyborg is a metaphor of resistance, specifically opposed to the destructive social formations of racism, sexism, poverty, capitalism, violence, ecological degradation, and domination that grow out of male dominance, capitalism, and a delusional faith in the related modernist projects of science and technology. These forces, among others, Haraway notes, have helped support and construct a series of progressively problematic dualisms (nature/culture, humans/machines, and men/women) that artificially separate members of the global ecosystem, masking the fact that they are actually related by a series of complex actions and effects. This false separation, in turn, serves as both a foundational and continuing basis for increasingly destructive social, material, and industrial practices, and the related beliefs that average human beings have little responsibility to control the technologies they create and limited ability to change the technological systems within which they participate for the better.

Haraway argued that the notion of a closed, organic body is especially detrimental to women with regard to technological agency: “Only by being out of place could we take intense pleasure in machines, and then with



excuses that this was organic activity after all, appropriate to females” (p. 99). Her closing declaration, “I would rather be a cyborg than a goddess” (p. 101), succinctly (and ironically) summarized her critique of essentialist feminist theories and initiated a new discourse that enabled scholars and teachers of composition—particularly feminist scholars and teachers—a very fruitful means by which to engage classroom technology issues and to approach pedagogy in computer-mediated environments from a feminist and socially conscious critical framework.

Many contemporary educators—particularly those who use computer technology to carry out their teaching and are critically aware of the difficulties that such teaching poses—have come to adopt the activist political agenda that Haraway assigned to cyborgs in 1985. Haraway’s work has been central to emerging pedagogies that stress our responsibility for helping students attend to the ways in which humans are implicated in technological systems, as well as our need to understand and respond to the increasingly close relationship between computer technology and literacy—between computers and human efforts to make meaning, to code culture and to construct social systems through their signifying practices (linguistic, depictive, aural, and multimodal) in digital contexts and environments. This chapter identifies several important aspects of this transformative agenda, drawing directly from Haraway’s essay—and subsequent works that have built on that germinal piece.

1. UNDERSTANDING HUMANS AND THEIR RELATIONSHIP TO TECHNOLOGICAL SYSTEMS IN LOCAL AND GLOBAL CONTEXTS

At the time that Donna Haraway’s “Manifesto” was published in 1985—and for sometime thereafter as the implications of this important contribution and related works percolated through the academic communities of the social sciences and humanities—most public educators in highly industrialized countries such as the United States and Canada understood computers and computer networks in relatively simple instrumental terms as effective teaching, learning, and communication environments. Relatively few educators during this period recognized the importance of exploring with students the critical and complex responsibilities humans have for understanding and shaping such environments. Relatively few were engaged in exploring with students the ways that humans are related to, and implicated in, the global spread of computer technology—or in making students aware of the larger social, cultural, political, and economic systems of which technology is a key part. But it was just this kind of critical awareness—of “taking responsibility for the social relations of science and technology” (p. 100) and understanding technology to be “completely without innocence” (p. 67)—that formed a central tenant of the cyborg politics Haraway described in the “Manifesto”.

## 2. HISTORICAL CONTEXTS

In part, the recognition of the “Manifesto’s” import was slow to take root in educational settings because industrialized nations such as the United States and Canada—the only countries in the early 1980s that could afford the large-scale integration of computers in public school classrooms—generally subscribed to a common, powerful, ideological parable—a story that linked advances in science and technology to progress in education, society, and politics. Contributing to the effects of this dominant narrative were other related fictions, historically framed in Western cultures by words like *progress*, *democracy*, and *capitalism*; as well as the common practice of appropriating “nature as a resource for . . . production,” and the habit of composing Western identities and ideas of “self” in opposition to “reflections of the other” (p. 66). Given the mythic status of these intersecting narratives and their accompanying practices, it was not surprising that so many educators in the United States and Canada, especially in the first decade of computer use in public school classrooms—understood computers as instructional tools that had a great deal of potential (Hawisher et al., 1996; Selfe, 1999).

This central and unified fiction—in shorthand, Scientific + Technological Progress = Social + Economic + Educational Progress—was deeply sedimented in both public and official discourses about computer technology during the 1980s, the decade that marked the emergence of the first fully assembled microcomputers in U.S. markets. A brief look at the history of that period shows why this fiction was so dominant.

When Ronald Reagan assumed the U.S. presidency on 20 January 1981, the country was deeply mired in a stubborn recession at home. Abroad, the country was occupied with fighting a troublesome, multifront Cold War and confronting a troubling loss of economic sovereignty (Johnston & Packer, 1987).

Internationally, the political battles of the Cold War raged on in Libya, the former Soviet Union, Nicaragua, Italy, and Granada (*Annals of America*, Vol. 21, 1987: xxx–xxxvi). These Cold War political struggles were mirrored by, and actually related to, international economic battles the United States found itself waging around the world. After World War II, as industrial Japan, Germany, and Brazil recovered and began to flex their political and economic muscles, the global scene became increasingly populated by nations who had their own opinions about American politics and financial policies, and, moreover, felt justified in challenging the United States in both areas. By the end of the 1970s, then, the increasingly competitive global economic picture had become at least as disturbing to many Americans as the contested political landscape: The American standard of living was threatened; the competitive status of the domestic steel, automobile, textiles, consumer electronics, and other manufacturing industries had begun to erode; and Americans had begun to express a “growing crescendo of support for trade restrictions”, (Johnston & Packer, 1987: 13).

By the end of the 1980s, the effects of these international wrestling matches were being felt more directly. The oil cutoffs by OPEC, for example, convinced many Americans that these struggles were serious, indeed, and that the United State's former sovereignty over global economic matters had ended. By 1987, when the famous Hudson Institute report, *Workforce 2000*, was published, a disturbing picture of economic decline had begun to dominate the American consciousness:

Between 1975 and 1980, [productivity] output per hour in U.S. manufacturing rose by an average of 1.7 percent per year, compared to 3.8 in West Germany and 8.6 percent in Japan . . . . U.S. steel production dropped by more than one-fourth between 1975 and 1983, and the U.S. share of the world steel production declined from 16 percent to 12 percent; for autos, the drop in volume was 22 percent, as the U.S. share of world production fell from 27 to 17 percent.

(Johnston & Packer, 1987: 15)

America's domestic growth was now "inextricably intertwined with world growth" (Johnston & Packer, 1987: 3) and this linkage was not going America's way:

Between 1960 and 1985, the world economy grew at an average rate of 3.9 percent per year, while U.S. growth averaged 3.1 percent annually. As a result of this lower growth, the U.S. share of the world economy . . . dropped from 35 percent in 1960 to 28 percent in 1985 . . . . The U.S. share of the economy will fall further by the year 2000. (p. 6)

Given this political and economic environment, the American national mood was increasingly tense and defensive. On the 23rd of March, in 1983, President Reagan delivered a televised address to Americans in which he described a space-based, missile-defense system that the media called "Star Wars". And, although many scientists were skeptical about whether or not such a system could succeed, the first and second voyages of the space shuttle *Challenger*—concluded on 9th April and 24th June, respectively—helped convince many Americans that the Star Wars project might actually work (*Annals of America, Vol. 21*, 1987: xxxiv–xxxvi).

Other frontiers and challenges also provided a positive vision of what Americans were capable of accomplishing if the national resources could be organized effectively. In March of 1983, for instance, after 112 days as the first recipient of an artificial heart, Barney Clark died. In May of 1983, the United States declared AIDS as the nation's top medical priority, and in October of 1984, Baby Fae had a baboon's heart transplanted into her chest cavity in an attempt to save her life (*Annals of America, Vol. 21*, 1987: xxxiv–xxxvi).

A combination of macro-level historical, political, economic, and social factors—the global struggles of the Cold War and America’s fading economic status, the domestic recession, the ongoing race for the domination of space, and the technological challenges associated with medical research—converged to fuel America’s national investment in technology and the resultant explosion in technological innovation that was to characterize the decades of the 1980s and the 1990s. As the national thinking went, such an investment could help revitalize a flagging domestic economy and stop America’s downward spiral in global political and economic arenas as well (Johnston & Packer, 1987). This investment was enacted, on a practical level, by a range of social agents: Among only a few of these, members of the military-industrial complex, medical researchers, industry leaders, and educators.

Technology was certainly a primary focus of the nation’s military-industrial complex during the Reagan presidency (Levidow & Robins, 1989). In particular, the military’s need for increasingly sophisticated technological weaponry and the domestic industrial sector’s need for lucrative contracts proved an extremely potent combination. By 1983, for instance, the military and the private sector—represented by large research universities and major technology companies—had begun collaborating on The Defense Advance Research Projects Agency’s (DARPA) Strategic Computing Initiative, a “major program for research in microelectronics, computer architecture, and AI [artificial intelligence]” (Kurzweil, 1990: 480). In Michigan, the DARPA effort inspired a related statewide project—the Michigan Educational Research Information Triad (MERIT)—which would link major universities conducting technology research to both the National Science Foundation and corporate sponsors such as IBM and MCI (“Merit’s History,” 1998).

By 1987, similar collaborations among military, industrial, and educational partners were underway on AI vision systems for military aircraft and AI support for remotely piloted aircraft (Kurzweil, 1990: 255). These projects exploited the country’s Cold War concerns about foreign aggression and its increased willingness to fund military efforts. During the two terms of the Reagan Presidency, from 1981 to 1989, national defense spending increased from \$167.5 billion to \$303.4 billion (Council of Economic Advisors, 1990: 295). With such resources available to support military projects, private industries, and public universities participated willingly and vigorously in defense-based research and development efforts—most of which involved technology (Noble, 1989).

The needs of medical and health researchers also fueled the demand for increasingly sophisticated technologies and a workforce capable of both using and manufacturing such technologies. By the early 1980s, for example, the medical research team that had worked on an early diagnosis project named MYCIN had also produced two more expert systems for disease diagnosis: NeoMYCIN and ONCOCIN, both of which used newly designed hierarchical database structures. By 1982, CADUCEUS, a computer program based

on the expert knowledge of internists, was able to make more than “100,000 associations between symptoms and diseases” and to cover 70% of that field’s knowledge. And, by 1986, the development of computer-based imaging systems allowed doctors to see “inside our bodies and brains” (Kurzweil, 1990: 471–499).

The Reagan administration hoped that the increasing numbers of industries undertaking such technology-rich projects would need to hire large numbers of technologically savvy workers—thus, creating an employment trend that would reduce high-unemployment figures and boost America out of the current recession. To grease the skids for this recovery dynamic, Reagan began a program of industry de-regulation (Council of Economic Advisors, 1985: 119–126)—an approach that, along with other factors, contributed to the rapid growth of the computer industry during the 1980s and 1990s.

By mid-decade, the expansion of the technology industry was well underway, and Americans had begun to recognize its value as a key to both the country’s domestic *and* global difficulties. If America could develop advanced technologies faster than other countries, the thinking went, it could recapture its rightful share of global and economic power—but to accomplish this task, the country had to continue down a high-tech path. Thus, when Japan formed the ICOT consortium to develop a new “Fifth Generation” of computers in 1982 and funded it with a billion dollars of government and private monies, the Americans undertook, in short order, a similar project. By 1984, Ronald Reagan had signed legislation paving the way for the Microelectronics and Computer Corporation, an American-based consortium of more than 20 companies that shared a goal of developing intelligent computers and a budget of \$65 million a year. By 1986, the revenue of the American AI industry alone reached \$1 billion, growing to 1.4 billion by 1987 (Kurzweil, 1990: 479–480).

The vigor of all these converging trends led to astonishing growth in the computer industry during the 1980s, and not only in the manufacturing of large mainframe computers for advanced research and development. In the late 1970s, the invention of integrated microcircuit technologies—such as Motorola’s 68,000 16-bit microprocessor containing 680,000 transistors (*Timeline of Computing History*, 1996)—fed into the rapid and far-reaching development of personal computers. And the invention of these handy, relatively affordable machines was to prove transformative for many aspects of American life.

In 1981, for example, the IBM PC was launched, and its open architecture system, in turn, invited additional industry collaborations and partnerships (*Timeline of Computing History*, 1996). Among the first of these, in 1982, was Microsoft’s release of *DOS 1* (Polsson, 2000) and WordPerfect Corporation’s release of *WordPerfect 1.0* (*Timeline of Computing History*, 1996). Indeed, as Paul LeBlanc has noted, within a year of the IBM PC’s release, IBM was supporting 12 new Microsoft products, and 30 other companies had announced

the development of DOS-based software programs (Hawisher et al., 1996: 41). Also in 1982, the word “internet” was used for the first time (*PBS Life on the internet*, 1997), *Time* magazine named the computer “Man of the Year”, and the first commercial e-mail service linked 25 cities. In 1983, the Apple Lisa was launched; and in 1984, the Apple Macintosh followed. By the end of 1984, computers were so much a part of our national consciousness that William Gibson invented the term “cyberspace” in his novel *Neuromancer* (*Timeline of Computing History*, 1996). The software industry grew in tandem with the personal-computer hardware industry: The 300 software companies in existence in 1970 skyrocketed to over 2000 companies in 1983; sales in this industry went from \$750 million in 1977 to \$475 billion in 1983 (Hawisher et al., 1996: 96).

### 3. EDUCATIONAL CONTEXT

The American educational system was quick to understand the implications of these related national trends—especially for new, technologically rich curricula. A successful global superpower needed increasingly sophisticated technologies—to manufacture goods more efficiently, to wage war more effectively, or to conduct medical research on new and threatening viruses. And to invent and operate these new technological systems, increasing numbers of technologically savvy citizens were needed.

*The Condition of Education* (1980) described the new national dynamic as it was to affect American education during the coming decade:

The 1980's are expected to be a period of new assessments of our scientific capabilities, as National concerns shift to such areas as energy, the environment, and health. . . . Our Nation's continued advancement in technology is dependent to a large extent upon its supply of science and engineering personnel. The persons who can make up this manpower base conduct basic research to advance the understanding of nature, perform applied research and development in a variety of areas such as health, energy, and the environment, and train the nation's future scientists and engineers. (p. 6)

In support of this national project to expand technology use—and technological education—in schools, as Hawisher et al. note, a powerful coalition of social forces aligned themselves:

Computer industry giants like IBM, Control Data Corporation, and Mitre Corporation were rushing to explore the educational marketplace [for computer applications]. Government agencies like the National Science Foundation, the U.S. Office of Education, and the Defense Advanced

Research Projects Agency (DARPA) were seeking to inform and enlist American education in response to Cold War politics (Thurston, 1994). Private foundations like the Carnegie Corporation and the Annenberg/CPB Project were funding new answers to old educational questions.

(Hawisher et al., 1996: 34)

In this milieu, the newly invented personal computer promised to be an exceptionally powerful educational ally. These small, affordable machines offered a cost-effective way of helping educators produce a technologically savvy citizenry, and the relative ease of programming personal computers appealed to teachers in a number of disciplines unrelated to computer science. Personal computers made it relatively easy for faculty to create their own computer-assisted instruction (CAI) packages for mathematics, social studies, and importantly, English—where personal computers quickly became popular environments for literacy and communication instruction.

It was during this period of innovation—framed by a growing national investment in technology as a response to the challenges posed by the Cold War, raging economic battles at home and around the globe, the need for new energy sources, and the call for medical and health innovations—that Donna Haraway’s “Manifesto” was first published in 1985.

#### 4. ACADEMIC CONTEXTS: HUMANITIES AND THE SOCIAL SCIENCES

Haraway’s publication presented educators in the humanities and social sciences with a challenging new role. The cyborg political agenda described in the “Manifesto” charged educators not with simply *using* computers and teaching students to do so—a task which had proven difficult enough in public school classrooms during the previous 5 years—but also with acknowledging their own participation in, and responsibility for, the technological systems that supported national and international systems of domination. Teachers and scholars were asked, moreover, to *become* cyborgs: To assume the role of “monsters” (p. 99) responsible for blaspheming the powerful mythic system surrounding computers in the increasingly technological U.S. culture and to create new, resistant “world-changing fictions” (p. 65) that would help students and the public gain some critical perspective on technology as a part of social systems and formations that supported the politics of domination and inequity. These new fictions were needed to tell different truths, to show different perspectives—in Haraway’s words, to give voice to the “imaginative apprehension, of oppression, and so of possibility” (p. 66) that escaped the masking and naturalizing effects of the nationalistic narratives perceived as common sense.

Given the public enthusiasm for computer technology during the 1980s and 1990s—as well as the potency, ubiquity, and coherence of the social and discursive formations surrounding computer use in educational settings—the impact of the “Manifesto” on U.S. educational practice and the diffusion of ideas from this publication took considerable time to unfold. Despite this delay, however, the “Manifesto” proved itself to be an important intellectual forerunner of a vigorous movement to establish critical perspectives on technological systems and their relation to existing social, political, ideological, cultural, and economic formations (cf. Feenberg, 1999; Gray, 1995; Grossberg et al., 1992; Turkle, 1995). During the 1980s, the intellectual trajectory described by these works—especially as influenced by the “Manifesto”—grew in strength and gave rise to work in four important areas of the academy: Historically and philosophically informed studies of the relationship between science, technology, and society; literary studies of cyborgs and their antecedents; cultural studies of cyberspace; and gender and technology studies.

A number of cyborg educators and scholars, for instance, were involved in extending agenda related to those in the “Manifesto”—tracing for students and the public the historical and philosophical roots of Western narratives about science and ideologically determined belief that science and technology would always yield a better world for the human species. Gergen (1991), for instance, pointed out, that a broad public faith in Science gained potency with the emergence of modernity near the end of the 19th century. During this period, as Gergen noted, Science as a waxing social and cultural influence was linked to the waning of Romanticism and its adherence to “passion, purpose, depth, and personal significance” (p. 27). Scientific discovery—sketched in simple terms as the outcome of applied truth and reason, and associated with an accompanying faith in the power of systematic observation, rigorous reason, and rationally designed technological tools—exerted increasing cultural influence in various fields over the next century (Gergen, p. 27).

As the “Manifesto” suggested, technological invention played a crucial role in the rise of science in the 19th and 20th centuries, and many scholars who read Haraway’s work were prompted by such thinking to outline the specific historical and philosophical connections between technology and various “longstanding social and cultural practices” in both highly industrialized and less industrialized countries. After the publication of the “Manifesto”, scholars such as Bruno Latour (1993), Arturo Escobar (1994), Andrew Feenberg (1999), and Chris Hables Gray (1989, 1995) among many others, studied the sustained connections between technology and the social formations of positivism, rationality, instrumentality, capitalism, democracy, and militarism. Bruno Latour (1988, 1993) traced ways in which the philosophical tenets of modernism shaped understandings of technology, agency, and human relationships to technology within social contexts. J. MacGregor Wise (1997) examined the ways in which Western cultural formations have historically shaped epistemic understandings of technology. Haraway’s cyborg metaphor



has also been taken up by Chéla Sandoval (1995) who argued that for the past 300 years colonized peoples have been using “cyborg skills” and “cyborg consciousness” to survive “techno-human conditions” (p. 408). She outlined a “methodology of the oppressed”, (p. 409), using Haraway’s metaphor to think through configurations of “U.S. Third World Feminism”.

A second group of educators found it fruitful to explore Haraway’s cyborg as a textual and literary phenomenon, as Haraway herself does on numerous occasions. These educators focused on cyborgs and their literary forerunners as rendered in works of literature (especially science fiction) and film by authors such as Mary Shelley, cyberpunk writers such as William Gibson and Neil Stephenson, and comic books by superhero and supervillain artists (Oehlert, 1995). Katherine Hayles, whose early work on scientific discourse and language (1984) influenced Haraway’s (1991a, b) analysis of biopolitics, has consistently explored the cyborg and its implications for literature and writing in “post-human” contexts (1995, 1999, 2002). David Tomas (1989) cited Haraway in his examination of William Gibson’s cyberpunk fiction—*Neuromancer*, *Count Zero*, and *Mona Lisa Overdrive*—claiming that such literary works could help further Haraway’s agenda by “sensitiz[ing] us to the possibility of explosive social/biological mutations produced by rapidly changing technoscapes” (p. 129). In related work, Mark Oehlert (1995) used Haraway’s work to explore images of cybernetic heroes and villains in comic books, maintaining that the graphic representation of such characters revealed our own ambivalence to the merger of biology and technology. Alison Landsberg (1995) cited Haraway as she explored the prosthetic nature of human memories in an analysis of the films *Total Recall* and *Blade Runner*.

A third group of scholars, influenced by a combination of popular culture and cultural studies, took up the challenges of Haraway’s “Manifesto” by examining popular conceptions of cyborgs and cyberculture. Diana Gromala (1996), for instance, suggested that medical imaging transformed humans into cyborgs—beings in which “social, political, economic, and technological forces flow and collide” (p. 236); and Alluquere Rosanne Stone (1992) described a community of individuals who conversed so consistently and actively online that they created a “social space in which the divide between nature and technology” was “thoroughly unrecognizable” (p. 82). Many of the scholars interested in cyberculture focused on Haraway’s call for a “cyborg world” that was informed by radical feminist, socialist, and transformative values—one that might be informed by “lived social and bodily realities in which people are not afraid of their joint kinship with animals and machines, not afraid of permanently partial identities and contradictory standpoints” (p. 72). These scholars, committed to the “Manifesto’s” call for “fictions” that resisted the dominant utopian narratives about technology, remained wary of the dangers posed by a “salvation history” (p. 67). Working in this arena, for instance, Lisa Nakamura (1995a, b) extended the agenda of Haraway’s work by critiquing the racist practices of “identity tourism” (p. 181), the appropriation

and colonization of minority identities in online chat rooms and commercial advertisements about technology; Vivian Sobchack accused the *Mondo 2000* subculture of the “God trick” (Haraway, 1991a, b: 189) of plugging into “dangerous forms of holism” and a “dizzying pro-technology rhetoric” (that was “neither progressive nor democratic, . . . [and] hardly communitarian” (Sobchack, 1994: 22–24) in nature. In a similar vein, Chris Hables Gray (1995), in “The Cyborg Soldier”, extended Haraway’s agenda by exploring the ways in which computer technologies were implicated in the specific agenda of U.S. militarism and aggression.

Finally, feminist scholars undertook critical projects closely related to those in the “Manifesto”, both extending and, at times, influencing Haraway’s own work on technology and gender. Judith Wajcman (1991) surveyed feminist approaches to technology and science, advocating that feminists develop theories and models that reveal technology’s connection to structures of power and knowledge production. At the same time, she argued, like Haraway (1991b), that a monolithic theory would not suffice. Anne Balsamo (1996) examined intersections of the discursive and the material in representational practices such as female bodybuilding, plastic surgery, reproductive technologies, and cyberspace. Other feminists considered the boundaries between gendered bodies and identity in cyberspace, emphasizing the fluidity of personality (Turkle, 1995), the diverse configurations of gendered participation (Miller, 1995), or communication styles in computer-mediated environments (Herring, 1996; Kramarae, 1988; Kramarae & Taylor, 1993). Sadie Plant (1997) argued that women have always played essential roles in the development and use of technology, focusing as an example on Ada Lovelace’s involvement in Charles Babbage’s “Difference Engine” project. In 1997, Lynn Hershman Leeson wrote and directed the film, *Conceiving Ada*, in which a pregnant modern-day mathematician makes contact with Ada Lovelace through her computer and transfers the memories and, ostensibly, the DNA of Lovelace to her unborn child. Directly or indirectly, Haraway’s incisive “Manifesto” became a touchstone for virtually all considerations of gender, technology, and science that followed it.

##### 5. UNDERSTANDING THE RELATIONSHIP BETWEEN COMPUTER TECHNOLOGY AND LITERACY

If Haraway’s “Manifesto” influenced work in key areas of social sciences and literature, however, much of its impact was limited to academic scholarship published in professional journals and theoretical discussions in graduate-level classrooms. Relatively little of this scholarship found its way into the undergraduate collegiate curricula (women’s studies programs providing an exception) and even less into actual secondary classrooms. In English composition studies, however, the ideas contained within the “Manifesto”

shaped not only the scholarship of educators, but, importantly, teaching practices as well—both at the undergraduate and graduate levels. For the many teachers and scholars who, by 1985, were researching and teaching composition in digital environments, Haraway’s work had become mandatory reading.

## 6. HISTORICAL CONTEXT

In part, composition teachers and scholars found Haraway’s thinking in the “Manifesto” so compelling because she acknowledged that writing in digital contexts was an important new literacy practice that had strong potential for political agency. “The silicon chip”, as Haraway acknowledged, had become a politically charged “surface for writing” (p. 70), and one that had “special significance” for transformative efforts. Within this space, many composition teachers agreed with Haraway, the “contemporary political struggle” was being played out, and with “deadly serious” (p. 93) consequences that would affect citizens not only in the United States, but in many other countries as well.

The importance of Haraway’s insight on this point was especially significant to educators—many of whom were influenced by the work of Paulo Freire—who were increasingly dissatisfied with the inequitable literacy practices that characterized U.S. schools and classrooms in an age considered so rich with technological promise. A brief review of the historical context can help explain the persistent problems that these educators considered so disturbing. When the first fully assembled microcomputers began entering American classrooms early in the 1980s, hopes for computers were high. Teachers and scholars hoped not only that computers could serve as effective instructional tools, but also—in a broader and more important context—that these machines could actually help democratize American classrooms. As the culturally informed reasoning went during that period, if the nation could put enough computers into enough schools, then all students—regardless of socio-economic status, race, or gender—would have access to technology and, thus, to success through the technologically supported power structures of our culture. This reasoning was based on a series of important cultural realizations: First, that U.S. society would be increasingly dependent on technology in the decades to come; second, that all citizens could benefit from rapid technological development and a vigorous computer sector; third, that schools would be responsible for the education of an increasingly savvy, high-tech workforce; and, fourth, that the current educational system had not yet been successful in providing equitable opportunities to all students.

The context within which these realizations were articulated was influenced by an increasingly acute set of social and educational tensions. As Mary Louise Gomez (1991) explained

United States classrooms are increasingly filled with children who are poor (Kennedy et al., 1986), children who have limited English proficiency (Hispanic Policy Development Project, 1988), and children who are not white (National Center for Education Statistics, 1987a, b). For example, estimates of the growth of the nonwhite school population includes a rise from 24% in 1976 to 30–40% in the year 2000 (Center for Education Statistics, 1987a, b). . . . Currently, 2.5 million school-age children speak a language other than English or come from homes where English is not spoken (Romero et al., 1987), and these numbers will increase as the non-English language background (NELB) population is expected to grow to 39.5 million by the year 2000.

(Gomez, 1991: 319)

These changing demographics of ethnicity and race, moreover, could not be separated from the changing demographics of the U.S. economy in the 1980s. Many of the populations, as Gomez noted, lived in poverty. As she further explained

data show that one in four children in the U.S. lives in poverty. A breakdown of these figures for race shows much higher rates of poverty for blacks (50%) and for Hispanics (40%). Of the 80 million school-age children in the U.S. in 1988, nearly 10 million came from homes headed by a single, female parent (Strong, 1989). For children living in female-headed households, rates of poverty are high, rising to 47.6%, 68.5%, and 70.5% for whites, blacks, and Hispanics (Kennedy et al., 1986). . . . Of students who were enrolled as sophomores in our public secondary schools in 1980, 12.2% of whites had dropped out of school by the autumn of 1982; while in the same period, 17% of black students, 18% of Hispanic students, and 29.2% of Native American students left school.

(Gomez, 1991: 319; Wheelock & Dorman, 1989)

Educators clearly recognized these inequities, and they hoped that personal computers would help the U.S. educational system address them by providing children with an entre into high-tech, high-paying jobs and subsequent economic prosperity. Within this context, the mass integration of personal computers into U.S. classrooms during the decade of the 1980s happened rapidly—especially in courses involving fundamental literacy instruction, such as English composition. According to the National Center for Educational Statistics, for instance, although only 23.4% of Grade 4 reported using a computer in school to write stories or papers in 1984, this number grew to 39.6% by 1988, 48.6% by 1990, 56.9% by 1992, and 68.3% by 1994 (*Condition of Education 1997*, 1997: 56).

The rapid large-scale integration of computers into U.S. classrooms continued throughout the 1980s and 1990s despite a disturbing lack of evidence

that technology provided any help at all for long-standing educational and literacy problems, and even evidence to the contrary (Cole & Griffin, 1987; *Falling Through the Net*, 1995, 1998, 1999, 2000; Sheingold et al., 1987). Teachers, parents, school administrators, and community members, continued to believe that increasing the numbers of computers in schools would result in more citizens from all races and classes who could secure high-tech, high-paying jobs; re-invigorate the computer sector of the nation's economy; and, ultimately, help the United States establish an expanded role in a competitive global marketplace. In part, this belief persisted because it was articulated with what Haraway recognized as a complex "historical system" that "structured relations" (p. 85) between the United States and other peoples of the world.

An important part of this system was the commonly held belief that the United States had the responsibility of ensuring prosperity domestically while creating conditions conducive to the spread of democracy and free-market economic trade so that other nations could benefit from the same advantages on an international basis (Selfe, 1999). Integral to this understanding was a related belief in the superiority of democracy and the conviction that the world would be a better place if the concept of democracies were to spread around the globe. Within such a global system, U.S. citizens reasoned, individuals around the world could exercise freedom of speech and religion; make their own independent choices about local, state, and national issues of importance; and engage in representative forms of government.

At an ideological level, the agenda to extend democracy on a global scale was linked to the success of free-market capitalism, as Haraway pointed out in the "Manifesto". Capitalism was understood to provide an open stage for individuals—regardless of their current position in society—to work hard, invest their own capital and labor, and reap both the rewards and the risks that accrued from such activities. Hence, the freedoms represented by democracy, according to this linked set of beliefs, required an appropriately unregulated economic environment within which to flourish.

Computer technology, in this belief system, was understood as an important vehicle for the expansion of both capitalism and democracy. The Global Information Infrastructure (GII), for instance, was identified by the Clinton administration in 1993 as a primary means of supporting the spread of democratic ideas and free-market capitalism to the rest of the world. Vice President Gore, for example, noted that computer network technologies were designed to provide individuals around the globe access to increasing amounts of information so that they could make "incredibly accurate and efficient decisions" (1991: 150) as literate and responsible citizens.

Of course, this national focus on technology, as Haraway had pointed out in the "Manifesto", was far from innocent. Both the technology and the equipment for creating the GII were to come from the U.S. computer industry—a sector that would be revitalized by supporting increased levels of export, advanced technological research, and the development of new technological

products, and the infusion of knowledgeable employees. A government report in 1993 described the benefits of this domestic dynamic, explaining how the National Information Infrastructure (NII) would provide the springboard for the larger GII:

In an era of global markets and global competition, the technologies to create, manipulate, manage, and use information are of strategic importance for the United States. Those technologies will help U.S. businesses remain competitive and create challenging, high-paying jobs. They will also fuel economic growth which, in turn, will generate a steadily increasing standard of living for all Americans. . . . The development of a national information infrastructure (NII) that enables all Americans to access information and communicate with each other using voice, data, image or video at any time, anywhere. By encouraging private sector investment in the NII's development, and through government programs to improve access to essential services, we will promote U.S. competitiveness, job creation, and solutions to pressing social problems.

*(The National Information Infrastructure, 1993: 5)*

If the Clinton Administration was to build a viable NII and GII, however, a large proportion of Americans had to be educated to use, design, and manufacture sophisticated technologies in increasingly effective ways. The education of the population on such a large-scale constituted, *de facto*, a national project of enormous proportions, especially because it included efforts in all areas of the curriculum. Americans not only had to be able to design and manufacture technology, they had to be able to program, create software products, market technologies, and use electronic networks for communication, among many other tasks.

## 7. EDUCATIONAL CONTEXT

To jump start this effort, in 1996, the Clinton administration allocated \$109 billion (*Getting America's Students Ready*, 1996: 6) to the Technology Literacy Challenge. This national literacy project had the goal of creating a citizenry comfortable in using computers *not only* for the purposes of calculating, programing, and designing, but also for the purposes of *reading, writing, and communicating*. The project's sponsors claimed, further that it would provide *all* Americans equal access to an education rich in opportunities to use and learn about technology. With such an education, it was believed, graduates would be able to gain the qualifications needed for high-tech, high-paying jobs, and thus, to the means of achieving upward social mobility and economic prosperity within an increasingly technological culture (*Getting America's Children Ready*, 1996: 3).

As a result of this funding and the broader national investment in digital literacy that it represented, the proportion of younger American school children who used computers as a literacy tool increased rapidly during the last half of the 1990s. As of 1994, for example, 68.4% of 4th grade students, 82.3% of 8th grade students, and 86.9% of 11th grade students were writing stories or papers on computers (*The Condition of Education 1997*, 1997: 56). By 1999, 98% of all schools owned at least some computers, and the ratio of computers to students, at 1–10, was at an all time low (Coley et al., 1997: 3).

Given this context, enthusiasm for technology use in educational contexts remained generally high during both the 1980s and 1990s. But as Haraway points out, in the “Manifesto”, totalizing narratives of progress and technology never tell the entire story. Even by mid-1980s, educators (Cole & Griffin, 1987; Sheingold et al., 1987) were noting alarming trends in connection with race and poverty associated with computers. Mary Louise Gomez (1991), for example, summarized the findings of a 1987 report authored by Cole and Griffin:

- more computers are being placed in the hands of middle- and upper-class children than poor children;
- when computers are placed in the schools of poor children, they are used for rote drill-and-practice instead of the “cognitive enrichment” that they provide for middle- and upper-class students (pp. 43–44).

Pioneering teacher-scholars such as Richard Ohmann (1985) and David Livingstone (1987) also began to connect the dots between early efforts to expand computer-supported literacy, the forces of monopoly capitalism, and intergenerational patterns of poverty and illiteracy. As Livingstone (1987) noted

Throughout the past 150 years of industrial capitalism, advocates of the extension of public schooling have repeatedly emphasized two basic themes, solidly grounded in technological rationalist and progressive individualist precepts respectively: the importance of formal schooling in upgrading the labor force and ensuring upward social mobility among the disadvantaged.

The essence of the upgrading theme has been the assumption that continual societal progress requires a more socially competent and technically knowledgeable populace, and that such qualities can best be assured through formal schooling. The mobility theme is founded on the belief that individuals control their own destinies, and that schooling can provide equal opportunities for each individual to develop his or her abilities. (p. 127)

Supporting the insights of such scholars was the fact that, despite the money invested in the President’s Technological Literacy Challenge during

the next decade, the same persistent problems of racial and class inequities were proving embarrassingly persistent. By the end of the 1990s, in the American schools system as a whole, and in the culture that this system reflected, computers—and, thus, technological literacy—continued to be distributed differentially along the related axes of race and socio-economic status. And this uneven distribution continued to contribute—as Haraway’s “Manifesto” had foreshadowed—to ongoing patterns of racism, domination, and to the continuation of poverty.

By 1997, for instance, educational researchers noted that schools primarily serving students of color and poor students continued to have less access to computers, and access to less sophisticated computer equipment than did schools primarily serving more affluent students or white students. Moreover, schools primarily serving students of color and poor students were reported to have *less* access to the internet, *less* access to multimedia equipment, *less* access to CD-ROM equipment, *less* access to local area networks, and *less* access to videodisk technology than did schools primarily serving more affluent and white students (Coley et al., 1997: 3).

These data, which were profoundly disturbing, became all the more problematic when linked to the situation in the country’s workplaces and homes. There, too, census figures indicated a strong correlation between race and socio-economic status: Black employees were *less* likely than White employees to use a range of computer applications in their workplace environments; employees who had not graduated from high school were *less* likely to use a range of computer applications than were employees who had a high school degree or had some college experience (*The Digest of Educational Statistics 1996*, 1996: 458); families of color and families with low incomes were *less* likely to own and use computers than were white families and families with higher incomes (cf. *The Condition of Education 1997*, 1997: 212; *The Digest of Educational Statistics 1996*, 1996: 458; *Getting America’s Children Ready*, 1996: 36).

In other words, within the system of domination that Haraway had identified in the “Manifesto”, the poorer individuals were and the less educated they were—both conditions that continued to be closely correlated with race—the less likely they were to be technologically literate and to have access to computers and to high-paying, high-tech jobs. In these terms, then, the national project to expand technological literacy had *not* resulted in a better life or more democratic opportunities or an enriched educational experiences for *all* U.S. citizens, as many believed—or hoped—it might. Rather, it had served to improve the education only for *some* citizens. Moreover, this specific project—and the more general social forces and formations that sustained it, many of which Haraway had identified specifically in the “Manifesto”—had substituted a value on competition and consumerism for a commitment to equal opportunity, democratic cooperation, and a public education that served the common good of this country’s peoples.



Partly as a result of these converging forces, by the last decade of the 20th century, the findings of educators who had expressed early reservations about the educational benefits of technology (Coley et al., 1997; Livingstone, 1987; Ohmann, 1985) began to resonate with the activist intellectual trajectory described by Haraway's "Manifesto". In 1992, for instance, Cynthia Selfe wrote

[O]ne way of working toward the goals of radical democracy—in the spirit of Gilles Deleuze and Felix Guattari (1987) and Donna Haraway (1991a, b)—involves thinking, and trying to act, as what I am going to call nomadic, feminist, cyborg guerillas: nomadic beings (Deleuze & Guattari, 1987) who can inhabit *both* virtual and non-virtual landscapes; contentious, "protean," feminist (Haraway, 1990: 125) beings possessed of attributes both human and machine; disruptive, *oppositional* beings created continually by the technology that we ourselves continually create. By thinking in these terms, I suspect we can come to an increasingly realistic understanding of what is entailed in operating effectively within virtual spaces. We can learn how to balance or restore our own electronic ecology, recognizing that we define in virtual spaces—simultaneously and in continually contradictory ways—both official and anti-official territories. We can explore where we are now standing as educators, from what perspectives we are now seeing and not seeing; we can struggle with our own implication in the very inequities we work to critique or eradicate.

(Laclau & Mouffe, 1987; Selfe, 1992: 16)

In addition to these convergences, many compositionists—even those unfamiliar with Haraway's work when the "Manifesto" was first published—shared with her an understanding of the importance of discourse and rhetoric within specific social contexts; an appreciation of the explanatory power of Marxism, cultural studies, feminism, and post-modern theories; and a belief in social justice and the need to enact productive social change—even if only temporary, partial, and fragmentary. Like Haraway, moreover, many composition and literacy scholars also had a first-hand understanding of the difficulties associated with achieving social justice, enacting change, and resisting the tendential forces associated with stasis. Many of these educators shared a general commitment to enacting productive social change—especially in the venues of educational settings (including classrooms, schools and institutions, writing centers, educational sites in workplaces, and community literacy program) as potential venues for enacting productive social change. Paradoxically, this commitment was shaped by a sense of hope and optimistic pragmatism, even while it was tempered by the skepticism. Much like Haraway, for instance—although these educators did not focus directly on technology studies—critical pedagogists such as Berlin (1994, 1996), Cooper (1986, 1999), Faigley (1992, 1996, 1999), Giroux (1991,

1992a, b), Knoblauch and Brannon (1993), and Ohmann (1985), who were familiar with and influenced by the work of Paulo Friere, possessed a keen understanding of the role that institutions played in reproducing inequities along the related axes of race, class, gender, and orientation.

#### 8. ACADEMIC CONTEXTS: HARAWAY IN COMPUTER-SUPPORTED COMPOSITION CLASSROOMS

Composition and literacy scholars whose work did focus on computer use in classrooms shared with Haraway a complex understanding of technology and technological systems and recognized the contradictory potential of technology. These educators saw technology both as a possible vector for enacting productive change and a powerful force for resisting such change and exacerbating inequitable practices. Their understanding rested on two related insights: That technology consisted not only of machines—of computers, for instance—but also of a complexly articulated set of social formations and that technology and power and literacy practices were linked at fundamental levels (Faigley, 1996, 1999; Kolko et al., 2000; Selfe, 1999). Eventually, the work that these educators undertook went far beyond the use of computers as transcription devices, machines that made revision easier, or mechanisms that supported drill-and-practice approaches to grammar. Inspired by Haraway's vision, scholars in computers and composition studies assumed increasing responsibility for establishing important critical perspectives on the relationship between computers and humans and for shaping computers networks in ways that helped authors think transformatively about their work, and their exchanges with others.

Given this intellectual context, it was little wonder that cyborg politics and scholarship emerged as such a vigorous force in composition studies and had such an impact in computer-supported composition classrooms. At least four major threads of composition studies were strongly influenced by the "Manifesto's" challenge. They included

- implementing computer-based pedagogies in literacy classrooms;
- identifying social justice and equity issues as they affect technological literacy;
- tracing literacy practices and values in post-modern contexts;
- examining how individuals represent themselves in digital literacy environments.

Haraway's "Manifesto" helped ensure that the work of composition scholars and teachers was, wherever possible, mutually informed by pragmatic, theoretical, and political concerns.

Perhaps the most immediate exigency for paying attention to the ideas contained within Haraway's "Manifesto" had to do with the pragmatic material

reality of the U.S. educational system. Within this system, during both the 1980s and 1990s, increasing numbers of students and teachers were being asked to use computers and networked systems in English studies, language arts, and composition classrooms; in writing centers; in educational institutions; in workplace education sites; and in community literacy programs. It became increasingly clear during this period that literacy and technology were inextricably intertwined, at least within American culture, and that, as a result, individuals were no longer considered literate unless they knew how to communicate in the officially sanctioned form of Standard English and within electronic contexts (Selfe, 2000).

Given this context, many of the educational projects carried out in computer-supported composition classrooms during the decade of the 1990s had to do with discovering and designing effective instructional approaches that were based on sound theory and practice, and critically reflecting on—and assessing—the efficacy of such approaches on different populations of students. In this work, compositionists saw computers much as did Haraway in the “Manifesto”—as “coded texts through which we engage in the play of writing and reading the world” (p. 69). Compositionists who believed that critical technology literacy was an essential component of composition pedagogy in computer-supported environments began to write new narratives of pedagogical possibility. These scholars cited Haraway, and often the “Manifesto”, directly, in their explorations of composition pedagogy (Duin and Hanson, 1996; Johnson, 1997; Joyce, 1999; Porter, 1997; Selber, 1997; Sloan, 2000; Wahlstrom, 1997).

Working from this foundation, composition teachers continued to explore and critique the liberatory instructional potential of a wide range of computer-based environments: Among them, computer networks and conferences (Gruber, 1999; Romano, 1999); MOOs, particularly, those designed specifically for language exchanges (Haynes, 1999; Sanchez, 1998); chat rooms (Boese, 1999); listservs (Hocks, 1999; Kolko, 1998a); the web (Hawisher & Sullivan, 1999); e-mail (Grigar, 1999; Monroe, 1999); and computer-based classrooms and labs (Covino, 1998; Snyder, 1996). Pedagogical approaches in these environments were aimed at helping students explore the relationship between writing and identity in virtual environments (DeVoss & Selfe, 2002, Selfe & Selfe, 1994; Takayoshi et al., 1999), made use of chat and MOO transcripts where students could critically examine talk about writing during peer review (Haynes & Holmevik, 1998), and asked students to reflect on their experiences with technology in technology autobiographies (Kitalong et al., 2003). The latter activity helped students interrogate the connection between literacy practices and the development of new technologies. In each of these cases and more, educators resisted the notion that computers were simply tools that transparently facilitated writing and helped students imagine the broader implications of writing practices in technological environments.

Composition teachers also took up Haraway's agenda for social justice and equity—focusing on the issues of race, class, gender, and sexuality as they seemed to be linked to computer-based literacy. These scholars and teachers composed new “ambiguous” (Haraway, “Manifesto”, p. 69) narratives that acknowledged the paradoxes associated with social justice efforts and technological systems. This particular strand of inquiry recognized, as did Haraway, competing discourses of optimism and skepticism, enthusiasm, and critical awareness. Citing Haraway directly or indirectly (by including references to works that *had* cited Haraway) compositionists interrogated claims that computer-based learning environments could encourage increasingly democratic or egalitarian contexts for literate exchanges (Daisley & Romano, 1999; Taylor & Ward, 1998); and questioned the discursive possibilities for women and other under-represented groups practicing literacy in online contexts (Taylor, 1997; Addison & Hilligoss, 1999; Aschauer, 1999; Kolko et al., 2000; Sloan, 1999).

Many compositionists who worked on issues of social justice and equity were influenced by the “Manifesto's” attention to the complex and thorny social and cultural issues associated with technology. These educators often looked at large-scale literacy practices and contexts, focusing, for instance, on inequities related to the differential distribution of—and access to—computers within the American culture, especially along the related axes of race, class, age, or gender (Braun, 2001; Selfe, 1999). Composition teachers and scholars have also found Chéla Sandoval's (1994) theory of “oppositional technologies of power” (p. 409) useful as they questioned constructions of whiteness in critical pedagogy practice (Trainor, 2002) and interrogated the production of traditional and non-traditional (technology-based) academic work (Gruber, 2000).

Compositionists interested in the use of computers also focused, like Haraway, on the dynamic conditions of post-modernity and the changing nature of discursive practices generated within—and sometime in resistance to—these conditions. This work has produced particularly productive examinations of the post-modern values that shape communications in digital and online environments (Bolter & Grusin, 2000; Johnson-Eilola, 1994; Sloan, 1999). Haraway, among others, provided Johndan Johnson-Eilola (1997) with a means by which to question the seemingly transparent and “angelic” operations of hypertext, while at the same time offering teachers strategies for “inhabit[ing] and appropriat[ing], if only partially and rarely, the technologies of literacy” (p. 186). Haraway also proved to be an active influence on the theoretical and pedagogical considerations of multimedia composing. When Jay David Bolter and Richard Grusin examined how new technologies “re-mediate” perceptions of “the real”, for instance, both Haraway and Anne Balsamo were central to their insights about remediation and “technologies of the gendered body” (Balsamo, 1996). Other scholars working in this area explored the claim that conventional forms of discourse, especially those

authorized by modernism, functioned to “imprison” the imagination in various ways. These scholars looked at the possibility that writing in the radically new post-modern environments of computer-based environments might provide ways of “cut[ting] the code” to achieve new kinds of “cyborg heteroglossia”, of engaging in a “radical cultural politics” (Haraway, 1985: 70). Among these, some examined how conventional alphabetic forms constrained communication (Barber & Grigar, 2001; Vielstimmig, 1999). Other educators in this arena explored how new computer-based literacy forms like hypertext might affect both students’ and scholars’ patterns of reading and writing, and, thus, thinking (LeCourt & Barnes, 1999; Snyder, 1996; Vitanza, 2001).

Finally, among the most vigorous intellectual work in composition studies over the past two decades has been that occurring in the area of representation—both graphic and text-based representation—within computer-based literacy environments. This work was often shaped—albeit not always—by concerns of social justice and frequently focused on problematic representations of gender, race, class, and sexuality. Computers and composition scholars working in this arena cited Haraway and other feminist scholars (Kramarae, 1988; Plant, 1997; Turkle, 1984, 1988, 1995; Wahlstrom, 1994; Wajcman, 1991) directly as they tried to identify pedagogical approaches that would help students recognize and resist conventional print and visual representations of women used in cyberspace and in connection with computer technology (Balsamo, 1996; Blair & Takayoshi, 1999; DeVoss & Selfe, 2002; Grigar, 1999; Hawisher & Selfe, 1999, 2001; Hawisher & Sullivan, 1999; Haynes, 1999; Hocks, 1999; Selfe, 1999; Takayoshi, 1994; Takayoshi et al., 1999). Representation projects also focused on resistant identity narratives involving race (Knadler, 2001) and the politics of the body (Kolko, 1998b; Monroe, 1999; Sanchez, 1998).

#### IN LIEU OF A CONCLUSION: THE VALUE OF AMBIGUITY, THE MATERIALITY OF DISCOURSE AND THE NATURE OF CYBORG RESPONSIBILITY

In his analysis of the “manifesto technologies” of Marx, Marinetti and Haraway, Steven Mentor (1996) has observed that, “Haraway’s cyborg manifesto contains a cyborg writing that joins the reader to different prosthetic rhetorical machinery”. Or, as Haraway has put it, “I will never finally say what I mean . . . not because I’m of bad faith[, but] because I’m committed to the proposition that this is neither possible nor a good idea” (Olson, 1996). Haraway’s willingness to embrace the indeterminacy of language seems in some ways at odds with the agenda of the traditional writing classroom where teachers ostensibly help students say what they mean. However, as Marilyn Cooper (1999) has observed, the role of teachers and students in post-modern classrooms may more accurately be characterized by the extent to which students can learn to mean what they say. Allowing students to explore language

in electronic environments gives them “the chance to consciously consider and take responsibility for the effects their actions have on others” (p. 157). Moreover, teachers must be willing to shift the terms of their authority rather than finding new ways to regulate student voices. Haraway’s “cyborg writing” has offered compositionists ways to envision and teach new writing technologies that resist these potentially over-determining effects in order to actively engage with the materiality of language: “Cyborg writing is about the power to survive, not on the basis of original innocence, but on the basis of seizing the tools to mark the world that marked them as other” (1985: 175). Through her fluent and wide-ranging analysis of science, technology, and their rhetorics, Haraway has permanently joined class, race, sexuality, and gender to technology discourse and left her own lasting mark on contemporary composition classrooms.

#### REFERENCES

- Addison, J. & Hilligoss, S. (1999). Technological fronts: lesbian lives ‘on-the-line.’ In: Blair, K. and Takayoshi, P. (Eds.) *Feminist Cyberscapes: Mapping Gendered Academic Spaces*. Stamford, CN: Ablex, 195–226.
- Annals of America, Volume 21, 1977–1986, Opportunities and Problems at Home and Abroad* (1987). Chicago, IL: Encyclopedia Britannica, Inc.
- Aschauer, A. B. (1999). Tinkering with technological skill: an examination of the gendered uses of technologies. *Computers and Composition* 16(1), 7–24.
- Balsamo, A. (1996). *Technologies of the Gendered Body: Reading Cyborg Women*. Durham, NC: Duke University Press.
- Barber, J. & Grigar, D. (2001). *New Worlds, New Words: Exploring Pathways for Writing about and in Electronic Environments*. Creskills, NJ: Hampton Press.
- Berlin, J. (1994). Postmodernism, the college curriculum, and composition. In: Winterowd, W. R. and Gillespie, V. (Eds.) *Composition in Context*. Carbondale, IL: Southern Illinois University Press, 46–61.
- Berlin, J. A. (1996). English studies, work, and politics in the new economy. In: Bloom, L. Z., Daiker, D. A., and White, E. M. (Eds.) *Composition in the Twenty-first Century: Crisis and Change*. Carbondale, IL: Southern Illinois University Press, 215–225.
- Blair, K. & Takayoshi, P. (Eds.) (1999). *Feminist Cyberscapes: Mapping Gendered Academic Spaces*. Stamford, CN: Ablex.
- Boese, C. (1999). A virtual locker room in classroom chat spaces: the politics of men as “other.” In: Blair, K. and Takayoshi, P. (Eds.) *Feminist Cyberscapes: Mapping Gendered Academic Spaces*. Stamford, CN: Ablex, 195–226.
- Bolter, J. D. & Grusin, R. (2000). *Remediation*. Cambridge, MA: MIT Press.
- Braun, M. J. (2001). The political economy of computers and composition: ‘Democracy Hope’ in the era of globalization. *JAC* 21(1), 129–162.
- Cole, M. & Griffin, P. (1987). *Contextual Factors in Education: Improving Science and Mathematics Education for Minorities and Women*. Madison, WI: Wisconsin Center for Education Research, University of Wisconsin-Madison.
- Coley, R. J., Crandler, J., & Engle, P. (1997). *Computers and Classrooms: The Status of Technology in U.S. Schools*. Educational Testing Service, Policy Information Center. Princeton, NJ: ETS.

- Cooper, M. M. (1986). The ecology of writing. *College English* 48, 364–375.
- Cooper, M. M. (1999). Postmodern pedagogy in electronic conversations. In: Hawisher, G. and Selfe, C. (Eds.) *Passions, Pedagogies, and 21st Century Technologies*. Logan, UT: Utah State University Press, 140–160.
- Council of Economic Advisors. (February 1985). *Economic Report of the President*. Washington, DC: Government Printing Office.
- Council of Economic Advisors. (February 1990). *Economic Report of the President*. Washington, DC: Government Printing Office.
- Covino, W. (1998). Cyberpunk literacy; or, piety in the sky. In: Taylor, T. and Ward, I. (Eds.) *Literacy Theory in the Age of the Internet*. New York: Columbia University Press, 34–46.
- Daisley, M. & Romano, S. (1999). Thirteen ways of looking at an m-word. In: Blair, K. and Takayoshi, P. (Eds.) *Feminist Cyberscapes: Mapping Gendered Academic Spaces*. Stamford, CN: Ablex, 327–356.
- Deleuze, G. & Guattari, F. (1987). *A Thousand Plateaus: Capitalism and Schizophrenia*, Brian, M. (Trans.) Minneapolis: University of Minnesota Press.
- DeVoss, D. & Selfe, C. L. (2002). This page is under construction: reading women shaping on-line identities. *Pedagogy* 2(1), 31–48.
- Digest of Education Statistics 1996*. (November 1996). National Center for Educational Statistics, Office of Educational Research and Improvement, U.S. Department of Education, NCES 96–133.
- Duin, A. H. & Hansen, C. J. (Eds.). (1996). *Nonacademic Writing: Social theory and Technology*. Mahway, NJ: Lawrence Erlbaum Associates.
- Escobar, A. (1994). Welcome to Cyberia: notes on the anthropology of cyberculture. *Current Anthropology* 35(3), 211–231.
- Faigley, L. (1992). *Fragments of Rationality: Postmodernity and the Subject of Composition*. Pittsburgh: University of Pittsburgh Press.
- Faigley, L. (1996). Literacy After the Revolution. Address presented at the Conference on College Composition and Communication, March, 1996, Milwaukee, WI.
- Faigley, L. (1999). Beyond imagination: the Internet and global digital literacy. In: Hawisher, G. and Selfe, C. (Eds.) *Passions, Pedagogies, and 21st Century Technologies*. Logan: Utah State University Press, 129–139.
- Falling through the Net: Toward Digital Inclusion: A Report on Americans' Access to Technology Tools*. (October 2000). United States Department of Commerce, Economic and Statistics Administration, and National Telecommunication and Information Administration, Washington, D.C., October 2000. Accessed 16 October 2001 at <<http://www.ntia.doc.gov/ntiahome/digitaldivide/>>
- Falling through the Net: Defining the Digital Divide*. (July, 1999). United States Department of Commerce, Economic and Statistics Administration, and National Telecommunication and Information Administration, Washington, D.C., July 1999. Accessed 16 October 2001 at <<http://www.ntia.doc.gov/ntiahome/digitaldivide/factsheets.htm>>.
- Falling through the Net: Toward Digital Inclusion: A Report on Americans' Access to Technology Tools*. (1998).
- Falling through the Net: Defining the Digital Divide*. (July, 1995).
- Feenberg, A. (1999). *Questioning Technology*. London: Routledge.
- Gergen, K. J. (1991). *The Saturated Self: Dilemmas of Identity in Contemporary Life*. New York, NY: Basic Books.
- Giroux, H. A. (1991). Modernism, postmodernism, and feminism: rethinking the boundaries of educational discourse. In: Giroux, H. A. (Ed.) *Postmodernism, Feminism, and Cultural Politics: Redrawing Educational Boundaries*. Albany: State University of New York Press, 1–59.

- Giroux, H. A. (1992a). *Border Crossings: Cultural Workers and the Politics of Education*. New York: Routledge.
- Giroux, H. A. (1992b). Resisting difference: cultural studies and the discourse of critical pedagogy. In: Grossberg, L., Nelson, C., and Treichler, P. (Eds.) *Cultural Studies*. New York: Routledge, 199–212.
- Gomez, M. L. (1991). The equitable teaching of composition. In: Hawisher, G. E. and Selfe, C. L. (Eds.) *Evolving Perspectives on Computers and Composition Studies*. Urbana, IL and Houghton, MI: The National Council of Teachers of English and Computers and Composition Press, 318–335.
- Gore, A. (1991). Infrastructure for the global village. *Scientific American* 265(3), 150–153.
- Gray, C. H. (1989). The cyborg soldier: The U.S. military and the post-modern warrior. In: Lev- idow, L. and Robins, K. (Eds.) *Cyborg Worlds: The Military Information Society*. London: Free Association, 43–71.
- Gray, C. H. (Ed.) with Figueroa-Sarriera, H. J. & Mentor, S. (1995)s. *The Cyborg Handbook*. New York: Routledge.
- Grigar, D. (1999). Over the line, online, gender issues: e-mail and women in the classroom. In: Blair, K. and Takayoshi, P. (Eds.) *Feminist Cyberscapes: Mapping Gendered Academic Spaces*. Stamford, CN: Ablex, 257–283.
- Gromala, D. (1996). Pain and subjectivity in virtual reality. In: Hershman Leeson, L. (Ed.) *Clicking In: Hot Links to a Digital Culture*. Seattle: Bay Press, 222–237.
- Grossberg, L. (Ed.) with Nelson, C., Treichler, P. A. (1992). *Cultural Studies*. New York: Routledge.
- Gruber, S. (1999) I, a Mestiza, continually walk out of one culture into another: Alba's story. In: Blair, K. and Takayoshi, P. (Eds.) *Feminist Cyberscapes: Mapping Gendered Academic Spaces*. Stamford, CN: Ablex, 105–132.
- Gruber, S. (2000). Technology and tenure: creating oppositional discourse in an online and offline world. *Computers and Composition* 17(1), 41–55.
- Haraway, D. (1985). A manifesto for cyborgs: science, technology, and socialist feminism. *Socialist Review* 80(March/April), 64–107.
- Haraway, D. (1990). A manifesto for cyborgs: science, technology, and socialist feminism. In: Nicholson, L. J. (Ed.), *Feminism/postmodernism*. London: Routledge, Chapman & Hall, 190–233.
- Haraway, D. (1991a). *Simians, Cyborgs, and Women: The Reinvention of Nature*. New York: Routledge.
- Haraway, D. (1991b). The promise of monsters: A regenerative politics for inappropriate/d others. In Grossberg, L., Nelson, C., and Treichler, P. (Eds.) *Cultural Studies*. New York: Routledge, 183–201.
- Haraway, D. (1997a). Ecce homo, ain't (ar'n't) I a woman, and inappropriate/d others: the human in a post-humanist landscape. In: Butler, J. and Scott, J. W. (Eds.) *Feminists Theorize the Political*. New York: Routledge, 86–100.
- Haraway, D. (1997b). *Modest\_Witness@Second\_Millennium.FemaleMan©\_Meets\_OncoMouse™*. New York: Routledge.
- Hawisher, G. E., LeBlanc, P., Moran, C., Selfe, C. L. (1996). *Computers and the Teaching of Writing in American Higher Education, 1979–1994: A History*. Norwood: Ablex.
- Hawisher, G. E. & Selfe, C. L. (2001). Dispatches from the middlewor(l)ds of computers and composition: experimenting with writing and visualizing the future. In: Barber, J. & Grigar, D. (Eds.) *New Worlds, New Words: Exploring Pathways for Writing about and in Electronic Environments*. Creskills, NJ: Hampton Press, 185–210.
- Hawisher, G. E. & Selfe, C. L. (Eds.) (1999). *Passions, Pedagogies, and 21st Century Technologies*. Logan, UT: Utah State University Press.



- Hawisher, G. E. & Sullivan, P. (1999). Fleeting images: women visually writing the web. In: Hawisher, G. and Selfe, C. (Eds.) *Passions, Pedagogies, and 21st Century Technologies*. Logan, UT: Utah State University Press, 140–160.
- Hayles, N. K. (1984). *The Cosmic Web: Scientific Field Models and Literary Strategies in the Twentieth Century*. Ithaca: Cornell University Press.
- Hayles, N. K. (1995). The life cycle of cyborgs: writing the posthuman. In: Gray, C. H. (Ed.) *The Cyborg Handbook*. New York: Routledge, 321–335.
- Hayles, N. K. (1999). *How We Became Posthuman: Virtual Bodies in Cybernetics, Literature, and Informatics*. Chicago: University of Chicago Press.
- Hayles, N. K. (2002). *Writing Machines*. Cambridge: the MIT Press.
- Haynes, C. (1999). Virtual diffusion: ethics, techne, and feminism at the end of the cold millenium. In: Hawisher, G. and Selfe, C. (Eds.) *Passions, Pedagogies, and 21st Century Technologies*. Logan, UT: Utah State University Press, 337–347.
- Haynes, C. and Holmevik, J. R. (1998). *High Wired: On the Design, Use, and Theory of Educational MOOs*. Ann Arbor: University of Michigan Press.
- Herring, S. (1996). Posting in a different voice. In: Ess, C. (Ed.) *Philosophical Perspectives on Computer-Mediated-Communication*. New York: State University of NY Press, 115–145.
- Hocks, M. E. (1999). Feminist interventions in electronic environments. *Computers and Composition* 16(1), 107–120.
- Johnson-Eilola, J. (1997). *Nostalgic Angels: Rearticulating Hypertext Writing*. Norwood, NJ: Ablex.
- Johnson-Eilola, J. (1994). Reading and writing in hypertext: Vertigo and Euphoria. In: Selfe, C. and Hilligoss, S. (Eds.) *Literacy and Computers: The Complications of Teaching and Learning with Technology*. New York: MLA, 195–219.
- Johnson, R. (1997). Audience involved: toward a participatory model of writing. *Computers and Composition* 14(3), 361–376.
- Johnston, W. B. & Packer, A. H. (1987). *Workforce 2000: Work and Workers for the 21st Century*. Indianapolis, IN: Hudson Institute.
- Joyce, M. (1999). Beyond next before you once again: repossessing and renewing electronic culture In: Hawisher, G. and Selfe, C. (Eds.) *Passions, Pedagogies, and 21st Century Technologies*. Logan, UT: Utah State University Press, 399–417.
- Kennedy, M. M., Jung, R. K., and Orland M. E. (1986, January). Poverty, Achievement, and the Distribution of Compensatory Education Services. (An interim report from the National Assessment of Chapter 1, OERI), Washington, D.C.: U.S. Government Printing Office.
- Kitalong, K., Bridgeford, T., Moore, M., & Selfe, D. (2003). Variations on a theme: the technology autobiography as a versatile writing assignment. In: Takayoshi, P. and Huot, B. (Eds.) *Teaching Writing with Computers: An Introduction*. Boston, Houghton, Mifflin, 219–233.
- Knadler, S. (2001). E-racing difference in e-space: black female subjectivity and the web-based portfolio. *Computers and Composition* 18(3), 235–256.
- Knoblauch, C. H. & Brannon, L. (1993). *Critical Teaching and the Idea of Literacy*. Portsmouth, NH: Boynton/Cook.
- Kolko, B. E. (1998a). Intellectual property in synchronous and collaborative virtual space. *Computers and Composition* 15(2), 163–184.
- Kolko, B. E. (1998b). We are not just electronic words: learning the literacies of culture, body, and politics. In: Taylor, T. and Ward, I. (Eds.) *Literacy Theory in the Age of the Internet*. New York: Columbia University Press, 61–78.
- Kolko, B., Nakamura, L., & Rodman, G. B. (Eds.) (2000). *Race in Cyberspace*. New York: Routledge.

- Kramarae, C. (1988). Gotta go, Myrtle, technology's at the door. In: Kramarae, C. (Ed.) *Technology and Women's Voices: Keeping in Touch*. New York: Routledge, 1–14.
- Kramarae, C. & Taylor, H. J. (1993). Women and men on electronic networks: a conversation or a monologue? In: Taylor, H. J., Kramarae, C., and Ebben, M. (Eds.) *Women, Information Technology, and Scholarship*. Urbana, IL: Women, Information Technology, and Scholarship Colloquium, 52–61.
- Kurzweil, R. (1990). *The Age of Intelligent Machines*. Cambridge: MIT Press.
- Laclau, E. & Mouffe, C. (1985). *Hegemony and Socialist Strategy: Toward a Radical Democratic Politics*. London: Verso.
- Landsberg, A. (1995). Prosthetic memory: *Total Recall* and *Blade Runner*. *Body and Society* 1(3–4), 175–189.
- Latour, B. (1988). Mixing humans and nonhumans together: the sociology of a door closer. *Social Problems* 35, 298–310.
- Latour, B. (1993). *We Have Never Been Modern* (C. Porter, Trans.) Cambridge, MA: Harvard University Press.
- LeCourt, D. & Barnes, L. (1999). Writing multiplicity: hypertext and feminist textual politics. *Computers and Composition* 16(1), 55–72.
- Levidow, L. & Robins, K. (Eds.) (1989). *Cyborg Worlds: The Military Information Society*. London: Free Association Books.
- Livingstone, D. (Ed.) (1987). *Critical Pedagogy and Cultural Power*. South Hadley, MA: Bergin & Garvey Publishers, Inc.
- Mead, M. (1970). *Culture and Commitment: The New Relationship between the Generations in the 1970s*. New York, NY: Doubleday.
- Mentor, S. (1996). Manifesto technologies: Marx, Marinetti, Haraway. In: Gray, C. H. (Ed.) *Technohistory: Using the History of American Technology in Interdisciplinary Research*. Melbourne, FL: Krieger Publishing.
- Merit's History: Three Decades of Growth, Innovation, and Achievement at Michigan's Leading ISP (1998). An article reprinted from *Library Hi Tech* (Vol. 16, No. 1) and accessed 24 April 2000 from Merit web site at <<http://www.merit.edu>>.
- Miller, L. (1995). Women and children first: gender and the settling of the electronic frontier. In: Brook, J. and Boals, I. A. (Eds.) *Resisting the Virtual Life: The Culture and Politics of Information*. San Francisco: City Lights, 49–57.
- Monroe, B. (1999). Remembering mama: the female body in embodied and disembodied communication. In: Blair, K. and Takayoshi, P. (Eds.) *Feminist Cyberscapes: Mapping Gendered Academic Spaces*. Stamford, CN: Ablex, 63–82.
- Nakamura, L. (1995a). Where do you want to go today? Cybernetic tourism, the Internet, and transnationality. In: Kolko, B., Nakamura, L., and Rodman, G. B. (Eds.) *Race in Cyberspace*. New York: Routledge, 15–26.
- Nakamura, L. (1995b). Race in/for cyberspace: identity tourism and racial passing on the Internet. *Works and Days* 13(1–2), 181–193.
- Noble, D. D. (1989). Mental material: The militarization of learning and intelligence. In: Levidow, L. and Robins, K. (Eds.) *Cyborg Worlds: The Military Information Society*. London: Free Association Books, 13–42.
- Oehlert, M. (1995). From Captain America to Wolverine: cyborgs in comic books: Alternative images of cybernetic heroes and villains. In: Gray, C. H. (Ed.) *The Cyborg Handbook*. London: Routledge, 219–232.
- Ohmann, R. (1985). Literacy, technology, and monopoly capitalism. *College English* 47(7), 675–689.
- Olson, G. (1996). Writing, literacy, and technology: toward a cyborg writing. *JAC* 16(1). Website accessed 15 January 2003 at <<http://jac.gsu.edu/jac/16.1/Articles/1.htm>>.

- Plant, S. (1997). *Zeros + Ones : Digital Women + the New Technoculture*. New York: Bantam Doubleday Dell.
- Polsson, K. (2000). *Chronology of Events in the History of Microcomputers*. Web site accessed 22 March 2000 at <<http://www.islandnet.com/~kpolsson/comphist/>>
- Porter, J. (1997). Legal realities and ethical hyperrealities: a critical approach toward cyberwriting. In: Selber, S. (Ed.) *Computers and Technical Communication: Pedagogical and Programmatic Perspectives*. Greenwich, CN: Ablex, 45–74.
- Romano, S. (1999). On becoming a woman: pedagogies of the self. In: Hawisher, G. and Selfe, C. (Eds.) *Passions, Pedagogies, and 21st Century Technologies*. Logan, UT: Utah State University Press, 249–267.
- Romero, M.; Mercado, M.; and Vazquez-Faria, J. A. (1987). *Students of Limited English Proficiency*. In: V. Richardson Koehler (Ed.), *Educator's Handbook: A Research Perspective*. White Plains, N. Y. Longman, 348–369.
- Sanchez, R. (1998). Our bodies? Our selves?: questions about teaching in the MUD. In: Taylor, T. and Ward, (Eds.) *Literacy Theory in the Age of the Internet*. New York: Columbia University Press, 93–108.
- Sandoval, C. (1994). Re-entering cyberspace: sciences of resistance. *Disposition* 19, 75–93.
- Sandoval, C. (1995). New sciences: cyborg feminism and the methodology of the oppressed. In: Gray, C. H. (Ed.) *The Cyborg Handbook*. New York: Routledge, 407–422.
- Selber, S. A. (1997). *Computers and Technical Communication: Pedagogical and Programmatic Perspectives*. Greenwich, CN: Ablex.
- Selfe, C. L. (2000). Digital divisions: cultural perspectives on information technology. *The English and Media Magazine* 42(3), 12–17.
- Selfe, C. L. (1999). *Technology and Literacy in the Twenty-First Century: The Importance of Paying Attention*. Carbondale: SIU Press.
- Selfe, C. L. (1992). Politicizing and Inhabiting Virtual Landscapes as Discursive Spaces. Paper presented at the 1992 Meeting of Computers and Writing, May 1992.
- Selfe, C. L., & Selfe, R. J., Jr. (1994). The politics of the interface: Power and its exercise in electronic contact zones. *College Composition and Communication* 45(4), 480–505.
- Selfe, C. L. & Selfe, R. J. (1996). Writing as democratic social action in a technological world. In: Duin, A. and Hansen, C. (Ed.) *Nonacademic Writing: Social Theory and Technology*. Mahwah, NJ: Lawrence Erlbaum, 325–358.
- Selber, S. A. (1997). *Computers and Technical Communication: Pedagogical and Programmatic Perspectives*. Greenwich, CN: Ablex.
- Sheingold, K. & Pea, R. D. (Eds.) (1987). *Mirrors of Minds: Patterns of Experience in Educational Computing*. Norwood, NJ: Ablex.
- Snyder, I. (1996). *Hypertext: The Electronic Labyrinth*. Melbourne: Melbourne University Press.
- Sloan, S. (2000). *Digital Fictions: Storytelling in a Material World*. Stamford, CT: Ablex.
- Sloan, S. (1999). Postmodernist looks at the body electric: e-mail, female, and hijra. In: Blair, K. and Takayoshi, P. (Eds.) *Feminist Cyberscapes: Mapping Gendered Academic Spaces*. Stamford, CN: Ablex, 41–62.
- Sobchack, V. (1994). New age mutant ninja hackers: Reading Mondo 2000. In: Dery, M. (Ed.), *Flame Wars: The Discourse of Cyberculture*. Durham: Duke University Press, 11–28.
- Stone, A. R. (1992). Will the real body please stand up? Boundary stories about virtual cultures. In: Benedikt, M. (Ed.) *Cyberspace: First Steps*. Cambridge, MA: MIT Press, 81–118.
- Strong, L. A. (1989). The Best Kids They Have. *Educational Leadership*, 46(5), 2.
- Takayoshi, P. (1994). Building new networks from the old: women's experiences with electronic communication. *Computers and Composition* 11(1), 21–36.

- Takayoshi, P., Huot, E., & Huot, M. (1999). No boys allowed: the World Wide Web as a clubhouse for girls. *Computers and Composition* 16(1), 89–106.
- Taylor, T. (1997). The persistence of difference in networked classrooms: non-negotiable difference and the African American student. *Computers and Composition* 14(2), 169–178.
- Taylor, T. & Ward, I. (Eds.) (1998). *Literacy Theory in the Age of the Internet*. New York: Columbia University Press.
- The Condition of Education 1997* (June 1997). National Center for Education Statistics, Office of Educational Research and Improvement. U.S. Department of Education. Washington DC, NCES 97-388. <<http://www.edu.gov/NCES/pubs/ce/c9705A01.html>>
- The Condition of Education 1980*. (1980). National Center for Education Statistics, Office of Educational Research and Improvement. U.S. Department of Education. Washington DC, NCES 80-400.
- Thurston, C. (1994). Computer-assisted instruction. In: *Encyclopedia of English Studies and Language Arts*. New York: NCTE, 250–252.
- Tomas, D. (1989). The technophilic body: on technicity in William Gibson's cyborg culture. *New Formations* 8, 113–129.
- Timeline of Computing History*. (1996). Computer: Innovative Technology for Computer Professionals. IEEE web site accessed 22 March 2000 at <<http://www.computer.org/computer/timeline/>>.
- Trainor, J. S. (2002). Critical pedagogy's "other": constructions of whiteness in education for social change. *College Composition and Communication* 53(4), 631–650.
- Turkle, S. (1984). *The Second Self: Computers and the Human Spirit*. London: Granada.
- Turkle, S. (1995). *Life on the Screen: Identity in the Age of the Internet*. NY: Simon and Schuster.
- Turkle, S. (1988). Computational reticence: why women fear the intimate machine. In: Kramarae, C. (Ed.) *Technology and Women's Voices: Keeping in Touch*. London: Routledge, 41–61.
- Vielstimmig, M. (1999). Petals on a wet black bough: textuality, collaboration, and the new essay. In: Hawisher, G. and Selfe, C. (Eds.) *Passions, Pedagogies, and 21st Century Technologies*. Logan, UT: Utah State University Press, 89–114.
- Vitanza, V. (2001). In-between: or, writing on the midway. In: Barber, J. and Grigar, D. (Eds.) *New Worlds, New Words: Exploring Pathways for Writing about and in Electronic Environments*. Creskills, NJ: Hampton Press, 75–94.
- Wajcman, J. (1991). *Feminism Confronts Technology*. University Park: Pennsylvania University Press.
- Wahlstrom, B. (1994). Communication and technology: defining a feminist presence in research and practice. In: Selfe, C. and Hilligoss, S. (Eds.) *Literacy and Computers: The Complications of Teaching and Learning with Technology*. New York: MLA, 171–185.
- Wahlstrom, B. (1997). Teaching and learning communities: locating literacy, agency, and authority in a digital domain. In: Selber, S. (Ed.) *Computers and Technical Communication: Pedagogical and Programmatic Perspectives*. Greenwich, CN: Ablex, 129–147.
- Wheelock, A., & Dorman, G. (1989). *Before It's Too Late*. Boston, MA: Massachusetts Advocacy Commission.
- Wise, J. M. (1997). *Exploring Technology and Social Space*. Thousand Oaks, CA: Sage.

## Chapter 6: The Political Economy of the Internet: Contesting Capitalism, the Spirit of Informationalism, and Virtual Learning Environments

JEREMY HUNSINGER

*University of Toronto, Koku University of Toronto,  
Hunsinger Virginia Polytechnic Institute and State University*

In Neal Stephenson's *Diamond Age* the world is transformed by a series of events surrounding the creation of a virtual learning environment in the form of a book, *The Young Lady's Illustrated Primer*. It is a story of power, liberation, social division, and transformation. It is a fable of information technology and virtual learning environments in which the dustpan world of Stephenson's novel is overcome. The social structures that create the virtual learning environment are transformed by its creation, creating a population that are critically aware of their situation and what they can do to change it. Similarly, virtual learning environments are transforming learning and thus transforming the world and our understanding of it. Inherently these environments, like all technological environments, contain systemic, ideological biases, and assumptions. We need to be critically aware of these environments, their biases and assumptions and the world that creates, endorses, and in the end supports them, so that we have the ability to understand our responsibilities toward not merely their usage, but their creation, and what is built into them, the biases, values, and ideological positions.

For virtual learning, it is clear that human interests and social structures are politicized and embedded in the relationships of power found in the era of informational capitalism. The power is merely embedded not only in the social world, but also in our technics, our institutions, and our ecology. Informational capitalism has transformed the world and made it a more interesting and problematic place to live. In its moment, informational capitalism has transformed the landscape of education, brought about the advent of the virtual learning environments, a new contestation surfaces involving the manifold roles of information and knowledge, their centralization and distribution through society. In attempting to come to grips with these issues for virtual learning environments, I confront the spirit of informationalism as conceived by Manuel Castells. I question the explicit ideas for it in the context of online education as network enterprises.

“The spirit of informationalism” is the culture of “creative destruction” accelerated to the speed of the opto-electronic circuits that process its

signals, Schumpeter meets Weber in the Cyberspace of the Network Enterprise”.

(Castells, 2000: 215)

Castells sees the recreation of the digital world through the Schumpeterian idea of creative destruction, this is a conception of innovation and labor, where an old set of institutions is destroyed and a new one is created to take its place. But I argue, the old set of institutions, the old forms, and clearly the old powers, are implicit in the new network enterprises; they are not destroyed as much as they are recreated in the informational arena. Through this continue recreation of old forms into new combined with the ongoing capitalist enterprise, there becomes new centralizations of information, new places that hold power, and want to retain power.

Informational capitalism requires us to accept the perspective that information transforms the central systems of our economy, and with that has ripple effect to everything that depends on those systems. To understand one of those ripples, virtual learning environments, we have to understand what information is in the context of learning and learning’s goal—knowledge.

#### 1. INFORMATION AND KNOWLEDGE

Our everyday life is enmeshed in information. From its physical manifestation in computer-aided design of toasters and cars to its purely digital form constituting the monetary flows of capitalism, internet broadcasted lectures, and the textual flows of e-mail, information is ubiquitous. These digital goods constitute a significant part of our economic, social, and political milieu. “Digital goods—by which I mean things we produce, such as this book in its original form, that can be reduced to 1’s and 0’s—are materially different from other goods, mainly in that they are material-less and have economic lives of their own” (Mckenzie, 2003: 2). The 1s and 0s fill our everyday existence, constructing and signaling everything from traffic signals to art. These fundamental reductions seem to have lives of their own because they are informational signaling systems that control parts of our lives and occasionally interact in unexpected ways. Information’s core conception is that it contains meaning. Meaning is constructed and reconstructed through interaction. Humans and machines interact with it and are left changed. That information can impart change is very important to it as a concept, because it explains its importance for our economy and society and as such why control of information is transforming our lives and institutions. Information causes change, and the ability to control that change is a significant power in our everyday lives. The moments of informational capitalism are inscribed in these digital goods and the implications for this are not dissimilar to the effects of prior revolutions in material culture on everyday life and as such learning.

In the context of learning, information is not synonymous with knowledge as Lively indicates, “Information is knowledge in any form” (Lively, 1996). Contrarily, one type of information is encoded knowledge, knowledge abstracted and removed from the subject and encoded into any of a myriad of forms. Other types of information may encode the values, norms, ideologies, and other meaningful abstract systems, which may be embedded in knowledge, but may also be externalized in other meaningful parts of our ecology. Knowledge though, when it is encoded, is transformed into information. The encoding process varies, and with it, the usefulness of the information it produces varies. Digitalization, for instance, transforms knowledge into zeros and ones, making it, giving it some use in digital technologies, such as computers or the internet. “Digitalization shifts human agency and structure to a register of informational bits from one of manufactured matter” (Luke, 1995). Digitalization transforms knowledge from its analogue whole to its digitalized parts, fragmenting it, and allowing less meaningful parts to be forgotten altogether. It creates an informational representation of the analogue, abstracted at a definable level, losing richness and completeness for the sake of control, ubiquity, and efficiency, shifting the registers of subjectivity with it. While digitalization is conceivably a manual activity, it usually requires an immense amount of human labor, machinics, and informatics to enable its functional use in society. This labor is in part of our subjectivity that we are embedding through the labor process into the digital object. Combining the embedded labor with the embedded knowledge the digital, informationalized object contains the moment of informationalization to a form of alienation of subjectivity. This alienation of subjectivity has been seen in the industrial age as a normalized function of production. However, in digitalization, the informationalized object no longer is objectified as physical artifacts, books, papers, etc., but it is informational, which entails that with the proper tools, we can make infinite copies and distribute them without cost. This mode of production and distribution transforms the value structure of the artifact transforms the value structure surrounding our subjectivity, and with that transforms the structures surrounding knowledge, devaluing and to some extent delegitimizing them (Lyotard, 1984).

Similarly to books and traditional instructional materials, information forms and requires an infrastructure. The infrastructure contains implicit and explicit biases about labor, subjectivity, and power, just like the infrastructures of material culture. The infrastructures themselves also encode norms, traditions, and modes of use, distribution, and production. “While design intentions can be evaded or subverted, as most hacking practices indicate, the infostructures raised in cyberspace also begin to conventionalize how and why they are used by most of their clients (Luke, 1995). This conventionalization is normalization. As new digital tools are created, they recreate the environments that their creators use to create them, thus the cultural systems embedded in these tools are not only distributed as product by consumed by their creators.

This creates contested spaces of cultural production that parallels and constitutes the mode of production of the digital artifacts. There is a “hacker” space, that many think countervenes but in most places eventually sublimates itself into informational capitalism (Castells, 2002; Himmanen, 2001). The subversion found in hackers and their alternative mode of production, which seems to be a subaltern, is actually a substructure of the hegemony. The creative practice of coding in informational capitalism is always integrated into the larger whole.

The codification of knowledge and the architecting of its infrastructures is clearly an immense, ongoing project that is encapsulating both the past and seeks to encapsulate the future. The institutions pursuing this encapsulation and their corresponding norms and traditions surrounding information are just as important as the information itself. This might be why some metaphors and ideas carry well in the provision of information; the library, the encyclopedia, and the journal have their metaphorical relation in digital space. It might also be why builders of informational spaces structure them similarly to their own experiences in the classroom or elsewhere. They want to pass on their traditions, real or imagined, in this digital environment. The old physical form is made new in digital form to conventionalize and normalize the way people use the information provided by technocrats and through their infotechnics.

The information itself, to be used, must be interpreted either by a human or machine. These interpreters are nodes that make the knowledge available. Once available, information tends to flow either as knowledge amongst humans or socio-technical networks like the internet to reach another node of translation. These networks are the central institutional structures of the information society, and the manifold ways that they order and structure our world is still being understood. These networks can be understood to operate on many levels, from the interpersonal network, to the global information superhighway, to the massive networks of economies, monetary exchange, and capital flows. They can be seen along the whole spectrum of analysis, from the atomic like digital subjectivity to the molar like integrated world informational capitalism (Guattari, 2000). With these networks we have interactions and interchanges, and transformations at all levels, they are always in flux, and so, along with the information they contain, must be interpreted, and must be converted into knowledge through interpretation. These networks require human and machinic capacity to operate, and in that requirement they require certain knowledges and ideas to be inculcated into future generations of the network and the culture surrounding it, until such a point as it becomes apparent that they do not apply and then we have a change, paradigm shift, or minor revolution (Fleck, 1981; Kuhn, 1996; Lakatos, 1980).

Castells believes the transformation from the industrial age to the information age is revolutionary. In that revolution, there is another relationship



between information and knowledge that is transformed by thinking about information. “What we think, and how we think, become expressed in goods, services, material and intellectual output, be it food shelter, transportation and communication systems computers, missiles, health, education, or images” (Castells, 31). If the goods, services, and productive outputs structure the way we think then information itself structures the way we think. What we believe about information, such as “information wants to be free”, structures our worldview. Our knowledge about information may be true or not, but in either case; it structures our relationship to information. If we believe the learning environment to be a marketable good in all cases, then institutions and tools will reflect that belief and with that, you have changed the premises of education and educational institutions toward a market mentality and in that transformed the future.

## 2. INFORMATIONAL SPACE AND INFORMATIONAL POWER

While there are many forms of power operating on many levels of analysis in informational capitalism, informational power is one of the defining forms of power within the spaces it inhabits. Lefebvre indicates this in his conclusion of *The Production of Space*:

Historical formations flow into worldwide space much like rivers debouching into the ocean: some spread out into a swampy delta, while others suggest the turbulence of a great estuary. Some, in democratic fashion, rely on the force of inertia to insure their survival; others look to power and violence (of strategic—and hence military and political—kind).

(Lefebvre, 1991: 417)

Power flows through and inhabits space through the social presences of human beings and the technologies they create and use in that space. Power is a subjective and universal part of human experience. It is embedded in language, and operates as much through discursive formations as through physical force. For the first time in history, the human mind is a direct productive force, not just a decisive element of the production system (Castells, 2000: 31). There is a very real aspect of all forms of power, and it can be analyzed in a variety of ways. With the recognition of information all around us, the recognition of power operating in and through information, as much as through any other interaction or artifact, becomes manifest. Much like the physical power of arms and armies, informational power is about spaces or territories, and what is allowed to pass through those spaces.

Comprehending the nature of this power perhaps can be aided by Foucault’s description:

Power is not something that is acquired, seized, or shared, something that one holds on to or allows to slip away; power is exercised from innumerable points, in the interplay of non-egalitarian and mobile relations . . . Power comes from below; that is, there is no binary and all encompassing opposition between rulers and ruled at the root of power relations, and serving as a general matrix—no such duality extending from the top down and reacting on more and more limited groups to the very depths of the social body.

(Foucault, 1978)

In short, power is not purely the dominating power of armies, but it also exists as dispersed and pastoral. It is a power of control, but it is not limited to the manipulation of base emotion, like fear based in inequities in the means of production and their control, it is habituated and constructed into the very subjectivity of the individual and populace, through the establishment of norms, traditions, and similar systems. This power governs populations as much as any other, and it is through its operations that governance that a political economy of the internet are made possible.

The spaces of power though need not be real spaces, though real spaces have much the same characteristics. The construction of virtual spaces whether perceived or imagined also holds and sustains power

Software and networks do more than structure and present information; they also generate and sustain spaces, or hyperreal estates, which need to be rethought and reenacted as spatial domains with their own unique properties of accessibility/inaccessibility, boundedness/unboundedness, underdevelopment/overdevelopment, security/insecurity, publicity/privacy, openness/enclosure or commodification/collectivization for the cybersubjectivities now beginning to inhabit them in groupware, thoughtware, mediaware formations as digital beings.

(Luke, 1995)

Hyperreal, virtual spaces construct another area of informational power as Luke indicates. Functionally, they operate as real loci of power for users and creators, like any space does. It has the power of the territory and the power of flows that occur in it. Capillary power flows through these spaces as distributed interests are pursued, contesting the very structure and presentation of the information involved. These virtual territories are places of recruitment and enclosure (Latour, 1988, 1993; Callon, 1998). The imagination of the virtual learning environment is commonly an imagination of a virtual space, like a virtual library, a virtual classroom or a virtual lecture hall. It is the imagination of a simulation of a classroom, frequently lacking the other secondary systems supporting the existence of classrooms, and in that partial simulation it amplifies all of the structures of power that we can identify with classroom.

Is there anything more than simulation and power in these environments? There must be because they are informational, they possess the perpetually reconstructed artifactuality of the digital artifact, which can be created and manipulated in real time according to programmers or others wishes. This is part of informational power, the power of immediate control via infotechnics. In short, these virtual territories are spaces that are controlled by infotechnics that are built by programmers and designers. This array of infotechnics and communities establish a defensible territory, a community of knowledge and practice that provides the productive capacity for the future development of informational spaces.

This community is at the core of any notion of informational power because its members control the means of production and reflexively structure the mode of production. They are sub-political in that the decisions they make are directly political, but our outside of the public sphere. "Sub-politics, then, means shaping society from below. Viewed from above, this results in the loss of implementation power, the shrinkage and minimization of politics," (Beck, 1995, 23). The state, the social apparatus as a whole, becomes less powerful because the sub-political exists within it, and transforms it. The meta-politics involved in sub-politics is where the politics of the information age plays out. It is a politics without choice, determining what will be within or outside of political decision-making depending on many variables, but driven by economic concerns. Even though many state and institutional policies exist as official political apparatus, they do not change the institutions as a whole. Information producers and users are altering the rules of virtual learning environments and transforming the very environment in which they operate. They are providing an external system, a different set form of governance, with a different form of power, a sub-political power of transformation and depoliticization, that may be liberating for certain economic interests, but even if not liberating is encapsulating to the greater population because they are the ones that learn the values, norms, and rules built into the information systems.

### 3. INFORMATIONAL POWER AND THE PARALOGICS OF CONTROL

There is a question of governance and economy in the sense that people and machines control information and inversely, according to Norbert Wiener, information can control people and machines in a variety of ways (Wiener, 1965). Through the creation of informational goods, people create value, and then they have the choice of what to do with this valuable object, and when they make those choices, they are in fact governing the relationships surrounding this informational good. So we can think of informational power about the control or management of informational goods in a given territory. A political understanding of the contestation of informational power provides us with an understanding of the informational power as a power of control, a power of

territories, a power of flows, and a power of institutions and artifacts/objects. Informational power is thus a power of space, both real and virtual, where issues of who owns, who governs, and in the end, who controls information are contested.

This definition of information power helps us to understand what is at stake in the digital world. The technical assemblage of information surrounding learning in later modernity and the power and culture constituting it already are surrounded with monumental institutions for their production and distribution. One of those institutions is a school, which is usually part of a large system of nodes and networks governing the production and distribution of education. The materiality of education stored in schools, libraries and increasingly in virtual learning environments, clearly must contain valuable information if their management is so costly in comparison to their production.

Inherently the architecture surrounding informational artifacts varies significantly along several spectrums. The difference between the book as it sits on a student's desk and the book as it exists on someone's computer for future reading on their Personal Digital Assistant is the difference between the physicalized information and information in its digital form, letters and words versus bits and bytes. From physical artifact to digital artifact is one spectrum of analysis, but there are others. Value is another significant area of analysis. When virtual learning environments become points of translation, and points of negotiation, where they become partial subjects or actants, and thus possess power, they become valuable (Latour, 1993). In that they hold value, and come to embody values, they become political spaces and spaces of governance.

These quasi-objects need not be like any artifact that we currently know (Latour, 1993). Ted Nelson for instance frequently argues that in fact these informational artifacts should not be limited by physical form or the metaphor thereof, but should be as open as the human mind allows (Nelson, 1987). However, we are burdened by familiarity and tradition, though there are processes of detraditionalization certainly removing some of our boundaries, norms, and expectations over time, leaving us with new forms for digital artifacts which will have to some extent, new ways of expressing informational value (Lash, 2002; Luke, 1989). Nelson's *Computer Lib/Dream Machines* clearly realizes the concretization of traditions and tried to break the paradigmatic structures implicit in the page and book. But as we can learn from his efforts, fighting the behemoth of traditionalized capitalist institutions may not in the end bring you to the desired result.

It is clear that informational artifacts seemingly possess the qualities Nelson identified, it is also clear that most information systems are not built to handle empowered, fluxing, compound, actants, such as mutable hypertexts, wikis or related interactive digital media. Those are aberrations of the normal institutions and call for new institutions to be imagined. Because of their fluxing nature, and the number of people using them at any point in time, some digital objects can take on a life of their own and be very hard to control and archive.

Most archived media reproduces media in earlier forms, media that is fixed, and closed. The reasons for this are varied, but control and encapsulation of the artifacts should not be dismissed as one of the possible motivations.

These quasi-objects take on significance in our culture whether we want them to or not because they have value (Latour, 1993). With the social construction of value, we always have the social construction of means to control its value. Overtime we develop norms, laws, rights, and similar social technologies to manage these things and their affects. Copyrights, patents, Digital Rights Management, even computer operating systems are being built to control and manage what people do with information that they may have created, transformed, or otherwise interacted with to create value. Even when people want to make their materials publicly accessible, they might face impediments based on the systems of control, which are built into our socio-political economic system. These paralogics of control: the laws, norms, and instruments are part of informational power because it is centered on the access and use of information, the control of information, and the limitations put upon that by a variety of institutions.

Informational power then is not unlike any other power; it involves the creation of artifacts, their transmission, and their control. It involves subjects, their construction, and their control through norms, traditions, laws, and other means. Informational power then is a social power as much as it is technical. It is not just a power based in contestation, but it is a power of enculturation, transformation, and everything that implies. This is why informational power as the control of information, its distribution, and its access is a core issue in the informational capitalism.

#### 4. BUSINESS MODELS AS CULTURAL MODELS FOR VIRTUAL LEARNING

There is a tension widely described between normal, shared, cultural production and its capitalization. The tension exists between some content producers and content commodifiers (Lessig, 2001). The tension centers on the concept of ownership, and as such control of information. For our purposes, this is a question of provision, and in capitalist structures collection of payment, but provision is the central question. We have a problem because for a few hundred years there were commodities that were heavily imbued with value through their initial production, and then imbued with other values through their reproduction (Benjamin, 1985). The transformation from individual and guild craft production to industrial production changed the value structure of production. Likewise, when the costs of replication of the digital object become infinitesimally close to zero, commodity structures change, and this changes business and culture.

The normal, communal sharing of knowledge in science and education is somewhat contrary to the privatization accompanying commodification

(Merton, 1942). We can see the transformation of knowledge production and provision toward a commodification model in current events. Systems and forms of knowledge are rapidly changing, as knowledge becomes more business centered than science centered. With businesses such as Blackboard moving into teaching, Pearson's digital publishing providing digital only materials too classrooms, and the rise of for profit universities providing online content, the traditional forms of knowledge that science and human development requires are moving from the public to the private sphere. This extensive privatization and rapid transformation of education makes knowledge provision an increasingly costly service, one that states and nations are slowly vacating. Instead of knowledge provision being of a shared cost between colleagues, educational institutions, teachers, and students, it is a matter of massive contracts between capitalist institutions and occasionally other forms. This service model drives further privatization of public knowledge in a strange circularity, where the privatization of knowledge encourages the further privatization of knowledge, and packages of related knowledge are sold together. By packaging private knowledge with public knowledge, the ownership of the knowledge in the public domain becomes unclear, and if they are bundled in certain ways, such as in a database in the United States, the public knowledge then becomes private knowledge. This vicious circle is happening throughout the educational enterprise, and with the market ballooning to tens of billions of dollars in the next decade, it is hard to see where it might stop.

The institutional apparatus that allow this privatization and commodification of knowledge are manifest in our everyday life. They are justified in part by a claim that the production of a digital artifact within a proprietary system under license gives the proprietor some property rights toward the artifact, whether or not, it can be directly shown to be derived from their product or not. However, ownership of these tools is a key strategy for the informational world.

Productivity and competitiveness in information production are based on the generation of knowledge and information processing. Knowledge generation and technological are key tools for competing between firms, organizations of all kinds, and, ultimately countries.

(Castells, 2000: 124)

We have to be careful when, like Castells, we assign the outcomes of production and processing to the firm, organization, and country, because it need not be so. When we think about it this way though, we automatically put information, no matter what its intent, into the realm of profit and capital. This move imports significant ideological commitments about ownership and control that do not hold for all digital artifacts.

We have a choice between the open models of shared knowledge versus a closed model of owned, proprietary knowledge. However, it is not really a

binary opposition, but a spectrum of virtue and vice. Some knowledge will be owned and some will be shared. It will become an asset not just of individuals and corporations, but also of nations and part of national security and trade policy. We see this today already with certain computers being classified as weapons in the U.S. to prevent them from being used by certain nations to decode transmissions. These instruments of control are being used as weapons against loss of “intellectual property”. “This is an age in which ownership of ideas—copyright—can create international trade crises and lead publishing houses to fight the electronic revolution with all their might” (Chodorow, 2001: 5). The technologies developed to handle this will then determine the future of knowledge, if we design computers with implicit Digital Rights Management for music and movies, and people habituate themselves in their contexts, then those habits over time will likely territorialize other habits, practices, and assumptions in their everyday life.

In the end, as Lessig indicates in *The Future of Ideas*, we have choices. One choice we can make is to have a system of control that allows for all to define their own roles instead of having them being defined for us. The default choice seems to assume the current system of centralization of systems into corporations, and information provision in pursuit of economic incentives will rule the day. If we look virtual learning environments, it seems as if many of their chief promoters have made the choice similarly to Castells’ spirit of informationalism. They assume the rampant progress of informational capitalism, and frame the situation in that context instead of framing it in terms such as social or public goods.

Traditionally, models based on public goods are put forth as the motivation for education, such as sharing of knowledge, providing for the education of the public, or similar social goals. While there need not be tensions between the commercial interest and the public good, in this case the tension is clear, especially if the commercial interests impedes the public good as it might if the commercial spirit of informationalism holds forth. If our knowledge is embedded within payment structures that require our schools to submit to and in the end participate fully in the realm of privatized, commoditized knowledge, then what are we teaching about public goods, and how do we legitimize the functions of government in that respect? The crisis of legitimation surrounding public goods is clear. If learners do not participate in the public sphere in schools, where will they participate in it? As our educational institutions are detraditionalized from their roots in information and knowledge as public goods, toward the privatization of knowledge, the students are learning the values of privatization, corporations, and similar interests, which certainly have private, not public interests at their core.

The forms and values that educational institutions take force real understandings of the way they work and should world onto their users, from the student, to the instructor, to the woman off the street. “Users and Doers may become the same” (Castells, 2000: 31). The development of this multiplicity

and its transition into a fully fledged digital knowledge space will take on aspects of the traditional forms as much as they will become something new. However, the traditional role of educational institutions is more significant. Like early churches, educational institutions seed a territory with specific forms of knowledge and structures of control. It is a pastoral knowledge closely related to the pastoral power of feudalistic institutions. In libraries and universities, knowledge is housed not only in books, but in the buildings, structures, traditions, and people themselves. They combine as the institutions to provide a portal to the forms of knowledge that has become their role to provide such as books, newspapers, movies, and music, and in that are a place of power.

They are not merely local nodes in the network of information though. They are global networks and the nodes are global too, though they are local to some users. Chodorow states “Librarians and collections are now serving an increasingly global public and serving it globally” (Chodorow, 2001: 11). This is clearly true for libraries and educational institutions, but the global public that they serve should not be mistaken for a utopian universalization of access to education and information. In becoming networked enterprises, these institutions take the dispositions that information and its owner’s puts on access and use. They cannot give access to information without overcoming social, economic, and technological barriers embedded in information technology. This means that the traditional public institutions may no longer serve for the public at large, but will only serve in formational public, which implicitly has a different demographic than the universal public, much as the televisual public is a different demographic than newspaper reading publics (Baudrillard, 1983).

Different publics consume and thus require different information, and that perpetuates the differentiation of the public into individual consumers and the eventual collapse of the public sphere. In a recent issue of *Educause Review*, Cass Sunstein warns higher education of the problems of the individualized market in higher education (Sunstein, 2002). The argument, which parallels one in his book *Republic.com*, is that one of the aspects of learning in our current environment is the exposure to and tolerance of the ideas of others. He sees this tolerance and the trust of the good of plural views collapsing under the weight of individualized filters and the ignorance of others. This collapse of the public into not merely publics and counterpublics, but to a non-public is one of the risks of moving from the universal public with a unified public sphere. The death of the public sphere and the collapse of the social are not new theoretical constructs. They are historically issues involved with the growth of a legitimation crisis in late capitalism (Habermas, 1975). This legitimation crisis is tied intrinsically to educational institutions as public goods and the rise of the information society according to Lyotard (1984). Between Sunstein, Habermas, and Lyotard, there is reason to view that as the publics collapse and



are transformed, there are spaces of power where informational institutions are aiding in the devolvement of the universal public into the informational, filtered, individual consumer. This structural change transforms the cultural models of information that business models use and lessens the resistance toward the commoditization of public goods.

The idea that educational institutions will benefit from the new efficiencies of virtual learning is clear in the public rhetoric, but we have to wonder about how the system will end up and who will benefit from that and why. In fact, if we look at the transition to the informational mode of production that will be required, we quickly see there are other issues at stake. When we move from industrial production to informational production, the infrastructure required is different. No longer do you need factories, presses, and large institutions maintaining them. "The production of services and other informational commodities (legal contracts, product promotions, movie showings, scientific papers, etc.), however, can be conducted almost entirely on the Net through shareware packages or on-line services" (Luke, 1995). The one benefit of the fordist, factory-based production had was that it provided for a new arena for collectivity, for people to work together in a common goal, and learn to be effective in organizing themselves toward that goal, which then translates into political effects that sought new power for the workers and producers of these objects, both the creative class, technocrats, and the capitalists.

But the diverse interests of these competing classes and their technocratic constructs have implications for society much like fordism transformed and unified subjects into classes, post-fordism, and late capitalism, ruled by technocratic producers and systems breaks the collectivities and transforms the public sphere, which traditionally contains the learning environments as Beck indicates:

Technocracy ends with the alternatives which break open the technoeconomic process and polarize it. These alternatives become fundamental and detailed, professional and profitable, found careers, open markets and perhaps even global markets. They divide up the power bloc of the economy in this way and thereby make possible and enforce new conflicts and constellations between and inside the institutions, parties, interest groups and public spheres of all types, and as far and as soon as this occurs, the image of the indifferent self-referentiality of social system shatters.

(Beck, 1995: 48)

As the economy is divided and transformed by information, the new constellations of technocrats in institutions gain power, and subvert some of the institutions interests to their own, and with that the imagination, the norms, and traditions embodied in that institution loses the self-referential possibility

of identity and the collectivity and its politics fails. Likewise, with online education and distributed, online production, you no longer require the physical location, the factory or its functional equivalent, that produces this politicized collectivity.

In fact, informationalized production deterritorializes production, distributing power, and control across many individuals and institutions that do not seem to have the same political effect. This is paralleled in the decentralization of users, and their individualization in education that Sunstein describes as possible in virtual learning environments. Unlike most educational institutions, where you might meet, socialize, and coproduce knowledge and power, virtual learning environments like Blackboard have few communal facilities that allow the normal interaction of the anonymous and social public. They focus on the user and the service, this transforms the potentialities of production from communal and shared to one of limited potentialities where one person and one screen with their own digitized experience, individualized and customized to limit. With digital rights management regimes in place, these functions will be reterritorialized and recentralized, to be controlled by different interests.

It can be imagined to be otherwise of course.

In the fluid world of the electron, the body of scholarship in a field may become a continuous stream, the later work modifying the older, and all of it available to the reader in a single database or a series of linked databases. In such a world, scholarship would progress in a perennial electronic conference or bulletin board. Contributions and debates would occur on the internet and be continuous. The browser would become the catalog to the collection of knowledge.

(Chodorow, 2001: 7)

Chodorow envisions an information intensive interactive communal system, perhaps one like Wikipedia. However, wikipedia is a communal, open project and not a closed learning environment. It is an encyclopedia of sorts as claimed by its presentation at wikipedia.org (Wikipedia.org, 2004). But it is still distributed, and in some ways heavily contested instead of a collective domain. It is an encyclopedia of negotiated knowledge, not of universal agreement, and is still mediated through the internet, its controls, and interfaces. Similarly, the social constructivist, open source learning system developed at Curtin University of Technology called Moodle might be a point of resistance against the corporatization of education and the privatization of knowledge found in informational capitalism. However, both Moodle and Wikipedia are late arrivals to informational capitalism, and both are facing increasing problems with the capital requirements of information provision, such as funding of bandwidth, providing easy access, and openness in the face of the barrage of the normalized culture of commodification.

The processes involved in virtual learning are always involved in the creation and distribution of informational power, the control over information, in all its dimensions. The strategies and tools available to them are the ones that are built into the institutions in which they exist, such as ownership, rights management, software production, etc. These tools and strategies are being vested into knowledge spaces in a variety of ways, and are producing systems that have significantly different social effects than their predecessors and namesakes.

## CONCLUSIONS

Manuel Castells in *The Rise of the Network Society* argues that there is a spirit of informationalism that provides an ethical foundation of the network enterprise (Castells, 2000: 214). This parallels Weber's argument in *The Protestant Ethic and the Spirit of Capitalism*, in which the normative framework of Protestant Christianity is put forth as the core driving force and the ethical justification of capitalism and capital accumulation.

Inarguably, Castells is talking about a business network, but the education is in fact more and more becoming a form of networked enterprise, and more often than not is a business venture of itself in these the days of academic capitalism. "These business networks that form the new network enterprise are built on technological tools and attempt to compete globally and resist to some extent the idea of the state" (Castells, 2000: 212). They are very much transnational institutions or if not stand a high likelihood of becoming one. But they are the same sort of institutions we find in our everyday lives, the old forms, and the old powers, are inherent in the Castells network enterprises; they are not destroyed as much as they are recreated in the informational arena.

We should not forget that these transnational institutions are technologically enabled. This is what allows them to reach their audiences and investors equally well and convince them of their relative merit in comparison the wide array of competing services. This as Castells notes, is part of their historical development, they arose with these tools and moved into the informational arena by strategically implementing information services within their organizations. These arose in specific historical context though.

The informational, global, economy is organized around command and control centers able to coordinate, innovate, and manage the intertwined activities of networks of firms. Advanced services, including finance, insurance, real estate, consulting, legal services, advertising, design, marketing, public relations, security, information gathering, and management of information systems, but also R&D and scientific innovation, are at the core of economic processes, be it manufacturing, agriculture, energy, or services of different kinds. They can all be

reduced to knowledge generation and information flows. Thus, advanced telecommunication systems could make possible their scattered location around the globe.

(Castells, 2002: 410)

The context is the firm and the service sector business for Castells, that is the locus of the information network and control. However, as we have seen, it need not be so. The publicly funded school provides a counter example, a public good, that while like a firm was occasionally provided for by states, and non-business groups. As a category for reference and ground for traditional expectations, educational culture provides an alternative to the grounding of the spirit of informationalism, while always being immersed in its contexts.

Information systems are scattered in one context, the geographic, but concentrated in another, the informational. Relatedly informational power is concentrated where information combines with institutions, both new and old. This concentration is aided by the social development of new technologies strategically supporting the goals of the social groups that consume them. The combinations of possible institutions and information technology are nearly endless. It is clear that many groups strategically seek some goal in relation to informational power, either concentration or diffusion of it. Many things will happen, some people will win, and some people will lose. Will our world be like Stephenson's socially fragmented, informational dystopia, or will there be a revolution or a point of balance where we can balance the tendencies of informational capitalism with the provision of public goods such education and knowledge? Depending on what happens in the near future, either the spirit of informationalism will align with Castells' conception or not, and this has implications for the future of virtual learning environments.

#### REFERENCES

- Agre, P. E. (2003). Information and institutional change. In: Bishop, A. P., Van House, N. A., and Buttenfield, B. P. (Eds.) *Digital Library Use: Social Practices in Design and Evaluation*. Cambridge, Massachusetts: MIT Press, 219–240.
- Baudrillard, J. (1983). *In the Shadow of the Silent Majorities*. New York City, NY: Semiotext(e).
- Beck, U., Giddens, A., & Lash, S. (1995). *Reflexive Modernization: Politics, Tradition and Aesthetics in the Modern Social Order*. Stanford, California: Stanford University Press.
- Benjamin, W. (1985). *Illuminations*. New York: Schocken Book.
- Bishop, A. P., Van House, N. A., & Buttenfield, B. P. (Eds.) (2003). *Digital Library Use: Social Practices in Design and Evaluation*. Cambridge, Massachusetts: MIT Press.
- Burt, R. (1992). *Structural Holes*. Chicago: University of Chicago Press.
- Callon, M. (1998). *The Laws of the Markets* (Sociological Review Monograph). Blackwell Publishers. London.
- Carley, K., & Wendt, K. (1991). Electronic mail and scientific communication. *Knowledge* 12(4), 406–440.

- Castells, M. (2000). *The Rise of the Network Society*. London: Blackwell Publishers.
- Castells, M. (2002). *The Rise of the Network Society*. Blackwell Publishers, London.
- Chodorow, S. (2001). Scholarship, information, and libraries in the electronic age. In: Marcum, D. B. (Ed.) *Developments in Digital Libraries*. Westport Connecticut: Greenwood Press, 3–15.
- Consalvo, M., Baym, N., Hunsinger, J., Jensen, K. B., Logie, J., Murero, M., et al. (2004). *Internet Research Annual: Selected Papers from the Association of Internet Researchers Conferences 2000–2002 (Digital Formations, 19)*. New York: Peter Lang Publishing.
- Fleck, L. (1981). *Genesis and Development of a Scientific Fact*. Chicago: University of Chicago Press.
- Foucault, M. (1990). *The History of Sexuality: An Introduction*. Vintage. New York.
- Guattari, F. (2000). *The Three Ecologies*. London and New Brunswick, NJ: Athlone Press.
- Habermas, J. (1975). *Legitimation Crisis*. Beacon: Beacon Press.
- Harasim, L., Hiltz, S. R., Teles, L., & Turoff, M. (1995). *Learning Networks: A Field Guide to Teaching and Learning Online*. Cambridge, MA: MIT Press.
- Himanen, P. (2001). *The Hacker Ethic, and the Spirit of the Information Age*. New York: Random House.
- Kuhn, T. S. (1996). *The Structure of Scientific Revolutions*. Chicago: University of Chicago Press.
- Lakatos, I. (1980). *The Methodology of Scientific Research Programmes: Volume 1: Philosophical Papers (Philosophical Papers Volume I)*. Cambridge, U.K: Cambridge University Press.
- Lash, S. (2002). *Critique of Information*. London; Thousand Oaks, Calif.: SAGE.
- Latour, B. (1993). *We have Never been Modern*. Harvard University Press.
- Latour, B. (1998). *Science in Action: How to Follow Scientists and Engineers Through Society*. Harvard University Press, Cambridge.
- Lefebvre, H. (1991). *The Production of Space*. Oxford, UK: Blackwell.
- Lessig, L. (2001). *The Future of Ideas*. New York: Random House.
- Lessig, L. (2004). *Free Culture*. New York: Penguin Press.
- Lively, L. (1996). *Managing Information Overload*. New York: Amacon.
- Luke, T. W. (1989). *Screens of Power: Ideology, Domination, and Resistance in Informational Society*. Champaign, IL: University of Illinois Press.
- Luke, T. W. (1995). Simulated sovereignty, telematic territoriality: The political economy of cyberspace. (Ed.), *Second Theory, Culture and Society Conference "Culture and Identity: City, Nation, World."* Berlin: <http://www.cddc.vt.edu/tim/papers>
- Lyotard, J. F. O. (1984). *The Postmodern Condition : A Report on Knowledge*. Minneapolis: University of Minnesota Press.
- Mandel, E. (1978). *Late Capitalism*. London: Verso.
- Mckenzie, R. B. (2003). *Digital Economics*. Westport, Connecticut: Praeger.
- Merton, R. K. (1942). A note on science and democracy. *Journal of Legal and Political Sociology*, Vol. 1, 115–126.
- Mumford, L. (1963). *Technics and Civilization*. New York: Harvest/HBJ Book.
- Nazer, N. (2000). The emergence of a virtual research organization: How on invisible college becomes visible. Unpublished Ph.D. Thesis, Department of Sociology, University of Toronto.
- Nelson, T. H. (1987). *Computer Lib/Dream Machines*. Redmond Washington: Microsoft Press.
- Noble, D. F. (1999). *The Religion of Technology: The Divinity of Man and the Spirit of Invention*. New York: Penguin Books.
- Noble, D. F. (2001). *Digital Diploma Mills: The Automation of Higher Education*. New York: Monthly Review Press.

- O'Day, V. L., & Nardi, B. A. (2003). In: Bishop, A. P., Van House, N. A., & Battenfield, B. P. (Eds.) *Digital Library Use: Social Practices in Design and Evaluation*. Cambridge Massachusetts: MIT Press, 65–84.
- Okerson, A. B. (2001). Can we afford digital information? Libraries? An early assessment of economic prospects for digital publications. In: Marcum, D. B. (Ed.) *Developments in Digital Libraries*. Westport, Connecticut: Greenwood Press, 95–108.
- Sunstein, C. R. (2001). *Republic.com*. Princeton, NJ: Princeton University Press.
- Sunstein, C. R. (2002). MyUniversity.com? Personalized Education and Personalized News. *Educause Review*, September/October.
- Tuomi, I. (2003). *Networks of Innovation: Change and Meaning in the Age of the Internet*. Oxford, U.K.: Oxford University Press.
- Weber, M. (2001). *The Protestant Ethic and the Spirit of Capitalism (Routledge Classics)*. New York: Routledge.
- Wiener, N. (1954). *The Human Use of Human Beings: Cybernetics and Society (Da Capo Paperback)*. Houghton Mifflin, New York.
- Wiener, N. (1965). *Cybernetics, Second Edition: Or the Control and Communication in the Animal and the Machine*. Cambridge, M.A.: The MIT Press.
- Zuboff, S. (1989). *In the Age of the Smart Machine: The Future of Work and Power*. New York: Basic Books.

## Chapter 7: The Influence of ASCII<sup>1</sup> on the Construction of Internet-Based Knowledge

JASON NOLAN

*School of Early Childhood Education, Ryerson University*

### 1. PROGRAM OF INQUIRY

The intention of this chapter is to engage the deep structures of the hegemony of the digital technology revolution as represented by the internet, levels beneath those addressed by most of the contemporary critical discourses. I am not working with more obvious barriers that constitute the “digital divide” such as the relationship of access to safe drinking water and basic rights of women’s education to global attempts to bridge the digital divide (Nolan, 2000), the future of educational technology in North America (Nolan and Hogbin, 2001), or the potential for zero-cost computing and telephony technologies and indigenous language software environments. The goal is to extend the dialogue to a consideration of the locations of control over which disadvantaged groups of users of communication technologies have little or no control, and even less information or understanding. I am looking not at the content/information/data that is presented through the various media of the internet, but at the bias inherent in the medium itself (Jones, 2000).

The internet is first and foremost a learning environment in both formal and informal learning (Nolan and Weiss, 2002). It is one that presents itself as value neutral; a manifestation of McLuhan’s global village where bias and difference all meld into a stream of bits (McLuhan, 1995). There is a great deal of pedagogy and curriculum about the internet that both challenges and reinforces difference (Cummins and Sayers, 1995; Harasim et al., 1995; Haynes and Holmevik, 1998). But there is very little curriculum or curriculum theorizing that engages the software, code, discourse, and metanarrative of the internet itself, leaving current pedagogy to function in a sea of assumptions about what can be done and said and accomplished online. There is an “anti-intellectualism” similar to what Giroux describes as present in the classroom, or lack of interest in the sub-surface discourse of the code and software of the internet (Giroux, 1992: 116; Gray, 2001).

McLuhan’s *medium is the message* mantra is ever current as we are infected with the latest rash of technological developments. However, as educators and researchers confront the dominant and subversive ideologies presented online, very few are willing or aware of the need to critique the imposition of the

locations of power that have brought the internet into existence. There is a need for us all to be aware of the levels of implicit colonialization that accompanies the proliferation of internet-informed culture (Said, 1993). There are a variety of layers that must be unpacked and brought into the light of inquiry, “to know as much as possible about the house that technology built, about its secret passages and its trapdoors” (Franklin, 1992: 12). First and foremost is the foundation and genesis of the internet itself, located in the Cold War desire for a computer network designed to withstand nuclear war (Krol, 1992). Who made the internet? Who are its informal architects? What culture was this creation located in? Second, we have to look at the software that runs the internet, the servers that move information, and the software that extends its purview to our desktops at home and in our workspaces. Third, there is the post-1994 World Wide Web which opened this brave new world to both the general public and to the commercial influences that followed them (Berners-Lee, 1998). Fourth, we are faced with the internet representing technology and discourse as the informing metanarrative of the new global economy. Fifth, we need to envision strategies to help educators encounter difference in our pedagogy, practice, and inquiry. These will serve to point to locations, the potential avenues, for radical repositioning of the discourse at the nexus of the educator and her performative/transformational capacity as creator of learning environments (Nolan, 2001).

## 2. THE FOUNDATION AND GENESIS OF THE INTERNET

Most of us are aware of the genesis of the internet at the hands of the Advanced Projects Research Group, of the US Department of Defense which, in late 1960s founded research that led to the linking of computers at universities in the Western U.S. (Cailliau, 1995; Gray, 2001; Krol, 1992; Mitchell, 1998). This foundation has morphed into an ostensibly uncontrolled and uncontrollable global phenomenon that has exploded the opportunities for voice and communication around the world. It has gone down in Western history alongside Gutenberg and Caxton’s moveable type revolutions which propelled text out of the Medieval modes of production and privilege (McLuhan, 1995). And just as the print revolution was about the technology of the printing press, the internet is as much about the software code and Internet Protocols (originally TCP/IP, Telnet, SMTP, FTP, and recently HTTP) that bring the internet into existence as it is about what we do on it. Those who controlled the printing presses still controlled what could be and was said. Someone needed to control a printing press in order to have voice; as time went on more people had access, and differing voices could make themselves heard. Of course, concomitant with this means of production, one needed to have access to networks of distribution, a limitation that still restricts the diversity of voices that are heard both in media-rich and media-poor cultures/languages. Today,



access to public consciousness via the medium of print is seen as widespread, but in many situations individuals and groups are still voiceless (OECD, 2000).

The internet stands now as a force within our collective worlds. But control is still located in corporate and government institutions. In 1992, the U.S. government released the rules governing acceptable use of internet resources, opening the internet up to business, and since then corporations have taken over much of the internet (Cerny, 2000; Hochheiser and Ric, 1998). Individuals must purchase or rent time on expensive machines made by an ever-shrinking number of multinational corporations. Organizations such as the various Freenets (Scott, 2001), FIDOnet (Vest, 2001) and the Free Software Foundation (Stallman, 1999) are still challenging the hegemony of institutional and corporate interests, but their influence is small and localized.

### 3. TECHNOLOGIES OF RESISTANCE

The internet is not the free-for-all anarchic space that business, the media, Libertarians, and cyborgs would have us believe (Gray, 2001). Though chaotic and anarchic activities do exist, and these are very important locations of resistance, every act of resistance or conformity occurs under the graces of the protocols of the internet. These protocols are governed by various institutions, governments, and administrative agreements. The most fundamental of these is the TCP/IP protocol, invented by Vinton Cerf and Bob Kahn. Almost all internet traffic must conform to the TCP/IP protocol or it is rejected by the servers that pass information from computer to computer. How that information is encoded is governed by standards developed and maintained by various groups such as WC3 (World Wide Web Consortium), ICANN (Internet Corporation for Assigned Names and Numbers), IEEE (Institute for Electrical and Electronic Engineers), and JPEG (Joint Photographic Experts Group) (Champeon, 2001). These regulatory bodies, organizations, and protocol standards control what can and is done on the internet. Many of these groups are transnational, but they contain a very narrow selection of interests that are contiguous with the goals of the West.

There is no question that the software and hardware we use is primarily informed by multinational corporations; Microsoft, Sun Microsystems, Intel, Google, AOL Time Warner, Apple Computer, IBM, Yahoo, Hewlett-Packard, Sony, etc., along with their support companies and organizations, control at the most basic level how we communicate online. Their software is not value-neutral. It is culturally and linguistically embedded in a technologically positivist metanarrative that sees the technology itself, and those who create it and use it, at the apogee of human cultural experience (Lyotard, 1984). This predisposition is encoded in the software itself.

There are a number technologies and movements that challenge the consumerist/corporatist profit driven models of the internet, positing a somewhat prosumerist<sup>2</sup> model; “As prosumers we have a new set of responsibilities, to educate ourselves. We are no longer a passive market upon which industry dumps consumer goods but a part of the process, pulling toward us the information and services that we design from our own imagination” (Finely, 2000). The open source movement is the key idea that brings otherwise competing interests together; it is one of the most important in computing in the late 1990s, and will probably be one of the dominant forces into the next century (Scoville, 1998; Raymond, 1998; O’Reilly & Associates, 2000). Open Source Initiative and the GNU Project are two organizations influenced by specific individuals; GNU by Richard Stallman, and Open Source by Eric Raymond (Scoville, 1998). In general terms, they both want to promote software that is free, freely available, and open to the Hacker community. These projects both support the traditional notion of sharing resources among members of a community.

The Free Software Foundation is clearly immersed in the Hacker philosophy that information wants to be free. The Free Software Foundation’s GNU General Public License (GPL) was first brought forth in 1991: “The licenses for most software are designed to take away your freedom to share and change it. By contrast, the GNU General Public License is intended to guarantee your freedom to share and change free software—to make sure the software is free for all its users” (Stallman, 1999).

The Linux operating system builds on this open source philosophy. It is both a software and a conceptual revolution that has changed computing in a way that we cannot have imagined. Because of its success, it is also an important pedagogical signpost, showing an alternative direction from the commercialization of online exploration of learning. “Linux is a free Unix-type operating system originally created by Linus Torvalds with the assistance of developers around the world. Developed under the GNU General Public License, the source code for Linux is freely available to everyone” (Online 1994–2000). As such, it represents a movement that critical education can follow, through vehicles such as the GNU, to allow individuals and organizations to maintain ownership, while freely sharing of their work with a larger community.

The rise in importance of Linux ([www.linux.org](http://www.linux.org)) is predicated on the fact that it is an open source operating system. The dynamic potential of the CVEs (Collaborative Virtual Environments) I work with is fundamentally due to their open source existence. This means that the raw source code of the system is publicly available under a license that allows anyone to use it and modify it for their own purposes under relatively flexible conditions as laid out in the license (Nolan, 2001; Nolan and Weiss, 2002). The result is that thousands of users are motivated not only to modify and add to open source software for

their own purposes, but also to share what they have created with the entire community. The strength comes from the openness of the system and the community that surrounds it.

#### 4. CULTURAL PRODUCTION

These initiatives do not challenge the Western bias outlined in this chapter. They do, however, challenge the multinational corporations' ability to control what software we use, and how software can be modified. Open source initiatives offer individuals and groups interested in social justice not only valuable allies who are often underutilized, but most importantly a model of resistance that seeks to transform debates and relocalize them within social, as opposed to corporate, purviews.

Hackers are the first community of the internet. Many of the original members are the programmers who hacked the internet together in the first place. They were the first to subvert the dominant discourse of the internet to human, communicative, social ends (Ruffin, 2001; Sterling, 1993). Hackers are not the malicious Crackers and virus programmers that strike fear into corporations and are vilified in the popular media (e-cyclopedia, 1999; Raymond, 2000; Stoll, 1989). They are not destroyers, but travelers, seekers, and creators of alternatives and solutions to barriers to accessing knowledge and information. Their mantra is that information wants to be free (Gray, 2001). They are also predominately ultra-privileged young educated heteronormative white males, but they are philosophically opposed to the hegemony of corporate and governmental interests. I work with queer Hackers, cyborgwomen, and cybergirls, and the work of Stone on the transgendered body (Stone, 1992), and Harraway's cyborg (Harraway, see chapter 4), and Hayles post-human (Harraway, see chapter 4; Hayles, 1999) collectively reveal how the interfacing of women and technology are relocalizing the discourse of hacking in gendered spaces. As the technologies and influence of technology on the body are engaged by women, they are staking territory in the realm of the Hacker. The roots of the community, however, are located in this opposition to institutions that want to control information and access to resources.

There are social learning environments, collectively called Collaborative Virtual Environments (CVEs) such as MOOs, where individuals and groups construct/program/hack out virtual spaces and communities (Cicognani, 1998; Fanderclai, 1995; Rheingold, 1993; Schank et al., 1999; Turkle, 1995). I have been involved in CVEs since the late 1980s, and developed two MOOs. MOO is an acronym for Object Oriented MUD, itself an acronym often unpacked as Multi-User Domain/Dungeon/Discourse (Curtis, 1992; Curtis and Nichols, 1993). My MOOs are virtual places where participants from as far away as Taiwan, Iceland, Brazil, and Russia "create

representations of people, places and things and share them with others” (Nolan, 2001). The key to these constructionist, polysynchronous<sup>3</sup> (integrated synchronous and asynchronous communication) spaces is that people not only communicate online in a multimedia, open source software environment, but that they can collaboratively create and program these spaces according to whatever criteria they choose to conceptualize and describe (Davie et al., 1998; Davie and Nolan, 1999). Though MOOs still suffer from their English-only roots, we can and have worked simultaneously in English, Chinese, Japanese, Russian, Icelandic, and we are conceiving a MOO dedicated to polylingual communication. A polylingual space, versus multilingual, suggests that not only can many languages be accommodated, but that no one language reigns supreme; that multiple, intersecting language events and spaces can be created, and participants can work within the language(s) of their choice without being mediated by an overall dominant language.

#### 5. THE INTERNET IS WRITTEN IN ENGLISH

The internet infrastructure, corporations, and technologies/groups that challenge them are primarily English/male/Western dominated discourses. All strands are Western in voice. More importantly, software is written in programming languages such as C, C++, ObjectC, Java, and/or scripting/markup languages like Perl, PHP, HTML, XML. Though it is possible to use these languages to express written languages other than English through various encodings, these languages were created by speakers of English to be used by English speakers. You cannot participate in the creation of software without *using* English in the programming, scripting, or markup of content, without participating in the hegemony of English, even if you do not have the ability to speak or write English.

What does this mean in terms of education and technology? Simply put, it means that it is practically impossible to participate in the world of technology without privileging English. The internet is written in English. A programmer who wants to write a word processor for Icelandic writes the word processor in English using a language like Java or C++. The software is installed into, say, a Windows, Linux or Apple operating system that has been *localized* into Icelandic. And files created still require, in most instances, a .doc .txt .html suffix; all derived from English. These *localized* versions are localized as an afterthought. The major operating systems, and the various software packages, are most all written for English consumers first, tested and made available to English consumers, and then *ported* to other languages, *if* the software company feels that it is profitable to do so. In 1997, Microsoft was pressured into porting one of their versions of windows to Icelandic by the

Icelandic government, highlighting the fragility of languages in the face of English and corporate interests (Ford, 2001).

Though many operating systems, such as Macintosh's OSX and Linux, now are sufficiently international to ship with multi-language package options, and has localized versions for a few major language markets, there is very little available that is not Anglo-centric. The hegemonic influence of English in the computer languages running the internet, however, means that concerted effort by educators of difference who are willing to work towards the creation of alternative language spaces is required.

The 26 letters of the English alphabet form the basis of how most content moves across the internet, encoded as ASCII (American Standard Code for Information Interchange) text. The internet functions primarily using the 94 printable characters that make up the ASCII character set:

```
abcdefghijklmnopqrstuvwxyz  
ABCDEFGHIJKLMNOPQRSTUVWXYZ  
0123456789  
!"#$%&'()*+,-./:;<=?@[\\]^_`{|}~ (Lunde, 1993: 36)
```

And when Japanese is displayed on your computer, the characters look and act like Japanese, but the encoding method still involves ASCII characters in the background.

かな漢字  
82A9 82C8 8ABF 8E9A

In this example the two groups of characters, *ka na* and *kan ji*<sup>4</sup>, are presented with ASCII characters shown below.<sup>5</sup> These *characters* which represent words that describe the two main writing scripts in Japanese (*ka na* and *kan ji*) are each represented by four hexadecimal digits; digits which are part of the ASCII character set.<sup>6</sup> That is, the Japanese language is represented by characters that make up the American Standard Code for Information Interchange. And Japanese is often encoded using methods that represent data based on ASCII in order to be to be communicated to another computer, even within Japan.

When you write a program, script, or electronic document, it must be written using an English-based programming language, such as Java, C, Perl, HTML. This following example from MOOca.java describes connecting to our MOO and setting the parameters for encoding non-English characters:

```
outputWriter = new OutputStreamWriter(mSocket.getOutputStream(),  
mRequestedEncoding);  
s = new StringBuffer(0, byteCount, getEncoding());
```

Where `mRequestedEncoding` is taken from the applet parameters and is a string such as “SJIS” “ASCII” “UTF8” [Unicode] which tells Moooca how it should encode the characters to send it to the Moo. Where `getEncoding()` usually is the same as `mRequestedEncoding` above. The only time it would be different is if someone tried to ask for an encoding that didn’t exist, such as “japlish”, in which case it would fall back to the user’s default encoding (Nolan and Goulden, 1996–2001).

(Goulden, 2001)

It is possible to see this form of encoding as unproblematic. A minor price to pay for global communication, but the hegemony of English is even more profound: “*Does the interiorization of media such as letters alter the ratio among our sense and change mental processes?*” (McLuhan, 1995: 119). When you send an e-mail message, regardless of the language in which you compose your text, your e-mail program must talk to a server. A message is sent to a server on port 25 and the first message it says is “HELO”, an abbreviation of “hello”, in order to initiate a process that gets your e-mail moving on its way (commands sent to initiate communication are in **bold**):

**telnet achieve.utoronto.ca 25**

Trying 128.100.163.xxx... Connected to achieve.utoronto.ca.

Escape character is '^]'. 220 achieve.utoronto.ca ESMTP Sendmail 8.9.3/8.9.3; Tue, 6 Nov 2002 14:36:15 -0500

**helo achieve.utoronto.ca 25**

achieve..utoronto.ca Hello envvirtual.utoronto.ca [128.100.163.xxx], pleased to meet you

This means that every e-mail ever sent on the internet by anyone in any language to any country, is couched in, or bracketed by, English. Communication is initiated in English and concluded in English. As Steiner notes: “So far as language is the mirror or counter statement to the world, or most probably an interpretation of the reflective with the creative along an ‘interface’ of which we have no formal model, it changes as rapidly and in as many ways as human experience itself” (Steiner, 1998: 468). Steiner’s ideas suggest that what we can do and think with technology is forever informed by a language that, though in flux itself, forces the expression of human experience to conform to the influence of a single language and perhaps the metanarrative of those who thus situated it. The phenomenon that is the internet has come upon the human species fast and unanticipated. Educators are playing catch up in their critical awareness of the foundations of the internet, with the result that aspects of this revolution that should be challenged and problematized have slipped by, perhaps unnoticed.

## 6. THE EDUCATOR AS A CREATOR OF LEARNING ENVIRONMENTS

I am writing this chapter in English, as it is the only language to which I can claim fluency, but I choose to code this chapter in raw html, the hidden background scripting language that forms the background of most web pages. What I have written looks to me like this:

```
</blockquote>
<p><b>The educator as a Creator of Learning Environments</b></p>
<blockquote>
<p>
I am writing this . . .
```

I am also writing using programs such PICO and BBEditLite, free word processors. These choices remove, even if just temporarily, a level of commercial influence over the production of text, and a level of isolation from what goes on behind the location of the presentation of text. In order to participate in the publication of this book, however, I will have to convert my text into Microsoft's Word program. These vaguely symbolic acts do highlight how an educator can position herself within alternatives to corporatist agendas, and model a practice that can be both emulated by students and stimulate awareness and inquiry into alternatives.

These are, however, the most superficial locations of resistance, and an entire volume such as this would be required to engage the possible examples and experiences of CVEs, MOOs, Cyborgs, and Hackers (Gray, 2001; Stone, 1992). Technology and computer literacy as it is taught rarely takes even this stance. Review any curriculum, and you will see that it is largely infused with corporate technologies and corporate interests. The goal of technology-based curriculum is that of teaching users to be consumers of products in the name of global competitiveness and efficiency. Often the technologies are no more than computer assisted learning and evaluation tools. Teaching is limited to what is proscribed in the manual. Rarely do even the most pedagogically aware educators, informed by critical pedagogy and aware of the need to promote alternative voices, critique the technologies in which the voices are located. And if/when they are aware, they lack the time or resources to really explore the options that are hidden away by security-conscious systems administrators (Nolan, 2001). Today most decisions as to what technologies are used in learning environments are made by technology specialists and administrators, and are given to educators with little or no consultation. There is even less awareness on the part of the educators and students that alternatives exist.

This is an untenable position. If valid and sustained strides are to be made to embed alternative choices in the global culture, they must be found within the technologies we use. These technological alternatives are something that cannot be done for us either. They must be done by us in community with our

peers and students. To control the conceptualization, creation, development, implementation, co-habitation, and governance of these spaces we must learn to code, program, create our own software and environments that reflect our diverse needs and goals, and we must share them freely with others; allowing others to revise and relocalize what we share according to their own criteria and needs. For if we do not actively participate in the creation of our discursive spaces, they are created by someone else, and we are at the most disempowered end of the power relationship (Foucault, 1991; Illich, 1970). If we do not govern our own spaces, teaching and learning is open to commodification, and we are no longer creators, but consumers.

As a first step, transforming ourselves from consumers into prosumers where we are involved in communities of discourses, technologies, and narratives that we co-create and inhabit, allows us to share and interact with our stories. The much vaunted virtual community becomes a potential reality when we are able to (re)construct and embrace both collective and infinitely differentiating representations of ourselves, as we see ourselves, and reflect upon how we see others and are seen by them (Fernback and Thompson, 1995; Rheingold, 1993). The potential dialogues are, however, only realizable when we control the means of our own representation. The situation is hazardous simulation when dialogues are mediated by technologies over which we have minimal understanding and scant influence (Baudrillard, 1988; Fernback & Thompson, 1995; Stone, 1992).

The influence of the internet on diverse languages and cultures, those represented and under-represented by technology, is an act of relocalization of culture(s) from the real to the virtual. Cultural topologies are (re)constructed, and cultural experience must find new strategies of expression and resistance to survive and thrive (Ostrom, 1990; Rheingold, 1993). But more importantly, this relocalization is an act of translation of cultural experience (Steiner, 1998). And without the concerted effort of educators informed by the ideas of the pedagogies of difference—educators who are able to engage and dialogue with the Englishness of the internet below the surface level of written texts, down to the level of the code and encodings that make the internet happen—we are situating struggles within colonializing dialogues, aware of whose hands we are playing into, but unaware of how deeply the cards are stacked against us (Giroux, 1992). Where Steiner hypothesizes that “the proliferation of mutually incomprehensible tongues stems from an absolutely fundamental impulse in language itself [and] that the communication of information, of ostensive and verifiable ‘facts’, constitutes only one part, and perhaps a secondary part, of human discourse” I think that we are not only engaged in a struggle to liberate internet discourses from the hegemony of English, but are engaged in a struggle fundamental to the defense of all aspects of difference (Steiner, 1998: 497). Little can be done to exorcise English as the fundamental language informing internet communication, but it is important that educators struggle to demarginalize communities of difference to extend their program



of inquiry and resistance to an engagement of how language and cultural influences inherent in the structure of the internet translate/encode discourse and experience within a dominant cultural ideology.

#### ENDNOTES

1. ASCII stands for American Standard Code for Information Exchange, and is the encoding method by which most text-based information moves around the internet.
2. Prosumer, in general, is an individual who partakes in both production and consumption.
3. Polysynchronous is a term coined to describe the nature of MOOs where communication is an embedded combination of both synchronous and asynchronous communication (Davie and Nolan, 1999; Nolan, 1998). An IRC chat group is completely synchronous. Users communicate in real time, and there is usually no record kept of the communication unless one member personally creates a transcript of the interaction as a log. Asynchronous communication refers to the what happens on bulletin boards and via e-mail where a message is composed and transmitted to another individual or group. In a MOO, communication can be synchronous or asynchronous, but it can also be a combination of both. A conversation can be encoded into an object for others to read. MOO objects can be programmed to listen to conversations between members and generate responses that become part of the MOO-space itself for other participants to listen to later. As well, a conversational interaction may take the form of direct synchronous speech *and* the co-manipulation of MOO objects. It is possible to talk with another person, hand her virtual objects for her to look at, co-program MOO objects, and record the conversation for a third party to read later. This type of polysynchrony is particular to MOO-type environments, but reflects the direction that collaborative virtual environments are anticipated to follow in the future (Nolan, 2001).
4. The *ka na* and *kan ji* characters and their encodings have been created by Ken Lunde for this publication.
5. For more information on Japanese language and computers, please see Jun'ichiro Kida's web site "Japanese in the Age of Technology" (<http://www.honco.net/japanese/>). Of particular relevance to this paper is the section "Inputting Text with Two-Byte Characters" (<http://www.honco.net/japanese/05/page4.html>).
6. Dave Goulden (2003) notes that Japanese characters are more properly identified as having been encoded into hexadecimal digits, rather than ASCII characters. Hexadecimal is a base-16 numbering system used by programmers for, among other things, representing binary data. The hexadecimal character set (1, 2, 3, 4, 5, 6, 7, 8, 9, 0, A, B, C, D, E, F) can, for the purposes of this discussion, be characterized as a subset of ASCII.

## REFERENCES

- Baudrillard, J. (1988). Simulacra and simulations. In: Poster, M. (Ed.) *Selected Writings*. Stanford: Stanford University Press.
- Berners-Lee, T. (1998). *Tim Berners-Lee: A Short History of Web Development*. [HTML] [cited August 2, 2001]. Available from <http://www.w3.org/People/Berners-Lee/ShortHistory>.
- Cailliau, R. (1995). *A Little History of the World Wide Web* [HTML]. W3C, 03 October 1995 [cited August 4, 1999]. Available from <http://www.w3.org/History.html>.
- Cerny, J. (2000). *Who Runs the Internet?* [HTML] [cited November 1, 2001]. Available from <http://www.unh.edu/Internet/web/whoruns.html>.
- Champeon, S. (2001). *RTFM: A Guide to Online Research* [HTML]. Wired Digital Inc. n.d. [cited 2001 November 1]. Available from [http://hotwired.lycos.com/webmonkey/templates/print\\_template.html?meta=/webmonkey/00/08/index2a\\_meta.html](http://hotwired.lycos.com/webmonkey/templates/print_template.html?meta=/webmonkey/00/08/index2a_meta.html).
- Cicognani, A. (1998). On the linguistic nature of cyberspace and virtual communities. *Virtual Reality* 3, 16–24.
- Cummins, J., & Sayers, D. (1995). *Brave New Schools: Challenging Cultural Illiteracy through Global Learning Networks*. Toronto: O.I.S.E. Press.
- Curtis, P., & Nichols, D. (1993). MUDs grow up: social virtual reality in the real world. Paper Read at Third International Conference on Cyberspace, at Austin, TX.
- Curtis, P. (1992). Mudding: social phenomena in text-based virtual realities. *Intertrek* 3(3), 26–34.
- Davie, L., Abeygunawardena, H., Davidson, K., & Nolan, J. (1998). Universities, communities, and building sites: an exploration of three online systems. Paper read at Educational Computing Organization of Ontario, at Toronto, ON.
- Davie, L., & Nolan, J. (1999). Doing learning: building constructionist skills for educators, or, theatre of metaphor: skills constructing for building educators. Paper Read at TCC, at Maui, Hawaii.
- e-cyclopediia. (1999). *BBC News | e-cyclopediia | Cracking: Hackers turn nasty* [HTML]. e-cyclopediia@bbc.co.uk, Tuesday, August 31, 1999, [cited April 19, 2000]. Available from [http://news.bbc.co.uk/hi/english/special\\_report/1999/02/99/e-cyclopediia/newsid\\_434000/434498.stm](http://news.bbc.co.uk/hi/english/special_report/1999/02/99/e-cyclopediia/newsid_434000/434498.stm).
- Fanderclai, T. L. (1995). MUDs in education: new environments, new pedagogies. *Computer-Mediated Communication* 2(1), 8.
- Fernback, J., & Thompson, B. (1995). *Virtual Communities: Abort, Retry, Failure?* [HTML] [cited August 16, 1999]. Available from <http://www.well.com/user/hlr/texts/VCCivil.html>.
- Finely, M. (2000). *Alvin Toffler and the Third Wave*. [HTML] [cited April 18, 2000]. Available from <http://www.mastersforum.com/toffler/toffler.htm>.
- Ford, P. (2001). *Need Software in, Say, Icelandic? Call the Irish*. [HTML]. Christian Science Monitor, February 6, 2001 [cited October 15, 2001]. Available from <http://www.csmonitor.com/durable/2001/02/06/fp1s3-csm.shtml>.
- Foucault, M. (1991). Governmentality. In: Burchell, G., Gordon, C. and Miller, P. (Eds.) *The Foucault Effect: Studies in Governmental Rationality*. Hertfordshire: Harvester Wheatsheaf.
- Franklin, U. (1992). *The Real World of Technology*. Toronto: Anansi.
- Giroux, H. A. (1992). *Border Crossings: Cultural Workers and the Politics of Education*. New York: Routledge.
- Goulden, D. (2001). Raw MOOca. Toronto, November 7, 2001.
- Goulden, D. (2003). Email Communication. June 6, 2003.
- Gray, C. H. (2001). *Cyborg Citizen: Politics in the Posthuman Age*. New York: Routledge.
- Harasim, L., Roxanne Hiltz, S., Teles, L., & Turoff, M. (1995). *Learning Networks: A Field Guide to Teaching and Learning Online*. Cambridge, MA: MIT Press.

- Harraway, D. (2000). A cyborg manifesto: science, technology and socialist-feminism in the late twentieth century. In: Bell, D. and Kennedy, B. (Eds.) *The Cybercultures Reader*. London: Routledge.
- Haynes, C., & Holmevik, J. R. (1998). *Highwired: On the Design, Use and Theory of Educational MOOs*. Ann Arbor: Michigan.
- Hayles, K. (1999). *How We Became Posthuman: Virtual Bodies in Cybernetics, Literature, and Informatics*. Chicago: Chicago.
- Hochheiser, H., & Ric, R. (1998). *Who Runs the Internet?* [HTML]. Computer Professionals for Social Responsibility, May 3, 1998 [cited November 1, 2001]. Available from <http://www.cpsr.org/onenet/whoruns.html>.
- Illich, I. (1970). *Deschooling Society*. New York: Harper & Row.
- Jones, S. (2000). The bias of the web. In: Herman, A. and Swiss, T. (Eds.) *The World Wide Web and Contemporary Cultural Theory*. New York: Routledge.
- Kida, J. (2003). *Japanese in the Age of Technology* [Cited June 19, 2003]. Available at <http://www.honco.net/japanese/>.
- Krol, E. (1992). *The Whole Internet User's Guide and Catalog*. Sebastapol: O'Reilly.
- Lunde, K. (1993). *Understanding Japanese Information Processing*. Sebastapol: O'Reilly.
- Lyotard, J. F. (1984). *The Postmodern Condition: A Report on Knowledge, Theory and History of Literature*, Vol. 10. Manchester: Manchester University Press.
- McLuhan, M. (1995). The gutenbergalaxy. In: McLuhan, E. and Zingrone, F. (Eds.) *Essential McLuhan*. Toronto: Anansi.
- Mitchell, W. (1998). *City of Bits: Space, Place and the Infobahn*. Cambridge, Mass: MIT Press.
- Nolan, J. (2001). The techneducator effect: colliding technology and education in the conceptualization of virtual learning environments. PhD Dissertation, Curriculum Teaching and Learning, Ontario Institute for Studies in Education, University of Toronto, Toronto. Available from <http://jasonnolan.net/papers/dissertation.pdf>.
- Nolan, J. (2000). Unpacking transnational policy: learning to bridge the digital divide. *Educational Technology and Society* 1(1).
- Nolan, J., & Goulden, D. (1996–2001). *MOOca.java* (3.0) [Java Applet]. Project Achieve 1996–2001 [cited April 18, 2000]. Available from <http://www.zanid.com/mooca/>.
- Nolan, J., & Hogbin, E. J. (2001). *Internet Literate: The A report on Future Trends for Online Learning Environments in North America*. Toronto: Vivendi.
- Nolan, J., & Weiss, J. (2002). Learning cyberspace: an educational view of virtual community. In: Renninger, K. A. and Shumar, W. (Eds.) *Building Virtual Communities: Learning and Change in Cyberspace*. Cambridge: Cambridge.
- O'Reilly & Associates, Inc. (2000). *Welcome to the O'Reilly Open Source Center* [HTML]. O'Reilly & Associates, Inc., [cited April 18, 2000]. Available from <http://opensource.oreilly.com/>.
- OECD. (2000). *Learning to Bridge the Digital Divide, Schooling for Tomorrow*. Paris: OECD Publications.
- Online, L. (1994–2000). *The Linux Home Page at Linux Online*. Linux Online Inc. [cited April 18, 2000]. Available from <http://www.linux.org/>.
- Ostrom, E. (1990). Governing the commons: the evolution of institutions for collective action. In: North, J. A. D. (Ed.) *The Political Economy of Institutions and Decisions*. Cambridge: Cambridge.
- Raymond, E. S. (1998). *Open Source: Software Gets Honest* [HTML] [cited April 18, 2000]. Available from <http://www.opensource.org/>.
- Raymond, E. S. (2000). *How to Become a Hacker* [HTML], March 24, 2000 [cited April 18, 2000]. Available from <http://www.tuxedo.org/~esr/faqs/hacker-howto.html>.
- Rheingold, H. (1993). *The Virtual Community*. New York: Harper.

- Ruffin, O. (2001). *The Hacktivism FAQ v1.0* [HTML]. cDc communications 2001 [cited October 20, 2001]. Available from [http://www.cultdeadcow.com/cDc\\_files/HacktivismFAQ.html](http://www.cultdeadcow.com/cDc_files/HacktivismFAQ.html).
- Said, E. (1993). *Culture and Imperialism*. New York: Vintage.
- Schank, P., Fenton, J., Schlager, M., & Fusco, J. (1999). *From MOO to MEOW: Domesticating Technology for Online Communities* [HTML]. SRI International, Center for Technology in Learning [cited April 7, 2000]. Available from <http://kn.cilt.org/cscl99/A64/A64.HTM>.
- Scott, P. (2001). *Free-Nets and Community Networks* [HTML]. Lights.com, [cited October 15, 2001]. Available from <http://www.lights.com/freenet/>.
- Scoville, T. (1999). *Whence the Source: Untangling the Open Source/Free Software Debate* [On-line]. O'Reilly & Associates, Inc., [cited April 18, 2000]. Available from [http://opensource.oreilly.com/news/scoville\\_0399.html](http://opensource.oreilly.com/news/scoville_0399.html).
- Stallman, R. (1999). *GNU's Not Unix!—the GNU Project and the Free Software Foundation (FSF)* [HTML]. Free Software Foundation, Inc., [cited April 18, 2000]. Available from <http://www.fsf.org/>.
- Steiner, G. (1998). *After Babel: Aspects of Language and Translation*. 3rd (Ed.) New York: Oxford University Press (Original edition) 1975.
- Sterling, B. (1993). *The Hacker Crackdown: Law and Disorder on the Electronic Frontier*. New York: Bantam.
- Stoll, C. (1989). *The Cuckoo's Egg: Tracking a Spy through the Maze of Computer Espionage*. New York: Pocket books.
- Stone, A. R. (1992). Will the real body please stand up?: boundary stories about virtual cultures. In: Benedikt, M. (Ed.) *Cyberspace: First Steps*. Cambridge, MA: MIT Press.
- Turkle, S. (1995). *Life on the Screen*. New York: Shuster.
- Vest, F. (2001). *FidoNews—The FidoNet Dialup BBS Community Weekly Newsletter* [HTML]. FidoNews Editor, October 15, 2001 [cited October 15, 2001]. Available from <http://www.fidonews.org/>.

## Chapter 8: Interaction, Collusion, and the Human–Machine Interface

MIZUKO ITO

*University of Southern California*

In contrast with instructional media such as videos and books, the computer has held out the promise of instruction that is learner-centered and engaged, with the machine providing immediate and situationally responsive feedback. The early 1980s saw interaction with computers expand from drill-and-practice into action video gaming as well as the instructional adventure and simulation formats that we now associate with commercial edutainment. By the 1990s, multimedia had become a new buzzword in educational media, promising to rival popular culture with its fast-paced and attention-grabbing graphics and sound. These interactive qualities and multiple forms of media representation have given birth to interactive entertainment and instructional media that have proven to capture the attentions of children. At the same time, these media forms have introduced new complexities in media design and our understandings of learning with computers. Interactive media not only rely on a layering of technical, narrative, and interactive qualities that expand opportunities for engagement with media, but also make these engagements difficult to predict and determine. This indeterminacy provides unique challenges for those seeking to create and analyze learning with computers. Drawing from a more extended study of the production and consumption of children's software (Ito, 1998; 2003), this chapter works to fill in one piece of this puzzle, by analyzing some of the basic interactional dynamics between a child and educational software.

The interaction between a child and a piece of computer code differs in important ways from interpersonal interaction and interaction with other forms of media. Not only must analytic attention be trained to the particular rhythms of human–computer interaction, but also research must pay attention to the design and symbolic content of the computer's "voice" as it is packaged and distributed through the software. Consumer software is often designed to imitate situationally responsive aspects of human interaction while at the same time partially replicating other kinds of media that concretize culture in a relatively inflexible way.<sup>1</sup> Accordingly, study of human–computer interaction must poach from frameworks derived from cultural studies of media (looking at how meanings are packaged into texts that travel) and human interaction studies (looking at how meaning is constituted through interaction).

Study of computational media is enabled by the ability to observe interactions in ways not available to researchers of non-interactive media: mouse

clicks and keystrokes are accessible ways of observing the act of “reception” (use) of computational media. The challenge, however, is that the meanings of computational media are often less effectively explored outside of the actual context of use (i.e., through subsequent conversation or testing). Since there are multiple and contradictory pathways that one can take through many of the new forms of computer games, it is difficult to unpack the consumption-side meanings instantiated by a game without looking at the activity context. For example, a child might play a city simulation game for hours, treating it as a palette for drawing blobs on a grid, without ever engaging in the game as a representation of a developing city. This contrasts to, say, film, where viewers of a given movie might reasonably be expected to have journeyed through a similar set of images, albeit with different interpretations. In the case of interactive media, our understanding of what children get out of their engagement benefits from conversation with users as well as direct observational studies of use in order to capture the particular kinds of interactions and understandings that a particular software title affords.

This chapter takes some first steps towards describing the unique qualities of interaction with computational instructional media through analysis of a videotaped interaction with one educational multimedia title where a child works on a simple word-matching game with an adult helper. The case describes the space of possibility with an interactive title as indeterminate due to the multireferential quality of the interface. Alignment with the designed uses of the game is a contingent process of negotiation between child, game, and others in the local play context. Two analytical lenses are proposed for the study of children’s interactions with educational multimedia. One is the asymmetric interactional capabilities of human and machine, where the strength of machine interaction is in its inflexibility and reproducibility, and the human’s is in flexibility, indexicality, and situational responsiveness. The other is an idea of human–machine interface that extends beyond objects on the screen and the keyboard to include other people and contexts of play. After first describing the analytic framework for this study, I turn to the interaction case.

## 1. INTERACTION, GAMES, AND MEDIA

Studies of the details of interpersonal interaction, including conversation, gestures, and proxemics, have amply demonstrated the intricacies of the alignment work that goes into the construction and instantiation of a shared set of interpersonal understandings (e.g., Duranti & Goodwin, 1992; Garfinkel, [1967] 1994; Goodwin, 1990; Kendon, 1990; Lynch, 1985; McDermott & Tylbor, 1984; Schegloff, 1992). These studies have demonstrated how the structure of language and meaning are played out and engaged with in historically specific, context dependent, dynamic, and ongoing activity. In their essay on

“the necessity of collusion in conversation”, McDermott and Tylbor (1984) describe how the meaning of an utterance can only be fully understood as part of an ongoing set of interpersonal and institutional negotiations, and that analytic attention should be trained not to meaning sealed within the “inside” of an utterance, but rather meaning as it is achieved through the collusion of multiple actors in complex social relations.

Collusion derives from a playing together (from the Latin *com plua ludere*). Collusion refers to how members of any social order must constantly help each other to posit a particular state of affairs, even when such a state would be in no way at hand without everyone so proceeding. Participation in social scenes requires that members play into each other’s hands, pushing and pulling each other toward a strong sense of what is probable or possible, for a sense of what can be hoped for and/or obscured. In such a world, the meaning of talk is rarely contained on the “inside territory of an utterance”; proposition and reference pale before the task of alignment, before the task of sequencing the conversation’s participants into a widely spun social structure (219).

McDermott and Tylbor thus insist on a relational view of language, not only in the semiotic sense of relation and difference in signification (Saussure, 1959), but also in the interactionist sense of meaning as a product of historical, relational, interpersonal, practice. In line with other interaction based studies of language use, McDermott and Tylbor describe how even the most mundane human activities are a product of constant and subtle acts of interpretation and alignment, which both index and utilize a wealth of structuring resources, linguistic, material, and institutional.

Given an interactional view of meaning production, media artifacts present particular analytic problematics. Mass media and computer games have a set of semiotic and material relations “hardwired” into a material substrate, whether this is a page, film, or a floppy disk, but these meanings acquire social significance through engagement in everyday practice. An interactional view of language has much in common, conceptually though not methodologically, with ethnographic work on how mass media texts are interpreted at local sites of consumption (Mankekar, 1999; Morley, 1992; Radway, 1991). The attention, again, is on how a text is made meaningful through its embeddedness in and indexing of the ongoing activity of everyday life. A mass media text, as a stabilized or “encoded” configuration of meaning, mechanically reproduced and distributed across wide distances, is socially meaningful only to the extent that it is rendered sensible in particular, local, circumstances of consumption. In contrast to analytic positions that locate meaning only in the “inside” of a text and read a determinate set of meanings based on the text itself, ethnographic approaches to mass media have looked at how these artifacts are part of the ongoing flow of social life and acquire meaning through

their location in social and historical contexts. The same is true for games, as particular “texts”, or standardized, rule-governed systems. In her analysis of girls’ play with hopscotch, Marjorie Goodwin describes gaming as a meaningful activity, determined, not by the formal rules of the game and the parameters of the hopscotch grid, but rather by the interplay between these structuring resources and the embodied practices of play:

In hopscotch, a player systematically moves through a grid of squares drawn in chalk or painted on the sidewalk, street, playground, or other flat surface. The marks on the grid construct a relevant visible field for action, which orients those who know how to read it to the sequence of moves through space that must be traversed while playing the game . . . the grid makes possible the forms of action and local identities that are constitutive of the game: for example, stepping on or outside a line count as a consequential event, an “out” in which the hapless player loses her turn. Of central importance to the conduct of the game are not simply internal representations (e.g., an abstract rule set of some sort), but rather a dynamic interplay between the player’s body and visible marks in a structured external environment (1995: 263).

Computer games, as a particular kind of text, based on a rule-driven model of interaction, engage varied and indeterminate interactions and relationships with the daily lives of children, institutions, and other interlocutors. Like a game of hopscotch, a computer game embodies a stabilized set of rules and meanings that are locally engaged with in various and flexible ways by children, and acquires social meaning through these ongoing engagements. The meaningfulness of a game is thus an interaction between the stabilized sets of meanings and rules “coded” in the game, and the active sense-making processes of children in local situations of play. This is not to say that human activity is governed by a set of abstractable rules, but rather, on the contrary, that games, rules, and stabilized texts are malleable resources in the production of meaningful action, and that in turn, rules and structure are produced as a result of these ongoing practices.

In the case of both people and interactive texts, language and meaning are necessarily indexical and situated within a set of common cultural understandings, but the different embodiments of human and machine make for an asymmetric interagentive encounter. The computer game relies on a set of pre-programmed semiotic relations animated by a standardized and mass-produced configuration of computer circuitry. The success of a piece of software is predicated on its stability and inflexibility across situations, its ability to reliably produce the same responses and interpretations based on standard inputs. We want our word processors to reliably save and format our documents, and we want our games to respond consistently when we input answers to certain questions. For people, stable and common understandings are



interactional achievements, based on ongoing collusion between people with unique life histories and richly embodied sensory awareness of the world. Conversation analysts have demonstrated that even moments as simple as asking for the time or saying a greeting are occasions for widely variable and situationally responsive negotiations. In contrast to the interpretive inflexibility of machine understanding, human understanding indexes a richly indeterminate set of meanings and interpretive resources. Computer games, no matter how sophisticated, are based on a freezing or standardization of meanings in order for them to function translocally, as mass produced objects. In contrast, while people certainly share a common set of cultural resources, these meanings are constantly in flux, idiosyncratic, and situationally responsive.

The result of this asymmetry in interactional resources is that human-machine interaction has a peculiar rhythm and structure, where the person is continuously compensating for the inflexibility of the machine, as well as trying to guess at the underlying structure internal to the machine. In actor-network terms (Latour, 1987; 1990), this is the sense in which stabilized technologies enlist people into their sociocultural network, as durable and inflexible objects in the social landscape. It is the interaction between this stabilized sets of meanings, and the dynamic and heterogeneous contexts of human play, that is the topic of this chapter. The remainder of this chapter outlines a theoretical departure point for this work in Lucy Suchman's analysis of human-computer interaction and then analyzes one example of game play as a way of drawing from this framework and extending it into the particular domain of computational media.

## 2. THE PROBLEM OF HUMAN-MACHINE COMMUNICATION

In her book, *Plans and Situated Actions: The Problem of Human-Machine Communication*, Suchman (1987) analyzes the interactions between people and a function-loaded copier with a computerized, interactive interface. Drawing from ethnomethodological frameworks and previous studies of face-to-face interaction between people, Suchman posits a basic asymmetry in the interaction between people and machines: "(P)eople make use of a rich array of linguistic, nonverbal, and inferential resources in finding the intelligibility of actions and events, in making their own actions sensible, and in managing the troubles in understanding that inevitably arise" (180-181). In contrast, machines "rely on a fixed array of sensory inputs, mapped to a predetermined set of internal states and responses" (81). Through close analysis of interactional sequences of copier use captured on videotape, Suchman demonstrates some of the interactional outcomes of this asymmetric communication. Of particular interest are breakdown situations, where the responses of the machine, as anticipated and pre-programmed by systems designers, are not appropriate to the specific needs and situations of the users, and human and machine are

unable to engage in mutually intelligible action. For example, Suchman has documented many instances when the user and machine have been unable to orient to a task, such as making double-sided copies of a document, because of the mutual unintelligibility of their respective actions.

Suchman's analysis points to the differences between the semiotic and material capabilities of a human and machine, and some of the peculiarities of interaction and communication across this divide, the most salient of which is the asymmetry between pre-determined and situationally informed response. What is curious about computer software, however, are its multiple layers of signification, mediating between "internal" computer code at one end, and visible interface encodings at the other, only the latter of which is directly available to and interpretable by the user of a machine or the player of a computer game. Unlike non-interactive media, computer software embeds within its internal operation the force of interpretation, the ability, albeit a primitive one, to associate a set of symbolic elements, associations that are often unexpected to the user. A computer takes user input and performs operations based on the user input, in ways that are invisible to the user or only partially represented at the interface. It is this sense of opacity, the distance between human and machine interpretive stances and capabilities, which can be both a problematic and enabling feature of interaction with computers.

Examples from Suchman's study are illuminating of this sense of mutual opacity, of this distance between human and machine codes and interpretive capacities. In many of her examples, users of the copier are attempting to complete a complex task with multiple steps, such as making a set of double-sided copies from a single-sided, bound document. Through the course of a task of this sort, the copier communicates to the user through a display that provides instructions such as "place your original face down on the glass", or "close the document cover". The machine is able to gain knowledge of the user's status and activity through a limited set of sensory inputs, such as the closing of the document cover, the selection of the number of copies, or the pushing of the start button. Progress along a multistep task is made through the fulfillment of if—then conditions that speculate as to the status of user activity (e.g., if the document cover is closed, this means that the user has placed an original on the glass, then give the next instruction to the user). Situationally, relevant information, such as whether the user has a bound or unbound document, or whether the user knows what a "document cover" is, is systematically unavailable to the copier.

This opacity, however, goes both ways. The user, too, is lacking situationally relevant information about the internal states of the copier and the semantic relations of its encoding. While the interface provides the user with information about each step in a pre-programmed procedure for action, the user lacks access to the actual logic of the copier's sequential operation, the conditions it needs to fulfill to move along the multiple steps of a complex task, and an understanding of the machine language that drives these procedures. When

the designer has successfully anticipated a user's sequence of action, human and machine action are mutually comprehensible, the task is completed without incident, and the user leaves the interaction with a sense that he/she has engaged with an "intelligent" machine. In situations of breakdown, however, the machine is frozen into a set of pre-programmed procedures and interpretations that are out of alignment with the particular situation of the user, and whose logic is incomprehensible and inaccessible to the user.

As with any media, whether it is print, film, radio, or television, computer software ventriloquizes for its creators through the body of a material technology—a page, a screen, a mouse, or a keyboard. While this is, in a sense, a form of highly mediated interpersonal interaction, the process of producing consumer software strips the content creators of access to the settings of consumption or play. As reception studies of media have amply demonstrated, a representation acquires meaning as an effect of human interpretation and decoding of meaning, rather than through the force of its own internal operation or the creator's intentions (Hall, 1993). To the extent that the relatively circumscribed settings of software creation and the manifold settings of use are socially and culturally disjunctive, we can expect that the meanings encoded at the moments of production and the meanings instantiated at moments of consumption will diverge. In a related vein, de Certeau (1984) has theorized how the practices of everyday life are structurally disjunctive from the "proper" spaces of authoritative cultural production, producing meanings that poach from and refigure those centrally produced while also being dependent and subordinate to authoritative texts.

Standing behind Suchman's description of an asymmetric encounter between human and machine is a communicative breakdown between content creators and consumers, the structurally over-determined failures of programmers to anticipate all of the situations in which software might be used. In more recent work, Suchman (2000) has critiqued the stance of "design from nowhere", where technical commodities are designed with the goal of being "stabilized and cut loose from the sites of their production long enough to be exported *en masse* to the sites of their use". These relations of technology production and use mean that usage contexts are often systematically invisible from the point of view of designers, since the settings of design are separated from the settings of use through multiple distancing mediations. These are forms of distancing that Suchman (2003) seeks to challenge by crossing boundaries between settings of design and use and insisting on a view of humans and artifacts as mutually constituted across these settings. It follows that the necessary inflexibility of machine response has to do with the material structure of software and machine, as well as particular relations of production and consumption; a product coded and designed at a singular and relatively controlled site of production is mechanically reproduced and disseminated to a wide and indeterminate set of settings of consumption.

Computer games, as a form of mass media with an increasingly complex set of interactional possibilities, are a far cry from Suchman's copier, in terms of the activity that they invite, the computational complexity of their encodings, and the narrative meanings mobilized. Suchman's insights on the disjuncture between human and machine (and design and use) understandings still, however, provide a useful lens for analyzing some of the basic dynamics of how children engage with computer games. The starting point, in an analysis of interaction involving computational devices, is the peculiarity of the communicative encounter between human and machine.



SCREEN SHOT FROM LANGUAGE EXPLORER.

Source: Reproduced with permission from Nordic Software, Inc.

### 3. EXPLORING LANGUAGE WITH A COMPUTER GAME

My research on play with children's software was conducted as part of a three-year, collaborative ethnographic evaluation effort examining the Fifth Dimension After-School Club (5thD) reform effort,<sup>2</sup> where we analyzed field-notes and videotape from three 5thD clubs. The 5thD is an activity system where elementary-aged children and undergraduates from a local university come together to play with educational software in an afterschool setting. The clubs are located at community institutions such as Boys' and Girls' Clubs,

schools, or libraries and vary considerably depending on the local context and institution. What is common across the settings is a commitment to a collaborative and child-centered approach to learning, the non-hierarchical mixing of participants of different ages, and the use of personal computers running software designed for children.

One example of play in the 5thD with a game with a simple interface and functionality illustrates the relationship between pre-determined code and indeterminate local meaning, and some of the texture of human-machine interaction with interactive media. In this bit of activity, a graduate student and an 8-year old are playing together with a game called *Language Explorer*. The task is a simple one. The machine presents a set of words, with blanks above them, and a set of pictures that correspond with the words. The goal of the game is to click on and drag the pictures into the proper blanks. The pictures can be dragged to any part of the screen, but will only stick in the blanks above the words. Once all the pictures are placed, the computer will drop any incorrectly placed pictures back down to the starting position. If the pictures are all placed correctly, they will stay in position and animate.

The semiotic and functional relations encoded in this game are relatively simple and thus provide a useful starting point for understanding the basic structures of interaction with educational software and games. The content of the game can be understood based on a simple means-end model, where there is a starting state, an ending state, and a limited set of interactional possibilities to move from the one to the other. The cultural knowledge embedded in the system is one of simple signification between word and picture, where a designer has determined that one corresponds to the other. Interactionally, the only available form of human communication with the machine is through the dragging of pictures into spaces. From a starting state with blanks and pictures in a random jumble at the bottom of the screen, the player is invited to fill in the blanks. The machine has two possibilities for communicative response (only after all blanks have been filled): drop some pictures back to the bottom or leave pictures in the spaces. The responses signify, respectively, a disjuncture and a match between the semiotic relation programmed into the machine, and the one instantiated by the player. The desired end-state, from the point of view of the designers/educators, is correspondence between the signification relations encoded in the machine, and the signification relations instantiated through the activity of the player.

Although this game is simpler than most educational software on the market today, similar interactional tensions between the intentionalities of designers and the maneuverings of players still hold. Games are cultural resources that explicitly provide narrative content and interactive capabilities that players can take up in flexible ways. Despite this flexibility, however, the following case illustrates a stubbornness of machine response that encourages gradual alignment to the relations instantiated by the machine rather than flexible interpretation of the narrative elements, particularly when there is an adult present

who orients a child in a more goal-directed way. In other words, even the most sophisticated media technologies embed certain cultural and interactive relations that have persuasive force, in part because of the inflexible nature of the technology, and in part, because other users share similar cultural frameworks. The industrial relations that bring a piece of software to the hands of a child are a highly mediated form of interpersonal communication that works through the body of a machine to instantiate the vision of the designer and programmer. The voices of software creators are privileged ones even at these distanced sites of play because they have enlisted stubborn technologies and local adults with a shared interest in merging education and play. The educators at the 5thD and the educationally minded programmers of *Language Explorer* culturally collude across a social divide to deliver a vision of learning that is active and playful, but remains focused on the mastery of academic content.

While the structure of the *Language Explorer* software is simple and seemingly transparent, the actual dynamics of use can be quite complex, especially when they involve a young child who does not necessarily orient to the suggested associations between a word and a picture. In the example to follow, the interpretation of the game is further complicated by the participation of an English-speaking adult, a bilingual child who is an early reader, and a Spanish language game. Sonia is a regular participant at one of the bilingual 5thD sites and is one of the younger kids at the site, known for her sassy charm. The adult working with her is a graduate student who is involved with the 5thD project, and makes occasional visits to Sonia's club. While the semiotic relations between game elements are fixed within the parameters of game functionality and interaction, at local sites of use, the meanings of these elements are indeterminate and subject to a wide range of interpretive flexibility.

In the interactional sequence below, collusion with the meanings encoded in the machine is achieved only as the result of an extended series of interactions, where the machine provides repetitive feedback and an adult works to orient the child to what the machine is designed to communicate. This case is presented in order to illustrate the dynamic between the interactional capabilities of a game, a child and adult, when they engage in joint activity. The child begins by flexibly interpreting the narrative elements on the screen in a playful and open-ended way. The adult and the machine gradually orient her to the learning task of matching words to pictures. In contrast to the inflexible responses of the machine, the adult is able to provide nuanced and situationally responsive interaction that eventually cements a common space of understanding and goals. This is a microcosm of processes of cultural reproduction through media artifacts. The three players of child, adult, and game have aligned themselves to a set of meanings that the game and adults sought to "teach". Far from being a result of transparent "decoding" at sites of play, cultural reproduction, in this example, is about highly contingent and ongoing alignment between multiple social and technological actors.

This first sequence of activity opens with the computer booting up the game, and a title splash screen appearing, with the words: “Language Explorer”.

S = Sonia

A = Adult

1. S: OK, You know how to play this?
2. A: No, uh-huh. What do you do?
3. S: (Picks up a picture and starts to move it around the screen as she talks.) Try to find the name, the name that says—Hmmm. Do we put it up here? Over here? (Places first picture in top left space.)
4. A: The name that fits with the picture?
5. S: Look we got to put it right here in the blanks, OK? (Places a second picture in space immediately below first picture.)
6. A: OK. What’s that one? (Points to screen.)
7. S: *Martillo*
8. A: This is ahhhh?
9. S: *Nina*. (Places third picture below the second, completing one column of pictures.)
10. A: What is that?
11. S: *Naranja*. (Places another picture at top of next column.) See what I’m doing? (Places another picture below the previous one.) And then I take them off, and then I do it again. OK.
12. A: Ahh.
13. S: *Pajaro, pajaro*. (Places another picture below the previous one, completing second column.)
14. A: Ahhh.
15. S: Let’s do this.
16. A: But . . .
17. S: You see what I’m doing? (Places another picture in new column.)
18. A: Isn’t the name supposed to go with the picture?
19. S: You can do it any way you want to.

When the game screen comes up, the child begins by determining the adult’s knowledge of the game: “You know how to play this”? (line 1). When the answer is negative, she explains and exhibits her state of understanding of the game. She begins to explain the relevance of “the name” to the game, but interrupts her own exposition, “hmmm”, and orients toward the interactional choice of where to put the picture: “Do we put it up here? Over here”? (line 3). The adult, in the meantime, has decoded the game rules and explicates them for her in light of her seeming confusion: “The name that fits with the picture” (line 4). Taking a contrary and didactic tone, Sonia insists, “Look, we’ve got to put it right here in the blanks, okay?” (line 5). The adult again orients to the task of naming, that is, establishing the signifying relation that ties together word and picture (lines 6 and 8). Sonia then starts to move pictures into the blanks, in sequence from right to left, top to bottom, while

calling out names (lines 7, 9, 11, and 13). These names refer to elements in the pictures—*martillo* (hammer), *nina* (girl), *pajaro* (bird)—they are not the words that are written below the blanks. For example, the picture that Sonia identifies as “*martillo*”, which depicts a hammer shattering an object, is identified by the game as “*romper*” (to break). As she busily fills in the blanks, explaining, to the adult, the task at hand, the adult protests—“But”—and finally cuts in—“Isn’t the name supposed to go with the picture?”—again trying to establish the relation between the two game elements (lines 16 and 18). She responds, “You can do it any way you want to” (line 19). In short, Sonia is operating from knowledge about the interactional capabilities of the game (move pictures, fill blanks, repeat) and certain narrative meanings available at the interface (a hammer, a girl, a bird) while the adult tries to orient her to the semiotic relations between game elements (the match between a written word and a picture). She goes on to demonstrate her knowledge of how the pictures only will stick in the blanks, and not in other parts of the screen (lines 20 and 22):

20. S: Look. (Drags a picture to a space between two blanks, and it drops back down to the bottom of the screen.)
21. A: Oh, OK.
22. S: See, look. Look what happens. (Again, drags a picture to a space between two blanks, and it drops back down to the bottom of the screen.)
23. A: So it doesn’t go there.
24. S: Yeah, it goes. Yeah so we put it right here. (Places a picture.) See, and that one goes over here. (Places a picture.)
25. A: And that fits there.
26. S: Get up here, get up here. There. (Places last picture in final blank, and most of the pictures fall back to the bottom of the screen.)
27. A: Whoa.
28. S: You see? Magic. You see? Magic.
29. A: Magic. Yeah, pretty good.

*Some transcript omitted where she continues to place pictures in spaces at random.*

30. A: So what does it, what are you supposed to do? I still don’t, I mean like you put the pictures in the places, but –
31. S: And then, then some stay OK?
32. A: Some stay. OK.

A few minutes later, Sonia has filled in all the blanks, and most of the pictures fall back down to the bottom of the screen. “You see”? She exclaims, “Magic. You see? Magic” (line 28). She sees the pictures dropping to the bottom of the screen as an example of a fun special effect, and an indication of



playful narrative meaning, rather than an indication of an incorrect answer. In this sequence, Sonia displays an alternative set of meanings that can be brought to bear on the game, which are fully “explanatory” of (i.e., make sense of) game elements, but which mobilize a set of associations that are not coded into or intended by the game design. For Sonia, a graphic representation calls forth multiple associations—a hammer, something breaking, a bright color—and interaction with the machine is about exploration of a space of possibility—some things go in some places and not in others; and some things migrate while others do not. Sonia has interpreted game responses as *ad hoc* rather than rationalistic and pre-determined, game syntax as associative rather than syntagmatic, and game narrative as whimsical rather than evaluative. Sonia has a wide range of interpretive resources that enable her to take pleasure in the visual and spectacular features of the game, even as adults try to orient her to educational goals. She is a confident and regular participant in the 5thD and is comfortable talking back to an adult. Her interpretation of the game is robust, has held up through at least one other instance of her play of this game, and holds ground for some time despite the adult’s persistent though gentle interference pattern.

In alliance with the game, the adult does eventually succeed in displacing Sonia’s interpretation of the game interface. He begins to read, in halting Spanish, the words below the blanks. “*Detras de* means . . .”? he asks. “What?!” Sonia responds, turning to look at him in surprise. He repeats himself, pointing to the screen, and Sonia begins to orient rapidly to the designed goal of the game, to match the words to the pictures. They arrive at an interactional dynamic where he will read a word, she will translate for him, and they will work together to figure out which picture corresponds to the word. They proceed in this manner until all of the spaces are filled, and the computer responds by dropping a substantial number of the pictures down to the bottom of the screen. In contrast to her earlier delight at the “magic” of this computer response, now Sonia is dismayed, and responds with a loud “What?!” (line 33). She then orients immediately toward working out the correct answers with the adults help:

33. S: WHAT? OK, let’s do this. Tell me what this is. (Points to blank.)
34. A: That one? (Points to blank.)
35. S: Uh-huh.
36. A: *Deba . . . debah.*
37. S: *Debajo.*
38. A: *Debajo de. Esto.* (Points to picture.)
39. S: OK this one. (Puts picture in blank.)

This example illustrates some of the interactional and interpretive dynamics involved in play with an interactive informational technology. The basic asymmetry that Suchman identified is clearly exhibited here: a child with a

rich set of imaginative and interpretive resources, and a game that responds to her activity with simple, formulaic responses, based on a narrow set of interpretive resources. The game's responses are in marked contrast to that of the adult, who repeatedly engages the child in multiple ways, in response to the nuances and timing of her utterances and actions. The first characterization of this interaction, then, follows directly from Suchman's analysis; in contrast to interpersonal interaction, where people are constantly molding their responses in collusion with another's, human-machine interaction is characterized by an asymmetric relation of a person with a wide interactional range, and a machine with a small set of interactional resources.

A related feature of this interaction is the contrast between the range of meanings produced on either side of the human-machine interface. Sonia and *Language Explorer* exchange the same limited set of tokens across the same graphical user interface—information about whether a picture has been moved into one location or another. And both Sonia and the game process the exchange of these tokens as meaningful “social” acts (i.e., acts that provide relational information). The contrast is between the game, which interprets a token based on conformity to a simple binary logic (a correct or incorrect match), and a child, who is able to produce meaning out of not only the location or a picture in or out of a grid, but also of the dynamic quality of its motion, the varied nuance of the graphical form, and the relation to other experiences (i.e., “magic”). In other words, there is a disjuncture between the semiotic logic of the software's interactional algorithms (if this, then that), and the semiotic logic of the narrative elements (multiple associative networks of meaning), as represented at the user interface. This disjuncture is exploited in game design as a way of infusing game characters with evocative and multidimensional qualities despite the fact that they may only have a limited set of pre-programmed responses.

The graphical aspects of the media form also point to some particular features of multimedia that distinguish them from more “functional” computational objects such as copiers, or text-based drill-and-practice exercises. The narrative logic of the game affords multiple meaningful interpretations that are pleasing to Sonia but not significant to the game play mechanism—the way the pictures move and how the characters and objects are represented at the interface. While *Language Explorer* has a very thin set of narrative elements, they are still interpretable as meaningful by Sonia apart from the goal-oriented logic of the underlying machine functionality. The animation and graphics are experienced as “magical” special effects that elicit delight apart from any goal-directed aspect of play. The case of Sonia is a schematic microcosm of these particular game features and aspects of kid-game interaction.

The two people in this interaction collude in shifting, resourceful, and complicated ways, organized in part by the inflexible task set up by the machine.

While the machine doggedly reproduces the same sets of meanings—a set of meanings that would not be comprehensible to a young girl with limited reading skills and an adult with limited Spanish knowledge—the two players are able to orient quickly to both their respective capabilities, as well as the capabilities of the software. Sonia and the adult have thus demonstrated superior interpretive and practical flexibility, which has enabled them to move ahead in the task, but it is the meaning intended by the game designers, rather than Sonia’s idiosyncratic readings, that were, in the end, reproduced. This triumph of the meanings generated through the game production is due in part to the stubbornness of the machine, as well as the adult’s alignment with these meanings. This particular interaction, in addition to providing an illustration of the asymmetric interactional dynamics between human and machine, is also a microcosm of processes of cultural reproduction, where people and artifacts engage in a complex collusional dance, which serves to instantiate a set of meanings that are locally, and at least momentarily, hegemonic. These hegemonies are the result of an alignment of multiple factors such as the presence of guiding adults and peers, as well as the design of the technology. They need to be instantiated moment by moment, situation by situation in order to retain their hold on children’s imaginations.

This case could also be considered an instance of genre ambiguity. Sonia initially reads the game as an entertainment title, designed for fleeting pleasures read primarily through the idiom of children’s visual culture. Part of the adult’s work in this interaction is to facilitate genre recognition, orienting Sonia to the fact that the game is not only about enjoying brightly colored animations, but also about progressing along a set of discrete progress-oriented tasks. One could imagine Sonia continuing to engage with the software as an entertainment title if playing within a peer group setting. The adult eventually orients her to the software as an educational genre; he is stubborn in his resistance to Sonia’s modality of play, and the software is stubborn in its pre-programmed responses. Both the adult and the game display the dispositions of responsible and progress-directed educators.

Even the more graphically sophisticated educational titles that are currently on the market (and which were analyzed as part of the broader research project framing this study) generally exhibit interactional building blocks similar to those found in Sonia’s case. Play-minded children orient to whimsical and entertainment-oriented graphical hooks, often engaging repetitively with what adults call “eye candy”. In an educational setting, they tend to be guided through the collusion of on-screen cues, characters, and local adults toward the underlying academic goals and functionality of the game. In Sonia’s case, as in many others, the 5thD has succeeded in inflecting a reading of the game to align with the educational orientation of the software creators, a small but clear shift in the micropolitics of representation and social reproduction, a translocal handshake across a highly mediated set of social relations.

#### 4. INTERFACE

Beginning with the recognition of an asymmetric relation between human and machine, and complemented by a notion of multiple technical and narrative layers of interactive media, the human–machine interface becomes a crucial analytic focus, the site where meanings are translated across a fundamentally disjunctive divide. In the case of a copier, an interface is largely valued based on the transparency of its translations, the ability to provide the user with relevant information about machine functionality, and the ability to translate user intentions into a form clearly intelligible to the machine. In the case of games, this relation is more complex, due to their multimedia interfaces, their more developed narrative qualities, and their interactive range. Most significantly, interactive multimedia rely on the production of a vivid fantasy environment, and deliberate obfuscation of the technical substrate that produces this fiction as its special effect.

Regardless of how transparent, the human–machine interface is a site of mutual mystification between person and technology, a meeting point of incommensurable regimes of value (Appadurai, 1986), where one coin of the realm is exchanged for a different currency. The interface, while still the site of translation between human and machine understandings, is also the site of meaningful opacity. Just as in film, where the suspension of disbelief is based on a technical apparatus of digital special effects, artful editing, and tricks of lighting, all of which are invisible to the spectator, the fantasy effect of multimedia is also dependent on the (at least partial) invisibility of the technical substratum, and a propped up illusion of a simulated environment. Suchman demonstrated that copier interfaces produce certain interface fantasies and obfuscations that were seen as failures in translation rather than as productive fictions. In the case of games, functional transparency of interactive elements is valued in addition to the graphical and auditory qualities that evoke a narrative and fantasy elements that exceed the functional encodings of the game.

In contrast to much of the common usage of the term interface, this study suggests an interactional and socially contextualized view. Some in the software design community have suggested that a notion of interface be expanded out from a narrow view of buttons and windows on a screen to include the broader social relations (i.e., technical support staff, manuals, etc.) that make software intelligible to users. In his study of the history of the term in computer design, Grudin (1990a, b) traces how the notion of computer interface grew out of the growing separation between production and use. Owing to the esoteric nature of early computational practice, the first computer users were almost inevitably also programmers and were comfortable with and relied on the visibility of machine language in their computer use. As computers became more widespread and more complex, designers and programmers needed to represent machine functionality in ways accessible to non-programmers,

and the notion of interface represented these more accessible representations that were distanced from basic machine language. Grudin's work suggests that, as computers become embedded in more complicated social networks, designer's notions of computer interface need to be expanded out from this narrowly technical usage.

The growing distance and layering between machine code and functions and the interface thus mirrors the growing sense of mediation and distance between software design and use (Suchman, 2000). From a somewhat different angle, Turkle (1995) has described how the post-Macintosh user interface has co-constructed modes of engagement with computers that center on the manifestations of the interface rather than on underlying machine algorithms. While recognizing the distancing and fixity of certain aspects of current consumer interfaces, this study has suggested that the relations between user and code are not determinate; interface should be understood as an interactive process, constantly under negotiation, rather than a static set of encoded relations or structural positions. The case of Sonia illustrates how there are multiple interfaces and entry-points to a given piece of software, relations that extend beyond the co-present encounter to include the processes of coding and designing the software, engaging with particular elements of the software, and alternative narrative and functional interpretations.

The human-machine interface is importantly the site not only of happy mutual understanding and successful alignment between human and machine actors, but also the site of conflict, tension, confusion, complaint, and misunderstanding. As with face-to-face interaction, human-machine interaction is the occasion for relationships to be instantiated, relationships that carry the usual weight of social conflict, power relations, and institutional imperatives. In their discussion of "macro-actors", Callon and Latour (1981) describe the particular kind of power that comes from stabilizing and fixing a set of relations into a durable network of actors. This conglomerate, which they call a macro-actor, is defined by its durability and translocal reach, as well as by its ability to bend the will of others around the space that it occupies, by the sheer force of its stubbornness and size. What Latour and Callon describe is the power of the machine (as a stabilization and black-boxing of the interests of multiple actors) to insist on an inflexible set of meanings and demand, invite, and cajole human alignment. No matter how many times Sonia tries to get the machine to see her point of view, the machine will persist in dropping pictures to the bottom of the screen until they are exactly the way it wants them. This asymmetry is indicative of a power differential that legitimizes and embodies a certain model of educational and software design into mass-produced and durable artifacts, rather than the whimsical readings that Sonia brings to bear on the situation.

In contrast, interactional studies of human action describe a different source of strength and resilience, one based on the ability to index flexibly a wide range of meanings, and to work around the stubbornness of any particular

object. Sonia can create meaningful play out of a relatively simple toy, bending the meanings suggested by the machine into something that is personally evocative, a source of amusement, and an occasion to have some fun with a friendly adult. As de Certeau suggests, she can inflect and exploit the given cultural resources she has on hand to something of her own local manufacture. She is also empowered by her superior ability to figure out the machine's point of view; for all we know, Sonia could grow up to become a computer game programmer and code her own view of the world into a machine. In the larger scheme of things, Sonia can also get bored and walk away, unless she is called into alignment with the machine by a greater institutional power (i.e., a teacher), or by an undergraduate playmate. The machine enlists Sonia into a stubbornly defined set of relations, but Sonia, in turn, enlists the machine as a peripheral element in the overall fabric of her life. The power dynamic at the interface, between the hegemony of a set of encoded meanings and their reinterpretation, is a constant feature of play with computational media.

The interface is also the site at which children form relationships with machines. While certainly different, in both depth and range, from interpersonal relationships, relationships with computational media are important factors in the learning and identity formation of many children. Children's relation to computers, both in terms of technical literacy and their orientation to the broader cultural codes embedded in computer games, is a dynamic site of identity work, where children pit their skills and wills against the game goals and the deliberate opacity of the interface. Much of the work of "beating" a computer game is about decoding the peculiar nature of machine communication and delving below the visible clues of the interface to work out the underlying logic of machine semantics. Continued engagement with computer games is also importantly about progressive alignment with the semiotic relations that are encoded into the game, as well as the concomitant social and institutional subject positions implied by those relations.

When looking at interactive multimedia as a particular computational form, the interface emerges as uniquely layered based on the relations between narrative and functional encodings. The goal of this chapter has been to lay out a working framework for understanding some of the foundational features of children's engagement with interactive multimedia, drawing on existing theories of narrative engagement, on one hand, and interpersonal and human-machine interaction on the other. Through the case of Sonia and *Language Explorer*, the work has been to apply these existing theories and extend them into the domain of interactive multimedia. In contrast to most human-computer interactional approaches, which focus on computational tools or communications, interaction analysis of computer games needs to pay more attention to narrative meanings, goals, and competition, as they are coded into a mass media form. In short, the interactive aspects of computer games demand interaction and activity-based understandings of media consumption as well as

understandings of interpretive process and narrative meaning. The responsive and narrative qualities of interactive multimedia present us with new analytic puzzles that demand attention to a widely spun social structure co-constituted by people and machines encountering one another across an increasingly complex set of interface conventions, as well as the relations of production and consumption that bring these actors together.

#### ACKNOWLEDGMENTS

Research for this chapter was conducted as part of a project funded by the Mellon Russell-Sage Foundation, and located at the Institute for Research on Learning, the University of California, San Diego, and Whittier College. The overall 5thD effort is immense, but I would like to acknowledge those in my immediate research team: my academic advisors, Ray McDermott, Michael Cole, James Greeno, Don Bremme, and Shelley Goldman, fellow graduate students Vanessa Gack and Katherine Brown, and research assistants Dena Hysell, Natasha Royer, Joy Yang, Raquel Ramirez, and Alla Cherkassky. Writing was funded in part by a Spencer Dissertation Fellowship and the Annenberg Center for Communication and the University of Southern California. This chapter is excerpted from two dissertations at Stanford University, one at the School of Education, entitled *Interactive Media for Play*, and the other at the Department of Anthropology, entitled, *Engineering Play*. This chapter has benefited from readings and comments by Jason Nolan, Carol Delaney, Joan Fujimura, Shelley Goldman, James Greeno, Purnima Mankekar, Ray McDermott, Susan Newman, Lucy Suchman, and Sylvia Yanagisako.

#### ENDNOTES

1. By this, I am not referring to interpretive inflexibility on the part of viewers, but rather the fact that users cannot easily reconfigure the texts themselves, or design customized pathways through the representations.
2. For more information on the 5thD clubs, see Cole (1997) and Vasquez et al. (1994).

#### REFERENCES

- Appadurai, A. (1986). Introduction: commodities and the politics of value. In: Appadurai, A. (Ed.) *The Social Life of Things: Commodities in Cultural Perspective*. New York: Cambridge University Press, 3–63.
- Callon, M. & Latour, B. (1981). Unscrewing the big leviathan. In: Knorr, K. and Cicourel, A. (Eds.) *Toward an Integration of Micro and Macro Sociologies*. London: Routledge.

- Cole, M. (1997). *Cultural Psychology: A Once and Future Discipline*. Cambridge: Harvard U. Press.
- de Certeau, M. (1984). *The Practice of Everyday Life* (Rendall, S., Trans.). Berkeley: University of California Press.
- Duranti, A. & Goodwin, C. (Eds.) (1992). *Rethinking Context: Language as an Interactive Phenomenon*. New York: Cambridge University Press.
- Garfinkel, H. ([1967] 1994). *Studies in Ethnomethodology*. Cambridge: Polity Press.
- Goodwin, M. H. (1990). *He-Said-She-Said: Talk as Social Organization Among Black Children*. Bloomington: Indiana University Press.
- Goodwin, M. H. (1995). Co-construction in girls' hopscotch. *Research on Language and Social Interaction* 28(3), 261–281.
- Grudin, J. (1990a). The Computer Reaches Out: The Historical Continuity of Interface Design. Proceedings of the ACM SIG CHI Human Factors in Computing Systems Conference, Seattle.
- Grudin, J. (1990b). Interface. Paper presented at the *Conference on Computer Supported Cooperative Work*, Los Angeles.
- Hall, S. (1993). Encoding, decoding. In: Durin, S. (Ed.) *The Cultural Studies Reader*. New York: Routledge, 90–103.
- Ito, M. (1998). *Interactive Media for Play: Kids, Computer Games, and the Productions of Everyday Life*. Stanford: Stanford University.
- Ito, M. (2003). *Engineering Play: Children's Software and the Productions of Everyday Life*. Stanford: Stanford University.
- Kendon, A. (1990). *Conducting Interaction*. Cambridge: Cambridge University Press.
- Latour, B. (1987). *Science in Action*. Cambridge: Harvard University Press.
- Latour, B. (1990). Drawing things together. In: Lynch, M. and Woolgar, S. (Eds.) *Representation in Scientific Practice*. Cambridge: MIT Press, 19–68.
- Lynch, M. (1985). *Art and Artifact in Laboratory Science: A Study of Shop Work and Shop Talk in a Research Laboratory*. London: Routledge and Kegan Paul.
- Mankekar, P. (1999). *Screening Culture, Viewing Politics: An Ethnography of Television, Womanhood, and Nation in Postcolonial India*. Durham: Duke University Press.
- McDermott, R., & Tylbor, H. (1984). On the necessity of collusion in conversation. In: Tedlock, D. and Mannheim, B. (Eds.) *The Dialogic Emergence of Culture*. Urbana: University of Illinois Press, 218–236.
- Morley, D. (1992). *Television, Audiences, and Cultural Studies*. New York: Routledge.
- Radway, J. A. (1991). *Reading the Romance: Women, Patriarchy, and Popular Literature*. Chapel Hill: University of North Carolina Press.
- Saussure, Fd. (1959). *Course in General Linguistics*. New York: McGraw-Hill.
- Schegloff, E. A. (1992). Repair after next turn: the last structurally provided defense of intersubjectivity in conversation. *American Journal of Sociology* 97(5), 1295–1345.
- Suchman, L. (1987). *Plans and Situated Actions: The Problem of Human/Machine Communication*. New York: Cambridge University Press.
- Suchman, L. (2000). *Located Accountabilities in Technology Production*. Lancaster University Department of Sociology. Available at: <http://www.comp.lancs.ac.uk/sociology/soc039ls.html>.
- Suchman, L. (2003). *Human/Machine Reconsidered*. Lancaster University Department of Sociology. Available at: <http://www.comp.lancs.ac.uk/sociology/soc040ls.html>.
- Turkle, S. (1995). *Life on the Screen: Identity in the Age of the Internet*. New York: Simon & Schuster.
- Vasquez, O. A., Pease-Alvarez, L., & Shannon, S. M. (1994). *Pushing Boundaries: Language and Culture in a Mexicano Community*. Cambridge: Cambridge University Press.



## Chapter 9: Technological Transformation, Multiple Literacies, and the Re-visioning of Education<sup>1</sup>

DOUGLAS KELLNER

*Philosophy of Education, University of California, Los Angeles*

The dramatic multiplication of computer, information, communication, and multimedia technologies has been changing everything from the ways people work, to the ways they communicate with each other and spend their leisure time. This technological revolution is often interpreted as the beginnings of a knowledge or information society, and therefore ascribes education a central role in every aspect of life. It poses tremendous challenges to educators to rethink their basic tenets, to deploy the new technologies in creative and productive ways, and to restructure schooling to respond constructively and progressively to the technological and social changes currently underway. At the same time, important demographic and socio-political changes are taking place throughout the world. Emigration patterns have created the challenge of providing people from diverse races, classes, and backgrounds with the tools and competencies to enable them to succeed and participate in an ever more complex and changing world.

In this chapter, I argue that educators need to cultivate multiple literacies for contemporary technological and multicultural societies, that teachers need to develop new literacies of diverse sorts, including a more fundamental importance for print literacy, to meet the challenge of restructuring education for a hi-tech, multicultural society, and global culture. In a period of dramatic technological and social change, education needs to help produce a variety of types of literacies to make current pedagogy relevant to the demands of the contemporary era. As new technologies are altering every aspect of our society and culture, we need to comprehend and make use of them both to understand and transform our worlds. In particular, by introducing multiple literacies to empower individuals and groups traditionally excluded, education could be reconstructed to make it more responsive to the challenges of a democratic and multicultural society.

### 1. TECHNOLOGY AND THE RE-VISIONING OF EDUCATION

To dramatize the issues at stake, we should consider the claim that we are now undergoing one of the most significant technological revolutions for education since the progression from oral to print and book-based teaching (Best & Kellner, 2001; Castells, 1996; 1997; 1998). Just as the transition to print

literacy and book culture involved a dramatic transformation of education (Illich & Sanders, 1988; McLuhan, 1962; 1964; Ong, 1988), so too does the on-going technological transformation demand a major restructuring of education today with novel curricula, pedagogy, literacies, practices, and goals. Furthermore, the technological developments of the present era makes possible the radical re-visioning and reconstruction of education and society argued for in the progressive era by Dewey and in the 1960s and the 1970s by Ivan Illich, Paolo Freire, and others who sought radical educational and social reform.<sup>2</sup>

A re-visioning education requires a thorough examination and critique of dominant institutions of schooling, pedagogical practices, and the goals and ends of teaching. Technological change, globalization, and multicultural expansion all demand looking at things in novel ways and looking back at how the world was before dramatic changes have occurred. Re-vision involves both critically seeing the past and the present and imagining a different future. It implies as well reconstructing education, using informed theory to guide novel pedagogical practices and to fundamentally restructure educational institutions. Re-visioning education also involves another way of seeing and doing grounded in historical practices of the present and looking toward a different and better future.

Put in historical perspective, it is now possible to see modern education as preparation for industrial civilization and minimal citizenship in a passive representative democracy. Modern education, in short, emphasizes submission to authority, rote memorization, and what Freire called the “banking concept” of education in which learned teachers deposit knowledge into passive students, inculcating conformity, subordination, and normalization. Today, these traits are somewhat undercut in certain sectors of the global post-industrial and networked society with its demands for new skills for the workplace, participation in emergent social and political environs, and interaction within novel forms of culture and everyday life.

A more flexible economy, based on an ever-evolving technological infrastructure and more multicultural workforce demands a more technically literate, interactive, culturally sensitive, and educated workforce, while revitalizing democracy requires the participation of informed citizens.<sup>3</sup> Yet, while on one hand, the demands of the expanding global economy, culture, and polity require a more informed, participatory, and active workforce and citizenship, on the other hand, a docile workforce and service industry is still the norm in many sectors of work, society, and culture. Although for a time, ideologues of the new technologies argued that information and communication technology (ICT) would of themselves dramatically reorganize and democratize the workplace, schooling, the polity, and everyday life (Gates, 1996; Kelly, 1995; 1999, it is by now clear the supposed liberating effects of new technologies were greatly exaggerated. But while globalization and technological multiplication have highly ambiguous effects (Best & Kellner, 2001), they

provide educational reformers with the challenge of whether education will be restructured to promote democracy and human needs, or whether education will be transformed primarily to serve the needs of business and the global economy.

To some extent, constant technological transformation renders necessary the sort of thorough restructuring of education that radicals have demanded since the Enlightenment of Rousseau and Wollstonecraft through Dewey, all of whom saw the progressive reconstruction of education as the key to democracy. Today, however, intense pressures for change now come directly from technology and the economy and not ideology or educational reformist ideas, with an expanding global economy and novel technologies demanding innovative skills, competencies, literacies, and practices. It is therefore a burning question as to what sort of restructuring of education and society will take place, in whose interests, and for what ends. More than ever, we need philosophical reflection on the ends and purposes of education, on what we are doing and trying to achieve in our educational practices and institutions. In this situation, it may be instructive to return to Dewey and see the connections between education and democracy, the need for the reconstruction of education and society, and the value of experimental pedagogy to seek solutions to the problems of education in the present day. A progressive reconstruction of education will urge that it be done in the interests of democratization, ensuring access to ICTs for all, helping to overcome the so-called digital divide and divisions of the haves and have nots, so that education is placed, as Dewey (1997 [1916]) and Freire (1972; 1998) propose, in the service of democracy and social justice.

Yet we should be more aware than Dewey of the obduracy of divisions of class, gender, race, and work self-consciously for multicultural democracy and education. This task suggests that we valorize difference and cultural specificity, as well as equality and shared universal Deweyan values such as freedom, equality, individualism, and participation. Theorizing a democratic and multicultural reconstruction of education forces us to confront the digital divide, that there are divisions between information and technology have and have nots, just as there are class, gender, and race divisions in every sphere of the existing constellations of society and culture. The latest surveys of the digital divide, however, indicate that the key indicators are class and education, as well as race and gender, hence the often-circulated argument that new technologies merely reinforce the hegemony of upper class white males must be questioned, at least for some contemporary societies.<sup>4</sup>

Rob Shields has argued that the concept of the “digital divide” serves as a marketing device for the benefit of technology disseminators and that on the whole the development of new technologies helps increase the divide between haves and have nots (2001). While no doubt hi-tech corporations and affiliated government institutions have promoted the challenge of a

digital divide the concept points to some serious problems and challenges. It is clear by now that providing access and computers alone without proper training and pedagogy does not advance education or social justice. Thus, more broadly conceived, the notion of a digital divide points to disparities in terms of access, training, skills, and the actual use of technologies to improve education and promote social justice.

With the proper resources, policies, pedagogies, and practices, educators can work to reduce the (unfortunately growing) gap between haves and have nots by promoting broad training in information and computer literacy that embraces a wide range of projects from providing technical skills to engaging students in the production of media projects. Although technology alone will not suffice to democratize and adequately reconstruct education, in a technological society providing proper access and training can improve education if it is taken as a supplement.<sup>5</sup> That is, technology itself does not necessarily improve teaching and learning, and will certainly not of itself overcome acute socio-economic divisions. Indeed, without proper re-visioning of education and without adequate resources, pedagogy, and educational practices, technology could be an obstacle or burden to genuine learning and will probably increase rather than overcome existing divisions of power, cultural capital, and wealth.

In the following reflections, I focus on the role of computers and information technology in contemporary education and the need for new pedagogies and an expanded concept of literacy to respond to the importance of ICTs in every aspect of life. I propose some ways that ICTs and new literacies can serve as efficacious learning tools which will contribute to producing a more democratic and egalitarian society, and not just provide skills and tools to privileged individuals and groups that will improve their cultural, capital, and social power at the expense of others. How, indeed, can education be re-visioned and reconstructed to provide individuals and groups with the tools, the competencies, the literacies and social practices, to overcome the class, gender, and racial divides that bifurcate our society and at least in terms of economic indicators seem to be growing rather than diminishing?

First, however, I wish to address the technophobic argument against ICT *per se*. I have been developing critical theories of technology that call attention to uses or types of technology as tools of domination, and that rejects the hype and pretensions of techno-utopias and techno-fixes to the problems of education and society. A critical theory of technology thus sees the limitations of pedagogy and educational proposals based primarily on technology without adequate emphasis on classroom pedagogy, and on teacher and student empowerment. It insists on developing educational reform and restructuring to promote multicultural democracy, and calls for appropriate restructuring of technology to democratic education and society. Yet a critical theory also sees how technology can be used, and perhaps redesigned

and restructured for positive purposes such as enhancing education, democracy, and overcoming the divide between haves and have nots, while enabling individuals to democratically and creatively participate in a new global economy, society, and culture (see Feenberg, 1991; 1999; Best & Kellner, 2001).

The late Ivan Illich's post-industrial model of education contains a radical critique of existing schooling and alternative notions like webs of learning, tools for conviviality, and radically reconstructing education to promote learning, democracy, and social and communal life, thus providing salient alternatives to modern systems (1971, 1973). Illich's "Learning Webs" (1971) and "Tools for Conviviality" (1973) anticipate the internet and how it might provide resources, interactivity, and communities that could help revolutionize education. For Illich, science and technology can either serve as instruments of domination or progressive ends. Hence, whereas big systems of computers promote modern bureaucracy and industry, personalized computers made accessible to the public might be constructed to provide tools that can be used to enhance learning. Thus, Illich was aware of how technologies like computers could either enhance or distort education depending on how they were fit into a well-balanced ecology of learning.

"Tools of conviviality" for Illich are appropriate, congenial, and promote learning, sociality, and community (1973). They are tools in which ends dictate means and individuals are not overpowered or controlled by their technologies (as say, with assembly lines, nuclear power plants, or giant computer systems). Convivial tools produce a democratic and convivial society in which individuals communicate, debate, participate in social and political life, and help make decisions. Convivial tools free individuals from dependency and cultivate autonomy and sociality. They provide individuals and society with the challenge of producing convivial tools and pedagogies that will create better modes of learning and social life.

Conviviality for Illich involves "autonomous and creative intercourse among persons, and the intercourse of persons with their environment" (1973: 27). Illich proposes a normative dimension to critique existing systems and construct alternative ones using values of "survival, justice, and self-defined work" as positive norms (1973: 13). These criteria could guide a reconstruction of education to serve the needs of varied communities, to promote democracy and social justice, and to redefine learning and work to promote creativity, community, and an ecological balance between people and the Earth. Indeed, Illich was one of the few critics working within radical pedagogy in his period who took seriously ecological issues and critically appraised institutions like schooling, medicine, transportation, and other key elements of industrial society within a broad social, political, economic, and ecological framework. His goal was nothing less than a critique of industrial civilization and a project of envisaging post-industrial institutions of learning, democratization, and social justice.

Illich saw that a glaring problem with contemporary educational institutions was that they become fixed in monomodal instruction with homogenized lesson plans, curricula, and pedagogy, and neglect to address challenging political, cultural, or ecological problems. The development of tools of conviviality and radical pedagogies enable teachers and students to break with these models and to engage in Deweyan experimental education. A reconstruction of education could help create subjects better able to negotiate the complexities of emergent forms of everyday life, labor, and culture, as contemporary life becomes more multifaceted and dangerous. More supportive, dialogical, and interactive social relations in learning situations can promote co-operation, democracy, and positive social values, as well as fulfill needs for communication, esteem, and learning. Whereas modern mass education tended to see life in a linear fashion based on print models and developed pedagogies which broke experience into discrete moments and behavioral bits, critical pedagogies could produce skills that enable individuals to better navigate the multiple realms and challenges of contemporary life. Deweyan education focused on problem-solving, goal-seeking projects, and the courage to be experimental, while Freire developed alternative pedagogies and Illich oppositional conceptions of education and learning and critiques of schooling. It is this sort of critical spirit and vision to reconstruct education and society that can help produce new pedagogies, tools for learning, and social justice for the present age.

At a time when many were enamored of the autonomous power and emancipatory potential of the school, Illich insisted on seeing schools as part and parcel of industrial society and one of the major instruments of its social reproduction. One of Illich's enduring contributions is to see relationships between modern industrial institutions like schooling, production, medicine, transportation, and other major sectors of industrial society. In order to engage with how what goes on in educational institutions we must have far better and more critical self-understandings of what specific institutions like schooling do in their institutional structure within the broader society, their hidden curriculum and how they engage in social reproduction. Understanding schooling beyond its institutional sites also requires grasping its dialectical relationships to the public pedagogies of media and the street, and the networked civic and social space of the internet, as well as how schooling relates to the oppressions and operations of workplaces, government institutions, and corporations.

Illich thus provides concrete analyses and a critique of how schooling reproduces the existing social order and is flawed and debased by the defects and horrors of the industrial system. Illich also recognizes that post-industrial society requires certain competencies and that a major challenge is to construct convivial technologies that will improve both education and social life. While he resolutely opposed neo-liberal agendas and was critical of encroaching corporate domination of the internet and information technologies, Illich's notion of "webs of learning" and "tools of conviviality" can be appropriated

for projects of the radical critique and reconstruction of education and learning in the contemporary era.

It is interesting that one of the godfathers of critical pedagogy, Paulo Freire, was positive toward media and new technologies, seeing technologies as potential tools for empowering citizens, as well as instruments of domination in the hands of ruling elites. Freire wrote that: "Technical and scientific training need not be inimical to humanistic education as long as science and technology in the revolutionary society are at the service of permanent liberation, of humanization" (1972: 157).<sup>6</sup> Some critical pedagogues, however, are technophobes, seeing new technologies solely as instruments of domination. Certainly, both Illich and Freire also had concerns about the internet and globalization. In a world inexorably undergoing processes of globalization and technological transformation, one cannot, however, in good conscience advocate a policy of clean hands and purity, distancing oneself from technology and globalization, but must intervene in the processes of economic and technological revolution, attempting to deflect these forces for progressive ends and developing new pedagogies to advance the project of human liberation and well-being.

Re-visioning technology, literacy, and education should avoid both technophobia and technophilia, rejecting technological determinism, while being critical of the limitations, biases, and downsides of new technologies, but wanting to use and redesign technologies for education for democracy and for social reconstruction in the interests of social justice. This project is also, in the Deweyan spirit, pragmatic and experimental, recognizing that there is no agreed upon way to deploy new technologies for enhancing education and democratization. Critical educators should be prepared to accept that some of the attempts to use technology for education may well fail, as have no doubt many of our own attempts to use computer-mediated technologies for education. Different parts of the world and varying groups will have different projects that computers can help them with, different needs and problems, and thus varied pedagogical projects.

A critical theory of technological literacy is aware that technologies have unforeseen consequences and that good intentions and seemingly good projects may have results that were not desired or positive. Indeed, there are ecological consequences concerning the production, use, and discarding of computer technologies, dangers of over and misuse of computers for individual health and well-being, and costs and downsides of organizing so many activities ranging from work to communication to research around information technologies. A critical pedagogy will thus contextualize the production and use of multimedia and information technologies within social relations and contexts, criticize negative aspects and effects, and attempt to transform technologies into positive environments of education and social transformation.

Thus, the question is not whether computers and multimedia technologies are good or bad in the classroom or more broadly for education. Rather, it is

a question of what multimedia and computers can do and cannot do toward helping to produce a more democratic and equalitarian society and what their limitations are for producing more active and creative human beings and a more just society. Crucially, we must ask: What sort of skills do students and teachers need to effectively deploy computers and information technology, what sort of effects might ICTs have on learning, subjectivities, and social relations, and what new literacies, forms of education, and social relations do we need to democratize and improve education today?

## 2. MEDIA LITERACY: AN UNFULFILLED CHALLENGE

Literacy involves gaining the skills and knowledge to read and interpret the text of the world and to successfully navigate and negotiate its challenges, conflicts, and crises. Literacy is thus a necessary condition to equip people to participate in the local, national, and global economy, culture, and polity. As Dewey argued (1997), education is required to enable people to participate in democracy, for without an educated, informed, and literate citizenry, strong democracy is impossible. Moreover, there are crucial links between literacy, democracy, empowerment, and participation, and without developing adequate literacies differences between haves and have nots cannot be overcome and individuals and groups will be left out of the emerging economy, networked society, and culture.

To reading, writing, and traditional print literacies, one could argue that in an era of technological revolution, we need to develop robust forms of media literacy, computer literacy, and multimedia literacies, thus cultivating “multiple literacies” in the restructuring of education. Computer and multimedia technologies demand novel skills and competencies, and if education is to be relevant to the problems and challenges of contemporary life it must expand the concept of literacy and develop new curricula and pedagogies.

Both traditionalists and reformists would probably agree that education and literacy are intimately connected. “Literacy” in my conception comprises gaining competencies involved in effectively using socially constructed forms of communication and representation. Learning literacies requires attaining competencies in practices in contexts that are governed by rules and conventions. Literacies are socially constructed in educational and cultural practices involving various institutional discourses and pedagogies. Literacies evolve and shift in response to social and cultural change and the interests of elites who control hegemonic institutions.

I would resist, however, extreme claims that the era of the book and print literacy is over. Although there are discontinuities and novelties in the current constellation, there are also important continuities. Indeed, in the emergent information-communication technology environment, traditional print literacy takes on increasing importance in the computer-mediated cyberworld as



people need to critically scrutinize and scroll tremendous amounts of information, putting increased emphasis on developing reading and writing abilities. For instance, internet discussion groups, chat rooms, e-mail, blogs, wikis, and various internet forums require writing skills in which a new emphasis on the importance of clarity and precision is emerging.<sup>7</sup> In this context of information saturation, it becomes an ethical imperative not to contribute to cultural and information overload, and to concisely communicate thoughts and feelings.

In the emergent multimedia environment, *media literacy* is arguably more important than ever. Cultural studies and critical pedagogy have begun to teach us to recognize the ubiquity of media culture in contemporary society, the growing trends toward multicultural education, and the need for media literacy that addresses the issue of multicultural and social difference.<sup>8</sup> There is expanding recognition that media representations help construct our images and understanding of the world and that education must meet the dual challenges of teaching media literacy in a multicultural society and sensitizing students and publics to the inequities and injustices of a society based on gender, race, and class inequalities and discrimination. Recent critical studies see the role of mainstream media in exacerbating or diminishing these inequalities and the ways that media education and the production of alternative media can help create a healthy multiculturalism of diversity and more robust democracy. They confront some of the most serious difficulties and problems that currently face us as educators and citizens.

Yet despite the ubiquity of media culture in contemporary society and everyday life, and the recognition that the media themselves are a form of pedagogy, and despite criticisms of the distorted values, ideals, and representations of the world in popular culture, media education in K-12 schooling has never really been established and developed in most contemporary societies. The current technological revolution, however, brings to the fore more than ever the role of media like television, popular music, film, and advertizing, as the internet rapidly absorbs these cultural forms and creates novel cyberspaces and forms of culture and pedagogy. It is highly irresponsible in the face of saturation by internet and media culture to ignore these forms of socialization and education; consequently a critical reconstruction of education should produce pedagogies that provide media literacy and enable students, teachers, and citizens to discern the nature and effects of media culture.

Media culture is a form of pedagogy that teaches proper and improper behavior, gender roles, values, and knowledge of the world (Kellner, 1995a, b). Individuals are often not aware that they are being educated and constructed by media culture, as its pedagogy is frequently invisible and subliminal. This situation calls for critical approaches that make us aware of how media construct meanings, influence and educate audiences, and impose their messages and values. A media literate person is skillful in analyzing media codes and conventions, able to criticize stereotypes, values, and ideologies, and competent

to interpret the multiple meanings and messages generated by media texts. Media literacy helps people to use media intelligently, to discriminate and evaluate media content, to critically dissect media forms, and to investigate media effects and uses.

Within educational circles, however, a debate persists over what constitutes the field of media pedagogy, with different agendas and programs. A traditionalist “protectionist” approach would attempt to “inoculate” young people against the effects of media addiction and manipulation by cultivating a taste for book literacy, high culture, and the values of truth, beauty, and justice, and by denigrating all forms of media and computer culture (see Postman, 1985; 1992). A “media literacy” movement, by contrast, attempts to teach students to read, analyze, and decode media texts, in a fashion parallel to the advancement of print literacy. Media arts education in turn teaches students to appreciate the esthetic qualities of media and to use various media technologies as instruments of self-expression and creation. Critical media literacy builds on these approaches, analyzing media culture as products of social production and struggle, and teaching students to be critical of media representations and discourses, but also stressing the importance of learning to use the media as modes of self-expression and social activism where appropriate (Kellner, 1995a).

Developing critical media literacy and pedagogy also involves perceiving how media like film or video can also be used positively to teach a wide range of topics like multicultural understanding and education. If, for example, multicultural education is to champion genuine diversity and expand the curriculum, it is important both for groups excluded from mainstream education to learn about their own heritage and for dominant groups to explore the experiences and voices of minority and excluded groups. Thus, media literacy can promote multicultural literacy, conceived as understanding and engaging the heterogeneity of cultures and subcultures that constitute an increasingly global and multicultural world (Courts, 1998; Weil, 1998).

Critical media literacy not only teaches students to learn from media, to resist media manipulation, and to use media materials in constructive ways, but is also concerned with developing skills that will help create good citizens and that will make them more motivated and competent participants in social life. Critical media literacy can be connected with the project of radical democracy and concerned to develop skills that will enhance democratization and participation. Critical media literacy takes a comprehensive approach that would teach critical skills and how to use media as instruments of social communication and change. The technologies of communication are becoming more and more accessible to young people and ordinary citizens, and can be used to promote education, democratic self-expression, and social progress. Technologies that could help produce the end of participatory democracy, by transforming politics into media spectacles and the battle of images, and by

turning spectators into cultural zombies, could also be used to help invigorate democratic debate and participation (Kellner, 1990; 1998).

Indeed, teaching critical media literacy could be a participatory, collaborative project. Watching television shows or films together could promote productive discussions between teachers and students (or parents and children), with emphasis on eliciting student views, producing a variety of interpretations of media texts, and teaching basic principles of hermeneutics and criticism. Students and youth are often more media savvy, knowledgeable, and immersed in media culture than their teachers, and can contribute to the educational process through sharing their ideas, perceptions, and insights. On the other hand, critical discussion, debate, and analysis ought to be encouraged with teachers bringing to bear their critical perspectives on student readings of media material. Since media culture is often part and parcel of students' identity and most powerful cultural experience, teachers must be sensitive in criticizing artifacts and perceptions that students hold dear, yet an atmosphere of critical respect for difference *and* inquiry into the nature and effects of media culture should be promoted.

One of the most effective ways of teaching critical media literacy is involving students themselves in the production of media texts (see Hammer in McLaren et al., 1995; Kellner and Share, 2005). Learning to produce different forms of media texts teaches codes, formal features, and the role of technology in constructing media artifacts. In becoming literate in semiological and ideological codes of media culture, students not only can read and critique dominant modes of cultural hegemony, but also can produce oppositional forms of culture, subverting the dominant codes and ideologies and providing alternatives.

A major challenge in developing critical media literacy, however, results from the fact that it is not a pedagogy in the traditional sense with firmly established principles, a canon of texts, and tried-and-true teaching procedures. Critical media pedagogy is in its infancy; it is just beginning to produce results, and is more open and experimental than established print-oriented pedagogy. Moreover, the material of media culture is so polymorphous, multivalent, and polysemic, that it requires sensitivity to different readings, interpretations, perceptions of the complex images, scenes, narratives, meanings, and messages of media culture which in its own ways is as complex and challenging to critically decipher as book culture.

Teaching critical media literacy involves occupation of a site above the dichotomy of fandom and censor. One can teach how media culture provides significant statements or insights about the social world, empowering visions of gender, race, and class, or complex esthetic structures and practices, thereby putting a positive spin on how it can provide significant contributions to education. Yet critical educators should indicate also how media culture can advance sexism, racism, ethnocentrism, homophobia, and other forms of

prejudice, as well as misinformation, problematic ideologies, and questionable values, accordingly promoting a dialectical approach to the media that aims at critical and discriminating readers.

### 3. COMPUTER LITERACY: AN EXPANDED CONCEPT

To fully participate in the hi-tech and global society, teachers and students should cultivate forms of computer literacy in ways that go beyond standard technical notions. Critical computer literacy involves learning how to use computer technologies to do research and gather information, as well as to perceive computer culture as a terrain containing texts, spectacles, games, and interactive multimedia which call for cultivating new literacies. As technologies like computers, telephones, televisions, and emergent multimedia devices converge, computer-mediated culture will increasingly provide an encompassing environment in which people work, play, relate, learn, and interact. Becoming computer-literate in this broad sense thus requires expanding notions of literacy and learning how to communicate, interact, and create in novel cybercultures.

The emergent cybercultures can be seen as a discursive and political location in which students, teachers, and citizens can all intervene, engaging in discussion groups and collaborative research projects, creating Websites, producing innovative multimedia for cultural dissemination, and engaging in novel modes of social interaction and learning. Computer culture enables individuals to actively participate in the production of culture, ranging from dialogue concerning public issues to creation of their own cultural forms. However, to take part in this culture requires not only accelerated skills of print literacy, which are often restricted to the growing elite of students who are privileged to attend adequate and superior public and private schools, but also demands multiple forms of literacy.

To respond intelligently to the dramatic technological revolution of our time, we need to begin teaching computer literacy from an early age. Computer literacy, however, itself needs to be theorized. Often the term is synonymous with technical ability to use computers, to become proficient in the use of existing programs, and maybe undertake some programming. I suggest expanding the conception of computer literacy from using computer programs and hardware to a broader concept of information and multimedia literacy. This necessitates promoting more sophisticated abilities in traditional reading and writing, as well as the capability to dissect and read cultural forms taught as part of critical media literacy and multimedia pedagogy.

In my expanded conception, computer literacy involves learning how to use computers, access information and educational material, use e-mail and

list-serves, and construct Websites. Computer literacy comprises the accessing and processing of diverse sorts of information proliferating in the so-called “information society”. It encompasses learning to find sources of information ranging from traditional sites like libraries and print media to new Internet Websites and search engines. Computer-information literacy involves learning where information is found, how to access it, and how to organize, interpret, and evaluate the information that one seeks.

One exciting development in the current technological revolution is that library materials and information are accessible throughout the world. To some extent, the internet is potentially the all-encompassing library, imperfectly constructed in Alexandria, Egypt, that would contain the great books of the world. Yet while a mind-boggling amount of the classics are found on the internet, we still need the local library to access and collect books, journals, and print material not found on the internet, as well as the essential texts of various disciplines and the culture as a whole. Information literacy, however, and the new tasks for librarians, also involve knowing what one can and cannot find on the internet, how to access it, and where the most reliable and useful information is at hand for specific tasks and projects.

Information literacy also requires learning how to distinguish between good and bad information, identifying what Burbules and Callister (2000) identify as misinformation, malinformation, messed-up information, and mostly useless information. In this sense, information literacy is closely connected with education itself, with learning where information is found, how to produce knowledge and understanding, and how to critically evaluate and interpret information sources and material. It also raises questions of power and knowledge, concerning who decides that privileged information is, who gets to produce and valorize various modes of information, and whose ideas get circulated and discussed, and who gets marginalized.

Computer and information literacies also involve learning how to read hypertexts. This involves learning how to traverse the ever-changing fields of cyberculture, and to participate in a digital and interactive multimedia culture that encompasses work, education, politics, culture, and everyday life. Hypertext was initially seen as an innovative and exciting new mode of writing which increased potentials for writers to explore novel modes of textuality and expression (Joyce, 1995; Landow, 1992).<sup>9</sup> As multimedia hypertext developed on the internet, it was soon theorized as a multisemiotic and multimodal form of culture. This mode is now increasingly seen as the dominant form of a new hyperlinked, interactive, and multimedia cyberculture (see Burbles & Callister, 1996; 2000; Snyder, 1996; 1997; 2002).

Genuine computer literacy involves not just technical knowledge and skills, but refined reading, writing, research, and communicating ability. It involves heightened capacities for critically accessing, analyzing, interpreting, processing, and storing both print-based and multimedia material. In a novel

information/entertainment society, immersed in transformative multimedia technology, knowledge and information come not merely in the form of print and words, but through images, sounds, and multimedia material as well. Computer literacy thus also involves the ability to discover and access information and intensified abilities to read, to scan texts and computer data bases and Websites, and to access information and images in a variety of forms, ranging from graphics, to visual images, to audio and video materials, to good old print media. The creation of new multimedia Websites, databases, and texts requires accessing, downloading, and organizing digitized verbal, imagistic, and audio and video material that are the current building blocks of multimedia culture.

Within multimedia computerized culture, visual literacy takes on increased importance. On the whole, computer screens are more graphic, multisensory, and interactive than conventional print fields, and disconcerted many of us when first confronted with the new environments. Icons, windows, mice, and the various clicking, linking, and interaction involved in computer-mediated hypertext dictate new competencies and a dramatic expansion of literacy. Visuality is obviously crucial, compelling users to perceptively scrutinize visual fields, perceive and interact with icons and graphics, and use technical devices like a mouse to access the desired material and field. But tactility is also important, as individuals must learn navigational skills of how to proceed from one field and screen to another, how to negotiate hypertexts and links, and how to move from one program to another if one operates, as most now do, in a window-based computer environment. And as voice and sound enter multimedia culture, refined hearing also becomes part of the esthetics and pedagogies of an expanded computer literacy.

In my conception, computer literacy thus involves technical abilities concerning developing basic typing skills, mastering computer programs, accessing information, and using computer technologies for a variety of purposes ranging from interpersonal communication to artistic expression to political debate and struggle. There are ever more hybrid implosions between media and computer culture as audio and video material becomes part of the internet, as CD-ROMs, DVDs, and multimedia develop, and the evolving technologies become part and parcel of the home, school, and workplace. Therefore, the skills of decoding images, sounds, and spectacle learned in critical media literacy training can also be valuable as part of computer literacy.

Moreover, with ever-expanding internet subcultures and on-line communities, more and more people have the possibilities of participating in cultural production and expression. New web forms of design, such as blogs and wikis,<sup>10</sup> have emerged as important new developments of the Net's hypertextual architecture and provide opportunities for new voices, alternative on-line communities, and political activism (Kahn & Kellner, 2003). Participation in this new cultural and political environment accordingly requires the cultivation of multiple literacies.

#### 4. MULTIMEDIA AND MULTIPLE LITERACIES: THE NEW FRONTIER

The emergent multimedia environments necessitate a diversity of types of multisemiotic and multimodal interaction, involving interfacing with words and print material and often images, graphics, and audio and video material. As technological convergence develops apace, individuals need to combine the skills of critical media literacy with traditional print literacy and new forms of multiple literacies to access, navigate, and participate in the current multimedia hypertext environments. Literacy in this conception involves the abilities to engage effectively in socially constructed emergent and novel forms of culture and communication. Reading and interpreting print was the appropriate mode of literacy for books, while critical multiple literacies entail reading and interpreting discourse, images, spectacle, narratives, and the forms and genres of media culture. Forms of multimedia communication involve print, speech, visuality, and audio, in a hybrid field that combines these forms, all of which involve skills of interpreting and critique.

The term “multiple literacies” points to the many different kinds of always proliferating literacies needed to access, interpret, criticize, and participate in the emergent multimedia forms of culture and society.<sup>11</sup> The key root here is the “multiple”, the proliferation of media and forms that demand a multiplicity of competencies and skills and abilities to access, interact, and help construct a new semiotic terrain. Multiple literacies involve reading across varied and hybrid semiotic fields and being able to critically and hermeneutically process print, graphics, moving images, and sounds. Perpetually multiplying media provide the challenge for multiplying uses, always recreating and reconstructing media forms and practices.

The term “hybridity” suggests the combination and interaction of diverse media and the need to synthesize the various forms in an active process of the construction of meaning. Reading a music video, for instance, involves processing images, music, spectacle, and sometimes narrative in a multisemiotic activity that simultaneously draws on diverse esthetic forms. Interacting with a Website, DVD, or CD-ROM often involves scanning text, graphics, moving images, and clicking onto the fields that one seeks to peruse and explore, looking for appropriate material. This might lead individuals to draw upon a diversity of materials in novel interactive learning or entertainment environments, whereby they must simultaneously read and interpret images, graphics, animation, and text.

While traditional literacies concern practices in contexts that are governed by rules and conventions, the conventions and rules of multiliteracies are currently evolving so that their pedagogies comprise a fresh although bustling and competitive field. Multimedia sites are not entirely new, however. Multisemiotic textuality was first evident in newspapers (consider the difference between *The New York Times* and *U.S.A. Today* in terms of image, text, color graphics, design, and content) and is now evident in textbooks that are much

more visual, graphic, and multimodal than the previously linear and discursive texts of old. But it is CD-ROMs, DVDs, Websites, and new multimedia that are the most distinctively multimodal and multisemiotic forms. These spaces are the new frontier of learning and literacy, the great contemporary challenge to education. Critical educators need to theorize the literacies necessary to interact in these emergent multimedia environments and to gain the skills that will enable individuals to learn, work, and create in emergent cultural spaces and domains.

Cultivating multiple literacies and reconstructing education for democratization will also involve reconstructing traditional pedagogies and social relations. Emergent multimedia technologies enable group projects for students and more of a problem-solving pedagogy in the spirit of Dewey and Freire (1972 and 1998) than traditional transmission top-down teaching models. To enable students to access information, engage in cultural communication and production, and to gain the skills necessary to succeed in the global economy and culture, they need to acquire enhanced literacies, abilities to work cooperatively with others, and to navigate emergent cultural and social terrains. Such group activity may generate more egalitarian relations between teachers and students and more democratic and co-operative social relations. Of course, it also demands reconsideration of grading and testing procedures, rethinking the roles of teacher and student, and constructing projects and pedagogies appropriate to the new cultural and social environments.

Moreover, critical educators are soon going to have to rethink SATs and standard tests in relation to the new media and technologies; having the literacy and skills to successfully access material sought after, communicate, work, and create within computer and multimedia culture is quite different from reading and writing in the mode of print literacy. While traditional skills of reading and writing continue to be of utmost importance in cyberculture, they are sublated within multiliteracy, so eventually an entirely different sort of test is going to need to be devised in order to register individuals' multiple literacy competencies and to predict success in a new technological and educational environment. In this mutating global and technological world, it becomes increasingly irrational to focus education on producing higher test scores on exams that themselves are becoming obsolete and outdated by the changes in the economy, society, and culture.<sup>12</sup>

Critical pedagogies of the future must also confront the issue of on-line education, of how the new cultural terrain of cyberspace produces new sites of information, education, and culture, as well as novel on-line forms of interaction between students and teacher. In addition, possibilities of students developing their own spaces, cultural forms, and modes of interaction and communication should be promoted. The challenge will also arise of how to balance classroom instruction with on-line instruction, as well as sorting out the strengths and limitations of print versus on-line multimedia material (see Feenberg, 1999). Indeed, the emergent ICTs and cultural spaces require



us to rethink education in its entirety, ranging from the role of the teacher, teacher—student relations, classroom instruction, grading and testing, the value and limitations of books, multimedia, and other teaching material, and the goals of education itself.

On-line education and virtual learning also confronts us with novel problems such as copyright and ownership of educational materials; collaborations between computer programmers, artists and designers, and teachers and students in the construction of teaching material and sites; and ascertaining the role of federal and local government, the community, corporations, and private organizations in financing education and providing the skills and tools necessary for a global economy and culture. Furthermore, the technological revolution forces a rethinking of philosophical problems of knowledge, truth, identity, and reality in virtual environments. Both philosophy and philosophy of education must be reconstructed to meet the challenges of democracy and a new hi-tech economy (Kellner, 2003).

Finally, adequately meeting the challenges of ever-multiplying technologies raise the question of design and reconstruction of technology itself. As Feenberg (1991, 1995, 1999) has long argued, democratizing technology often requires its reconstruction and re-visioning by individuals. Within the technology world, “hackers” have redesigned technological systems and much of the internet itself is the result of individuals contributing collective knowledge and making improvements that aid various educational, political, and cultural projects. Of course, there are corporate and technical constraints in that dominant programs impose their rules and constraints on users and the open source movement has challenged users to participate in alternative computer programs and sites, freely providing new innovations, programs, and content of various modes. There has been an on-going struggle within computer world between corporations and users with governments usually intervening on the side of major corporations.

Critical educators, however, should help teach students and themselves to become producers as well as consumers, thus helping to redesign and reconstruct the very forms and programs of computers. There are, of course, restrictions on what those without highly developed technical knowledge can do, but within limits more creative and reconstructive uses of ICTs can be devised and implemented. This leads to some final considerations on the revision and reconstruction of education.

##### 5. RE-VISIONING AND RECONSTRUCTING EDUCATION IN THE CONTEMPORARY ERA

In sum, individuals should be helped to develop the competencies to understand, critique, and transform the social and cultural conditions in which they live, gaining the ability to be creative and transformative subjects and not just

objects of domination and manipulation. This requires developing abilities for critical thinking, reflection, and the capacity to engage in discourse, cultural creation, and political action and movements. Active and engaged subjects are produced in social interaction with others, as well as with tools and techniques, so social skills and individual capacities for communication, creativity, and action must be part of the multiple literacies that a radical reconstruction of education seeks and cultivates.

Crucially, developing multiple literacies and alternative pedagogies must become reflective and critical, aware of the educational, social, and political assumptions involved in the restructuring of education and society currently underway. In response to the excessive hype concerning ICTs and education, it is important to maintain the critical dimension and to reflect upon the nature and effects of new technologies and the pedagogies developed as a response to their challenge. Many advocates of ICTs, however, eschew critique for a purely affirmative agenda. For instance, after an excellent discussion of new modes of literacy and the need to rethink education, Kress (1997) argues that we must move from critique to design, beyond a negative deconstruction to more positive construction. But rather than following such modern logic of either/or, critical pedagogues should pursue the logic of both/and, perceiving design and critique, deconstruction and reconstruction, as complementary and supplementary rather than as antithetical choices. Certainly, we need to design alternative technologies, pedagogies, and curricula for the future, and should attempt to design more democratic and egalitarian social and pedagogical relations as well, but we need to criticize misuse, inappropriate use, overinflated claims, and exclusions and oppressions involved in the introduction of ICTs into education. The critical dimension is needed more than ever as we attempt to develop improved teaching strategies and pedagogy, and design more emancipatory and democratizing technologies and curricula. In this process, we must be constantly critical, practicing critique, and self-criticism, putting in question our assumptions, discourses, and practices, as we experimentally develop novel and alternative literacies and pedagogy (see Kellner, 2003).

In all educational and other experiments, critique is indeed of fundamental importance. From the Deweyan perspective, progressive education involves trial and error, design and criticism. The experimental method itself comprises critique of limitations, failures, and flawed design. In discussing new technologies and multiple literacies, we also need to constantly raise the questions: Whose interests are emergent technologies and pedagogies serving? Are they helping all social groups and individuals? Who is being excluded and why? We also need to raise the question both of the extent to which multiplying technologies and literacies are preparing students and citizens for the present and future and producing conditions for a more vibrant democratic society, or simply reproducing existing inequalities and injustice.

Further, creating multiple literacies must be contextual, engaging the life-world of the students and teachers participating in the new adventures of education. Learning involves developing abilities to interact intelligently with the environment and other people, and calls for vibrant social and conversational environments. Education requires doing and can be gained from practice and social interaction. One can obviously spend too much time with technologies and fail to develop basic social skills and competencies. As Rousseau, Wollstonecraft, and Dewey argued, education involves developing proficiencies that enable individuals to successfully develop within their concrete environments, to learn from practice, and to be able to interact, work, and create in their own societies and cultures. In the dynamically evolving and turbulent global culture, multiple literacies require multicultural literacies. Communicating and interacting with different groups and individuals demands being able to understand and work with a heterogeneity of people and spaces, acquiring literacies in a multiplicity of media and gaining the competencies to participate in a democratic culture and society (see Courts, 1998; Weil, 1998).

From the policy perspective, it seems clear that it is the duty of the federal, state, and local government, as well as other interested parties, to provide the necessary equipment and tools to teachers, students, and schools in order to make it possible for education to cultivate the skills necessary for participation in the emergent global economy, networked society, and cyberculture. Second, it is important that teachers have proper training to make use of the technology in their classrooms and that there are labs with training or support people who have the proper skills and can ensure that teachers and students can effectively deploy the new media and technologies.<sup>13</sup> Recent studies have indicated that without proper teacher training the technology itself will not do the teaching and may be a source of frustration, thus blocking the educational goals desired (see Rawls, 2000; Zimmerman, 2000). Consequently, teacher training and intelligent computer lab design and use, as well as development of more intelligent and user-friendly software, is necessary to improve education in the contemporary era.

But, as I have argued in this paper, teachers and students need to develop new pedagogies and modes of learning in the emergent information and multimedia environment. This could involve a democratization and restructuring of education such as was envisaged by Dewey, Friere, and Illich in which education is seen as a dialogical, democraticizing, and experimental practice. ICTs encourage the sort of experimental and collaborative projects proposed by Dewey (1997 [1916]) as important for progressive education. This could also involve the more dialogical relations between student and teachers envisaged by Freire (1972, 1998) in which teachers learn from students and promote collaborative, dialogical and non-authoritarian teaching methods, and Illich's conceptions of "webs of learning" and "tools for conviviality" (1971 and 1973).

This re-visioning of education involves that recognition that teachers can learn from students and that often students are ahead of teachers in various technological literacies and technical abilities. Many of us (and this is true of myself) have learned much of what we know of computers and new media and technologies from students. We should also recognize to extent to which young people helped invent the internet and have grown up in a cyberculture in which they may have cultivated technological skills from an early age.<sup>14</sup> Peer-to-peer communication among young people is highly sophisticated and developed and democratic pedagogies should build upon and enhance these resources and practices.

One of the challenges of contemporary education is to overcome the disconnect between students experiences, subjectivities, and interests rooted in the emergent multimedia cyberculture in contrast to the classroom situation grounded in print culture and traditional learning and disciplines (see Luke & Luke, 2002). Already in the 1960s, McLuhan (1964) pointed to the disconnect between students raised on radio, television, and popular culture confronted with print materials. Today, the disconnect is even more striking in the contrast between an interactive and multimedia cyberculture and traditional forms of authoritarian lecturing and problematic print materials, thus suggesting a generational divide as well as a digital divide.

The disconnect and divides can be overcome, however, by more actively and collaboratively bringing students into interactive classrooms or learning situations in which they are able to transmit their skills and knowledge to fellow students and teachers alike. Such a democratic and interactive reconstruction of education thus provides the resources for democratic social reconstruction, as well as cultivating the multiple skills and literacies needed for the global economy and cyberculture. So far, arguments for restructuring education mostly come from the hi-tech and corporate sector who are primarily interested in new media and literacies and the reconstruction of education for the workforce and economy. But restructuring can serve the interests of democratization as well as the global economy. Following Dewey, we should accordingly militate for education that is aimed at producing better democratic citizens, as well as providing skills for the workplace and social and cultural life.

Further, to cultivate multiple literacies for democratizing education and society in the contemporary era, we need the Deweyan experimental method of trying out and testing ideas in how computers and new information technology can aid reading, research, and teaching traditional material. This involves trial and error, attempting to discern what works and what does not in using ICTs to democratize and enhance education. Thus, like Dewey, we need to perceive the interconnection of science, technology, education, and democracy in the present conjuncture. To have an enlivened democracy, we must have educated and informed citizens who require training in science and technology, and acquisition of new multiple literacies. Cultivating multiple literacies involves the scientific method of trial and error, seeking collaborative solutions to

problems, and working together to democratically reconstruct education and society. As Dewey noted, this experimental and collaborative method is also the ethos of democracy, which involves dialog, co-operation, and working together, as well as designing and properly using voting machines.<sup>15</sup>

It appears that technology will certainly drive the reconstruction of education, but we should make sure that it works to enhance democracy and empower individuals and not just corporations and a privileged techno-elite. Producing democratic citizens and empowering the next generation for democracy should be a major goal of the reconstruction of education in the present age. Moreover, as Freire reminds us (1972, 1998), critical pedagogy comprises the skills of both reading the word and reading the world. Hence, multiple literacies include not only media and computer literacies, but also a diverse range of social and cultural literacies, ranging from ecoliteracy (e.g., understanding the body and environment) to economic and financial literacy to a variety of other competencies that enable us to live well in our social worlds. Education, at its best, provides the symbolic and cultural capital that empowers people to survive and prosper in an increasingly complex and changing world and the resources to produce a more co-operative, democratic, egalitarian, and just society. Thus, with Plato, Rousseau, Wollstonecraft, Dewey, Freire, and others, I see philosophy of education as reflecting on the good life and the good society and the ways that education can contribute to creating a better world. But as the world changes, so too must education that will be part of the problem or part of the solution as we enter negotiate an ever more precarious and insecure present and future.

The project of transforming education will take different forms in different contexts. In the overdeveloped countries, individuals should be empowered to work and act in a hi-tech information economy, and should learn skills of media and computer literacy to survive in the evolving social environment. Traditional skills of knowledge and critique should also be enhanced, so that individuals can name the system, describe and grasp the changes occurring and the defining features of the emergent global order, and can learn to engage in critical and oppositional practice in the interests of democratization and progressive transformation. This process challenges us to gain vision of how life can be, of alternatives to the present order, and of the necessity of struggle and organization to realize progressive goals. Languages of knowledge and critique must be supplemented by the discourse of hope and praxis.

In much of the world, the struggle for daily existence is paramount and meeting unmet human and social needs is a high priority. Yet everywhere education can provide the competencies and skills to improve one's life, to create a better society, and a more civilized and developed world. Moreover, as the entire world becomes part of a global and networked society, gaining the multiple literacies discussed in this chapter becomes important everywhere as media and cyberculture become more ubiquitous and the world economy demands ever more sophisticated technical skills.

This is a time of challenge and a time for experiment. It is time to put existing pedagogies, practices, and educational philosophies in question and to construct more democratic and progressive ones. It is a time for pedagogical experiments to see what works and what does not work. It is a time to reflect on our goals and to discern what we want to achieve with education and how we can achieve it. Ironically, it is a time to return to classical philosophy of education which situates reflections on education in reflections on the good life and society at the same time that we reflect on how we can transform education to become relevant to a hi-tech society and global economy and culture. It is time to return to John Dewey to rethink that intimate connection between education and democracy at the same time we address the multicultural challenges that Dewey in the midst of a still vital melting pot ideology and liberal progressivist optimism did not address. Most saliently, it is time to take up the Deweyan attitude of pragmatic experimentation to see what it is that the new technologies can and cannot do in order to see how they can enhance education.

In the current turbulent situation of the global restructuring of capitalism and worldwide struggles for democratization, we have a chance to reconstruct education and society. In this conjuncture, technology is a revolutionizing force, whereby all political parties and candidates pay lip service to education, to overcoming the digital divide, and to expanding literacy. The time is ripe to take up the challenge and to move to reconstruct education and society so that groups and individuals excluded from the benefits of the economy, culture, and society may more fully participate and receive opportunities not possible in earlier social constellations.

#### ENDNOTES

1. An earlier and substantially different version of this study appeared in *Educational Theory* (Kellner, 1998) and I am grateful to its editor Nicholas Burbules for helpful criticism and on-going discussion of technology and literacy. Yet another version was presented at UCLA in February 26, 1998 at my Kellner Chair Inaugural Lecture and I thank members of the audience for discussion of the issues developed here. The paper was also presented at the Philosophy of Education Society convention in Toronto on April 1, 2000 and I appreciate this audience for vigorous polemic and to commentator Nicholas Burbules for constructive critique and discussion. I was also able to refine ideas in this paper at the October 2000 Pac-Bell/UCLA conference on information literacy and at the California Association for the Philosophy of Education (CAPE) meetings at UCLA the same month and am also thankful to audiences at these events for constructive commentary and discussion, especially Aimee Dorr and Howard Besser who organized the

Pac-Bell/UCLA conference and participated in CAPE discussions. Later versions were published in a Routledge volume on multiculturalism, edited by George Katsiaficas and Teodros Kiros, and Silicon Literacies, edited by Ilana Snyder (Kellner, 1999; 2002) and I am thankful to the editors for comments and discussions which helped with clarification of my position on multiculturalism and education and on “silicon literacies”. For continuing discussions of the issues in this paper I am especially grateful to Rhonda Hammer, Allan and Carmen Luke, and Richard Kahn.

2. For materials pertaining to the educational reform proposed by Dewey and Freire and the broader conceptions of relating education to creation of the good life and good society advanced by Plato, Rousseau, Wollstonecraft, and others which inform this paper, see my philosophy of education Website, accessible from [www.gseis.ucla.edu/faculty/kellner/kellner.html](http://www.gseis.ucla.edu/faculty/kellner/kellner.html). See also my Education and Technology Website, which contains materials pertinent to this study.
3. Studies reveal that women, minorities, and immigrants now constitute roughly 85% of the growth in the labor force, while these groups represent about 60% of all workers; see Duderstadt (1999–2000: 38). In the 1990s, the number of Hispanics in the United States increased by 35% and Asians by more than 40%. Since 1991, California has had no single ethnic or racial minority and half of the high school students in the state are now African-American or Latino. Meanwhile, a “tidal wave” of children of baby boomers are about to enter college; see Atkinson (1999–2000: 49–50). Obviously, I am writing this study from a U.S. perspective, but would suggest that my arguments have broader reference in an increasingly globalized society marked by a networked economy, increasing migration and multiculturalism, and a proliferating internet-based cyberculture. There is by now a tremendous amount of books and articles on the global economy, technological revolution, new cultural spaces, and the implications for every aspect of life from education to war. See, for example, the monumental studies by Castells (1996, 1997, 1998), and the analyses of the restructuring of capital, technological revolution, and the post-modern turn in Best and Kellner (2001).
4. The “digital divide” has emerged as the buzzword for perceived divisions between information technology have and have nots in the current economy and society. A U.S. Department of Commerce report released in July 1999 claimed that digital divide in relation to race was dramatically escalating and the Clinton administration and media picked up on this theme (See the report “Americans in the Information Age: Falling Through the Net” at <http://www.ntia.doc.gov/ntiahome/digitaldivide/>). A critique of the data involved in the report emerged, claiming that it was outdated; subsequent studies by Stanford University, Cheskin Research, ACNielsen, and the Forester Institute claim that education

and class are more significant factors than race in constructing the divide (see <http://www.clickz.com/stats/big-picture/demographics> for a collection of reports and statistics on the divide; see also <http://nces.ed.gov/pubsearch/pubsinfo.asp?pubid=2004011>). Earlier and more recent research both make clear that there is a gaping division between information technology haves and have nots, that this is a major challenge to developing an egalitarian and democratic society, and that something needs to be done about the problem. My contribution involves the argument that empowering the have nots requires the dissemination of new literacies and thus empowering groups and individuals previously excluded from economic opportunities and socio-political participation.

5. See the Ph.D. dissertations by two of my UCLA students, Rawls (2000) and Zimmerman (2000). See also Bernard Warner, "Computers for Youth: Spreading the Net", *The Standard*, March 27, 2000 which reports: "A study conducted recently by Denver-based Quality Education Data showed school districts across the country spent \$6.7 billion on technology in the 1998–1999 school year, up almost 25% from the previous year. But the same study revealed that an equally crucial funding component—computer training for teachers—was startlingly low, rising just 5.2% over the same period". In June 2000, however, President Bill Clinton argued for increased funding for teaching training to use new technologies so it appears that there is growing recognition of the problem.
6. Freire also stated that: "It is not the media themselves which I criticize, but the way they are used" (1972: 136). Moreover, he argued for the importance of teaching media literacy to empower individuals against manipulation and oppression, and using the most appropriate media to help teach the subject matter in question (114–116).
7. On the novel forms of internet culture and on-line communities, see Kahn and Kellner (2003).
8. For an earlier and expanded discussion of media literacy, see Kellner (1998). Carson and Friedman (1995) contains studies dealing with the use of media to deal with multicultural education. Examples of teaching media literacy which I draw on include Masterman (1985), Kellner and Ryan (1988), Schwoch, White, and Reilly (1992), Fleming (1993), Giroux (1992, 1993, 1994, 1996), Giroux and McLaren (1994), Sholle and Denski (1994), McLaren et al. (1995), Kellner (1995a, b), Luke (1996, 1997a, b), Giroux and Shannon (1997), Potter (1998), Semali and Pailliotet (1999) and Kellner and Share (1995). See also the work of Barry Duncan and the Canadian Association for Media Literacy (Website: <http://www.nald.ca/province/que/litcent/media.htm>) and the Los Angeles based Center for Media Literacy ([www.medialit.org](http://www.medialit.org)). It is a scandal that there are not more efforts to promote media literacy



throughout the school system from K-12 and into the University. Perhaps the ubiquity of computer and multimedia culture will awaken educators and citizens to the importance of developing media literacy to create individuals empowered to intelligently access, read, interpret, and criticize contemporary media and cyberspace.

9. Some early advocates of hypertext attacked the emergence of the World Wide Web as a debased medium which brought back into play the field of earlier media, like television, forcing the word to renegotiate its power against the image and spectacles of sight and sound, once again decentering the written word [see, for instance, Joyce (1995) and the discussion in Landow (1992, 1997); see also their more recent reflections in Snyder (2002)]. As the internet becomes a multimedia hypertext, however, it is clear that contemporary education must teach reading a multimodal hypertext as a basic skill and mode of literacy.
10. On blogs and wikis, see Kahn and Kellner (2003). "Blogs" are hypertextual web logs which people use for new forms of journaling, self-publishing, and media/news-critique. For examples, see our two blogs: BlogLeft: Critical Interventions, <[www.gseis.ucla.edu/courses/ed253a/blogger.php](http://www.gseis.ucla.edu/courses/ed253a/blogger.php)> (accessed November 2005). Vegan Blog: The (Eco)Logical Weblog, <[getvegan.com/blog/blogger.php](http://getvegan.com/blog/blogger.php)> (accessed November 2005). "Wikis" (from the Hawaiian word for "quick") are popular new forms of group databases and hypertextual archives. See [http://en.wikipedia.org/wiki/Main\\_Page](http://en.wikipedia.org/wiki/Main_Page).
11. For other recent conceptions of multimedia literacy that I draw upon here, see the discussions of literacies needed for reading hypertext in Burbules (1997); Burbules and Callister (1996, 2000); the concept of multiliteracy in the New London Group Cazden et al. (1996) and Luke (1997a, b); the papers in Snyder (1997, 2002); Semali and Pailliotet (1999); and books being published in David Barton's Routledge series "literacies" that include Illana Snyder's "silicon literacies", as well as books on "city literacies", "situated literacies", "multiliteracies", and "global literacies and the World Wide Web".
12. On the centrality of preparation for exams in contemporary education and the role of standardized tests in the U.S. educational and social system, see Lemann (1999). While I have not myself researched the policy literature on this issue, in the many discussions of SAT tests and their biases which I have read, I have not encountered critiques that indicate the obsolescence of many standardized tests in a new technological environment and the need to come up with new testing procedures based on the new cultural and social fields that we are increasingly immersed in. I would predict that proposals for devising such tests will emerge and that this issue will be hotly debated and contested in the future.
13. It was at one time encouraging that computers and new technologies were getting into the schools in the U.S. and elsewhere at an impressive rate.

The September 25, 2000 *U.S. News & World Report* notes that in 1994 when President Clinton vowed to connect every school to the information superhighway, only one in three schools, and just 3% of the classrooms, were wired to the internet. But by 1999, according to the National Center for Education Statistics, 95% of schools and 63% of classrooms had internet access. A survey then showed that 76% of the public polled believed that U.S. government should support efforts to train teachers to use new technologies in their classrooms, and that those surveyed said that they saw new technologies and gaining necessary literacies and skills as essential to their own professional and personal advancement, that 71% thought that the internet could enhance their own educational level, while 86% thought that the net could help their children learn more and that 71% claimed that they had gone online for educational reasons—up from 36% when same group was polled in 1999. Yet it is discouraging that the Bush administration has not continued the progressive technology and education policies of the previous administration and has reverted to conservative schooling based on training for tests and centering on traditional forms of literacy and curricula.

14. For instance, Mosaic, Netscape, and the first browsers were invented by young computer users, as were many of the first Websites, list-serves, chat rooms, and so on. A hacker culture emerged that was initially conceptualized as a reconfiguring and improving of computer systems, related to design, system and use, before the term became synonymous with theft and mischief, such as setting loose worms and viruses (see Levy, 1991). On youth and internet subcultures, see Kahn and Kellner (2003).
15. I am, of course, ironically pointing to the non-functioning of voting technology and the system of democracy in the 2000 U.S. Presidential election, suggesting a massive disconnect between the hi-tech economy and cyberculture and traditional voting machines and practices that helped the Bush machine to gain the presidency (see Kellner, 2001).

#### REFERENCES

- Atkinson, R. C. (1999–2000). The future arrives first in California. *Issues in Science and Technology* (Winter), 43–51.
- Best, S. & Kellner, D. (2001). *The Postmodern Adventure*. New York: Guilford Press.
- Burbules, N. C. (1997). Rhetorics of the web: hyperreading and critical literacy in page to screen. In: I. Snyder, (Ed.) *Taking Literacy into the Electronic Era*. New South Wales: Allen and Unwin, 102–122.
- Burbules, N. C. & Callister, T. (1996). Knowledge at the crossroads: some alternative futures of hypertext learning environments. *Educational Theory* 46(1) (Winter), 23–50.
- Burbules, N. C. & Callister, T. (2000). *Watch IT. The Risks and Promises of Information Technology*. Boulder, CO: Westview Press.

- Carson, D. & Friedman, L. D. (1995). *Shared Differences. Multicultural Media & Practical Pedagogy*. Urbana and Chicago: University of Illinois Press.
- Cazden, C., Cope, B., Fairclough, N., Gee, J., Kalantzis, M., Kress, G., Luke, A., Luke, C., Michaels, S., & Nakata, M. (1996). A pedagogy of multiliteracies: designing social futures. *Harvard Educational Review* 66, 60–92.
- Courts, P. L. (1998). *Multicultural Literacies: Dialect, Discourses, and Diversity*. New York: Peter Lang.
- Dewey, J. (1997 [1916]). *Democracy and Education*. New York: Free Press.
- Dines, G. & Humez, J. (Eds.) (1995). *Gender, Race, and Class in Media*. Thousand Oaks, CA and London: Sage.
- Duderstadt, J. J. (1999–2000). New roles for the 21st century university. *Issues in Science and Technology* (Winter): 37–44.
- Feenberg, A. (1991). *Critical Theory of Technology*. New York: Oxford University Press.
- Feenberg, A. (1995). *Alternative Modernity*. Berkeley: University of California Press.
- Feenberg, A. (1999). *Questioning Technology*. New York and London: Routledge.
- Fleming, D. (1993). *Media Teaching*. Oxford: Basil Blackwell.
- Freire, P. (1972). *Pedagogy of the Oppressed*. New York: Herder and Herder.
- Freire, P. (1998). *A Paulo Freire Reader*. New York: Herder and Herder.
- Giroux, H. (1992). *Border Crossing*. New York: Routledge.
- Giroux, H. (1993). *Living Dangerously. Multiculturalism and the Politics of Difference*. New York: Peter Lang.
- Giroux, H. (1994). *Disturbing Pleasures*. New York: Routledge.
- Giroux, H. (1996). *Fugitive Cultures: Race, Violence, and Youth*. New York: Routledge.
- Giroux, H. & McLaren, P. (Eds.) (1994). *Between Borders. Pedagogy and the Politics of Cultural Studies*. New York: Routledge.
- Giroux, H. & Shannon, P. (1997). *Education and Cultural Studies*. London and New York: Routledge.
- Illich, I. (1971). *Deschooling Society*. New York: Harper and Row.
- Illich, I. (1973). *Tools for Conviviality*. New York: Harper and Row.
- Illich, I. & Sanders, B. (1988). *ABC: The Alphabetization of the Popular Mind*. San Francisco: North Point Press.
- Joyce, M. (1995). *Of Two Minds: Hypertext Pedagogy and Politics*. Ann Arbor: University of Michigan Press.
- Kahn, R. & Kellner, D. (2003). Internet subcultures and oppositional politics. In: Muggleton, D. (Ed.) *The Post-subcultures Reader*, London: Berg.
- Kellner, D. (1995a). *Media Culture*. London and New York: Routledge.
- Kellner, D. (1995b). Cultural studies, multiculturalism, and media culture. In: Dines and Humez 1995, 5–17.
- Kellner, D. (1998). Multiple literacies and critical pedagogy in a multicultural society. *Educational Theory* 48(1), 103–122.
- Kellner, D. (1999). Multiple literacies and critical pedagogy in a multicultural society. In: Katsiaficas, G. and Kiros, T. (Eds.) *The Promise of Multiculturalism*. New York and London: Routledge, 211–236.
- Kellner, D. (2000). Globalization and new social movements: lessons for critical theory and pedagogy. In: Burbules, N. and Torres, C. (Eds.) *Globalization and Education*. New York: Routledge.
- Kellner, D. (2003). Toward a critical theory of education. *Democracy and Nature* 9(1) (March): 51–64.
- Kellner, D. & Jeff, S. (2005). Toward critical media literacy: core concepts, debates, organization, and policy. *Discourse: Studies in the Cultural Politics of Education* 26(3), 369–386.

- Kellner, D. & Ryan, M. (1988). *Camera Politica: The Politics and Ideology of Contemporary Hollywood Film*. Bloomington, IN: Indiana University Press.
- Kress, G. (1997). Visual and verbal modes of representation in electronically mediated communication: the potentials of new forms of text. In: Snyder, I. (Ed.) *Page to Screen: Taking Literacy into the Electronic Era*. New South Wales: Allen and Unwin, 53–79.
- Landow, G. (1992). *Hypertext. The Convergence of Contemporary Critical Theory and Technology*, 2nd ed. Baltimore and London: Johns Hopkins University Press; *Hypertext 2.0* (1997).
- Lemann, N. (1999). *The Big Test: The Secret History of the American Meritocracy*. New York: Farrar Straus & Giroux.
- Luke, C. (1996). Reading gender and culture in media discourses and texts. In: Bull, G. and Anstey, M. (Eds.) *The Literacy Lexicon*. New York and Sydney: Prentice-Hall.
- Luke, C. (1997a). *Technological Literacy*. Melbourne: National Languages & Literacy Institute, Adult Literacy Network.
- Luke, C. (1997b). Media literacy and cultural studies. In: Muspratt, S., Luke, A., and Freebody, P. (Eds.) *Constructing Critical Literacies*, Cresskill, NY: Hampton Press, 19–50.
- Luke, A. & Luke, C. (2002). Adolescence lost/childhood regained: on early intervention and the emergence of the techno-subject. *Journal of Early Childhood Literacy* 1(1), 91–120.
- Masterman, L. (1989 [1985]). *Teaching the Media*. London and New York: Routledge.
- McLaren, P., Hammer, R. Sholle, D., & Reilly, S. (1995). *Rethinking Media Literacy. A Critical Pedagogy of Representation*. New York: Peter Lang.
- McLuhan, M. (1962). *The Gutenberg Galaxy*. New York: Signet Books.
- McLuhan, M. (1964). *Understanding Media: The Extensions of Man*. New York: Signet Books.
- Ong, W. (1988). *Orality and Literacy: The Technologizing of the Word*. London and New York: Routledge.
- Postman, N. (1985). *Amusing Ourselves to Death*. New York: Viking-Penguin.
- Postman, N. (1992). *Technopolis: The Surrender of Culture to Technology*. New York: Random House.
- Rawls, J. J. (2000). The role of micropolitics in school-site technology efforts: a case study of the relationship between teachers and the technology movement at their school. Ph.D. Dissertation, UCLA.
- Semali, L. & Pailliotet, A. W. (1999). *Intermediality*. Boulder, CO: Westview.
- Schwoch, J., White, M., & Reilly, S. (1992). *Media Knowledge*. Albany: State University of New York Press.
- Sholle, D. & Denski, S. (1994). *Media Education and the (Re)Production of Culture*. Westport, CT: Bergin & Garvey.
- Snyder, I. (1996). *Hypertext: The Electronic Labyrinth*. Melbourne and New York: Melbourne University Press and New York University Press.
- Snyder, I. (Ed.) (1997). *Page to Screen: Taking Literacy into the Electronic Era*. New South Wales: Allen and Unwin.
- Snyder, I. (Ed.) (2002). *Silicon Literacies*. London and New York: Routledge.
- Webster, F. (1995). *Theories of the Information Society*. London and New York: Routledge.
- Weil, D. K. (1998). *Toward a Critical Multicultural Literacy*. New York: Peter Lang.
- Wollstonecraft, M. (1988). *A Vindication of the Rights of Woman*. New York: Norton.
- Zimmerman, R. (2000). The intersection of technology and teachers: challenges and problems. Ph.D. Dissertation, UCLA.

## Chapter 10: Cyberpedagogy

CARMEN LUKE

*Centre for Critical and Cultural Studies,  
University of Queensland, Australia*

### 1. INTRODUCTION

In the last two decades, everyday life in post-industrial societies has shifted from a wired to an increasingly wireless world. Cell phones have given us a new kind of mobility and freedom to send messages or talk to anyone from anywhere, to check our e-mail, access the web, or locate others by activating global tracking systems. Online shopping, banking, entertainment and travel reservations, and educational courses—they are all just a click away whether on the wired or wireless keyboard or cell phone touchpad. Anyone, anywhere, can now communicate and access information as long as the user has a computer and access codes to wireless networks (WLAN), or a modem, electricity and a cable or phone line which, needless to say, excludes two-thirds of the world's population. In the brave new digital world, everyone is said to have access to more information than ever before, which many ICT enthusiasts herald as the democratization of knowledge and information. Interactivity has broken the tyranny of the passive user (whether of magazines, books, or TV), as the cyberspace is now in charge of when and what is viewed and read. Connectivity has broken the tyranny of distance and time as instant electronic access to information and people located anywhere around the globe shrinks time and space. ATMs, internet, and phone banking have liberated us from the drudgery and “time waste” of banking queues. Online education courses enable students any time and from anywhere to log on and move through menued choices at their own pace and leisure. Wired or wireless—our everyday routines, social relations, cultural activities, and frames of reference have been irrevocably changed by digital technologies and global connectivity.

### 2. MULTIMODAL MULTILITERACIES

In the midst of all this, educators have tried to come to terms with the contradictions between industrial model schooling based on static print/book culture and competitive individualism, and the collaborative learning possibilities and deterritorialized meaning-making and knowledge configurations enabled by new technologies. Digital technologies have remediated traditional text genres and forms (Bolter, 2002; Bolter & Grusin, 2000), and have given us a new

kind of immediacy (e-mail and chat; www shopping, searches or e-ticketing; virtual reality, webcams, etc.). When learning is no longer geographically tied to a desk, the school library, the book, or the teacher who demands “all eyes up front”, then old-style transmission and surveillance pedagogy is destabilized and increasingly unworkable. Throughout the last decade, notions of a singular print-based literacy have been reconceptualized into hyphenated or multiple literacies that acknowledge the diversity of information sources and media that people access, negotiate, and redeploy in everyday contexts.

Partially influenced by constructivist theories of learning and pedagogy (Bruner, 1990; Vygotsky, 1978), and post-structuralist theories of knowledge as socially constructed, critical educational theorists have been arguing for the need to reconceptualize traditional teaching and learning relations in light of technologically mediated access to and relations with knowledge that have changed literacy practices and produced new kinds of social relations among learners/students in their engagements with IT (Snyder, 2002). A social constructivist view of knowledge and learning implies that learning occurs in situated sociocultural contexts and that knowledge is apprehended and appropriated in social interaction, dialogue, negotiation, and contestation. In the contemporary blend of “old” and “new” information environments, learning and information exchange or knowledge production occur in socially interactive communities as people draw on diverse sources of information, modes of communication, and (virtual) community engagements. Solitary and silent desk-bound (or library-bound) reading and writing, pencil and paper testing are being replaced by interactive group work around, with and “through” the computer interface.

In turn, collaborative and constructivist theories of pedagogy and learning complement emerging interest in problem-based learning (Savin-Baden, 2000) seen as more responsive to the diverse experiences and background knowledge of students, and able to provide “richer” and more “authentic” situated learning experiences that demand interdisciplinary thinking and learning. Together, collaborative, constructivist, and problem-based learning is a powerful conceptual antidote to pedagogy as transmission, and knowledge as parceled facts and objects. Instead, knowledge acquisition and production are seen as process, as design, as contextual, situational, and contestable. That is to say, the joint formulation of a solution to a problem is necessarily a design process—a process of harnessing diverse information “bits” into new relations in response to the situated context of a given problem. This locates knowledge and learning, rather than technology, at the center of pedagogy. Knowledge as design implies and much more adequately describes the intrinsic relational aspects of knowledge, the mix-and-match characteristics of hybrid, intertextual, and multimodal knowledge and communication exchanges, and the inherent transformative nature of all knowledge as people apprehend, use, contest or reproduce it in situated contexts.

### 3. READING, WRITING, CONNECTING

As more texts become available in digital form, users are forced to access information in different ways that have profound ramifications for reading and writing. Although the fundamental principles of reading and writing have not changed, the process has shifted from the serial cognitive processing of linear print text to parallel processing of multimodal text-image information sources. Longhand pencil and paper writing has been replaced by keyboarding and, increasingly, iconic writing (button clicks). Text and meaning are no longer embedded exclusively in a linear sequence of alphabetic characters combined in a “logical” sequence of phrase, sentence, paragraph, and narrative units dictated by author intent or formatting demands of a page or book. Instead, hypertext embeds text-image and (potential) meaning in a web-like pattern of links that readers can pursue or ignore. The hypertext author designs an “editorial” structure of potential meanings through links, but readers too structure their own transitions from one part of the text to another, moving from one set of emerging meanings to another (Kaplan, 2000). The process of the link pathways chosen and those passed by demands a particular kind of reading, a cognitive mapping and pathway navigation that is radically different from the relatively choice less linearity of book-based print.

Yet hypertext reading is also hypertext viewing of the semiotic cartography of software interfaces, graphics, link patterns, images, color, and sound. The cultural discourses subtending these symbols, images, and metaphors are extra-textual yet an integral component of an emerging “grammar” of knowledge and communication that students are enculturated into from an early age through electronic story books, games, and toys (Holloway & Valentine, 2000; Luke, 1999). Since students not only learn important social and cultural lessons from such texts and objects, but reshape and re-incorporate them into their own play, social relations, and (hyper)textual productions, it thus seems crucial that students develop a critical understanding of the cultural stories they consume and produce. Arguably, then, the need for a critical ICT literacy is as important in the use and study of new media as it is of “old” (broadcast) media (Johnson-Eilola, 1997; Luke, 2002).

Having grown up in a world of connectivity and immediacy, of “digital fun and games” (Nixon, 1998), children’s entry into knowledge-in-boxes curriculum, into disciplined “on task” cognition and a school culture of hyperindividualism and “deferred gratification” (e.g., “testing”, grades) can create the kind of generational divide that Green and Bigum (1993) have referred to as “aliens in the classroom”. Students see their teachers as aliens from another time: trained in the culture of the book, monologic literacy, specialists in one disciplinary content area, and many struggling with the new technologies. Teachers, in turn, see today’s students as alien digi-kids—wired and plugged in, speaking a “foreign language” of ICT acronyms and insider technical

know-how. Connectivity invokes clichés of a borderless world and in that immaterial “white” space there is a new sense of spatiality that defies the sorts of modernist understandings of knowledge, of place, of sociality that is so foundational to our own schooling experience and the normative social science and teacher training most of us underwent at some time in the last several decades.

Offline–online distinctions are increasingly untenable in relation to young people’s use of ICTs and in terms of media convergence. Today’s youngster is a savvy citizen of the digital age. She has seen *Harry Potter* the movie, read the book, has the DVD and several *Potter* e-toys, and Hogwarts mosey across the screensaver on her personal digital assistant (PDA). Perhaps for adults, going “online” to do the banking or a bit of web browsing is something that happens, say, in the study, after a “real” social event like the family dinner. For kids who have grown up with Walkman, Gameboy, cell phones, kiddie PDAs, internet, and console gaming, “real life” is online. Net, TV, and radio can be accessed while doing e-mail on one screen, chat on another, and text messaging on the cell phone. Magazines emulate webpage layouts, most are accessible online, and product advertisements whether on the subway, billboard, or TV provide the ubiquitous dot.com website of the product or service. Information, ideas, cultural icons, social connections cross-reference, and flow into one another in an intertextual multimedia and multimodal network in which (middle class) kids’ experience and knowledge of the world, their identities, literacy practices, and learning are largely shaped.

Industrial-era collection code curriculum delivered through chalk-and-talk pedagogy measured academic outcomes and success on the accumulation and reproduction of isolated facts in discrete content area domains. In digitalized knowledge and networked environments, an understanding of the relations among ideas is as if not more important than mastery of the bare facts. The conceptual shift here is one from *collection* to *connection*. Thinking laterally across associations, developing a meta-awareness of the links or paths taken and those passed over, backtracking along paths, reading and viewing mix-and-match old and new blended media genres and forms—these are the very rhizomatic conceptual and cognitive maps required to read through and think through localized branchings of larger global knowledge units (disciplinary or otherwise). Thinking across associations, accessing, and integrating knowledge laterally are the very cognitive, socially situated repertoires we use to negotiate everyday life and are core requirements for hypertext navigation. In that regard, hypertext’s multimedia and multimodal interface and gateways to laterally connected and further embedded information sources and/or knowledge domains comes much closer to an authentic representation of the interdisciplinarity, connectedness, and multimodality (Kress & Van Leeuwen, 2001) of knowledge as we experience and enact it in the contexts of everyday life.



Since all meaning is situated relationally—connected and cross-referenced to other genres, media and related meanings in other social and cultural contexts—an intertextual understanding of how meanings shift across media, genres, and cultural frames of reference is crucial. Meaning-making from the multiple linguistic, audio, and symbolic visual graphics of hypertext means that the cyberspace navigator must draw on a meta-knowledge of traditional and newly blended genres or representational conventions, cultural, and symbolic codes, as well as linguistically coded and software driven meanings. The dynamics of lateral and cross-linked information of hypertext requires and generates a cognitive orientation akin to what is often termed lateral thinking—the very skills many educators aim to instill in students. That is to say, instead of learning and thinking “vertically”—deductively or inductively—within the root structures of disciplinary boxes, connectivity and hypertext environments demand horizontal or lateral cognitive mobility across disciplines, genres, modalities and, indeed, cultural zones. The global cross-cultural information flow on the internet and the global composition of many virtual communities (whether chat, gaming, special interest, or classroom communities) requires new ways of thinking about transcultural communication: our “readings” of and interaction with others from culturally diverse backgrounds. Intertextuality, transcultural communication, metamedia (Lemke, 1998), multimedia or “intermediality” (Semali, 1999), and multimodal multiliteracy (Luke, 2000) are features of the “new communicative order” (Kress & van Leeuwen, 1996; Snyder, 2001) in which young people’s orientations to “life online”, information, knowledge, learning and communication, time and space, are shaped.

#### 4. PEDAGOGY

In just two decades educational wisdom has shifted from 1980s assumptions about the need for a computer in every classroom, in the early 1990s to have a computer on every students’ desk, by the late 1990s to have every classroom wired and every computer network capable, and today to plan for the wireless school. We know now that students prefer collaborating around the screen, problem solving, and information sharing as a group rather than working individually in isolation (Bruce, 2002; Holloway & Valentine, 2000). The social group habits that kids establish during the years of out-of-school console or web-based gaming and “play” have been transposed into the classroom and they engage with screen-based information and learn in very different ways that involve risk and play: “let’s click here and see what happens” or “playing around” with MP3s, identities, digital scanners, or cameras (cf. Beavis, 1997). What, then, might a “cyberpedagogy” based on collaborative and constructivist learning principles look like?

Too often collaborative learning may merely mean co-operative learning as in a group task. Collaborative learning by contrast implies not only

co-operative group work but, importantly, aims to develop students' mastery (or meta-awareness) over their own learning skills and styles. This self-reflective understanding of one's learning, in turn, informs collaboration with others (via face to face, chat, bulletin boards, or e-mail) to (dis)confirm if one is on the right track in terms of situational understanding, meaning-making, design of new knowledge, and perceptions of multiple problem-solving options. Collaboration is about "sound checks" on one's learning and understanding in the context of peers, and in consultation with and guided by the teacher or instructor. In higher education contexts, however, where courses are often exclusively online without real-time face-to-face contact with instructors, the disadvantages are that there is no guided "instructional conversation", no mediating "authority" or expert to pull a group back on track, or to suggest alternatives. In totally unmediated online groups, students often find that some are doing all the work while others only marginally contribute which can create interpersonal and intragroup tensions and conflicts that militate against the very principles of a collaborative and co-operative learning environment. Moreover, when communication is solely via chat, bulletin boards (e.g., WebCT), or e-mail, replies from other students or an instructor may take days and discussions languish because members fail to log in. Clearly, a balance between face-to-face real time and online learning encounters is optimal.

Despite common fears among educators of the demise of the teacher role in the face of a rapid and global rollout of e-education programs, courses, and software, IT is but one resource among a platform of critical, learner-centered, constructivist, and collaborative pedagogy. Teachers are an indispensable component in this mix. Their role as mediators, as tele-guides and mentors, as craft experts with specialized expertise who induct new learners into communities of practice is as central as is their role in shaping and supporting pedagogies that assist and immerse student learning in authentic and relevant activities. High-tech and visually seductive webpages, courseware, and graphic interfaces are no substitute for teachers' specialized expertise at scaffolding learning, working with and alongside groups around the screen, engaging students through probing, guiding, and prompting, simplifying or expanding a concept or approach, and ensuring a productive, cultural, and ability inclusive real-time and online environment. Teachers and curriculum, "old" media and "new" media resources, parents and other community stakeholders, academic or community experts, together constitute the broader platform of mixed resources on which learners draw and which collectively shapes students' intellectual growth and learning environments.

Yet despite general agreement among many educators over the "fit" between constructivist approaches to learning and the new ICTs, we still find ourselves in an historical moment where institutional infrastructures, teacher skills, student access to and facility with ICTs are uneven. Moreover, given that K-12 and higher education sectors remain immersed in residual book-print culture along with a very powerful legacy of teacher centered pedagogy, and a

psychologized and individualized model of learning, assessment, and achievement, many educators have become experts at bricolage pedagogy. Teachers are grafting “new” onto “old” models of learning and teaching, trying out innovative pedagogies while also answering state or federally mandated calls for outcomes-based instruction, individualized assessment, and grades. And yet, in this current backwash of rapid ICT innovation, wired into bricks and mortar educational paradigms, teachers nonetheless have been constructing innovative hybrid pedagogies in the cracks between industrial model schooling and cyberschooling (Bruce, 2002; Chris Bigum, 2001; Hawisher & Seife, 2000; Windschitl & Sahl, 2002). Whether teachers incrementally develop a more collaborative and student-centered pedagogy as a result of the introduction of IT into classrooms, or whether teachers’ established pedagogical knowledge and philosophy are grafted onto technology remains unclear. What is certain is that teachers’ attitudes toward and uses of technology and pedagogical change remain uneven and variable (Bigum et al., 1997; Meredyth et al., 1999; Windschitl & Sahl, 2002).

Some studies have suggested that the more adept teachers become with technology over time, the more likely they will reshape their orientation toward a more constructivist pedagogy (Becker & Ravitz, 1999; Mehlinger, 1996; Schofield, 1995). Yet as Windschitl and Sahl (2002) found in their study of instructional change among teachers in a laptop school, availability of technology in and of itself does not appear to “initiate teachers’ movements toward constructivist pedagogy” (p. 198). The re-shaping of teacher practice seems to depend on the variable intersections between teachers’ attitudes and beliefs about IT and pedagogy, and a host of contextual and situational factors such as the extent to which teachers use technology in out-of-school settings, the kinds of technologies available in schools, levels of technical support, access to ongoing professional development, and levels of collaborative and collegial relations among teachers.

#### CONCLUDING COMMENT

Although hypertext and the internet are placeless and “immaterial” in a literal sense, the user–reader–viewer interacts with the interface to the virtual from an embodied space, a material place (home, school, office), reads and writes in real time. The materiality of interaction among teachers and students at and through the screen requires a new way of looking at the temporal and spatial presence in the disembodied and immaterial spaces of flows. So, on one hand the importance of old-style ethnographic studies of real bodies in real-time connected to new forms of immaterial but nonetheless “real” spatialities located *within institutionalized educational contexts* remains crucial. On the other hand, the bigger challenge is to devise flexible and innovative analytic tools with which to track the fluidity and mobility of “travel” across the

semioscape of links, knowledge fields, webpages, chat rooms, e-mail routes, intersubjective and intercultural relationships, and so on. Capturing the idea and practices of mobility and flows—of the subject’s circuits and trajectories, semantic-semiotic production and consumption—across the internet’s global terrain of signification which operates in real time but nearly instantaneously and yet “never stops” (Jordan, 1999), is probably at present beyond what electronic transcript analysis, interview, observational or survey data, electronic site logging, or even critical discourse analysis can reveal. As Burbules (2001) has argued, learning with and on the web is not just about information access, retrieval or even critical hyperreading. Rather, we should conceptualize “learning in the context of the web as the achievement of a certain kind of *mobility* . . . to move within . . . across . . . against the pathways that seem to determine users’ options for navigation and for meaning-making” (p. 83). The challenge for educational theorizing and research, then, is to devise a flexible conceptual and methodological mix based on an equally flexible, indeed provisional and transformational, epistemology with which to capture the dynamics of mobility and “travel” across media, modalities, information nodes, communities, link pathways, and networks which demand and generate new kinds of learning, (meta)cognitive routing, multisemiotic literacy, identity construction and performance, community ethics, and sociality.

#### REFERENCES

- Beavis, C. (1997). Computer games, culture and curriculum. In: Snyder, I. (Ed.) *Page to screen*. Sydney: Allen & Unwin, 234–255.
- Becker, H. & Ravitz, J. (1999). The influence of computer and Internet use on teachers’ pedagogical practices and perceptions. *Journal of Research on Computing in Education* 31(4), 356–385.
- Bigum, C. (2001). Design sensibilities, schools and new computing and communication technologies. In: Said, E. (Ed.) *Silicon Literacies: Communication, Innovation and Education in the Electronic Age*. New York, London: Routledge, 130–140.
- Bigum, C., Durrant, C., Green, B., Honan, E., Lankshear, C., Morgan, W., Snyder, I. & Wild, M. (1997). *Digital Rhetorics: Literacies and Technologies in Education—Current Practices and Future Directions*. Canberra: Department of Employment, Education, Training and Youth Affairs.
- Bolter, J. D. (2002). Formal analysis and cultural critique in digital media theory. *Convergence* 8(4), 77–88.
- Bolter, J. D. & Grusin, R. (2000). *Remediation: Understanding New Media*. Cambridge, MA: MIT Press.
- Bruce, B. (2002). Diversity and critical social engagement: how changing technologies enable new modes of literacy in changing circumstances. In: Alverman, D. (Ed.) *Adolescents and Literacies in a Digital World*. New York: Peter Lang, 1–18.
- Bruner, J. (1990). *Acts of meaning*. Cambridge, MA: Harvard University Press.
- Burbules, N. (2001). The web as a rhetorical place. In: Snyder, I. (Ed.) *Silicon Literacies: Communication, Innovation and Education in the Electronic Age*. New York, London: Routledge, 75–84.

- Green, B. & Bigum, C. (1993). Aliens in the classroom. *Australian Journal of Education* 37(2), 1119–1141.
- Hawisher, G. & Seife, C. (Eds.) (2000). *Global Literacies and the World Wide Web*. New York, London: Routledge.
- Holloway, S. L. & Valentine, G. (Eds.) (2000). *Children's Geographies: Playing, Living, Learning*. London: Routledge.
- Johnson-Eilola, J. (1997). Living on the surface: learning in the age of global communication networks. In: Snyder, I. (Ed.) *Page to Screen*. Sydney: Allen & Unwin.
- Jordan, T. (Ed.) (1999). *Cyberpower: The Culture and Politics of Cyberspace and the Internet*. New York, London: Routledge.
- Kaplan, N. (2000). Literacy beyond books. In: Herman, A. and Swiss, T. (Eds.) *The World Wide Web and Contemporary Cultural Theory*. New York, London: Routledge, 207–234.
- Kress, G. & van Leeuwen, T. (1996). *Reading images: The Grammar of Visual Design*. New York, London: Routledge.
- Kress, G. & Van Leeuwen, T. (2001). *Multimodal Discourse: The Modes and Media of Contemporary Communication*. London: Arnold.
- Lemke, J. (1998). Metamedia literacy: transforming meanings and media. In: Reinking, D., McKenna, M., Labbo, L., and Kieffer, R. (Eds.) *Handbook of Literacy and Technology: Transformations in a Post-Typographic age*. Mahwah, NJ: Lawrence Erlbaum.
- Luke, C. (1999). What next? Toddler netizens, playstation thumb, techno-literacies. *Contemporary Issues in Early Childhood* 1(1), 95–100 [www.triangle.co.uk/ciec].
- Luke, C. (2000). Cyber-schooling and technological change: multiliteracies for new times. In: Cope, B. and Kalantzis, M. (Eds.) *Multiliteracies: Literacy Learning and the Design of Social Futures*. Melbourne: Macmillan, 69–91.
- Luke, C. (2002). Re-crafting media and ICT literacies. In: Alverman, D. (Ed.) *Adolescents and Literacies in a Digital World*. New York: Peter Lang, 132–146.
- Mehlinger, H. D. (1996). School reform in the information age. *Phi Delta Kappan* 77(6), 400–407.
- Meredyth, D., Russell, N., Blackwood, L., Thomas, J., & Wise, P. (1999). *Real time: Computers, Change and Schooling*. Canberra: Department of Education, Training and Youth Affairs.
- Nixon, H. (1998). Fun and games are serious business. In: Sefton-Green, J. (Ed.) *Digital Diversions: Youth Culture in the Age of the Multi-Media*. London: UCL Press, 21–43.
- Savin-Baden, M. (2000). *Problem-based Learning in Higher Education: Untold stories*. Buckingham, UK: Open University Press.
- Schofield, J. (1995). *Computers and Classroom Culture*. New York: Cambridge University Press.
- Semali, L. W. P. A. (Ed.) (1999). *Intermediality: A Teacher's Handbook of Critical Media Literacy*. Boulder, CO: Westview.
- Snyder, I. (2001). The new communication order. In: Durrant, C. and Beavis, C. (Eds.) *P(ICT)ures of English: Teachers, Learners and Technology*. Melbourne: Wakefield Press, 111–124.
- Snyder, I. (Ed.) (2002). *Silicon Literacies: Communication, Innovation and Education in the Electronic Age*. London, New York: Routledge.
- Vygotsky, L. S. (1978). *Mind in Society: The Development of Higher Psychological Processes*. Cambridge, MA: Harvard University Press.
- Windschitl, M. & Sahl, K. (2002). Tracing teachers' use of technology in a laptop computer school: the interplay of teacher beliefs, social dynamics, and institutional culture. *American Educational Research Journal* 39(1), 165–206.

# Chapter 11: Re-situating Constructionism

JOHN W. MAXWELL

*Centre for the Study of Curriculum and Instruction, University of British Columbia,  
Vancouver, BC, Canada*

## 1. INTRODUCTION

Over the past few decades, much has been written and said about the use of computers in education. But despite the incredible advances in computing power and software sophistication in that time, the application and integration of technology in educational settings have remained confused and troublesome for many educators. For all the energy expended in creating and marketing computing technologies, the ways in which educators have used technology in teaching and learning have developed little over the past 20 years. While there are certainly more computers in classrooms today than ever before, the “big ideas” that shape how we interpret and use these technologies have been few and far between.

One of these “big ideas” is the school of thought called *constructionism*, which emerged from the Epistemology and Learning Group at the MIT Media Lab in the 1980s. Constructionist theorists hold that learning happens best when children are engaged in creating personally meaningful objects and sharing them with their peers. Probably, its most famous manifestation has been the Media Lab’s work with children and the Logo programming language. The computer was seen as an expressive tool that allowed children to manipulate objects (the Logo “turtle” is the classic example) in a computer “microworld”, and through exploration and reflection to come to more formal understandings of relationships, say, in geometry. The constructionist researchers saw educational technology in the sense of “objects to think with” that facilitate novel ways of thinking.

Since the Logo research of the 1980s, the world of computers and high technology has seen enormous—if not revolutionary—change. The personal computer has become an integral part of how most people communicate, work, write, learn, and play. The advent of global networks and ubiquitous connectivity has caused us to consider computing technology as a mass medium alongside television and the press. The emergence of the “information economy” and e-commerce spawned a new period of economic growth—one that has looked at times like a gold rush. But this incredible social transformation brings with it much confusion about what’s really going on, where things are really heading, and what will really be important over the long run. A casualty of this confusion has been, I believe, the field of educational technology,

which is sorely fragmented and insecure today. This is not surprising, for how can we hope to understand educational technology when our understanding of technology itself is constantly being challenged?

I believe that it is worthwhile to re-examine constructionism as a guiding philosophy in educational technology in the light of some significant recent contributions in the fields of situated learning, media theory, and science and technology studies. My aim here is to re-situate constructionism within contemporary thought as a way of re-defining its relevance to the integration of education and technology today.

This chapter is in three parts. In the first, I will examine the literature on situated learning, situated cognition, and ecologies of knowledge. In the second, I will explore some significant contributions to thinking about media, science, and technology. In the third and final part, I will focus on the literature of constructionism itself, from the early 1980s to current works, and attempt to trace some trends in the thinking around it. Ultimately, I will attempt to elaborate an *ecological* approach to understanding educational technology and educational media, an approach that brings together the three areas covered in this chapter. By ecology, I mean a dynamic, evolving system in which actor and environment are inseparable and mutually constitutive, in which both people and cultural artifacts are considered, and in which responsibilities and ethics are emergent and situated. In looking for these qualities in approaches to knowledge, culture, learning, and technology, I believe, we can begin to develop a critical stance with respect to a confusing world.

## 2. SITUATED LEARNING AND ECOLOGIES OF KNOWLEDGE

A good place to begin the examination of situated learning is an article by Brown et al. (1996 [1989]) called “Situated Cognition and the Culture or Learning”. This article, which largely introduced the concepts and vocabulary of situated cognition to the educational community, expressed the authors’ concern with the limits to which “conceptual knowledge can be abstracted from the situations in which it is situated and learned” (Brown et al., 1996: 19)—as is common practice in classrooms. Building upon the experiential emphasis of pragmatist thinkers like John Dewey and on the social contexts of learning of Russian activity theorists like Vygotsky and Leontiev, Brown and his colleagues proposed the notion of “cognitive apprenticeship”. In a cognitive apprenticeship model, knowledge and learning are seen as situated in practice

The activity in which knowledge is developed and deployed, it is now argued, is not separable from or ancillary to learning and cognition. Not is it neutral. Rather, it is an integral part of what is learned. Situations

might be said to co-produce knowledge through activity. Learning and cognition, it is now possible to argue, are fundamentally situated. (p. 20)

Cognitive apprenticeship takes as its model the “evidently successful” (p. 22) authentic activities of craft apprenticeship, and extends it to include the kinds of cognitive-domain learning that one might find in a mathematics classroom. Brown, Collins, and Duguid explore several examples from mathematics education in which the apprenticeship model has been applied to “thinking mathematically” in a variety of authentic and situated contexts. Brown and his colleagues go on to argue that all knowledge is like language in that it is “indexical”. Indexicality in language is seen in pronouns, articles, and dependent references, where the meaning of an utterance is very directly linked to the context of the discourse, as in the statement, “I will be here tomorrow”. Extending this notion to knowledge itself, Brown suggests: “its constituent parts index the world and so are inextricably a product of the activity and situations in which they are produced” (p. 22). This idea is carried forward to an examination of tools and the way in which they are learned and used

Learning how to use a tool involves far more than can be accounted for in any set of explicit rules. The occasions and conditions for use arise directly out of the context of activities of each community that uses the tool, framed by the way members of each community see the world. The community and its viewpoint, quite as much as the tool itself, determine how a tool is used. (p. 23)

Brown is thus critical of the de-contextualized quality of classroom learning—or rather, its artificially contextualized nature, since classroom activity is of course situated within the social and cultural context of the school. But this is significantly distant from the way actual practitioners of math, science, history, and so on work. The assumption underlying traditional classroom teaching is that abstracted conceptual representations are self-sufficient as an approach to knowledge. Brown, Collins, and Duguid challenge this assumption at its root:

A theory of situated cognition suggests that activity and perception are importantly and epistemologically prior—at a nonconceptual level—to conceptualization and that it is on them that more attention needs to be focused. (p. 42)

This phenomenological stance is significant. Brown, a cognitive scientist at Xerox PARC, was undoubtedly influenced at the time by trends in computing and artificial intelligence (AI) research—trends that pointed to a de-centered, situated view of cognition, in contrast to the rationalist, representational focus



of previous decades. Two important books appeared in the late 1980s that describe the AI community's movement away from a cognitive model that is based on internal representations of external reality: Winograd and Flores' *Understanding Computers and Cognition*, and Suchman's *Plans and Situated Actions*.

In *Understanding Computers and Cognition: A New Foundation for Design*, Winograd and Flores (1986) attempt to orient the field of AI research and intelligent systems design in a new direction. Instead of a rationalist, rules-based computational model of mind, Winograd and Flores take a de-centered and situated approach. Winograd and Flores draw on the phenomenological thinking of Martin Heidegger, the biology of perception work of Humberto Maturana and Francisco Varela, and the speech-act theory of philosophers John Austin and John Searle. These influences lead them to call for a situated model of mind-in-the-world, composed of a self-sustaining system that is capable of continual transformation, capable of commitment, and intentionality in real relationships.

Winograd and Flores' work raises significant questions about the assumptions of a functionalist, rationalist, representational model of cognition, arguing that such a view is based on highly questionable assumptions about the nature of human thought and action. In a parallel and almost contemporaneous book, *Plans and Situated Actions: The Problem of Human-Machine Communication*, Suchman (1987) examines the difference between rational, purposive "plans", and circumstantial, negotiated, "situated actions". As her argument develops through examples of each, it becomes clear that rather than situated actions being imperfect copies of rational plans, plans are *idealized* representations of real-world actions. Research in cognition and intelligent systems design needs to take the latter seriously:

A basic research goal for studies of situated action, therefore, is to explicate the relationship between structures of action and the resources and constraints afforded by physical and social circumstances.

(Suchman, 1987: 179)

Both Winograd and Flores' and Suchman's work point to the emergence in the AI and intelligent systems communities of theories of situated, distributed knowledge, embodied in real-world contexts, rather than functionalist, abstract models of cognition. The implications for education and learning theories are significant.

The work that brings the situated perspective firmly home to education is Lave and Wenger's (1991) *Situated Learning: Legitimate Peripheral Participation*. This small, simple book has more to say than most of the rest of the literature combined. Coming a year or two after Brown, Collins, and Duguid's article, it presents a view of situated learning substantially more developed. One of Lave and Wenger's starting points—Brown's "cognitive

apprenticeship”—becomes a point of some departure. Lave and Wenger are wary that privileging apprenticeship over other forms of teaching and learning misses the point: while the apprenticeship model may be an example of situated learning in action, they argue, situated learning cannot help but occur in all contexts of practice:

In our view, learning is not merely situated in practice—as if it were some independently reifiable process that just happened to be located somewhere; learning is an integral part of generative social practice in the lived-in world. . . . Legitimate peripheral participation is proposed as a descriptor of engagement in social practice that entails learning as an integral constituent.

(Lave & Wenger, 1991: 35)

This perspective flips the argument over: it is not that learning happens best when it is situated (as if there were learning settings that are not situated), but rather, learning is an *integral part* of all situated practice. So, rather than asking, “How can we create authentic learning situations?” they ask, “What is the nature of communities of practice?” and “How do newcomers and old-timers relate and interact within communities of practice?”. They answer these questions through elaborating the nature of communities of practice in what they term “legitimate peripheral participation”.

By this we mean to draw attention to the point that learners inevitably participate in communities of practitioners and that mastery of knowledge and skill requires newcomers to move toward full participation in the sociocultural practices of a community. (p. 29)

The terminology is intentionally elusive; there is really no such thing as “illegitimate” or “central” participation; legitimate peripherality refers to the dynamics of membership in a real community of practice. A member of a community is *legitimate*, in that the community forms the context for practice in a real way; *peripherality* refers to the notion that he or she is inevitably on a trajectory from newcomer to old-timer within a community. “*Peripherality* is also a *positive* term, whose most salient conceptual antonyms are *unrelatedness* or *irrelevance* to ongoing activity” (p. 37).

Lave and Wenger warn against understanding legitimate peripheral participation as a technique or a form of learning environment, one that can be designed or created. Rather, they argue, it is an “analytical viewpoint on learning, a way of understanding learning” (p. 40), and as such it forms a framework for looking at the dynamics of learning in all situations of practice, even those which at face value appear to be anti-thetical to learning. Included in this latter category is their example of butchers’ apprentices (pp. 76–79) in which newcomers feel intimidated and are kept apart from the experienced meat cutters,

confined to tasks that have little to do with professional practice. Nevertheless, learning takes place, and the dynamics of this community of practice produce new generations of butchers. In a later work, Brown and Duguid (1996a) explore the idea of learning as “stolen knowledge”, and ask how one can “legitimize theft”. Their answer is a reference to Lave and Wenger’s book.

Core to Lave and Wenger’s work is the idea of knowledge as distributed across a community of practice—what Gavriel Salomon refers to as the “radical situated” perspective (Salomon, 1993). This idea stands opposed to conceptions of learning and cognition that emphasize individuals’ internalization of knowledge. Lave and Wenger instead re-emphasize the ways a community of practice reproduces itself through its individuals:

This pivotal emphasis, via legitimate peripheral participation, on relations between the production of knowledgeable identities and the production of communities of practice, makes it possible to think of sustained learning as embodying, albeit in transformed ways, the structural characteristics of communities of practice.

(Lave & Wenger, 1991: 55)

This is indeed an ecological perspective, for it describes the shaping of the environment by the actors within it, and the reciprocal shaping of the actors by the environment. Neither one nor the other is privileged as the locus of action or learning. It is impossible to consider one without considering the other.

Interestingly, this has implications for traditional notions of “abstract” versus “concrete” thinking and learning, which might previously have been thought of as constituting (or *not* constituting, as it were) situated learning. Some forms of practice may be disconnected or bracketed from others. “*Abstraction* in this sense stems from the disconnectedness of a particular cultural practice. Participation in that practice is neither more nor less abstract or concrete, experiential or cerebral, than in any other” (p. 104).

Lave and Wenger also elaborate on the involvement of cultural artifacts and technologies within communities of practice. As knowledge is stretched across a community of practice, it is also embodied in the material culture of that community, both in the mechanisms of practice and in the shared history of the community:

Participation involving technology is especially significant because the artifacts used within a cultural practice carry a substantial portion of that practice’s heritage. . . . Thus, understanding the technology of practice is more than learning to use tools; it is a way to connect with the history of the practice and to participate more directly in cultural life. (p. 101)

Artifacts and technology are not just instrumental in embodying practice; they also help constitute the structure of the community. Peripheral participation can involve differential access to various areas of community knowledge. Lave and Wenger refer to the relative *transparency* and *opacity* of systems and technologies, in terms of the degree to which members of the community have access to them.

Knowledge, power, history, and identity are all constituted through the structures and interstices of communities of practice. Lave and Wenger's success at turning the situativity of learning upside down gives us a perspective on learning as integral to situated practice, instead of the other way around. The result is a theory of knowledge that is not limited to the individualistic conceits of a Cartesian epistemology. It is a theory of knowledge that will stand us in good stead when we need to relate it to a world rich with electronic media and technology.

The sociologist of science Susan Leigh Star, in the introduction to her book, *Ecologies of Knowledge*, writes, "Our memories are in families and libraries as well as inside our skins; our perceptions are extended and fragmented by technologies of every sort" (Star, 1995: 19). It is to the world of technology and media that I will turn next.

### 3. ECOLOGIES OF ACTORS AND ARTIFACTS

In *Abstracting Craft: The Practiced Digital Hand*, Harvard architecture professor McCullough (1998) offers the following definition of *tool*, *medium*, and *artifact*:

Tools are means for working a medium. A particular tool may indeed be the only way to work a particular medium, and it may only be for working that medium. Thus, a medium is likely to distinguish a particular class of tools . . . . Sometimes a medium implies such a unique set of tools that the whole is referred to without differentiation. Painting is a medium, but it is also the use of specific tools and the resulting artifact: a painting. The artifact, more than the medium in which or tools by which it is produced, becomes the object of our work . . . . Artifact, tool, and medium are just different ways of focusing our attention on the process of giving form.

(McCullough, 1998: 62–63)

In his exploration of the subtleties of craft—and particularly handcraft—McCullough moves from tool to medium to artifact seamlessly, drawing his attention to the spaces of tension and grain within each, letting his attention fall away where it is not needed. Making a point reminiscent of Winograd and Flores' notions of distributed cognition, McCullough writes, "If a medium is a realm of possibilities for a set of tools, then any immediate awareness of the

tools may become subsidiary to a more abstract awareness of the medium” (McCullough, 1998: 63).

The idea of abstract awareness is key to McCullough’s analysis. His goal is to demonstrate how digital technologies are now reaching the point of sufficient sophistication that practices previously in the domain of traditional handcrafts—sculpture, drawing, and painting—can now be used with the computer. “Formal notation invites the study of structure”, McCullough writes, and the elaboration of structure is what digital technologies are all about; the sophistication and richness of any digital medium is a reflection of the sophistication and richness of its underlying structures. The analog, in his terminology, is *grain*:

Objects have a grain, as if they might as well have cracks and wrinkles. This grain consists of internal hierarchies and classifications, external formats and displays, and accumulations of specially modified generic formal vocabulary elements. Understanding these constructive frameworks is at the heart of digital form-giving expertise. (p. 166)

Awareness of tool and medium is about knowledge of this grain or structure. McCullough writes, “Acute knowledge of a medium’s structure comes not by theory but through involvement” (p. 196). This awareness or knowledge has two faces: one is the falling away of intermediaries to allow consciousness of the medium or artifact itself. The other is the traces of culture, knowledge, and history that become wrapped up in our tools, media, and artifacts. The guitar may disappear from the consciousness of the musician, such that she becomes aware only of the music, but over time, the instrument will bear the marks of her playing, will show wear from her hands, be stained by the moisture from her skin. In a sense, our tools, media, and artifacts are as situated as we are, and they share the temporality of our existence. They have history, or historicity, or horizons that we merge with our own.

Perhaps, a more everyday example of this notion is the ubiquitous document. In a recent article, “The Social Life of Documents”, by Brown and Duguid (1996b)—not talking about situated learning this time—the social and artifactual role of documents is discussed. Documents are more than texts, because they have a kind of material form that embodies them in social reality. This material or artifactual incarnation is socially important “because it mediates and temporizes, records traces and fixes spaces, and demands institutions as well as technologies of distribution”. Brown and Duguid continue, “We need to see the way documents have served not simply to write, but also to underwrite social interactions; not simply to communicate, but also to co-ordinate social practices”.

Documents, say Brown and Duguid, perform a number of important social roles. One is the constitution (in both senses of the word) of communities and nations. Another is the maintenance and construction of the boundaries

between communities. Still another is bridging and negotiation between distinct communities. In a document-literate society, we are quite used to these phenomena; because we are familiar—intimate, even—with the structure or “grain” of documents as tools, media, or artifacts, our world is richly constituted and structured by the distribution, historicity, and inter-relations of documents.

A complementary argument is made by the literary critic Fish (1980) in his book, *Is There a Text in this Class?*. Fish describes how interpretive communities create texts, or at least the readings of them. As a literary critic, he is concerned with the interpretation of texts. Going beyond the idea that the meaning of a text is in the reader or in the reading, Fish holds that the meaning of a text is not centered in the individual, but in the community:

[Interpretive strategies] proceed not from [the reader] but from the interpretive community of which he is a member; they are, in effect, community property, and insofar as they at once enable and limit the operations of his consciousness, he is too. (p. 14)

The appropriateness or authority of any interpretation is a function of the interpretive community within which it is read. What constitutes interpretive communities themselves seems to be the historicity of readers and readings and texts and interpretations; again, a distributed, ecological perspective. Fish continues:

The fact of agreement, rather than being a proof of the stability of objects, is a testimony to the power of an interpretive community to constitute the objects upon which its members (also and simultaneously constituted) can then agree. (p. 338)

Brown and Duguid’s conception of documents managing community structures—inside, between, and across communities—fits nicely with Fish’s account of how interpretive communities constitute disagreements as well as agreements. Fish writes provocatively, “Disagreements are not settled by the facts, but are the means by which the facts are settled” (p. 338).

Stanley Fish’s turning upside-down of facts and disagreements almost perfectly pre-figures the work of French sociologist of science Bruno Latour. Latour makes almost the exact same inversion that Fish does, and does so in a similar spirit to the shift in focus Lave and Wenger made regarding the situatedness of learning.

Latour’s concern is with how science is made. His influential work, *Science in Action* (1987), paints a picture of science as the working through of disputes via the “mobilization of collectives”—that is, through gathering and arranging an army of allies: natural, social, human, non-human, political, technical, and so on. Latour’s argument is that it makes little sense to

spend time dividing up the world along these axes, since what makes science effective is the skill by which these allies are orchestrated and directed to a common goal. The business of arranging such diverse actors along coherent networks so that disparate forms and voices speak as one is what Latour calls “translation”, and it is this activity that western science has become very good at.

Latour’s actor network theory traces science in the making, watching not for the emergence of reliable facts and “black boxes”, but rather for the mobilization of forces to resolve disputes, and thus to construct valid ways of representing reality. According to Latour, the practice of science is all about translating potential allies (human and non-human, “natural” and “social”) into useful ones by getting them to speak the same language. In the tradition and culture of western science, there are a variety of accepted ways of doing so; ways of “inscribing” phenomena in such a way that they are mobilizable in scientific texts. Latour (1987: 227) refers to such inscriptions as “immutable, combinable mobiles”, because they are translated into a fixed form that is combinable and comparable with other inscriptions, and because they are then able to be carried from their original contexts to other applications. Latour gives the example of the maps that European explorers made of the coast of Asia (p. 215ff): inscriptions which were fixed and thus reliable, which shared their form with other maps of other places, and which were capable of being rolled up and taken back to Europe. This translation and inscription of hydrographic features gave European nations immense power over trade relations in Asia. Latour’s immutable, combinable mobiles are very similar to Brown and Duguid’s documents, defining communities, drawing boundaries, and making bridges between disparate groups.

While it may be tempting to identify Latour’s immutable mobiles with the distilling of abstract knowledge from the concrete, Latour is careful to warn that translation and inscription are not occult cognitive processes. In a similar movement to Lave and Wenger’s denigration of the abstract-concrete divide, Latour writes:

The concrete work of making abstractions is fully studiable; however, if it becomes some mysterious feature going on in the mind then forget it, no one will ever have access to it. This confusion between the refined product and the concrete refining work is easy to clarify by using the substantive “abstraction” and never the adjective or the adverb. (p. 241)

This questioning of sacred either—or divisions is key to Latour’s work, and reaches its peak in his book, *We Have Never Been Modern* (1993), in which Latour deconstructs the totalizing myths upon which the modern world has been built: the divisions between nature and society, science and politics,

and the distinction between modern and pre-modern cultures. Latour critiques modernity's belief in the separateness of these categories by pointing out the *hybrid* nature of almost all cultural forms, despite our best intentions in believing that natural things are purely natural and social things are purely social. Latour's project is to refocus the sociology of science and technology (and contemporary society) on a more faithful account of the constitution of the world, one in which the objects of study are both natural and cultural, human and non-human, and scientific and political—a "parliament of things" (p. 142). Latour calls for anthropology to come home from the tropics; anthropologists, he argues, have never had any trouble in portraying the complex blend of spiritual, natural, and cultural aspects of "pre-modern" societies as holistic systems. Why then do we have such trouble viewing our own systems as similarly intermeshed?

This anthropological challenge informs Latour's (1995) own studies of science. In his article "Mixing Humans and Non-humans: The Sociology of a Door-Closer", Latour writes under the pseudonym Jim Johnson, a technologist from Columbus, Ohio (thereby inscribing a convenient "non-human" delegate for his instructive purposes), to conduct an ethnographic treatment of the broken-down hydraulic door spring at the sociology department of Walla Walla University. Latour (as Johnson) approaches the collection of hydraulic cylinder, spring, door, sociology building, cold weather, and warm sociologists as an integrated whole, each participant in the system acting in ways that anticipate and expect the actions of others in the system. The door spring is banal, yet essential to Latour's argument. He writes:

The bizarre idea that society might be made up of human relations is a mirror image of the other no less bizarre idea that techniques might be made up of non-human relations. We deal with characters, delegates, representatives, or, more nicely, lieutenants (from the French *lieu tenant*, i.e., holding the place of, for, someone else), some figurative, others nonfigurative, some human, others nonhuman, some competent, others incompetent.

(Latour, 1995: 273)

Latour, it seems, is calling for an ecology of actors and artifacts, and suggesting that it is foolish to try to see the world otherwise. We are engaged in communities of practice that are not made up of people alone. The ways in which we work have everything to do with the non-human presences we construct (tools, media, and artifacts, as McCullough might point out) and with whom we are in constant dialogue. To recognize this is to adopt a theory of human action that is inclusive of its technological and artifactual extensions; one not limited to the mind/body reductivism of a Cartesian worldview.



#### 4. RE-SITUATING CONSTRUCTIONISM

The school of constructionism comes from MIT researcher Seymour Papert, who, in the 1970s and 1980s, led a groundbreaking series of projects that brought computing technology to schoolchildren through the Logo programming language. As described in Papert's (1980) landmark book *Mindstorms: Children, Computers, and Powerful Ideas*, the Logo project puts children in charge of computational objects—originally, a mechanical “turtle” that drew a line on paper as it moved around, but later a virtual turtle that moved on the computer screen. Papert, a protégé of famous developmental psychologist Jean Piaget, was concerned with children's difficult transition from Piaget's concrete to abstract stages. Papert saw the computer as the tool that could make the abstract concrete:

Stated most simply, my conjecture is that the computer can concretize (and personalize) the formal. Seen in this light, it is not just another powerful educational tool. It is unique in providing us with the means for addressing what Piaget and many others see as the obstacle which is overcome in the passage from child to adult thinking.

(Papert, 1980: 21)

Papert's work made computer programming accessible to children, not through “dumbing down” computer science, but by carefully managing the relationship between abstract and concrete. Logo gave children the means to concretize mathematics and geometry via the computer, which made them into explorers in the field of math. Papert believed that since the best way to learn French is not to go to French class, but to France, the best way to learn mathematics would be in some sort of “Mathland” (p. 6). Logo provided a “microworld” operating in terms of mathematical and geometric ideas. By experimenting with moving the turtle around, children had direct, concrete experience of how mathematical and geometric constructs work. Through reflection on their experiments, they would then come to more formalized understandings of these constructs. Papert saw children as *epistemologists*—thinking about their thinking about mathematics.

By the late 1980s, Papert's work with children and Logo was one of the most influential forces in educational technology. The MIT Media Lab's Epistemology and Learning Research Group ran extensive research projects in schools, studying all manner of phenomena around the experience of schoolchildren and Logo-equipped computers. A snapshot of this research is found in Harel and Papert's (1991) book *Constructionism*, which covers the perspectives of 16 different researchers. In the book's introductory essay, “Situating Constructionism”, Papert outlines how *constructionism* differs from Piaget's *constructivism*:

Constructionism—the N word as opposed to the V word—shares constructivism’s connotation of learning as “building knowledge structures” irrespective of the circumstances of the learning. It then adds the idea that this happens especially felicitously in a context where the learner is consciously engages in constructing a public entity, whether it’s a sand castle on the beach or a theory of the universe.

(Papert, 1991: 1)

There are two main features of the theory. The first, building on Piaget’s constructivism, is that knowledge is not transferred whole from person to person, but rather is constructed by individuals in practice. Papert’s playful essay notes the irony of explaining what constructionism is, rather than letting the reader construct her own idea of it. The second feature is that this knowledge construction does not exist purely within the head of the individual, but is embodied in the creation of a “public entity”. There is something of the ecological stance in this, especially as Papert draws our attention to the necessary *pluralism* that comes from the interplay of different people engaged in constructing their own knowledge. The importance of the public, shared nature of what is constructed implies that there is communication and shared culture that is built in the process. Papert writes

We can come to agreement about theories of learning . . . only by groping in our disorderly bags of tricks and tools for the wherewithal to build understandings. (p. 2)

The emphasis on pluralism in constructionist practice is a major theme to emerge from the Media Lab in the 1980s. Sociologist Sherry Turkle’s ethnographies of computing cultures emerge from this work. Her hugely popular 1984 book, *The Second Self: Computers and the Human Spirit*, explored the different “styles of mastery” that she observed in boys and girls in Logo classrooms. In her 1991 article with Papert, “Epistemological Pluralism and the Revaluation of the Concrete”, Turkle outlines two poles of technological mastery: “hard” and “soft”. Hard mastery, identified with top-down, rationalist thinking, they observed in a majority of boys. Soft mastery, identified with relational thinking and Claude Lévi-Strauss’ notion of *bricolage*, they observed in a majority of girls (Turkle & Papert, 1991: 167–168).

The identification of soft mastery and *bricolage* in programming was very important for Papert and Turkle, for a number of reasons. This relational, negotiated approach to understanding systems has much in common with Piaget’s constructivist theory and is also very much in line with how Papert saw children working with Logo, exploring the features of a microworld, and building an intimate awareness of it. Papert and Turkle’s agenda was to “revalue

the concrete”, which they saw as woefully undervalued in contemporary life, and especially in math and science education. Turkle wrote

The development of a new computer culture would require more than technological progress and more than environments where there is permission to work with highly personal approaches. It would require a new and softer construction of the technological, with a new set of intellectual and emotional more like those we apply to harpsichords than hammers.

(Turkle & Papert, 1991: 184)

I find it particularly interesting to note the tension in Papert and Turkle’s writings between an ecological perspective—which seems so near amid discussion of *bricolage*, relational approaches, pluralism, the construction of public entities, and so on—and the centered, cognitive science perspective from which their work derives. Papert’s work with Jean Piaget, not to mention his long-standing relationship with the MIT AI Lab, can be credited with supplying the cognitivist paradigm he seems to write from. Sherry Turkle too, with a background in psychoanalysis and body of work studying computer scientists at MIT, is concerned with what is going on inside people’s heads. Their work on *epistemological* pluralism clearly reveals this cognitivist perspective: both Papert and Turkle are working from a deep desire to understand *how mind works*—rather than how knowledge and understanding are constituted in communities, or what I have been calling an ecological approach.

It may not be fair to criticize the thinking of a particular period in hindsight, but I believe the cognitivist stance was limiting for constructionist theory in the 1980s. Roy Pea, in his article “Practices of Distributed Intelligence and Designs for Education” (1993) offers a critique of Papert’s constructionism from the standpoint of distributed intelligence:

Papert described what marvelous machines the students had built, with very little “interference” from teachers. On the surface, the argument was persuasive, and the children were discovering important things on their own. But on reflection, I felt this argument missed the key point about the “invisible” human intervention in this example—what the designers of LEGO and Logo crafted in creating just the interlockable component parts of LEGO machines or just the Logo primitive commands for controlling these machines.

(Pea, 1993: 65)

Pea’s insight draws attention to the fact that what is going on in the Logo project exists partly in the minds of the children, and partly in the Logo system itself; that they are inseparable. This is, I think, a more distributed stance than Papert and Turkle take.

Interestingly, the major work of the Media Lab in the 1980s was contemporaneous with a sea change in the thinking of AI researchers, such as described in the work of Winograd and Flores, described earlier. Sherry Turkle later acknowledged the significance of the newer trends of “connectionism” and “emergent AI” in her 1995 book, *Life on the Screen: Identity in the Age of the Internet* (Turkle, 1995: 137).

It would be the next generation of Media Lab researchers who would move constructionist research to a more distributed footing. Mitchel Resnick was probably influential in this trend, with his work with parallel computing: Logo microworlds with hundreds or thousands of turtles that allowed children to play with populations and complex systems (Resnick, 1991: 205–214). However, while Resnick’s work explored ecologies of turtles, it did not really address ecologies of learners. But Resnick’s student Amy Bruckman took constructionism and situated it in the MUD.

The internet had emerged as a revolutionary technology for many in the early- to mid-1990s. During this time, educational technology, and practically everything else having to do with computers, suddenly became about the internet. Amy Bruckman was interested in MUDs—*Multiuser Dungeons*—multiplayer text-based virtual reality games on the internet. Bruckman watched the dynamics of communities in internet MUDs and made the connection: “MUDs are a constructionist playground”, she wrote in 1995 (Bruckman & Resnick 1995). While Bruckman’s work is not heavily theoretical, she succeeded in merging the constructionist and situated learning perspectives. In her doctoral dissertation, *MOOSE Crossing*, she wrote:

Analyses of individuals interacting with stand-alone computer systems such as those in Sherry Turkle’s *The Second Self* often focus on the individual’s quest for mastery (Turkle, 1984). That quest takes on added dimensions when the activity is strongly situated in a supportive community context. (p. 122)

The idea of supportive community is key to Bruckman’s work. *MOOSE Crossing* describes a MUD she created for a community of pre-adolescent kids. Her work is an ethnographic portrait of a subset of the community there, a community situated in a very real place, and with very real interpersonal dynamics.

Calling a software system a “place” gives users a radically different set of expectations. People are familiar with a wide variety of types of places, and have a sense of what to do there. . . Instead of asking “What do I do with this software?”, people ask themselves, “What do I do in this place?” The second question has a very different set of answers than the first. (Bruckman 1997, p. 49)

Bruckman's thesis is that community and constructionism go hand in hand. Her ethnography reveals very close, very personal bonds emerging between children in the process of designing and building software in the virtual environment. "The emotional support", she writes, "is inseparable from the technical support. Receiving help from someone you would tell your secret nickname to is clearly very different from receiving help from a computer program or a schoolteacher" (p. 128). Bruckman's ethnography underscores dynamics clearly recognizable from Lave and Wenger's description of legitimate peripheral participation:

Sometimes the best teachers are not experts, but learners only one step ahead of you who are excited about sharing what they themselves just learned. (p. 132)

As close as Bruckman's ethnography of MOOSE Crossing comes to an ecological approach to constructionism, I feel it still falls short. Bruckman emphasizes the importance of role models in the virtual environment and points out many cases in which the personal creations of children in the virtual environment were instrumental in helping establish relationships. But they remain just that: the artifacts in the virtual world are projections of their creators and remain mere instruments, secondary to the more important interpersonal connections. Bruckman does not fully acknowledge the ecology of people, virtual artifacts, and environment that emerges in MOOSE Crossing.

Constructionism reaches what I consider a more complete ecological perspective in the work of Ricki Goldman-Segall. Part of the Media Lab's second generation, Goldman-Segall's approach is that of an ethnographer and a media theorist, rather than a cognitive scientist or a hacker. This difference is significant, I think, because it allows Goldman-Segall to move into a phenomenological perspective in her analysis of ecologies of learning. In her book, *Points of Viewing Children's Thinking*, she writes:

[A] medium opens up a path for a different set of partnerships among viewer, author, and text—a set of partnerships that revolves around, and is revolved around, our constant recognition of culture. A video segment (in text form), for example, is the representation of a cultural moment in the making of cultures. A video object is a cultural object, something to turn around and reshape. And, just as we change it through our manipulation, so it changes both us and our cultural possibilities.

(Goldman-Segall, 1998: 10–11)

Goldman-Segall's central metaphor is the *constellation*: a configuration of stars that takes its shape—its essence—from the point of view of the subject. The majority of Goldman-Segall's work has dealt with ways of embodying the

constellation metaphor in collaboratively authored hypermedia documents, so that several participant authors can configure texts according to their own points of view, and to layer the resulting configurations. This layering leads to what Goldman-Segall calls “configurational validity” (Goldman-Segall, 1995; 1998), the idea that we can construct more valid interpretations by layering and comparing the perspectives of others. This is somewhat reminiscent of Stanley Fish’s notion of interpretive communities, but draws more influence from “post-modern” anthropologist Stephen A. Tyler’s notion of ethnographic ‘authority’ via *polyphony* and *evocation* (Tyler, 1986).

Moreover, Goldman-Segall directly challenges the work on “epistemological styles” developed by Turkle and Papert (1991), in favor of much more dynamic ideas of “frames” and “attitudes”. Framing is a notion of perspective used in many contexts: Marvin Minsky’s AI, Howard Gardner’s theory of multiple intelligences, Erving Goffman’s everyday sociology, architecture, and cinematography. The important thing about frames—in contrast to the essentialist notion of “styles”—is that they implicate the framer as well as that which is left out of the frame.

I have become less comfortable with the notion of styles, which is the term my colleagues Sherry Turkle, Seymour Papert, and others have asked us to consider over the last decade. I now choose a different kind of framing—one that is conscious of the precariousness of any framing of others’ lives. The kind of frames I now choose open the possibility for both those who are being portrayed and those who view them to become partners in framing.

(Goldman-Segall, 1998: 244–245)

Goldman-Segall’s notion of epistemological “attitudes” emerged as a dynamic response to the more essentialist notion of “styles” in Turkle’s hard and soft mastery. Attitudes imply positionality and orientation and are situated in time and place. The idea that dynamic epistemological attitudes may run at odds with the gender breakdown of hard and soft mastery led Goldman-Segall to suggest that “gender-flexing” may occur: that boys may take on attitudes that are traditionally associated with girls’ styles and vice versa. The underlying theme here is the primacy of situated “points of viewing”, rather than essential qualities. Goldman-Segall sees learners more as *ethnographers* than epistemologists.

This *meta*-ethnographic approach, in which Goldman-Segall creates texts of learners creating texts, is key to what I see as the ecological perspective of Goldman-Segall’s work. She makes the children into ethnographers, into videographers, and in so doing, the lines of research methodology, ethnographic authority, subject, and object, are blurred, for the ecology of texts is polyvocal and collaboratively authored. The researcher’s traditional authoritative stance is de-centered. Furthermore, the texts and constructions

of the participants become part of the ecology of texts that constitutes their community—become constellations—encouraging still further configuration and layering, in an ongoing process.

We can now form more permeable partnerships with those we study and with our readers, creating a digital commons . . . Readers of our socially constructed texts can either be silent lurkers or decide to make their presence known to us. Layers build, patterns emerge, friendships and enmities grow, and digital inquiry becomes a reflexive practice—with an emphasis on flexing, stretching, and strengthening our inquiry. (pp. 268–269)

#### CONCLUSION: DISTRIBUTED CONSTRUCTIONISM

In this review, I have attempted to draw together three traditions of research—from situated learning, media and technology, and constructionism—to assemble a more sophisticated arrangement. This layering creates a whole that is greater than the sum of its parts. I believe that situated learning becomes richer when viewed from the point of view of media and technology studies, that media and technology are better understood from the point of view of constructionist learning theory, and that constructionism itself benefits greatly from the light shed by situated and distributed learning theories. I have presented the work of a variety of thinkers, drawing together the commonalities, and pointing out the paths to more ecological awarenesses of action, inquiry, and learning.

These perspectives have important implications for educational analysis and practice: Lave and Wenger made it clear that their description of legitimate peripheral participation was not in itself a recipe or model for the design of educational systems, but it is not too hard to think forward to such designs, with their analysis in mind. Latour's sociology of science is first and foremost an analysis, but he is careful not to distance himself or his work too much, not to deconstruct capriciously or irresponsibly, and as such provides a model for honest intellectual practice. Goldman-Segall's outright blurring of methodological boundaries is certainly a call to follow suit, to be a participant learner. I am fond of this passage from Goldman-Segall's book, in which she relates her reaction to Ryan, a 13-year-old educational researcher, in a profoundly de-centered moment:

I sit in my seat, rendered speechless by his idea that learning is a result of layering others' views with our own, and his broad understanding about how we make sense of the living world around and inside us.

(Goldman-Segall, 1998: 232)

I am seeking an ecological perspective on constructionism, one that takes seriously the distributed nature of cognition, intelligence, and learning across a community of practice; that includes the tools, media, and artifacts themselves as part of that community; and that recognizes the interdependent evolution of individual and context.

#### REFERENCES

- Brown, J. S., Collins, A., & Duguid, P. (1996 [1989]). Situated cognition and the culture of learning. In: McLellan, H. (Ed.) *Situated Learning Perspectives*. Englewood Cliffs, NJ: Educational Technology Publications. 19–44.
- Brown, J. S. & Duguid, P. (1996a). Stolen knowledge. In: McLellan, H. (Ed.) *Situated Learning Perspectives*. Englewood Cliffs, NJ: Educational Technology Publications.
- Brown, J. S. & Duguid, P. (1996b). The social life of documents. *First Monday* 1(1).
- Bruckman, A. S. (1997). MOOSE Crossing: Construction, Community, and Learning in a Networked Virtual World for Kids. Unpublished Doctoral Thesis, Massachusetts Institute of Technology.
- Bruckman, A. S. & Resnick, M. (1995). The MediaMOO project: constructionism and professionalism community. *Convergence* 1(1):94–109.
- Fish, S. (1980). *Is There a Text in This Class?* Cambridge: Harvard University Press.
- Goldman-Segall, R. (1995). Configurational validity: a proposal for analyzing ethnographic multimedia narratives. *Journal of Educational Multimedia and Hypermedia* 4(2/3), 163–182.
- Goldman-Segall, R. (1998). *Points of Viewing Children's Thinking*. Hillsdale, NJ: Lawrence Erlbaum and Associates.
- Harel, I. & Papert, S. (Eds.) (1991). *Constructionism*. Norwood, NJ: Ablex Publishing.
- Latour, B. (1987). *Science in Action*. Cambridge: Harvard University Press.
- Latour, B. (1993). *We Have Never Been Modern*. Porter, C. (Trans.). Cambridge: Harvard University Press.
- Latour, B. (1995). Mixing humans and non-humans together: the sociology of a door-closer. In: Star, S. L. (Ed.) *Ecologies of Knowledge*. Albany: SUNY Press.
- Lave, J. & Wenger, E. (1991). *Situated Learning: Legitimate Peripheral Participation*. Cambridge: Cambridge University Press.
- McCullough, M. (1998). *Abstracting Craft: The Practiced Digital Hand*. Cambridge: MIT Press.
- Papert, S. (1980). *Mindstorms: Children, Computers, and Powerful Ideas*. New York: Basic Books.
- Papert, S. (1991). Situating constructionism. In: Harel, I. and Papert, S. (Eds.) *Constructionism*. Norwood, NJ: Ablex Publishing.
- Pea, R. D. (1993). Practices of distributed intelligence and designs for education. In: Salomon, G. (Ed.) *Distributed Cognitions: Psychological and Educational Considerations*. Cambridge: Cambridge University Press.
- Resnick, M. (1991). Overcoming the centralized mindset: towards an understanding of emergent phenomena. In: Harel, I. and Papert, S. (Eds.) *Constructionism*. Norwood, NJ: Ablex Publishing.
- Salomon, G. (1993). No distribution without individuals' cognition: a dynamic interactional view. In: Salomon, G. (Ed.) *Distributed Cognitions: Psychological and Educational Considerations*. Cambridge: Cambridge University Press.



- Star, S. L. (Ed.) (1995). *Ecologies of Knowledge*. Albany: SUNY Press.
- Suchman, L. A. (1987). *Plans and Situated Actions: The Problem of Human–Machine Communication*. Cambridge: Cambridge University Press.
- Turkle, S. (1984). *The Second Self: Computers and the Human Spirit*. New York: Simon and Schuster.
- Turkle, S. (1995). *Life on the Screen: Identity in the Age of the Internet*. New York: Simon and Schuster.
- Turkle, S. & Papert, S. (1991). Epistemological pluralism and the revaluation of the concrete. In: Harel, I. and Papert, S. (Eds.) *Constructionism*. Norwood, NJ: Ablex Publishing.
- Tyler, S. A. (1986). Post-modern ethnography: from document of the occult to occult document. In: Clifford, J. and Marcus, G. E. (Eds.) *Writing Culture*. Berkeley and Los Angeles: University of California Press.
- Winograd, T. & Flores, F. (1986). *Understanding Computer and Cognition: A New Foundation for Design*. Norwood, NJ: Ablex.

# **Part II**

## **Schooling, Professional Learning and Knowledge Management**

## Chapter 12: Realizing the Internet's Educational Potential

J. W. SCHOFIELD

*Learning Research and Development Center and Psychology Department,  
University of Pittsburgh*

Internet access is increasingly widespread in primary and secondary schools around the world, just as it is in society at large. Ninety-nine percent of public schools in the United States had internet access by 2001, as did 87% of their classrooms (National Center for Education Statistics, 2001). Many other countries, including Australia, Canada, England, Finland, Iceland, New Zealand, Singapore, and Wales, also have very high levels of school internet access and numerous others, including Korea and Israel, have more modest but still substantial levels of access (Organization for Economic Cooperation and Development, 2002a; Pelgrum & Anderson, 2001). Indeed, the development of the idea of virtual schools and the growth in the availability of distance education opportunities (E-defining education, 2002; Orange & Hobbs, 2000; Trotter, 2002; Virtual Schools Forum Report, 2002; Zehr, 1997; Zucker & Kozma, with Yarnall, Marder & Associates, 2003) have begun to challenge the very notion of a school as a specific geographic place in which teachers and students congregate for the purpose of teaching and learning. Furthermore, the growing popularity of laptop computers and hand-held computing devices and the increasing presence of the internet at home, work and in other settings have also blurred the boundaries between schools and other places by facilitating rapid communication and collaboration between those who are not in the same location at the same time (Kozma & Shank, 1998).

Internet access has grown so quickly in schools because it is seen as a way of substantially, even dramatically, improving students' education. Countries around the world have set national goals and policies reflecting the belief that the use of this information and communication technology will improve their school systems (Jones, 2003; Pelgrum & Anderson, 2001; Plomp et al., 2003). Consistent with glowing, sometimes utopian, predictions made about the impact of other earlier computer applications (Kling, 1994), expectations tend to be very high. For example, Mambretti (1999: 17) argues that "Not since the invention of movable type and the printing press has a technology held such potential for transforming the learning process... the internet is a revolutionary technology that is bound to change every aspect of society and, in particular, the education system". Similarly, Carlitz (1991: 26) asserts that the internet "has the potential to become the foundation on which all educational programs and material are developed and distributed".

Faith in the power of the internet to improve education is not limited to scholars and visionaries. It can be seen in public opinion polls in the U.S., Canada and elsewhere which suggest that parents believe that technology is “very important” for their children’s education (Media Awareness Network, 2000; Turow, 1999). It is also apparent in the public support in many countries for “Net Days” when parents, educators, community members, vendors, and others work together to help bring internet access to large numbers of schools simultaneously (Süss, 2001). Such faith is most likely strengthened by advertising campaigns, run by those with a commercial interest in fostering internet access in schools and elsewhere, that link the use of educational technology to improved learning. It is also most likely connected to the growing ubiquity of internet use for both work related and personal purposes in many countries around the globe, which exposes millions of individuals to the internet’s power and reach. Finally, there is a growing research-based consensus that many different kinds of computer applications do indeed have positive educational outcomes (Hattie et al., 1996; Kulik & Kulik, 1991; Murphy et al., 2002; President’s Committee of Advisors on Science and Technology and Panel on Educational Technology, 1997; Waxman et al., 2002; Wenglinsky, 1998), although not all studies of the issue are consistent with this conclusion (Angrist & Lavy, 2002). This emerging consensus may also play a role in encouraging educational policy makers to adopt yet another such application, the use of networking technologies.

Indeed, the internet does appear to have the potential to be very useful for students and teachers (Bransford et al., 1999; Means et al., 2001; Owston, 1997). First, and most obviously, it has the potential to provide access to an extraordinary amount and variety of information. Thus, it can put students and teachers in touch not only with far more information than school libraries are likely to be able to supply, but also with a wider variety of kinds of information and experiences than would be available otherwise (video clips, graphics, databases, government documents, foreign language newspapers, specialized web pages designed for educational purposes, etc.). Second, it provides a convenient and rapid means of communication between teachers, students and those beyond the walls of their schools or the confines of the communities in which they are located (Penuel et al., 2002). This creates many opportunities for professional growth for teachers (Renninger & Shumar, 2002; Schlager et al., 2002; Schofield & Davidson, 2002), although teachers’ use of such opportunities may be more problematic than it is often assumed to be (Hunter, 2002). It also opens up the possibility of involving those with specialized expertise in students’ education, of allowing students to enroll in on-line classes that can not be taught in their schools because of limitations related to demand, resources, or expertise, of allowing collaboration between individuals who would have no practical means of working together otherwise, and of providing students with a wider audience for their work.

1. INTERNET'S CURRENTLY LIMITED SCHOOL USE BY AND EDUCATIONAL IMPACT ON STUDENTS

Yet, it is unwise to assume that school or classroom internet access, in and of itself, will promptly result in substantial student internet use, let alone substantial student use that will transform educational environments and improve educational outcomes. Almost as common as the theme of high expectations in the research literature on computer technology in schools is that of relatively low levels of use. Studies indicate that computers in schools are employed less frequently than might be expected (Cuban, 2001; Loveless, 1996; Schofield, 1995; U.S. Congress, Office of Technology Assessment, 1995; U.S. Department of Education, 1993). Accounts of computers sitting virtually unused for long periods of time, boxed or gathering dust in a corner, are numerous (Piller, 1992; Schofield, 1995). Broken or outdated computers are also quite common in schools (Pelgrum & Anderson, 2001). Indeed, Hollands (2003) found that middle school students in New York City reported being much more likely to use a computer in a public library than at a school library, an interesting finding in light of the vastly greater time students spend in school and the fact that many of these students' schools had large numbers of computers.

Although more and more classrooms have internet connections, studies suggest that student internet use is nonetheless often relatively low. For example, Süß (2001) reports that, as of late 1998, only 13% of over 4000 European students who used computers in school reported using the internet there, although the proportion of those reporting such use varied markedly by country and age, with Nordic countries and older students showing much higher than average levels of internet use. Furthermore, Becker's (2000) large-scale study of internet use in classrooms in the U.S. found that only one-quarter of teachers with modem-based classroom access and 30% of teachers with direct high speed connections indicated that they had asked students to do World Wide Web research on ten occasions or more over the course of the school year. A more recent study of U.S. students, selected because of high self-reported levels of internet use, including home use, reported that these students perceived numerous serious barriers to their use of the internet at school, including a variety of kinds of school-imposed limitations on access. Indeed, many of these students reported using the internet for school work more at home than in school because of such limitations in school (Levin & Arafah, 2002). Consistent with this, a study of middle and upper SES Israeli high school students found that the most commonly reported educational use of the internet was to do homework, that the preferred location for internet use was the home (82%) rather than the school (17%), and that only 7.4% of these students reported learning to use the internet in school (Nachmias et al., 2000).

In addition, there are at least some indications that when internet use does occur in schools it often does not realize its full educational potential, or

even begin to have the kind of impact that many expect. Although parents are very positive about internet access as a means of gathering information, the very large majority do not think that it has any effect on their children's grades (The UCLA Internet Report, 2003). Interestingly, a survey of nearly 6000 Canadian students and over 1000 Canadian parents found that whereas 66% of the parents of students in 7th–11th grade reported educational benefits as the biggest benefit gained from their children's internet use, only 24% of the students agreed (Environics Research Group, 2001). Students were more likely to highlight benefits related to their social life (36%), to convenience (31%), and to entertainment (27%). Further, Levin and Arafeh (2002) found that the internet-using students they interviewed reported that the quality of their internet-based school assignments was poor, complaining about rote activities, like filling out worksheets, that do not make full use of the internet's potential. Yet another study found that whereas teachers "felt they are making dramatic leaps in their ability to harness the power of technology to create stimulating, engaging and challenging learning experiences for students, the students themselves have seen few changes in classroom instruction" (Power to Teach, 2003: 1).

## 2. THE IMPORTANCE OF FIT IN REALIZING THE INTERNET'S EDUCATIONAL POTENTIAL

The main argument presented in this chapter is that several important issues above and beyond merely connecting schools to the internet must be dealt with if internet use in schools is even to begin to realize its full potential for improving education. Specifically, this chapter focuses on four issues that have the potential to impede internet use, to undercut the utility of such use for teachers and students, and/or to raise problems for schools attempting to make use of the internet to improve the education they provide for students. Unless careful thought is devoted to dealing with these issues, internet use is likely to be less frequent and less productive than it could be. Given the very high hopes that typically accompany the introduction of the internet to schools and classrooms and the major financial investment already made in many countries to provide teachers and students with access (Anderson & Becker, 2001; Coley et al., 1997; Department of Education and Skills, 2003; Pelgrum & Anderson, 2001), finding ways to maximize the internet's contribution to education seems crucial. Ironically, given existing rhetoric about the ways in which the internet will revolutionize education, the issues that must be dealt with to facilitate productive internet use in schools can readily be conceptualized as issues of alignment or fit with the existing educational system and the context in which it is embedded. These issues include fit between teachers' goals and those that internet use is likely to facilitate, fit between teachers' existing skills, expectations, and practices and those needed to take full advantage of internet

access, fit between the values and norms of the communities in which schools are embedded and those of the world to which the internet connects them, and fit between existing assessment systems and the student outcomes most likely to be influenced by internet use. Each of these issues will be explored in turn.

### **2.1. Fit Between Teachers' Goals and Those for Which the Internet Provides a Comparative Advantage over Other Resources**

It has become increasingly clear during the past two decades that merely placing computers in schools does not guarantee their use, let alone their effective use (Collis et al., 1996; Cuban, 2001; Schofield, 1994, 1995). Research on the use of numerous kinds of computer applications suggests that such use depends on many factors including the extent to which teachers believe the use of this technology is likely to meet their needs and to help them reach valued goals (Cohen, 1988; Cuban, 1986). The same appears to be true with regard to use of the internet.

Specifically, Becker (2000) reports a positive relationship between teachers' judgments about the value of the internet in their work and their professional use of it. In addition, he and his colleagues found a clear link between teachers' objectives and their use of various kinds of computer-based applications. For example, teachers who considered finding out about ideas and information to be one of their main objectives for students were much more likely to use the World Wide Web than were those who did not. In addition, those who considered mastering basic skills or the remediation of skills as among their main objectives for students were much less likely to use the World Wide Web than other teachers (Becker et al., 1999). Similarly, Schofield and Davidson (2002) found a link between the internet's facilitation of teachers' goals and internet use. Specifically, use of the internet was relatively high when teachers believed it helped them reach goals that they had been striving to reach before the introduction of the internet and low when this was not the case. Thus, for example, use was high in classes whose teachers had decided that it was important to expose their foreign language students to the words of native speakers of the languages being studied, which the internet does readily by providing access to foreign language newspapers, web sites, and chat rooms. In contrast, use was often low when it did not lend itself in such an immediate and obvious way to achieving ends for which teachers were already striving. These findings are consistent with Hunter's (2002) conclusion that many teachers tended not to use the resources available through an extremely rich internet project called the Math Forum because they saw the materials presented there as outside of the curriculum they were trying to teach, that is, as not consistent with the goals they were trying to reach.

Many teachers believe that internet use will help further attainment of their goals, both personal and professional (Schofield et al., 1997). For example, Becker (2000: 85) reports that roughly half of the teachers surveyed in a large study in the U.S. saw having access to e-mail and the World Wide Web as essential to their work, and nearly 90% thought it was either valuable or essential for their work. However, the most common type of teacher internet use is very consistent with the traditional goal of having teachers' present students with information to be assimilated. Specifically, Becker (2000) reports that teachers in the U.S. most commonly use the internet to find information for use in lessons, many doing so weekly. This use of the internet influences students only by first influencing teachers, a less direct route to changing student experiences or outcomes than internet use by students themselves. Another large-scale survey of technology decision-makers in districts in the U.S. also suggests that teacher research is a very common use of the internet, with 72% of respondents mentioning it (National School Boards Foundation, 2002).

Use of the internet in this way may well importantly increase the timeliness or richness of the information that teachers present to their students. Thus, it is likely to contribute to students' education. However, it is not likely to foster the kind of major change that proponents of internet use in schools often foresee. Indeed, the kinds of activities that would more clearly reflect changed goals, such as the use of the internet for extended student projects, were reported in fewer than 10% of school districts in the U.S. (National School Boards Foundation, 2002). This finding is consistent with that of a study of use of the internet in Europe, which concluded that the most common student use in most countries studied was for finding information, a task quite traditional for students. Uses that implied greater change in classroom goals or practice, such as internet use for group projects or for the dissemination of materials produced by the students, were much less common (Pelgrum & Anderson, 2001). Interestingly, another large-scale, multinational project designed specifically to study innovative uses of the internet concluded that fewer than 20% of these projects reported using information and communication technology to foster curricular change or other educational reform efforts (Kozma, 2003).

In sum, there seems little reason to expect that teachers will make substantial use of the internet in their work unless they believe that it will help them achieve the goals for which they are already striving better than the resources they have traditionally used. The fact that the internet is very commonly referred to as a tool in discussions of its use in education emphasizes this point. Just as individuals are unlikely to use a hammer sitting at hand unless they have something that they wish to pound, they are unlikely to use the internet unless they have something they wish to accomplish for which it seems well suited. Indeed, since learning how to use the internet in their work involves time and effort for many teachers, it is only logical that educators must believe it will help them achieve their goals better than existing tools in order to justify that investment.



Of course, those who study the history of technology use point out that it often takes a while for individuals to realize just what pre-existing goals they can accomplish with a new technology and how a tool can be used (Bruce, 1993). This fact is especially important with regard to the use of the internet in schools since, unlike some kinds of computer applications such as computer assisted instruction or computer-based tutors, the internet was not developed to serve as an educational tool. Thus, it takes considerable effort and thought on the part of the user to understand thoroughly the capabilities of the internet and the ways in which these capabilities can be used to foster given educational goals. Although more and more resources, located both on the internet and elsewhere, are available to help with these tasks, it nonetheless takes time and effort to locate them and to reflect on how the internet might be useful in specific situations to achieve pre-existing educational goals.

Although fit with existing goals is very important in influencing internet use in schools, the development of new technologies can sometimes lead people to adopt new goals over time as they become aware of possibilities they did not envision before because the means to achieve them were not at hand (Bruce, 1993; Mehan, 1989). As will be discussed later in this chapter, there is some reason to think that internet use may sometimes foster a gradual change in educational goals and practices by opening up new possibilities. For example, Dexter, Anderson and Becker (1999) found that computer-using teachers who used progressive teaching practices saw their reflections on such experiences as a source of change in their teaching. Similarly, Kozma and McGhee (2003) conclude that use of information and communication technology can foster significant change in a range of classroom practices. However, in order to make maximally effective use of the internet in schools, it will be necessary to explore carefully how it can help teachers reach their existing goals while at the same time focusing close attention on the issue of what new possibilities internet access brings with it that may ultimately end up changing current understandings of what it is reasonable and desirable to strive for in schools.

## **2.2. Fit Between Teachers' Skills, Expectations, and Longstanding Practices and Those Conducive to Productive Internet Use**

As Bruce (1993: 9) points out, "The linking of new technology to a vision of transformed pedagogy is a distinguishing feature in many proposed innovations in education. It is rare that the developer of an innovation would adopt the goal of simply facilitating current practices with a new technology". Consistent with this, those who advocate internet use in schools typically see it as a mechanism for change in goals or practice (Bransford et al., 1999; Feldman et al., 2000; Sheingold & Frederiksen, 2000). More specifically, internet use is often seen as facilitating constructivist practices, which are consistent with research in cognitive science suggesting the importance of students' active

involvement in creating their own understandings. For example, the internet is often seen as useful in helping teachers shift from reliance on a didactic approach to the use of more student-centered practices. In the immediately preceding section of this chapter, I argue that internet use is likely to be relatively low when the goals it readily facilitates are not consistent with those of teachers. Here, I argue that internet use is also likely to be relatively low when it requires skills that teachers do not have or when its productive use seems to call for practices that do not fit well with those with which teachers are familiar.

The importance of fit between teachers' skills and those required for effective internet use is widely acknowledged. Awareness that lack of such fit may well lead to underutilization of this relatively expensive resource has led to increasing recognition of the importance of professional development activities related to technology use in countries in which large investments have been made for internet use in education (CEO Forum, 1999; National Grid for Learning, 2003; National School Boards Foundation, 2002; Pelgrum & Anderson, 2001; President's Committee of Advisors on Science and Technology and Panel on Educational Technology, 1997).

However, in spite of awareness of the importance of such fit, this fit is often not achieved. For example, after conducting a survey of internet use in schools in roughly two-dozen countries around the world, Pelgrum and Anderson (2001) concluded that providing teachers with the skills they need to make effective use of information and communication technology is still a major problem in most countries. Solving this problem is important in order to realize value from the money spent on internet access in schools since both empirical evidence (Anderson & Becker, 2001; Hollands, 2003) and logic suggest that appropriate support and skill development for teachers is related to technology use in schools. Consistent with this point, Becker, Ravitz, and Wong (1999) found that teachers' computer expertise is related to their use of the World Wide Web in a substantial number of subject matter areas, although generally speaking the relation between skills and the teacher's own professional use of technology was greater than the relation between their skills and their instructional use of technology. Not surprisingly, teachers' computer expertise appears to be related to at least some degree to professional development experiences (Pelgrum & Anderson, 2001).

Providing appropriate professional development experiences is likely to be especially complex and expensive with regard to internet use for several reasons. First, in addition to learning various technical skills, teachers need to develop a vision of how the internet can be used productively in their work and to develop ways to implement this vision in the context of their classroom environments (Feldman et al., 2000; Levin & Arafah, 2002; Means et al., 2001). Developing such a vision is a much more complex task than allowing or encouraging students to use a piece of software designed specifically to develop various skills or to help them learn about a particular topic. Furthermore, finding effective ways to implement such visions is made more difficult

by that fact that many educators have relatively little experience with curriculum development. In addition, the most effective kinds of internet use may be quite different from grade to grade and from subject to subject, further complicating the task of professional development. Finally, those charged with the responsibility for providing professional development experiences to teachers relating to information and communication technology are generally more proficient with regard to technical matters than with regard to pedagogical and curricular issues (Feldman et al., 2000; Pelgrum & Anderson, 2001). There are more and more software tools, web sites, on-line curricula, and books designed to help educators figure out how to make productive use of the internet for themselves or with their students, but these are much more readily available in some languages than in others (Hogenbirk, 2000). In addition, many teachers may not have the time or the inclination to make use of these resources, especially if they do not receive support for this effort from related professional development activities.

Even if teachers develop the requisite technical skills to use the internet effectively and the capacity to envision how they can use the internet to enrich and improve students' experiences in school, issues regarding fit with long-standing expectations and practices and with the constraints existing in the larger school environment are still likely to limit internet use. Two common expectations are particularly problematic with regard to internet use. The first is the expectation that teachers will know more than their students. The second is the expectation that teachers will function quite autonomously within their classrooms. Each of these expectations and its potential impact on internet use will be discussed in turn.

An important part of the teacher's role is the exercise of authority, that is, legitimate power over the students (Bierstedt, 1970). Teachers' authority has a number of bases, one of which is their expertise, or more precisely the gap between their expertise and their students' level of expertise (Benne, 1970). Events that undermine a teacher's image as knowledgeable and competent in comparison to students have implications not only for the teacher's sense of self but also for the functioning of the classroom.

There is little doubt that a substantial number of students, especially in secondary schools where issues of authority are often the most problematic, know more about internet use than many of their teachers (Schofield & Davidson, 2002). Sometimes schools make good use of students' technical expertise (Means et al., 2001). For example, in the U.S. over 50% of school districts report having students provide technical support in at least some of their schools (National School Boards Foundation, 2002). Interestingly, it appears that the disparity between students' and teachers' technical knowledge can sometimes even improve teacher-student relations when teachers discover new-found respect for students they had not thought very well of before, and students react positively to feeling valued (Schofield & Davidson, 2003). However, some teachers see the likelihood that students may know

more than they do regarding the internet as a problem, fearing that it will undermine their authority, increase the difficulty they have managing their classes, or provide students with an opportunity to use the internet inappropriately with impunity (Schofield & Davidson, 2002). For these teachers, the disparity between their own and students' knowledge serves as a deterrent to the instructional use of the internet.

Yet another common expectation in many countries that is often inconsistent with internet use is that teachers will function quite autonomously in their classrooms. It is true that schools, school districts, or even national policy may set rules about many important aspects of teachers' work, including things such as the textbooks to be used, curricular objectives to be pursued, and acceptable disciplinary practices. However, once teachers have closed their classroom doors and begun to interact with their students they are often more or less on their own as long as they stay within the bounds of professional behavior (Hargreaves, 1993; Little, 1990; Lortie, 1975). Many kinds of use of the internet can interfere with the teacher's expectation of being able to work fairly autonomously. For example, collaborative activities between students and others at a distance, which many see as having great promise for enhancing students' educational experiences, raise a host of issues connected to the need to negotiate goals and coordinate schedules. Although such issues may appear minor, in practice often they are not, at least partly because collaborators in different school systems or in other kinds of settings may be working within larger organizational contexts that differ in important ways from that of any given teacher trying to initiate or maintain a collaboration. Further, collaboration puts teachers and their students at the mercy of the collaborators. If the latter fail to carry out the activities they agreed to by the time agreed on, or if the others' efforts do not work out as expected, the result may be wasted time and effort, which is likely to discourage further collaborative undertakings. Perhaps such issues account for the finding in a recent study of innovative uses of information and communications technology in many countries that very few such projects involve connection and collaboration with others outside of the classroom (Kozma & McGhee, 2003).

Not only are deeply held expectations often rather inconsistent with internet use, so too are some longstanding classroom practices. Such inconsistency may well limit use. For example, Schofield and Davidson (2002) found that internet use was high in classroom situations in which use readily fit with longstanding practices and procedures and low when it did not. So, for example, teachers with a small number of computers with internet access in their classroom were likely to have students make use of those connections if they were used to having students work in small groups. In contrast, teachers with similar computer set-ups who were more used to and comfortable with whole class instruction had their students make relatively little use of the internet.

Whole class instruction is common, most likely because teachers in many countries typically have over twenty students to work with at any given time

(Organization for Economic Cooperation and Development, 2002b). Teachers used to whole class instruction are faced with a dilemma if they wish to have the students in their classes use the internet unless they have a classroom equipped with a very large number of internet-connected computers, a highly unusual situation. [Even in such atypical situations, clashes between internet use and traditional practices arise because web sites may be overwhelmed when large numbers of students try to access them simultaneously (Power to Teach, 2003; Schofield & Davidson, 2002)]. Given the student-computer ratios common in countries whose schools are characterized by internet connections (Pelgram & Anderson, 2001), a much more common situation is for a teacher with classroom internet access to have a small number of internet connected computers. This creates a challenge to traditional whole class instruction. Unless the internet connection is used with a LCD projector and screen, which many classrooms do not have, there is no way for all or even most students to see the computer's monitor or to work on the internet simultaneously. Rather, the internet must sit unused or a small number of students must break off from the larger class to pursue an internet-related task. To the extent students need assistance from others, including their teacher, to use the internet productively, their internet use is potentially disruptive to the larger class. Further, the question arises of how the internet-using students will learn the material being covered by the rest of the class, unless such use is restricted to students who have already completed their work, which raises important issues related to equity.

Such issues of fit between traditional practices and internet use do indeed often limit use markedly (Schofield & Davidson, 2002). Indeed, as mentioned earlier, many of those who most enthusiastically advocate the instructional use of the internet do so precisely in the hope that such use will encourage teachers to adopt different kinds of classroom practices (Feldman et al., 2000). Given the foregoing, it should come as no surprise that Becker (2000) found that the more teachers espouse constructivist goals and report constructivist practices, the more they value the internet, use it themselves, and have their students use it for research and for projects and publication. Furthermore, these differences are large in magnitude. For example, the most constructivist teachers were likely to report using the internet roughly three times as much as the most traditional teachers. Indeed, pedagogical beliefs and practices were the third most important predictor of internet use in this study, right after classroom access and the teacher's computer expertise.

In sum, lack of fit between teachers' technical and curriculum development skills and those required for productive internet use can limit such use. Use is often further limited both by pre-existing expectations about teachers' roles that are not always consistent with internet use and by traditional practices. Further, fit between pedagogical goals and practices and those conducive to internet use seems not only to influence how readily individual teachers make use of the internet, as discussed above. It also influences how quickly and

easily the new practices pioneered by innovative teachers are adopted by their peers (Hunter, 2002; Owston, 2003) as do the structural conditions under which teachers work (Schofield & Davidson, 2002).

However, the fact that disjunctions between existing skills, expectations, and practices and those conducive to internet use often limit internet use does not mean that some change is not possible or likely. For example, in the United States the last twenty years have seen a major change in conceptions of what good teaching looks like. Constructivist approaches, which many see as very consistent with various affordances provided by the internet, are now quite widely accepted by teachers there, at least at a philosophical level (Ravitz et al., 2000). The availability of internet access may provide teachers who would like to adopt such practices with a means to do so. Furthermore, there is some evidence that the availability of technology for instruction may encourage teachers to move in new directions, at least to some degree (Becker, 1999a). Thus, at the same time that lack of fit inhibits internet use, such lack of fit can serve as a force for change, as it surely has in the last decade with regard to teachers' computer-related skills in many countries.

### **2.3. Fit Between the Values and Norms of the Community in which the School is Embedded and Those of the Larger World Accessible via Internet**

One of the primary benefits of the internet is that it can connect students to information resources and people all around the world (Cummins & Sayers, 1995; Garner & Gillingham, 1996; Koizumi et al., 2000; Starkey, 1998). This opens up an extraordinary variety of potentially useful educational possibilities, as mentioned earlier. However, the very access to people and resources that would not otherwise be available that gives the internet so much potential as an educational tool raises an important issue—whether it also exposes students to individuals and to written, auditory, or graphic content that is unacceptable within their communities, especially within the context of an educational institution.

Norms, values, and behaviors vary markedly from culture to culture. In addition, the internet has a kind of culture of its own because it is a place where those whose interests or behaviors are not mainstream can make themselves and their views known as readily as those who are more conventional. Furthermore, they can do so anonymously if they wish to. Thus, those who are part of educational systems in different parts of the world are likely to find some of the behavior and content found on the internet disturbing, offensive, or unacceptable, although exactly what is seen as problematic may vary from culture to culture. To take just one example, controversy about internet content in the context of U.S. schools tends to focus around access to explicit sexual material (Schofield & Davidson, 2002). In much of Europe, in contrast, there is less concern about certain kinds of sexual material and more concern about hate speech (Thornburgh & Lin,

2002). In other countries, such as China and Saudi Arabia, concern runs high in influential sectors of society about the dissemination of Western political thought and popular culture because it is seen as incompatible with existing political structures or influential world views (Rand Review, 2002).

When internet content is inconsistent with the interests of the local power structure, or with local values and norms, use can be curtailed in schools due to concerns about the impact of such material on students or about controversy within the community regarding the materials to which students should have access at school (Thornburgh & Lin, 2002). For example, these concerns had a very marked impact on the way the internet was used in a U.S. school district studied in detail as it introduced the internet to its classrooms (Schofield & Davidson, 2002). The primary impact seemed to be to limit internet use in a variety of ways. Specifically, many teachers did not let students use the internet unless the students were closely supervised. Often, this supervision consisted of the teacher keeping an eye on the computer monitor to see what kinds of material the students were accessing. Since many classrooms had just a few computers in the back and it was difficult for a teacher to both teach the other students and supervise those using the internet, this sometimes curtailed internet use dramatically. Concerns about supervision also inhibit computer use elsewhere. This is not surprising in light of the fact that many books written for educators emphasize the importance of close supervision, as illustrated by Valauskas and Ertel's (1996: 111) admonition to teachers to "Watch your students like a Doberman watches the mailman when they have internet access". Lankshear, Snyder and Green (2000) report that students in a school in Australia lost their lunchtime and recess access to the internet when physical changes in their school meant that teachers could no longer observe them from the staff room. In Switzerland and Spain most students have no independent internet access, with such access typically being limited to students doing schoolwork under the supervision of a teacher. Much less frequently, as in Finland, are students free to use the internet without supervision, such as in computer rooms open after school hours (Süss, 2001).

Use may not only be curtailed by concerns about students' exposure to certain kinds of content. In addition, the kinds of use allowed can be so circumscribed that a substantial portion of the possible educational value of internet use can be undermined. For example, due to fears about inappropriate material, some teachers allow students to visit only pre-approved web sites, which dramatically reduces the resources students can access using the internet as well as undermining the development of many kinds of internet-related skills (Schofield & Davidson, 2002). As another example, the same study found that a high school librarian kept the computer keyboard behind her desk and only let students check it out for use after she had approved the search terms they planned to use, again because of fear about what material students might seek or encounter inadvertently if left to their own devices. This procedure markedly discouraged student searches and constrained students

from making useful changes in search terms in response to seeing what their initial search produced. Interestingly, such procedures reflect a much broader trend in U. S. school districts, 48% of which report some sort of restriction of access (in addition to filtering) as a mechanism used to deal with security, privacy or safety (National School Boards Foundation, 2002).

Of course, strategies have been developed to try to deal with incompatibility between local values and those of the world accessible via the internet (National Research Council and Institute of Medicine, 2001). For example, acceptable use policies, which parents and/or students in some countries sign as a condition of students' internet access, lay out the kinds of materials that students are permitted to seek and the kinds of internet behaviors in which they are allowed to engage (Thornburgh & Lin, 2002). In addition, filters that block many kinds of content can be used. Finally, many efforts have been made to create educational resources that students and teachers can use to help students learn how to avoid danger or exploitation by individuals they may encounter on the internet who may not have their best interests at heart (Thornburgh & Lin, 2002). However, each of these approaches to handling possible clashes between the norms and values of the local community and those of the larger world outside has its own problems and complications.

Acceptable use policies are one reasonable way of trying to make sure that students use the internet in ways consistent with the norms of their schools and the community in which they are embedded while they are in school. However, use of these policies, which is widespread in the U.S. (National School Boards Foundation, 2002), raises numerous potentially complicated and difficult issues. First, of course, the signing of such a policy as a condition of access creates at least some administrative burden, especially in districts in which the student population is very mobile. Second, the issue arises of how teachers adjust their curricula and assignments so that students who have not signed the policy can be accommodated. Third, a similar issue arises regarding students who may have lost access due to behavior inconsistent with the policy. Of course, somewhat similar issues arise when schools have policies relating to suspension of students for unacceptable behavior. However, suspended students are not in the classroom, whereas those without internet access are, which creates a more complicated situation with regard to how assignments can be structured. Specifically, it creates a situation in which use for all may be restricted or diminished because some students do not have internet access. Finally, acceptable use policies both become harder to enforce and more complex to construct when schools have programs that provide students with internet access during non-school hours, such as the increasingly common programs that provide students with laptop computers for home access. In such cases, the common expectation that internet use will be restricted solely to educational activity becomes unreasonably limiting and close supervision becomes impossible without software designed to monitor student activity. The use of such software raises difficult issues related to privacy, especially



since other family members may use the computer. Furthermore, it adds to cost since someone needs to decide if violations of the acceptable use policy have occurred and to follow up on such violations.

Filters that block access to content that the school or community finds objectionable can also be used to minimize any potential harm that might come to students through exposure to such material and to help prevent controversy about their access to such materials. Indeed, filters are widely used in schools in some countries. For example, roughly 90% of school districts in the U.S. use some kind of filtering (National School Boards Foundation, 2002). Filters are typically designed to block very specific kinds of materials, which may or may not overlap completely with the ones that would concern a particular community.

Although many filters are flexible and allow districts to influence the kinds of things that are blocked, there is no guarantee that they will be structured in a way that meets every community's desires. Further, given the increasing diversity in many countries due to immigration, there is no guarantee that there will be any significant consensus within the community from which a school draws its students regarding what, if anything, should be filtered and what should not be. Many school systems have longstanding procedures for the selection of educational materials such as textbooks or library books. For example, the American Library Association has a workbook on educational materials selection procedures that is used by many school districts in the U. S. However, procedures for deciding whether and how to use filters often need to be developed, and this process is complicated by the fact that at least some filters will not provide information on the specific sites that they block (Thornburgh & Lin, 2002).

Finally, there is no doubt that filters block at least some materials that they were not intended to block, making internet access less useful to students than it would otherwise be (Digital Chaperones for Kids, 2001). If filters are set appropriately, the amount of unintended blocking can be markedly reduced (Rideout et al., 2002). However, schools and school systems may well err on the side of over blocking in order to avoid controversy. For example, interviews with school district personnel in several communities in the U.S. found that the avoidance of controversy was a much more frequently mentioned reason for filtering than concerns about actual harm to students from exposure to unfiltered material (Thornburgh & Lin, 2002). Further, some teachers expressed specific concerns about their legal liability if students under their supervision accessed certain kinds of objectionable materials, ranging from the explicitly sexual to information on topics such as suicide or bomb construction. Such concerns also seem likely to lead to over blocking because the consequences of lawsuits pertaining to such issues could potentially be very serious for both teachers and school systems.

Students frequently complain about the blocking of access to internet materials for which they feel they have a legitimate educational need, suggesting

that over blocking is more than a theoretical possibility (Levin & Arafeh, 2002; Thornburgh & Lin, 2002). Thus, it appears that the institutional needs of educational organizations to maintain public support and to avoid problems may well be given priority over the educational needs of students when decisions are made about if and how to use filters, creating yet another way in which the lack of fit between materials available on the internet and local values and norms can limit access to internet resources.

The use of educational resources to help students learn how to avoid danger or exploitation by individuals they may encounter on the internet is yet another mechanism for protecting students from experiences that might harm them or that are inconsistent with local values (Thornburgh & Lin, 2002). Such resources have proliferated in recent years, and many schools have found ways to ensure that students are exposed to them. For example, some schools require internet safety certification before students are provided with access. This is one approach to dealing with part of the potential misalignment between the norms of the local community and those of the larger world to which students are exposed via the internet that does not tend to undercut internet use. However, schools often have difficulty fitting internet safety information into the already crowded curriculum, especially if there is no formal computer literacy or media literacy course that students take before gaining internet access.

Of course, as a tool that facilitates information access and communication, the internet not only allows students to find information they might otherwise not have access to or to be contacted by individuals that they might not otherwise meet. It also allows students to provide information to others and to initiate contact with others. Interestingly, issues of fit arise with regard to these activities that also impede student internet use, although not as strikingly as with the concern about information the students might access. For example, numerous teachers in one district felt that they should monitor whatever material students sent out over the internet, partly to make sure that students did not give out personal information such as their home addresses, and partly to ensure that the students' messages did not somehow embarrass the school by dealing with topics or using language seen as inappropriate in the school environment (Schofield & Davidson, 2002). This undercut the rapidity with which messages were exchanged, which is significant in light of the fact that speed is often cited as one of the primary advantages of using the internet for correspondence. Further, it also allowed teachers to control the content of the messages when such messages were inconsistent with teachers' understandings of community norms or the image of the school they wished to present to the local community. For example, in one case a teacher changed the content of an e-mail that was part of an exchange designed to foster understanding between white and African-American elementary students in nearby but very different communities. A specific invitation from one student to another to meet in person to go the movies was transformed without the students' knowl-

edge into a more general observation about how nice it would be to meet. In another case, teachers reviewing a web site required a student to remove comments critical of their colleagues (Schofield & Davidson, 2002). Although such behaviors do not actually limit internet use, they do undercut the internet as an agent for change.

#### **2.4. Fit Between Existing Assessment Systems and Student Outcomes Most Likely to be Influenced by Internet Use**

Another major factor likely to influence internet use is the alignment between the assessment mechanisms that school systems and teachers use and the kinds of experiences and skills that internet use is likely to foster. In many countries there are national or regional exams that play an extremely important role in determining individual students' and educational institutions' reputations and futures. For example, in the United States schools whose students do not perform adequately run the risk of being required to replace staff, to allow student transfers, and even of being taken over by the state or by a private management contractor. Furthermore, in some states students who do not pass a minimum competency test do not receive high school diplomas even though they have taken the required set of courses. Given such facts, it should not be surprising that tests often shape what is taught and that they have real power, both as agents of change and as inhibitors of change, depending on how they are aligned with newly emerging and traditional practice (National Research Council, 2003; Sheingold & Frederikson, 2000).

As mentioned previously, there is good reason to believe that use of many kinds of computer technology does foster educational outcomes that have traditionally been valued. Thus, such use may well produce the kind of learning that is evidenced on standardized tests, in spite of the numerous factors that can interfere with measuring such change when it occurs (Herman, 1994). However, there is no reason to assume that the internet use will necessarily do the same. Indeed, the internet is so new that strong evidence about its effectiveness in fostering various kinds of traditionally valued and measured outcomes is not readily available in large and convincing quantity, although studies of this issue have begun to emerge (Songer, 1996). Furthermore, the internet is such a flexible application that there is no reason to expect it will normally be used in one or two ways with predictable outcomes. Indeed, Kozma and McGhee's (2003) study of innovative internet use in twenty-eight countries concluded that there are eight different common patterns or clusters of use and that different patterns of use produce different kinds of outcomes. Although it is clear that many teachers value internet use highly (Becker, 2000; Schofield & Davidson, 2002), and there are indications that some of its uses may be helpful in developing long-valued skills such as writing (Cohen & Riel, 1989), it is far from clear how various kinds

of internet use are likely to influence scores on many existing influential standardized tests.

There are several problems in the fit between traditional tests and internet use that lead to the prediction that internet use may well not result in marked positive change on many of the kinds of high-stakes tests currently used in schools within the relatively short time periods that policy makers usually desire to see results from change efforts. First, as mentioned previously, unlike many kinds of computer-based educational applications, the internet itself was not designed specifically to foster learning. It came into being for purposes quite unrelated to education. Thus, finding ways to use it effectively is an uncertain evolutionary process. The speed and success of this process is influenced by a broad array of factors including how students' existing skill levels are suited to making good use of the content available, teachers' familiarity with the internet and their level of technical skill, the overall quality of the information available on the internet, and the quality of various tools, resources, and professional development experiences created to help teachers use the internet effectively. Perspectives that expect rapid improvement in student performance on traditional tests stemming from internet use are most likely unrealistic, given that it is widely acknowledged that teachers may take from three to five years to learn how to use even less challenging kinds of educational technology (Hadley & Sheingold, 1993; Honey, 1994; Kerr, 1991; Sheingold, 1990; Stearns et al., 1991).

Second, many of the kinds of change that the internet seems most likely to bring about in classrooms are not necessarily ones that will produce better scores on the kinds of tests that are traditionally used to measure students' and schools' performance. For example, one of the great advantages of the internet is that it can individualize learning and allow students to pursue their own interests more than is often the case when the internet is not used (Hollands, 2003; Schofield & Davidson, 2002). However, standardized exams, almost of necessity, presuppose a common set of knowledge and skills that are tested. To the extent that the internet leads to more diverse and individualized learning opportunities for students, there is at least the possibility that such use will not be reflected on many high-stakes examinations and that this will ultimately discourage teachers and educational institutions from taking maximum advantage of internet access.

Indeed, it is important to note that the kinds of changes in classroom experiences and outcomes that are readily facilitated by internet use are not ones that seem likely to presage better performance on the kinds of standardized tests that are widely used (Means et al., 2001). For example, Means, Penuel, and Quellmalz (2000) describe an innovative technology-supported project called Hands-On Universe in which high school students use software tools similar to those used by actual scientists to help search for super nova and asteroids. They point out that this project has many of the characteristics that current theory and research (Bransford et al., 1999) suggest facilitate learning,

such as a real world context and interaction with experts. However, they also suggest that the skills learned in conjunction with projects of this type are not likely to be measured by standardized tests.

Problems in fit between internet use and longstanding classroom practices discussed earlier also contribute to making internet use unlikely to improve standardized test scores. Specifically, such problems contribute to the practice of teachers using the internet for “enrichment” or other peripheral activities rather than as part of the core curriculum (Schofield & Davidson, 2004). Typically, enrichment or peripheral activities are not the focus of teachers’ classroom testing, which can lead to students taking them less seriously than they would otherwise and thus undermine learning that might otherwise occur (Means et al., 2000). Further, Wallace, Kupperman, Krajcik, and Soloway’s (2000) study of internet use in science classrooms concludes that students use the internet simplistically and that developing students’ understanding of science through use of the World Wide Web is a challenge for students and teachers. In addition, Schofield and Davidson (2002) discuss the fact that many students tend to drift to recreational and entertainment sites when they are supposed to be using the internet for schoolwork.

There is yet another issue relating to fit between assessment practices and internet use that is likely to impact both what is learned from internet use and whether tests reflect this. Typically, in addition to the standardized high-stakes tests that students take at widely spaced intervals, students often take other everyday tests covering materials their teachers consider central to their courses. These tests are commonly developed by teachers or supplied by textbook publishers. To the extent that these tests reflect teachers’ past experiences, traditional views of achievement, and the kinds of standardized tests that are important in a particular school system, they are not likely to measure internet-related computer skills or the kinds of capabilities with regard to information seeking, collaboration, or the like that many feel can be fostered by well-structured internet use (Owston, 1997). Furthermore, they may not be well-aligned with the specific content students’ learn in internet activities. This leads to two problems. First, as Young, Haertel, Ringstaff, and Means’ (1998) study of classes using the Global Lab Curriculum suggests, students may not be tested on either the content they are intended to learn during activities involving the internet or on the kind of skills they might develop in the course of such activities, leading them to see these activities as unimportant “fun” even when they are intended to be a part of the curriculum (Means et al., 2000). In addition, in such cases, teachers get relatively little feedback on whether students are learning what they are intended to learn through these activities. Thus, students’ learning or the lack thereof may go unnoticed and activities that do not promote learning may be left in place because they are assumed to be useful.

Another reason why it is unrealistic to assume that internet use will improve academic achievement as it is commonly measured is that study after study

suggests that teachers do not use the internet with students primarily to improve academic achievement. For example, Pelgrum and Anderson (2001) found that teachers in over a dozen countries most commonly rated improving academic achievement seventh or eighth out of eight possible instructional objectives for their use of information and communications technology. Much more commonly ranked high were objectives like making learning more interesting and preparing students for jobs. Schofield and Davidson (2002) also found that teachers in an urban district in the U.S. were more likely to mention using the internet in order to do things like preparing students for a world in which technology plays an important role than as a means for improving their academic achievement.

Although it is possible that internet use intended to achieve such alternative purposes could result in increased learning that would be reflected on standardized tests, it does not seem likely. Furthermore, even if such increases in learning as it is traditionally measured were demonstrated, they might not capture the most important contributions that internet use has made to students' education. However, without ways to measure other outcomes it is hard to gauge the extent to which internet use actually influences them. Thus, it seems vitally important to develop assessment tools appropriate for the outcomes that are expected to come from various kinds of internet use (Means et al., 2000; National Research Council, 2003). Unless this is done, schools face two serious risks. The first is that the positive impact of internet use on students will be under-estimated, thus setting up a situation in which the spread of effective internet use may be inappropriately undermined because of disappointment regarding its apparent lack of impact on students. The second is that the impact of this relatively expensive resource will be incorrectly assumed to be positive. This might well divert resources from other potentially more valuable activities. In addition, it makes it less likely that teachers will have feedback needed to help them determine how to make the most productive use of this resource.

### 3. CONCLUDING THOUGHTS

This chapter has argued that lack of fit between the world of the internet and teachers' goals, skills, expectations, their longstanding educational practices, community norms, and valued assessment systems create impediments to potentially productive instructional use of the internet in schools. Furthermore, the contention that lack of fit often leads to low levels of utilization and to utilization in a manner that is unlikely to change education in fundamental ways suggests that conceptualizing the internet as an agent of rapid educational transformation may be mistaken. However, this does not mean that the internet has no useful place in schools. Furthermore, it does not mean that, over time, the internet will not serve as an agent of constructive, if not fundamental, change.

There are many ways in which the internet can make important contributions to education without transforming it. For example, like many other computer applications, internet use appeals strongly to many students, and there is reason to believe that it may increase motivation, class attendance and the like (Schofield & Davidson, 2002). There is also no doubt that its use provides teachers and students with access to a world of resources and opportunities that would not be otherwise available or that would be so inconvenient to access that they would not be used. Furthermore, its extraordinary scope and its remarkable flexibility of use means that it can serve administrators, teachers, and students in a variety of ways, from providing educators with opportunities for professional development, to putting students in touch with mentors, to helping link schools more closely with their communities. Thus, its potential to improve education as it is currently conducted depends largely on the imagination and creativity of those who use it, the wisdom and flexibility of those who create the conditions under which students and teachers work, and the resources that are devoted to providing a technical and social environment in which constructive internet use can flourish.

In addition, it appears likely that internet use may well, at least under some conditions, lead to changes that take a step toward transforming certain aspects of education as we presently know it. For example, the contention that fit between teachers' goals and the internet's affordances influences use suggests that teachers who wish to change their practices in significant ways may do so when internet use supports such change. Consistent with this observation, the work of Becker (1999b: 30) and his colleagues (Becker & Ravitz, 1999) suggests that internet use may have "an emancipating effect on teachers who believe in project-based teaching and other constructivist-compatible strategies". To the extent constructivist beliefs become widespread, as research suggests is beginning to be the case in the United States and elsewhere (Pelgrum & Anderson, 1999; Ravitz et al., 2000), the potential for major change is substantial. For example, Law, Yuen, Ki, Li, Lee, and Chow (2000) found that Hong Kong teachers who wished to change their teaching strategies toward more constructivist and problem-based approaches were able to do so using information and communication technology.

Furthermore, internet use sometimes seems to lead unexpectedly to potentially important changes in schools. For example, Schofield and Davidson (2003) found that internet use led to increased student independence, even in the classrooms of teachers who did not set out to achieve this goal. This is consistent with other research suggesting that the internet leads to greater individualization of instruction (Hollands, 2003) and that students often take on valued and constructive roles in supporting their schools' use of information and communications technology (National School Boards Foundation, 2002). Further, Schofield and Davidson (2003) found that internet use rather unexpectedly appeared to improve student-teacher relations in many classrooms and that, over time, some teachers evolved constructive uses of the

internet which they had not been able to envision before they had some experience working with it. There is no reason to assume that all potentially significant unplanned changes relating to internet use will be positive. However, awareness of the potential power of this resource to change students' educational experiences in unexpected ways may make it possible to find ways to enhance those changes which seem constructive and to find ways to minimize those than are unconstructive.

In sum, existing social arrangements, including commonly shared educational goals, expectations and practices, community values, and existing assessment systems will play a major role in determining the amount and nature of internet use in schools around the globe. In the near term, such factors seem likely to importantly constrain internet use and the subsequent impact of that use on schools and the students in them. Thus, in the near future, it is unrealistic to expect internet use to transform schools and those in them in fundamental ways. However, just as the social environment of schools influences technology use, so too technology and the affordances it brings is likely, over time, to influence schools and those in them by opening up new possibilities and helping them envision and realize new ways of teaching and learning.

#### ACKNOWLEDGMENT

The research reported here was funded by Grant no. 199800209 from the Spencer Foundation.

#### REFERENCES

- Anderson, R. E., & Becker, H. J. (2001, July). School investments in instructional technology. *Teaching, Learning, and Computing: 1998 National Survey*, Report #8. Center for Research on Information Technology and Organizations. University of California, Irvine and University of Minnesota.
- Angrist, J., & Lavy, V. (2002). New evidence on classroom computers and pupil learning. *The Economic Journal* 112, 735–765.
- Becker, H. J. (April 1999a). Changing teachers' pedagogical practices through the use of the world wide web. In: Windschitl, M. A. (Chair), *How is the Internet Affecting Teaching and Learning in k-12 Classrooms? An Open Discussion of Promising Practices and Research Questions for the Future*. Division C-Interactive Symposium conducted at the annual meeting of the American Educational Research Association, Montreal, Canada.
- Becker, H. J. (1999b). *Internet Use by Teachers: Conditions of Professional Use and Teacher-Directed Student Use*. (Report #1) University of California, Irvine and University of Minnesota [On-line]. Retrieved March 26, 2003, from <http://www.crito.uci.edu/TLC/findings/Internet-Use/startpage.htm>.
- Becker, H. J. (2000). Internet use by teachers. In: *The Jossey-Bass Reader On Technology And Learning*. San Francisco: Jossey-Bass, 80–111.
- Becker, H. J., & Ravitz, J. L. (1999). The influence of computer and Internet use on teachers' pedagogical practices and perceptions. *Journal of Research on Computing in Education* 31(4), 356–384.



- Becker, H. J., Ravitz, J. L., & Wong, Y. (1999, November). Teacher and teacher-directed student use of computers and software. *Teaching, Learning, and Computing: 1998 National Survey*, Report #3, Center for Research on Information Technology and Organizations, University of California, Irvine and University of Minnesota.
- Benne, K. D. (1970). Authority in education. *Harvard Education Review* 40, 385–410.
- Bierstedt, R. (1970). *The Social Order*. New York: McGraw-Hill.
- Bransford, J. D., Brown, A. L., & Cocking, R. R. (1999). *How People Learn*. Washington, DC: National Academy Press.
- Bruce, B. (1993). Innovation and social change. In: Bertram, B., Peyton, J. K. and T. Batson (Eds.) *Network-Based Classrooms: Promises and Realities*. New York: Cambridge University Press, 9–32.
- Carlitz, R. (1991). Common knowledge: networks for kindergarten through college. *Educom Review* 26, 25–28.
- CEO Forum on Education & Technology. (1999). School technology and readiness report. *Professional Development: A Link to Better Learning*. Retrieved April 7, 2003, from <http://www.ceoforum.org>.
- Cohen, D. (1988). Educational technology and school organization. In: Nickerson, R. S. and P. P. Zoghbi (Eds.) *Technology in Education: Looking Toward 2020*. Hillsdale, NJ: Erlbaum, 231–264.
- Cohen, M., & Riel, M. (1989). The effect of distant audiences on students' writing. *American Educational Research Journal* 26(2), 143–159.
- Coley, R. J., Cradler, J., & Engel, P. K. (1997). *Computers and Classrooms: The Status of Technology in U.S. Schools*. Princeton, NJ: Educational Testing Service.
- Collis, B. A., Knezek, G. A., Lai, K. W., Miyashita, K. T., Plomp, T., & Sakamoto, T. (1996). *Children and Computers In School*. Mahwah, NJ: Erlbaum.
- Cuban, L. (1986). *Teachers and Machines: The Classroom Use of Technology Since 1920*. New York: Teachers College Press.
- Cuban, L. (2001). Why are most teachers infrequent and restrained users of computers in their classrooms? In: Woodward, J. and Cuban, L. (Eds.) *Technology, Curriculum and Professional Development*. Thousand Oaks, CA: Corwin Press, 121–137.
- Cummins, J., & Sayers, D. (1995). *Brave New Schools: Challenging Cultural Illiteracy Through Global Learning Networks*. New York: St. Martin's Press.
- Department for Education and Skills. (2003). *ICT in Schools*. Retrieved March 26, 2003, from <http://www.dfes.gov.uk/ictinschools/faq.shtml>.
- Dexter, S. L., Anderson, R. E., & Becker, H. J. (1999). Teachers' views of computers as catalysts for changes in their teaching practices. *Journal of Research on Computing in Education* 31(3), 221–239.
- Digital Chaperones for Kids. (2001, March). Retrieved April 9, 2003, from <http://www.consumerreports.org/main/detailv2.jsp?>
- E-defining education. (2002). Cyber schools, online teaching and testing, and other e-learning initiatives are changing how schools operate. *Education Week* 21(35), 8–11.
- Enviroics Research Group. (2001). *Young Canadians in a Wired World: The Students' View: What are Youth Doing Online, and What do their Parents Need to Know?* Retrieved April 7, 2003, from <http://www.media-awareness.ca/eng/webaware/netsurvey/index.htm>.
- Feldman, A., Konold, C., & Coulter, B. with Conroy, B., Hutchinson, C., & London, N. (2000). *Network Science a Decade Later: The Internet and Classroom Learning*. Mahwah, NJ: Erlbaum.
- Garner, R., & Gillingham, M. G. (1996). *Internet Communication in Six Classrooms: Conversations Across Time, Space, and Culture*. Mahwah, NJ: Erlbaum.
- Hadley, M., & Sheingold, K. (1993). Commonalities and distinctive patterns in teachers' integration of computers. *American Journal of Education* 101(3), 261–315.

- Hargreaves, A. (1993). Individualism and individuality: Reinterpreting the teacher. In: Little, J. W. and McLaughlin, M. W. (Eds.) *Teachers' Work: Individuals, Colleagues, and Contexts*. New York: Teachers College Press, 51–76.
- Hattie, J. A., Biggs, J., & Purdie, N. (1996). Effects of learning skills interventions on student learning: A meta-analysis. *Review of Research in Education* 66, 99–136.
- Herman, J. L. (1994). Evaluating the effects of technology in school reform. In: Means, B. (Ed.) *Technology and Education Reform: The Reality Behind the Promise*. San Francisco: Jossey-Bass, 133–167.
- Hogenbirk, P. (2000). EE-NET. In Watson, D. M. and T. Downes (Eds.) *Communications and Networking in Education: Learning in a Networked Society*. Norwell, MA: Kluwer Academic Publishers, 114–117.
- Hollands, F. M. (2003). *The Impact of Computer Use on the Individualization of Students' Learning Experiences in Public Middle School Science Classrooms*. Doctoral dissertation, Columbia University (UMI 3071378).
- Honey, M. (1994). NII roadblocks: Why do so few educators use the Internet? *Electronic Learning* 14(4), 12–13.
- Hunter, B. (2002). Learning in the virtual community depends upon changes in local communities. In: Renninger, K. A. and Shumar, W. (Eds.) *Building Virtual Communities: Learning and Change in Cyberspace*. New York: Cambridge University Press, 96–126.
- Jones, R. M. (2003). Local and national ICT policies. In: Kozma, R. B. (Ed.) *Technology, Innovation, and Educational Change. A Global Perspective: A Report of the Second Information Technology in Education Study, Module 2*. Eugene, OR: ISTE (International Society for Technology in Education), 163–193.
- Kerr, S. T. (1991). Lever and fulcrum: educational technology in teachers' thinking. *Teachers College Record* 93(1), 114–136.
- Kling, R. (1994). Reading all about computerization: how genre conventions shape non-fiction social analysis. *The Information Society* 10(3), 147–172.
- Koizumi, H., Dasai, T., Graf, K. D., Yokochi, K., & Moriya, S. (2000). Interactive distance learning between Japan and Germany. In: Watson, D. M. and Downes, T. (Eds.) *Communications and Networking in Education: Learning in a Networked Society*. Norwell, MA: Kluwer Academic Publishers, 39–50.
- Kozma, R. B. (2003). *Technology, Innovation, and Educational Change. A Global Perspective: A Report of the Second Information Technology in Education Study, Module 2*. Eugene, OR: ISTE (International Society for Technology in Education).
- Kozma, R. B., & McGhee, R. (2003). ICT and innovative classroom practices. In: Kozma, R. B. (Ed.) *Technology, Innovation, and Educational Change. A Global Perspective: A Report Of The Second Information Technology In Education Study, Module 2*. Eugene, OR: ISTE (International Society for Technology in Education), 43–80.
- Kozma, R. B., & Shank, P. (1998). Connecting with the 21st century: technology in support of educational reform. In: Dede, C. (Ed.) *Yearbook 1998: Learning with Technology* 3–27. Alexandria, VA: ASCD.
- Kulik, C., & Kulik, J. (1991). Effectiveness of computer-based instruction in secondary schools. *Computers in Human Behavior* 7, 75–94.
- Lankshear, C., Snyder, I., & Green, B. (2000). *Teachers and Technoliteracy: Managing Literacy, Technology and Learning in Schools*. St. Leonards, NSW, Australia: Allen & Unwin.
- Law, N., Yuen, H., Ki, W., Li, S., Lee, Y., & Chow, Y. (2000). *Changing Classrooms: A Study of Good Practices in Using ICT in Hong Kong Schools*. Hong Kong, China: Centre for Information Technology in School and Teacher Education, University of Hong Kong.
- Levin, D., & Arafah, S. (2002, August 14). *The Digital Disconnect: The Widening Gap Between Internet-Savvy Students and Their Schools*. Prepared for the Pew Internet & American

- Life Project. Retrieved March 26, 2003, from <http://www.pewinternet.org/reports/toc.asp?Report=67>.
- Little, J. W. (1990). Teachers as colleagues. In: Lieberman, A. (Ed.) *Schools as Collaborative Cultures: Creating the Future Now*. Bristol, PA: Falmer Press, 165–193.
- Lortie, D. C. (1975). *School Teacher: A Sociological Study*. Chicago: University of Chicago Press.
- Loveless, T. (1996). Why aren't computers used more in schools? *Educational Policy* 10(4), 448–467.
- Mambretti, C. (1999). *Internet Technology for Schools*. Jefferson, NC: McFarland.
- Means, B., Penuel, W. R., & Padilla, C. (2001). *The Connected School: Technology and Learning in High School*. San Francisco: Jossey-Bass.
- Means, B., Penuel, B., & Quellmalz, E. (2000). The secretary's conference on educational technology 2000: *Developing Assessments for Tomorrow's Classrooms*. Retrieved May 1, 2003, from [http://www.ed.gov/Technology/techconf/2000/means\\_paper.html](http://www.ed.gov/Technology/techconf/2000/means_paper.html).
- Media Awareness Network. (2000). *International Comparative Analysis*. Retrieved April 7, 2003, from [http://www.media-awareness.ca/english/resources/special\\_initiatives/survey\\_resources/research\\_backgrounders/comparative\\_analysis/international\\_analyses\\_2](http://www.media-awareness.ca/english/resources/special_initiatives/survey_resources/research_backgrounders/comparative_analysis/international_analyses_2).
- Mehan, H. (1989). Microcomputers in classrooms: educational technology or social practice? *Anthropology and Educational Quarterly* 20, 5–22.
- Murphy, R. F., Penuel, W. R., Means, B., Korbak, C., Whaley, A., & Allen, J. E. (2002, April). *A Review of Recent Evidence on the Effectiveness of Discrete Educational Software*, SRI Project 11063. Retrieved May 12, 2003, from [http://www.sri.com/policy/elt/pdfs/Task3\\_FinalReport3.pdf](http://www.sri.com/policy/elt/pdfs/Task3_FinalReport3.pdf).
- Nachmias, R., Mioduser, D., & Shemla, A. (2000). Internet usage by students in an Israeli high school. *Journal of Educational Computing Research* 22(1), 55–73.
- National Center for Education Statistics (2001). *Internet Access in U.S. Public School Classrooms: 1994–2001*. Retrieved March 26, 2003 from <http://nces.ed.gov/pubsearch/pubsinfo.asp?pubid=2002018>.
- National Grid for Learning. (2003). *Background to the NGfl*. Retrieved March 26, 2003, from [http://www.ngfl.gov.uk/about\\_ngfl/background.jsp](http://www.ngfl.gov.uk/about_ngfl/background.jsp).
- National Research Council. (2003). Planning for two transformations in education and teaching technology: report of a workshop. Committee on improving learning with information technology. In: Pea, R., Wulf, W. A., Elliott, S. W. and Darling, M. A. (Eds.) *Center for Education and Board on Behavioral, Cognitive, and Sensory Sciences, Division of Behavioral and Social Sciences and Education and Computer Science and Telecommunications Board, Division on Engineering and Physical Sciences*. Washington, DC: The National Academies Press.
- National Research Council and Institute of Medicine. (2001). *Non-Technical Strategies to Reduce Children's Exposure to Inappropriate Material on the Internet: Summary of a Workshop*. Board on Children, Youth, and Families and Computer Science and Telecommunications Board. Joah G. Iannotta (Ed.), Washington, DC: National Academy Press.
- National School Boards Foundation. (2002). *Are We There Yet?: Research and Guidelines on Schools' Use of the Internet*. Retrieved April 18, 2003, from <http://www.nsb.org/thereyet/fulltext.htm>.
- Orange, G., & Hobbs, D. (2000). *International Perspectives on Tele-Education and Virtual Learning Environments*. Burlington, VT: Ashgate.
- Organization for Economic Cooperation and Development. (2002a). *Education at a Glance 2002—Tables*. Retrieved March 26, 2003, from <http://www.oecd.org/EN/document/0,,EN-document-604-20-no-27-32058-604,00.html>.
- Organization for Economic Cooperation and Development. (2002b). *Education at a Glance: OECD Indicators 2002*. Paris: OECD.

- Owston, R. D. (1997). The world wide web: a technology to enhance teaching and learning? *Educational Researcher* 26(2), 27–33.
- Owston, R. D. (2003). School context, sustainability, and transferability of innovation. In: Kozma, R. B. (Ed.) *Technology, Innovation, and Educational Change. A Global Perspective: A Report of the Second Information Technology in Education Study, Module 2*. Eugene, OR: ISTE (International Society for Technology in Education), 125–161.
- Pelgrum, W. J., & Anderson, R. E. (2001). *ICT and the Emerging Paradigm for Life-Long Learning*. Netherlands: International Association for the Evaluation of Educational Achievement.
- Penuel, W. R., Yim, D. Y., Michalchik, V., Lewis, S., Means, B., Murphy, R., Korbak, C., Whaley, A., & Allen, J. E. (2002). *Using Technology to Enhance Connections Between Home and School: A Research Synthesis*. SRI Project 11060, April 2002. Retrieved May 12, 2003, from [http://www.sri.com/policy/clt/pdfs/Task1\\_FinalReport3.pdf](http://www.sri.com/policy/clt/pdfs/Task1_FinalReport3.pdf).
- Piller, C. (1992). Separate realities: the creation of the technological underclass in America's public schools. *MacWorld* 9, 218–230.
- Plomp, T., Anderson, R., Law, N., & Quale, A. (2003). *Cross-national ICT policies in education*. Greenwich, CT: Information Age Publishing.
- Power to Teach. (2003). *The Growing Technology Gap Between Schools and Students: Findings from the Bellsouth Foundation Power to Teach Program*. Retrieved April 9, 2003, from <http://www.bellsouthfoundation.org/pdfs/pttreport03.pdf>.
- President's Committee of Advisors on Science and Technology and Panel on Educational Technology. (1997). *Report to the President on the Use of Technology to Strengthen K-12 Education in the United States*. Washington, DC: Authors.
- Rand Review. (2002). *Poor Connections: Trouble on the Internet* *Frontiers* 26(3), 24–29.
- Ravitz, J. L., Becker, H. J., & Wong, Y. T. (2000). Constructivist-compatible beliefs and practices among U.S. teachers. *Teaching, Learning, and Computing: 1998 National Survey, Report #4*, Center for Research on Information Technology and Organizations, University of California, Irvine and University of Minnesota.
- Renninger, K. A., & Shumar, W. (2002). Community building with and for teachers at the math forum. In: Renninger, K. A. and Shuman, W. (Eds.) *Building Virtual Communities: Learning and Change in Cyberspace*. New York: Cambridge University Press, 60–95.
- Rideout, V., Richardson, C., & Resnick, P. (2002). *See No Evil: How Internet Filters Affect the Search for Online Health Information*. Henry J. Kaiser Family Foundation Study, Executive Summary, December 2002. Retrieved May 15, 2003, from [http://www.kff.org/content/2002/3294/Internet\\_Filtering\\_exec\\_summ.pdf](http://www.kff.org/content/2002/3294/Internet_Filtering_exec_summ.pdf).
- Schlager, M. S., Fusco, J., & Schank, P. (2002). Evolution of an online education community of practice. In: Renninger, K. A. and Shuman, W. (Eds.) *Building Virtual Communities: Learning and Change in Cyberspace*. New York: Cambridge University Press, 129–158.
- Schofield, J. W. (1994). Barriers to computer usage in secondary school teaching. In: Huff, C. W. and Finholt, T. (Eds.) *Social Issues in Computing: Putting Computing in its Place*. New York: McGraw-Hill, 547–580.
- Schofield, J. W. (1995). *Computers and Classroom Culture*. New York: Cambridge University Press.
- Schofield, J. W., & Davidson, A. L. (2002). *Bringing the Internet to School: Lessons from an Urban District*. San Francisco: Jossey-Bass.
- Schofield, J. W., & Davidson, A. (2003). The impact of Internet use on relationships between teachers and students. *Mind, Culture and Activity* 10, 62–79.
- Schofield, J. W., & Davidson, A.L. (2004). Achieving equality of student Internet access within schools. In: Eagly, A., Baron, R. and Hamilton, L. (Eds.) *The Social Psychology of Group Identity and Social Conflict*. Washington, DC: APA Books.
- Schofield, J. W., Davidson, A. L., Stocks, J. E., & Futoran, G. (1997). The Internet in school: a case study of educator demand and its precursors. In: Kiesler, S. (Ed.) *Culture of the Internet*. Mahwah, NJ: Erlbaum, 361–381.

- Sheingold, K. (1996, December). Restructuring for learning with technology: the potential for synergy. In: Sheingold, K. and Tucker, M. S. (Eds.) *Restructuring for Learning with Technology*. New York: CTE, Bank Street College; and Rochester, NY: National Center on Education and the Economy, 9–27.
- Sheingold, K., & Frederiksen, J. (2000). Using technology to support innovative assessment. In: *The Jossey-Bass Reader on Technology and Learning*. San Francisco: Jossey-Bass, 320–337.
- Songer, N. B. (1996). Exploring learning opportunities in coordinated network-enhanced classrooms: a case of kids as global scientists. *The Journal of the Learning Sciences* 5(4), 297–327.
- Starkey, B. A. (1998). Using computers to connect across cultural divides. In: Bromley, H. and Apple, M. W. (Eds.) *Education/Technology/Power*. Albany, NY: State University of New York Press, 175–185.
- Stearns, M. S., David, J. L., Hanson, S. G., Ringstaff, C., & Schneider, A. A. (1991). Cupertino-Fremont model technology schools project research findings: Executive summary (*Teacher-Centered Model of Technology Integration: End of Year 3*), January. Menlo Park, CA: SRI International.
- Süss, D. (2001). Computers and the Internet in school: closing the knowledge gap? In: Livingstone, S. and Bovill, M. (Eds.) *Children and Their Changing Media Environment: A European Comparative Study*. Mahwah, NJ: Erlbaum, 221–241.
- The UCLA Internet Report. (2003) Surveying the digital future, year 3. Retrieved March 26, 2003, from <http://www.ccp.ucla.edu>.
- Thornburgh, D., & Lin, H. S. (2002). *Youth, Pornography, and the Internet*. Washington, DC: National Academy Press.
- Trotter, A. (2002). E-learning goes to school. *Education Week* 21(35), 13–18.
- Turow, J. (1999). *The Internet and the Family: The View from Parents, the View from the Press*. Retrieved April 7, 2003, from [www.appcpenn.org/internet/family](http://www.appcpenn.org/internet/family).
- U.S. Congress, Office of Technology Assessment. (1995). *Teachers and Technology: Making the Connection* (OTA-HER-616). Washington, DC: U.S. Government Printing Office.
- U.S. Department of Education. (1993). *Digest of Educational Statistics*. Washington, DC: U.S. Department of Education.
- Valauskas, E. J., & Ertel, M. (1996). *The Internet for Teachers and School Library Media Specialists: Today's Applications Tomorrow's Prospects*. New York: Neal-Schuman.
- Virtual Schools Forum Report. (2002). Virtual Schools Forum held October 21–22, 2002 in Denver, Colorado. Retrieved March 26, 2003, from <http://www.centerdigitaled.com/highlightstory.phtml?docid=40235>.
- Wallace, R., Kupperman, J., Krajcik, J., & Soloway, E. (2000). Science on the web: Students on-line in a sixth grade classroom. *Journal of the Learning Sciences* 9(1), 75–104.
- Waxman, H. C., Connell, M. L., & Gray, J. (2002, December). *A Quantitative Synthesis of Research on the Effects of Teaching and Learning with Technology on Student Outcomes*. Retrieved May 12, 2003, from <http://www.ncrel.org/tech/effects>.
- Wenglinsky, H. (1998). *Does It Compute: The Relationship Between Educational Technology and Student Achievement in Mathematics*. ETS policy information report retrieved March 28, 2003, from [www.ets.org/research/pic/pir.html](http://www.ets.org/research/pic/pir.html).
- Young, V. M., Haertel, G., Ringstaff, C., & Means, B. (1998). *Evaluating Global Lab Curriculum: Impacts and Issues of Implementing a Project-Based Science Curriculum*. Menlo Park, CA: SRI International.
- Zehr, M. A. (1997). Partnering with the public. *Education Week* 17(11), 36–39.
- Zucker, A., Kozma, R., with Yarnall, L., Marder, C., & Associates (2003). *The Virtual High School: Teaching Generation V*. New York: Teachers College Press.

## Chapter 13: Virtual Schools: Reflections on Key Issues

GLENN RUSSELL

### 1. INTRODUCTION

A VLE can be understood as a computer-accessible cognitive context where students interact with mediated representations rather than their experiential equivalent. For students of school age, an emergent variation is the Virtual School, where the internet is used to deliver some or all of the courses that would traditionally be offered in a “bricks-and-mortar” school in face-to-face mode with a teacher. Increasingly, Virtual Schools are an available alternative to conventional schools. Unlike their physical counterparts, Virtual Schools are, for the most part, not restricted by the restraints of timetables, bells, uniforms, or other organizational characteristics of face-to-face teaching.

Virtual Schools have shown considerable growth in recent years, particularly in the U.S.A. (Clark, 2001) and Canada (SAEE, 2002). They are seen as having identifiable advantages. Mittleman (2001) refers to a Virtual School in Israel as “breaking barriers of time and place” (p. 84), while Florida High School in the U.S.A. uses the motto “any time, any place, any path, any place” (Florida Virtual School, 2003). Virtual Schools have been described in quite glowing terms. Berman (1999) sees virtual learning in the following way:

Imagine classrooms without walls, where students are able to attend their classes at any time they wish, 24 hours a day, seven days a week. Imagine a nearly limitless selection of courses that are innovative, timely and technologically rich. Imagine students working collaboratively and on-line with students from a wide variety of geographic locations. What you are imagining is becoming a reality . . . (p. 12)

Virtual Schooling shares some similarities with Home Schooling, but it can be differentiated from it by the responsibility that parents accept for the education of their children. While both variations can involve students using online technology at home, Virtual Schools usually provide a course of instruction from a more distant site, and a teacher or tutor accepts some responsibility for student assessment. Despite this distinction, the boundaries between Home Schooling and Virtual Schooling can be indistinct. There are indications from the World Wide Web that some Home Schoolers are quite comfortable with technology, and that they use online materials including those of Virtual Schools when they feel that they are appropriate. In both the online interpretation of

Home Schooling and Virtual Schools, students are educated through a Virtual Learning Environment (VLE).

## 2. REASONS FOR THE EMERGENCE OF VIRTUAL SCHOOLS

Virtual Schools have become an attractive option for some students and parents in recent years. Several factors account for the growth of Virtual Schools, including increased technological capability, the acceptance of technology in school education, the modeling effect provided by online alternatives in daily life, dissatisfaction with existing schools, the desire for increased flexibility in learning, economic rationalism, globalization, and vested interests.

Technological capability, in the context of online learning, refers to the potential for online computers to deliver educational programs in a timely, motivating and interactive way. While there have been forms of distance education for more than a hundred years, students' ability to interact with peers, teachers, and educational materials was reduced by the ways that predecessor technologies such as print, radio, and television relied on top-down publication or broadcast of materials. The development of the World Wide Web has meant that students can access online learning environments wherever there is a computer and phone line, and they are not usually constrained by the synchronous data transmission that have characterized radio and television. These environments can contain animations, movies, sounds, graphics, and interactive components. They are likely to prove interesting for students who have been conditioned by fast-paced mass media to expect dynamic presentations in their daily lives.

A related issue is access to the technology and acceptance of its use in school education. Virtual Schools can be accessed from homes, existing schools, or other areas where students can obtain an internet connection. internet connections are more common in industrialized countries where there is a sophisticated telecommunications network. It is not surprising that leading adopters of Virtual Schools should include the U.S.A., Canada, Australia, the U.K., and Israel. The widespread availability of such a network has contributed to the adoption of the internet in U.S. schools. Ninety-nine percent of public schools in the U.S.A. had access to the internet in 2002, an increase from 35% in 1994 (NCES, 2002). Where internet technology is commonplace in the community, it is likely that increased acceptance of its use in education will follow.

Daily life in the early 21st century provides numerous examples of online alternatives to conventional hands-on or non-mediated experiences. Mitchell (1995), in his book *City of Bits: Space, Place and the Infobahn*, discussed the ways in which digital spaces have provided alternatives to traditional locations:

I discovered—as did many others—that I no longer had to go to work.  
Not that I suddenly became idle; it's just that the work now came to me.

I did not have to set out every morning for the mine (as generations of my forebears had done), the fields, the factory, or the office; I simply carried a lightweight laptop computer that gave me access to the materials on which I was working, the tools that I required, and the necessary processing power . . . More and more of the instruments of human interaction, and of production and consumption, were being minimised, dematerialised, and cut loose from fixed locations. (pp. 4–5)

There are now online alternatives to the bricks-and-mortar places that have been part of our daily lives for hundreds of years. Banks, travel agents, bookshops, meeting places, libraries, and businesses all have an online presence. Virtual universities can also be added to this list. Dunn (2000) argues that there are now hundreds of university degrees available through distance education, and suggests that by 2025 the virtual university will be the predominant mode of higher education. Collectively, the online alternatives provide a modeling effect when people choose how they will live their lives. There is a reassurance that online activities are normal, and a reasonable choice that can be made. In the case of virtual universities, they provide additional evidence that education does not require attendance at a physical campus. As more students graduate from virtual universities, or complete online courses from a more conventional university, it can be expected that many households will contain parents with personal experience of online learning. Consideration of a Virtual School for students becomes more likely in this context.

In some countries a contributing factor to an interest in Virtual Schools can be dissatisfaction with the conventional school system. Concerns can include fear for students' safety or moral development, the apprehension that students are disadvantaged through under-resourcing, and inflexibility of curriculum. As Wellburn (1999) suggests, declining confidence in the public school system in the U.S.A. has led to the development of charter schools, and to parents taking their children out of the public school system altogether. It has also contributed to the popularity of the Home Schooling movement in the U.S.A., where as many as one million school children were home schooled in the period 1997–1998 (Stevens, 2001).

Devine (1996), discusses examples of inner-city New York schools where there are uniformed security guards, weapons searches, and violence is seen as normal. Less obvious are the concerns raised by Epp (1996), where schools are complicit in exclusionary practices, tolerate abuse, and are involved in other practices that hinder student learning.

Student dissatisfaction with conventional schools can result from a range of factors including a dislike of the institutional nature of schools and unsatisfactory academic progress. Thompson (1998) points out that school staffs are asked to take on a range of academic and social missions with insufficient staff and diminishing resources. When parents believe that classes are too large for effective learning, the school is poorly maintained, or the nature of school



organization hinders learning, they may be more inclined to consider the alternative of Virtual Schools. There are critics such as Tiffin and Rajasingham (1995), who believe that schools can be seen as part of a former industrial era, and those who accept this view might believe that existing schools are not always appropriate for the 21st century.

Organizational constraints also contribute to the perception that traditional forms of schooling are inflexible, and this can make Virtual Schools attractive in comparison. Conventional schools require timetabled classes if face-to-face teaching is to occur, and this means that, for other than elementary schools, the full range of classes may be unavailable for students. A hypothetical example illustrates this point. If a large senior high school contained students who wanted to study a range of foreign languages, but only a small number of students wanted to enroll for each language, it is likely that the school would be unable to afford a teacher for each language, even if timetabled rooms could be found. A Virtual School, in contrast, would be able to enroll students from a wide geographical area, and classes could be offered in asynchronous mode to enable students to complete their classwork when they wanted to.

Economic rationalism also contributes to the spread of Virtual Schools because, as Smith and Sachs (1995) argue, economic rationalism puts a premium on productivity, efficient use of resources, and value for money. One interpretation of how this theory can be applied to school education is, as Rutherford (1993) suggests, the perception that deregulation, private provision, and commercialization is preferable to government provision of goods and services. When some observers are able to view conventional schools as an inefficient use of resources, Virtual Schools can seem an attractive alternative. For administrators and politicians who have to budget for the infrastructure and buildings required for new schools, the possibility that a Virtual School will reduce these costs by allowing students to work from home can be tempting. Economic rationalism also promotes the commercial aspects of Virtual Schools because it encourages the provision of non-government schools, and it enables vendors to sell the software, which the teachers and administration at the school will use.

Globalization is also a contributory factor in the rise of Virtual Schools because the same use of online computers that enables globally oriented businesses to bypass geographical boundaries in order to access markets enables students to access a Virtual School from anywhere in the world. Students are no longer restricted in their choice of schools to those that they can physically travel to each day. Moreover, while it is likely that there will continue to be certification requirements for identifiable school districts, states, and areas, it is also true that the materials that students draw on to satisfy these requirements will increasingly be drawn from the internet. Increasingly, it will be possible for students to connect to their Virtual School from a number of countries, and they will not be restricted to the print-based texts in their community.

The extent to which vested interests are involved in the spread of Virtual Schools is difficult to estimate. Understandably, when Virtual Schools are introduced there is a corresponding need for administrators and teachers with expertise in online learning. The market for online modules, and for related hardware and software, will also develop. In short, Virtual Schools can advance the careers or commercial interests of those who promote them. As it is likely that the Virtual Schools will also satisfy an identified need for learners, self-interest will be difficult to untangle from public announcements concerning the reasons for a school's introduction.

A number of the factors identified in this chapter may apply to the introduction of a Virtual School. Variation can be expected depending on the cultural, educational, economical, and historical patterns that influence school education. Such variations also help to explain the differing ways that countries have introduced VLEs, or even why they have not been adopted at all. Dutton (2003) has observed that complex social processes can result in many different outcomes for the same technology, depending on choices made by people in the production, use, consumption, and governance of information and communication technologies. Hence, for Virtual Schools, the technological capability of users and administrators is not the sole determinant of adoption, and it helps to explain why some technologically sophisticated countries have shown little interest in the introduction of Virtual Schools. In addition, such explanations provide part of the answer to the question of why countries with similar online capabilities can introduce versions of Virtual Schools that are quite dissimilar.

In trying to understand the ways in which these social processes affect the characteristics of Virtual Schools, it is important to ask why students and parents would prefer a Virtual School to a conventional equivalent. Senior high school students who wanted employment during the school day would find the out-of-school variety of virtual school attractive. This situation is also likely to be true for students who are concerned with problems of violence and bullying in conventional schools, for students who live at a considerable distance or for those who are unable to travel to school because of inhospitable weather conditions. In contrast, the Virtual Schools which Brown and Weiss (2005) refer to as bricks-and-mortar schools with elements of virtual schooling, offer a less radical solution. Although the need to conform to timetables and geographic place suggests reduced flexibility, advantages including socialization and supervision can be identified.

### 3. MODELS OF VIRTUAL SCHOOLING

Several variations (or models) of Virtual Schools can be identified. The choice of school or home as learning site and the relative proportion of face-to-face and mediated interactions are among the distinguishing characteristics. In

this chapter, two contrasting models of Virtual Schooling are discussed, and this approach allows the exploration of relative advantages, disadvantages, and educational outcomes. The two models referred to are the *in-school* and *out-of-school* models, respectively.

The *in-school* model is exemplified by the Virtual Schooling Service (2003), in Queensland, Australia. This system uses a synchronous delivery system, primarily based on audiographics (Prendergast et al., 2002), with some additional support provided by asynchronous websites. Lessons are timetabled, with delivery schools providing a service to receiving schools. A Study Coach provides both an administrative function and student guidance.

Schnitz and Young (2002) refer to the type of Virtual School, which does not require school buildings as the *out-of-school* model. The Florida Virtual School is probably the most well-known example of this type. The Florida High School Evaluation (2002) notes that “there is no Florida High School building and students and teachers can be anywhere in the world” (p. 12). Florida Virtual School uses the slogan “Any Time, Any Place, Any Pace” (Johnston, 2004) and the approach emphasizes flexibility.

#### 4. KEY ISSUES IN VIRTUAL SCHOOLING

Russell (2004a) identifies a number of issues critical to an understanding of Virtual Schools, including flexibility, industrial models of schooling, socialization, student suitability for online environments, and teacher training and professional development. These concerns are explored in this section of the chapter, together with other consequences that might result from the adoption of a new educational paradigm.

#### 5. FLEXIBILITY

An advantage of Virtual Schools is the flexibility that results from the spatial and/or temporal separation of students, teachers, and learning materials. For both the *in-school* and *out-of-school* models a valuable aspect of this flexibility is the provision of teachers. The author’s research to date has not identified any Virtual Schools that have replaced teachers. The use of online computers has changed the ways that teachers work (Russell & Russell, 2001), and the application of them to Virtual Schools has enabled existing pools of teachers to be used more effectively. The *in-school* model allows schools to timetable subjects where there is no trained teacher available in the receiving school. However, the *out-of-school* model provides additional flexibility in this respect because it is not constrained by synchronous technology, and the organizational characteristics of bricks-and-mortar schools. Hence, a senior high school student in the *out-of-school* model could be employed during the

day and study missed high school subjects in the evening. Similarly, a student could attend a conventional school during the day and enroll for one subject in a Virtual School, which could be studied at a time convenient for the student.

## 6. INDUSTRIAL MODELS OF SCHOOLING

One of the reasons why parents or students may choose the out-of-school model of Virtual Schools is that conventional bricks-and-mortar schools can seem unattractive or inappropriate. Existing schools may be unable to meet student needs, and provide adequate skills for employment or tertiary entrance. There can also be concerns about pedagogy, resourcing, and safety. Schools as we know them may be remnants of a former industrial era, where it was appropriate to treat students as though they were part of a factory system. In this understanding of schooling, the organizational model required students to attend timetabled classes on a physical site, and undergo regimented procedures as they were processed through the system. For Perelman (1992), traditional schools are irrelevant and ought to be replaced with “a brand new high-tech learning system” (p. 20).

Virtual Schools can be seen as one solution to the problems arising from an educational design that has its origins in the factory era of the 19th and early 20th centuries. However, although schools usually retain industrial era characteristics, their organizational nature is more complex than might first appear. Beare (2001) argues that we are now in a post-industrial period where the concepts of market economy, increased responsibility, and reduced centralization and management teams are more likely to prevail. Consequently, the *in-school* model of Virtual Schooling retains all of the advantages and disadvantages of traditional schools. Virtual classes are timetabled within its organizational and physical constraints, but there may also be some benefits arising from face-to-face interactions. The *out-of-school* model, in contrast, can be seen as a more radical alternative in which the organizational problems of traditional schools are largely eliminated, but problems arising from reduced unmediated interaction are likely to increase.

## 7. SOCIALIZATION AND VIRTUAL SCHOOLS

The question of whether students are adequately socialized in virtual and conventional schools prompts a reflection on a more basic underlying question. What is the purpose of schools? The answer to this question is likely to reflect the role, position, and perspective of the respondent. While many would mention the development of skills and knowledge, or stress related certification and employment, others could refer to custodial functions while parents earn a living, the importance for the economy, or appropriate attitudes needed for

future life. The development of student attitudes and values has been a continuing educational theme in conventional schooling, and it has been reinforced both by the teaching of appropriate school subjects, and the ways in which learning experiences have been provided in schools.

Students will learn the norms and values of society by interacting with people, artifacts, and representations in a variety of contexts. This will include schools, mass media, the internet, and physical environments such as shopping malls. Public education, according to Moll (1998), has become the primary vehicle for the transference of national narratives, and of humanistic and democratic values. If students were to transfer from a traditional school to an out-of-school model of a Virtual School, the ways in which these values would be taught is uncertain. It is unlikely that a value-free school could ever exist. Consequently, students enrolled in an *out-of-school* model of Virtual School will interact with others online, and when they are not involved in school activities it is likely that they will meet with peers and others for social activities. The principles of honesty, respect for self and others, responsibility, and citizenship have been identified by Wagner (1993) by the use of school focus groups. With traditional schools, these principles are often reinforced by face-to-face relationships between students and teachers, and between students, in combination with institutionalized procedures such as assemblies and awards.

With the *out-of-school* model of Virtual Schooling, the mediating technology reduces the teacher's ability to support this traditional schooling role. With asynchronous technologies such as e-mail, teachers have a restricted ability to monitor students' affective responses because cues such as body language and facial expressions are absent.

If students were prejudiced against a particular group in society, the teacher of a virtual class in the *out-of-school* model might never become aware of it. Indeed, a student who does not want to respond to an online teacher can simply turn off the computer. Some Virtual Schools are aware of these problems. Odyssey Charter School (2003) offers a range of extra-curricular activities to supplement its academic program, including field trips, skate nights, holiday events, and choir. Children are also required to attend assigned group science class twice per month. While there is no guarantee that the provision of these activities will solve students' socialization problems, by planning for face-to-face activities it is likely that students will continue to be able to relate to others.

The socialization problem is less pronounced with the *in-school* model of Virtual Schools because it takes place within a conventional school. As such, the usual support structures provided by face-to-face teachers and peers, and by school organizational procedures, will continue to be available. The Virtual School component of the student's day is likely to be synchronous, providing the teacher with immediate feedback on a student's understanding. In addition, there are likely to be Study Coaches or other designated support teachers who can discuss the implications of online lessons with students.

It might be possible to argue that the in-school variety of Virtual Schools are inferior because they offer face-to-face classes, and that this was one element of schooling that proponents of the out-of-school model of Virtual Schools usually avoid. The objection, however, misses the point. The worth of a virtual school, or any other school, is determined by the congruence between the educational environment, curriculum, and the objectives of those involved. It is more appropriate to consider whether the interests of students, parents, and the community are being addressed than it is to compare an individual school against a theoretical framework.

#### 8. STUDENT SUITABILITY FOR ONLINE ENVIRONMENTS

Students' success in Virtual Schools is related both to the nature of the online learning provided and to the students' characteristics. Findings from a study by Del Litke (1998), based on an *out-of-school* model of Virtual Schooling, indicated that self-motivation, persistence, intelligence, and supportive parents were important factors. Some Virtual Schools offer online questionnaires for students, asking them about their independent learning abilities, motivation, and time management skills.

The problems are likely to be more pronounced in the *out-of-school* model of Virtual Schooling, because students are not constrained by teacher presence and timetabled classes. While students have the freedom to choose when they will complete their online schoolwork, they will still need the self-discipline to meet deadlines. Parental support is likely to be particularly important. If parents accept responsibility for supervising their child in an out-of-school model of Virtual School, they will need to provide adequate assistance.

Students involved in the *in-school* model of Virtual Schooling are less likely to suffer from this problem because the usual support structures should be in place, and the online sessions will often be timetabled in the expectation that the student will attend. Much, however, will depend on what assistance is provided. There may be a shortage of subject teachers for the area that the student is enrolled in, and this presumably is one reason why the course has been offered. However, the school will still need to provide assistance in areas such as counseling, time management, and information technology.

#### 9. TEACHER TRAINING AND PROFESSIONAL DEVELOPMENT

Teaching in a Virtual School requires both the acquisition of new skills and a reduced emphasis on some traditional skills. The teaching practices and class management skills used in face-to-face classrooms will differ from their online equivalents. Because Virtual Schools constitute only a very small proportion

of available schooling, there has been little modification by teachers' colleges and other providers of teacher education to existing courses, although teacher trainees will increasingly use online methods for some components of their courses. Training is likely to highlight teachers' professional development, rather than pre-service education.

Some evidence for this proposition is provided by the California Virtual School Report (2002). This report describes the use of online modules for teachers at Durham Virtual High School, in Canada, a 15-week teacher training program in Fairfax County School District, and professional development options at Virtual High School. There is also a mentoring program operating at Florida Virtual School, and a training program operating at the Cyber Schoolhouse associated with the Clark County School District in Nevada, U.S.A.

Although it is possible to identify characteristics of both *in-school* and *out-of-school* Virtual Schooling models, it is likely that teachers in both environments would benefit from tailored professional development. Prendergast et al. (2002: 35) have identified the characteristics for virtual teachers as including technoliteracy, flexibility, dynamism, grasp of subject content, experience as a classroom teacher, awareness of student learning styles, ability to use a variety of teaching strategies, enthusiasm, and confidence. A more specific response is suggested by Erlbaum et al. (2002) who outline a 26-week online course, which trains secondary teachers in online teaching practices and prepares them to design and deliver their own online course.

#### 10. VIRTUAL LEARNING ENVIRONMENTS: NEW PARADIGMS AND TENSIONS

The perception that the predominant mode of school education required students' collective attendance at a designated place, where trained teachers would educate them, has its origins in the 19th century. The adoption of universal education through the 19th and 20th centuries led to changes in educational practice. In earlier times, it was likely that either children would receive little education, or some instruction would be provided at home, by parents or tutors. The emergence of the in-school variety of Virtual Schools constitutes a potential paradigm shift that substantially returns the focus to the home as the instructional center. Thomas Kuhn (1970), in *The Structure of Scientific Revolutions*, noted that paradigms were examples of practice, and that these provided models from which particular coherent traditions were derived (pp. 10–11). Conventional schooling has coalesced into such a paradigm, and, as Von Dietze (2001) argues, it is consistent with the conformity of paradigms that the community involved seeks to suppress competing views.

Consequently, the opponents of Virtual Schools will include those who find it difficult to imagine any system other than that which they have always accepted. Conversely, Virtual School proponents would argue that the existing paradigm is inadequate. This explanation can include the notion that the

society for which students are to be educated has changed radically. Daily life combines unmediated and digital experiences, and the preparation of students involves a wide variety of functions that schools can address only with great difficulty.

Tension arises for educators in both conventional and Virtual Schools when they attempt to resolve the tensions that arise from the resolution of competing alternatives. Festinger (1959) argued that humans try to establish consistency among opinions, and that the decision between two or more alternatives leads to dissonance. In conventional schools, this can lead to questions such as the inclusion of digital literacies in the curriculum, or exploration of online environments. A school curriculum is a perpetually contested arena, where competing interest groups struggle to maintain their share of available instructional time. For Virtual School educators, critical issues are likely to be associated with the acceptance of Virtual Schools as an appropriate learning pathway. This can include the effectiveness of online environments in socializing students, or in providing online education that will provide the equivalent of experiential or face-to-face contact between teachers, students, and instructional materials. Some schools, such as the Fraser Valley Distance Education Centre (2002), invite students to complete their science work at home and send digital pictures or movies of their project to a supervising teacher. A number of Virtual Schools outline their curriculum offerings on related websites, and an examination of these websites indicates that some schools have resolved this issue by not offering face-to-face activities or subjects.

#### 11. VIRTUAL SCHOOLS AND THE REDUCTION OF EMPATHY

Virtual Schools can also be criticized because they represent a form of VLE where fewer information channels are used to transmit information than in a corresponding face-to-face class. Parks (1996) has argued that the cues emanating from physical settings are missing in online contexts. In contrast, the bandwidth available in conventional classes allows for the transmission of cues related to body language, and social and relational cues. The consequence of the reduction of these cues in Virtual Schooling contexts is that much of the information relating to the emotional and psychological states of teachers and learners is lost or misunderstood.

In the unmediated world, a continuing theme is that an increase in geographical distance between people can lead to a distancing effect. This can make it harder for one person to feel sympathy for another. Joseph Wiezenbaum (1972) believed that technology was implicated in the psychological distance between a bomber pilot and his victims. Similarly, in the online world, teachers and students may also suffer from a distancing effect. The long-term result may be that students in Virtual Schools may have a reduced ability to appreciate the concerns of others.



## 12. DISSIMILAR VALUES IN ONLINE AND UNMEDIATED ENVIRONMENTS

The problems arising from distancing can be better understood by considering the ways that values are transmitted or promoted in both conventional and Virtual Schools. Traditional schools promote values that they consider important, by overt and less obvious means. Teachers can see when students do not understand their work, or do not seem to appreciate the values that the school supports. As a result, teachers can adjust their teaching practices. In addition, the organizational nature of schools serves to support value formation, by practices such as school assemblies to reward students, attendance at chapel for religious schools, recognition of sporting achievements, and opportunities for community involvement. By these means, conventional schools promote qualities such as community and group cohesion. Schools' ability to encourage desirable attitudes is further strengthened by the greater ability to exercise power and control that is characteristic of face-to-face contexts.

In contrast, Virtual Schools rely on online interactions that often involve students using the internet from their homes. However, the values characteristic of the internet may be inappropriate. It is a global consumer culture where most people speak English (Ess, 2001). The web is also permeated by many websites, which implicitly support identifiable interpretations of democracy, individual freedom, sexuality, capitalism, individualism, and consumerism. However, some cultures can be expected to oppose these values. In addition, the ways in which media environments condition users are probably still not well understood. McLuhan and Hoskins (1989) once argued that the ways that media alter perception are more important than the content of media, and that we are not aware of these changes. The application of this argument to Virtual Schools suggests that the nature of the online environment itself will be an important factor in how students perceive the world. In addition, they may be unaware that their worldview is likely to differ from those of their conventional school counterparts.

## 13. RESEARCH AND VIRTUAL SCHOOLS

Much of the research on Virtual Schools is still speculative. Individual schools have published evaluations available over the internet, including the California Virtual School Report (2000), the Florida High School Evaluation (2002), and Virtual High School (Kozma et al., 2000). Others, however, provide few details of their operations. The problem is further compounded because some traditional schools and distance education centers offer online courses, and the identification of them as "Virtual Schools" is sometimes problematic. The reliable identification of trends over time is also difficult, as programs can change, and Virtual Schools can appear, or disappear. One recent survey

of Virtual Schools (Russell, 2004b) provides an indication of some virtual schooling trends, but the associated study was limited by the number of respondents. It is however, likely that the imperative to demonstrate educational quality will lead to schools publishing evaluations and reports as a matter of course. At present, there is a tendency for some Virtual Schools to promote their schools through websites that use student testimonials, advertizing slogans, and sophisticated web elements to impress potential students.

#### 14. CONCLUSION

Virtual Schools are one example of a VLE. Their emergence in the closing years of the 20th century and subsequent growth can be attributed to a complex combination of technological changes, economics, and views of learning. Although some characteristics of Virtual Schools can be identified, they are undergoing constant change. Consequently, the ways in which students can gain an online education are also changing. Although a number of advantages can be identified, there are still several disadvantages that will need to be overcome before Virtual Schools become more widely accepted. It is likely that as online computers become more powerful, interactive, and mobile, VLEs will become increasingly attractive for school students and their parents. This is likely to lead to an increased focus on the characteristics of online environments and a deeper understanding of the purposes of school education.

#### REFERENCES

- Beare, H. (2001). *Creating the Future School*. London: Routledge Falmer.
- Berman, S. (1999). The reality of virtual learning. *The School Administrator* 56(4), 6–11.
- Brown, R. S. & Weiss, J. (2005)
- California Virtual School Report. (2000). *The California Virtual High School Report: A National Survey of Virtual Education Practice and Policy with Recommendations for the State of California*. Available at: [http://www.uccp.org/docs/VHS\\_Report\\_lowres.pdf](http://www.uccp.org/docs/VHS_Report_lowres.pdf).
- Clark, T. (2001). *Virtual schools: Trends and Issues—A Study of Virtual Schools in the United States*. Available at: [http://www.WestEd.org/online\\_pubs/virtualschools.pdf](http://www.WestEd.org/online_pubs/virtualschools.pdf).
- Del Litke, C. (1998). Virtual schooling in the middle grades: a case study. *Journal of Distance Education* 13(2), 33–50.
- Devine, J. (1996). *Maximum Security: The Culture of Violence in Inner-City Schools*. Chicago: University of Chicago Press.
- Dunn, S. L. (2000). The virtualizing of education. *The Futurist*, Washington, March/April. Available at: <http://proquest.umi.com/pqdweb>.
- Dutton, W. H. (2003). The Internet and society. In: Barfield, C. E., Heiduk, G., and Welfens, P. J. (Eds.) *Internet, Economic Growth and Globalization*. Berlin: Springer-Verlag, 311–325.
- Epp, J. R. (1996). Complicity and sources of violence. In: Epp, J. R. and Williamson, A. M. (Eds.) *Systemic Violence: How Schools Hurt Children*. London: Falmer Press, 1–23.

- Erlbaum, B., McIntyre, C., & Smith, A. (2002). *Essential Elements: Prepare, Design and Teach Your Online Course*. Madison, WI: Atwood Publishing.
- Ess, C. (2001). What's culture got to do with it? Cultural collisions in the electronic global village, creative interfaces, and the rise of culturally-mediated computing. In: Ess, C. and Sudweeks, F. (Eds.) *Culture, Technology, Communication: Towards an Intercultural Global Village*. Albany: State University of New York Press, 1–50.
- Festinger, L. (1959). *A Theory of Cognitive Dissonance*. London: Tavistock.
- Florida High School Evaluation. (2002). *The Florida High School Evaluation: 1999–2000 Year-End Report for the Orange County School Board*. Tallahassee, Florida: Center for the Study of Teaching and Learning, Florida State University. Available at: [http://www.flvs.net/\\_about\\_us/pdf\\_au/fhseval\\_99-00.pdf](http://www.flvs.net/_about_us/pdf_au/fhseval_99-00.pdf).
- Florida Virtual School. (2003). *Florida Virtual School*. Available at: <http://www.flvs.net>.
- Fraser Valley Distance Education Centre. (2002). Available at: <http://www.fvrcc.gov.bc.ca/>.
- Johnston, S. (2004). Teaching any time, any place, any pace. In: Cavanaugh, C. (Ed.) *Development and Management of Virtual Schools: Issues and Trends*. Hershey: Information Science, 116–134.
- Kozma, R., Zucker, A., Espinoza, C., McGee, R., Yarnell, L., Zalles D., & Lewis, A. (2000). *The Online Course Experience: Evaluation of the Virtual High School's Third Year of Implementation, 1999–2000*. Available at: <http://www.sri.com/policy/ctl/html/vhs.html>.
- Kuhn, T. (1970). *The Structure of Scientific Revolutions*. Chicago: The University of Chicago Press.
- McLuhan, M. & Hoskins, H. (1989). Electric consciousness and the church. In: Sanderson, G. and Macdonald, F. (Eds.) *Marshall McLuhan: The Man and His Message*. Golden, Colorado: Fulcrum, 159–168.
- Mitchell, W. J. (1995). *City of Bits: Space, Place and the Infobahn*. Cambridge, Massachusetts: MIT Press.
- Mittelman, T. (2001). The establishment of a virtual high school in Israel. *Educational Technology Research and Development* 49(1), 84–93.
- Moll, M. (1998). No more teachers, no more schools: information technology and the “De-schooled” society. *Technology in Society* 20, 357–369.
- NCES. (2002). Internet Access in U.S. Public Schools and Classrooms: 1994–2002. Available at: <http://nces.ed.gov/surveys/frss/publications/2004011/>.
- Odyssey Charter School. (2003). Available at: [http://www.odyssey.org/about\\_faq.htm](http://www.odyssey.org/about_faq.htm).
- Parks, M. R. (1996). Making friends in cyberspace. *Journal of Communication* 46(1), 80–97.
- Perelman, L. (1992). *School's Out: Hyperlearning, the New Technology and the End of Education*. New York: William Morrow and Company.
- Prendergast, D., Kapitzke, C., Land, R., Luke, A., & Bahr, M. (2002). *Virtual Schooling Service Pilot—Two Year Review*. Brisbane: The University of Queensland.
- Russell, G. (2004a). Virtual schools: a critical view. In: Cavanaugh, C. (Ed.) *Development and Management of Virtual Schools: Issues and Trends*. Hershey: Information Science, 1–25.
- Russell, G. (2004b). Virtual schools: a critique of two models. *Paper presented at ACEC 2004 Australian Computers in Education Conference*, Adelaide, Australia, July 5–8, 2004.
- Russell, G. & Russell, N. (2001). Virtualisation and the late age of schools. *Melbourne Studies in Education* 42(1), 25–44.
- Rutherford, T. (1993). Democracy, markets and Australian schools. In: James, C., Jones, C., and Norton, A. (Eds.) *A Defence of Economic Rationalism*. St Leonards: Allen and Unwin, 151–159.
- SAEE. (2002). Executive Summary of E-Learning: Studying Canada's Virtual Secondary Schools. Available at: <http://www.saeec.ca/vschoolsum.html>.
- Schnitz, J. & Young, J. E. (2002). Models of Virtual Schooling. Available at: <http://www.can.ibm.com/k12/pdf/Virtualschool.pdf>.

- Smith, R. & Sachs, J. (1995). Academic work intensification: beyond postmodernism. In: Smith, R. and Wexler, P. (Eds.) *After Postmodernism: Education, Politics and Identity*. London: Falmer Press, 151–159.
- Stevens, M. L. (2001). *Kingdom of Children: Culture and Controversy in the Homeschooling Movement*. Princeton, New Jersey: Princeton University Press.
- Thompson, R. A. (1998). *Nurturing an Endangered Generation: Empowering Youth with Critical Social, Emotional, and Cognitive Skills*. Washington, D.C.: Accelerated Development.
- Tiffin, J. & Rajasingham, L. (1995). *In Search of the Virtual Class: Education in an Information Society*. London: Routledge.
- Virtual Schooling Service. (2003). Available at: <http://www.education.qld.gov.au/curriculum/service/virtual/index.html>.
- Von Dietze, E. (2001). *Paradigms Explained: Rethinking Thomas Kuhn's Philosophy of Science*. Westport, Connecticut: Praeger.
- Wagner, T. (1993). Systematic change: rethinking the purpose of school. *Educational Leadership* 51(1), 24–28.
- Wellburn, E. (1999). Vision, theory and technology for virtual learning in K-12. In: Feyton, C. M. and Nutta, J. W. (Eds.) *Virtual Instruction: Issues and Insights from an International Perspective*. Englewood, Colorado: Libraries Unlimited, 35–63.
- Wiezenbaum, J. (1972). On the impact of the computer in society. *Science* 176(12), 609–614.

## Chapter 14: Time, Space, and Virtuality: The Role of Virtual Learning Environments in Time and Spatial Structuring

ROBERT S. BROWN\* AND JOEL WEISS†

\*Research & Information Services, Toronto District School Board, Toronto, Canada;

†OISE/UT

There is no lack of speculation and theorization on the current and future roles of virtual schools. However, when one looks at virtual schools through the prism of the role of calendars—the chronological superstructure of schools—a different, rather less theoretical picture emerges. Many e-learning institutions call themselves virtual schools, but there is a continuum from “bricks-and-mortar” schools with elements of virtual schooling, to true virtual schools where all educational teaching and learning occurs in the virtual environment. At this time, more tend to have elements of virtual schooling than to be true virtual schools. Because of this situation, we will mainly refer to virtual schooling except for those situations where a true virtual school is in view. Much of the discussion of virtual schooling is ahistorical: From documents extolling virtual schools one would think virtual schooling dates from the widespread growth of personal computers and the World Wide Web in the mid- 1980s, whereas much of the structure is directly attributable to distance education which has existed for nearly two centuries.

There are three main types of time structuring in modern schools: The school calendar or chronological superstructure (usually used to describe the duration of study throughout the year, but also including the number of days in the week and the number of hours in the day); attendance and absenteeism of students (the degree to which students show up to school and to classes), and the organization of the school day (into classes, lunch, study periods, etc.). Each of these topics has received a fair bit of study. The key direction at this time in current calendar research is around the advantages or disadvantages of the full-year school versus the importance of the summer vacation (Gold, 2002; Weiss & Brown, 2003). Attendance has been examined both as a sociological phenomenon and for its role in student achievement (e.g., Brown, 1999). The importance of the organization of the school day was recognized by the authors of *Prisoners of Time*, the 1994 report of the National Education Commission on Time and Learning (1994). However, in a virtual environment, it is difficult to differentiate time structures: Therefore, an examination of the school calendar will look at all three of these issues. Given its key role in an understanding of virtual schooling, we believe it necessary to briefly discuss the concept of the “calendar”.

## 1. CALENDAR EVOLUTION

The calendar is a social invention. In his examination of the history of the modern calendar, Duncan (1998) noted, “We take the mechanism of the calendar for granted, as we do breathing and the force of gravity”. Yet this current, unexamined part of our lives is the result of a turbulent evolution that has had an important role in the development of today’s society.

For thousands of years the effort to measure time and create a workable calendar was one of the great struggles of humanity, a conundrum for astronomers, mathematicians, priests, kings, and anyone else who needed to count the days until the next harvest, to calculate when taxes were due, or to figure out the exact moment a sacrifice should be made to appease an angry god. A case can be made that science itself was first sparked by a human compulsion to comprehend the passing of time, to wrestle down the forward motion of life and impose on it some sense of order.

Likewise, the calendar of school is something that tends to be taken for granted. However, today’s elementary, secondary, and post-secondary time structures have been stable for only the past century or so. Contemporary universities proudly trace their descent to medieval institutions. In the High Middle Ages and early Renaissance, most elements of the university were still evolving and the time structures of the university year also changed substantially. According to the Catholic Encyclopedia, lectures were given throughout the year, with short recesses at Christmas, Easter, and Pentecost, and a longer vacation in summer. Throughout the High Middle Ages university calendars across Europe varied considerably.

In Germany, there was considerable difference between the calendars of the various universities and even between those of the faculties at the same university. In general, the year began about the middle of October and closed about the middle of June. But at Cologne, Heidelberg, and Vienna there was a break from the end of August to early October. The vacation, however, was not a complete suspension of academic work; the extraordinary lectures, given for the most part by bachelors, were continued, and credit was given to students who attended them. About the middle of the 15th century, the division of the year into two semesters, summer and winter, was introduced at Leipzig, and eventually was adopted by the other German universities (Catholic Encyclopedia, 1914).

Our research in Ontario, Canada (Weiss & Brown, 2003) as well as the work of Gold (2002) in Michigan, Virginia, and New York in the U.S., chronicles a similar fluidity in the evolution of the summer vacation in North American public schools as they evolved in the 19th and early 20th centuries. Looking at Ontario and Toronto historical documents, we found that legislation established the first minimum school holidays for Ontario elementary schools in 1850—a short two-week break between terms, the same as at Christmas. It would appear that, at this time, Ontario authorities were most interested in

ensuring that the new Ontario schools remained open long enough to ensure an education to those students who could actually attend. The 2-month long holiday we know today evolved between 1850 and 1913, when it was universally mandated across all schools. Although reasons for the growth of the summer holiday are not totally entirely apparent, the impetus clearly came from cities and urban areas; and rather than being the cause of the Ontario summer holiday, the farming communities were in opposition to it. Data for other jurisdictions suggests similar patterns of calendar development.

That the current academic calendars were most stable over the last century—the height of modern industrial technology—may be more than coincidence. And it is recent technology that has been instrumental in raising questions about the structure of the calendar through the possibilities associated with virtual schooling. In this chapter, for the most part, we discuss these issues for formal schooling, but we briefly touch upon some aspects of non-formal education, including the important area of professional development. Finally, we speculate on how the development of another learning environment, the library, may intersect with future activities in virtual learning.

## 2. FROM VIRTUAL SCHOOLING TO VIRTUAL SCHOOLS

There are a number of unresolved issues around day-to-day organization, such as the role of attendance (time on task, task completion, time on computer, versus time in the classroom) the roles and responsibilities of teachers and students, communication in a virtual environment, and what “success” means in such a context. The ability of current educational structures to absorb changes has been impressive, and at this time, the structure of electronic virtual schooling tends to resemble that of standard educational institutions. Yet the increasing popularity of virtual schooling is bound to lead to changes over time for both standard and virtual educational structures. Ultimately, these changes could redefine what is meant by public education, as the distinctions among virtual schooling and schools, charter schools, and home schooling becomes blurred, as does the distinction between formal and non-formal courses.

When one looks at virtual schooling as it relates to organizational structure, most examples can be segmented into four categories: Virtual elements as a supplement to already existing courses; virtual courses that grew out of the distance education tradition; virtual courses; and finally, virtual schools. As we have earlier suggested, the difference between, on the one hand, the labels of virtual courses and virtual schooling, and on the other, the label of virtual schools, is rather blurred. Many so-called “virtual schools” are actually intended for students attending regular “bricks-and-mortar” schools, and so are parts of schools in the traditional sense. An actual virtual school

is physically unlike traditional schools, although there are features such as planning, curriculum, and financing activities, all of which may be shared with bricks-and-mortar structures.

### 3. VIRTUAL ELEMENTS AS A SUPPLEMENT TO ALREADY EXISTING COURSES

Over the last number of decades, developments in various technologies have been integrated into instructional environments. Halyard and Pridmore (2000) outline the changes they have observed in the teaching of science, going from 8 mm film loop projectors in the 1960s; through overhead projectors, videotapes, and audiotapes; into the 1970s and 1980s with mainframe computers providing drill and practice through computer-assisted instruction (CAI); entering cyberspace in the early 1990s with CD-ROMs and low-cost computers introducing simulated labs; and, finally, the internet of the late 1990s as an intrinsic part of science instruction. The internet has become the student's "third hand".

But for most courses, this "third hand" remains a supplement to regular instruction—albeit one that, as Halyard and Pridmore speculate, is fundamentally changing and will continue to change this instruction. Thus, Witham et al. (2002/3) outline the use of WebCT, a multipurpose software package, to create an online supplement to their Earth Science course. Uses include class e-mail, hyperlinks, an online calendar, an online discussion board, and online handouts.

Using virtual elements in a course may also lead to the course becoming entirely virtual. Clark (2001: 3) found that a quarter of self-described virtual schools had been operating in 1995 or before. Many of these early start dates "appear to be referring to pilots of early internet-based instruction, or dial-up client server applications. Some of these organizations previously offered CAI as part of independent study packages, and gradually transitioned to online or internet delivery".

### 4. VIRTUAL COURSES THAT GREW OUT OF THE DISTANCE EDUCATION TRADITION

We have previously suggested that much of the discussion of virtual schools is ahistorical, and owes much of the structure to the earlier era of distance education, which has existed for nearly two centuries, and with CAI, which became fairly prevalent in the 1960s.

Formal distance education started in 1840 when Isaac Pitman began to teach by correspondence. In 1850, the University of London offered distance courses to students in British colonies, like India and Australia. In 1889,



Queen's University in Kingston, Ontario first started offering post-secondary correspondence courses. These 19th-century courses used writing and the mail service, but distance educational institutions have been among the first to utilize new technologies. In 1922, Pennsylvania State College and Columbia University began radio courses. In 1968, Stanford University created a television network. By the 1980s, TVOntario and the University of Guelph were experimenting with computer-based courses, including electronic e-mail systems, one of several such pilots taking place across the world.

Having the tradition of adapting new technologies to their already existing structures meant that the internet was easily folded into distance education courses in the 1990s. An example is Ryerson Polytechnic Universities' Open College distance education program, founded in 1969, and inspired by Britain's Open University. Ryerson offered its first credit course—via radio—in 1971.

Norquay (1993), the first Director of the Open College, stated that Ryerson had to fight the assumption that any course offered outside the bricks-and-mortar classroom was academically suspect. Therefore, it was thought necessary that the Open College courses were to be like Caesar's wife—not only did they have to be academically demanding, they also had to be *seen* to be academically demanding. This led to “extraordinary” efforts to match Ryerson's bricks-and-mortar academic structure.

Ryerson's standard full credit course in the Faculty of Arts called for two semesters, each semester consisting of three contact hours per week for thirteen weeks, for a total of 78 hours (less three or four when a holiday or special event intervened). Open College hours, therefore, were carefully planned to total 76, on the basis that radio hours were a full sixty minutes, not the classroom fifty minutes. There would be 48 hours of radio programming and two study weekends (one per semester), each with fourteen hours of lectures and discussion . . . ten television programs were planned as “enrichment”, but they were not regarded as crucial for course content. In addition to listening to 48 broadcast hours and attending two study weekends, the students completed thirteen assignments, a minor and a major essay, a mid-term, and a final examination. These requirements, more rigorous than those required of regular classroom students, were built into the course to assure that it would be regarded as academically worthy.

(Norquay, 1993: 75–76)

By the late 1980s, Ryerson was offering 27 courses through a combination of radio, audiocassette, and correspondence. The current (2003/4) course calendar shows that the number of courses has dramatically increased (to over 100). Courses are offered in print, on the internet, or on audiocassette. Students submit assignments in person, by mail, by fax, or by e-mail. The

courses (many of which can be applied to a degree or certificate program) are still located within the regular Ryerson academic calendar.

There are no references to “virtual reality” in the Ryerson calendar. In fact, it is easy to miss the references to the internet altogether. Ryerson has clearly added the internet to its already-existing distance education system; a system in itself consciously modeled on the structure of the mother university—itsself a modified version of a medieval institution. It is difficult to find a clearer illustration of the resiliency of institutional organizations.

Britain’s Open University reiterates the difference between distance education and virtual schooling. In “E-learning at the Open University” available through the Open University’s main web page, the Open University states that it “has always been a world leader in the use of new technologies to improve the quality of education for students and to broaden their access to it”, and that it is regarded as Britain’s major e-learning institution. However, the document also notes that the Open University does not strive to become an “online university”. Instead, the University believes that “the best outcomes for learning are usually achieved by striking a balance between using traditional and new media, individually selecting and developing the products that are best suited for each purpose”. It is essential to provide the right balance of text, audio, video, interactive simulations, database resources, IT tools, and communication environments.

## 5. SOME THOUGHTS ABOUT LIBRARIES

Libraries have traditionally been closely associated with schooling as an important learning resource. Both the school library and the public library system have been used to augment classroom teaching–learning activities. The public library is always available for those situations like virtual schooling, home-schooling, and charter arrangements that may bypass the formal school structure. The development of the e-library (see chapter by Brophy in this volume) potentially magnifies the importance of virtual learning sites.

The library is in some ways the ultimate institution of self-directed learning. Perhaps in the best of all worlds, the properly educated person should be able to take advantage of the guidance and facilitation of a library (through the library’s organization, its support materials, and the expertise of its staff) to be able to design and implement his or her learning, whether this be in the context of a specified curriculum or research project. Although this guidance and facilitation has not traditionally taken the form of courses in the formal educational system, it is possible that it might in the future, given how the format of “virtual courses” are becoming more common in aspects of professional development, and in various forms of schooling. How would this change the time structures of schooling? One reason for the growth of virtual libraries has been their ability to facilitate and provide quick response

to interactive inquiry. Such a dynamic could ultimately lead to a change in the way courses are organized—and it is a safe bet that this change will be different from whatever we can speculate about now.

Much of this speculation is dependent on changes in the school calendar in the form of year round schooling, growth in charter schools, and home schooling, as well as any realistic notion that virtual schooling will become more feasible, not to mention “true” virtual schools. There are many issues that are necessary to be resolved before there is realistic expectations for major influx of the “true” virtual school: Politics, resource availability, technological advances, a trained and willing teacher complement, as well as resistance to radical change in one of our most conservative institutions. We are starting to see changes in higher education, and in the workplace, but formal schooling, as we know it might be more resistant to such a radical development.

## 6. VIRTUAL COURSES AND VIRTUAL SCHOOLS

The number of virtual schools appears to be growing; according to the 2003 Tech Trends survey done for Education Week (Ansell & Park, 2003) U.S. 16, states had virtual schools and 24 allowed cyber charter schools. It should be noted that the Tech Trends survey looked at elementary and secondary virtual schools only. Researchers looking at California’s e-line learning potential felt that the virtual educational system should be designed for all levels of education, serving students from kindergarten through graduate school (Trotter, 2002). Currently, this is a distant ideal. The discussion of “cyber schools” tends to revolve around the elementary and secondary levels; post-secondary courses are more likely to be offered through already-existing universities and colleges, and often reflect the pre-existing “distance education” dialogue. However, there are post-secondary institutions such as the University of Phoenix, which specialize in online programs, including the granting of degrees.

Elementary/secondary and post-secondary schools appear to be separated in virtual reality as they are in regular education, or in real time. In part, this may be due to organizational structure, with elementary and secondary schools having entirely different systems of certification and authority and funding. The evolution of many distance education courses in post-secondary institutes prior to the growth of the internet may have heightened the divide. Of course, we cannot overlook the fact that these types of institutions operate on different calendars: An 8–9 month university school year versus a 10-month elementary/secondary organizational structure.

Clark (2001) provides one of the most comprehensive examinations of virtual schools to date. He lists several categories of virtual schools: State-sanctioned; state-level (sanctioned by the state government to act as the state’s own virtual school); college and university based; consortium and regionally

based; local education agency based (created by local public school and school districts); charter schools; and private schools.

At this time, most so-called cyber schools offer only a selection of courses rather than the full range of educational requirements. For example, the Virtual School of the Toronto District School Board offered twenty-three secondary school courses in 2003, a fraction of the total available credit courses in the district.

Clark (2001) notes that the majority of students are taking courses from virtual schools that are supplemental to their “regular” high schools—that is, they attend bricks-and-mortar high schools, and use virtual courses as additional options. These students (and courses) would be following the traditional school calendar: Regular school year semesters, or summer school.

There are some interesting exceptions, although these appear to demonstrate the dynamic tension of providing “regular” courses within a virtual environment, and how calendar may allow flexibility. The Virginia Internet High School offers 90-day courses, although some remedial 45-day courses are also available (Rutkowski, 1999). The Florida Virtual High School (FLVS) is the largest virtual school in the U.S., and is regarded as an industry leader. The motto of FLVS was learning at “any time, any place, any path, any pace”. However, the school found that large numbers of students in “any pace” courses were not completing them. As a result, the school modified its “any pace” pledge to adopting three time frames: The standard 9-month schedule; an accelerated 6-month schedule if students feel comfortable with the course material; or an extended, year-long schedule, if they think they need more time (Doherty, 2002). The COOLSchool of Eugene, Oregon allows students to work on courses at each student’s own pace—but within the 10-month school year.

## 7. ISSUES OF VIRTUAL SCHOOL ORGANIZATION

Although the overall structure of virtual schooling tends to resemble that of standard educational institutions, there are a number of issues around day-to-day organization that bear discussion. These issues may define the differences between the time structure of “bricks-and-mortar”, and that of virtual, schools.

### 7.1. What is Meant by Attendance in a Virtual School?

What is written about attendance in a virtual school is not especially consistent, perhaps because virtual schools are at an early enough stage of evolution that there is limited consistency in their composition and characteristics. As noted earlier, at this time most students taking virtual courses are actually attending “bricks-and-mortar” schools and taking virtual courses as a supplement, so

“attendance” in the virtual school would only refer to working on one or a few courses. Schools usually have legal penalties aimed at students physically absent from the school for a certain amount of time (truancy requirements for those below the age of school leaving, deletion from the school rolls for those at or above the school leaving age). It is unclear how overall school attendance is calculated for those students taking both face-to-face and virtual classes.

According to Clark (2001) many virtual courses were developed for primary use within regular instructional time in public K-12 schools (for example, for students wishing to take courses not available at the school). Thus, these students are (or may be) physically present in the school while taking the virtual course. Students can always work at these courses during non-school hours, presuming they have online access. Of course, this is no different from students spending time on non-virtual courses outside of school hours.

Moreover, looking specifically at course attendance rather than attendance at the school, the term is still unclear. In a physical environment, class or course attendance simply means that the student is in the general vicinity of the teacher, regardless of whether learning takes place (as many teachers can testify). In the virtual environment there is no clear replacement for this physical link, since many or most students are working on the course after school, in the evenings, late at night, or on weekends (Doherty, 2002). Educational providers do try to monitor and/or enforce attendance. Some courses monitor attendance using the number of “hits” (Witham et al., 2002/3). Others have logs that are verified by the parent (Bowman, 2003). Both have issues of validity. Numbers of “hits” may merely show that the student (or, someone signed on as the student) has made a connection to the course, but with today’s multitasking computers that may well be like a student signing into their homeroom class in the morning and never attending any actual courses. Hurley’s account of attendance at a virtual school shows some of the problems of both logs and self-paced courses:

Flexibility regarding when work could be done led to problems for some students. It was common for a portion of the week’s work to be put off to the weekend, resulting in long hours on Saturday and/or Sunday to meet the time quota. Also, because a learner-level user [in the PLATO system] cannot effectively call up a record of time logged on, some students found that they had trouble remembering to record their sessions properly. Those who failed to log the minimum hours were warned, counseled, set up with schedules to log extra hours, and, when necessary, removed from the program.

(Hurley, 2002: 34)

Ultimately, the concept of “attendance” in a virtual course or virtual school may have to be fundamentally modified. Many post-secondary institutes do not have clear attendance and absenteeism requirements. Students are expected to

hand in assignments and attend exams, without necessarily attending classes. This is the ultimate direction, a “laissez faire” approach to schooling pioneered by Robert Hutchins of the University of Chicago in the middle of the 20th century. However, since there is a clear, linear relationship between absenteeism and secondary school success in “brick-and-mortar” schools, such a process (and the lack of monitoring for signs of “at risk” absenteeism) may dramatically increase the number of course non-completers (Brown, 1999).

Perhaps virtual schools will agree on some sort of compromise attendance process, combining time-on-task and task completion. Currently this does not appear to even be at the discussion stage, but the issue has the potential to be a divisive problem as virtual instruction becomes more widespread in school systems.

## **7.2. What is Communication and Instruction in a Virtual Course?**

It is all very well to talk about “24/7” as an advantage of virtual schooling, but if this means the ability of the student to get onto the computer and work on assignments, there is little difference from completing pen-and-paper assignments. However, the difference may be in the roles that teachers play. There appears to be a wide range of roles undertaken by the teacher in the virtual setting, and in the methods of the virtual teacher in interacting with the students.

According to Clark (2001), a majority of virtual schools appear to be using web or internet instruction as their only distance learning method. However, this does not mean that virtual schools are entirely “virtual”. As noted above, the philosophy of many schools that call themselves “distance education” providers (such as the Open University) is to use whatever technology is best for the match of learner and instruction, including the internet but with many other possible directions. In addition, Clark points out that many schools are part of organizations that offer conventional, face-to-face education; that traditional independent study programs sometimes have web-based courses as a parallel offering to traditional independent study methods; that some require on-site meetings or offer optional activities like field trips; and that print-based study guides traditionally associated with independent study are used by some schools (Clark, 2001: 7).

Three of the schools profiled by Joiner (2002) illustrate the potential range of structures. Courses in the Virtual High School in Hudson, Massachusetts have no live meeting times. But with the CCS Web Academy of North Carolina, students must meet with online instructors at a pre-determined date and time. Students from the Basehor–Linwood Virtual Charter School complete assignments at their own pace but submit weekly progress reports, and exams are proctored at specific locations.

Also, classes can be taken at any time (asynchronous) or teachers and students might be required to log in at the same time each day (synchronous), or, a combination (Vail, 2002). Synchronous classes are very similar in structure to the regular school calendar, but they also reduce the flexibility that is supposed to be one of the key advantages of the virtual course.

Several articles on virtual schools stress the difference between face-to-face teaching and virtual teaching (e.g., Vail, 2002). Among some of the differences outlined by Melnick (in Owen, 2002) are:

- With no face-to-face time between teachers and students, all interactions must take place and be supported by technology. If the technology fails, so does the learning.
- Teachers need to become experts in myriad technologies, often without benefit of formal training.
- Courses need to be continually modified by teachers as links to existing resources change and new online resources become available.
- Curriculum has to be written with consideration given to the specific technology that will be used for delivery.

There are some types of activities that may never make the transition to an entirely virtual environment. Bowman (2003) looks at the physical education course offered through the Florida Virtual High School. Students are required to exercise, but the ultimate usefulness of the course has its critics. Halyard and Pridmore (2000) wonder about the absence of the “wet” nature of science labs in the virtual environment, and whether this provides the opportunity to “really” experience the exercise. Perhaps technology may ultimately make this distinction meaningless, as portrayed in the world of Arthur C. Clarke’s science fiction classic *The City and the Stars* (Clarke, 1968).<sup>1</sup> But at least for the immediate future some experiences cannot be replaced in cyberspace, and these will need to be integrated into the time structure of virtual schools.

### 7.3. Time Structure and Governance

What “time” means in cyber schools also brings up a host of issues related to school governance. As Payne (2002: 48) points out, “one of the biggest drawbacks to online education is that no standards currently exist, meaning a school district could have to pay for cyber education without the slightest knowledge that the student is learning anything except how to log on to a computer”.

It might be worthwhile to recall how the supervision of curriculum in the public system evolved. In 19th century Ontario (a fairly typical example), prior to post-secondary education there were no “credits” or formal courses of the sort we take for granted today. A reasonably small proportion of students

wrote exit exams (for the end of elementary school and secondary school) and entrance exams (for entering high school and university). The quality of instruction in schools was validated by a complicated hierarchy of regional school “inspection” (hence, the name of the official in charge was usually “Inspector”). One role of the Inspector was to physically visit schools to ensure that instruction was both standardized and of sufficiently high quality. This was complemented by having a reasonably consistent (some might consider as rigid) curriculum and to have a standardized time structure, both throughout the day, and throughout the year. In addition, public “success” in an educational system meant the degree to which the system could get students to come to school and stay throughout the year; this also increased the importance of the time structure of the calendar. Over the century, inspection and external validation of education has to a degree been replaced by standardized tests; entrance and exit exams have been replaced by credit completion requirements (and in some cases, re-instituted in the form of school-leaving competency examinations); the concepts and practices of teaching has changed out of all recognition; and courses have dramatically increased in both scope and variety).

Yet in spite of all of this, the time structure of schools has remained remarkably unchanged—perhaps, in part, because it adds consistency in the governance of a rather large and unwieldy set of institutions. In general, the more formal the governance structure, the more rigid the time structure. When looked at this way, the virtual school’s evolving use of time may provide yet another challenge to bringing acceptance by mainstream education.

## 8. ALTERNATIVES TO TRADITIONAL COURSES

From the above description of the format of virtual schooling, it is likely that although the technology used in the formal virtual environment has changed, the fundamental morphology of the courses has not. Courses are nearly always offered within the calendar of the mother institution—usually semesters over the regular school year, with additional options for summer school. (The limited exceptions, as with the FLVS, may be exceptions that prove the rule.)

However, when most people think of “courses” they tend to think only of those offered in the formal education system: Instruction by accredited educational authorities as a component of graduation, whether the graduation is from elementary school, secondary school, or post-secondary institute. In addition to traditional credit courses, there are also courses for professional development in a variety of fields, and non-formal or self-directed learning courses. These appear to have a much wider range of calendar options, in both bricks-and-mortar and virtual environments.



### 8.1. Formal Courses for Professional Development

In the 19th and 20th century, accredited instruction in such fields as medicine, architecture, and law came from various apprenticeship and certification practices recognized by tradition. The “articles” of law practiced by Dickens’s David Copperfield in his employer’s workplace, which would have led to Copperfield becoming a lawyer after several years of clerkship, is a well-known literary example. In late 19th-century Manitoba, this “consisted of five years of apprenticeship (three in the case of university graduates) under articles of clerkship to a practicing lawyer. At the end of the period of articles, each student had to pass an examination prescribed by the Bar Society” (*Historical Sketch of Legal Education in Manitoba*, <http://webapps.cc.umanitoba.ca/calendar99/faculties/law/history.asp>).

Most of these programs evolved into training and accreditation through formal and standardized university fields of study. In Manitoba, a provincial law school was established in the early 20th century under the joint authority of the Law Society and the University of Manitoba, which became the Faculty of Law in 1962. One can see this process today in the requirements for certification by various accounting societies such as the Certified Management Accountants association. Today, professions are more likely to provide courses for upgrading or maintaining skills and practice. The courses are provided (or at least regulated) by the professional organization rather than the formal education system.

Not surprisingly, many of these professional development or upgrading courses have evolved into the virtual environment. Thus, Microsoft offers a certification program where courses can be completed entirely online. The size and influence of Microsoft, and the effort provided by Microsoft to regulate the courses, have provided this certification by a private company a similar “cachet” to certification by professional organizations.

And unlike formal school credits, these courses may not have a set calendar—they do not necessarily start and end on a standardized and relatively inflexible date. There is more likely to be a set of chronological conditions, e.g., that the requirements must be completed by a certain time after the (often arbitrary) start date. In Ontario between 2000 and 2003, certified teachers were required to complete an average of three professional courses a year. The courses were regulated, although not provided, by a provincial authority, the Ontario College of Teachers. There was a range of course providers, often Ontario school boards. In the Toronto District School Board, the Staff Development department provided half day, one day or multiple day conferences on selected topics; it also provided virtual courses where teachers could register at any time and complete on a completely open basis.

## 8.2. Non-Formal/Self-Directed Learning Courses

These courses are taken for the interest of the learner, whether for professional reasons or for pleasure. As with distance education, non-formal courses have a long tradition, for example, with the “Mechanics” and “Workers” institutes that became prominent across Ontario during the mid-19th century. These types of courses have also utilized “new” technologies as they became developed. For example, starting in the 1970s, TVOntario started to provide non-formal learning “telecourses” that consisted of a television component, along with support materials that always included print (usually a textbook and/or a viewers guide) and sometimes included audio tapes, CAI, and human contact such as telephone tutors.

Participants sometimes signed up for the courses in a rather casual manner (often on a whim) but their use of the materials was focused: Rather than using materials according to the organizational plan of the course designers, they strategically located and synthesized the information they needed. Participants also noted that they signed up for TVO telecourses rather than bricks-and-mortar courses because they found telecourses more convenient, or they were too “busy” to take a regular course, or they preferred to learn at their own pace (Brown & Constantin, 1992).

In other words, these learners preferred telecourses because of characteristics that tend to be consistent with the virtual environment. The internet has provided verdant ground for the growth of non-formal courses (e.g., the online non-credit courses offered through Louisiana State University in Shreveport).

The difference between non-formal and formal courses for professional development may in some cases have to do with the intent of the learner than the actual structure of the course. In 2001, the Ontario Ministry of Education had mandated that teachers take an average of three professional courses a year, in order to maintain their certification. The requirement was extremely contentious and was opposed by the teaching associations (and ultimately was abolished in May 2004 following a change in provincial government). Offering these mandated courses put professional development suppliers such as the TDSB into a bind. As a result, the courses were offered, but whether they would be taken for certification, or taken for professional (but informal) interest was left to the discretion of the student. Thus, the only difference between a formal course taken by one student, and a non-formal course taken by another, would be a decision by the first student to submit the course to the Ontario College of Teachers. Furthermore, the submission to the College of Teachers could be made after the course had ended—no one would know at any given time during the course which student was taking it as formally, and which was taking it non-formally.

The time structure of self-directed courses—always broad—has become extremely elastic with recent technological changes. Initially, TVO telecourses

had the limitation of their broadcast schedule. With the increased availability of videocassette technology in the 1980s, even this structure became irrelevant. On the internet, the calendar of self-development courses becomes more philosophical: The calendar is dependent upon when the student is engaged in his/her inquiry of knowledge, balanced by some loose technological and administrative constraints: How long the course is available through internet access, how long the student is allowed to log on to gain access to course material or to work on tutorials. If the student is accessing a course through CD-ROM rather than through the internet, even these limitations may be irrelevant.

## 9. FUTURE DIRECTIONS

While virtual schools may have greater similarities to their technological predecessors than some virtual school proponents would like to believe, differences are major enough that they should lead to some very new structures in education. There is a possible analogy of how the virtual school may change school calendars, with now the sorting of students into age-based grades evolved between the 19th and 20th centuries. The later was a compromise of administrative consistency and pedagogical efficiency.

### 9.1. Time on Task: a Proviso

Elsewhere in this volume, Russell (2004) makes the point that virtual instruction is quite different from regular instruction, and many instructors tend to find it more “time consuming” than comparable instruction for regular “bricks-and-mortar” schooling. The same might be said of the experience of many students. It is a common finding of distance education research that distance students tend to have higher achievement than regular students. This may be because they are a self-selected group—are voluntarily seeking further education, are older, and are highly motivated and self-disciplined (see <http://www.uidaho.edu/eo/dist9.html>). Such self-discipline is often needed because a distance education course may require more time than a comparable on-campus course (e.g., <http://www.regent.edu/acad/schedu/defaq.html> for a brief overview of this).

Looked at optimistically, the possibility that virtual education students and curriculum designers will spend more time than their “bricks-and-mortar” equivalents suggests that virtual learning environments motivate students to spend more time at schooling. Less optimistically, it could be a limitation on the potential growth of virtual classes. There appears to be little discussion about how an increase in “time on task” would change virtual time structure

(perhaps because theoreticians may be happily assuming that virtual schooling will decrease time on task). Since students have only so many hours in the day to spend on school, would the number of courses decrease? Would homework decrease? Would the number of school days in the school year increase? It will be interesting to see how this plays out.

## 9.2. The Blurring of Spatial Boundaries

In January 2004, the Wisconsin Education Association Council filed a lawsuit challenging the legality of the Northern Ozaukee School District's online charter school, the Wisconsin Virtual Academy. The suit contends that the district violated state law by enrolling students from outside its boundaries (the academy is run by the school district in conjunction with K12 Inc., the company led by former U.S. Education Secretary William J. Bennett) (Johnston, 2004).<sup>2</sup> In this example, we have the intersection of several organizational possibilities: A virtual school, run as a charter school at public expense, for children being home schooled.

Perhaps what is most telling about this lawsuit is the fact that it occurred at all. Not too long ago, it was taken for granted that "regular" public education, home schooling, and charter schools were separate institutions. The lawsuit shows that the distinctions are starting to blur. The possible modification of school attendance areas may introduce another element of uncertainty into the time structures of virtual schools. Although the written documentation of many virtual schools use "24/7" as a catchword, the fact remains that most virtual schools had tended to be locally based—in the city (or, at best, state/province) in which the physical plant of the virtual school is located. Slowly, things may be changing. The TDSB Virtual School is intended for students living in Toronto, but it also includes students from outside Canada (including several from China).

Such cases—where physical attendance even for introductory meetings becomes impossible, and where teachers are living in a different day than their students—are infrequent enough at this time that they have not challenged thinking about the time structure of schooling. This may not be the case in the future. It is telling that the Wisconsin lawsuit raises some issues on the structure of "out of area" attendance, since physical catchment areas are irrelevant. It has been wryly observed that money will change an educational issue from vaguely abstract to immediate and urgent. Perhaps public educational systems may have greater incentive to emphasize virtual schooling in their regular curriculum and structures in response to perceived funding shortfalls. Enrolling "virtual students" potentially represents additional revenues, but more information is needed about the costs of virtual schooling before judgments of financial viability can be made. These issues—finances, charter schools,

private provisioning of education—in conjunction with virtual schooling, may well help to elevate time structural issues into mainstream discussions.

### 9.3. The Blurring of School Institutional Boundaries

Earlier, the LSU Shreveport online courses were pointed to as an example of non-credit courses being offered through the internet. However, a closer examination of these courses show that many are components of professional certification in such fields as travel, IT and health sciences (see [http://www.lsus.edu/ce/online\\_courses/gatlin\\_online\\_courses\\_2003.htm](http://www.lsus.edu/ce/online_courses/gatlin_online_courses_2003.htm)). Thus, doctors can use these courses for professional development; software engineers can maintain or upgrade their Microsoft certification. Some of the course providers appear to be “for profit” enterprises; others are professional associations. By “non-credit”, LSU presumably means non-credit for its own post-secondary degree requirements.

Although exact figures are hard to come by, there is no question that these types of professional development courses are becoming more common as the use of the internet has become commonplace in so many areas of society. As the LSU Shreveport example shows (and has been seen elsewhere in this chapter) the difference between formal and non-formal study is becoming blurred at times.

To put this in historical context, there has been fluidity in the relationship between professional societies and formal post-secondary institutions: Many faculties of medicine, dentistry, nursing, law, business, and teaching started as institutions outside the formal university structure that were gradually integrated (or, perhaps, assimilated). For example, the School of Dentistry for Ontario was founded in 1875 by Ontario’s professional governing body of dentists, the Royal College of Dental Surgeons, who had responsibility for professional training and education. Between 1888 and 1925 the school gradually changed from control of the College of Dental Surgeons to that of the University of Toronto (see <http://www.utoronto.ca/dentistry/abouttheschool/aboutback.html>).

A difference at this time is that many, perhaps most of the associations now offering internet upgrading and certification courses are aiming their “product” (to use the current nomenclature) at people who are already working professionals or, at least, working full time. As the trend continues, there are many different possibilities. The widespread nature (or, at least, quantity) might modify the time structure of the virtual university structure—although the fabled ability of the university structure to resist change may make this a challenge. It is just as likely, based on previous historical developments, that professional associations will adapt themselves into the current virtual university structure.

## CONCLUSION

In April 2004, MIT announced a new course-management platform called Caddie.net, designed to give educational institutions more flexibility in managing both on-campus and distance education programs. According to an online article in e-School News,

...the framework—which schools can download free of charge—supplies basic applications for course management and scheduling, while enabling users to build customized portals designed to meet the specific needs of a particular class or campus organization.

Developers are touting the program as more versatile and easier to use than leading commercial course management solutions, such as those provided by Blackboard Inc. and WebCT. What's more, they say, the program will save schools money by cutting down on IT costs and streamlining the process of updating web services applications such as campus events calendars, class schedules, and student rosters.

(Murray, 2004)

This particular technological innovation may or may not succeed; but the article clearly shows that this is one of several software innovations that, collectively, could be an important step in the evolution of virtual schools and schooling. Yet so far, such innovations appear to have had a comparatively limited influence on the time structure of virtual schooling, which appears much closer to “bricks-and-mortar” scheduling than one might expect from the current rhetoric around e-learning.

The school calendar is a social construct that been taken for granted, but has tended to be extremely variable in the past. The North American elementary and secondary school calendars have provided a dizzying series of permutations throughout the 19th and early 20th century, before stabilizing into the format we tend to regard with the agelessness of the pyramids. Yet currently, there appears to be limited experimentation by virtual schooling and schools with elementary, secondary, and even post-secondary academic calendars.

This lack of calendar variation may be a consequence of the relatively small number of truly virtual schools. Many of what are called virtual schools actually are virtual schooling components to existing schools. They are not truly different institutions, but consist of some layer of virtuality to already-existing regular school structures—the assigning, research, and marking of assignments through the internet, for example, or the offering of a range of courses designed as a supplement to a student's regular curriculum. There simply may not be enough truly virtual schools, operating consistently for several years, to observe recognizable modifications to the traditional time structures.

But it is likely that there will be some sort of systemic change, if for no other reason than simple economics. Although many think that the advantage of virtual school as currently organized is that they will lower the costs of education, they may not be cheaper to operate than traditional schools. Several have reported financial difficulties and some states are tightening up their auditing requirements (“Virtual-School Costs Under Siege”, Gartner, 2004). “Necessary as the mother of invention” is one cliché with much truth behind it, and the time structures of virtuality will doubtless evolve in consequence. This can already be seen in a limited way with professional development courses and schooling.

Speculating on what directions this evolution will take may be fun and intriguing but will doubtless be at least in part inaccurate. A central premise of Tenner’s “Why Things Bite Back: Technology and the Revenge of Unintended Consequences” (1996) is that technological advances will often lead to developments entirely different from their original intentions. The final (or, at least, stable) time structures of virtual schools will probably follow this pattern.<sup>3</sup>

#### ENDNOTES

1. This brilliant 1953 tale outlined a world of virtual reality in the far future. Like other of Clarke’s works, it also showed the ultimate sterility in relying entirely on computers.
2. According to the January 21, 2004 *Education Week* article, the suit also charged that because the charter school’s students are typically directed by their parents or another adult, the virtual school violates a state law requiring public school students to be licensed instructors: Another potential issue as virtual schools, and their association with charter instruction, becomes more widespread.
3. “Intensive antibiotic therapy has removed the horror of some of the nineteenth century’s most feared infections, yet it has also promoted the spread of even more virulent bacteria. Massive shielding of beaches from the energy of waves has deflected their intensity to other shores or robbed these beaches of replenishing sand” (Tenner: 255).

#### REFERENCES

- Ansell, S., & Park, J. (2003). Tracking Tech Trends. *Education Week* 22(35), 43–44, 48.
- Bowman, D. (2003). Internet spawns online physical education. *Education Week* 22(20), 3.
- Brown, R. (1999). *A Study of Absenteeism in the Toronto Board of Education, 1850–1997*. Doctoral. diss., OISE/University of Toronto.
- Brown, R., & Constantine, D. (1992). Distance education at TVOntario: an analysis of english and french registrants in non-formal courses. *Journal of Distance Education* 7(2), 77–88.

- Catholic Encyclopedia. (1914). Universities. Available at: <http://www.newadvent.org/cathen/15188a.htm>.
- Clark, T. (2001). *Virtual Schools: Trends and Issues*. Wested. Western Illinois University.
- Clarke, A. (1968). *The City and the Stars*. New York: Signet.
- Doherty, K. (2002). Students speak out. *Education Week* 21(35), 19–24.
- Duncan, D. (1998). *Calendar: Humanities Epic Struggle to Determine a True and Accurate Year*. New York: Avon.
- Gartner, J. (2004). Virtual-school costs under siege. *Wired News* (April 1, 2004). Available at <http://www.wired.com/news/politics/0,1283,62890,00.html>.
- Gold, K. (2002). *School's In: The History of Summer Education in American Public Schools*. New York: Peter Lang.
- Halyard, R., & Pridmore, B. (2000). Changes in teaching and learning—the role of new technology. *Journal of College Science Teaching* 29(6), 440.
- Hurley, R. (2002). Fine-tuning an online high school to benefit at-risk students. *T.H.E. Journal* 30(4), 33–40.
- Johnston, R. (2004). Wisconsin Teachers Sue to Close Online School. Washington: Education Week, Jan 21, 2004 (Note: change article ref to Johnston).
- Joiner, L. (2002). A Virtual Tour of Virtual Schools. *American School Board Journal* 189 (9), 50–52.
- Murray, C. (2004). MIT develops free course-management platform. *ESchools News*, April 7, 2004.
- National Education Commission on Time and Learning. (1994). *Prisoners of Time*. Washington: Commission.
- Norquay, M. (1993). Personal reflections on the early years of Ryerson Open College. *Journal of Distance Education* 8(1), 71–83.
- Owen, T. (2002). Learning with technology. *English Journal* 91(5), 85–88.
- Payne, E. (2002). Whose student is it, anyway? *American School Board Journal* 189(9), 47–48.
- Rutkowski, K. (1999). Virtual schools: chartering new frontiers. *Multimedia Schools* 6(1), 74–49.
- Tenner, E. (1996). *Why Things Bite Back: Technology and the Revenge of Unintended Consequences*. New York: Alfred A. Knopf.
- Trotter, A. (2002). Calif.'s online-learning potential evaluated. *Education Week* 22(8), 11, 14.
- Vail, K. (2002). A new kind of school. *American School Board Journal* 189(9), 40–44.
- Weiss, J., & Brown, R. (2003). Telling Tales Over Time: Constructing and Deconstructing the School Calendar. *Teachers College Record* 105(9), 1720–1757.
- Witham, S., Krockover, G., Ridgway, K., & Zinsmeister, W. (2002/3). Educational technology for the undergraduate geology classroom. *Journal of College Science Teaching* 32(4), 264–269.



## Chapter 15: Motivational Perspectives on Students' Responses to Learning in Virtual Learning Environments

MARY AINLEY\* AND CHRISTINE ARMATAS†

*\*University of Melbourne, Melbourne, Vic., Australia*

*†Deakin University, Melbourne, Vic., Australia*

Virtual learning environments are of special interest to educators because it is the province of educators to create, select, and provide environments that encourage learning. This is true whether the educator is concerned with very young children who have a very limited range of knowledge and skills, or mature learners whose experience has equipped them with extensive knowledge and well-developed learning strategies. It is the way environments set the framework or context for experiences that make them key tools whereby educators influence the direction of learning. Learning happens with or without the educator. However, the yardstick for evaluation of any educational endeavor is the degree that learning approximates the goals and outcomes valued by learners, educators, educational institutions, and educational systems. The chapters in this volume acknowledge that throughout history humans have used a wide range of technologies to design and construct environments to encourage the development of knowledge and skills in their young. However, the power of environments to promote learning has been accentuated by electronic information technologies as they offer an ever-increasing range of digital and virtual forms. These virtual learning environments have the potential to provide opportunities for active, flexible, and increasingly individualized learning experiences. Our examination of motivational perspectives will range widely across the electronic information technologies that are used in creating virtual learning environments, from the simplest forms of computer-aided instruction through to complex virtual reality environments.

An important factor influencing the widespread interest in electronic information technologies is the seemingly limitless possibilities they provide for the construction of virtual learning environments. Each new virtual learning environment comes with its implicit assumptions, and often explicit claims offering enhanced student learning outcomes. The idea that electronically created environments will open the doors of learning for everyone has been embraced enthusiastically to the extent that it is not uncommon to read claims such as "ICT can be used to provide new, authentic, interesting, motivating and successful educational activities" (Kelleher, 2000: 37). In particular, it is the motivating power of virtual learning environments that we will examine.

In this chapter we present a perspective that gives central place to identifying the character of the relationship or interactive process that connects learner and learning environment. More specifically our analysis will identify motivational processes that characterize how students engage with technologically based learning environments. In this way our approach will differ from other reviews of learning and virtual learning environments and will address what some have referred to as a “neglected factor in instructional design” (Spitzer, 1996). Our focus is not on any one form of virtual learning environment but rather we explore how the set of learner characteristics known as motivation might influence educational experiences and outcomes across a range of virtual learning environments. As Hartley and Bendixen (2001) have suggested the role of learner factors is likely to become more pronounced as learning environments become more open-ended.

The editors have adopted for this series a perspective that treats learning experiences as “participation in an interconnected series of learning environments”. Our approach is to focus on the motivational processes that influence “participation”. Motivation is about movement, energy, selectivity and direction in behavior, and so motivation is an essential component of participation. We examine how some psychological factors (e.g., curiosity, interest, goals, anxiety) influence what happens when specific objects or events within electronic environments impact students’ personal information processing systems. This is one of a number of perspectives on learning in virtual learning environments that emphasize functional qualities of the interactive learning system. For example, another way to look at learning in virtual learning environments is represented in a Gibsonian perspective. As Flach and Holden (1998) note, the Gibsonian view of design principles as applied to virtual environments highlights the link between perception and action. They argue that the dynamic interplay between the environment and the learner determines the quality of the simulation and therefore the quality of the experience. In this way, the yardstick for measuring experience in virtual environments lies not in the quality of the images, but with what can be done, “the reality of experience is defined relative to functionality, rather than to appearances” (p. 94). In contrast, we address the issue of learning in virtual learning environments by considering ways that students react to and interact with (i.e., are curious about, have their interest triggered by, become anxious about, want to master, want to avoid) virtual learning environments.

We have adopted a broad conception of virtual learning environments and include computer-mediated and computer-assisted learning programs that model traditional classroom practices, as well as electronic environments that simulate real-world situations in which students can interact and influence the environment. An important characteristic of virtual learning environments is their degree of veridicality with real-world environments. As societies have developed ways of transmitting adaptive understandings of the culture to developing members of the social group, so they have constructed learning

environments that are more or less veridical with the real-world environments which the developing young will need to navigate. These learning environments can also be classified according to whether learners experience them as being equivalent to the real world. Some learning environments represent the real world on a two-dimensional page. Throughout the history of education in western, literate societies, environments of this type have made up a large proportion of children's educational experiences. The critical features of real-world experience are abstracted and represented in either two- or three-dimensional form on the two-dimensional surface. At the same time there have always been educators who have argued the need for a closer match between the learning environments that make up formal schooling and the "real-world environments" for which schooling is preparing students. In the electronic age this issue is again brought into focus through the potential of computer environments to both *be* learning environments and *to simulate* real-world learning environments. Contemporary learning environments range on a continuum of immediacy. Towards one end of the continuum is the two-dimensional page or screen with its symbolic representations of the real world, abstracted from the environment and formally presented in a range of ways thought to assist learning. Currently at the other end are the virtual reality worlds created through digital means where students are active contributors to the life of the environment. The history of education shows clearly that across the full range of these learning environments students have reported experiences of being curious about, being interested in, wanting to understand, as well as being bored, being confused and frustrated, and being anxious. We will consider elements of learners' experiences within a range of these learning environments by giving special focus to what we can discover about the characteristics of students' motivational processes and how they contribute to what happens in the encounter between learner and virtual learning environment.

The specific approach we have taken to understanding learning in virtual environments can be illustrated by reference to a recent review of educational research technology. Winn (2002) identified four successive perspectives associated with the development of educational technology. The underlying theme for these perspectives has at its core the increasing sophistication of learning technologies. Early research according to Winn focused on learning content. Research questions were framed in terms of task analysis identifying effective instructional design. As more sophisticated presentation features were developed there was a shift to consideration of how format and individual student characteristics interact. Then development of media technologies that supported simulations heralded opportunities for vastly enhanced student control and more constructivist learning approaches. The latest stage has been the use of technological advances to generate learning environments that potentially can transcend limitations of time and space in what they offer to communities of learners. Seen in this way, the underlying theme associated with changes in learning environments is increasing sophistication of

technology. However, learning does not take place without a learner, and although the learner is never absent in the perspectives presented by Winn, his analysis gives technological change center stage. While acknowledging the importance of the technological changes described by Winn, we will turn the spotlight onto the psychological processes, more particularly the motivational processes that color the relationship between learner and environment. In doing so we will identify how these relationships contribute to the quality of the learning outcome.

Our motivational perspective on virtual learning environments will take as its central tenet that if we wish to understand learning we need to consider the subjective experience of the learner (Hickey, 1997). Curiosity, interest, anxiety, and achievement goals are just some of the motivational processes that describe the interactive relationship between learner and learning environment. We will examine evidence on the effectiveness of virtual learning environments to identify where motivational processes are essential for the quality of learning outcomes.

## 1. MOTIVATION, LEARNING, AND ACHIEVEMENT

Questions about motivation arise from the selectivity of human behavior. At any given point in time every person is surrounded by a vast array of stimulation, some we notice, some we ignore, and some never impinge on our awareness. Every person also has a history that they bring with them to any new situation as a psychological organization incorporating values, interests, emotions, and attitudes. When two people are in the same situation what is novel and puzzling for one person may be familiar and valued, or familiar and trivial for others. Sometimes what is selected for attention and further investigation is a function of specific properties of the stimulus. At the simplest level this may be the brightest light, the strongest color, or maybe the loudest sound. Brightest, strongest, and loudest all imply appraisal of the selected stimulus relative to others that might have attracted attention. Sometimes what is selected and investigated is a function of personal expectation or valuing. Most people have at some time had their attention drawn away from their own conversation at a party or social event by hearing their name mentioned in a conversation across the room.

When the prominent or predictable in a virtual learning environment is ignored and a less predictable path chosen, the selectivity typical of human behavior becomes an especially critical issue invoked to understand learner behavior. Knowing how learners typically respond to particular properties of instructional experiences provides important knowledge that can be used to guide instructional design. What stimulus qualities prompt curiosity and interest, trigger specific achievement goals, or create anxiety? Of course this is only the typical pattern and individual learner characteristics can intervene

and reduce the precision of predicted effects. There is also pattern within the personal factors that influence selectivity.

All of the major motivational dimensions associated with learning and achievement command a literature exploring situational triggers as well as a literature exploring individual differences. Sometimes these are framed as situational and individual perspectives and at other times as state and trait perspectives. As background to our review of the contribution of motivational processes in virtual learning environments, we will outline how both of these perspectives have been applied to some key motives associated with learning and achievement; namely curiosity, interest, achievement goals, and anxiety.

### **1.1. Curiosity**

Curiosity refers to the motivational processes that result in a person approaching a novel situation. Probably the most well known of curiosity researchers is Berlyne, who found that the motive curiosity and its consequences, exploratory behavior, were associated with situations that were characterized by what he called *collative variability* (Berlyne, 1960; 1978). This referred to properties such as ambiguity, complexity, and incongruity. From his research findings we know that most people will approach novel situations that have high collative variability. They will then explore the situation to reduce the uncertainty generated by its ambiguity, its complexity, or its incongruity. From the perspective of individual or personal variability, a number of theorists (Beswick, 1971; Day, 1971) have proposed that there are also individual differences in the degree that people generally approach novel situations. For example, some individuals may have their curiosity aroused by a wide variety of novel situations, whereas for others there is a much narrower range of situations that arouse curiosity and result in exploratory behavior. Some may have their curiosity aroused by novel and puzzling situations that offer new knowledge and understanding, others by situations that offer new experiences and sensations (Ainley, 1987; 1998).

### **1.2. Interest**

Interest is a related construct that has also been used to explain the impact of motivation on learning. Schiefele (1996) reviewed a number of studies that have quantified influences of interest on learning suggesting that about 10% of the variability in learning can be accounted for by interest factors. Maximize student interest in what is to be learned and typically learning will improve. The roles of both situational (Hidi, 1990; Hidi & Berndorff, 1998; Hidi & Harackiewicz, 2000) and individual interest (Krapp, 2002; Krapp et al., 1992) as they contribute to learning have been explored extensively. Recent studies

have attempted to identify how both situational and individual factors together contribute to learning (Ainley et al., 2002a, b). These studies have shown that students bring to their learning well-developed individual interests and that simultaneously specific learning topics trigger different levels of interest. In addition they have explored some of the processes through which interest has its effect on learning. For example, positive effect is involved in maintaining students' engagement, thereby providing an opportunity for learning to occur.

### **1.3. Achievement Goals**

Achievement goals refer to students' purposes in learning. Typical models refer to a range of specific purposes. On the one hand purpose can be defined as whether students want to master, to understand, or to improve competency (mastery or learning goals). Another purpose students have for their learning is to do well (performance goals). This may take the form of wanting public acknowledgement of achievement, of wanting to outperform peers, or to maintain face and "not appear dumb" in front of family or friends. At the other end of the spectrum, work avoidance goals indicate that students' purpose is to reduce learning to a minimum (Dweck, 1986; Elliot & Harackiewicz, 1996; Nicholls et al., 1985). The major emphasis in this research has been to consider the individual perspective, and achievement goals have been measured as personal orientations. Some research has adopted a situational perspective and has considered goals and purposes for learning that are salient in specific classroom environments (Ames, 1992; Ames & Archer, 1988). Most recently, research into the contribution of achievement goals to learning has expanded the focus to consider combinations of social and achievement goals represented. Every learning situation is also a social situation and so both sets of goals contribute to learning outcomes (Urduan & Maehr, 1995; Wentzel, 1992; 1999).

### **1.4. Anxiety**

Undoubtedly the most widely known effects of motivation on learning have come from the literature on anxiety (Pekrun, 2000). The debilitating effects of anxiety on learning have been well documented. Equally well known is the inverted U-curve describing the relationship between anxiety and performance. Up to a point anxiety can improve learning. But as the level of anxiety gets higher the anxiety symptoms such as increased heart rate, or quickened breathing divert attention from the task and the quality of performance declines. When students experience a learning exercise as an easy task, anxiety focuses attention and facilitates performance. When experienced as a difficult task, anxiety is likely to interfere with performance. In the anxiety literature

the situational perspective has been prominent through measurement of *state* anxiety and investigation of the relationships between state anxiety and performance. The individual perspective is represented in studies of *trait* anxiety, that is the degree to which individuals generally have a tendency to feel threat in a wide variety of situations (Spielberger & Krasner, 1988).

We have briefly sketched some prominent research directions in the study of motivation and learning. It is not exhaustive. What is critical for a consideration of the contribution of motivation in virtual learning environments is an acknowledgment that both situation and person contribute to the actual learning experience. Instructional design for virtual learning environments should be cognizant of the knowledge that has been generated from both situational and individual perspectives on motivation and learning. The learner perceives, appraises, and interacts with the virtual learning environment. In each of the processes that make up perception, appraisal, and interaction there is a contribution of both what is triggered in the person by the situation and what the selective processing of learners' personal psychological organization detects as salient.

## 2. STUDENT REACTIVITY TO ELECTRONIC LEARNING ENVIRONMENTS

The most common medium for accessing virtual learning environments is the personal computer. How students use computers and their attitudes toward the place of computers in education is critical to understanding student motivation and interactivity within virtual learning environments. One of the most recent studies shedding light on the extent of computer use amongst students in western industrialized countries is the OECD's Programme for International Student Assessment (PISA)<sup>1</sup>. Fifteen-year-old students were asked about their familiarity with computers as part of their learning environment. The questions consisted of self-assessments in response to items on interest in computers, attitudes and ability to work with computers, and use and experience with computers (OECD, 2001). Each self-report rating was made on a scale specifying response categories of "disagree", "disagree somewhat", "agree somewhat", and "agree". Summaries of these data for 16 OECD countries have been published and are informative for the insights they offer into national variations in access to computers.

While on average 60% of 15-year-olds in OECD countries use a computer at home almost every day, or at least a few times per week, there is considerable variability between countries. For example, this figure ranges from 21% in Mexico, 40% and 45% in Hungary and the Czech Republic, to more than 70% in Australia, Canada, Norway, and Sweden. In contrast, only 36% of students in this age group in OECD countries use a computer at school every day or at least a few times per week. Again there is considerable variability across countries, with proportions ranging from 15% in Germany to 55% or

more in Denmark, Hungary, and the United Kingdom. Internet use across all OECD countries is high, with 42% of students on average using a computer for electronic communication almost every day or at least a few times per week, with school-related use high at 30%.

Analysis of the particular familiarity issues (interest, comfort, and perceived ability) across national samples demonstrates some of the complexity of students' responses to computers as learning environments. Patterns of familiarity are related to factors such as computer availability and school organization, and also reflect cultural beliefs and lifestyles that determine the amounts of time spent in work, school, and leisure by children and adolescents around the world (Larson & Verma, 1999).

The PISA (OECD, 2001) measure of student interest in using computers was based on responses to questions dealing with using computers for reasons of importance, fun, being interested, and involvement. Students' comfort and perceived ability with computers consisted of self-ratings on questions about specific tasks including writing a paper and taking a test. They were also asked to compare their own computer ability with what they thought to be the computer skills of the average 15-year-old. When these indices of students' responses to computers were considered in relation to measured reading achievement there was a positive association between interest in computers and reading literacy scores. The authors caution that this association does not allow interpretations of directional effects, nor does it allow for the operation of other factors such as socio-economic status. However, these data are available for closer inspection and some of the more detailed patterns within this general finding are particularly informative for understanding students' reactivity to electronically mediated learning environments. Students from Finland and from the U.S.A. demonstrated contrasting patterns. Overall, Finnish students scored lower than average across the OECD respondents for interest in computers and scored very high on the reading literacy index. For these students there was a negative association between interest in computers and literacy scores. In contrast, students from the U.S.A. reported the highest level of interest in computers coupled with a strong positive association between interest in computers and reading. Australian, New Zealand, and Canadian students whose reading levels were comparable showed only slight variations in reading literacy scores across the quartiles of interest ratings. Students from all three countries showed lower than average interest in computer scores. It is of note that for all three of these countries, the lower than average interest in computers index was coupled with high comfort and computer ability scores. Countries such as Germany, the Czech Republic, and Denmark, who also demonstrated little difference in the reading literacy scores across the four quartiles of interest in computers, showed a range from high interest (Germany), close to average interest (Czech Republic), and low interest (Denmark). Clearly the patterns of association between the various aspects of familiarity with electronically mediated learning environments and



student achievements is complex and requires more understanding of how students within specific socio-cultural contexts are reacting to those learning environments. Most of the research that is reviewed in this chapter was conducted in countries where computer availability is high. Students are familiar with computers, are generally interested in them, and expect them to be part of their learning environment. The findings cannot necessarily be applied to students in countries where computer availability is low.

### 3. SITUATIONAL FACTORS INFLUENCING REACTIVITY TO VIRTUAL LEARNING ENVIRONMENTS

A widely used approach to evaluating the role of situational factors in virtual learning environments compares learning outcomes using some form of electronic instruction medium (e.g., CAI or Web) and traditional learning environments. A second approach directs attention to specific components within the learning environment supported by newer learning technologies and explores their effectiveness in terms of cognitive processing characteristics of the learner. Each specific component is tested for its contribution to learning in controlled experiments. A third approach focuses on the motivational conditions required for effective learning and from this perspective identifies features of virtual learning environments that optimize motivation. We will consider the contribution of each of these approaches in turn.

### 4. VIRTUAL AND TRADITIONAL LEARNING ENVIRONMENTS COMPARED

Virtual learning environments have commonly been evaluated by asking whether students' learning is enhanced when some form of electronic medium delivers that learning. The basic research design involves comparison of an electronic medium with some form of more traditional learning medium. Because of their longer history and the relative ease of implementing the experimental design, CAI learning environments have featured prominently in the large numbers of these studies reported over the last three decades. More recently results have been synthesized using meta-analysis. For example, one meta-analysis of studies involving secondary students (Christmann et al., 1997) indicated that overall there was a slight improvement in achievement associated with the CAI treatment groups. However, the size of this effect varied considerably. Of the studies that met their strict criteria for inclusion (i.e., a CAI treatment group compared with a traditional instruction group and the effect of the treatment on measured achievement outcomes reported), approximately half reported positive findings in favor of the CAI groups, some reported no difference, and others negative findings. Effect size varied across subject areas. The largest positive effect sizes were reported in

studies concerned with science instruction and the largest negative effect sizes in studies concerned with English instruction. Two examples of this type of study will be detailed here to illustrate the findings and interpretations that are generated using this approach.

Using instructional material from a Biology course on reproduction in plants and animals, Soyibo and Hudson (2000) compared the pre- and post-instruction scores of Jamaican grade 11 students. One group of students had the typical lecture and discussion methods of instruction supplemented with access to commercially produced software called the *Virtual Body* (made by Time-life, IVI Publishing Inc., 1995). The attractive elements of this package for the teaching of animal reproduction were the attention given to issues of “learner control, feedback, interactivity, and flexibility”. Other material that did not have strong interactivity features was used for the plant reproduction section of their course. At the end of the 4 weeks instructional period Soyibo and Hudson found that students in the *Virtual Body* experience group significantly outscored the control group. The outcome variable in this study was a score on a 30-item multiple-choice biology knowledge test. Studies of this general type have sometimes reported significant learning advantages for the virtual learning experience groups, sometimes no differences and sometimes negative results, although the latter might be expected to have more difficulty in getting published (Christmann et al., 1997). In other studies comparisons of learning outcomes across learning environments based on media allowing for a range of learner participation are reported. For example, Ricci and Beal (2002) compared children’s story memory following use of interactive story software, narration (audio-only), and a television-like audio-visual. A second form of the interactive-computer story software consisted of a passive computer condition where the student “observed but did not control” the story. Measures of story memory following these four modes of presentation indicated that the audio-only group had the poorest performance, but there were no significant differences between memory response scores for the other three presentation modes.

In terms of the range of virtual learning environments available in the first decade of the 21st century these studies have investigated relatively simple learning environments. However, it is important to note that both studies go beyond the basic achievement findings and report aspects of students’ reactivity to the learning experience. Soyibo and Hudson (2000) reported changes in students’ attitudes to biology and to computer-aided instruction following their learning experience, and more importantly that the post-instruction attitudes to biology showed a “positive statistically significant but weak relationship” with the post-test biology achievement scores. Changes in students’ responsiveness to both the medium of instruction and to the content of the instruction were reported. In the Ricci and Beal (2002) study, children’s enjoyment ratings for the story were high and did not differ between any of the four media conditions. However, when all of the children reported their preferences across

media types, there was a significant preference for computer-based media. Radio was least preferred.

The difficulty of comparing and synthesizing findings from these types of studies is compounded by a number of factors. As pointed out earlier, there are very different socio-cultural environments in which the students are located. Soyibo and Hudson's (2000) study was conducted in Jamaica in direct response to educational authority initiatives seeking to increase the low base of computer use in Jamaican primary and secondary schools. In contrast, Ricci and Beal (2002) described their school context as one where "computer access and use by children is becoming increasingly important, both at home and in school settings" (p.138). There are also complexities for interpretation and generalization of results from these studies associated with the age of the students. Ricci and Beal conducted their study with 6–7 year olds and suggested that the children were highly engaged with material no matter what the medium. Contrast this with the situation provoking a lot of studies like those of Soyibo and Hudson where the computerized instruction medium has been adopted in response to falling motivation for learning (generally dealing with adolescent/secondary or high school populations). In the latter, electronically mediated learning environments are often seen as a way of addressing issues of engagement and motivation.

On balance, comparisons between the effectiveness of learning using various forms of virtual learning environments and learning using more traditional methods have shown that virtual learning environments can produce higher learning outcomes. However, across the studies results are variable and often the interpretation of group differences has to be qualified with reference to the influence of students' interest, enjoyment, or attitudes. Motivational factors such as interest, enjoyment, and clear goals are important influences on students' responsiveness in virtual learning environments.

## 5. COMPONENTS OF VIRTUAL ENVIRONMENTS SUPPORTING LEARNING

A second way of assessing virtual learning environments is to focus on the key factors of the learning environment in relation to the cognitive abilities of the learner. In response to the large body of research comparing electronic and traditional learning environments, Mayer has argued that "the most important factor in producing cognitive outcomes is not the medium that is used but rather the quality of the instructional message" (Mayer, 1997: 7). Quality is determined by the way instruction is tuned to the cognitive processing capacities of student users. In this he is supported by a range of reviews directing attention to the characteristics of instructional materials as they facilitate or inhibit learning, rather than the more global approach that credits the medium *per se* as the facilitator of learning (Clark, 1994; Kozma, 1994a, b). The work of Mayer and his colleagues (Cordova & Lepper, 1996; Mautone & Mayer,

2001; Mayer, 1997; Mayer & Chandler, 2001; Mayer et al., 2002; Mayer et al., 1999; Mayer et al., 2000; Moreno & Mayer, 2002) has made a substantial contribution to this field. Their research program is built on insights from a number of contemporary theories about learning processes. For example, citing Wittrock's (1989) generative theory, Mayer argues that the learner is a constructor of knowledge, actively selecting from within the available information, building their own representation of the selected information, and then integrating it with their existing representational system. From Pavio's (1986) dual coding theory he points to the possibility that separate visual and verbal systems will be involved in the extraction of information from multimedia displays. All of this occurs within the constraints on the information processing system set by the capacity of short-term working memory (Chandler & Sweller, 1991). These and other theories of human information processing have been applied by Mayer and colleagues in their experiments evaluating the instructional potential of specific media components in multimedia learning environments.

In all Mayer's experiments, individual components of multimedia learning environments have been isolated to test their effects on two types of learning, retention and transfer. A relatively consistent picture has emerged showing that these two types of learning are differentially affected by the learner's experience with specific kinds of instructional components. The participants in many of these studies have been college-age students and they have been asked to learn concepts and principles from physical science. A number of these studies will be described in detail to illustrate the important features of this approach.

Interactivity is a key component of multimedia learning environments. Mayer and Chandler (2001) used narrated animation to assess the role of "simple interactivity" in the form of the learner being able to control the flow of the presentation. The experimental design involved narrated animation being presented to each student twice and incorporated different degrees of student control over the "pace of a narrated animation". Some students had a mixed experience. They controlled the pace for the first presentation but on the second presentation had no control over pace. For other students the order of these two experiences was reversed. Still other groups of students either controlled the pace for both presentations or had no control over the pace in either presentation. In this experiment there were two levels at which the effects of the medium of learning might operate: the actual processing of information during learning and the amount of information able to be retrieved. In terms of the processing of information, any learning exercise puts a certain level of cognitive load on students' working memory. Too much cognitive load on working memory interferes with learning. At the same time the structure of the learning exercise may facilitate or impede students' construction of a coherent mental model of the specific learning task. In many of Mayer's experiments the learning task consisted of explaining the formation of lightning (Mayer &

Chandler, 2001). Having control over the pace of the presentation promoted effective learning through matching the cognitive load of the presentation with the learner's pace of constructing their explanation of the formation of lightning. If simple user interactions lead to deeper understanding this would be indicated by higher scores on transfer tests for students who had control over the pace of presentation than those who did not. The results indicated that the order of control experiences was also important. When students controlled the pace on the first presentation and then passively viewed it on the second presentation, they performed better on the transfer test than students who controlled the pace on the second presentation after already experiencing the passive exposure.

In another experiment using similar learning material (Mayer et al., 1999), the effects of different combinations of narration and animation were tested (e.g., concurrent; narration before animation, animation after narration, narration and animation delivered in small or large bites). Here, an additional issue investigated was how the dual systems of visual and verbal materials are held and processed in limited capacity working memory. The concurrent and small successive bites groups outperformed the successive large bites group, thereby supporting a contiguity effect. These findings demonstrate how specific features of a multimedia environment influence learning (Mayer et al., 2001; Moreno & Mayer, 2002), and have contributed important principles that can be used to design effective multimedia learning environments.

The main contribution of this research has been identification of the specific cognitive processes through which components of the instructional environment impact on students' knowledge and understanding. For example, the cognitive load characteristics of the instructional contents will influence learning. Text and graphics presented together on a screen place more cognitive load on the learner than does text and narration. But the answers for effective instructional design are never simple. Although Mayer's research has demonstrated that contiguity of verbal and visual information in multimedia environments improves learning, it has also shown that individual learner characteristics matter. Students' prior knowledge of content and spatial abilities moderate the effects of the contiguity principle. When the learner has high levels of prior knowledge, contiguity is less important than when prior knowledge is low. Contiguity effects have more impact for learners who have strong spatial abilities than they do for learners who are less reliant on spatial abilities.

Alongside issues of cognitive load, Mayer draws on Wittrock's (1989) generative theory of learning which views the learner as a "knowledge constructor". This introduces into the learning equation differences in the degree that learners are able to select relevant information, and to organize and integrate it into a coherent model of the phenomenon to be explained. While all three sets of processes, selection, organization, and integration, are constrained by the cognitive abilities of the learner, motivational processes are also important.

The level of cognitive load represented by the instructional design can be set to match that of the learner, but, if the learner does not focus their attention on the computer screen, the selection will be less than optimal and the organization and integration processes that follow will be compromised. Factors that determine selectivity are clearly critical. Motivational processes such as learner interest in using computers, self-efficacy, or anxiety about using computers will influence attention and selectivity. In some of Mayer's experiments student interest has been included in the design (Mayer et al., 2000). At the end of the learning task students were asked to report how interesting they found the material. Differences in interest and learning between the experimental groups suggested that the groups reporting higher interest in the material were more likely to try to make sense of the material and to form a more coherent model.

Of special interest in this research has been the consistent finding of different outcomes according to the type of learning measure. Retention indices are not as sensitive as transfer measures. Constructivist theories of learning have been used to provide explanations for this difference in measured learning outcomes. Transfer learning requires deeper processing than retention of factual material. Deeper processing in this context represents making sense of and building a more coherent model that can be used to apply the critical concept or principle to new situations (transfer). The deeper processing that is associated with higher performance on the transfer measures of learning was also significantly related to motivational processes reflecting involvement or engagement with the learning environment (Mayer et al., 2000).

The important insight coming from all of this research is that instructional design of virtual learning environments requires a match between the design parameters and the cognitive capacities of target learners. At the same time this research points to critical role of the motivational processes, such as interest, that direct and sustain learning.

## 6. FEATURES OF ELECTRONIC LEARNING ENVIRONMENTS THAT OPTIMIZE MOTIVATION

A third approach to the situational factors associated with effective learning in electronic learning environments focuses on the motivational conditions required for effective learning in order to identify features that optimize motivation. A good example of this approach can be found in the research and writings of Lepper and colleagues (Cordova & Lepper, 1996; Lepper, 1985; Lepper & Gurtner, 1989).

In an early paper, Lepper (1985) defined a set of inter-related research issues that link the learner and the instructional possibilities of computer learning environments. He suggested that the design properties related to generating intrinsic motivation, the relationship between intrinsic motivation

and instructional effectiveness, and identification of the different philosophies of instruction embodied in educational computer programs were key issues to be addressed. According to Lepper, the increased motivation so often claimed to be typical of students' response to educational software depended on what theorists generally referred to as intrinsic motivation. For some theorists this was described in terms of challenge, effectance, or mastery motivation. Other theories of intrinsic motivation refer to curiosity, complexity, incongruity, and discrepancy, while others refer to perceived control, self-determination, or factors such as fantasy involvement. Lepper argued that these distinct theoretical traditions could profitably work together in the context of understanding the determinants of intrinsic motivation and how this might be reflected in the design of instructional software. This direction was of course predicated on the assumption that the increased intrinsic motivation generated by new educational software would be associated with improved instructional effectiveness. Lepper argued that rather than being a necessary consequence of increased motivation, instructional effectiveness was likely to be bound up in the degree that the motivation-enhancing special effects were interdependent with the problems to be solved or the instructional content. On another occasion Lepper and Gurtner (1989) contrasted the positive expectations of computer enthusiasts with the cautious and suspicious concerns of those educators challenging the computer revolution in education. He predicted that given the variability within computer learning environments, instructional effectiveness will be as varied as the instructional programs themselves both in terms of their formal features and their incidental content. In particular, Lepper argued that the attention students pay to various aspects of the learning environment, how involved they become, and the learning strategies they use all impact on the cognitive outcomes resulting from the experience. Similarly, motivational consequences are likely to be shaped by factors such as students' learning goals, their level of intrinsic motivation, perceived competence, and self-efficacy.

These relationships have been tested in a number of experimental studies reported by Lepper and his colleagues. For example, Cordova and Lepper (1996) experimented with a number of forms of educational software designed for teaching arithmetical order-of-operation rules to fourth and fifth grade students. Specific features designed to enhance intrinsic motivation were incorporated into the separate software conditions that varied the degree to which the learning content was abstract, contextualized, or personally meaningful. The control group engaged in two unembellished computer-based learning games. For the experimental conditions, students received the same learning activities embedded in a fantasy context. The fantasy context was manipulated so that for half the students the fantasies were generic, while for the other half they were personalized on the basis of information elicited from the students at the start of the experiment.

Cordova and Lepper (1996) found significant differences in the motivation of these groups as evidenced by such indicators as their level of task

involvement and the extent to which they chose more challenging versions of the game. Significantly higher learning scores were observed when the learning was embedded in the fantasy context, in the personalized context more than the generic context, and in the choice conditions more than the no-choice conditions. In a similar study, Mitchell (1993) identified how using computerized instruction in mathematics classes influenced specific motivational processes. Distinguishing between the initial reactions to the task and the continued interaction required for maximum learning, Mitchell found that the novel, electronic features of the computer presentation were effective in catching student interest. However, the instructional content needed to be involving and meaningful if it was going to maintain and hold students' attention.

Total immersion in an electronically mediated world that defines the reality within which the student can operate is a defining feature of virtual reality environments that separates these environments from other virtual learning environments. Again, issues of instructional design and learner reactivity need to be addressed when assessing the educational potential of these types of learning environments. Findings from the Project Science Space (George Mason University) help to illustrate the complexity of the interactive processes that need to be understood when using this form of virtual learning environment to achieve specific learning objectives (Salzman et al., 1999). The features of these environments that can increase motivation and contribute to greater learning include three-dimensional immersion, frames of reference (FORs) and multisensory cues (Salzman et al., 1999). Combinations of these features of virtual reality environments may also interact and add complexity to the structure of the learning environment. Specific learner characteristics that have been tested for their influence on the experience of virtual reality environments include gender, spatial ability, computer experience, concept domain experience, motion sickness history, and the individual's tolerance of the immersion experience. For example, NewtonWorld (NW) is a physics environment that has been designed to allow students to explore concepts that are often the substance of student misconceptions. One such misconception is that "motion implies force". In NW, the learner is in a corridor where they control the movement of balls of various masses. Additionally the student is able to "beam" between balls and cameras observing how the balls behave in relation to the surfaces of the room. As Salzman et al. explain:

"In NW, we rely on sensorial immersion to enhance the saliency of important factors and relationships and to provide experiential referents against which learners can compare their intuitions. Learners can be 'inside' moving objects; this three-dimensional, egocentric frame of reference centres attention on velocity as a variable. Multisensory cues are used to further heighten the saliency of crucial factors such as force, energy and velocity.

(Salzman et al., 1999: 298–299)



Observations of students' responses both to the experience in the virtual reality worlds and students' reports after their experiences indicated the importance of motivational factors. Being able to observe what was happening from multiple viewpoints (the FOR factor) as part of the learning experience was motivating for students.

In their analysis of the effects of their virtual reality environments Salzman et al. (1999) distinguish between the interaction experience (simulator sickness and usability) and the learning experience (immersion and motivation). They suggest that a positive interaction experience, a positive experience with the hardware and software interfaces is an important pre-condition for learning. These and similar experimental studies make an important contribution to an understanding of how specific design features of virtual learning environments enhance students' interest and engagement, and how they in turn are associated with stronger learning outcomes.

#### **6.1. Virtual Learning Environments and the Experience of Flow**

Another motivational variable that has recently received considerable attention from researchers working with virtual learning environments is Csikszentmihalyi's (1990) concept of "flow". Flow refers to an experience of intense emotional involvement, being completely involved in the activity for its own sake. "The ego falls away. Time flies." (Geirland, 1996). It is the state where the person feels so involved and committed to their current activity that they may not be conscious of their own level of effort and may lose all sense of time. The expanded opportunities for learner choice and control within electronically mediated environments have been interpreted as providing the ideal conditions for flow experiences. When asked about his views on the likelihood of web environments promoting flow experiences, Csikszentmihalyi contrasted a well-structured gourmet meal with cafeteria selection to highlight the need for instructional design in electronic learning environments. He is reported to have said:

"A web site that promotes flow is like a gourmet meal. You start off with the appetizers, move on to the salads and entrees and build toward dessert. Unfortunately, most sites are built like a cafeteria. You pick whatever you want. That sounds good at first, but soon it doesn't matter what you choose to do . . . web site designers assume that the visitor already knows what to choose. That's not true".

(Geirland, 1996)

In a recent study (Chen et al., 1999) web users were asked about flow experiences. Chen et al. found that the activities most likely to be associated with reports of flow experiences were information retrieval, communication,

and interaction. Information retrieval activities were described as provoking challenge and providing feelings of enjoyment. Describing their experiences, students used terms such as “engrossment, exploration, excitement, timelessness” that are very similar to the experiences described in Csikszentmihalyi’s (1990) work. From the questionnaire responses, Chen et al. were able to define a number of design factors associated with flow including the web user having clear goals and receiving immediate feedback. Like others using the flow framework, they reported that flow was more likely to be reported when there was a match between web-user skills and the challenges provided by the web environment. From these responses, Chen et al. suggested that design of web learning environments incorporate features that provide immediate feedback; clear rules to follow and goals to pursue; enough complexity which is not easily exhausted; creation of dynamic challenges not static ones (see Chen et al., 1999: 589).

Another study monitoring flow within a web learning environment used the experience sampling method (Csikszentmihaly & Larson, 1987) to collect students’ reports of how they felt about a hypermedia learning exercise (Konradt & Sulz, 2001). At designated points in the learning exercise students reported their level of activation, affect, concentration, satisfaction, and motivation by completing experience sampling rating scales. Students were classified into four groups defined by their particular balance of challenge and skill for this task (flow: high challenge, high skills; anxiety: high challenge, low skills; apathy: low challenge, high skills; boredom: low challenge, low skills). Approximately one-third of the students met the flow criteria and this was the largest group. Clearly the hypermedia presentation had engaged a substantial number of the students. One limitation in the complex design of this study was the relatively small numbers of students for each of the hypermedia experience categories. There were only 60 students in total participating in the study. Comparisons between the learning outcomes were reported for the “flow” and the “apathy” groups. All three learning measures (content knowledge, structural knowledge, and transfer) showed higher performance for the “flow” group. Although in the predicted directions, these differences were not statistically significant.

The experience of “flow” and its contribution to learning in virtual learning environments is currently attracting researchers’ interest (Pearce et al., 2005). With further refinement of measures and more robust designs this area promises to add substantially to our understanding of the processes whereby participation in virtual environments expands student learning.

## **6.2. Virtual Learning Environments as Social Environments**

In the previous section it was argued that learner responsiveness was critical in any electronic or virtual learning environments. Much of the research we have

cited has been seeking those forms of design that will maximize the likelihood that students will engage with, and be an active participant in, the learning environment. The literature on human–computer interaction makes liberal reference to “interactivity” as a major feature of technological environments that support constructivist learning. The response of one person to another person often initiates a chain of action and reaction that we call interaction or interactivity. Human responses in virtual environments can operate in a similar manner, the only difference being that the computer is taking on the role of responding partner. This is turn taking, or acting and reacting in a similar chaining sequence to what happens in human conversation or dialogue. Within the virtual environment there is some form of immediate response to the learner’s action. However, for effective learning to take place the learner must discern or make connections between their own actions and the responding activity in the virtual environment (Pearce & Ainley, 2002).

Recognition of the social character of learners and the influence this can have on the level of interactivity within virtual learning environments has found expression in a range of studies exploiting the potential of electronic learning environments to incorporate social experiences designed to heighten interactivity. Avatars or animated pedagogical agents (APAs) are now part of some significant electronic instructional projects (Lester et al., 2000). When computer users are asked about their reactions to computer-mediated characters their answers clearly indicate that interactions with electronic characters are treated as social interactions (Reeves & Nass, 1996). Some of the work emanating from the Intellimedia research group will be described to indicate how this approach contributes to our knowledge of learner motivation in virtual learning environments.

The designs for the APAs in Intellimedia projects are guided by both motivational and pedagogical considerations. Within the broader set of motivational processes, emotion has been identified as a key social process and so APAs are being constructed to both display and understand emotions (Lester et al., 2000). Student and agent together operate the learning environment. Students’ problem-solving activities drive the system. When the student is inactive for an extended time or when they are using poor problem-solving actions, the pedagogical agent comes in with actions and utterances designed to give direction and control of the problem-solving activities back to the student: “Engaging lifelike pedagogical agents that are visually expressive can clearly communicate problem-solving advice and simultaneously have a strong motivating effect on students” (Lester et al., 2000: 124). Early studies demonstrated that students found the agents with both animation and aural communication to be believable and reported that they found them encouraging and useful (Lester et al., 1997). Other researchers (Craig et al., 2002) have found that learning environments employing APAs with spoken narration result in better performance than where text-only or text with spoken narration are used, confirming the efficacy of realistic APAs for assisting learning. Similarly, Atkinson (2002)

found that worked examples coupled with an APA programed to deliver instructions aurally was more effective at promoting learning than text-only examples without agents.

One feature of electronic learning environments that has both positive and negative implications is the wide range of possible paths that can be taken navigating that environment. The positive side has been linked with the motivating effects when students are in control and can make active decisions within the environment. The negative side of this is the possibility that students may be overwhelmed by anxiety as they experience uncertainty associated with both the range of choice available and lack of confidence in their own knowledge and abilities. Based on Vygotsky's social-constructivist approach to learning, contemporary advocates of discovery-based learning environments acknowledge the importance of providing structure or scaffolding for students' choices and decision-making. The APA provides the scaffolding by matching actions and utterances to students' current location in the problem-solving space. Experimental evaluation has shown positive effects on learning in a virtual learning environment with the support of an APA. Using a microworld called "Design-A-Plant" with its APA, Herman, the learning outcomes for students working with an APA version were compared with students having a version of the microworld with no-APA (Moreno et al., 2000). The no-APA group received text information on the screen equivalent to the content of the utterances made by Herman for the APA group. Measures of retention of factual information showed no difference between the two groups. However, both transfer and self-reports of motivation and interest showed significantly more understanding and stronger motivation and interest in the APA group. In the same set of studies it was shown that personalized dialogue was associated with higher transfer scores and stronger motivation ratings than was the same message communicated via a non-personalized monologue.

These research programs suggest that the APA is effective because it taps into motivational systems that the majority of learners bring with them to their learning. The virtual learning environment that includes some form of APA becomes a social situation thereby broadening the appeal to include social as well as cognitive processes. Numbers of students whose interest is not triggered by the cognitive content of the task, or students who are only mildly interested are still likely to respond to the "person" who is communicating directly with them. However, further research is needed to understand these social processes and how they might best be used to maximize student engagement.

Providing conditions that maximize interactivity through the use of social agents or personalization techniques taps into the motivational systems that learners bring with them to their learning. On the indication of these current findings this should be a very fruitful area for further investigation.

### 6.3. Virtual Learning Environments and Communities of Learners

The importance of the social context supporting learning is also a key feature of instructional programs that are designed to build communities of learners. Classrooms of students working together become communities of inquiry. This means that students are provided with a learning environment that encourages them to construct knowledge and understanding through posing questions, reacting to questions and ideas generated by other students, and reflecting on their ideas, knowledge and understanding. The central character of this process of asking questions, knowledge construction and reflection is to make thinking visible. It is the potential of virtual learning environments to facilitate making thinking visible, and to use collaborative environments to scaffold the development of shared knowledge, that has encouraged a number of researchers to investigate patterns of knowledge construction within communities of learners (Bransford et al., 1999; Koschmann, 1996). One well-known virtual learning environment developed to facilitate communities of learners is the Knowledge Forum formerly known as CSILE (Scardamalia & Bereiter, 1994). The Knowledge Forum environment involves construction of a conferencing system and database by means of networked computer software. Designed to build a reflective thinking approach to knowledge construction this system is based on principles whereby learning is modeled and scaffolded. Individual thinking is cast into the shared language of the community of inquiry and the technology provides a structure for the sharing and development of ideas. Students are encouraged to express their ideas and questions, respond to the ideas and questions of their fellow students, and to develop these experiences into shared understandings. The technology has been designed to mediate the sharing of ideas and so allows this to occur across local environments as well as across time and space. Reports of student learning in such communities describe the gains made by students as they develop skill in knowledge building processes (Goldman et al., 2003). The social character of students' experiences as a member of a community of learners provides an important source of motivation and this is reflected in their attitudes and participation, their willingness to contribute ideas. However, as was the case with our knowledge of the effectiveness of APAs, the motivational processes that are connected with these learning outcomes and attitudes are implicit in the observations made by researchers of collaborative learning communities but are yet to be researched extensively.

For whatever reasons, the electronic venue seems to call forth more informative comments than students make in the context of face-to-face, whole-class and small-group discussions . . . Perhaps the electronic environment seems less test-like to them. Perhaps it is being part of a community engaged in the same activity. Perhaps it is the ability to see

their own responses in relation to those of their peers. These are empirical issues that bear further investigation as we continue to explore the value of electronic environments of the KF variety.

(Goldman et al., 2003: 279)

While situational factors such as features of the environment, the opportunity for social interaction and experiences of flow clearly influence reactivity to virtual learning environments, a comprehensive appreciation of the possibilities of virtual learning environments requires consideration of both person and situation. What students bring to their learning in terms of characteristic ways of responding to the mode and contents of learning environments, also needs to be the subject of close investigation so that virtual reality environments can support effective learning.

#### 7. INDIVIDUAL FACTORS INFLUENCING REACTIVITY TO VIRTUAL LEARNING ENVIRONMENTS

Both situational and individual factors impact on learning in virtual environments. However, a significant and not yet well-understood issue concerns the complex ways these individual and situational factors interact. This has been the subject of considerable debate in a number of areas of psychological theory. For example, one of the major challenges to the use of personality theories to predict behavior has been the claim that there is insufficient cross-situational stability to justify their use (Mischel, 1973). More recently Mischel and Shoda (1995) have suggested that it is not a question of either personality or situation (cross-situational consistency or situational variability), but rather how these two perspectives play out in human behavior. They suggest a more productive approach is to view personality “as a stable system that mediates how the individual selects, construes, and processes social information and generates social behaviors” (p. 246). What the person brings to the situation in the form of their relatively enduring patterns of expectancies, goals, and plans makes it more likely that certain aspects of situations are salient. These salient aspects are in turn more likely to be selected for attention and appraised in ways consistent with those relatively enduring patterns of expectancies, goals, and plans. It is also true that situations vary in the degree that specific characteristics have immediate salience. For example, when considered from the perspectives of trait and state (person and situation), Pintrich (2000) argued that achievement goal orientations involve schema or cognitive representations of what individuals would like to achieve. These may show both intra-individual stability and contextual sensitivity. The relative strength of situational cues and the accessibility of specific goal schema will influence actual behavior. “Strong contexts can overwhelm chronically accessible traits, but in the absence of strong cues in the environment, then traits may

influence behavior more.” (Pintrich, 2000: 102) In this way it becomes possible simultaneously to account for the contribution of qualities of the underlying personality and the predictable variability across situations.

Mischel and Shoda (1995) were addressing issues of person and situation from the perspective of social psychological research. However, the same issues offer important insights into students’ responsiveness to a variety of learning environments, including virtual learning environments. Situations may have features that by virtue of their intrinsic character are compelling for most learners. The type of research conducted by Mayer and his colleagues (Mayer, 1997; Mayer & Chandler, 2001), described in detail already, is predicated on the assumption that some characteristics of virtual learning environments will have similar impacts on most learners. Knowledge of these characteristics can then be used to inform instructional design. In addition, learners have personal motive systems and organized networks of schemas and effects that may be salient or require specific situational cues to bring them into prominence.

Some of the investigations into the effects of achievement goals on learning in virtual environments illustrate these patterns of relationships. A group of 11th and 12th grade students used the RiverWeb Water Quality Simulator (Azevedo et al., 2002) to learn about ecological systems and water quality. RiverWeb is a simulation that presents a wide range of scientific data on water systems and water quality. Students engage in a “simulated field trip through a prototypical watershed” and are able to explore the effects of a range of land uses on water quality. The exercise continued over 3 weeks. Students were randomly assigned to two instructional conditions; learner-generated goals or teacher-generated goals. In the learner-generated goals condition the broad goals of the whole learning exercise were presented and within this framework students were free to set their own specific goals. In the teacher-generated goals condition students followed a plan of goals determined by the teacher. Azevedo et al., monitored students’ knowledge and understanding across the course of this curriculum exercise, and found that the performance of both groups improved. However, the group which was able to generate their own specific learning goals showed a greater shift in their mental models of how ecological systems operate. Consider what is likely to have happened in these learning environments in terms of the interaction between person and situation. In this experiment the situation has set specific limits on the goal-setting procedure. Students’ purposes for their learning in the teacher-generated goal group were tightly controlled by the situation. For the learner-generated goal group the situation defined certain general purposes but within that framework students’ own purposes in learning could be expressed. It might be expected that students with similar levels of mastery goals who are assigned to different conditions would be expected to have very different learning experiences and, in consequence, achieve different learning outcomes. What is especially important about the experience and learning for the learner-generated goal

group is that it highlights one process whereby the personal and the situational combine. Personal achievement goals were mediated by situational affordances.

In another study (Pearce & Ainley, 2002), first year undergraduate students used a web-based instructional unit designed for exploring the physics of waves. Students' achievement goal orientations as well as some specific reactions to the learning task were recorded on-line. It was reported that after allowing for differences in prior physics knowledge, students with higher mastery goal orientation scores (wanting to understand and improve competence) were likely to report higher levels of interest in this specific topic and were more likely to choose interactive options within the program. When this was related to performance on test questions that involved application of the physics principle to a new situation, the effects of mastery goal orientation were mediated by interest in the topic. Situational cues that triggered interest brought into play students' more general purposes for their learning. The framework illustrated above for achievement goals can also be applied to other motivational constructs. In some recent work investigating dimensions of student interest through responsiveness to text materials accessed through an interactive learning task, the relationship between students' curiosity as a personal variable and interest triggered by specific popular text material was mediated by individual interest (Richardson, 2002).

Key to the connection between the situation and the person is the learner's perception of the learning situation and their perception of themselves as learners (Boekaerts, 1996). For the educator or the instructional designer this requires appreciation of the range of learners' subjective experience, their appraisals of the situation, and the specific self-schema activated or made salient by the appraisal process. The active psychological state draws on both person and context and the question is to identify within particular virtual learning environments the critical form(s) of interdependence between person and situation that occur. The quality of subjective experience is not just an outcome of personality characteristics, it is also a function of the situation as perceived and interpreted by the student.

## 8. GENDER AND VIRTUAL LEARNING ENVIRONMENTS

Gender is a factor that has been implicated in a wide range of educational outcomes and continues to provide important insights into educational processes (Wigfield & Eccles, 2000). Many of the investigations that have sought to understand why gender is such an important factor have suggested that gender represents critical dimensions of individual's understanding of themselves. This has been documented in terms of teachers' attitudes and perceptions of their students. Students also report differences in attitudes and behavior associated with gender and are aware of specific expectations and pressures



associated with these gender differences (Holden, 2002). Patterns of attitudes and actions associated with gender can be understood in terms of the self-understandings or self-schema that have been developed through both the child's biological makeup and their social and cultural experiences (Fivush, 1998). It is not surprising to find similar gender differences when students' attitudes and behavior in virtual learning environments are considered. For example, computer games have always been consumed more avidly by boys than girls (Subrahmanyam et al., 2002).

A recent investigation into the relationship between using a home computer and students' educational use of information technology (Selwyn, 1998) with a sample of 16- to 19-year-olds reported that more positive attitudes were associated with use of a computer at home. In this sample, young men were significantly more likely to have a computer at home than were their female peers. In addition, those young women who did have a computer at home were likely to use it less frequently. Patterns of ownership and use can clearly be shown to be linked to gender. However, there is some evidence that these gender patterns may also be age related. For example, Bergin et al. (1993) reported that this gender bias is "mild or non-existent in pre-school and kindergarten" (p. 438). They argue that gender differences reported with older children represent a personal self-concept of ability focused on computers. This argument is analogous to the self-concept of ability processes that have been shown to account for gender differences in subjects such as maths and science (Dickhauser & Stiensmeier-Pelster, 2002; Wigfield & Eccles, 2000). The psychological process mechanisms here are very similar to what we have described above in terms of person and situation. The personal or self-schema concerned with self-concept of ability incorporated motivational dimensions concerned with success and failure expectations and value dimensions. These self-schema are activated in virtual learning environments and influence the specific learning behavior. A substantial part of what has been studied as computer anxiety, again often observed along gender lines, involves the expectations of failure and threat made salient by the virtual learning environment. A recent study of children from 5 to 12 years of age (Downes, 2002) involved detailed observation of the way children used computers at home and at school. Downes suggested that the development of familiarity with computers was a motivational issue, and drawing on Dewey's writings referred to his concepts of "playful seriousness and serious play". Home use of computers was more likely to show patterns of shifting focus from play to work back to play and so students were able to "complete purposeful tasks through playful means". This blurring of the lines between play and work in home use of computers was in strong contrast to the patterns of use these same children experienced within their school classrooms. Classroom computer use was generally teacher directed and the content of computer experiences predominantly directed to achieving specific criteria in what are referred to as "key learning areas". These experiences while of interest in themselves, also contribute to

the development of the self-schema, or self-concept of ability that will be activated in succeeding computer experiences (Downes, 2002).

In this brief, and by no means exhaustive, review of factors influencing students' reactions to virtual learning environments, we have attempted to highlight the importance of considering the impact of both situational and individual factors. Comparisons of the learning outcomes resulting from various forms of virtual learning environments and more traditional methods have generally shown that virtual learning environments can produce higher learning outcomes. But it is also clear that motivational factors also influence learning outcomes. Research findings point to the critical role of motivational processes, such as interest, to direct and sustain learning, and demonstrate how specific design features of virtual learning environments can enhance students' interest and engagement and produce stronger learning outcomes. However, the social character of learners and the influence this can have on the level of interactivity within virtual learning environments also needs to be taken into account.

While the research findings to date allow us to paint a broad picture of the effectiveness of virtual learning environments in comparison to traditional learning situations, there is still much work to be done. Research paradigms that emphasize the real-time reactivity of students to features of the learning environment have the potential to add considerably to our understanding of students' reactions to learning environments. Just as educators have been innovative in their use of the new technologies, so too researchers are beginning to utilize the functionality available in virtual learning environments to provide important insights into learning not easily obtained in more traditional settings. Future work in this area needs to ensure that the critical role of individual and situational factors discussed in this chapter continue to be acknowledged so that the human aspect of virtual learning environments is not lost.

#### ENDNOTE

1. These questions were an "international option". Twenty of the 32 countries participating in PISA 2000 took this option.

#### REFERENCES

- Ainley, M. (1987). The factor structure of curiosity measures: breadth and depth of interest curiosity styles. *Australian Journal of Psychology* 39(1), 53–59.
- Ainley, M. (1998). Interest in Learning and the Disposition of Curiosity in Secondary Students: Investigating Process and Context. In: Hoffmann, L., Krapp, A., Renninger A., and Baumert, J. (Eds.) *Interest and Learning: Proceedings of the Seeon Conference on Gender and Interest*. Kiel, Germany: IPN.

- Ainley, M., Hidi, S., & Berndorff, D. (2002a). Interest, learning and the psychological processes that mediate their relationship. *Journal of Educational Psychology* 94(3), 545–561.
- Ainley, M., Hillman, K., & Hidi, S. (2002b). Gender and interest processes in response to literary texts: situational and individual interest. *Learning and Instruction* 12, 411–428.
- Ames, C. (1992). Classrooms: goals, structure and student motivation. *Journal of Educational Psychology* 84, 261–271.
- Ames, C. & Archer, J. (1988). Achievement goals in the classroom: student learning, strategies and motivation processes. *Journal of Educational Psychology* 80, 260–267.
- Atkinson, R. K. (2002). Optimizing learning from examples using animated pedagogical agents. *Journal of Educational Psychology* 94(2), 416–427.
- Azevedo, R., Ragan, S., Cromley, J. G., & Pritchett, S. (April 1–5, 2002). Do Different Goal-Setting Conditions Facilitate Students' Ability to Regulate Their Learning of Complex Science Topics With RiverWeb? *Paper presented at the Annual Meetings of the American Educational Research Association, New Orleans.*
- Bergin, D. A., Ford, M. E., & Hess, R. D. (1993). Patterns of motivation and social behavior associated with microcomputer use of young children. *Journal of Educational Psychology* 85(3), 437–445.
- Berlyne, D. E. (1960). *Conflict, Arousal And Curiosity*. New York: McGraw-Hill.
- Berlyne, D. E. (1978). Curiosity and learning. *Motivation and Emotion* 2, 97–175.
- Beswick, D. G. (1971). Cognitive process theory of individual differences in curiosity. In: Day, H. I., Berlyne, D. E., and Hunt, D. E. (Eds.) *Intrinsic Motivation: A New Direction in Education*. Toronto: Holt, Rinehart & Winston of Canada, 156–179.
- Boekaerts, M. (1996). Personality and the psychology of learning. *European Journal of Personality* 10, 377–404.
- Bransford, J. D., Brown, A. L., & Cocking, R. R. (1999). *How People Learn: Brain, Mind, Experience and School*. Washington, D.C.: National Academy Press.
- Chandler, P. & Sweller, J. (1991). Cognitive load theory and the format of instruction. *Cognition and Instruction* 8, 293–332.
- Chen, H., Wigand, R. T., & Nilan, M. S. (1999). Optimal experience of web activities. *Computers in Human Behavior* 15, 585–608.
- Christmann, E., Badgett, J., & Lucking, R. (1997). Microcomputer-based computer-assisted instruction within differing subject areas: a statistical deduction. *Journal of Educational Computing Research* 16(3), 281–296.
- Clark, R. E. (1994). Media will never influence learning. *Educational Technology Research and Development* 42(2), 21–29.
- Cordova, D. I. & Lepper, M. R. (1996). Intrinsic motivation and the process of learning: beneficial effects of contextualization, personalization, and choice. *Journal of Educational Psychology* 88(4), 715–730.
- Craig, S. D., Gholson, B., & Driscoll, D. M. (2002). Animated pedagogical agents in multimedia educational environments: effects of agent properties, picture features, and redundancy. *Journal of Educational Psychology* 94(2), 428–434.
- Csikszentmihaly, M. & Larson, R. W. (1987). Validity and reliability of the experience-sampling method. *Journal of Nervous and Mental Disease* 175(9), 526–536.
- Csikszentmihalyi, C. (1990). *Flow: The Psychology of Optimal Experience*. New York: Harper & Row.
- Day, H. I. (1971). The measurement of specific curiosity. In: Day, H. I., Berlyne, D. E., and Hunt, D. E. (Eds.) *Intrinsic Motivation: A New Direction in Education*. Toronto: Holt, Rinehart & Winston of Canada, 99–112.
- Dickhauser, O. & Stiensmeier-Pelster, J. (2002). Gender differences in computer work: evidence for the model of achievement-related choices. *Contemporary Educational Psychology* 27, 486–496.

- Downes, T. (2002). Blending play, practice and performance: children's use of the computer at home. *Journal of Educational Enquiry* 3(2), 21–34.
- Dweck, C. S. (1986). Motivational processes affecting learning. *American Psychologist* 41, 1040–1048.
- Elliot, A. J. & Harackiewicz, J. M. (1996). Approach and avoidance achievement goals and intrinsic motivation: a mediational analysis. *Journal of Personality and Social Psychology* 70, 461–475.
- Fivush, R. (1998). Interest, Gender and Personal Narrative: How Children Construct Self-understanding. In: Hoffmann, L., Krapp, A., Renninger, A., & Baumert, J. (Eds.) *Interest and Learning: Proceedings of the Seeon Conference on Gender and Interest*. Kiel, Germany: IPN.
- Flach, J. M. & Holden, J. G. (1998). The reality of experience: Gibson's way. *Presence* 7(1), 90–95.
- Geirland, J. (1996). *Go with the Flow*. Available from [http://www.wired.com/wired/archive/4.09/czik\\_pr.html](http://www.wired.com/wired/archive/4.09/czik_pr.html).
- Goldman, S. R., Duschl, R. A., Ellenbogen, K., Williams, S. M., & Tzou, C. (2003). Science inquiry in a digital world: possibilities for making thinking visible. In: van Oostendorp, H. (Ed.) *Cognition in a Digital World*. Mahwah, NJ: Lawrence Erlbaum Associates, 253–283.
- Hartley, K. & Bendixen, L. D. (2001). Educational research in the Internet age: examining the role of individual characteristics. *Educational Researcher* 30(9), 22–26.
- Hickey, D. T. (1997). Motivation and contemporary socio-constructivist instructional perspectives. *Educational Psychologist* 32(3), 175–193.
- Hidi, S. (1990). Interest and its contribution as a mental resource for learning. *Review of Educational Research* 60, 549–571.
- Hidi, S. & Berndorff, D. (1998). Situational Interest And Learning. In: Hoffmann, L., Krapp, A., Renninger, A., and Baumert, J. (Eds.) *Interest and Learning: Proceedings of the Seeon Conference on Gender and Interest*. Kiel, Germany: IPN, 74–90.
- Hidi, S. & Harackiewicz, J. M. (2000). Motivating the academically unmotivated: a critical issue for the 21st century. *Review of Educational Research* 70, 151–179.
- Holden, C. (2002). Contributing to the debate: the perspectives of children on gender, achievement and literacy. *Journal of Educational Enquiry* 3, 97–110.
- Kelleher, R. (2000). A review of recent developments in the use of information communication technologies (ICT) in science classrooms. *Australian Science Teachers Journal* 46(1), 33–38.
- Konradt, U. & Sulz, K. (2001). The experience of flow in interacting with a hypermedia environment. *Journal of Educational Multimedia and Hypermedia* 10(1), 69–84.
- Koschmann, T. (1996). Paradigm shifts and instructional technology: an introduction. In: Koschmann, T. (Ed.) *CSCL: Theory and Practice of an Emerging Paradigm*. Mahwah, NJ: Lawrence Erlbaum Associates.
- Kozma, R. B. (1994a). A reply: media and methods. *Educational Technology Research and Development* 42(3), 11–14.
- Kozma, R. B. (1994b). Will media influence learning? Reframing the debate. *Educational Technology Research and Development* 42(2), 7–19.
- Krapp, A. (2002). An educational-psychological theory of interest and its relation to SDT. In: Deci, E. L. and Ryan, R. M. (Eds.) *The Handbook of Self-Determination Research*. Rochester: University of Rochester Press, 405–427.
- Krapp, A., Hidi, S., & Renninger, A. (1992). Interest, learning and development. In: Renninger, A., Hidi, S., and Krapp, A. (Eds.) *The Role of Interest in Learning and Development*. Hillsdale, NJ: Lawrence Erlbaum Associates, 3–25.

- Larson, R. W. & Verma, S. (1999). How children and adolescents spend time across the world: work, play, and developmental outcomes. *Psychological Bulletin* 125(6), 701–736.
- Lepper, M. R. (1985). Microcomputers in education: motivational and social issues. *American Psychologist* 40(1), 1–18.
- Lepper, M. R. & Gurtner, J.-L. (1989). Children and computers: approaching the twenty-first century. *American Psychologist* 44(2), 170–178.
- Lester, J. C., Converse, S. A., Kahler, S. E., Barlow, S. T., Stone, B. A., & Bhogal, R. (1997). The Persona Effect: Affective Impact of Animated Pedagogical Agents. *Paper presented at the CHI '97 Human Factors in Computing Systems*.
- Lester, J. C., Towns, S. G., Callaway, C. B., Voerman, J. L., & FitzGerald, P. J. (2000). Deictic and emotive communication in animated pedagogical agents. In: Cassell, S., Prevost, S., and Sullivant, J. (Eds.) *Embodied Conversational Agents*. Boston: MIT Press, 123–154.
- Mautone, P. D. & Mayer, R. E. (2001). Signaling as a cognitive guide in multimedia learning. *Journal of Educational Psychology* 93(2), 377–389.
- Mayer, R. E. (1997). Multimedia learning: are we asking the right questions? *Educational Psychologist* 32(1), 1–19.
- Mayer, R. E. & Chandler, P. (2001). When learning is just a click away: does simple user interaction foster deeper understanding of multimedia messages? *Journal of Educational Psychology* 93(2), 390–397.
- Mayer, R. E., Heiser, J., & Lon, S. (2001). Cognitive constraints on multimedia learning: when presenting more material results in less understanding. *Journal of Educational Psychology* 93(1), 187–198.
- Mayer, R. E., Mautone, P. D., & Prothero, W. (2002). Pictorial aids for learning by doing in a multimedia geology simulation game. *Journal of Educational Psychology* 94(1), 171–185.
- Mayer, R. E., Moreno, R., Boire, M., & Vagge, S. (1999). Maximizing constructivist learning from multimedia communications by minimizing cognitive load. *Journal of Educational Psychology* 91(4), 638–643.
- Mayer, R. E., Moreno, R., Spires, H. A., & Lester, J. C. (2000). The Case for Social Agency in Computer-Based Teaching: Do Students Learn More Deeply When They Interact with Animated Pedagogical Agents? *Paper presented at the Annual Meetings of the American Educational Research Association*, New Orleans, LA.
- Mischel, W. (1973). Toward a cognitive social learning reconceptualization of personality. *Psychological Review* 80, 252–283.
- Mischel, W. & Shoda, Y. (1995). A cognitive-affective system theory of personality: reconceptualizing situations, dispositions, dynamics, and invariance in personality structure. *Psychological Review* 102(2), 246–268.
- Mitchell, M. (1993). Situational interest: its multifaceted structure in the secondary school mathematics classroom. *Journal of Educational Psychology* 85, 424–436.
- Moreno, R. & Mayer, R. E. (2002). Verbal redundancy in multimedia learning: when reading helps listening. *Journal of Educational Psychology* 94(1), 156–163.
- Moreno, R., Mayer, R. E., & Lester, J. C. (2000). Life-like Pedagogical Agents in Constructivist Multimedia Environments: Cognitive Consequences of Their Interaction. *Paper presented at the World Conference on Multimedia, Hypermedia, and Telecommunications (ED-MEDIA)*, Montreal.
- Nicholls, J. G., Patashnick, M., & Nolen, S. B. (1985). Adolescents' theories of education. *Journal of Educational Psychology* 77, 683–692.
- OECD. (2001). *Knowledge and Skills for Life: First Results from the OECD Programme for International Student Assessment (PISA) 2000*. Paris: OECD Publications.
- Pavio, A. (1986). *Mental Representations: A Dual Coding Approach*. Oxford, England: Oxford University Press.

- Pearce, J. & Ainley, M. (2002). Learning with ICT: the role of interactivity and student motivation. In: Rodrigues, S. (Ed.) *Opportunistic Challenges: Teaching and Learning with ICT*. New York: Nova Science Publishers, Inc., 133–158.
- Pearce, J., Ainley, M., & Howard, S. (2005). The ebb and flow of online learning. *Computers and Human Behaviour*, 21, 745–771.
- Pekrun, R. (2000). A social-cognitive, control-value theory of achievement emotions. In: Heckhausen, J. (Ed.) *Motivation Psychology of Human Development*. Oxford, U.K.: Elsevier, 143–163.
- Pintrich, P. R. (2000). An achievement goal theory perspective on issues in motivation terminology, theory and research. *Contemporary Educational Psychology* 25, 92–104.
- Reeves, B. & Nass, C. (1996). *The Media Equation*. New York: Cambridge University Press.
- Ricci, C. M. & Beal, C. R. (2002). The effects of interactive media on children's story memory. *Journal of Educational Psychology* 94(1), 138–144.
- Richardson, N. (2002). Mediating processes in the relationship between individual and situational interest. Unpublished Honours Thesis, University of Melbourne.
- Salzman, M. C., Dede, C., Loftin, R. B., & Chen, J. (1999). A model for understanding how virtual reality aids complex conceptual learning. *Presence: Teleoperators and Virtual Environments* 8(3), 293–316.
- Scardamalia, M. & Bereiter, C. (1994). Computer support for knowledge-building communities. *The Journal of Learning Sciences* 3(3), 265–283.
- Schiefele, U. (1996). Topic interest, text representation, and quality of experience. *Contemporary Educational Psychology* 21, 3–18.
- Selwyn, N. (1998). The effect of using a home computer on students' educational use of IT. *Computers and Education* 31, 211–227.
- Soyibo, K. & Hudson, A. (2000). Effects of computer-assisted instruction (CAI) on 11th graders' attitudes to biology and CAI and understanding of reproduction in plants and animals. *Research in Science and Technological Education* 18(2), 191–199.
- Spielberger, C. D. & Krasner, S. S. (1988). The assessment of state and trait anxiety. In: Noyes, R., Roth, M., and Burrows, G. D. (Eds.) *Handbook of Anxiety: Classification, Etiological Factors, and Associated Disturbances*, Vol. 2. New York: Elsevier, 31–51.
- Spitzer, D. R. (1996). Motivation: the neglected factor in instructional design. *Educational Technology* 36(5–6), 45–49.
- Subrahmanyam, K., Greenfield, P., Kraut, R., & Gross, E. (2002). The impact of computer use on children's and adolescents' development. In: Calvert, S. L., Jordan, A. B., and Cocking, R. R. (Eds.) *Children in the Digital Age: Influences of Electronic Media on Development*. Westport CT: Praeger.
- Urduan, T. & Maehr, M. L. (1995). Beyond a two-goal theory of motivation and achievement: a case for social goals. *Review of Educational Research* 65, 213–243.
- Wentzel, K. (1992). Motivation and achievement in adolescence: a multiple goals perspective. In: Schunk, D. H. and Meece, J. (Eds.) *Student Perceptions in the Classroom*. Hillsdale, NJ: Erlbaum, 287–306.
- Wentzel, K. (1999). Social influences on school adjustment: commentary. *Educational Psychologist* 34, 59–69.
- Wigfield, A. & Eccles, J. S. (2000). Expectancy-value theory of achievement motivation. *Contemporary Educational Psychology* 25, 68–81.
- Winn, W. (2002). Current trends in educational technology research: the study of learning environments. *Educational Psychology Review* 14(3), 331–351.
- Wittrock, M. C. (1989). Generative processes of comprehension. *Educational Psychologist* 24, 345–376.

## Chapter 16: User Adaptation in Supporting Exploration Tasks in Virtual Learning Environments

KINSHUK\*, TAIYU LIN\* AND ASHOK PATEL†

\**Information Systems Department, Massey University, Palmerston North, New Zealand,*

†*CAL Research and Training Center, De Montfort University, Leicester, United Kingdom*

### 1. INTRODUCTION

In the increasing heterogeneous student population in both the academic and corporate training environments, the need of a customized instructional design is becoming more and more obvious. There are a variety of factors, including the past experience, cognitive abilities, and personal preference, that could influence the knowledge transfer, acquisition, and construction during the learning process.

The ideal learning environment described by Gilbert and Han (1999) consists of many (or more exactly “infinite”) instructors, each having their unique teaching styles, available for every learners where the learners could choose the instructor that perfectly matches their own learning styles. Forbus and Feltovich (2001) even added that the instructors or assistants should be at every learner’s elbow whenever they are ready to learn, and for however long it takes. Aptitude-Treatment Interaction theory (Cronbach & Snow, 1989) also suggests that the best learning results when the instruction matches the learner’s aptitude.

Virtual learning environments (VLEs), which are defined in the context of our research as sets of computer/internet-based tools created to enhance learners’ learning experiences, attempt to provide individualized instruction by means of customizing the domain content and appearance of the learning environment, hence matching the instruction to the learner’s attributes. In the VLEs, customization could be within users’ control (adaptable), or achieved without users’ intervention (adaptive). Nonetheless, the generalized term “adaptivity” supersedes both of them and is used to cover the idea in the following discussion. Systems equipped with adaptivity have been proven more effective and efficient than traditional non-adaptive systems (De Bra et al., 1999). Sampson et al. (2002) provide an extensive discussion and examples of VLEs that are built with the idea of adaptivity.

Most of the recent VLEs have been implemented as adaptive hypermedia systems due to the widespread use of internet as a medium of learning. The adaptive techniques used in such systems can be categorized into either adaptive navigational support or adaptive content presentation (Brusilovsky et al.,

1998). Adaptive navigational support works at the link level and is usually implemented as visual cues attached to links to express suggestions. On the other hand, the adaptive content presentation works at the (learning) content level and tailor the presentation of information according to learners' competence level, preferences, goals, and so on.

One of the most important components in an adaptive VLE is the student model. Attributes of students are collected, analyzed, and stored in student models. Most student models focus on students' competence levels (hence called competence models), and they are implemented either as state models (Staff, 2001) or as process model (El-Sheikh & Sticklen, 1998). However, there is a growing consensus of student (user) modeling community that modeling competence alone could not provide sufficient adaptative ability that a VLE should have in an increasingly heterogeneous demography of the learners (Lovett et al., 2000).

We, therefore, introduce a new and complementary approach to student modeling, called the cognitive trait model (CTM). CTM is concentrated on those student attributes (cognitive traits) that are persistent for a long duration, and consistent for a variety of tasks. The role of CTM is not to replace existing competence models but to supplement in order to provide fine-grained adaptivity. We shall examine the existing adaptation techniques that rely on the student modeling, and then describe how CTM provides a more efficient and reliable way to achieve them.

## 2. ADAPTATION IN VIRTUAL LEARNING ENVIRONMENTS

The adaptive characteristics improve the usability of the VLEs. Without adaptivity, these environments would present the same material, with the same set of links, to all learners. It could work well if the intended user group has the same/similar learning characteristics, but it is rarely the case in real learning environment. Without adaptivity, such systems will mimic the traditional classroom, with one-to-many interaction.

Adaptive VLEs, with the ability to change the content or structure of the links according to the student's need, provide similar situation as there are many instructors available for each individual student, "the learner's chances of doing well in this classroom would appear to be significantly better than in a classroom with one instructor because each learner would adapt to the instructor(s) that would facilitate his/her learning style" (Gilbert & Han, 1999). Inclusion of adaptivity makes these systems more usable and suitable for a wider range of users. Brusilovsky et al. (1998) further distinguished two categories of features that could be adapted in VLEs: navigational adaptation and content adaptation.

Navigational adaptation focuses on building a sensible navigational path for every individual student. It supports the learning process by providing



a customized learning space for each learner. Adaptive navigation plays a supportive role and provides suggestions on how to go through the learning materials in a way that could suit the student's learning style. This is often accomplished by providing guidance on the available paths in a manner that is both pedagogically sound and customized to each individual student.

Content adaptation tailors the learning content, which is to be presented to the learner, according to the learner's current requirements and domain competence. "There is considerable evidence that different people learn best in different ways" (Kay & Kummerfeld, 1994). This means that it is very unlikely that one presentation style could suit to all students. To fully utilize the advantage of adaptive presentation, the systems need to (Pascoe & Sallis, 1998):

- provide supplementary material for background areas to those students whose background knowledge is below what is presumed by the instructor;
- provide different styles of documentation for the definitions/concepts; and
- give answers to the exercises using clearly identifiable supplementary material, so the students can be directed to clarify their misunderstandings.

Most of the research efforts on adaptivity in VLEs have focused on demonstrating the usefulness of technology in providing the adaptivity. However, most of the implementations lack the theoretical background of how the adaptivity should support the learners' cognitive processes during learning. As a result, combinatorial use of these techniques has not provided consistent benefits to the learners. All adaptivity techniques have their strengths and weaknesses, and they do not identify with each other as a mean to support learning process (Kashihara et al., 2000).

Exploration Space Control (ESC) tries to integrate and reorganize existing adaptive techniques and to offer the best result of adaptivity by combining both the adaptive content and the adaptive navigational support (Kashihara et al., 2000). We shall first discuss the theoretical structure of ESC and its formalization and then describe the CTM that uses ESC as its underlying theoretical framework.

### 3. EXPLORATION SPACE CONTROL

Exploration is a self-directed process and is an effective way of learning (Carroll et al., 1985). Exploratory learning, which involves searching the information, navigation through the learning space, understanding of domain-related conceptual knowledge and acquiring skills, often require high cognitive effort on the part of the learner.

ESC is a theoretical framework to support exploratory learning in multimedia-based educational systems by allowing students to explore/acquire domain concepts and skills with less cognitive load as possible (Kashihara et al., 2000).

ESC attempts to limit the learning space, called exploration space, to control the students' cognitive load at an adequate level depending on their learning approaches. ESC tries to facilitate adequate learning for a whole spectrum of learning competence by adopting two extreme approaches—active learning support and step-by-step learning support.

Active learning support offers the initial learning space as wide as possible using only those restrictions that are required to protect the students from cognitive overload, and adding or removing restrictions according to students' progresses. This approach fits the students with better competence level and with more familiarity and experiences of the domain; for example, those who come back for further education after working in an area related to the domain.

The step-by-step learning support adopts the opposite approach from active learning support by starting with as restricted information space as possible and then gradually enlarging. This approach provides a sense of comfort and security for those who are completely new to the domain area or do not have active learning styles. By the combination of these two approaches, "ESC can be employed to facilitate proper learning for all types of learners" (Kashihara et al., 2000).

The main concept of ESC is control; to control the available learning space by adaptive navigation and to control the presentation of the learning content by adaptive presentation. The most important reason for the control is to try to give the student the most suitable instructional style to achieve the best results. Several types of control are proposed by ESC at different aspects:

1. *Embedded information*: Information sources (e.g., different text fragments) are selected by according to individual student needs and used by the process of scaffolding to create the information space.
2. *Limiting information resources*: The selection of information resources has great effect on what the student is going to see and interact with. Multimedia resources that suit the student's learning style and integrated with consideration of student's cognitive ability yields the best result.
3. *Limiting exploration paths*: ESC supports the use of navigational adaptation to offer the suitable paths in the learning space. This ensures that the students are not discouraged by the complexity of the entire learning space and do not receive the material that is not appropriate for them at this stage of learning process.
4. *Limiting information to be presented*: When the information includes many media resources and/or is available in large amounts, care has to

be taken on how to present it in order to achieve the best effect. More information does not mean better understanding; sometimes it is a burden on the students. For example, textual explanation that matches the abstractness and granularity currently appropriate for a student may produce better learning result than flashy multimedia presentation. Therefore, all information resources are to be filtered and only the necessary ones to be presented.

The aim for those different controls is to avoid overloading the cognitive capacity of the students as this might greatly discourage them. By carefully adjusting those controls, it allows a student to progress in his/her own pace in a way that the learning satisfaction is obtained and thus the learning efficiency and effectiveness ensue. When the students start to engage in their learning more actively, the levels of the controls are gradually reduced in order to allow the learning to be maximized.

#### 4. EXPLORATION SPACE CONTROL ELEMENTS

Exploration space control elements (ESCEs) are those gauges on both the learning content and the navigational paths that could be modified to create different versions of the same materials to suit different needs. Therefore, the selection of the ESCEs has to cover both the content and the navigation. Table 1 attempts to list some examples of these gauges.

There are two elements for the path: the number of the path and the relevance of the path. Since most of the modern adaptive VLEs are built using hypermedia technology, paths are presented as a series of links. Therefore, the term link and path will be used interchangeably in the discussion.

There are six types of navigational paths identified by Kinshuk et al. (1999) as listed in Table 2.

Links with higher relevancy are links to the concepts that are closely related to the domain (direct successor, fine-grained links), while the links with lower relevancy are to the concepts that are more of supplementary nature (excursion links).

*Table 1. Exploration space control elements*

Path	Number Relevance
Content	Amount (detail) Concreteness Structureness
Info resource	Number

Table 2. Types of link and their relevance to the domain

Types of Link	Relevance to the Domain
Direct successor link	
Fine-grained link	
Glossary link	
Problem link	
Parallel concept link	
Excursion link	

The category of path (Table 1) covers both the number of paths and their relevance. The number of paths represents the amount of links to be presented to the students and the relevance of paths guides how relevant the linked targets should be and also determines the proportions of link types (Table 2) included.

In Table 1, there are three ESCEs on content; the amount/detail, the concreteness, and the structureness. Amount/detail of content decides how detailed the knowledge presentation is. The detailness affects the volume of the presentation; therefore, both of them are classified as only one ESCE.

The concreteness determines the abstract level of the information. The more concrete a piece of information is the more fundamentals and more examples it should include. Abstraction refers to the opposite of the concreteness.

The structureness of information indicates the ordering, arrangement, and sequencing of the information presented as a series/set of concepts. Concepts may or may not be directly or indirectly related to each other with certain sequence. The elaboration theory (Reigeluth, 1992) suggested a structured approach by stating that the instruction should be organized in increasing order of complexity for optimal learning. The more structured the information is the more orderly fashion it could be presented in. Structured information helps the learner in building up the mental model, but provides less freedom for free navigation.

Another category in Table 1 is information resource (shortened as Info resource). Information could be presented by different media, such as text, audio, visual, and so on. The effect of each media for presenting information is different. "Audio is good to stimulate imagination, video clips for action information, text to convey details whereas diagrams are good to convey ideas" (Kinshuk et al., 1999). Besides, each media type has different impact on each individual's learning. If there is more than one media (e.g., a textual explanation and a chart), it could make the information more impressive and easier for future recall. The greater the number of information resources, the more choices the system has for selection to suit the students' characteristics.

The formalization of ESC provides practical guidelines for producing VLEs that provide the facility of adaptivity, and at the same time adhere to the principle of human cognition base of the framework of ESC. In the next section, we shall discuss the formalization process of ESC.

#### 5. EXPLORATION SPACE CONTROL FORMALIZATION

Exploration Space Control Formalization (ESCF) provides guidelines on how to utilize the ESC framework to assist learning process in VLEs (Lin, 2002). The aim of ESCF is to provide a mould where the courseware content can be just cast in and the benefits of adaptivity could be ensured. ESCF matches the levels of control (size of exploration space, difficulty, etc.) with the differences of each student's learning abilities. Various cognitive traits (CTs) have been selected from the literature on human cognition, various characteristics of each of the selected trait are identified, and various control levels of ESC are then adapted to those traits to suit the individual's differences.

#### 6. THE SELECTION OF COGNITIVE TRAITS

Certain human learning abilities are derived from the aggregation of a group of lower-level abilities. Cognitive load is a good example. Cognitive load is an important factor in human learning, and its implication in learning environment has received intense discussion (Kashihara et al., 2000; Kinshuk et al., 1999). But the function and the ability of cognitive load can be broken down into even subtler elements. Students with higher cognitive load learn faster and have better comprehension. The speed of learning is also related to how fast the human brain processes the incoming information (information processing speed), the ability to integrate the new knowledge into existing one (associative learning skill), and the ability to work out the underlying rules of the presented information (inductive reasoning skill). The comprehension is also closely linked with associative learning skills, inductive learning skills, working memory, and also the ability to reflect on what was learnt, and determine whether the previous perceptions were correct or not (reflectivity).

Besides, with higher cognitive load, someone can easily reduce the load on his/her working memory by constructing a learning strategy, which represent higher-order rules and can generate other rules/data from it (Scandura, 1973). For example, some people remember the series of numbers (such as telephone numbers) by remembering the sequence of the positions of the number pad, while someone good in music could remember it as a series of pitches of sound; many others will probably have to look up the phone book and dial the numbers many times just to remember them.

The cognitive load consists of the function of information processing ability (Brown & Hirst, 1983), the inductive and associative learning skills (William, 2001), and determines the load of the working memory and thus its efficiency (Anderson, 1983). Therefore, it could be said that the cognitive load is in the higher level of the ability hierarchy than those of information processing speed, inductive reasoning skill, associative reasoning skill, and working memory capacity. For the purpose of this discussion, we need to consider the learning ability as the most elementary and basic in order to identify clear matches and relationships of the learning abilities to the curriculum designs. Therefore, the definition of CT here is the lowest-level element, in the ability hierarchy, of the current concern which is the study of the relationship and proportion of presentation elements to the learner's basic cognitive ability. The cognitivist view of learning, which posits that knowledge is represented as mental schema and learning is the process of reorganizing the schema, is adopted here and the term "trait" denotes the characteristic of the abilities that is relatively persistent in time and consistent across domains.

Unlike the knowledge or expertise, which is more domain-specific and evolving, CTs are relatively stable and portable over different tasks. Thus, the student model obtained in one domain can provide more reliable prediction of the performance the same student will have in another domain. Differences of CTs cause differences in quality, efficiency, and overall performance on the tasks carried out. Four CTs were selected from the cognitive science literature as the basis of cognitive load, as discussed above: working memory capacity, inductive reasoning ability, information processing speed, and associative learning skill.

## 7. WORKING MEMORY CAPACITY

Working memory is the cognitive system that allows us to keep active a limited amount of information (roughly  $7 \pm 2$  items) for a brief period of time (Miller, 1956) to temporarily store the outcomes of intermediate computations during solving a problem and to perform further computations on these temporary outcomes (Baddeley, 1986). The research on working memory (Huai, 2000; Kearsley, 2001) shows that the speed of learning, the memorization of learned concepts, effectiveness of skill acquisition, and many other learning abilities are all affected by the capacity of working memory, which is mainly comprised of two components; the limited storage system and the central execution unit carrying out the cognitive operation efforts.

There are already many educational system design guidelines, written by human-computer interaction (HCI) experts, devoted to address the relationship between the storage aspect of the working memory and the good interface designs. The effort to facilitate learning with regard to working memory is mainly focused on the instructional design to assist the synchronized

operation with the central execution unit by assisting the formation of higher-order rules, build up of the mental model, and of course not to overload the storage system of the working memory. The working memory is analyzed in the following with respect to learning.

#### **7.1. When the Working Memory Capacity of the Learner is Low**

The number of paths and the amount of information should decrease to protect the learners from getting lost in the vast amount the information, from overloading the working memory with complex hyperspace structure (Kashihara et al., 2000), and to allow more time for learner to review essential content if necessary. The relevance of the information should increase so the learners get the important information. The concreteness of the information should increase so the learner can grasp the fundamental rules first and use them to generate higher-order rules as suggested by the structured learning theory (Scandura, 1973). The structure of the information should stay unchanged. The increase of structureness could facilitate the building of mental model and assist future recall of the learned information. But as Huai (2000) indicated, the versatile learners tend to have smaller short-term memory (storage aspect of working memory) than serial learners, and the increase of structureness limits their navigational freedom, which is the primary way they learn. So basically, the net effect cancels out and the structure of the information is recommended to stay unchanged. The number of the information resources should increase, so the learners could choose the media resources that work best along their cognitive styles and allow deeper understanding on the subject domain ( Craik & Lockhart, 1972; Cronbach & Snow, 1989).

#### **7.2. When the Working Memory Capacity of the Learner is High**

The number of paths and the amount of information should increase and the relevance of the information should decrease to enlarge the exploration and domain space of the learning process so that more knowledge is available to the learners who process more higher-order rules which “account for creative behaviour (unanticipated outcomes) as well as the ability to solve complex problems by making it possible to generate (learn) new rules” (Kearsley, 2001). The concreteness of the information should decrease to avoid boredom for the learners resulting from too many similar examples. The structure of the information and the number of information resources should stay unchanged because there are no direct and apparent benefits associated.

The above discussion can be formalized as shown in Table 3.

Table 3. Working memory formalization

Level	Path		Content		Info Resource	
	Number	Relevance	Amount	Concreteness	Structure	Number
Low	-	+	-	+	\	+
High	\+	\-	+	-	\	\

Note: +, should increase; -, should decrease; \+, should slightly increase (recommend only) or could increase; \-, should slightly decrease (recommend only) or could decrease.

For example, Table 3 suggested that the number of paths (navigational link) should decrease while the learner’s working memory is identified low.

## 8. INDUCTIVE REASONING SKILL

Induction is to figure out the rules/theories/principles from observed instances of event. William (2001) described it as “inductive reasoning works the other way (from deduction), moving from specific observations to broader generalizations and theories”. It is a bottom-up approach and has an open-ended and exploratory nature.

The research on inductive reasoning skill (Heit, 2000; William, 2001) shows that higher the inductive reasoning ability, the easier it is to build up the mental model of the information learned. Mental model, also called cognitive structure, “provides meaning and organization to experiences and allows the individual to go beyond the information given” (Kearsley, 1998). From the constructivist’s point of view, the learner’s selection and transformation of information, constructs, hypotheses, and the decision process, all rely on the mental model (Bruner, 1973). For students who possess better inductive reasoning skill, it is easier for them to recognize a previously known pattern, generalize higher-order rules and, as a result, the load on working memory is reduced, and learning process is more efficient. For its educational value, there is a need to specify means to support those with lower inductive reasoning skill and to maximize the learning for those who are already good at induction. The following discussion analyzes the effect of poor and good inductive reasoning skill on the learning process.

### 8.1. When the Learner’s Inductive Reasoning Skill is Poor

The number of paths should increase to give the learner more opportunity for observation and thus promote induction. The relevance of paths should decrease and the concreteness of the information should increase so the learner can have more diverse observations to promote induction. The amount of



Table 4. Inductive reasoning skill formalization

Level	Path		Content		Info Resource	
	Number	Relevance	Amount	Concreteness	Structure	Number
Poor	\+	\-	+	+	+	\
Good	\-	\	-	\-	\	\

information should increase to give detailed and step-by-step explanation to the learners, so they can see the rules/theories easier. The structure of the information should increase so that it is easier for the learner to build up the mental model and see the sequential relationship of the topics and relationship of concepts. The number of information resources does not need to change because there are no direct and apparent benefits associated.

### 8.2. When the Learner's Inductive Reasoning Skill is Good

The number of paths and the amount of the information should decrease to speed up the learning process. The concreteness of the information should decrease to avoid the boredom result from too many similar examples. The structure of the information, the number of information resources, and relevance of paths do not need to change because there are no direct and apparent benefits associated.

The above discussion can be formalized as shown in Table 4.

## 9. INFORMATION PROCESSING SPEED

Information processing speed determines how fast the learners acquire the information correctly. The learner may process the information in such a low speed that he/she may be unable to hold enough detail in working memory to permit decoding of the overall meaning of the presented domain content (Bell, 2000). Instructional design of VLEs should take into account the consideration of learner's information processing speed. They should be able to provide adequate support in the form of adaptivity by providing hints to the learners with slow processing speed and to facilitate the maximum intake of knowledge for learners with fast processing speed. The effect of differences in information processing speed is analyzed as shown below.

### 9.1. When the Learner's Information Processing Speed is Slow

The number of the paths and the amount of information should decrease, and the relevance of the paths should increase so that only the fundamental/

Table 5. Information processing speed formalization.

Level	Path		Content		Info Resource	
	Number	Relevance	Amount	Concreteness	Structure	Number
Slow	-	+	-	\	\+	\
Fast	+	-	+	\	\	\

important points are presented to the learner to enable him/her to complete the course on time. The structure of the information should increase to facilitate and speed up the learning process. The concreteness of the information and the number of information resources do not need to change because there are no direct and apparent benefits associated.

### 9.2. When the Learner's Information Processing Speed is Fast

The number of paths, the amount of information should increase, and the relevance of the paths should decrease to enlarge the information space and hence the available knowledge and gain in-depth insight into the subject matters. The concreteness of the information, the structure of the information, and the number of the information resources do not need to change because there are no direct and apparent benefits associated.

The above discussion can be formalized as shown in Table 5.

## 10. ASSOCIATIVE LEARNING SKILL

Associative learning skill denotes the skill to link existing knowledge to the new information to make sense of it and thus the information becomes new knowledge. Quinton (2001) pointed out "we do not learn information as discrete, isolated facts, but instead integrate new information with knowledge we already possess. Our best learning occurs when new material is readily connected with what is often 'complex' and multiple link of association".

"Cognitive psychology suggests that a mental model consist of two major components: knowledge structure and the processes of using this knowledge" (Merrill, 2000). Inductive reasoning skill aids to figure out the pattern of the correct operations on how to use the knowledge structure whereas the associative learning skill assists the buildup and storage of the knowledge structure itself.

In order to assist the association processes during the student's learning, the instruction needs to assist the recall (revisit) of learned information, clearly show the relationships of concepts (new to existing), and facilitate new or

Table 6. Associative learning skill formalization.

Level	Path		Content		Info Resource	
	Number	Relevance	Amount	Concreteness	Structure	Number
Poor	+	+	\	\	+	+
Good	\-	-	\	\	\-	\

creative association/insight formation by providing information of related domain area. The associate learning skill is analyzed in the following with respect to learning process.

#### 10.1. When the Learner's Associative Learning Skill is Poor

The number of paths and the structure of the information should increase. More hints and information should help the learner to associate one concept to another. The number of information resources should increase. Different information resources (media) should provide different magnitude of understanding of the same concept. The relevance of the paths should increase to prevent the learner from getting lost in the less-relevant information and create too many useless associations. The amount of information and the concreteness of the information do not need to change because there are no direct and apparent benefits associated.

#### 10.2. When the Learner's Associative Learning Skill is Good

The number of paths and the structure of the information should decrease so learners can navigate more freely and hence enhance the learning speed, and stimulated more associations. The relevance of the paths should decrease to enlarge the information space and hence the available knowledge. The amount of information, the concreteness of information, and the number of information resources do not need to change because there are no direct and apparent benefits associated.

The above discussion can be formalized as shown in Table 6.

### 11. EXPLORATION SPACE CONTROL AND VIRTUAL LEARNING ENVIRONMENTS

ESC theory inherits the strength of both adaptive navigation and adaptive content presentation. It is designed to be used in VLEs and, therefore, it encompasses the advantages offered by multimedia, hypermedia, and adaptive hypermedia. On the other hand, human's cognitive ability has equal emphasis

in the ESC theory, which is the basis for determining different levels of control in exploration process. The overall aim is to make the learning a satisfactory experience for students with varied cognitive abilities.

The formalization of ESC provides a practical way to design VLEs that inherit the benefits of ESC. But to be able to provide adequate adaptation, the VLE should be able to infer the current state of student's attributes and preferences. This creates a need for a student model that is based on the same principles as guided by the ESC. Student model is regarded as an essential component in any adaptive systems and has attracted intensive research focuses in the last few decades (extensive review of student models have been continuously published in the *Journal of Artificial Intelligence in Education*).

But the existing student modeling techniques do not do adequate justice with the inherent exploratory and constructivist nature of the VLEs and rather hinder in the learning process. Constructivism postulates that the knowledge is formed subjectively from the student's previous experience. Knowledge exists only inside human mind (Duffy & Jonassen, 1991) and the existence is unique to every individual. Furthermore, "constructivism says that domain knowledge should not be decomposed and presented to the student in parts; instead, learning should take place in realistic settings with all the ambiguities and extraneous details that entails" (Mayo, 2001). Therefore, the students would be able to better apply their knowledge in real-world context.

Based on the argument that the cognitive structure of every student is unique, it becomes futile to represent the student in any pre-defined structure as current student modeling approaches attempt to do. Does it mean that the efforts on student modeling are pointless? Does or can student modeling or adaptivity fit into the constructivist's paradigm of learning? Mayo (2001) gave an alternative view by pointing out:

1. Novice students often lack the meta-cognitive skill required to explore in a constructivist learning environment. Getting lost in the learning environment is often the cause of disengagement or lost of motivation (Bouillion & Gomez, 2001; Kashihara et al., 2000).
2. New students to a domain require direct guidance, as they have no previous experiences to build on. Advocates of transitory model suggest that the students should initially be taught in objectivist approach before becoming intermediate level for which the constructivist approach could be applied.
3. The adaptivity can be directed to support constructivist principles.

In constructivism, good problems are those, which are able to stimulate the exploration and the reflection necessary for knowledge construction (Brooks & Brooks, 1993). Efficient exploration is one of the key skills required in order to be able to actively engage in a constructivist learning environment. When the inability to demonstrate exploratory skill is detected, the student model ought to advice the VLE to take responsive actions to support the skill.

Modeling of individual differences in cognitive processing is one of the areas where the full potential of student modeling has not yet been achieved (Lovett et al., 2000). This idea may be novel in its wider ambitions, but several HCI researchers have noted its potential (Barnard & May, 1993; Green, 1994; Tweedie & Barnard, 1992). We, therefore, introduce CTM, based on the CTs discussed above.

## 12. COGNITIVE TRAIT MODEL

It is the increasing need to model student's cognitive abilities/traits that gives rise to a completely new approach of student modeling: the CTM. The ultimate aim of this new approach is to provide system adaptivity to support cognitive processing of students.

CTM enables the learning environment to provide fine-grained adaptivity that takes each individual student's cognitive abilities and resources into account. Traits are relatively stable over a long period of time and persistent across different domains. This new approach to model CTs raises the question: How can a CT be modeled? This issue can be clarified by comparing the CTM approach to the existing student modeling approaches.

Most of the existing student modeling approaches try to represent

- the students' competence state (conceptual and procedural knowledge) by analyzing how much content has been read by tracing the path followed by the student, and how much is learned by analyzing the solutions to questions (state models: Smith, 1998; Staff, 2001; skill tracing: Han et al., 2001);
- the students' understanding of the procedures for solving a task by comparing the problem-solving scenario with the expert's model (constraint-based mode: Martin, 1999; problem-solving state tracing: Stankov, 1996); and
- the students' approach of the procedures for solving a task by analyzing the processes/steps that they have taken (process model: El-Sheikh & Sticklen, 1998).

The existing student models can be generalized as representations of the results of operations by the students (such as reading a page or answering a question) carried out on the presented domain content. Whereas, in order to model CT, students' behaviors have to be recorded at a granularity level, which is descriptive enough that the necessary aspects of the student attributes can be inferred by the VLE.

In order to record and describe students' behaviors, a logging mechanism and a formal language is required. This language must be able to describe which task student had done, and the actions taken to carry out the task. The logging mechanism should also allow those descriptions to be stored

and retrieved for future analysis. The granularity of behavior can range from “Chapter one completed” to “Mouse clicked on link A”, and the choice depends on the level of behavior useful enough for pedagogical consideration. Goals, Operators, Methods, and Selection Rules (GOMS) (Kieras, 1996), a form of engineering model for user interface design, is a suitable approach for this purpose. NGOMSL, natural GOMS language, provides a structured natural language format for the goal hierarchy and selection rules (Richter, 1997). NGOMSL can explicitly log every method the student had executed. Finer-grained information of the student behaviors, for example steps, can be derived from the logged method. Execution time is recorded as time-stamp for entries in the log. Thus, those properties and ability of NGOMSL make it very suitable for VLEs that require fine-grained student modeling (Kieras, 1996).

The purpose of CTM is not to replace performance-based student models but to complement. Student performance model records dynamic student domain-specific data while CTM stores those students’ attributes (could be multidimensional or stochastic) that are relatively persistent over time and across domains.

### 13. ARCHITECTURE TO INCORPORATE CTM

In order to maintain the logical modularity, a multicomponent architecture of student model is used (Figure 1). The student performance model can be either a state model or a process model depending on the nature of the domain (process model is more suitable for procedural knowledge as it models the process of a problem-solving procedure).

All student actions are recorded in the student behavior history. Actions are recorded according to the desired granularity. In order to provide fine-grained tuning, recording of actions has to be performed at a primitive level. Trait analyzer then takes the logged information in the behavior history and performs analysis. Systems with similar granularity levels include the READY (Jameson et al., 1999) that tries to model users’ time limitation and distraction from the system–user dialog, and Meyer et al.’s (1997) that attempts to find out the age group differences in World Wide Web (WWW) navigation, logs all navigational movement between and within pages, and asks participants to think aloud while searching.

The role of the interaction modeler is to represent and interpret the student–system interaction from the inputs of the interface module. The result of the interaction modeler is recorded in the interaction model. The main task of the interaction modeler is to recognize different interaction states and various interaction tasks the student is currently engaged in. Interaction states are the phases of the learning process. Interaction state could include knowledge acquisition state and knowledge application state. Pedagogical criteria are evaluated by the patterns of the state shift (e.g., from knowledge acquisition to

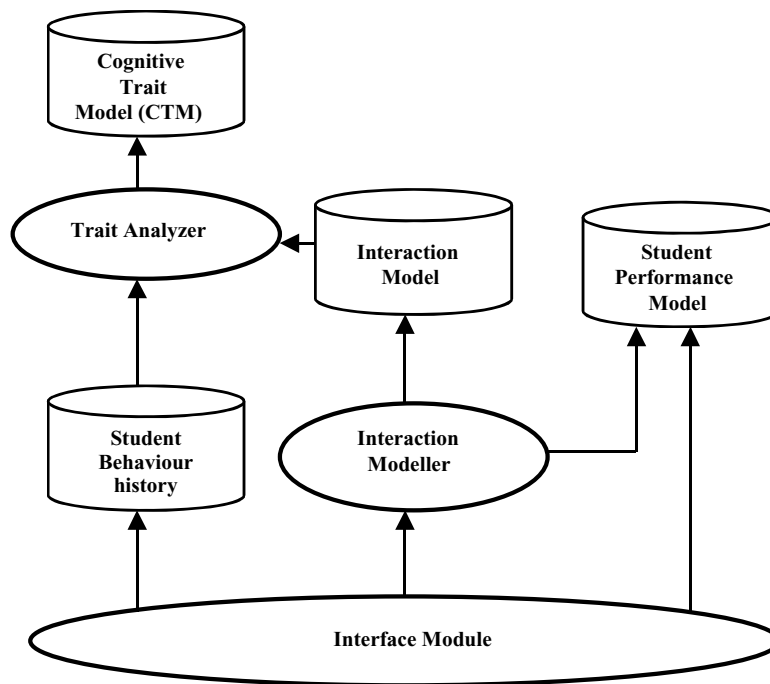

Figure 1. Architecture of cognitive trait model.

application). For example, the criteria could specify that only when a student is able to solve problem A, the knowledge application of concept A can be proved successfully, and then the VLE can assume that the concept A is learned. On the other hand, knowledge acquisition state can be optional due to the background knowledge of the student. The states also serve as the indicator of what the student is suppose to be doing at a particular moment. For example, while the state tells that student A has finished knowledge acquisition state on a concept C, and should now be at the application state of C (could be an exercise related to C), but actually the student A may have returned to an interaction task which has already been carried out in the knowledge acquisition state.

Interaction tasks can be further decomposed into interaction operations and interaction targets. Interaction targets represent the domain content; they could be concepts, examples, exercises, or topics. Interaction operations are those actions that are applied on the interaction target. An example of an interaction task is “Answering question A”, where “Answering” is the interaction operation and “Question A” is the interaction target. Together, the interaction state and the interaction task form an interaction entry, which is a unique identifier in the interaction model.

Every student action recorded in the behavior history has one interaction entry. The interaction entry serves as an indicator of the goal/motivation of why the student performs a particular action. Therefore, the purpose to include an

interaction modeler is twofold: to model student performance and to provide indication of the motive for student actions. The nature of the information gathered by the interaction modeler, i.e., the states and the tasks, makes it an essential part of the student performance model that belongs to any one of the state models. On the other hand, every interaction entry serves as the source of explanation for the rationale of corresponding student actions/behaviors.

The trait analyzer is the main component to determine the input into the CTM from analysis of student behaviors. The trait analyzer carries out the task of cognitive analysis of a list of actions. The motivation of those actions can be inferred from the interaction entry, but the cognitive analysis has to be backed up by thorough research in the theories of human cognition. One of the cognitive ability, *working memory*, is accounted as a necessary requirement for a vast number of human activities (Henry, 2001; Calvo, 2001). It is one of the CTs that are part of CTM. We shall now discuss what factors are used to analyze the working memory and the rationale behind selecting those factors.

#### 14. ANALYSIS OF WORKING MEMORY

In earlier times, working memory has also been referred as short-term memory. Richards-Ward (1996) named it the short-term store (STS) to emphasize its role of temporally storage of recently perceived information. STS allows us to keep active a limited amount of information (roughly  $7 \pm 2$  items) for a brief period of time (Miller, 1956). The term working memory refers to the same construct as the STS does, in terms of the capacity of transient storage and, in addition, it also denotes the concept that cognitive processes take place in working memory.

Baddeley (1992) provided decomposition of the working memory into several components. The structure of working memory was described as a control-slave system comprised of the central executive (controlling component), the phonological loop (slave component for verbal information), and a visual-spatial sketch pad (slave component for graphical information). The Central Executive takes the role to control, monitor the output of the two slave systems, and select what is relevant for potential processing (Richards-Ward, 1996).

While Baddeley (1992) defined working memory structurally, others defined it as a process (Salthouse et al., 1989). Salthouse et al. (1989) proposed that working memory consist of (1) a storage capacity sensitive to the number of items presented and (2) an operational capacity sensitive to the number of operations performed on items. They found that young adults have higher operational capacity than older adults especially among the highly capable participants. Little or no difference on the storage capacity was reported across the age differences. Therefore, they concluded, at that time, that it was the operational capacity that causes age-related working memory decline. A further



study of the operational efficiency of working memory showed that it was not the operational capacity (number of operations allowed) contributing the most to the efficiency of working memory, but it was actually the speed of execution (e.g., comparison speed) that determined the performance of the overall system of working memory (Salthouse & Babcock, 1991). Even though, these two different points of view do not agree on a common structure of working memory, they both agree that working memory consists of both storage and operational sub-systems (Richards-Ward, 1996).

Several other studies have shown that age-related performance of young children and old adults compared with young adults can be characterized by the inability to retain information in working memory while simultaneously processing other information (Case, 1995). Deficiencies in working memory capacity result in different performances on a variety of tasks. Examples of tasks affected could include natural language use (comprehension, production, etc.), recognition of declarative memory, and skills acquisition (Byrne, 1996).

An empirical study by Huai (2000) showed that students with holistic learning style have a significantly smaller short-term working memory but have remarkably higher learning effect in the long run, whereas the students with serial learning style (highly capable to follow and remember sequentially fixed information) have better short-term working memory capacity but poorer learning result in the long run. This shows that the intricate relationship between humans' in-built abilities and how different learning styles are adopted to circumvent any deficiencies in those abilities. The navigational strategies adopted by serial learners are linear whereas holists sometimes do better by jumping directly to complex concepts (Felder, 1988).

The discussion so far has covered various aspects of working memory from the perspective of its definition and structure. From this discussion, various implications for cognitive analysis can be summarized as follows:

- Working memory temporarily stores material for recall for only a few seconds (Atkinson & Shiffrin, 1968; Byrne, 1996). Constant revisits to the learned materials at very short intervals indicate sign of low working memory capacity.
- As new items enter into working memory, other items become harder to access, and the cognitive system becomes less efficient (Baddeley, 1986; Byrne, 1996). This is called the displacement or interference. Less tolerance of displacement or interference indicates sign of low working memory capacity. Tolerance level can be demonstrated as the ability to learn other "side information", while not get distracted from the main theme. Side information is usually represented by excursions using excursion links (Kinshuk et al., 1999), tips, warning, cases, and so forth.
- Working memory has a limited capacity for storage (Miller, 1956; Salthouse et al., 1989). Constant short-distant reversed navigation indicates sign of low working memory.

- Working memory has a limited capacity for operation (Miller, 1956; Salthouse et al., 1989). Ability to perform tasks simultaneously indicates sign of high working memory capacity.
- Unlike the long-term memory, in which interference is ascribed the main cause of retrieval failure (Reisberg, 1997), simple execution speed (e.g., comparison) greatly determines the overall performance of working memory due to the characteristic of rapid decay (Richards-Ward, 1996). Higher comparison speed implies higher working memory capacity. The amount of time spent on comparison tasks provides indications for working memory capacity.
- Working memory is the intermediate storage to and from long-term memory (Atkinson & Shiffrin, 1968). The ability and speed to retrieve knowledge from the long-term memory provide signs for working memory capacity.
- During a long sequence of calculation or procedure, frequently missing steps or lost components indicate signs of low working memory (Campbell & Charness, 1990).
- Working memory is subjective to vary with age (Kausler, 1991; Salthouse, & Babcock, 1991). Younger age indicates sign for higher working memory.
- Inferential ability is dependent on working memory capacity (Richards-Ward, 1996). Inferential ability to understand high-demand text, or complex concepts for which the inferential ability takes the role of bridging the necessary semantic together and thus called bridging inferential (Calvo, 2001). Greater number of inter-navigation between the current concept and its sub-concepts provides indication of the lack of bridging inferential ability and thus lower working memory capacity.

## 15. IMPLEMENTATION OF CTM

A prototype web-based tutorial has been developed in the domain of recursion in computer programming to demonstrate the applicability of CTM.

In this prototype, a simple tutorial on the use of recursion in computer programming language is created. The examples and listing in the tutorial is in C language but any other programming language that supports recursion can use this approach. The main focus of this tutorial is on the idea of recursion, principles of writing recursive functions, and good programming practice.

The tutorial is completely web compatible. It consists of 22 nodes (Figure 2) each of which can roughly approximate to single web page except the recursion nodes, which bring the learners to other websites of related topic. This tutorial has 61 relations which are mainly of six types: IsBasisFor, IsBasedOn, HasPart, IsPartOf, ExcursionTo, and IsExcursionOf.

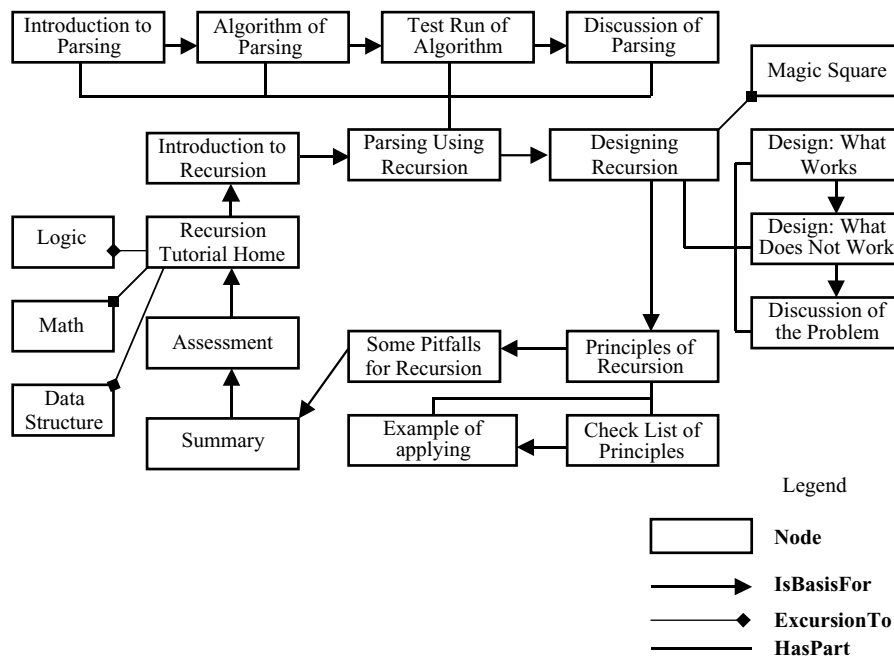

Figure 2. Structure of the domain: tutorial of recursion.

The logical start of the tutorial is Recursion Tutorial Home node, but it is not a strict limit. The learners can go through the tutorial in a linear fashion by following the IsBasisFor and HasPart relations, or they can explore more examples and different perspectives about recursive programming by the ExcursionTo relations. After the assessment page, the learner is automatically brought back to the Tutorial Home. This provides a means in this prototype to experiment with sessions of different length. On the top of every page, there is a navigation bar in which the “next” links to the pre-determined page and in the bottom of every page there is a view report link. There are sometimes excursions available for a particular node, which bring the learners to other websites of related concepts. For example, excursions available in the *Introduction to Recursion* (Figure 3) are recursions to *Data Structure and Algorithm, Logic, and Mathematics*.

Next, Figure 4 shows the excursion to the *Mathematics*. Recursions take the learner away from the host, called main host, where the tutorial is located, and thus learner’s activities in the excursion website are untrackable. However, the activations of the relations ExcursionTo, and IsExcursionOf are still in the control of main host and therefore these activations can be recorded in the student behavior history (Figure 1).

When the learner clicks the Next button in the *Introduction to Recursion*, the tutorial brings the student to the *Introduction to Parsing* (Figure 5). Please

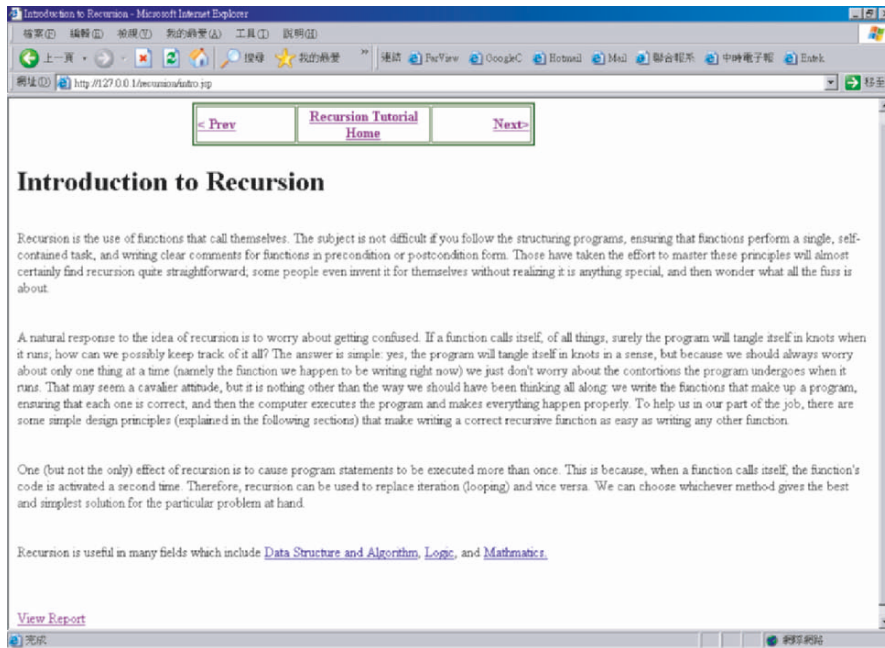

Figure 3. Introduction to recursion.

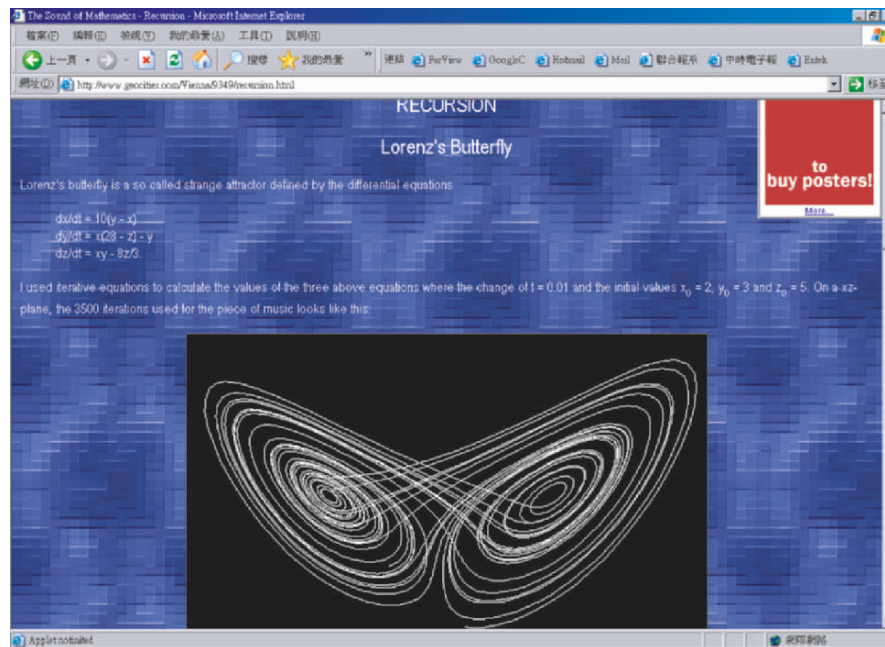

Figure 4. Excursion to the mathematics node.

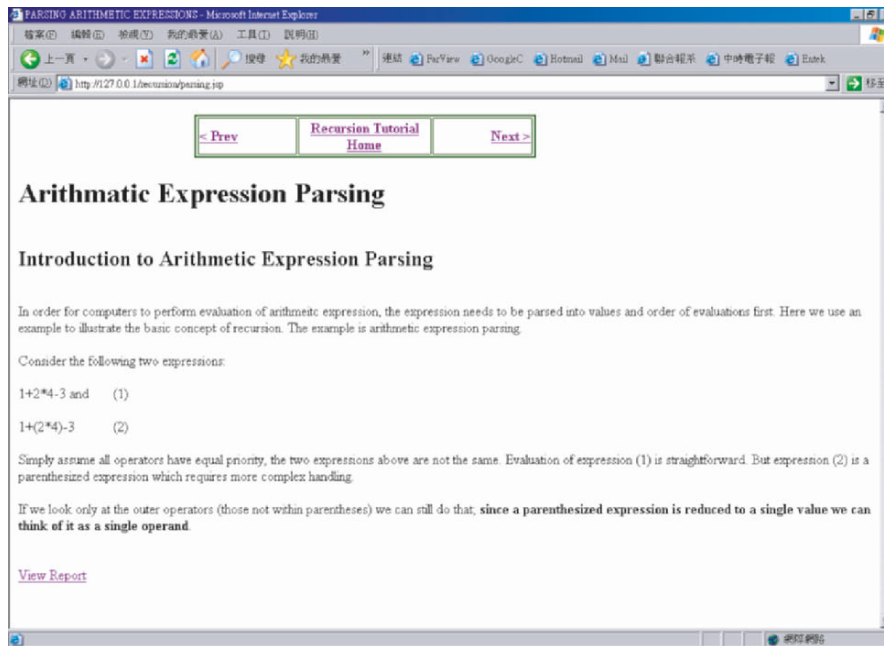

Figure 5. Page for the introduction to the arithmetic expression parsing.

note that in Figure 2, the *Introduction to Recursion* has an *IsBasisFor* relation to the *Introduction to Parsing*, which is actually a logical learning object only. Logical learning objects are used to relate learning objects semantically, but not necessarily physically (by hyperlinks). A single action of transferring from *Introduction to Recursion* to *Parsing Using Recursion* actually activates two relations: an *IsBasisFor* relation (from *Introduction to Recursion* to *Parsing Using Recursion*) and a *HasPart* relation (from *Parsing Using Recursion* to *Introduction to Recursion*).

#### 16. EXAMPLE OF TRAIT ANALYSIS

Learners' actions of navigation are recorded in student behavior history. An exemplary trait analysis is demonstrated below. For example, a learner performed the sequence of navigation shown in Figure 6.

The relations recorded in those navigation are sequentially: *ExcursionTo*, *IsExcursionOf*, *IsBasisFor*, *HasPart*, *IsBasisFor*, and *IsBasedOn*. Those relations can only construct three types of implementations, i.e., navigational linearity, reverse navigation, and excursions. Those implementation patterns are discussed next.

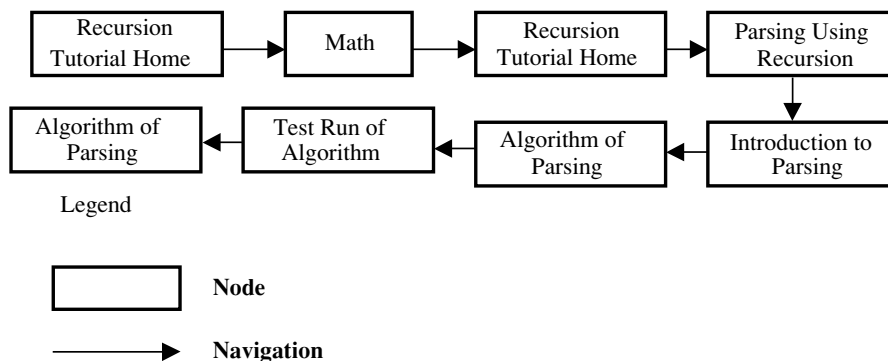

Figure 6. An exemplary session.

### 16.1. Navigational Linearity

Navigational linearity implies that the learner is traversing the learning space in a way that was originally designed to be the main route. In many learning environments, it is the Next button that guides the learner on the intended route designed by the curriculum designers. In terms of link type, it is the direct successor link, and in terms of relations, it belongs to the IsBasisFor relation, and IsBasedOn indicates the relation with opposite direction to the direct successor link.

For the number of relations, refer to Figure 2. In the navigational sequence in Figure 6, the total number of excursions is three, and the number of excursions visited is one. The number of total IsBasisFor relations is four whereas the number of relations visited is equal to one.

### 16.2. Reverse Navigation

Reverse navigation includes reverse navigation and revisit already learned materials, because both have some degree of similarity.

Constant reverse navigation (Figure 7A) indicates that a learner goes back to learned material often. In many systems, it may be most obviously represented by the “Back” button. In a general sense, the course of frequent reverse navigation is caused by an insufficient capacity of the working memory to hold on that material that has just been accessed. Frequent revisits to already learned material (Figure 7B) may seem different from the pattern shown in Figure 7A but the pattern “frequent revisits to already learned material” could be a generalization of the pattern “frequent reverse navigation”.

In terms of working memory capacity, the causes for these two patterns are qualitatively the same. This is another reason that these two different patterns are treated as a single pattern “reverse navigation”.

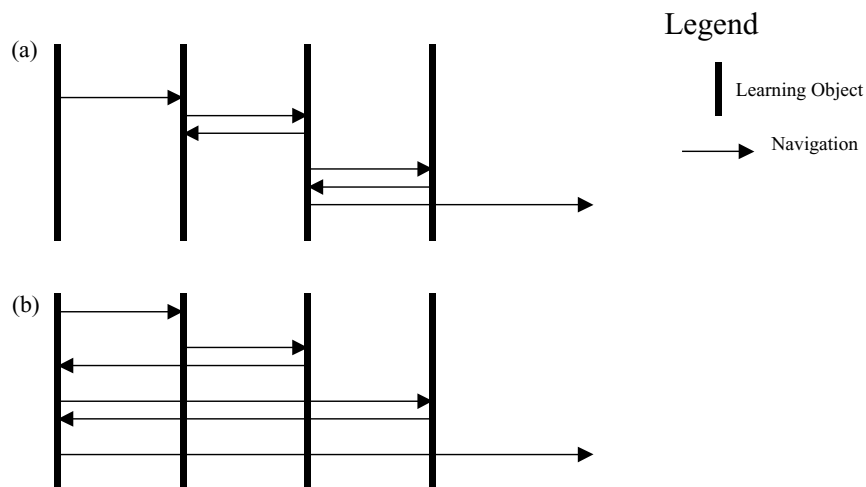

Figure 7. (a) Constant reverse navigation and (b) Frequently revisit learned material.

In the navigation in Figure 6, it is obvious that the learner indeed performed reverse navigation from Test Run of Algorithm to Algorithm of Parsing.

### 16.3. Excursions

Learners can take excursions to obtain side information during a course of learning. Excursions bring less-relevant information to the student, and therefore broaden the learning experience, and create opportunities for accidental learning. But excursions also bring distractions to the learner. Any distraction would affect the processing and the working of the working memory, which has limited capacity by its nature (Reisberg, 1997).

In the navigation in Figure 6, the learners take excursion to the *Mathematics* website.

### 16.4. Sample Results

Figure 8 shows the page summarizing the result of an example analysis. The HWMC represents “High Working Memory Capacity” and LWMC indicates “Low Working Memory Capacity”. The “View Report” link is made available on every page of the tutorial in order to facilitate the ease of examining the status of the CTM.

## 17. DISCUSSION AND FUTURE WORK

To summarize the CTM approach of student modeling, it can be divided into two major phases: modeling the interaction and cognitive trait analysis.

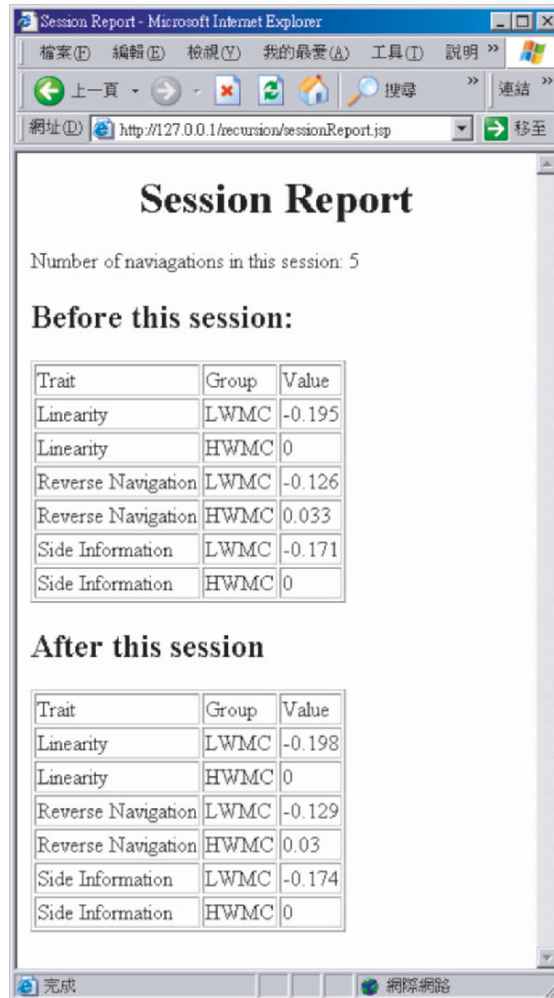

Figure 8. Page for the result of the analysis.

In order to model the students' interactions with the VLE, detailed log has to be maintained. NGOMSL (Richter, 1997), the Natural GOMS Language provides the structural and the formal representation of the student behaviors in the log. In order to cater for the necessary qualitative analysis, the trait analyzer adopts the strategy that incrementally makes use of sparse evidence, integration of unreliable evidence from a diverse set of observations, and explicit reasoning about the ways in which the user's resource limitations change during interaction (as suggested by Jameson et al., 1990). The analyzer can then perform inferences on students' CTs and store the result in the CTM. The CTM can assist instructional decisions the VLE has to make in conjunction with any competence state models.



Quinton (2001) pointed out, in the discussion of meaningful learning, that learning should be “truly holistic, flexible, dynamic, multidirectional, and adaptable”, and the role of a learning theory should accommodate those properties in order to provide a guide to comprehensive learning by customizable education in a technologically focused future. The strength of adaptivity in education does not just lie in its novelty; experimental studies have substantially proven its ability to enhance learning speed, memorization and comprehension; its customizable property makes it a preferable choice for the life-long learning.

This chapter provided a very broad outline on the issues of user adaptation in VLEs. The discussion of adaptive navigational support and adaptive content presentation demonstrates the state-of-the-art adaptive techniques used in most of the current adaptive VLEs and the lack of theoretical background. This is perhaps the major reason why most of the existing adaptive techniques do not identify with each other. The ESC approach attempts to address this issue (Kashihara et al., 2000). The ESC formalization serves as a tactical plan on how the strategies suggested by the theories can be carried out.

As most of the current student models are only competence-oriented, the adaptation can only be provided in a performance-based manner. This means that the VLEs adapt themselves in those areas where the student’s performance is identified (or predicted) to be sub-optimal.

CTM attempts to tackle this problem and provides a supplementary module to any existing VLEs that wish to support adaptation also at the cognitive level. CTM can be integrated in existing framework of VLEs by the addition of interaction modeling and trait analyzing facilities (Figure 1). The existing competence model can be used for performance-based adaptivity while CTM can supply the adaptivity that addresses the differences of each individual’s cognitive abilities.

Another issue for CTM is whether to allow the students to view and modify their own CTM. From the viewpoint of the information processing model of memory (Brown, 2001), information is processed in three “boxes”: sensory memory, working memory, and long-term memory among which working memory is the arena where the conscious thought operates. This reveals the point that one’s conscious thought is not conscious about his/her own working memory, and therefore allowing the students to modify the values of their working memory is not appropriate. Other CTs may have same or different property as working memory in this regard, and there could also be great educational values for allowing students’ conscious modifications on their CTM. This is an interesting future research opportunity.

## REFERENCES

Anderson, J. (1983). *The Architecture of Cognition*. Cambridge, MA: Harvard University Press.

- Atkinson, R. C. & Shiffrin, R. M. (1968). Human memory: a proposed system and its control processes. In: Spence, K. W. and Spence, J. T. (Eds.) *The Psychology of Learning and Motivation: Advances in Research and Theory*, Vol. 2. New York: Academic Press.
- Baddeley, A. D. (1986). *Working Memory*. Oxford: Oxford University Press.
- Baddeley, A. D. (1992). Working memory. *Science* 255, 556–559.
- Barnard, P. J. & May, J. (1993). Cognitive modelling for user requirements. In: Byerley, P. F., Barnard, P. J., and May, J. (Eds.) *Computers, Communication and Usability: Design Issues, Research and Methods for Integrated Services*. Amsterdam: Elsevier.
- Bell, T. (2000). Extensive reading: speed and comprehension. *The Reading Matrix* 1(1), np.
- Bouillion, L. M. & Gomez, L. M. (2001). The case for considering culture entailments and genres of attachment in the design of educational technology. In: Forbus, K. D. and Feltovich, P. J. (Eds.) *Smart Machines in Education*. Menlo Park, California: AAAI Press/MIT Press, 331–348.
- Brooks, J. G. & Brooks, M. G. (1993). *In Search of Understanding: The Case for Constructivist Classrooms*. Alexandria, VA: American Society for Curriculum Development.
- Brown, B. L. (2001). Dr. Brown's psychology 1501 home page. Retrieved July 27, 2003 from: <http://www.gpc.peachnet.edu/~bbrown/psyc1501/index.htm>.
- Brown, P. & Hirst, S. B. (1983). Writing reading courses: the interrelationship of theory and practice. In: Brumfit, C. J. (Ed.) *Language Teaching Projects for the Third World. ELT Documents*, Vol. 116. England: British Council English Teaching Information Centre.
- Bruner, J. (1973). *Going Beyond the Information Given*. New York: Norton.
- Brusilovsky, P., Eklund, J., & Schwarz, E. (1998). Web-based education for all: a tool for developing adaptive courseware. *Computer Networks and ISDN Systems* 30(1–7), 291–300.
- Byrne, M. (1996). A computational theory of working memory. Retrieved July 27, 2003 from: <http://www.acm.org/sigchi/chi96/proceedings/doctoral/Byrne/mdb.txt.htm>.
- Calvo, M. G. (2001). Working memory and inferences: evidence from eye fixations during reading. In: Gathercole, S. E. (Ed.) *Short-Term and Working Memory*. East Sussex, UK: Psychology Press Ltd.
- Campbell, J. I. & Charness, N. (1990). Age-related declines in working memory skills: evidence from a complex calculation task. Special section: cognitive training in later adulthood. *Developmental Psychology* 26, 879–888.
- Carroll, J., Mack, R., Lewis, C., Grischkowsky, N., & Robertson, S. (1985). Exploring a word processor. *Journal of Human-Computer Interaction* 1, 283–307.
- Case, R. (1995). Capacity-based explanations of working memory growth: a brief history and reevaluation. In: Weinert, F. E. and Schneider, W. (Eds.) *Memory Performance and Competencies: Issues in Growth and Development*. Mahwah, NJ: Erlbaum, 23–24.
- Craik, F. & Lockhart, R. (1972). Levels of processing: a framework for memory research. *Journal of Verbal Learning and Verbal Behavior* 11, 671–684.
- Cronbach, L. & Snow, R. (1989). Aptitude-treatment interaction as a framework for research on individual differences in learning. In: Ackerman, P., Sternberg, R. J., and Glaser, R. (Eds.) *Learning and Individual Differences*. New York: W. H. Freeman.
- De Bra, P., Brusilovsky, P., & Houben, G. J. (1999). Adaptive hypermedia: from systems to framework. *ACM Computing Surveys* 31(4). Retrieved July 27, 2003 from: <http://www.cs.brown.edu/memex/ACM-HypertextTestbed/papers/25.html>.
- Duffy, T. M. & Jonassen, D. H. (1991). New implications for instructional technology? *Educational Technology* 31(3), 7–12.
- El-Sheikh, E. & Sticklen, J. (1998). Using a functional approach to model learning environments. *Model Based Reasoning for Intelligent Education Environments Workshop, ECAI'98*, European Conference on Artificial Intelligence, Brighton, UK.
- Felder, R. M. (1988). Learning and teaching styles in engineering education. *Engineering Education* 78(7), 674–681.

- Forbus, K. D. & Feltovich, P. J. (2001). From this revolution to the next. In: Forbus, K. D. and Feltovich, P. J. (Eds.) *Smart Machines in Education*. Menlo Park, California: AAAI Press/MIT Press, 421–425.
- Gilbert, J. E. & Han, C. Y. (1999). Adapting instruction in search of a significant difference. *Journal of Network and Computer Applications* 22. Retrieved July 27, 2003 from: <http://www.cat.uc.edu/gilbert/arthur.pdf>.
- Green, A. J. K. (1994) An exploration of the relationships between task representations, knowledge structures and performance. *Interacting with Computers* 6, 61–85.
- Han, S. G., Yoon, J. S., & Jo, G. S. (2001). Case-based student model using knowledge markup language for intelligent e-learning systems. Retrieved July 27, 2003 from: [http://www.ifcomputer.com/inap/inap2001/program/inap\\_han.pdf](http://www.ifcomputer.com/inap/inap2001/program/inap_han.pdf).
- Heit, E. (2000). Properties of inductive reasoning. *Psychonomic Bulletin and Review*. Retrieved July 27, 2003 from: <http://www-psych.stanford.edu/~jbt/205/heit.pdf>.
- Henry, L. (2001). How does the severity of a learning disability affect working memory performance? In: Gathercole, S. E. (Ed.) *Short-Term and Working Memory*. East Sussex, UK: Psychology Press Ltd.
- Huai, H. (2000). Cognitive style and memory capacity: effects of concept mapping as a learning method. Doctoral Thesis, Twente University, The Netherlands.
- Jameson, A., Schlfer, R., Weis, T., & Weyrath, B. T. (1999). Making systems sensitive to the user's time and working memory constraints. Retrieved July 27, 2003 from: <http://www.iuiconf.org/99pdf/1999-001-0014.pdf>.
- Kashihara, A., Kinshuk, Oppermann, R., Rashev, R., & Simm, H. (2000). A cognitive load reduction approach to exploratory learning and its application to an interactive simulation-based learning system. *Journal of Educational Multimedia and Hypermedia* 9(3), 253–276.
- Kausler, D. H. (1991). *Experimental Psychology, Cognition, and Human Aging*, 2nd ed. New York: Springer-Verlag.
- Kay, J. & Kummerfeld, R. J. (1994). An individualised course for the C programming language. Retrieved July 27, 2003 from: <http://www.cs.usyd.edu.au/~bob/kay-kummerfeld.html>.
- Kearsley, G. (1998). Theory into practice (TIP) database. Retrieved July 27, 2003 from: <http://www.gwu.edu/~tip/index.html>.
- Kearsley, G. (2001). Explorations in learning and instruction: the theory into practice database. Retrieved July 27, 2003 from: <http://tip.psychology.org/scandura.html>.
- Kieras, D. (1996). A guide to GOMS model usability evaluation using NGOMSL. Retrieved July 27, 2003 from: <http://www.cosc.brocku.ca/~bockusd/3p94/kieras96guide.pdf>.
- Kinshuk, Oppermann, R., Patel, A., & Kashihara, A. (1999). Multiple representation approach in multimedia based intelligent educational systems. In: Lajpie, S. P. and Vivet, M. (Eds.) *Artificial Intelligence in Education*. Amsterdam: ISO Press, 259–266.
- Lin, T. (2002). Exploration space control formalisation. *Research Report*. Palmerston North, New Zealand: Massey University.
- Lovett, M. C., Daily, L. Z., & Reder, L. M. (2000). A source activation theory of working memory: cross-task prediction of performance in ACT-R\*. Retrieved July 27, 2003 from: <http://www.psy.cmu.edu/LAPS/pubs/Lovett00CogSysResearch2.pdf>.
- Martin, B. (1999). Constraint-based modeling: representing student knowledge. *New Zealand Journal of Computing* 7(2), 30–38.
- Mayo, M. J. (2001). Bayesian student modelling and decision-theoretic selection of tutorial actions in intelligent tutoring systems. Ph.D. Thesis. Retrieved July 27, 2003 from: [http://www.cosc.canterbury.ac.nz/research/reports/PhdTheses/2001/phd\\_0102.pdf](http://www.cosc.canterbury.ac.nz/research/reports/PhdTheses/2001/phd_0102.pdf).
- Merrill, M. D. (2000). Knowledge object and mental models. In: Kinshuk, J., Chris, T. O. (Eds.) *Proceeding of International Workshop on Advanced Learning Technologies: Advanced Learning Technology: Design and Development Issues: IWALT 2000*, Los Alamitos, U.S.A.: IEEE Computer Society, 244–246.

- Meyer, B., Sit, R. A., Spaulding, V. A., Mead, S. E., & Walker, N. (1997). Age Group Differences in World Wide Web Navigation. Retrieved July 27, 2003 from: <http://www.acm.org/sigchi/chi97/proceedings/short-talk/bm.htm>.
- Miller, G. (1956). The magic number seven, plus or minus two: some limit of our capacity for processing information. *Psychology Review* 63(2), 81–96.
- Pascoe, R. & Sallis, A. (1998). A pedagogical basis for adaptive WWW textbooks. *Proceeding of North American Web Developers Conference*. Retrieved July 27, 2003 from: <http://naweb.unb.ca/proceedings/1998/pascoe/pascoe.html>.
- Quinton, S. R. (2001). Meaningful learning in a complex information environment. In: Lee, C. H. (Ed.) *Enhancement of Quality Learning Through Information and Communication Technology (ICT): Proceedings of the ICCE International Conference on Computers in Education/SchoolNet2001*, Vol. 3. Seoul, Korea: Incheon National University of Education, 1326–1333.
- Reigeluth, C. (1992). Elaborating the elaboration theory. *Educational Technology Research and Development* 40(3), 80–86.
- Reisberg, D. (1997). *Cognition: Exploring the Science of Mind*. New York: W. W. Norton & Company.
- Richard-Ward, L. A. (1996). *Investigating the Relationship Between Two Approaches to Verbal Information Processing in Working Memory: An Examination of the Construct of Working Memory Coupled With an Investigation of Meta-Working Memory*. Palmerston North, New Zealand: Massey University.
- Richter, H. (1997). GOMS: CS6751 Final Part 1. Retrieved July 27, 2003 from: [http://www.cc.gatech.edu/classes/cs6751\\_97\\_fall/projects/!rodney/HAR\\_GOMS\\_Fall97.html](http://www.cc.gatech.edu/classes/cs6751_97_fall/projects/!rodney/HAR_GOMS_Fall97.html).
- Salthouse, T. A. & Babcock, R. (1991). Decomposing adult age differences in working memory. *Developmental Psychology* 27, 763–776.
- Salthouse, T. A., Mitcheel, D. R. D., Skovronek, E., & Babcock, R. L. (1989). Effects of adult age and working memory on reasoning abilities. *Journal of Experimental Psychology: Learning, Memory, and Cognition* 15, 507–516.
- Sampson D., Karagiannidis C., & Kinshuk (2002). Personalised learning: educational, technological and standardisation perspective. *Interactive Educational Multimedia* 4, 24–39.
- Scandura, J. M. (1973). *Structural Learning I: Theory and Research*. London: Gordon & Breach.
- Smith, S. (1998). Intelligent Tutoring Systems—My Personal Notes on this Topic. Retrieved July 27, 2003 from: <http://www.cs.mdx.ac.uk/staffpages/serengul/>.
- Staff, C. (2001). HyperContext: a framework for adaptive and adaptable hypertext. Ph.D. Thesis, University of Sussex, Sussex, U.K.
- Stankov, S. (1996). Student model developing for intelligent tutoring systems. *International Journal for Engineering Modelling* 9(1–4), 35–41.
- Tweedie, L. & Barnard, P. J. (1992). The interactive talk: a new tool for presenting complex theory. *Psychology Software News* 3, 43–45.
- William, M. K. (2001). Deductive and Inductive Thinking. Retrieved July 27, 2003 from: <http://trochim.human.cornell.edu/kb/dedind.htm>.

## Chapter 17: Collaborative Text-Based Virtual Learning Environments\*

RHONNA J. ROBBINS-SPONAAS<sup>†</sup> AND JASON NOLAN<sup>‡</sup>

<sup>†</sup>*Department of English, The Florida State University*

<sup>‡</sup>*School of Early Childhood Education, Ryerson University*

MOOs are text-based online environments that allow users to create representations of people, places, and things and share them with others (Nolan, 2001). A MOO is a collaborative space where people come together for communal purposes. They construct the MOO-space according to agreed upon criteria. They can create their own towns, buildings, rooms, objects, and personal avatars and then interact with others in these created spaces. The spaces can be institutional—like a school or a classroom—or they can be literary, like the topology of a novel. Or they can be chaotic, like a frat house. Each MOO has its own personality, characteristics, special features, and purpose that create cohesion and community within its boundaries.

MOOs are collaborative online virtual environments that go worlds beyond the concept of a chat room, online game, or a simulation. A simple way to visualize a MOO is to think of a chat room, then add a room description so the chatters have some idea of a place, perhaps graphics, a character description for each user, objects that the participants can pick up, handle, and manipulate. Allow the participants the ability to create their own objects or object behaviors (e.g., an object designed as a dog may bark at irregular intervals), or to work together to create as many rooms as they would like and link them all together to create a house, office building, or village. Throw in the potential for HTML and multimedia content and tools, and you will begin to have the idea. Unlike online role-playing games (RPGs and MRPGs), there is no inherent restriction or limitation as to what can be created or what object behaviors can be initiated or how they may be modified.

MOOs are generally perceived as being a new and breaking technology, and, perhaps in a biological evolutionary scheme of things, they are. In the fast-paced world of information technology, however, MOOs and their MUD predecessors are rather like the modern-day shark—they are constantly redefining themselves into a more effective species, but they have been around for the data equivalent of eons. Unlike the immediately recognizable silhouette

\* An earlier version of this chapter was published as Robbins-Sponaas, R. and Nolan, J. (2005). MOOs: polysynchronous collaborative virtual environments. In: Zemliansky, P. and St. Amant, K. (Eds.) *Internet-Based Workplace Communications: Industry and Academic Perspectives*. Hershey, PA: Idea Group, Inc.

of the shark, however, MOOs have inadvertently maintained such a modest profile that even within the communities which most use them, the technology is still relatively unknown and boasts virtually no recognition value with the general public. While that condition is changing with the advent of more sophisticated MOO technologies and interfaces, blank looks and glazed expressions at the sheer mention of MOO and MOOing are still the general rule rather than the exception.

In fact, MOOs could be said to suffer from dual difficulties. The opportunities they afford for online learning, in a conceptual and practical sense, outstrip anything presently available; they are just too much a part of the cutting edge of both learning and technology. Conversely, much of the code that makes up the bulk of MOOs—even the fancy GUI, web-based MOOs—is moribund and requires significant redesign and coding so that its connection to the contemporary internet is more than jury-rigged patches. Nevertheless, even with these “patches,” MOOs currently offer more opportunities than most other tools presently in use. Despite the fact that MOOs offer opportunities currently impossible in any other actively developed online communications environment, they have remained largely the purview of hackers, coders, and academics for a number of reasons, none of which preclude their potential value in mainstream academic and commercial environments. Rather, they offer a potential pathway for collaborative virtual learning environments (CVEs) to reach the promise only hinted at in today’s offerings.

MOOs predate the onslaught of interest in the internet brought about by the popularity of the World Wide Web in 1994 by a number of years. Organizations such as Xerox Parc, AT&T Research Labs, and NASA’s Jet Propulsion Labs (JPL) have devoted resources to exploring the possibilities that MOOs afford, and many commercial ventures, such as PlaceWare (now known as Microsoft Live Meeting) and Diversity University have developed as offshoots of MOO-based technologies. Organizations and institutions such as the University of Toronto’s Knowledge Media Design Institute, MIT’s Media Lab, SRI International, and the University of Toledo’s Department of Health and Safety have hosted MOO-based projects, with research sponsored by the U.S. Department of Defense, SUN, the NSF, Industry Canada, and NASA, among others.

The first question that comes up when discussing MOOs is, of course, “What the heck is a MOO anyway?” MOOs are collaborative virtual environments that are generally hosted on the internet and are accessible via a variety of programs that range from telnet to web browser. Their ancestors, Multi-User Dungeons (MUDs), were—as the name suggests—originally widely used by the gaming community (Aarseth, 1997; Bartle, 1990; Curtis, 1992; Curtis & Nichols, 1993; Rheingold, 1993). As technology redefined itself and grew increasingly more sophisticated, the environments gained the opportunity to be object-oriented; that is, they could be generated by creating a series of inter-relating but relatively self-contained segments of code that in turn

served as rooms, containers, features, interactive objects, player characters, and so on. The development of an integrated object-oriented programming language (the MOO language) within the MOO environment is one of the key differences between MOOs and other virtual environments. There is a certain amount of diversity in the types of MOOs currently in operation, but at the time of this writing, they tend to fall within three different categories: pure text, web-based, and enCore-based. There is an ongoing debate between the two MOO camps—webbed MOOs and text-based MOOs—about which is the better forum. Users of web-based or GUI MOOs often find text-based MOOs cumbersome and awkward, whereas users of text MOOs tend to find webbed MOOs cluttered and distracting. Both styles of MOOs have their particular advantages. For a beginning MOOer, the simple reality is that a GUI'd MOO is easier to learn; MOOing becomes much less intimidating when a user is able to utilize existing skills or find something familiar (surfing the 'net and web pages) on which to base her experience. Text MOOs, on the other hand, are exemplary for pure rhetoric discussion and exploration since the only available input is via the text under examination. The real issue, however, is how well each environment is implemented. For instance, MOOcanada has a very sophisticated text-only interface—MOOzilla—that is more interactive and dynamic than many GUI-based interfaces.

Pure-text MOOs are precisely what one may expect: they are MOOs that operate in a pure text environment. The user (player) must type all communications, commands, and actions, and all object and environment clues are portrayed entirely in text. There are no visuals to speak of; everything—objects, events, and other players—is portrayed and all actions are performed through the written word. From a creative perspective, the success of such environments often depends heavily on the developer's ability to use language in such a way that it is both concise and heavily visual; the more the user is able to form a concrete picture of the space and events, the stronger her experience will naturally be. On a practical level, nothing more than a bare-bones description or contextualization is necessary for the environment to function on the most basic of levels. There are a number of available software clients for both the PC and Macintosh platforms in order to avoid the ugliness of Telnet (e.g., zMUD, gMUD, WinMoose, MacMoose), but the operations and appearances are very much the same: one functions in a flat text environment only through the power of the typed command. In 2004, one of the strongest and most popular educational MOOs—Tari Lin Fanderclai's Connections MOO, operated out of the University of Florida—was laid to rest. While MOOs do have a definite life cycle, the loss of this particular MOO suggests that there is a growing turn away from pure-text MOOs for the general academic environment. Damningly, part of the reason for that turning away from text-based MOOs may be the heavier need for proper orientation, training, and support—and the decreasing availability of time or resources for those very things in academic lives that are growing increasingly more stressed and pressured. As

we will discuss shortly, running a MOO can be an exhausting proposition, and the burnout rate for owners and managers with no support system is phenomenally high. The increased simplicity of use GUI'd MOOs offer is most certainly not the only reason for the reduction in text-based MOOs.

As web browsers gained respect—and sophistication and power—an increasing number of MOOs began developing their own web-based graphic user interfaces, most often relying on Javascript and HTML in order to embed a Java Applet right into the web page that emulates the functions of a Telnet client. In these instances, the user accesses the MOO through a browser (typically Netscape/Mozilla or Internet Explorer) the same way she would access any other web page. The screen is traditionally divided into at least two parts: one segment, the Java Applet, contains all the text descriptions, conversations, events, messages, etc., while the other contains icons and images, many of which will be interactive and function as any normal web page. In these environments, a user will still be required to perform most actions by using a typed command, but there is an increased flexibility in how information is presented and accessed. She may, for instance, be able to click on an exit icon and move to another room rather than type the text command for the same action, or click on an icon of a bulletin board to see a welcome message. Because these web-based MOOs tend to be individually designed and built and are heavily dependent upon their owner's programming and coding abilities—and access to outside development resources—they run the gamut in both quality and appearance. Some are clean, coherent, easy to navigate, and are even easier to conceptualize as place rather than just space while others are cluttered, cumbersome environments that make a user feel a bit like she is walking through a construction site before the walls are up. Generally speaking, no two will either look or function alike.

With the release of graphical browsers for the World Wide Web in 1994, MOO developers started to experiment with adding graphical elements to MOOs, and by 1996 MOOki, TAPPED IN, Diversity University, LinguaMOO and others either had or were actively developing graphical interfaces. The surge of those early years offered up a number of failed efforts and a surprising number of startling successes. Unfortunately, while many of the success stories of that period would be more than competitive with later (perhaps even current) developments, they lacked the funding and promotional resources that would have made them available to the general public—or at least taken them beyond their own small and rather limited niches. Nevertheless, both the successes and failures of that period provided the building blocks and created the opportunity for something that would happen the following year, in 1997.

In 1997, Cynthia Haynes of the University of Texas at Dallas, and Jan Rune Holmevik and Sindre Sorensen of the University of Bergen in Norway released the beta version of a software that was to radically change the face of MOOs—literally—for much of the educational community, and do so in very short order (Haynes & Homevik, 1998; 1999). The release offered MOO



designers an alternative to existing resources in a two-part package: the High Wired enCore core (the heart or, in essence, the database skeleton of a MOO), and the graphic user interface, enCoreXpress. While the majority chose to use both the core and the interface, a fair percentage of builders with programming skills and resources opted instead to apply the enCoreXpress interface to their own cores. The interface is what made and continues to make this package most noteworthy; it increased the web applications of the MOO in such a way that an inexperienced user could log onto the MOO and be able to function in a relatively short period of time by taking advantage of her already-present ability to perform basic web browsing activities with Netscape/Mozilla or Internet Explorer. It provided a graphic user interface for those who wished one and lacked the skills, time, or resources to build their own, but it also offered the opportunity for some degree of uniformity and consistency between MOOs. While some functions changed from MOO to MOO depending upon the core or the MOO's programming resources and the owner's ability to fine tune the appearance or function of the existing package, the basic appearance and general operations remained the same, allowing users to go from one MOO to another without having to negotiate a completely new environment and learning curve.

Thanks in part to enCore's funding and publicity resources—advantages most MOO developers do not generally have—enCore has become a by-word within the academic MOOing community. The majority of web-based MOOs are currently using the enCoreXpress interface, and the software's popularity has spread globally, making it the dominant graphic user interface in use at this time, particularly within the educational community for which the program was first developed and introduced. Publication of Haynes and Holmevik's two texts—*High Wired* and *MOOiversity*, texts which are based on enCore's development—has created increased interest in the software and like ripples in a pond, the enCore interface has moved beyond its home court of academia and is becoming a growing presence in the world of social MOOs as well as MOOs associated with industry, science and technology, and the private sector.

Just as the faces of MOOs vary according to software design and coding, so too do their scope. MOOs currently occupy the entire spectrum of online activity, but they are most heavily concentrated in the educational, social, and gaming communities. Even within their niches, however, their range is nothing short of eclectic. One educational MOO in Bergen (cmcMOO) plays host to a display of Shakespeare's "A Midsummer Night's Dream" while others, like the recently defunct Diversity University, replicated campus classroom spaces. ESOL (English for Speakers of Other Languages) and foreign language MOOs include everything from Portuguese to Japanese. One social MOO is heavily "green" and builds clearly defined outdoor spaces while yet another has created a fantasy space of imaginative and impossible proportions. Gaming MOOs cover everything from the original "Dungeons and Dragons" to more modern

role-play games. Industry is gaining an increasing interest in the potential of these environments, and MOOs are now being considered for everything from virtual offices and customer support to scientific simulation. Regardless of their purpose, MOOs are very much a technology in a state of flux, and that condition of relative instability brings with it a mixed bag of both positive and negative conditions and results.

In addition to what has been mentioned already, MOOs are polysynchronous environments (Nolan, 1998; Nolan, 2001). The term polysynchronous was coined in order to describe the unique communicative affordances that MOOs offer. Polysynchronous environments are defined as virtual spaces that closely approximate real life environments. People communicating polysynchronously not only talk synchronously (in real time), but also create temporal objects such as mail messages, newsgroup messages, as well as objects that can be experienced by others. This form of virtual reality has potential as a dynamic learning environment.

This concept challenges the prevalent notion that online communication must be separated into synchronous and asynchronous activities. Most technologies only allow one activity; you can chat with your instant messenger or you can send an e-mail message. Though this limitation results from limitations on the part of those who conceptualize and design technologies, it has been taken up by both academics and the general public as a rigid limitation inherent in online communication. MOOs show that this does not have to be the case. MOOs were polysynchronous environments years before most internet users ever took their first online steps.

Almost all the information that passes back and forth across the internet is text, usually in the form of ASCII or Hexadecimal (Nolan, 2004). All our instant messages, emails, web pages, and blogs exist as some form of alphanumeric characters. It does not take much of a stretch of the imagination to realize that what may start as an instant message or a conversation in a MOO (synchronous) can be saved and pasted into a web page, e-mail message, or a blog and become an asynchronous document. This has always been the case in MOOs. What we say (through typed text) can be recorded, archived, consulted, or displayed at a later time. Furthermore, we can asynchronously program or script objects or robots (called bots) that are able to carry on complex conversations with individuals or groups at future points in time, and even the results of those bot/human conversations can be recorded and become material for future conversations (Leonard, 1997; Turkle, 1995). Though it is only slowly being recognized as such, the internet is inherently polysynchronous, and the synchronous/asynchronous dichotomy has been a temporary imposition by software designers.

There are a number of features that make MOOs valuable collaborative environments, and potentially the least of those is the ability to communicate in a real-time environment. While many limit their use of the technology to synchronous communications, MOOs are much more than chat rooms. The

ability to converse with students, teachers, and colleagues is indeed important, but MOOs go one step further than most chat technologies in that they allow a fuller mode of expression. MOOs recognize and create the required space for demonstration and performance of identity (Bruckman, 1992). For instance, rather than seeing a dislocated smile or emoticon beside a user's screen name, the audience sees a sentence that makes that expression both more vivid and more coherent: *Janet smiles*. Or, even better: *Janet smiles at you*. Permanent characters (non-guest avatars) are more than anonymous screen names; rather, they offer an infinite range of options for self-description and self-definition. Depending on the software and interface, users are able to not only provide text descriptions of themselves—including their special interests, e-mail address, or home web page information—but also have the opportunity to add graphics, photos, video, web cams, and sound, all of which help create a sense of the user's individuality and provide depth. Likewise, places—whether designed as outdoor spaces, fantasy realms, historical re-enactment, or traditional rooms—have the opportunity for personalization. Descriptions can be tailored to the creator's personal artistic or professional preferences and needs, graphics can be used (or eliminated) to help develop the setting, room activities and events can be generated in order to strengthen the sense of place and grant it dimension. In short, MOOs offer the advantage of making personal interactions much more “real” and immediate. That immediacy of experience is a large part of what makes MOOs special and helps differentiate them from the usual chat program. The user loses the sense that she is operating in something so mundane as a computer program and feels instead that she is part of a virtual community—often one that has as much reality and life as the “real” one away from her computer (Turkle, 1995; Wellman & Gulia, 1996; Baym, 1988 [1995]).

The ability to describe oneself has opened the path for discussions of gender and identity theory in ways that are not available to the face-to-face class. In a MOO, students can choose to call themselves by non-gender specific names, alter their descriptions, or change the avatar's settings to those of the opposing gender or gender neutral pronouns; they can experiment with genders other than their own. Likewise, they could choose to experiment with different class, race, or cultural identities. While such experimentation does not (indeed cannot and should not) attempt to assume full understanding of the experiences of those who live the lives students are role-playing, the experiment does open the door for dialog that cannot otherwise be generated so freely—or portrayed so vividly. Students are able to redefine themselves, and that process not only raises questions about casting of the “other,” but also pokes at the means by which they go about defining themselves in their own daily lives, and the way in which they interpret themselves as well as how they present themselves to be interpreted.

Personality and identity—regardless of whether it is the MOO's or the players'—is, of course, not the only advantage to a MOO. Another very large

advantage is the ability to create an object that another user can pick up, look at, manipulate, or use, incorporating a “sensory” and hands-on application to an otherwise purely visual learning experience. Such applications can be invaluable when it comes to recognizing and making the most of different learning styles; they allow students to explore their own learning processes in a manner that works best for them and by which they may gain the most benefit. As part of that approach, not only can the student “handle” the object or lesson, but also she can create her own in response. For instance, if the MOO-lesson guides students through the different aspects of writing dialog for a creative writing class, she may create two objects that “talk” to one another in a demonstration of those concepts, or she may program a bot to perform an interactive dialog with the instructor. Nor is that hands-on experience limited to a single-builder concept. While the MOO is a collection of code, if that code is designed properly and managed well, it becomes an interactive element of its own and performs in response to its users. While not living in the same sense as its players, their use and development of the MOO itself has the potential to turn it into a receptive and expressive environment with a personality of its own.

MOOs are unique for their ability to not only allow but also encourage collaboration. In short, a space may be developed by a group of people all working toward a given goal. For instance, a history class may recreate Civil War Gettysburg using very structured guidelines (each student creates objects and room space given a specific aspect of the assignment), or via the wonderful chaos of a free-for-all approach, allowing the class to brainstorm, create, and implement their ideas in their own unique learning process. The collaborative nature of MOOs is such an inherent feature that it is often overlooked in discussion, and it is frankly a difficult aspect to address, simply because of the sheer enormity of the possibilities. Small groups or entire communities can work together to create a representational space that combines knowledge and personalities of all the participants. A history club may create a series of rooms and objects that represent their understanding of the pre-Civil War American South, or a biology and natural science class may recreate the problems associated with a specific resource depletion. On a more limited level, a single user can create an object or space, then hand it over to another user for further development in a never-ending cycle of creation. By the same token, we must remember that the entire MOO—its programming, representation, geographic structure, and thematic construction—is the result of a collaborative effort of a MOO’s community and all its users. MOOs, as with people, do not exist in isolation, but rather are designed, created, and implemented by the society that uses it (Weiss et al., 2005).

An entire chapter could be dedicated to the issue of governance, and there are many resources that discuss the governance of online environments. Nolan and Weiss (2002) go into great detail to describe the major issues surrounding the question of governing MOOs. They describe a curriculum of community

that all participants must learn. This process is usually a social act of observation and modeling of acceptable practice. This curriculum is broken down into issues of access—how to connect to a MOO and use the environment; membership—how to interact with others and feel like a participant; and governance—how to keep the environment running both socially and technologically. Very few organizations, online or off, actually take these aspects of interaction into conscious consideration, but rather leave individuals to flounder and make their way on their own. For environments to be successful, however, those who run them have to ensure that not only are they interesting places full of interesting people and interesting things to do, but they also have to govern with a light touch, so that the experience is not a restricting one.

As with any online environment or community, MOOs need an organized system of governance (Collins & Berge, 1997; Fernback & Thompson, 1995; Foucault, 1991, Kollock, 1996; Ostrom, 1990). The environment is indeed a virtual one, but it still requires the same level of administration and support as any successful face-to-face program. That means that responsibilities need to be assigned to staff members, problem resolution avenues need to be prepared, operating expectations and standards established. Because of their online components, MOOs often become very personal very quickly; a sense of community can become so nearly a tangible characteristic that the MOO may well feel more like a family than a professional work environment—a family with all the egos, personality conflicts, and misunderstandings of any face-to-face family. If there is no administrative structure in place, it is far too easy for those critical elements to overwhelm the positive and the MOO to become a place of chaos, confusion, and factions.

It is important to recognize the “living” nature of MOOs. Just as they function and respond as performers—and host the performance of their users—they often have lives of their own. MOOs are born regularly and die equally regularly. The reasons for their passing are many and varied. Perhaps one of the biggest is the simple fact that they can be exhausting to administer and maintain, particularly if the MOO owner does not have administrative resources or funding for programmers and hardware. If the MOO is private and only plays host to the owner’s small class of 20 students each semester, the drain is reasonable; it is not much more demanding than maintaining one’s existing course materials, assuming the owner has the necessary hardware and internet access. If, however, the MOO is serving a variety of classes or an international community with a varied and active membership, the demand on time, funding, and hardware increases exponentially. Few MOO owners have the resources to hire programmers and administrators out of their own pockets. Simply put, some MOOs die when their owners can no longer support them. Others die because of the complex nature of their memberships. MOOs are living communities, and just as in “real” life, individuals grow away from each other, change jobs or lifestyles, move, and relocate. If a MOO does not have an active promotional program designed to bring in new members,

departing members may leave holes the MOO cannot fill, and the place soon becomes a ghost town. Last, some MOOs fall victim to their own members. Churches have long recognized the problem of splits in their congregations—splits that often result in evacuations that ultimately cripple the organization. The situation is no different in the MOO world. Members may fight amongst themselves, feelings get hurt, and people leave in favor of starting their own environment or joining another.

For whatever reason a MOO may die, its demise often creates a hole in the online community and affects real-life friendships and working relationships. Teachers must find other MOOs where they can host their classes, distance colleagues lose their forum for working relationships, and friends lose the opportunity to communicate regularly in a real-time environment. Some MOOers fall away from the MOO community altogether, others search for new homes, and yet others create their own.

Clearly, the overall state of the MOO as a concept is due for a major overhaul. Though it is presently a powerful and exciting tool, with great potential for learning implementations, and there are numerous projects underway using existing cores such as LambdaCore, enCore, and JHcore running on the LambdaMOO server, there are no active projects underway to develop the LambdaMOO server itself. There have been no changes to LambdaMOO since version 1.8.1 in early 2000.

There is no open-source community dedicated to bringing MOOs in line with existing standards of development. And, until there is some concerted effort to collaboratively develop the MOO, it will languish as a powerful and useful oddity, clinging to new changes in internet technologies by virtue of its inherent flexibility and the skills of the programmers working within the environment.

What we need is to reposition MOO as a paradigm for technology development and integration. The MOO paradigm, which is compatible with the hacker ethic and the various open source movements (Raymond, 1999; Raymond, n.d.; Stallman, 1999), is a way of looking at communication, online interactions, and programming. These three features are not seen in the MOO paradigm as separate functions, but rather integrated. Anyone who has an account on a MOO has the potential to become a programmer within the same environment. A user does not need to study programming, but rather learn how the MOO environment functions first through communication, then constructing representations of people, places, and things. Through participation in the MOO community and the sharing of skills, experiences, and stories, the user gains (or constructs) knowledge about the virtual environment. At this point, many users learn to program the aspects of the environment. Programming is one step beyond building “things.” It is the point where the user can now delve into the very structures with which the MOO is built. She can now program dynamic interactions, create whole new classes of objects for other people to use, or develop novel tools for communication and social interaction.

There is no other online or virtual environment that allows this breadth of participation from this wide a range of users—from guest, to a participant, to a builder creating virtual spaces, to a data-base programmer—all within a single virtual environment. In fact, very few environments and technologies can even be developed from inside by users. The MOO paradigm, which is loosely based on Seymour Paper's notions of constructionism (Davie & Nolan, 1999; Resnick, 1996), offers the ability to facilitate any kind of communication, social interaction, or experiential learning (Kolb, 1984; Moore, 1981) a teacher or learner can imagine. It is the ability to create an open-ended variety of virtual spaces along with the capacity to develop and program new tools from within a single community that sets MOOing apart from all other kinds of online interactions.

There is a very real potential for MOOs to finally rise to the challenge of being the concept that will truly facilitate the creation of widespread open source user-extensible virtual reality. This is an ambitious statement, but as things stand, there is no available technology that has the potential that MOOs exhibit. The MOO paradigm needs to be stripped down to its basic elements, legacy ghosts need to be exorcized, and MOOs need to return as a lean tool that will allow for the integration of what makes MOOs special with all the other elements of the internet—present and future—that fulfill niche needs.

The MOO paradigm is important for two major reasons. First, it offers constructivist virtuality—the fact that anything that can be described can be created in a MOO. Likewise, there is the internal object-oriented programming language that allows users to co-develop tools and applications from within. These two features allow for the rapid prototyping of new tools, collaborative co-development of virtual spaces, users' construction/control of their own environments, and the ability to glom (stick together or integrate) almost any other technology onto itself with minimal fuss.

The ability of the MOO paradigm to glom other technologies together requires some explanation. Although most internet tools have some rudimentary ability to communicate with each other, and there are multifunction tools—such as web-browsers—which are able to handle browsing, e-mail, chat, web page creation, and usenet news reading, it is difficult to make any changes to the provided suite of tools without waiting for the software vendor to provide a new version of the software.

Even with the existing MOO tools, however, both fledgling MOO programmer or experienced user is able to unilaterally attach any web-based multimedia tool to a MOO object. For example, in early 1996 MOOkiMOO, a precursor to Project Achieve, there was live streaming real-network video through the MOO to viewers who were then able to communicate with each other and post text questions to the live audience using the MOO's chat functions. It took less than a day to work out this prototype. Since that experiment, users have added shared whiteboards, audio-messaging systems, live-cams, and other tools they have found around the 'net and determined to be useful.

Because a user can add a useful tool with just a few lines of code, there is no requirement for a new version of MOO to come out in order to add new functionality. If a user does not like what is available, she can find something better and add it herself. Or, for that matter, she can create her own entirely new tool.

In order to extend the capacity of MOO at present, MOOs have built-in web, e-mail, newsreader, gopher servers, and clients. Keeping these sorts of built-in tools is unnecessary in today's distributed internet. Most users already have tools that perform these functions that are more suitable to individual tastes. What the MOO should, and can, afford is the option of joining the user's selection of tools together in the MOO, along with a plethora of other tools that work best for the user. The MOO would then facilitate the communication between these tools, and those of other users, in a seamless, transparent fashion.

MOOs are bandwidth independent. High-end users can still stream audio and video and use web-based Java tools. But this is not a minimum requirement. Anyone can access a MOO with the most minimal tools, such as a dumb terminal (computer screen and keyboard without a computer) and the oldest of modems to connect to a server with access to the internet. This means that the system requirements for text-MOOing are small enough that MOOs can be used in environments that have poor internet connections or old phone lines, an important issue when considering problems relating to the digital divide. It also means that MOOs can be used via wireless devices. There are no limitations as to what type of tools can be used to access MOOs, and regardless of how MOOs are developed, this capacity is unlikely to disappear.

Taking into consideration these sorts of capacities and flexibilities, it is possible to put together a picture of tomorrow's MOO. Imagine, if you will, a user-configurable core tool, self-sufficient and functioning all by itself. The core would include the following: telnet protocol-based text entry and response to handle communications to and from the MOO; hooks going from the MOO to a web server (probably Apache, since it is ubiquitous on the internet); hooks to PHP, Perl, and other scripting languages that are usually installed as modules in Apache servers; the MOO object-oriented programming language; all the basic MOO objects and classes for creating people, places, and things; all the MOO administration tools, help files, and tutorials; and added utilities for adding and configuring all the various multimedia communication tools that are the staple of the average user of the internet. What we have is the equivalent of an internet sticky tool to which a user can stick anything she or he wants in such a manner that the user can add or change any functioning element (e-mail, chat, streaming media, file and document servers) at will or whim without requiring the intercession of a programmer or system administrator.

At present, MOOs on the internet are charting two distinct paths. Projects such as enCore and TAPPED IN are providing powerful tools and



environments for the creation of CVEs. However, TAPPED IN, for example, has minimized the constructionist capacity of MOOs, making building and programming almost impossible. Their MOO hides all its inner workings in a metaphoric black box, not even openly acknowledging its MOOness.

enCore is well on its way to becoming the most popular MOOing platform. Until recently, enCore fell under the control of its developer, Jan Rune Holmevik. Limited resources meant that the program lacked the robustness and development potential of open-source projects where the project coordinators bring together work from a variety of programmers, and it is the highest quality work that makes it into the new releases. As of the fall of 2004, however, enCore's development is being nudged and guided by the enCore Consortium dedicated toward making the software—both core and interface—both more viable and more competitive.

The Consortium's hope is that a competitive array of teaching tools and increased flexibility, user-friendliness, support, and manageability will encourage instructors on all levels to consider the enCore MOO as an alternative to more restrictive and generally expensive courseware and course tools. For instance, an upcoming release of enCore's GUI will include a threaded discussion board and a variety of other tools designed to flesh out the existing package. A number of issues concerning students, teachers, and administrators of all levels are on the table and are being addressed by an eclectic collection of MOOers and programmers, most of whom currently fall within the realm of academia. Security issues associated with the GUI are not the least of these concerns, and a number of the software's former holes have already been closed. The increase in development resources promises a more energetic development program. While still too low profile to meet the need, the organization has been granted non-profit status, and an enCore Symposium planned for August of 2005 increased awareness of and provided publicity for both enCore and the organization itself. If the Consortium is able to draw in the necessary attention, talent, and funding from industry, government, and academia, enCore's future promises to be bright indeed, and its current lead in the world of MOOing will strengthen considerably.

MOO development is not dead, but with the exception of the enCore Consortium, it is somewhat dormant. TAPPED IN and enCore are spreading the popularity of MOO and have well-organized and easy-to-use environments. Clients such as MOOzilla are exploring new ways of interaction that do not suffer from the inherent problems of web-based programming. Both academic and business communities are watching MOOs, however, and no major paper or book on virtual community is complete without reference to MOOs. And with the thousands of young people learning programming skills in these social environments, a high percentage of whom are female, there is a growing body of future professionals who understand what MOOs are and what they can do to extend our experience online. Unfortunately and, again, aside from

the enCore Consortium, there are no major projects presently underway that are undertaking the renovation of MOOs or developing a MOO paradigm that facilitates the enhancement of constructionist learning, polysynchronous communication, and internal programming capacities. At present, MOOs are just beyond the event horizon, still waiting to be the next-big-thing.

#### REFERENCES

- Aarseth, E. (1997). *Cybertext Perspectives on Ergodic Literature*. Baltimore: Johns Hopkins.
- Bartle, R. (1990). Interactive Multi-User Computer Games (2005, January 23, 2005, <http://www.mud.co.uk/richard/imucg.htm>).
- Baym, N. [1998 (1995)]. The emergence of on-line community. In: Jones, S. (Ed.) *CyberSociety 2.0: Revisiting Computer-Mediated Communication and Community*. Thousand Oaks, CA: Sage, 35–68.
- Bruckman, A. (1992). Identity Workshop: Emergent Social and Psychological Phenomena in Text-Based Virtual Reality (Postscript Document) (<ftp://media.mit.edu/pub/asb/papers/MediaMOO-3cyberconf.ps.Z>) (March 1, 2005).
- Collins, M. P. & Berge, Z. L. (1997). Moderating on-line electronic discussion groups. Presented at the 1997 American Educational Research Association (AREA) Meeting, Chicago, IL, USA, March 24–28.
- Curtis, P. (1992). Mudding social phenomena in text-based virtual realities. *Intertrek*, 3(3), 26–34.
- Curtis, P. & Nichols, D. (1993). MUDs grow up: social virtual reality in the real world. Paper presented at the *Third International Conference on Cyberspace*, Austin, TX (2005, January 17, <http://citeseer.ist.psu.edu/curtis93muds.html>).
- Davie, L. & Nolan, J. (1999). Doing learning building constructionist skills for educators, or, theatre of metaphor skills constructing for building educators. Paper presented at the *TCC*, Maui, Hawaii (2004, October 14, <http://jasonnolan.net/papers/doing.html>).
- Fernback, J. & Thompson, B. (1995). Virtual Communities: Abort, Retry, Failure? (2005, January 1, <http://www.well.com/user/hlr/texts/VCCivil.html>).
- Foucault, M. (1991). Governmentality. In: Burchell, G., Gordon, C. and Miller, P. (Eds.) *The Foucault Effect: Studies in Governmental Rationality*. Hertfordshire: Harvester Wheatsheaf.
- Haynes, C. & Holmevik, J. R. (Ed.) (1998). *High Wired On the Design, Use and Theory of Educational MOOs*. Ann Arbor: University of Michigan Press.
- Haynes, C. & Holmevik, J. R. (Ed.) (1999). *MOOniversity*. New York: Allyn & Bacon.
- Kolb, D. (1984). *Experiential Learning*. Toronto: Prentice-Hall.
- Kollock, P. (1998, 1996). Design principles for online communities. *PC Update* 15(5), 58–60.
- Leonard, A. (1997). *Bots: The Origin of New Species, the Strange and Wild Saga of Cyberspace's Software Robots*. Toronto: Penguin.
- Moore, D. (1981). Discovering the pedagogy of experience. *Harvard Educational Review* 51(2), 286–300.
- Nolan, J. (1998). Educators in MOOkti: A Polysynchronous Collaborative Virtual Learning Environment (2005, January 25, <http://projectachieve.net/noisey/jason/mookti.html>).
- Nolan, J. (2001). The techneducator effect colliding technology and education in the conceptualization of virtual learning environments. Unpublished Dissertation (2005, January 1, <http://jasonnolan.net/papers/InfluenceofASCII.pdf>).
- Nolan, J. (2004). The influence of ASCII on the construction of internet-based knowledge. In: Hewitt, J. and DeCoito, I. (Eds.) *OISE-UT Papers in Technology Education*. Toronto: Imperial Oil Centre for Science, Mathematics and Technology Education, 99–114.

- Nolan, J. & Weiss, J. (2002). Learning cyberspace an educational view of virtual community. *Building Virtual Communities Learning and Change in Cyberspace*. Ann Renninger and Wes Shumar: Cambridge UP.
- Ostrom, E. (1990). *Governing the Commons: The Evolution of Institutions for Collective Action*. Cambridge: Cambridge University Press.
- Raymond, E. (1999, October 26). The Cathedral and the Bazaar (Web site) (<http://www.catb.org/~esr/writings/cathedral-bazaar/>) (2005, December 15).
- Raymond, E. (n.d.). The Hacker Ethic (Web site) (<http://catb.org/~esr/jargon/html/H/hacker-ethic.html>) (2005, December 15).
- Resnick, M. (1996). Distributed Constructionism (Web site) (<http://llk.media.mit.edu/papers/archive/Distrib-Construct.html>) (2005, March 1).
- Rheingold, H. (1993). *The Virtual Community Homesteading on the Electronic Frontier*. Reading, Massachusetts: HarperPerennial.
- Stallman, R. (1999). Free Software Definition—GNU Project—Free Software Foundation (FSF) (Web site). Free Software Foundation, Inc. (<http://www.fsf.org/philosophy/free-sw.html>) (2005, January 18).
- Turkle, S. (1995). *Life on the Screen*. New York: Shuster.
- Weiss, J., Nolan, J., & Nincic, V. (2005). Virtual communities. In: Trifonas, P. (Ed.) *The Communities of Difference*. New York: Palgrave (Global Publishing).
- Wellman, B. & Gulia, M. (1996). Net surfers do not ride alone virtual communities as communities. In: Smith, M. (Ed.) *Communities in Cyberspace*. Berkeley: University of California Press.

## Chapter 18: Designing Virtual Learning Environments for Academic Language Development

ELENI SKOURTOU\*, VASILIA KOURTIS-KAZOULLIS\*,  
AND JIM CUMMINS†

\**University of the Aegean*; †*University of Toronto*

### 1. INTRODUCTION

In this chapter, we examine the relationships between pedagogy and the use of information technology (IT) in schools. IT refers not only to computers (hardware and software), but also to the full range of multimedia technological tools that are potentially available to support learning and communication of knowledge (e.g., digital and video cameras, DVD players, etc.). Specifically, we address questions such as: What pedagogical options are available for use of IT in schools? To what extent can IT amplify the impact of different approaches to pedagogy? Is the impact of IT potentially more powerful as a catalyst and support for learning when harnessed to certain forms of pedagogy as compared with others?

These questions reflect the fact that despite the increase in access to IT in schools, it is not clear what educational problems IT is supposed to solve. Policy-makers assume that IT will promote student achievement but, as documented below, there is still no large-scale support for such an assumption. Furthermore, there is no consensus as to *how* computers and other new technologies should be used to support learning. In the United States, for example, schools in affluent middle-class areas increasingly tend to use computers to support higher-order thinking through creative project work while those in low-income inner city areas still use computers predominantly to reinforce students' mastery of basic skills through drill and practice activities (Education Week, 2001).

Drawing from both North American and European research and recent experience, we argue that questions regarding the effectiveness and cost-effectiveness of IT in schools can be coherently addressed only in relation to the potential of IT within particular pedagogical orientations. We distinguish three pedagogical orientations that we envisage nested within each other. In the inner circle, with the narrowest focus, is transmission-oriented pedagogy where the goal is to transmit the information and skills articulated in the curriculum directly to students. The middle circle marks a pedagogical space that we term social constructivist pedagogy (Windschitl, 2002). This orientation

incorporates the curriculum focus of transmission approaches but broadens it to include the development among students of higher-order thinking abilities based on teachers and students co-constructing knowledge and understanding. Finally, transformative approaches to pedagogy broaden the focus still further by emphasizing the relevance not only of curriculum transmission and knowledge construction, but also of promoting critical literacy among students to enable them to analyze societal discourses and conceptualize forms of action to affect these discourses.

We describe the potential of IT to amplify the impact of each of these forms of instruction drawing primarily on data from a computer-mediated sister-class project between students in Greece (specifically the islands of Rhodes and Kassos) and Toronto, Canada (Kourtis-Kazoullis, 2002; Skourtou, 2002; Skourtou & Kourtis-Kazoullis, 2002). We conclude that among school-age students, the impact of IT, as well as its cost-effectiveness, is likely to be significantly greater when it is harnessed to social constructivist and transformative pedagogies than to transmission pedagogies. However, this impact will be apparent only when appropriate forms of assessment are employed. Most standardized tests and national examinations focus primarily on lower-level skills and information contained in the curriculum and are thus likely to be insensitive to the thinking and literacy skills that social constructivist and transformative pedagogies attempt to promote.

It is important to note that we are not in any way disputing the potential efficiency of IT in transmitting information and skills to adults and school-age students. Transmission of information and skills is certainly a legitimate goal in many educational and corporate contexts. However, the goals of schooling go far beyond these forms of transmission, and to limit our pedagogical vision to a transmission mode represents an anemic orientation to education and a highly inefficient use of IT.

We begin with a brief overview of some of the key constructs that need to be clarified in examining the design of virtual technology-mediated learning environments. These constructs include Literacy, Technology, Curriculum/Pedagogy, Assessment, and Diversity.

## 2. CLARIFYING KEY CONSTRUCTS

### 2.1. Literacy

The teaching of literacy in the context of formal schooling has been controversial since its origins in the early 1800s and it remains so in many contexts around the world (see Clark, 2001 for analysis of the volatile “literacy crisis” debates in several countries). Academic debate on the nature of literacy has continued alongside the public debates and has yielded many insightful conceptualizations (e.g., Hornberger, 2003; Kalantzis & Cope, 2000; Willinsky,

1990). Two sets of constructs are worth noting at this point: (a) the distinction between *autonomous and ideological orientations* to literacy and (b) the contrast between traditional linear text-based forms of literacy and the multiple forms of literacies encompassed by the term *multiliteracies* (Kalantzis & Cope, 2000).

With respect to literacy instruction, in most countries curriculum is based on what Street (1999) terms an *autonomous model of literacy* that “assumes decontextualized skills, competencies, basics, a sequence from isolated to more complex units, and it privileges written over oral language” (p. 9). In contrast, many current literacy theorists endorse an *ideological model of literacy* that conceptualizes literacy as a set of social practices that are embedded in societal power relations (e.g., Baynham & Prinsloo, 2001; Gee, 2000; Kalantzis & Cope, 2000; Street, 1995; 1999).

Although autonomous and ideological models of literacy are typically contrasted with each other as opposite orientations, this is not necessarily the most productive conceptualization (Cummins, 2000). We locate our research and theory (elaborated below) broadly within an ideological model of literacy while viewing school-based (autonomous) literacy as one set of crucial social practices in which students must develop expertise if they are to participate productively in social and economic life.

The social practices that constitute typical school-based literacy should not be taken as given and immutable; rather they are subject to critique from the perspectives of both social constructivist and transformative pedagogical orientations. Thus, the relationship we envisage between “autonomous” and “ideological” orientations to literacy is one of constant critical dialog where school-based literacy practices are pushed to locate themselves in relation to societal power relations, and ideological pronouncements and/or prescriptions regarding literacy are pushed to realize themselves in practice in the complex world of schooling.

The term *multiliteracies* was introduced by the New London Group (1996) and includes both new forms of literacy associated with information, communication, and multimedia technologies (e.g., the ability to create web pages) and, equally important, the variety of culturally specific forms of literacy associated with complex pluralistic societies (Kalantzis & Cope, 2000). The construct of multiliteracies reflects the fact that we live in a world where population mobility and technological change are rapidly transforming social, economic, and educational realities. These technological changes, together with the information explosion, have also resulted in demands that schools promote higher levels of conventional literacy (reading and writing skills) together with expertise in new forms of literacy (e.g., computer literacy, media literacy) that are emerging in unpredictable ways.

The normalization of cultural and linguistic diversity in schools, together with the increasing infusion of sophisticated technologies into all aspects of society, has created both challenges and opportunities for education.

Specifically, is it feasible or reasonable to expect a one-size-fits-all homogenized curriculum to meet the needs of an increasingly diverse student body? To what extent should the education system attempt to acknowledge and promote the linguistic and cultural resources that students bring to school? If we see it as educationally desirable to promote students' multilingual and multicultural potential in schools, then what kinds of curricula and pedagogy are likely to achieve this goal? How do we evaluate a differentiated approach to curriculum and pedagogy as opposed to a homogenized centrally imposed model?

## 2.2. Technology

Computer access has expanded dramatically in North American and European schools. In the United States, the gap between affluent and poor schools in access to computer technology has also been reduced in recent years. The periodical, *Education Week* (2001) reports, for example, that schools in high poverty communities have one computer for every 5.3 students which is just slightly higher than the national average of one computer for every 4.9 students. However, although the "digital divide" between affluent and poor schools has been reduced with respect to quantity indices, the gap persists in the ways computers are utilized:

With poor children, student-to-computer ratios belie huge gaps when it comes to internet access, according to the U.S. Department of Education. In schools, where fewer than 11 percent of students qualify for federally subsidized lunches, for example, 74 percent of classrooms have internet access. On the other hand, in schools where 71 percent or more students are living in poverty, only 39 percent of classrooms are connected to the internet.

(Manzo, 2001: 12)

The recent massive investment in IT has been undertaken on faith rather than evidence. Critics in the United States have pointed to the absence of any overall impact on national reading achievement levels despite more than a decade of increasing access to IT in U.S. schools (Bennett, 2002). Canadian critics have berated the *disinformation highway* (Barlow & Robertson, 1994) and the diversion of scarce resources from other areas of the curriculum (Armstrong & Casement, 1998).

We argue below that a major reason for the lack of demonstrable impact of IT on academic achievement is that there has been minimal focus on the kinds of *pedagogy* that are required to exploit the potential of new technologies (Cuban, 2001; Cummins & Sayers, 1995) and the forms of *assessment* required to evaluate these potential impacts. Tyner (1998) has forcefully expressed this

point: “The scholarship on the uses of electronic and digital communication forms for literacy purposes is abysmally weak” (p. 41). This situation is beginning to change. For example, a recent volume (Feldman et al., 2000) analyzing 10 years of data on the use of computer networking to support the learning of Science (e.g., the National Geographic Kids Network) highlighted the naiveté underlying aspects of the initial pedagogical vision. They articulated the importance of a social constructivist approach to pedagogy if IT projects are to yield academic gains. However, at this point, educators and policy-makers have just begun to address the integration of technology and pedagogy.

### *2.2.1. Use of IT in Greek Schools*

Within the European context, the situation in Greece can be used to illustrate trends that apply across European Union (EU) countries (Kron & Sofos, 2003). EU funding has made possible the expansion of IT within educational contexts even in less affluent countries. IT is regarded as highly significant by EU policy-makers as a means to connect different languages and cultures beyond national borders.

Golemati (2000) has identified different forms of IT use within Greek schools:

- (a) the teaching of IT as a subject in schools;
- (b) the use of IT as a tool of teaching in other subjects;
- (c) the use of IT for administrative purposes (e.g., the use of software for school administration);
- (d) the use in IT in experimental student-centered learning environments; and
- (e) the training of teachers through Ministry of the Education programs.

She reports that the majority of uses in Greek schools involved situations (a) and (b) above.

Koutsogiannis (1999) separates the use of IT in Greek schools into three periods:

- The first period (1986–1992) includes the first computer laboratories in approximately 500 schools in secondary education and the use of these laboratories for the teaching of computer science;
- The second period (1992–1996) involved the creation of 800 more computer laboratories and the explicit consideration of pedagogical goals;
- The third period (1996–1999) involved (a) small-scale pilot studies involving computer-mediated communication, (b) development of software for the teaching of specific subject areas, and (c) in-school training of educators.



Recent work has highlighted the challenge Greek educators face in trying to integrate the use of IT into a very traditional centrally imposed curriculum. Koutsogiannis (1999) reported that the majority of teachers he studied followed the curriculum of the school and used traditional pedagogy in both the regular classroom and IT contexts. Teachers attempted to transfer the familiar methods they used in the regular classroom to the new electronic environment. This is hardly surprising. Because teachers are required to follow a central curriculum, there is little opportunity or incentive for pedagogical innovation (Raptis & Raptis, 2002). Support materials designed for teachers (e.g., software consisting of practice drills or textbooks on how to use the internet) are also often highly traditional.

### 2.3. Curriculum/Pedagogy

Clark (2001) points to the polarized debate in many countries between “traditionalists” and “progressivists”, the former portrayed as “representing order in the classroom with a defined sense of what was right and wrong whilst ‘progressivists’ were represented as child-centered, relativist and presiding over chaotic classrooms” (p. 149). The pedagogical framework that we have used to guide our research on computer-mediated sister-class projects avoids these caricatured extremes by highlighting the centrality of knowledge generation in an Information Age economy and the need for rigorous guided student inquiry as a foundation for learning. The framework also emphasizes (a) the centrality of language to all areas of the school curriculum (Cummins, 2001; Early, 2001; Hornberger, 2003; Mohan, 1986), (b) the role of imagination as one of the “most powerful and energetic intellectual tools children bring to school” (Egan, 1986: 18), and (c) the importance of collaborative critical inquiry that builds on and validates students’ experience and culture (Cummins, 2001; Greenleaf et al., 2001; Kalantzis & Cope, 2000; Wells, 1999). The framework does not discard the utility of transmitting information and skills but highlights the importance of expanding a transmission or traditional orientation into *social constructivist* and *transformative* orientations. The former focuses on collaborative knowledge building and experiential learning designed to promote literacy and higher-order thinking while the latter similarly highlights the importance of collaborative knowledge building and experiential learning but with the goal of developing a *critical* literacy that focuses on social, rather than just cognitive, realities.

As illustrated in Figure 1, we envisage the three pedagogical orientations nested within each other rather than being distinct and isolated from each other.

Transmission-oriented pedagogy is represented in the inner circle with the narrowest focus; the goal is to transmit information and skills articulated in the curriculum directly to students. Social constructivist pedagogy,

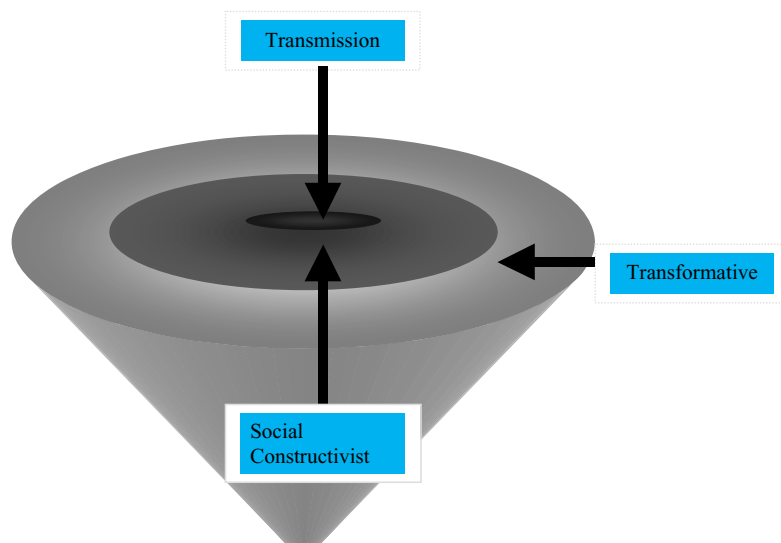

Figure 1. Nested pedagogical orientations.

occupying the middle pedagogical space, incorporates the curriculum focus of transmission approaches but broadens it to include the development among students of higher-order thinking abilities based on teachers and students co-constructing knowledge and understanding. Finally, transformative approaches to pedagogy broaden the focus still further by emphasizing the relevance not only of transmitting the curriculum and constructing knowledge, but also of promoting critical literacy among students to enable them to analyze societal discourses and conceptualize forms of action to affect these discourses.

The rationale for nesting these orientations within each other is to highlight the fact that features of traditional/transmission pedagogy are relevant to all kinds of learning. Both in classrooms that are clearly traditionally orientated and in communities of critical inquiry among students and teachers, structured guidelines and explicit instruction can play an important role in effective teaching/learning. Similarly, as the *DiaLogos* project outlined below illustrates, even in a traditional learning environment, spaces can be opened for social constructivist pedagogy, which, in turn, can sow the seeds for transformative pedagogy.

#### 2.4. Assessment

Standardized assessment has become a major tool in the drive to increase literacy attainments in schools. There is considerable concern, however, that an over-emphasis on tests has narrowed the curriculum and is causing teachers

to “teach to the test”, consigning broader educational goals such as the development of imagination, critical literacy, and higher-order thinking to the status of “off-task” activities (e.g., Kohn, 2000). Most centrally mandated large-scale assessment programs in countries around the world focus narrowly on traditional school-based literacy and ignore the multiple literacies (linguistic and technological) that may be equally relevant to students’ future economic advancement and civic participation (Kalantzis & Cope, 2000).

The relevance of re-conceptualizing high-stakes assessment procedures is that the design of innovative virtual learning environments will be severely constricted if students’ accomplishments within these environments are ignored for assessment purposes. If traditional reading, writing, and numeracy skills are the primary (or exclusive) focus of assessment, then students who spend time pursuing multiliteracies endeavors and/or critical literacy activities are likely to be penalized rather than rewarded for their achievements.

From our perspective, assessment should reflect, and reinforce, the range of pedagogical orientations and goals that are being implemented in the classroom. Unfortunately, in many contexts, assessment succeeds in reinforcing only transmission-oriented pedagogy and effectively eliminates other pedagogical orientations from the classroom. Thus, we would advocate different forms of assessment according to the specific learning activities that are being pursued. For example, traditional paper and pencil tests may be appropriate for a vocabulary learning activity, but this form of assessment is incapable of capturing the learning objectives of group-based project work. The latter forms of activity might be better assessed through portfolio assessment that tracks students’ academic accomplishments over time (Tierney, 1991). Thus, just as an applicant for Art College would submit his/her portfolio of work for assessment, students’ accomplishments in multiple spheres of literacy endeavor (e.g., web-page design, writing of bilingual stories for younger students, etc.), both in school and outside school, could be gathered in portfolios, assessed, and given academic credit. Implementation of portfolio assessment was a major factor in the outstanding academic outcomes obtained during the 1990s by recently arrived low-income ESL students attending the International High School in LaGuardia Community College in New York City (Cummins, 2001; DeFazio, 1997).

## **2.5. Diversity**

Cultural and linguistic diversity has become the norm in major urban school systems across both North American and Europe. More than 50% of the school population in Toronto and Vancouver, for example, come from non-English-speaking backgrounds. The same trends are evident in Europe. For example, during much of the 20th century, Greece supplied many immigrants to the United States, Canada, and Australia but during recent decades has become

a host country for immigrants from former socialist East European countries. Rhodes, the major site of the project we describe below represents a highly multicultural/multilingual landscape (Gialamas et al., 2000; Skourtou, 1995). The new global economy is similarly characterized by a plethora of languages and cultures, despite the current dominance of English in many cultural, scientific, and economic spheres. Thus, any pedagogical framework that aspires to promote literacy and prepare students for a globalized Information Age economy must assign a central role to linguistic and cultural diversity. Currently, this is not the case in the vast majority of European and North American school systems, despite occasional rhetoric about multicultural and anti-racist education.

The necessity to articulate pedagogical intersections between diversity issues and the design of virtual learning environments can be illustrated by examining one of the central components of a social constructivist orientation, namely the importance of activating students' prior knowledge in the teaching/learning process (e.g., Cummins, 2000; Wells, 1999). In a classroom (or virtual learning environment) characterized by cultural and linguistic diversity among learners, activating prior knowledge will bring a diverse array of culturally specific experiences into the pedagogical space. When the learning environment is designed appropriately, this process will enhance the learning opportunities of all learners. Unfortunately, however, there are currently few pedagogical guidelines or documented procedures for implementing virtual learning environments that respond appropriately to the diversity of student experiences.

In conclusion, although of necessity we have considered these five areas of theoretical and practical concern separately, they are interwoven in virtually all the interactions that educators, individually and collectively, orchestrate with their students. The challenge for educators is to integrate these areas within a coherent pedagogical framework particularly in the context of designing virtual learning environments, which are likely to proliferate in the near future (Tyner, 1998). A major paradox in the current situation is that virtual learning environments potentially provide the means to differentiate learning experiences according to the prior knowledge, learning styles, and goals of a diverse array of learners but they are increasingly being implemented in educational contexts that are retreating rapidly into one-size-fits-all homogeneous pedagogical and assessment orientations.

In the next section, we outline the framework within which we have conceptualized our recent work in designing and implementing virtual learning environments that respond to the considerations outlined above. This framework builds on the nested configuration of pedagogical orientations outlined above. Explicit demystification of how language and literacy operate as semiotic systems is very much incorporated into the framework as is the pursuit of *dialogic inquiry* (Wells, 1999) and the development among students of a critical awareness of how language and power intersect. Both *process* and

*product* are seen as important with students encouraged to use language to explore and act on social realities that affect their lives.

### 3. FRAMEWORK FOR TECHNOLOGY-SUPPORTED ACADEMIC LANGUAGE LEARNING

The central sphere in Figure 2 represents the interpersonal space created in the interactions between teachers and students. Within this interpersonal space, knowledge is constructed and identities are negotiated. In other words, teacher–student interactions can be viewed through two lens: (a) the lens of *the teaching–learning relationship* in a narrow sense, represented by the strategies and techniques that teachers use to promote literacy, numeracy, content knowledge, and cognitive growth and (b) the lens of *identity negotiation* reflected in the messages communicated to students regarding their identities—who they

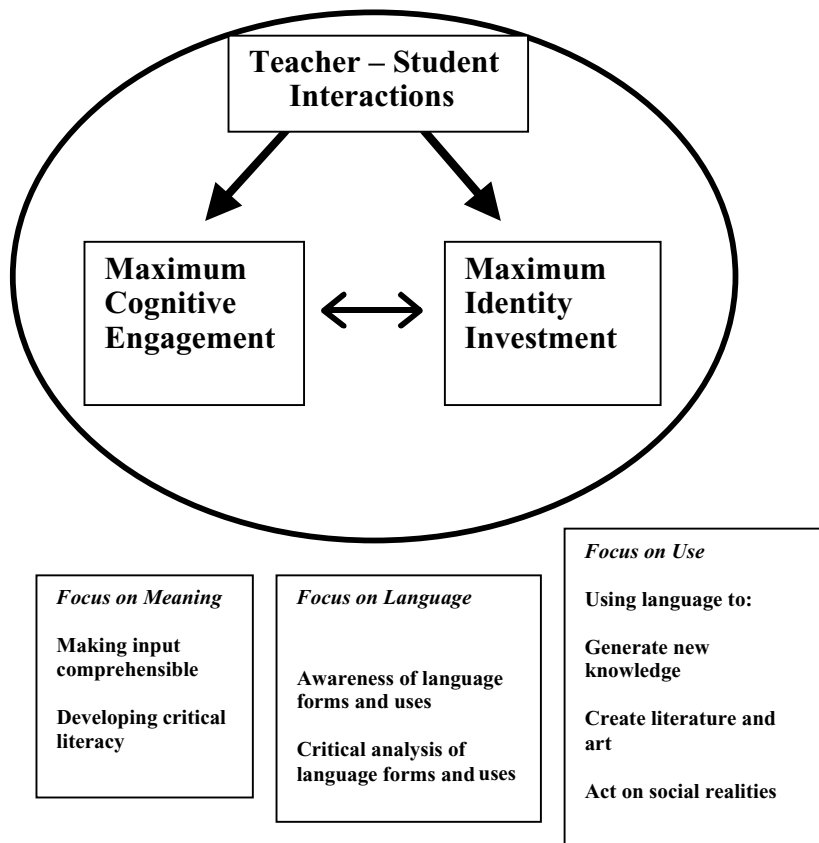

Figure 2. A framework for academic language learning. Source: Adapted from Cummins (2001: 125).

are in the teacher's eyes and who they are capable of becoming. The framework proposes that an optimal learning environment, virtual or "real", requires that both cognitive engagement and identity investment be maximized.

In contexts of cultural, linguistic, or economic diversity, these interactions are never neutral: They either challenge the operation of coercive relations of power in the wider society or they reinforce these power relations. Within the interpersonal space of teacher–student interactions, the more students become engaged cognitively, the more academic progress they are likely to make. Engagement of higher level cognitive processes is likely to produce much more learning for the simple reason that much more of students' brains are involved in the process of learning. If students are involved primarily in rote memorization in the classroom, only a fraction of their cognitive capacity is engaged in learning.

The interpersonal space represented in Figure 2 extends Vygotsky's (1978) notion of the *zone of proximal development* beyond the cognitive sphere into the realms of affective development and power relationships. The dual process of reciprocal negotiation of identity and collaborative generation of knowledge take place within this *construction zone* and are seen as being intimately related to each other. Teacher–student collaboration in the construction of knowledge will operate effectively only in contexts where students' identities are being affirmed. The framework also makes clear that the *construction zone* can also be a *constriction zone* where student identities and learning are constricted rather than extended.

The relevance of identity investment derives from the fact that affect is a major determinant of the extent to which students are likely to engage cognitively and academically. Students will be reluctant to invest their identities in the learning process if they feel their teachers do not like them, respect them, and appreciate their experiences and talents. In the past, students from marginalized social groups have seldom felt this sense of affirmation and respect for language and culture from their teachers, and consequently their intellectual and personal talents rarely found expression in the classroom. This perspective implies that in considering the potential of IT projects or programs to increase academic engagement among students from marginalized communities, two significant factors are likely to be (a) the extent to which students are encouraged to explore and appreciate aspects of their own cultural and linguistic heritage and (b) the extent to which they come to see themselves as intelligent and capable human beings in the process of carrying out these projects.

There is a reciprocal relationship between cognitive engagement and identity investment. The more affirmed and respected students feel in the learning environment, the more they are likely to engage cognitively; cognitive engagement results in learning and the more the students learn, the more their academic self-concept grows, which, in turn, results in more cognitive and academic engagement.

With specific reference to academic language learning, the framework proposes that instruction should focus on *meaning*, *language*, and *use*. Each of these foci is sketched below.

### 3.1. Focus on Meaning

The framework highlights the fact that effective instruction in a first or second language must focus initially on meaning or messages. Virtually all applied linguists agree that access to sufficient comprehensible input in the target language is a necessary condition for language acquisition. With respect to academic language learning in both L1 and L2, there is a vast amount of research showing a strong positive relationship between extensive reading and the development of reading comprehension (see Cummins, 2001, for a review).

The focus on meaning component argues that the interpretation of the construct of *comprehensible input* must go beyond just literal comprehension. Depth of understanding of concepts and vocabulary as well as critical literacy are intrinsic to the notion of comprehensible input when we are talking about the development of academic language proficiency. This implies a process whereby students relate textual and instructional meanings to their own experience and prior knowledge (i.e., activate their cognitive schemata), critically analyze the information in the text (e.g., evaluate the validity of various arguments or propositions), and use the results of their discussions and analyses in some concrete, intrinsically motivating activity or project (e.g., making a video or writing a poem or essay on a particular topic).

The application of IT tools in this way is consistent with Wells' (1999, 2000) advocacy of communities of *dialogic inquiry* where students, in negotiation with their teachers, plan their topics of inquiry and integrate their prior knowledge into the knowledge generation process within the school. The aim is to offer students multiple opportunities to contextualize learning. In Gee's (2000) work, *context* is a central construct. Learning becomes meaningful to students when they can create a context that integrates what they already know and what they are taught. A major part of this context is the particular discourse community, to which the student must gain access for learning to occur, whose perspectives, values, and "ways with words" (Heath, 1983) structure meaning in specific ways. Kress (2000) similarly argues for the role of context making and transformation in learning. The individual student is seen as a "re-maker" or "transformer" of learning resources (e.g., texts, videos, etc.) rather than as simply a "user" of them. Re-making of learning resources is a necessary process that the student has to go through in order to contextualize the content and make it comprehensible (Wells, 1999). Prior knowledge and contextual support represent the means for this transformation.

Depth of cognitive engagement, as implied by the transformation of learning resources, seldom occurs within a traditional pedagogical orientation because the focus is typically on memorization of content and internalization of particular literacy-related skills. Thus, the comprehensible input that students receive seldom moves beyond superficial literal understanding.

### 3.2. Focus on Language

The focus on language component in Figure 2 attempts to put controversial issues such as the appropriate time and ways to teach grammar, the role of phonics in reading instruction, etc. under the “umbrella” of *Language Awareness*. The development of language awareness (Toulasiewicz & Adams, 1999) includes not just an explicit focus on formal aspects of the language but also the development of *critical language awareness* that encompasses exploration of the relationships between language and power. Students, for example, might carry out research on the status of different varieties of language (e.g., colloquial language versus formal “standard” language) and explore critically why one form is considered by many educators and the general public to be “better” than the other. They might also research issues such as linguistic code switching and the functions it plays within their own lives and their bilingual communities. Or they might analyze letters to the editor on controversial issues such as immigration and examine how the language used in these letters positions and potentially stereotypes minority group learners such as themselves and their parents.

In short, the framework proposes that a focus on formal features of the target language should be integrated with critical inquiry into issues of language and power. Also, to be effective, a focus on language must be linked to extensive input in the target language (e.g., through reading) and extensive opportunities for written and oral use of the language (e.g., oral or written discussion of controversial issues).

### 3.3. Focus on Use

The focus on use component is based on the notion that L1 and L2 acquisition will remain abstract and classroom-bound unless students have the opportunity to express themselves—their identities and their intelligence—through language. In order to motivate language use, there should ideally be an authentic audience that encourages two-way communication in both oral and written modes. Clearly, computer-mediated sister-class projects provide such an audience. The three examples of language use presented in Figure 2 (*generate new knowledge, create literature and art, act on social realities*) are intended to illustrate important components of critical literacy. Language must be used



to amplify students' intellectual, esthetic, and social identities if it is to contribute to student empowerment, understood as the collaborative creation of power (Cummins, 2001). Unless active and authentic language use for these purposes is promoted in the classroom, students' grasp of academic (and conversational) aspects of their second language is likely to remain shallow and passive.

There is little question that IT can provide many of the essential components required to stimulate active written language use. Collaborative sister-class projects, publication of student work on classroom or school web pages, or simply the use of computers to layout and print newsletters or other forms of publication all facilitate access to wider audiences than would otherwise be possible. IT can dramatically expand the communities of inquiry to which students have access and provide immediate outlets for communicating the results of students' intellectual and artistic work (e.g., through school or class web pages).

The focus on use component in our framework incorporates this transformational aspect of language use, highlighted by Kress (2000), and does not simply involve mechanical application of prior designs. Kress argues that it is insufficient for learners to be positioned only as "users" of an existing stable system without acting on, and transforming, this system.

We illustrate the relevance of this framework as a heuristic device for conceptualizing the relationship between pedagogy and technology with reference to the outcomes of the *DiaLogos* computer-mediated sister-class project (Kourtis-Kazoullis, 2002).

#### 4. THE DIALOGOS PROJECT

*DiaLogos* was an internet-based sister-class project that was carried out over two school years between elementary school classes (4th, 5th, and 6th grades) in Canada and Greece. The initial objective was to create an environment of *dialogic inquiry* (Wells, 1999) where two different languages (i.e., English and Greek) could be learned. In co-operation with their sister classes, students in Greece were learning English and students in Canada (primarily students of Greek descent) were learning Greek. Students in the Greek primary school attend English lessons 3 hours per week. The *DiaLogos* students attended regular English lessons two times a week using the class textbook. However, once a week the lesson was held in the *DiaLogos* computer room.

The title, *DiaLogos*, implies many things. In the simplest sense, as one word, "dialogos" means conversation or dialog in Greek. However, with the "L" capitalized, *DiaLogos* is separated into two words and implies two different things: (a) "dia logos" or (b) "diadiktuou logos". In reference to (a), dialogos literally means *through words/through discourse/through logos*. The meaning of logos in Greek incorporates notions such as "speech", "discourse", and

the system of rules underlying particular discourses. In reference to (b), a diadiktuou logo means *logos on/through the internet*.

On the DiaLogos web page, there was a play on words inviting the students to take part in “dialogos” or communication stating that:

*A **DiaLogos** needs at least two **people**. It needs at least one **language**. And it needs at least one **subject**. We need **many people** to make our DiaLogos interesting. We also need **many languages** in order to be able to carry out the DiaLogos with many people. And we need **many interesting subjects** to be able to learn many things from our DiaLogos. In other words, we need **YOU**, the **LANGUAGES** you know and those that you want to learn and the **SUBJECTS** that will help us explore and discover new things.*

(DiaLogos web page)

Although, on the Greek side, DiaLogos was carried out within a traditional textbook-dominated educational setting, the pedagogical orientation of the project itself attempted to be explicitly transformative. However, at different times, the activities that took place in the classroom (with or without IT) ranged across the pedagogical space depicted in Figure 1. At certain times, the activities were partly traditional, partly constructivist. At other times, they were constructivist, moving toward transformative. However, regardless of where the activities were located within the pedagogical space, the “target” was always within the transformative realm.

The activities carried out by students in *DiaLogos* illustrate the major dimensions of the pedagogical framework articulated in Figure 2. As the examples outlined below show, students were cognitively engaged and personally invested to a high degree in the various projects they carried out. They read and discussed a considerable amount of material in the target language (English) originating both from internet sources and their sister-class partners (*focus on meaning*). They became aware of and began to use forms of colloquial English that they would never have heard within the traditional English language classroom (*focus on language*). Finally, they created “products” or “artifacts” (Wells, 1999) that, we would argue, amplified their sense of self. Their use of language (both Greek and English) entailed the creation of literature and art and concrete action on social realities that affected their lives (*focus on use*). These different foci are integrated in the activities described below.

#### 4.1. Critical Awareness of Language Forms and Uses

Within the regular English classroom, a *focus on language* was already apparent with the teacher making the students aware of language forms and uses by explicitly teaching grammar, vocabulary, syntax, etc. in a traditional manner. The English language in their textbook was of a relatively consistent

form. In contrast, the English language on the internet was diverse, and the English language used by their sister classes opened up entirely new possibilities for using the language. The Canadian students were using expressions that were completely new to the students in Greece, as the following two examples illustrate [spelling mistakes are original]:

**[Student from Canada]**

Katerina—I didn't have much of a Christmas this year because I was moviong and we didn't put up a tree and stuff like that but it was fun moving and stuff. On Christmas eve we went to my aunt's house and had a big feast and me and cousin Maria were chilling out. On New Years eve we went to my moms friends house and clebrated it there and we brought in 1999 we [with] a really big bang!!

BYE FOR NOW KATERINA!!!!!!!!!!!!

**[Student from Canada]**

On my winter break I had a remarkable week. My sister had her 8th birthday party. We had a blast!

Expressions in the letters from Canadian students such as *stuff like that*, and *stuff, chilling out*, with *a really big bang*, *we had a blast* and *whaz up*, fueled the students' curiosity and resulted in critical analysis of language forms. *Cool* and *bad* were words that students in Greece were familiar with; however, they were not familiar with the different way in which they were used. The Canadian students were using English but a different type of English. This had a significant effect on the students in Greece who began using the English language in similar ways to the students in Canada as early as the first year of correspondence (Kourtis-Kazoullis, 2002).

**4.2. Generating New Knowledge**

In Greece, the curriculum is prescribed by the central government and the same textbooks are used in all regions of Greece, despite the local identities and local language varieties of the students. Students in the island of Kassos used DiaLogos to generate new knowledge and share this knowledge with an audience outside their island. Kassos is a small island in the Dodecanese with a strong tradition of local music, both vocal in the form of sung poetry and instrumental in the form of playing the *lyra* (lyre). As in many rural areas of Greece, the teacher plays a central role in incorporating the local culture into classroom practice (despite the national curriculum) in the form of activities, often as a result of play performances or local holidays. The two-room school of Agia Marina, Kassos is a prime example, as the principal had already involved his students in activities such as researching the flora and fauna on

the island even before the DiaLogos project. They had a school magazine, the production of which was enhanced by means of the computer equipment made available through DiaLogos.

The English teacher who was not from the island herself was the person who was involved in the implementation of DiaLogos in the school. Initially, she was reluctant to participate and was convinced that the students could not do projects until we suggested that the students write local sung poetry and translate these poems into English for their sister class. The local history, oral stories, etc. became more significant when they were generated for an audience that knew nothing about the culture of the island. Thus, Kassos contributed to DiaLogos local oral stories such as “The Fishman and the Enchantress” and interviews of older members of the community, i.e., grandparents, fishermen, people who had immigrated to other countries and returned, etc. These activities, already carried out with their teacher in Greek, became more meaningful when they were created for students of their own age in a completely different environment, metropolitan Toronto. This student-generated writing was translated into English with the help of their English teacher and shared with others.

Many interviews took place. One example is given below (as written by the students, without corrections):

THE LIFE OF MY GRANDFATHER  
AT SEA

INTERVIEW: IOANNI DIM. EROTOKRITOU (GRADE 5)

IOANNIS: How was your life at sea, grandfather?

GRANDFATHER: Life at sea was very difficult.

IOANNIS: What was your job exactly?

GRANDFATHER: The captain gave us any job there was available, there were not many jobs then and we were in great need.

IOANNIS: How much money did the captain give you?

GRANDFATHER: We got paid every 6 months because there was a big economic crisis. I was 25 years old when I went to sea.

IOANNIS: When the crisis was over how much money did you get?

GRANDFATHER: We got 5 pounds every month.

IOANNIS: Was the captain strict? How many years did you stay in sea?

GRANDFATHER: The captain was very strict. I stayed 30 whole years in sea.

IOANNIS: How many people were on board?

GRANDFATHER: We were 60 people.

IOANNIS: When did you stop travelling and why?

GRANDFATHER: After 30 years because we shipwrecked and we were in great danger. Many hours later they came and saved us.

IOANNIS: What else do you remember from your life?  
GRANDFATHER: Once we caught on fire in Venice. Fortunately they towed us out and they saved us.  
IOANNIS: Did you like life at sea?  
GRANDFATHER: It was very tough but I had the opportunity to meet new people and discover new places. We went to England, America, Spain and other countries.

#### 4.3. Creating Literature

Evgenios Trivizas, a well-known Greek writer of children's stories, was asked for permission to use one of his stories for DiaLogos in order to foster sister-class collaboration on a joint project and creative expression through creative writing. Mr. Trivizas graciously went further to give us a handwritten introduction to a story, which he had just begun and had not completed. This introduction was translated into English and was circulated in Greek and English to all the schools via e-mail with directions to the teachers and students on how it could be used. The students were to continue the story in any way they wanted and were to decide on joint endings with students in their sister classes.

The story dealt with a grouchy man, Mr. Stripsidis, who sent away different animals who came to his home for protection. Thus, there was an element of dialog repetition each time a new animal came into the story. This repetition helped students construct their story endings by basing new dialog they wrote on what had already appeared. There was also a problem to be solved. Finding an ending meant finding ways of negotiation between the man and the animals. Students had to also collaborate with members of their sister class on a joint ending. The Greek students were encouraged to use the target language (English) but were free to use their first language when needed—or they could even use both languages in the same text.

Each class in Greece was divided into smaller groups of two or three students who jointly worked on the activity. In the traditional Greek school setting, collaboration of this sort was something new and unfamiliar to the students. In the end of the year interviews, both students and teachers stated that they rarely participated in group work, except for the DiaLogos project. The collaborative group work served as support for the students who were at different levels with respect to knowledge of English. However, it also posed difficulties in the beginning, as students were not familiar with this type of negotiation and collaboration.

In order to assist the students in a new task of this sort, three external experts were available, both in person and electronically: (a) a literature/language advisor, (b) a technical advisor, and (c) a creativity advisor to give students ideas. The literature/language advisor read all the texts the students wrote and answered each student individually, mostly to give the students encouragement.

As part of the communication between the sister classes, some of the students asked for information from their sister classes in order to complete the story. For example, students in Rhodes wrote to their sister class in Toronto and asked for information about the raccoon, as they wanted to use this animal as a character in their story. They knew that raccoons existed in Canada but did not know anything more about them.

### Letter from Greece

Dear friends from Diefenbaker class,

We are team E in Class E3 from Rhodes. Our names are Vivian, Alik, Eleni and Michaela. We are working on the project with Triviza's story and we need some information about Canadian animals. We want to add a raccoon to our story. Vivian has seen a raccoon in Canada because she was born in Toronto. Can you tell us where a raccoon lives? What kind of food do they eat? Are they good or bad animals? Bye.

[from E3 Rhodes]

The students responded with letters such as the letter below and suggestions on web sites to visit.

### Reply from Canada

Raccoons live in North America. They live in the forest, cornfields and make their homes in a hollow tree called a den. Raccoons eat frogs, fresh fish, mice, insects, fruit, birds, corn and their favorite food is crayfish. Raccoons are curious, mischievous and annoying. But they don't make good pets.

The information exchanged also dealt with language. In the letter below, one student asks, "How do we say *kakarizo* (the sound of a chicken) [in English]?" and "How do we say *sthrouthokamilos* (ostrich)?" Another student asks (in the student's own words) "What is a sound of a cat? [what sound does a cat make?]".

### Letter from Greece

Letter from E3 (Rhodes) to the Diefenbaker P.S.

Dear children,

We are trying to write the story of Evgenios Trivizas. Do you know things about him.

We will try to bring information about him. Spiros from D team asks how do say “kakarizo” (the sound of a chicken)?  
How do we say “strouthokamilos”?  
Maria S. from team F asks what is a sound of a cat.  
Bye for now  
Write to us soon to see what you are doing.  
The E3 class

In the letter above, it is clear that the students were exchanging information about the author. In other letters, information about the author was circulated and students in Greece who were more familiar with the author’s work made suggestions about further reading of his books.

The way the students used the bulletin board on the web site was significant. Although the bulletin board was designed only for story endings, the students used it in a way that had not been planned. They used the window to send corrections to the web master. This illustrates how conscious the students were of having their work published and read by others. The text was treated as an *improvable* object. Whereas in traditional classroom settings, corrections on assignments handed to the teacher are not viewed as particularly important by students, corrections on the web page were of vital importance to them. In fact, students became impatient when the web master took too long to make the corrections they requested.

Editing dealt with the content of the story as well as with the correctness of the form. The students often wanted to make changes in their stories, even a long time after they had written the original version. Although the activity was begun in the first year of DiaLogos’ implementation, editing of the texts went on throughout the 2 years. The students often went back to the texts, adding information and making changes. The students’ sustained interest in one particular text was very unusual.

The story, originally in Greek, became bilingual, as the contributions written by the students were in English and Greek. Eighty different stories were written. Fifty-nine stories were written by the students in Greece (35 stories in Greek and 24 in English) and 21 stories were posted on the bulletin board from students in Canada (9 in Greek and 12 in English). Some texts included both languages, reflecting students’ attempt to use the target language. It is evident from the level of Greek of the students in Toronto how hard they tried to write in Greek. They often used English words to express what they could not express in Greek. The students were not confined to only the standard forms of the languages, as is usually the case in school. They used words and expressions that were closely tied to their identity. For example, the Greek–Canadian students in Toronto often used words characteristic of the Greek–Canadian

lexicon such as “tzara” (written in Greek) for the word “jar”. The students from Canada also used words that the students in Greece would not normally come across in their English books (which contained only standard English) such as “zapped him”. It is interesting that the students learned the form of the target language that the members of their sister class were using. For example, when one of the students in Canada used the expression, “So, it is cool”, a student in Greece not only figured out the meaning of this expression, but also used it in communication with the sister class.

#### 4.4. Acting on Social Realities: *Ancient Rhodes*

The catalyst for the project on Ancient Rhodes was letters sent from Canada, asking for information about Ancient Rhodes. An (uncorrected) example is given below:

Hi, my name is Michael. Did you get  
my letter that I wrote to you?  
Do you have any information about  
ancient Greece. If you do can you  
please tell my!

In order to provide information, the students from one school in Rhodes began conducting research (in English class) on their own island and the areas around their homes and school. As the curriculum in Greek schools is specified by the central government and all textbooks are the same across regions, regional history is not taught as a specific subject in school. In some cases, if appropriate, it might be taught as part of the national history. The students began conducting their own research and embarked upon a project that was entitled *Ancient Rhodes*. In order to help students (and teachers) to carry out this research, a learning packet that outlined processes and strategies for carrying out critical research was prepared. The seven phases, summarized below, were articulated and discussed with students (Kourtis-Kazoullis, 2002).

##### 4.4.1. Structuring Critical Research

#### **Phase 1: Setting questions**

What do we want to know?

#### **Phase 2: Using what we know and what others know to construct new knowledge**

First we begin with what we already know. Once we utilize what we already know, we can gather new information.



**Phase 3: Gathering information**

**a.** Finding information (both from our own environment [e.g., local archeological sites, museums] and from other sources such as textbooks, the internet, teachers, experts, etc.).

**b.** Taking notes.

How do we record the material we find?

**c.** Documenting our work.

How do we state where we found the material?

**Phase 4: Critically viewing our topic**

What viewpoints are represented in the material we found?

**Phase 5: Production as process not as a static product**

When we write our articles we understand that we can change, elaborate, and improve the text at any time either by ourselves or with members of our group

**Phase 6: Sharing our ideas with others both orally and in written form**

Our articles can be shared between students, classes and schools, sent by e-mail to the sister classes and published on the web page.

**Phase 7: Critically viewing our work with others**

When we share our work with others, we can critically view our work by asking for other opinions and discussing issues with others.

Although learning rarely takes place outside the classroom in the normal school setting, the students of DiaLogos took part in critical research that went beyond the four walls of the classroom. They went to the archeology department and interviewed archeologists, visited the museum (many of the students for the first time) and a special exhibition commemorating the 2400 year anniversary of the establishment of the city of Rhodes, and they documented archeological sites in their village. They were surprised to find that there were archeological sites very near their school and that there were artifacts in the museum found on a site very near their school. They were given an electronic research sheet that guided them through different internet sites that would be used to collect information. One activity involved taking an electronic quiz dealing with archeology on a U.S.-based archeological web magazine called *Dig Magazine*. A high mark on this quiz would give the students the title of “honorary archeologist”, a title that they were eager to get as a result of the visit to the museum and their resulting interest in becoming archeologists. As most of the questions, surprisingly enough for the students, related to Greek culture, they were sure that they would do well. When the students answered the following question in this quiz, they were surprised to find that their answer was labeled incorrect:

**2. The marble figures and sculptures from the Parthenon in Greece, but have been owned by Britain since 1801, are called**

- a. The Parthenon facts
- b. The Greek Relics
- c. The Elgin Marbles
- d. The Olympic Artifacts (Dig Magazine, 2000, quiz 6)

Most of the students answered (a) as they knew that the marbles were from the Parthenon. However, this response evoked the following feedback:

***Your answer for question 2, Parthenon, is WRONG!  
The answer is c, the Elgin Marbles. The marbles were taken by a British ambassador named Lord Elgin in 1801 when Greece was ruled by Turkey's Ottoman Empire***

This had the effect of encouraging the students to take the step from inactive observers to active participants in critical inquiry. What gave them this strong incentive to take action was the mismatch between the information supplied on the electronic quiz and their own image of Greece and their place within Greece. They decided to research the topic, write to the editor, and argue their point. This action may seem like a very small step; however, it was a major step for these 10-year-olds. These *small* students from a *small* island in a *small* country, speaking a *small* language took a big step into the world far beyond their classroom to *battle* with the editor of a *large* educational magazine from a *large* country with a *large* language. They might never have taken this step if they had not felt that someone else was teaching them incorrectly about their *own* identity.

The students, with the help of their teacher, wrote and sent the following letter to the editor:

#### **Correspondence 55: Letter to editor**

At 10:02 AM +0300 5/9/00, *DiaLogos* Schools wrote:  
—Original Message—  
From: *DiaLogos* Schools  
To: 'editor@dig.archaeology.org'  
Sent: 9/5/2000 9:55•I  
Subject: Letter from Elementary School in Kremasti, Rhodes Greece  
Dear Editor,  
We visited your site and enjoyed it very much. We learned a lot about archeology around the world and recognized a lot of familiar things from Greece. However, there was one part which we disagree with. One of the questions on the test refer to the marbles from the Parthenon as the Elgin Marbles. This is what we have to say:

«In Ancient Greece there was a building called the Parthenon. They began building it in 447 B.C. and finished it in 432 B.C. It was made to honor the Goddess Athina and was designed by the architects Iktinos and Kallikratis. But in 1820 A.D. a British diplomat who was called Elgin Tomas stole the marbles. Apparently, he did not know their historical value. He took the Parthenon Marbles to Britain and as if that was not enough today they are called the “Elgin Marbles”. The marbles were later put in the British Museum.

So, we are writing this letter of complain to you. When you refer to these marbles on you web page, please do not refer to them as the Elgin Marbles. In reality, they are of Greek origin and should be called the Marbles of the Parthenon. Elgin profited by stealing them. He should not profit by having them named after him.»

We thank you very much. We would appreciate a reply from you with your own viewpoint on this matter.

On behalf of the 6th grade class of the Kremasti Elementary School in Rhodes, Greece,

Two letters were received back from the editor and the “in-house” archeologist of the magazine. These letters noted the complexity of the issue but also acknowledged the legitimacy of the students’ concern.

In short, in the context of their critical inquiry, these students discovered that how others depict their own culture might be very different from how they view themselves. But more importantly, they discovered that they could take action and that this action could bring results.

## CONCLUSION

We have argued in this chapter that IT *can* play a significant and positive educational role, but only if its pedagogical possibilities are clearly understood. For school-age students, IT is minimally useful as a pedagogical tool when it is assimilated into a rigid top-down teacher-centered textbook-oriented curriculum. It may do little more than the worksheets of old, at considerably greater cost. However, when IT is integrated into a more dynamic and socially transformative pedagogical orientation, it has enormous potential to promote academic language learning, thinking and problem-solving abilities, imagination, and affirmation and expansion of student identities. This orientation will not eschew transmission of information and skills. However, it will go beyond transmission to include collaborative construction of knowledge and the encouragement of social critique as important learning goals. Unfortunately, current trends in many countries with respect to pedagogy in general and IT in particular reflect the former one-size-fits-all pedagogical

orientation rather than the more dynamic “knowledge generation” orientation associated with a pedagogy of collaborative critical inquiry. These trends are particularly in evidence in schools serving low-income students.

The DiaLogos project has illustrated how cognitive engagement and identity investment can be increased when the power of IT is harnessed to connect students with sister classes in different cultural, linguistic, and geographical contexts. Students’ identities can be expanded when they have to define aspects of their own reality to present to the sister class and when this reality is reflected back to them through discussion and collaboration on concrete activities and projects. Literacy is expanded in the process of carrying out joint projects for the simple reason that students read more, discuss more, and write more than when they are in an isolated, contained, non-communicative classroom situation.

The theoretical framework articulated in this chapter suggests that in evaluating virtual learning environments for school-age students, we should go beyond asking whether the environment is effective and cost-efficient in transmitting information and skills. Although legitimate, these questions derive from and reinforce the normalization of transmission approaches to curriculum and instruction. Instead, we should also ask: To what extent is the virtual learning environment effective in encouraging and facilitating critical literacy? To what extent does it develop among students a greater awareness of language forms and structures, as well as an appreciation of the power of language to influence (for both good and ill) social realities? To what extent do students participating in virtual learning environments generate new knowledge, create literature and art, and act on social realities? When these questions are answered negatively, we would argue that the virtual learning environment is not living up to its potential.

The central questions for the future concern not the adequacy of the technical characteristics of various forms of IT, nor the professional development of teachers in using IT. Rather the major issue is whether as a society we are prepared to implement forms of pedagogy, powerfully amplified by IT, which can promote imagination and critical literacy abilities among students while at the same time potentially illuminating the operation of societal power relations.

#### REFERENCES

- Cummins, J. (2000) *Language, Power and Pedagogy: Bilingual Children in the Crossfire*. Clevedon, England: Multilingual Matters.
- Cummins, J. (2001). *Negotiating Identities: Education for Empowerment in a Diverse Society*, 2nd ed. Los Angeles: California Association for Bilingual Education.
- Cummins, J. & Sayers, D. (1995). *Brave New Schools: Challenging Cultural Illiteracy Through Global Learning Networks*. New York: St. Martin’s Press.
- DiaLogos. (2003). Retrieved June 2, 2003 from: [www.rhodes.aegean.gr/gr/progra/dialogos](http://www.rhodes.aegean.gr/gr/progra/dialogos).
- Dig Magazine. (2000). Retrieved April 2, 2000 from: <http://www.dig.archeology.org>.

- Education Week (2001). *Technology Counts 2001*. Retrieved May 24, 2002 from: <http://www.edweek.org/reports/tc01article.cfm?slug=35divideintro.h20>.
- Gee, J. P. (2000). New people in new worlds: networks, the new capitalism and schools. In: Cope, B. and Kalantzis, M. (Eds.) *Multiliteracies: Literacy Learning and the Design of Social Futures*. London, New York: Routledge, 43–68.
- Gialamas, V., Kourtis-Kazoullis, V., Batsouta, M., & Skourtou, E. (2000). Systematizing bilingualism. In: Skourtou, E. (Ed.) *Tetradia Ergasia Naxou: Bilingualism* (Working Papers of Naxos: Bilingualism). Rhodes: University of the Aegean (in Greek). Available at: [www.rhodes.aegean.gr/ptde/tetradianaxou](http://www.rhodes.aegean.gr/ptde/tetradianaxou).
- Golemati, M. (2000). New technologies in education: evaluation of the current situation in Greek high schools (in Greek). Paper Presented at the *InterUniversity Centre For Educational Research (ICO) Summer School*, Rhodes, Greece, September 4–9, 2000.
- Heath, S. B. (1983). *Ways with Words*. Cambridge, UK: Cambridge University Press.
- Kalantzis, M. & Cope, B. (2000). Changing the role of schools. In: Cope, B. and Kalantzis, M. (Eds.) *Multiliteracies: Literacy Learning and the Design of Social Futures*. London, New York: Routledge.
- Kourtis-Kazoullis V. (2002). DiaLogos: bilingualism and the teaching of second language learning on the Internet. Unpublished Doctoral Dissertation, University of the Aegean, Primary Education Department, Rhodes, Greece.
- Koutsogiannis, D. (1999). Information and communication technology in language learning in Greek secondary education: preliminary expressions (In Greek). Paper Presented at the *International Conference: ICT and Language Learning: The International Experience*. Thessalonica, Centre for Greek Language, 23–26 October 1999. Retrieved March 23, 2000 from: <http://www.komvos.edu.gr/enimerwsi/synedrio/koutsogiannis.htm>.
- Kress G. (2000). Design and transformation: new theories of meaning. In: Cope, B. and Kalantzis, M. (Eds.) *Multiliteracies: Literacy Learning and the Design of Social Futures*. London, New York: Routledge, 153–161.
- Kron, F. W. & Sofos, A. (2003). *Mediendidaktik (Teaching the media)*. Muenchen: Reihnhardt/UTB.
- Manzo, K. K. (2001). Academic record. In: *Technology Counts 2001. Education Week on the Web*. Retrieved April 15, 2002 from: <http://www.edweek.org/reports/tc01article.cfm?slug=35academic.h20>.
- Raptis A. (2000). Educational policy and the introduction of new technologies to education (in Greek). In: Komis, V. (Ed.) *Proceedings of the 2nd Panhellenic Conference "Information and Communication Technologies in Education"*. Patras: University of Patras.
- Raptis A. & Raptis A. (2002). The collaborative program and its results (in Greek). In: Dimitrakopoulou, A. (Ed.) *Proceedings of the 3rd International Conference "Information and Communication Technology in Education"*, Vol. 1. Rhodes: University of the Aegean, 85–90.
- Skourtou, E. (1995). Some notes about the relationship between bilingualism and literacy concerning the teaching of Greek as a second language. *European Journal of Intercultural Studies* 6(2), 24–30.
- Skourtou, E. (2002). Connecting Greek and Canadian schools through an Internet-based sister-class network. *International Journal of Bilingual Education and Bilingualism* 5(2), 85–94.
- Skourtou E. & Kourtis-Kazoullis V. (2002). The importance of pedagogy in language learning and information and communication technology: the example of DiaLogos. In: Dimitrakopoulou, A. (Ed.) *Proceedings of the 3rd International Conference "Information and Communication Technology in Education"*, Vol. 2. Rhodes: University of the Aegean, 139–148.
- Toulasiewicz, W. & Adams, T. (Eds.) (1999). *Teaching the Mother Tongue in a Multilingual Europe*. London: Cassell.

- Vosniadou, S. (2002). Information and communication technology in education: prospects, problems and suggestions. In: Dimitrakopoulou, A. (Ed.) *Proceedings of the 3rd International Conference "Information and Communication Technology in Education"*, Vol. 1. Rhodes: University of the Aegean, 49–54.
- Vygotsky, L. S. (1978). *Mind in Society*. Cambridge, MA: Harvard University Press.
- Wells, G. (1999). *Dialogic Inquiry: Towards a Sociocultural Practice and Theory of Education*. Cambridge: Cambridge University Press.
- Wells, G. (Ed.) (2000). *Action, Talk and Text: Learning and Teaching Through Inquiry*. New York: Teachers College Press.
- Windschitl, M. (2002). Framing constructivism in practice as the negotiation of dilemmas: an analysis of the conceptual, pedagogical, cultural, and political challenges facing teachers. *Review of Educational Research* 72(2), 131–175.

## Chapter 19: Inclusive E-learning

JUTTA TREVIRANUS AND VERA ROBERTS

*Adaptive Technology Resource Centre, University of Toronto*

### 1. INTRODUCTION

It has been very convincingly argued that true innovation and the way ahead can be found at the margins of any field (Rose & Meyer, 2000). In education, accommodating learners who are marginalized by traditional education delivery has and continues to expand the boundaries of the domain and inspire new strategies and practices that benefit all learners.

Disability is a relative and therefore constantly shifting state. A learner using a wheelchair is not disabled in a lecture setting with an accessible lecture hall; a learner who does not have the requisite background knowledge is. In a learning environment disability can be defined as a mismatch between the needs of the learner and the education offered. Given this definition, disability is not a personal trait but an artifact of the relationship between the learner and the learning environment or education delivery. Most educators, given the standard constraints in time and human resources, by necessity, teach to the hypothetical norm. Learners who do not fit that norm are disadvantaged or excluded. Depending upon the teaching approach, learners who are marginalized may include for example, learners who are gifted or shy, or who have a sensory impairment that affects their ability to receive the information presented (Jackl et al., 2004).

While there is little agreement in the research literature regarding the effects of online instruction versus traditional education delivery with respect to cost; instructor time, and learning outcomes for the average student; there is general agreement that computer-mediated learning benefits the student who is marginalized or performing poorly in traditional learning environments. This benefit is attributed to the ability to customize or personalize the delivery and content in computer-mediated online education (Aragon et al., 2002).

Individual customization and optimization is a difficult task in a traditional teaching environment. Diversity of learners and learning approaches is apparent even amongst high school students and post-secondary students who have several years of pressure and socialization to conform to the norm. Successfully accommodating this diversity implies that many students must be given individual programming, that the presentation must be multimodal and the learning activities rich and varied. The most talented and experienced pedagogue has great difficulty creating an optimal learning environment for

all learners in a traditional classroom. The higher the ratio of students to educators the more difficult this challenge becomes.

Given the reframing of disability above, accessibility can be defined as the ability of the learning environment to adjust to the needs of all learners. Accessibility is dependent on the flexibility of the education environment, curriculum, and delivery, as well as the availability of adequate alternative-but-equivalent content and activities. Accessibility requires individual optimization of the learning process.

Personalization in an online environment has come under criticism recently because of the perceived effects of services such as personalized news channels that deliver only the news the user is interested in, thereby creating an insular attitude and eliminating the opportunity to expand one's views or learn about novel topics (Riecken, 2000). Personalization in the context of this chapter does not imply that the learner is only exposed to topics she is interested in or that she is only presented with learning activities that she is capable of doing and feels comfortable with. Accessible e-learning implies education delivery that optimizes learning: Including activities and materials that are sufficiently challenging to advance the learner's knowledge and skills.

An approach that grows and wanes in popularity is the creation of curriculum, course packs, lesson plans, or modifications for a specific class of learner, such as learners for whom English is a second language, learners with attention deficit disorders, or even science for girls (Alberta Teacher's Association, 2001). The difficulty with this approach is that each learner may have important characteristics that distinguish that learner from fellow learners in a specific classification. These distinguishing characteristics may be more significant in a specific context than the characteristics that qualify the learner for the classification. Classifications also encourage overgeneralization and false assumptions based upon these generalizations. Even for an individual learner, requirements regarding education delivery may change from discipline to discipline or learning goal to learning goal. Given the complexity and fluid nature of each individual's needs, customization must be at a much more granular level. The authors would contend that this customization should be responsive to each individual learner and each learning context.

E-learning or computer-mediated networked learning has the potential to deliver this level of customization. Accessible e-learning is a compelling application that provides a critical purpose for a number of emerging information technologies including the semantic web, intelligent agents, and adaptive web services. Optimizing learning for each individual learner in an e-learning environment is dependent on either or both (a) components that are transformable and/or (b) a sufficiently broad pool of alternative components combined with mechanisms for matching the appropriate components to the learner. Transformable components would include:



- User interfaces that support more than conventional input and display devices (conventional devices being the keyboard, mouse, screen, and speakers);
- content that is amenable to restyling, is sufficiently structured to allow reorganization and has adequately informative labels (i.e., metadata) to allow reuse and re-purposing;
- activities and applications that can be presented and controlled in a number of ways and can be populated with a variety of content; and
- learning or knowledge management systems that implement a variety of ontologies and rules.

If designed and implemented correctly, e-learning may effectively eliminate all barriers learners with disabilities have faced in traditional learning environments. This chapter will outline the principles, processes, and technologies that support accessible networked learning. Existing, emerging, and potential tools and practices will be discussed.

## 2. THE MANY GOALS SERVED BY ACCESSIBILITY

Accessibility is rarely a priority for e-learning tool and curriculum developers. Traditionally, accessibility has not been regarded as a consideration in the drive for profitability. People with disabilities are not seen as a large enough consumer group to wield a significant market force. Even with legislation requiring accessibility and large institutional purchasers requiring accessibility in purchasing policies (WAI, <http://www.w3.org/WAI/Policy/>), accessibility is not prominent in the design criteria of most IT products. However, accessibility is consistent with a number of other design goals and agendas that receive a higher profile in corporate strategies. When accessible design principles are followed, other positive outcomes such as interoperability, content portability, device independence (device independence refers to the ability to write content once and display it in many different devices such as cell phones, PDAs, laptops, and desktop systems), internationalization, tool and content longevity, and many other benefits are also achieved (WAI, <http://www.w3.org/WAI/EO/Drafts/bcase/>). Conversely the technologies developed to achieve these other goals can be harnessed for accessible education delivery.

Information technology tool developers have adjusted to the notion that we do not live in a uniform world. We can make very few assumptions about consumers or even groupings of consumers. Users, their hardware, their software, their networks, and connectivity are very diverse. Technologies and information technology architectures are increasingly constructed to deal with that diversity. This flexibility when properly implemented can be used to provide accessible e-learning environments.

There are significant market arguments for device independence and flexibility in e-learning delivery. Students and other consumers use a large range of devices including stationary workstations, laptops, tablet computers, PDAs, and cell phone based browsers. Each of these have different display specifications and support a different presentation mode with regard to styling and information structure. Additionally, the disparity in available bandwidth is growing as certain nations install broadband infrastructure while the majority of the world continues to be restricted to dial-up access. Balancing the demands for rich content on the one hand and bandwidth efficient material on the other becomes more and more difficult as the gap widens. Globalization creates an added demand that translatable text may be extracted from code that does not require translation. Despite pressure for uniformity from large content producers, browser developers, in an attempt to survive in a highly competitive market, strive to distinguish themselves with unique features and proprietary rendering. Content creators do not wish to create multiple versions of content but would prefer to write once and present in multiple ways. This desire to accommodate multiple devices, bandwidths, languages, and browsers also serves accessibility.

### 3. THE IMPORTANCE OF INTEROPERABILITY AND ALTERNATIVE ACCESS SYSTEMS

Interoperability specifications and standards are the information technology equivalent of the rules, laws, and conventions that govern social behavior in a civilized society. As in a society, the alternatives to following these guidelines and requirements include living as a hermit, living in isolated and insular cultures, lawlessness, the rule of bullies, anarchy and chaos. It is easy to think of equivalents to all of these in information technology environments. Hermit software applications do not communicate or interact with others. Isolated and insular community applications can only be used in a specific context, content area, or platform. Information technology bullies impose their rule not through consensus or collaboration but through the influence of power and threat. Lawlessness, anarchy, and chaos exist when applications conflict with one another, are redundant and disorganized.

Education is a social activity. Academia cannot thrive without information exchange within the institution, within the community of interest and among intellectually engaged people nationally and internationally. An information technology system or application therefore cannot be an e-learning system unless it is interoperable.

While interoperability is important for e-learning, the importance is heightened for learners who use alternative access systems or specialized devices such as refreshable Braille displays, enlarged keyboards, or voice recognition systems. Many people with disabilities are dependent on alternative access

systems to use a computer. From an information technology developer's perspective every person with a disability potentially represents an external system that needs to interoperate. In fact, because of the diversity of alternative access systems, every person with a disability potentially represents a unique external system that needs to interoperate. Thus the equivalent challenge of compatibility between a Mac computer and a Windows computer is played out with each and every learner with a disability using an alternative access system.

E-learning application developers can either provide "direct access", meaning that the learner's alternative access needs are met by the application which provides a range of alternative display and control methods, or the application must interoperate with the personal access systems the learner uses. Applications that interoperate with alternative access systems are said to be "access system friendly". The same interoperability specifications and standards that govern application-to-application and application-to-alternative device interoperability (such as interoperability with cell phones or PDAs) also facilitate access system friendliness (Treviranus & Petty, 2001).

Alternative access systems, also referred to as assistive technologies, can be grouped into alternative display technologies, alternative control technologies, and assistive processing systems (ATRC, <http://www.utoronto.ca/atrc/reference/tech/techgloss.html>). Alternative display technologies provide alternatives for anyone who for whatever reason cannot see or hear what is presented through the standard screen and audio system of a computer. Alternatives include screen readers that read or speak out the information presented on the screen, screen enhancement software that enlarges and increases the contrast of visual information on the screen, refreshable Braille displays that provide the visual information in tactile Braille form, and visual cueing utilities to replace audio. Alternative control technologies provide alternatives to the mouse or keyboard for controlling the computer. These include minor modifications to the action of the keyboard (such as providing a way of holding down modifier keys including shift, alt, or control and other keys using a single digit, or slowing down the repeat rate of a key), alternative keyboards (such as keyboards with enlarged keys, miniaturized keys, alternative layout of keys, or alternative key actions), on-screen keyboards with switch input devices that allow input using as little as a single voluntary movement, coded input systems (such as Morse code systems) and voice recognition systems. Assistive processing systems help to organize or translate information into forms that are more suitable for the user or speed up input. These include prediction programs such as word completion programs, symbol input or display systems, and abbreviation-expansion programs. A large number of printed and web-based references exist describing these technologies (ABLEDATA, <http://www.abledata.com/>).

Because each user with a disability must access a number of frequently changing applications, the alternative access system must communicate effectively with all popular generic applications. Given the unfortunate dearth

of “access system friendly” applications, the burden of interoperability frequently falls upon the assistive technology developer. These are usually microcompanies that are addressing the needs of a tiny niche market and are therefore poorly resourced to tackle the complex design task. They are further challenged by uncooperative generic application developers who refuse to give them access to proprietary software design information needed to enable effective communication between the alternative access system and the application. The current conventional assistive technology business model is problematic. People with disabilities or their agents are presently the clients of assistive technology developers and bear the cost of interoperability development. However, e-learning application developers are compelled by law and by institutional purchasing requirements to provide accessible applications. If these e-learning application developers engage assistive technology developers to, in essence, assist them in meeting their accessibility commitments by creating alternative access systems that interoperate with their application, a more sustainable business model would be established. E-learning application developers would be more inclined to cooperate and collaborate with assistive technology developers. This would reduce the cost of interoperability development and lead to more efficient and effective assistive technologies. However widespread transition to this business model will require significant government intervention.

#### 4. TWO APPROACHES TO ACCESSIBILITY

There are essentially two approaches to providing accessible learning resources. The approach most commonly used at the moment can be called the “accessibility compliance approach”. Using this approach the education provider attempts to create a single resource that is accessible to everyone. In most cases this resource would meet accessibility guidelines such as the W3C WAI Web Content Accessibility Guidelines ([www.w3.org/WAI](http://www.w3.org/WAI)), described later in the chapter) or the US Rehab 508 Act (WAI, <http://www.w3.org/WAI/Policy/>). Over the past 5 years educators and students have identified a number of problems with this approach (Jackl et al., 2004). Among the problems noted are: (1) Most educators have little time to prepare curriculum or learning content. It is unrealistic to expect every educator to gain the expertise required to adhere to all of the accessibility guidelines or regulations; (2) Existing resources, created prior to the compliance effort are frequently discarded because they do not adhere to the set of accessibility guidelines, even when they include learning experiences that are highly engaging and interactive for some students; (3) Learning experiences that tightly adhere to accessibility guidelines may be accessible to all students, but at the expense of not being optimal for any student; and (4) When educators feel hampered by the regulations using this approach they frequently create a

“media-rich” version as well as an “accessible” version of a learning resource or experience. Students requiring the “accessible” version are effectively segregated from their peers. The maintenance of the “accessible” version is often neglected and it becomes outdated. A more fundamental problem with this solution is that the requirements of people with disabilities vary tremendously. The notion that a single resource configuration or design can optimally meet the needs of all individuals with disabilities is seriously flawed.

The alternative approach is to create a transformable, flexible resource delivery system. This system would match the needs of the learner with the education delivered by transforming the presentation of the resource, adapting the method of navigating or interacting with the resource, supplementing the resource with learner scaffolds or alternative representations of material, re-aggregating the resource or replacing the resource with an equivalent alternative. This approach also supports cumulative authoring of learning material so that many educators can pool approaches to achieving a specific learning outcome for a diverse set of learners.

## 5. PREREQUISITES FOR CONTENT AND USER INTERFACE TRANSFORMATION

Beyond adherence to open interoperability standards, there are five basic design principles at the core of accessible design in a digital environment. These are:

- 1) Separate content and structure from presentation.
- 2) Separate function from method of control.
- 3) When this is not possible provide equivalent alternatives in other modalities.
- 4) Structure content.
- 5) Label resources.

These same principles also support device independence and effective knowledge management.

### 5.1. Content and Structure Independent of Presentation

By separating content from presentation or style, content may be transformed by replacing one style sheet or display configuration with another. This transformability can be seen when you change the display preference in your browser and view a properly created HTML or XHTML text file. The author may have viewed the file with a blue background with yellow text at a 12 pt size. The reader can choose black on white with 16 pt text size. With more sophisticated browsers the reader can also choose to have three levels of headers extracted and presented as a navigation tool, for instance. This transformation

is prevented when the author explicitly asserts details about the presentation in the content markup, or presents text as a graphic.

### **5.2. Function Independent of Method of Control**

Transformability in the user interface is achieved by making the functions independent of the control method. A simple example of this independence is a submit function in a dialogue box, when control independence is enabled more than one method of activating the submit function are available: the user can submit by tabbing to the submit button and hitting enter, alternatively by pointing to and clicking on the submit button using the mouse or by entering a key combination such as control-s. A more complex instance would be a web service with a number of possible user interfaces, for example, a digital repository of e-journals could provide an unconstrained text search or a topic index with browsing to retrieve the desired journal.

### **5.3. Alternative but Equivalent Content**

Some content cannot be transformed. The content is inextricably linked to the medium it is presented in. In these cases, equivalent alternatives of the information should be made available in alternate modalities. Captions or sign language translations would be such equivalents for auditory speech, sounds, and paralinguistic information. Audio descriptions (spoken descriptions of visual information in a video, these are inserted into the pauses in the audio soundtrack of the video), text labels or “alt-text” and long text descriptions are equivalents for video and graphics (CNICE, <http://cnice.utoronto.ca>). Thus, for example, a learner who is blind would listen to the audio description of a video, as could a learner who is reviewing an instructional video while driving a car. Similarly, a learner using a screen reader would hear text labels for images as would a learner with limited bandwidth or an alternative device that cannot process large or incompatible images.

Creating equivalent alternatives is a relatively straightforward process when the content is purely informational or even conceptual. The same cannot be said for artistic content. Art, whatever form it takes, cannot be a solitary or constrained activity. The perception, thoughts and emotions of the audience are as much the artist’s medium as the paint, the music or the dance. As such it is an unpredictable medium influenced by the myriad of experiences and the cultural contexts of the viewer. If we add interpretation from one sensory modality to another to this complex mix of interactions we can strive to provide an accessible equivalent interpretation but we can never truly achieve this goal. This difference is not a bad thing, nor does it mean that we cannot hope to provide equal access in the arts. The challenge of equivalency spurs us to

explore our perceptions, our points of view and the great diversity of the human experience as well as the core elements that we all share. We come to realize that there is no equivalency, no uniform perception, or interpretation among audience members who have no disability. This diversity can be seen as an asset, not a deficit. The question then becomes not how can someone with a disability have the same experience but how can the experience of someone with a disability be as rich and evocative as the experience of the individual without a disability. In the e-learning context, the question becomes: How can the same learning goals be met?

#### **5.4. Structure**

When viewing a web page, we do much more than simply read the page word by word from left to right and top to bottom. We approach a new document with a series of questions. These questions are answered using a number of conventions or strategies, many of which are visually based. The first question is: What is this document? We get an overall sense of the document: The topic, the scope, the format, the author's approach, by quickly glancing at the document. We also take a quick inventory of what it contains (e.g., images, image maps, forms, etc.). We get a sense of what the author feels is important by looking at the formatting or other graphical conventions. Concepts or points are communicated or illustrated through pictures, videos, or graphs. We determine what we can do with the document by noting items like forms or links. We assess whether the document contains anything that interests us by scanning the document for key words or graphics. We answer the question "where can we go from here" by noting links. While reading the document, we get a sense of the organization or structure of the document, and the emphasis intended by the author, by noting the format and layout. The visually communicated structure also lets us quickly locate specific sections of the document (Treviranus, 1997).

For many computer users this same information must be gleaned by listening to a synthesized voice that reads only text. In North America, screen readers are the most popular computer access systems for people who are blind. Screen readers present aurally, information that is visually presented on the computer screen. Translating a rich visual environment or document into the audio channel is very difficult. The primary constraint is that, while we can process many pieces of visual information virtually simultaneously, the aural channel is largely serial. When information is spoken using a voice synthesizer, information can only be presented one piece at a time in a linear or serial fashion.

Web pages rely heavily on graphic devices or conventions, spatial layout, icons, pictures, video, and animation to communicate information. Multiple pieces of information are presented simultaneously. There is frequently no

logical serial order to the information on the screen. Associations between objects are expressed through visual means (e.g., proximity, color coding, etc.). Interface consistency and predictability are not prevalent (e.g., labels for text input fields could be located above, below or to side of the input field within a single dialogue box or form). Mouse pointer actions have largely replaced keyboard commands.

Due to the evolution of the computer user interface and the digital document, users of screen readers, and other serial devices such as refreshable Braille displays have difficulty receiving the information a sighted person might glean in a quick glance. It is also very difficult to find specific information and to move from one part of the document to another. People who use screen magnifiers encounter similar constraints. The amount of information that can be reviewed at one time is very restricted. When only a small section of the screen can be seen at once, it is easy to miss dialog boxes that pop up elsewhere, it may be hard to determine the relationship between objects, it is also very difficult to locate specific objects on the screen.

A number of these problems can be addressed by properly structuring a document using standard structural markup (e.g., HTML, XML). When a document is structured correctly, a learner with a serial browser can obtain an overview by quickly reviewing just the level one headers for instance. It also becomes much easier to navigate to a specific section of a page. Emphasis and importance can be derived from the placement in the heading structure hierarchy. The document can be virtually compressed to show only high-level elements. The document is also more amenable to logical reorganization and personal annotation.

### **5.5. Labels**

It is very difficult to supply the learner with resources that meet their learning needs if the resources in the resource pool do not have informative labels or metadata. The likelihood of a possible match increases as the pool of resources increases but so does the importance of accurate and informative metadata.

These labels should give information that is relevant to the variety of characteristics a learner may be looking for. Among the questions the labels should address are:

- what is needed to access this resource,
- is this resource amenable to transformation,
- what are the learning goals or objectives this resource addresses?

The more descriptive information available (preferably in machine readable form) about the resource, its usage, and its evaluation, the easier it becomes to deliver accessible content to each learner.



## 6. WEB ACCESSIBILITY INITIATIVE

The Web Accessibility Initiative (WAI) of the World Wide Web Consortium (W3C) has produced a number of guidelines that govern accessibility on the web (<http://www.w3.org/WAI>). These guidelines also form the basis of legislation, policy, and regulations in many countries and jurisdictions. There are three sets of guidelines: The web Content Accessibility Guidelines (WCAG) that provide guidance in making web content accessible, the Authoring Tool Accessibility Guidelines (ATAG) that provide guidance in making an authoring tool accessible and in developing an authoring tool that produces accessible content, and the User Agent Accessibility Guidelines (UAAG) that provide guidance in developing browsers, players, and viewers that are accessible. These guidelines provide the groundwork for inclusive design in a web environment.

### 6.1. Evaluation and Repair Tools

A large number of tools exist to assist in complying with the WCAG (<http://www.w3.org/WAI/Resources/#er>). A content author can evaluate web content using these tools to determine whether the checkpoints of WCAG have been followed. The tool identifies any known problems, and generates a list of required changes. The tool applies a set of software-based algorithms, however a large number of checks cannot be performed without the aid of human judgment. To complete these checks the tool would guide the user through a set of questions. Some tools also provide step-by-step and semiautomated assistance in repairing any accessibility problems (<http://www.w3.org/WAI/ER/existingtools.html#Repair>, <http://aprompt.snow.utoronto.ca/>).

There are several drawbacks with these tools. One drawback is the lack of consistency in interpreting the checkpoints from one tool to another. Also, the tool, by nature of its design, cannot provide a holistic evaluation of whether the content meets the intention of the guidelines. Authors or evaluators frequently rely upon the tools alone rather than also using their better judgment to determine whether the site achieves the goals of the guidelines. Lastly the checking and repair happens once the content has already been created and the mistakes have been made, requiring much more effort than if the mistakes had been prevented.

### 6.2. The Importance of Authoring Tools

Very few educational resource authors are aware of accessibility guidelines or knowledgeable in accessible authoring practice. Many do not see accessibility

as a priority when creating e-learning resources. Most, however, use some form of authoring tool to create online resources (i.e., web editing tools). The prevalence of inaccessible e-learning content will not be effectively addressed through education and advocacy or through compliance evaluation programs. Not all authors need to know the technical minutiae of accessible authoring practices, as all authors do not need to know about HTML to author web content. As discussed above, conformance testing occurs after the fact and is therefore an inefficient method of creating accessible online learning resources. The best and most efficient strategy for insuring that educational curriculum online is accessible is to broadly implement the use of authoring tools that create accessible content. This practice would ensure that even authors who are not knowledgeable about or motivated to create accessible content do so unconsciously. Accessible authoring would also be an integrated part of the process rather than an afterthought, reducing the time required to repair accessibility problems. This integration can be done by mandating or promoting the use of authoring tools that are compliant to the W3C WAI Authoring Tool Accessibility Guidelines (ATAG) (Treviranus et al., 2000).

## 7. “ACCESSFORALL” SPECIFICATIONS

The “AccessForAll” specifications of the IMS Global Learning Consortium (<http://www.imsglobal.org/accessibility>) build upon the WAI guidelines and support the second approach to accessibility or an approach that dynamically matches education delivery to the needs of each learner. The “AccessForAll” specifications consist of two specifications: One to describe the needs of the learner and the other to describe resources so that they can be matched to the learner needs. The “AccessForAll” specifications have been proposed and are making their way through the adoption process as ISO/IEC international standards for accessible e-learning (<http://jtc1.sc36.org>).

### 7.1. Describing User Needs and Preferences

The first of the “AccessForAll” specifications is the ACCLIP (Norton & Treviranus, 2003), a common structured language for describing the needs and preferences of the learner. The ACCLIP allows learners to declare, in a machine readable form, how they would prefer or need information to be presented, how they need or prefer to control the application and what alternative or supplementary resources they want or need. A single learner can have multiple preferences or ACCLIP records each for a different context. Thus a different preference record can be used in the morning than is used at night when the person is fatigued or at school versus at home where the internet bandwidth is lower. The learner is also able to specify generic settings

for a class of alternative access systems (e.g., the speech rate for any available screen reader) in addition to specifying a brand of technology and settings specific to that technology. This allows graceful degradation of functionality if the desired application brand is not available.

The ACCLIP is divided into three main sets of elements: Display, control, and content. Display refers to the appearance of the content and user interface and may, for example, include specifications for text size and color. Control refers to how functions in the interface and application will be activated by the user and enables the user to specify alternative ways to control the device such as keyboard rather than mouse control. Content refers to the kind of information that is displayed. Under the content choice of ACCLIP, users may specify preferences for alternative content such as text instead of graphics or for other equivalent content needs such as captions for any audio. ACCLIP supports the broader conception of disability discussed earlier. The specification is intended for all learners who may have diverse preferences based on learning approach, environment, learning context, device constraints, or disability. Unlike other applications, a learner does not identify a disability, they merely state functional requirements regarding the e-learning delivery system.

Learners or their assistants would create an ACCLIP record using an online questionnaire, also referred to as a “Preference Wizard”. By answering a series of guided questions, or checking off options, a portable record would be created. This record can be read by any “AccessForAll” compliant application such as a Learning Management System, a personal web portal, a digital repository or a multiuser workstation in a library, a computer lab or an internet café, for example. The record can be stored and taken from application to application on a smart card, a USB storage device, a disk drive, or stored on a networked server. The learner would in essence be carrying their preferred and familiar computer, application and learning content configuration with them from one application to the next.

## **7.2. Requirements for Making the Match**

E-learning systems can respond to a learner’s preferences as stated in an ACCLIP record in a number of ways. Possible methods of meeting the learner’s stated needs are:

- configuring the operating system or “system preferences” (e.g., visual signals rather than system sounds, higher speaker volume),
- configuring the application or browser settings (e.g., larger text fonts, larger buttons),
- restyling the content (e.g., using Cascading Style Sheets, CSS, or XSLT),
- launching and configuring alternative access systems (e.g., text to speech systems),

- supplementing the content with additional information (e.g., definitions, caption files), or
- replacing the resource with an equivalent resource that meets the access needs of the learner.

In order to accomplish the last two methods, learning resources must be described or cataloged so that they can be associated with each other and matched to a learner's preferences.

### 7.3. Describing the Learning Resource Characteristics

The learning resource description mentioned above can be found in an interoperability specification referred to as ACCMD or IMS Accessibility Metadata (Jackl et al., 2004). ACCMD is a common language and information model for describing characteristics of a resource that facilitates matching the resource to a learner's ACCLIP preference statement. The ACCMD divides learning resources into two categories: Primary resources and equivalent alternatives. The majority of learning resources or the default resources created by educators or curriculum producers are primary resources. Recognizing that most developers of digital resources complete metadata records with reluctance and that many of the metadata elements are misinterpreted by authors of metadata, the workload of the creator of the primary resource's metadata is kept as light and simple as possible. The primary resource metadata consists of:

- 1) A statement about the flexibility of the resource presentation and method of control. In other words, can this resource be restyled, and can it be controlled using devices other than a mouse? This can be described using the output of common accessibility checking tools (encoded in an Evaluation and Repair Language, EARL, Resource Description Framework, RDF, statement). The implication is that this can be created and attached to the resource automatically in a properly constructed authoring tool.
- 2) A statement about the access modality the resource is presented in. This describes whether vision, hearing, text literacy, or touch is required to use the resource.
- 3) A pointer to the location of any known equivalent alternatives. For example, if the resource is a video, is there a known caption file or description file somewhere?

The second class of resources is called equivalent alternatives. Equivalent alternatives are replacements or supplements for the primary resource or part of the primary resource. These alternatives address accessibility problems a learner may have with the primary resource. The equivalent alternatives would communicate the same information, teach the same lesson or meet the same learning objective as the primary resource. This information or lesson would

simply be communicated in a different way. Equivalent alternatives include caption files for audio information, audio descriptions for the visual elements of video, interactive activities that can be controlled using a single movement to replace an activity that requires a mouse, image intensive communication of a concept to replace dense text, bilingual presentation of a story rather than a purely English rendition of a story, to name a few. The ACCMD records for equivalent alternatives would point to the primary resources they are a replacement or supplement for and they would also describe the resource using the same terms as user preferences are described in the ACCLIP. Equivalent content is usually described in some detail. It is expected that the creators of equivalent alternatives and their metadata will be aware of accessibility needs and motivated to provide the details needed to ensure users can locate the equivalent resources. An equivalent alternative need not have been explicitly created to replace or supplement a primary resource. An educator can create an equivalent alternative resource record after the fact as it were, if they feel that one resource is a good alternative to another. Primary resources may also contain their own equivalent alternative resources in which case they would have both primary and equivalent alternative metadata records.

Most resources on the web consist of multiple objects combined into what are commonly known as pages. Sometimes this is captured in a single static version of the page and sometimes it is dynamically generated each time a page is visited. The AccessForAll approach assumes that the objects that comprise the version of the resource that is sent to the user need not be located in the same place, that is, they may be distributed. In fact, the original composite resource may contain objects that need to be transformed, replaced, or augmented; the equivalent objects used for replacing or augmenting may have been created in the original authoring process, or in response to some other user's difficulties with the original resource.

The "AccessForAll" specifications have been implemented in a variety of systems internationally. These systems include learning management systems, personal portals, public multiuser workstations, digital library portals, and Learning Object Repositories (LORs). One such implementation will be described in detail in a subsequent section.

## 8. COLLECTIVE RESPONSIBILITY AND POOLING OF RESOURCES

The approach to accessible e-learning delivery supported by "AccessForAll" encourages cumulative or collaborative creation of curriculum. The teacher who creates the original curriculum need not be the one who creates an all-text version or a reduced reading level version for example. To respond to the broad diversity of learners and provide a rich and engaging learning experience for all learners it is only logical to pool resources and to distribute the task of creating equivalent alternatives.

It has become far easier to provide equal access to curriculum for students with disabilities in a digital environment. One compelling example of this is in the area of geography instruction. Prior to digital curriculum, maps were communicated to students who are blind using physical models made of plywood, Styrofoam, string, and other tactile materials. Given the density of information in even a grade 4 atlas for example, the physical models needed to communicate the information in a single atlas would fill an entire classroom from ceiling to floor and wall to wall. The task of shipping and storing these models would be daunting. In a digital environment, these models can be created virtually. Spatial information can be communicated through speech, real world sounds, and through haptics or force feedback devices. “Haptics” is a term which encompasses both the sensing and action involved in touching and manipulating. Haptic devices are computer peripherals that make it possible for users to “touch” objects presented on computer displays as if they were real physical objects. This is done by simulating the forces that one would feel when touching a real object and presenting these forces to the user by using the force and tactile feedback capability of a haptic device. When done properly, this creates the illusion of “feeling” an object. Thus, students are able to feel shapes that represent geographic artifacts such as cities, rivers, mountains, railways, or other objects; the volume and location of real-world sounds helps them judge the proximity to geographic objects. For example, from an associated tone which occurs when they encounter a city on the map, they will be able to determine the approximate size of the city (see Figure 1). For example, a student will hear a real world sound associated with a city as they approach a city. The location of the city will also be marked by a haptic artifact. By pressing on the city they will hear the name. The student can choose to zoom into a specific location and query a large database of associated geographic

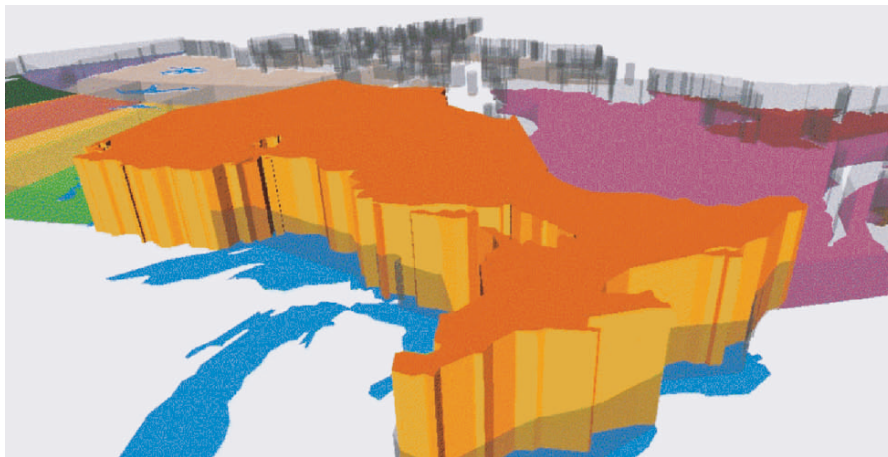

*Figure 1. The shape of a province is raised in a computer rendering so that it can be felt using a haptic device.*

data. To review the boundaries or shape of a geographic structure, such as a province, the student can choose to raise the structure so it can be examined using the haptic device (See Figure 1). If they want information on scale or relative location they can turn on a haptic grid of latitude and longitude lines which may feel like a number of strings or elastics strung over the map. Once these multimodal virtual maps are created they can be broadly distributed or accessed from a networked server.

Aside from these advanced technologies to support equal access there are other compelling reasons for educators to pool resources and to view the creation of accessible curriculum as a collective responsibility. A common phenomenon in North American education systems over the last decade appears to be the steady erosion in time to prepare curriculum. This is extremely frustrating for educators who recognize the diversity of learner needs and wish to apply learner-centric approaches to education. Despite constraints on time, content is frequently created for one learner or one class at a time. If this effort is pooled among educators, tutors, facilitators, or mentors within a disciplinary domain, contributors can collectively create a source of rich, creative, and diverse content that is responsive to the diversity of learners. If the pooled resources are authored correctly they can be amenable to the adjustments needed to re-purpose or reuse them in different contexts, with different learners.

## 9. LEARNING OBJECT REPOSITORIES AND “ACCESSFORALL”

One response to this need to pool resources is the development of Learning Object Repositories. LORs are digital repositories that provide support for pooling and sharing learning resources across members or participating communities (Wiley, 2000).

Creating curriculum for a single application or class must differ from creating it for a potential pool of users. The definition of a learning object espoused by each repository defines what can be submitted to the repository and how it should be structured or packaged for more general application. There is little agreement on what constitutes a learning object. In fact a great deal of academic debate has been devoted to defining learning objects (Wiley, 2000). The primary goals of this debate have been to determine what qualities of a learning object will make it most reusable and re-purposeable. Among the characteristics under dispute is the granularity of the object, whether there is an integrated learning design or learning objective (Koper et al., 2003), and whether roles and responsibilities should be described. Is a picture of a tree frog a learning object or must there be an associated learning goal? The approach made possible by “AccessForAll” compliant technologies presents a new perspective on this debate. Given this perspective, size does not matter

in determining the most re-usable or re-purposeable learning object as long as:

- the object is sufficiently structured so that content in different media can be separated and supplemented or replaced,
- the presentation or styling is independent of the content and structure so that the presentation can be replaced, and
- the method of controlling interactive components is flexible.

This allows the transformation of learning objects to meet the individual needs of learners in various contexts. What is promoted is not a granular but a layered approach to structuring learning objects in which the presentation layer can be wholly or partially replaced. This requires a considerable paradigm shift for educators and producers creating learning objects who frequently consider the presentation as an integral part of the content or objective. However this layered approach helps to achieve the goal of reusability and re-purposeability because it promotes a learning object that is more amenable to localization, institutional branding, display on a variety of devices, and interface consistency within a diverse set of reused objects. It can be argued that this is a necessary paradigm shift not only to achieve accessibility but also to achieve the primary goals of LORs.

Existing LORs differ greatly in the pedagogical philosophy supported and the functionality with respect to re-purposing. LOR functionality can be divided into three levels. The first level offers sharable learning objects. At this level the LOR has the functionality of a library. The learning objects are retrieved and used as they were checked-in by the original contributor. The structure of the learning object and the LOR architecture do not support their deconstruction and re-purposing other than to accommodate alternative hardware platforms. Most LORs in Canada and elsewhere fit into this category.

However, most educators would like to customize learning content to their learning context. The second level of functionality provides support for learning object re-purposing. The learning content is sufficiently structured or sufficiently granular to allow educators to swap components to adapt the learning object to a specific curriculum requirement, local context, or background knowledge. A number of LORs around the world are just beginning to explore this functionality to positive effect.

The third level of functionality acknowledges the diversity of learners and accommodates collaborative authoring among educators. The design of the LOR is motivated by the premise that each learner brings to the learning situation their own unique set of skills, background knowledge, motivations, learning goals, learning approaches, learning pace, and accessibility needs. This level of functionality supports the construction of learning content that is independent of presentation and control. It provides enough structure and granularity to allow the reassembly of learning content according to the needs and preferences of the learner. This level of functionality is supported by



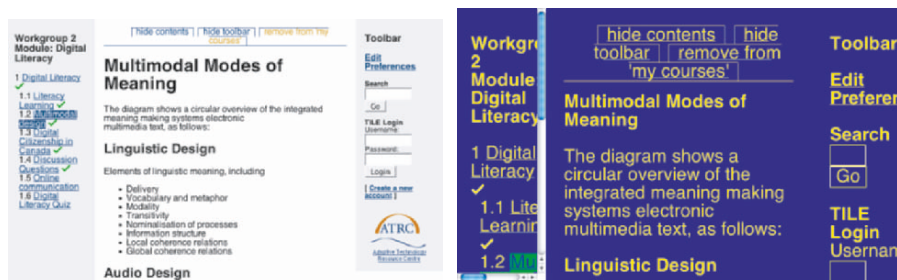

Figure 2. A simple style based transformation of a lesson page for a learner with vision impairment.

“AccessForAll” and implemented in a project called TILE or the Inclusive Learning Exchange (<http://inclusivelearning.ca>).

The Inclusive Learning Exchange (TILE) is a learning object repository developed by the Adaptive Technology Resource Centre at the University of Toronto. TILE implements both the IMS ACCMD and ACCLIP specifications. When authors (educators) use the TILE authoring tool to publish learning objects or curriculum units, they are supported in creating and appropriately labeling transformable lessons (codified by the TILE system using ACCMD). The authoring interface enables educators to assemble lesson components to form a content package in a personal “staging area” or workspace. Before the content is uploaded to the learning object repository, metadata is collected at the component and package level through a series of dialogues. Accurate and complete metadata is crucial for the successful search, retrieval, and customization of content by the learner. In order to reduce the demands on the author, metadata collection is automated whenever possible. In the same way accurate metadata is crucial for meeting learner needs, it is also vital to a thriving and active learning object repository where content is routinely deconstructed and its activities, media, material, and assessments used in different ways across multiple subject areas. Learners using the system define their user preferences, which are stored as ACCLIP records. TILE then matches the stated preferences of the user with the desired resource configuration by transforming (see Figure 2) or re-assembling the lesson.

The TILE system was implemented in a multisector national partnership in Canada to deliver learning resources to learners from elementary school, high school, university, and learners engaged in life-long learning programs. The TILE repository contains over 2370 learning objects. The project successfully investigated potential structures for accessibility metadata and acted as the test bed for ACCMD. The project also explored new ways of thinking about learning content through a series of community events across Canada referred to as TILE Potlucks. Through these collaborations with educators, and content producers from a variety of domains, the concept of deconstructing, re-purposing, and transforming learning objects was explored. At one

potluck, participants demonstrated that activities could be decoupled from content and re-purposed across multiple subject areas. This decoupling represented a shift in the way we normally think about learning objects (Figure 3).

One concern expressed by educators in the TILE project and discussed by Donald Norman is the risk inherent in using modular, re-usable learning objects: By excessive granularity and modularity we threaten the coherency of the learning experience. Through a prior project called the Barrierfree project the ATRC re-purposed and transformed educational film holdings in large film archives into interactive hypermedia learning experiences (<http://barrierfree.ca>). The caption track of the film was used as a structure to anchor relevant learning materials such as interactive exercises, definitions, illustrations of terms, and links to supplementary material. The captions were also used to navigate through the video content to previous occurrences of a term, for example. Therefore if I was watching a video of an eminent physicist and she mentioned a concept I was not familiar with I could go back to the first mention of the concept, access a definition, illustration or discussion of the concept, or engage in an interactive exercise that illustrated the concept by clicking on the term in the text caption while watching the video. Thus, coherency was achieved by providing a coherent story line as a learning structure. TILE however, re-purposed a full range of media and content types thereby necessitating a more generic learning structure. The backbone of the learning structure provided to educators within TILE was the lesson plan or learning plan. The learning plan acted as the base structure that was populated with a number of modular learning objectives, each of which was populated with any number of content objects. The content objects included exercises, simulations, publications, self-tests, videos, presentations, or other forms of online curriculum. Given the transformability of objects in the repository a consistent style sheet was applied to all transformable content in the lesson plan for each learner, to assist in coherency.

#### 10. "A WEEK IN THE LIFE OF A TRANSFORMABLE LEARNING OBJECT"

The following use case illustrates how a single learning object would be constructed, reused and re-purposed by a series of educators implementing TILE.

Ryan, a tutor with Frontier College, an adult literacy programme, works with a learner Jim who would like to learn to use on-line banking, since the trek to the bank is difficult during the winter. Jim needs assistance in learning to use the interface, reading and comprehending the information on the screens, paying the bills that he receives regularly and keeping track of his balances. Ryan uses the on-line learning design structure

Metric Prefixes - Microsoft Internet Explorer

File Edit View Favorites Tools Help

My Tutor

Customize

Current Users:



ED RJ P/V

Chat:

<ED> I guess the most important part is remembering the structure. Which prefixes are above and which are below 1.

<RJ> I find the deka and deci to be the most difficult to remember.

<P/V> I remember by associating deci with centi which is also smaller than 1.

### Metric Prefixes

The metric system consists of base units, modified by prefixes that increase or decrease the unit value by factors divisible by 10.

Prefix	Symbol	Multiplication Factor
mega	M	$10^6 = 1,000,000$
kilo	k	$10^3 = 1,000$
hecto	h	$10^2 = 100$
deka	da	$10^1 = 10$
deci	d	$10^{-1} = 0.1$
centi	c	$10^{-2} = 0.01$
milli	m	$10^{-3} = 0.001$
micro	$\mu$	$10^{-6} = 0.000,001$
nano	n	$10^{-9} = 0.000,000,001$

Metric Prefixes - Microsoft Internet Explorer

File Edit View Favorites Tools Help

My Tutor

Customize

*measuring the dimensions of a house, but not for calculating distances between cities. In this case, we prefer to use kilometres, each of which is 1000 metres.*

Prefix	Symbol	Multiplication Factor
mega	M	$10^6 = 1,000,000$
kilo	k	$10^3 = 1,000$
hecto	h	$10^2 = 100$
deka	da	$10^1 = 10$
		$10^{-1} = 0.1$
		$10^{-2} = 0.01$
		$10^{-3} = 0.001$
micro	$\mu$	$10^{-6} = 0.000,001$
nano	n	$10^{-9} = 0.000,000,001$

Symbol Info

$\mu$  (myoo)

The 12th letter in the Greek alphabet.

Figure 3. Three methods of teaching metric prefixes according to a learners stated preferences (illustration credit: Jan Richards, ATRC).

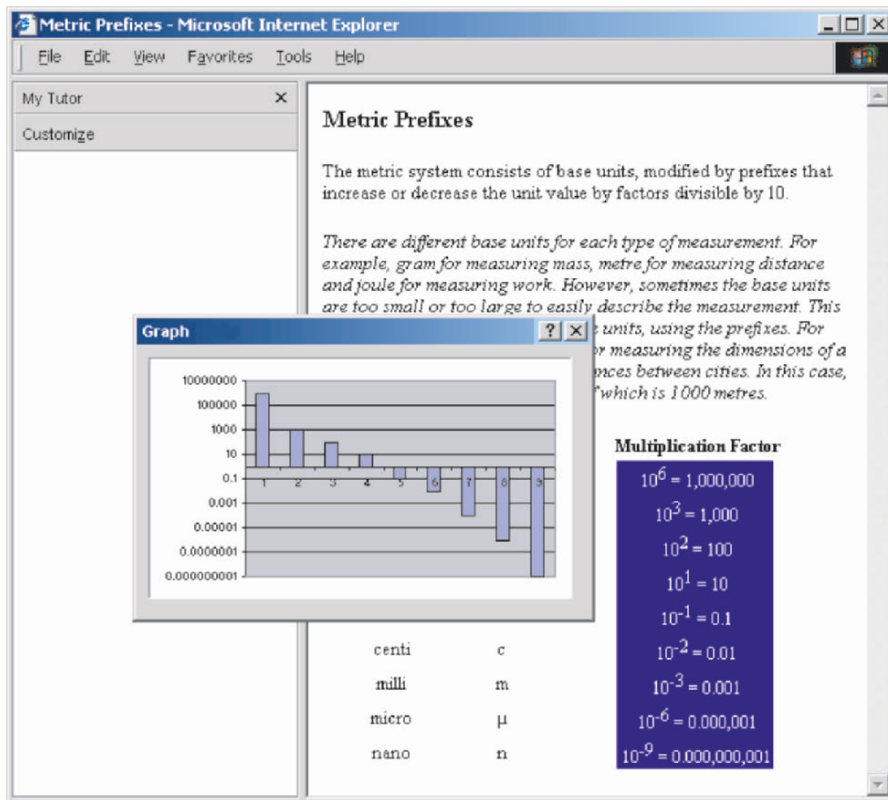

Figure 3. Continued

to specify the overall learning plan and the individual objectives. These he then populates with the actual screens that Jim will encounter at each step, his own clarifications of components of the screen, step by step instructions on how to accomplish each task, ways to recognize and correct errors, and instructions on how to verify that he has been successful. This completed assembly object or lesson is checked into the repository.

When Jim views the lesson the service delivers the assembly object according to Jim's previously expressed learner preferences. His preferences specify where, when and how clarifications, instructions, help, and self-evaluations will be displayed and how feedback will be given. Because Jim has a learning disability all text will be read to him when he points to it using his head pointer. Because he has difficulty pointing accurately all active areas of the screen such as buttons or input fields will be enlarged.

Mary is working with a learner, Fernando, who uses the same bank but has a different set of bills to pay. She checks out the lesson and replaces

the learning content pertaining to the unwanted bills with information about bills relevant to Fernando. Because Fernando is learning English and is more conversant in Spanish, Mary adds a Spanish translation of the clarifications and instructions, help and feedback. Mary also remembers a very simple-to-use accessible calculator that she has previously seen in a linked repository. She searches for it and adds a link to it. She then checks this new version of the lesson or assembly object into the repository. When Fernando accesses the lesson he reads and listens to both the English and Spanish text.

Judith is a trainer with the bank referenced in the lesson. She has just created an educational video about on-line banking. She includes verbatim captions of the video and then links the indexed segments of the video to the appropriate points in the learning plan. When Jim next views the lesson he can choose to reinforce what he is learning with the instructional video.

Alfred is a tutor working with a class who need to access the on-line banking service of another bank. He views the lesson and decides that he likes the structure of the learning plan and many of the generic explanations, but he must replace the screen shots and detailed instructions. After making these changes, he checks the new version of the lesson or assembly object into the repository.

Thus a learning object is re-purposed and collaboratively refined by a number of educators, saving educator time and benefiting a larger number of users.

#### 11. PARADIGM SHIFT FOR EDUCATORS AND EDUCATIONAL CONTENT PRODUCERS

As discussed earlier, most educators when creating e-learning content think about the presentation first. This is reinforced by the majority of software applications used to create web content. These applications usually prompt the author to choose a “look” or style for their content first before creating the content itself. The inclusive learning strategies discussed above require a paradigm shift in the way educational content online is created. Educators must first ask: “What do I want to teach, what are the learning objectives I want my learners to meet”, and then “what are the many ways or the many learning activities that can be used to meet these learning objectives”? Surprisingly this appears counterintuitive to most producers of online curriculum. These same educators will acknowledge that rich media, in most cases, plays a reduced role in learning (an exception that comes to mind is simulation-based learning). A learner engaged in active learning with little content may have better results than a learner who receives a multimedia slide show. Entertainment does not necessarily create better learning. The authoring tools used to create

online curriculum must reflect and support this pedagogical knowledge and prompt educators to consider and express the learning goals and lesson plan first. These software tools must also support the educator in creating learning content that can be restyled without losing the message or pedagogical effectiveness.

#### 12. CONTENT-FREE ACTIVITY TEMPLATES

One of the conclusions reached through consultation with educators during the TILE Potlucks was that the most valuable content for re-purposing and re-use was not, in fact content, but activities or interactive resources. Most educators can easily create static content on a variety of topics but few can control the tools or programming languages needed to create interactive applications on the web or on a computer. One of the other things discovered was that activities could be separated from content and repopulated with alternative content supporting a variety of subjects and learning goals. For example, a debate application on the web can be used to debate global warming or existentialism, a Web Quest application can be used to research math or anthropology. Subsequently, a growing pool of content-free activity templates was added to TILE. These templates were pre-configured so that the activities would adhere to accessibility guidelines no matter what content was used to populate the activities.

#### 13. OPEN ACCESS/OPEN SOURCE

In order to provide access to critical educational resources such as textbooks, learners with print impairments require access to electronic copies that can be rendered in a variety of formats. Frequently, intellectual property protection and associated copyright measures present significant barriers to equal access. In recent surveys it was found that many post-secondary students in Canada do not have access to required readings in an accessible format until well after their mid-term exams. These barriers are eliminated significantly reduced when required readings are provided in electronic format and are open access.

Similarly it is far easier to address interoperability requirements between software or web applications and alternative access systems when the applications are open source. Assistive technology development and distribution does not lend itself well to traditional commercial business models, but is driven by motivations that inspire open source communities. The trend toward a greater adoption of open source software and open access content in the educational domain has a number of significant benefits for equal access to education for learners with disabilities.

#### 14. COLLABORATIVE LEARNING ENVIRONMENTS

Real-time collaborative environments such as audio chats, video-conferencing systems, and electronic whiteboards present an extremely difficult accessibility challenge. There is no time to prepare an equivalent alternative to graphics created on a whiteboard, audio transcripts for live audio discussions or descriptions of visual information transmitted through video-conferencing. In response to this challenge, the Canadian Network for Inclusive Cultural Exchange (CNICE) has created a series of collaborative tools that support peer description and captioning (<http://cnice.utoronto.ca>). Using these tools, hearing participants in a collaborative forum are assisted in transcribing speech and sounds for fellow participants who are deaf, and sighted participants are assisted in describing images and visual information for fellow participants who are blind. In addition, the whiteboard provides a pallet of objects with associated text labels and the capability to provide a text label for a new grouping of objects. When these labelled objects are used to illustrate a point rather than free-hand drawing, a person who cannot see the images can derive meaning from the text labels.

#### 15. INTELLIGENT AND ADAPTIVE TUTORING

One technology that has the potential to deliver equal access for learners with disabilities is intelligent or adaptive tutoring systems. These systems use artificial intelligence to automatically adapt education delivery (Brusilovsky, 1996). The sequencing of activities, presentation of items and complexity of material among other characteristics are automatically adapted based upon the computers estimation of what is best for the learner. Among the artificial intelligence strategies used is the collection of performance metrics given specific conditions. These are used to create a model of each learner upon which to base design decisions: Does the learner get the answers right faster when the information is presented with diagrams rather than text, does the learner finish with a page faster when there are bold headers or teacher tips?

It would follow that these systems should be ideal for learners with disabilities. However through a series of informal trials, the authors found that learners with significant disabilities did not respond well to these systems. Learners reported that they were frustrated that they could not predict what adaptations were determined to be “good for them”, they were concerned that they were not consulted or warned by the system when shifts in the delivery happened. Learners were also frustrated with the constrained sequencing of learning activities; they wanted to give a set of explicit requests at the beginning rather than letting the system determine what is best for them. A number of individuals caused the system to create erroneous user models by exploring lessons and responses. These erroneous models made it impossible

to continue with the lesson. One learner made the insightful observation that there is so little he has control over in his life and so many people that try to decide what is good for him that he doesn't need a computer to do this as well.

Although further more formal trials are required, it would appear that in order to apply intelligent tutoring systems to assist individuals with significant disabilities, learners must be consulted in configuration decisions and these decisions should be explicitly stated. Learners should also be able to manually set the default user model including characteristics that should not be adjusted.

## 16. SEMANTIC WEB AND ACCESSIBLE E-LEARNING

One emerging technology that holds great promise for delivering learning resources that match the needs of individual learners is the Semantic Web. The functionalities foreseen in the Semantic Web would open up the potential pool of reusable learning objects to the entire web without the imprecise searching qualities of search engines such as Google.

Tim Berners-Lee (2001) describes the Semantic Web as “an extension of the current web in which information is given well-defined meaning, better enabling computers and people to work in cooperation”. The Semantic Web allows computers to determine the meaning and relationships of content on the web. By creating educational ontologies (files that formally define the relations among terms, most commonly through the use of taxonomies and inference rules) that embed the structure, vocabulary and relationships of “AccessForAll”, Semantic Web functionality can be used to accurately retrieve learning resources that meet the specific needs of the learner from the vast pool of resources that is the World Wide Web.

## CONCLUSION

By acknowledging and making room for the diversity of learners in the design of e-learning environments, we expand the possibilities and advance the field for all learners. At the same time, modifying our education practices to provide accessible learning experiences frequently prompts us to become cognizant of our teaching goals and the essence of the knowledge to be developed by the learner. It prompts us to re-learn long established “truths” about learning that have been obscured by a focus on new technologies. With dynamic networked learning environments and collective construction of resources, it is possible to optimize learning for each individual learner.



## REFERENCES

- ABLEDATA. Your source for assistive technology information. <http://www.abledata.com/>.
- Alberta Teacher's Association. (2001). Instructional Strategies, retrieved April 30, 2004, from <http://ata.iomer.com/Strategies/InstructionalStrategies.asp?id=2>.
- Aragon, S. R., Johnson, S. D., & Shaik, N. (2002). The influence of learning style preferences on student success in online versus face-to-face environments. *The American Journal of Distance Education* 16(4), 227–244.
- ATRC. Technical Glossary, <http://www.utoronto.ca/atrc/reference/tech/techgloss.html>.
- Berners-Lee, T., Hendler, J., & Lassila, O. (2001), The Semantic Web, *Scientific American* (May 20).
- Brusilovsky, P. (1996). Methods and techniques of adaptive hypermedia. *User Modeling and User Adapted Interaction* 6(2–3), 87–129.
- Caldwell, B., Chisolm, W., Vanderheiden, G., & White, J. (2003, June 24). Web Content Accessibility Guidelines 2.0, Working Draft 24, retrieved January 12, 2004, from <http://www.w3.org/TR/WCAG20/.cetis.ac.uk>. (2004, January 20). CETIS: The Centre for Educational Technology and Interoperability Standards. Retrieved April 12, 2004, from [www.cetis.ac.uk](http://www.cetis.ac.uk).
- Chisolm, W., Vanderheiden, G., & Jacobs, I. (1999, May 5). Web Content Accessibility Guidelines 1.0. Retrieved January 12, 2004, from <http://www.w3.org/TR/WCAG10/>.
- CITA. (2002). Section 508, retrieved April 1, 2004, from <http://www.section508.gov/index.cfm?FuseAction=Content&ID=3>.
- Harwin, W. S. (1998, June 23–25). Niche product design, a new model for assistive technology. Paper Presented at the 3rd TIDE Congress, Helsinki, Finland.
- Heath, A. (2003, October 27). Global collaborations in accessibility specifications. Paper Presented at the Fourth CETIS-TechDis Accessibility Special Interest Group (SIG) Partnership Meeting, Glasgow, Scotland.
- Jackl, A., Treviranus, J., & Roberts, A. (2004). IMS AccessForAll Meta-data Overview. ([http://www.imsglobal.org/accessibility/accmdv1p0/imsacmd\\_loviewv1p0.html](http://www.imsglobal.org/accessibility/accmdv1p0/imsacmd_loviewv1p0.html)).
- Koper, R., Olivier, B., & Anderson, T. (2003, January 20). IMS Learning Design Best Practice and Implementation Guide, retrieved April 12, 2004, from [http://www.imsglobal.org/learningdesign/ldv1p0/imslld\\_bestv1p0.html](http://www.imsglobal.org/learningdesign/ldv1p0/imslld_bestv1p0.html).
- Norton, M. & Treviranus, J. (2003, June 18). IMS Learner Information Package Accessibility for LIP Best Practice and Implementation Guide, retrieved April 12, 2004, from [http://www.imsglobal.org/accessibility/acclipv1p0/imsacclip\\_bestv1p0.html#1506397](http://www.imsglobal.org/accessibility/acclipv1p0/imsacclip_bestv1p0.html#1506397).
- Riecken, D. (Ed.) (2000). Personalized views of personalization, *Communications of the ACM* 43(8).
- Rose, D. H. & Meyer, A. (2000). The future is in the margins: the role of Technology and Disability in Educational Reform. *A Report Prepared for the U.S. Department of Education Office of Special Education Technology*. Washington, DC: USDO
- Treviranus, J. (1997). Nimble document navigation using alternative access tools. *WWW6 Conference*. Santa Clara.
- Treviranus, J. & Petty, L. (2001). Computer Access. *Manual of Assistive Technology*. Mosby: Chicago.
- Treviranus, J., McCathieNeville, C., Jacobs, I., & Richards, J. (2000). Authoring Tool Accessibility Guidelines 1.0. <http://www.w3.org/WAI/AU>.
- Web Accessibility Initiative. Developing a Web Accessibility Business Case for Your Organization: Overview, <http://www.w3.org/WAI/EO/Drafts/bcase/>.
- Web Accessibility Initiative, Policies Relating to Web Accessibility. <http://www.w3.org/WAI/Policy>.
- Wiley, D. (2000). Connecting Learning Objects to Instructional Design Theory: A Definition, a Metaphor, and a Taxonomy, retrieved April 13, 2004, from <http://reusability.org/read/chapters/wiley.doc>.

## Chapter 20: Displacing Student–Teacher Equilibrium in Virtual Learning Environments

JOANNA BLACK

*Faculty of Education, Department of Curriculum, Teaching and Learning, University of Manitoba, Winnipeg, Manitoba, Canada*

A great catalyst causing considerable change in our 21st century classrooms is the recent implementation and usage of the now ubiquitous computer; this new technological innovation in the secondary school classroom has had a tremendous over-riding effect on traditional learning environments. With digital technologies supplanting older ones, the computer has had an impact within schools. Not only are computers instrumental in the creation of virtual learning environments, but also within these new environments they also affect student–teacher social dynamics. Consequently, what are being altered are the learning environments themselves as well as the pedagogical and social relationships forged between educators and their pupils.

In the new virtual classrooms, frequently educators rely on their “tech-savvy” students for technical assistance while these “whiz kids” often have developed digital competence far surpassing their teachers (Black, 2002; Negroponte, 1995; Tapscott, 1998). However, it is often assumed (and hoped) that teachers in training have systematically developed a rich and extensive knowledge base in their area of technological expertise before being professionally hired to disseminate their knowledge to future students. Unfortunately, this is not the case. With the rapid change from analog to digital technologies within the last decade, with the embracement of many of these new technologies within educational institutions, and with the swift technological advancements perpetually occurring, many teachers find themselves in complex and tenuous situations. Both new and experienced educators have an extremely difficult time obtaining proper training in order to keep abreast of digital technologies in the schools.

In this chapter I will discuss case study research in which I examined the relationships between teachers and students in virtual learning environments (Black, 2002). For this study, I interviewed both educators and pupils in order to obtain their perceptions of the complex interactions and dynamics they have forged. One of the teachers I interviewed, Mr. Ross observes that good technology teachers obtain much respect because the prevalent student attitude is that mastering technology is not only important but also “cool”. The ideal situation is for teachers to have acquired a firm foundation studying computers and technology at university. The condition for this model foundation is superb technological teacher training at a teacher’s college; one can then supplement

this beginning later through teacher support programs and in-service training to keep abreast of ongoing technological changes when student teachers are hired as educators in the classrooms (Jordan & Follman, 1993). Reality, though, is often far from ideal. Schools lose the very people they need: Most educators trained in the computer technology area at university do not enter the teaching profession because there are greater salaries in the computer industry (Black, 2002). Consequently, few new educators have solid backgrounds in computers. Moreover, if more experienced teachers have indeed obtained previous university training, their knowledge would be obsolete as a consequence of rapid technological changes in the last decade. Consequently, it was found that most teachers are self-taught (Pelgrum & Plomp, 1993). Added to this, teacher support is inadequate once educators are working in the field. Jordan & Follman (1993) note that “. . . too many teachers have to play catch-up and learn on the job” (p. 27). Copious methods of staff development have been discussed by researchers, ranging from workshops, online tutorials, mentoring, and modeling to peer coaching and the use of help desks. In an older study by Wiske et al. (1988) it was found that teacher training and follow-up support in schools was inadequate; since then the situation has not improved. Hannafin and Savenye (1993) and Schofield (1995) conducted further studies in schools and found teachers again complained of inadequate training and support. In addition, Greh (2002) who specializes in digital Visual Arts also recently commented that there have been inadequate digital support systems and professional development in place for art teachers. She writes that educators often find there is “no training, no software, no budget. The computers often become dust collectors” (p. 7). Greh advises teachers to pursue computer training: Chances are that it is not provided within the school or board, and hence educators should pursue it within the community. What are the reasons for this less than ideal situation? Laino (1994), Pearlman (1989), and Schofield (1995) point the finger to the bottom line: saving money. Support and training are very expensive and the money is traditionally not earmarked for either; rather it is funneled into buying hardware and software for schools as is evidenced by computer infiltration into many schools throughout North America (AAUW Education Foundation, 2000). For example, an increase of 700,000 computers per year occurred in United States’ schools between the years 1992 and 1995 (O’Neil, 1995: 10).

Educators, on the one hand, often find they are ill-trained and unprepared for teaching cutting-edge technologies; yet on the other hand, find themselves having great expectations thrust upon them by administrators and the public regarding the teaching of new technologies, and teaching them well. As a result, they are often confronted with classrooms filled with computers and expectant, excited students, some of whom possess technological knowledge which often exceeds their own. I was particularly curious to explore how this affects the student–teacher relationship in arts education classrooms at the high school level. Those classes which I examined, range from

Communications Technology, Visual Arts, Media English, and Film to Computer courses which have a focus on art or have strong art components built into the curriculum.

In this chapter, I will describe my case study research in detail of two secondary institutions. Both these institutions, one private and the other public, employ cutting-edge technologies in their schools which are vastly different in their implementation of and the way in which the virtual learning environments have been shaped. In addition, I will look at how educators with a range of training have created differing virtual programs and environments. Then I will outline the type of student–teacher relationships which have been established between tech-savvy students and their often tech-unsavvy teachers. Specifically, in this chapter I will examine the displaced student–teacher equilibrium occurring as a result of virtual learning environments.

#### 1. DELINEATION OF TWO SECONDARY INSTITUTIONS

I conducted case study research at two Canadian secondary schools: one public and the other private. Names of schools and students I will discuss in this case study are all pseudonyms.

#### 2. PLEASANT DALE COLLEGIATE

The public school, Pleasant Dale Collegiate, was built in the 1950s and is located in the heart of a major city with a multicultural urban student population of almost 1,200, and a staff of approximately 70 teachers. Forty-four languages are represented in the school and just over half the student population's mother tongue is a language other than English. This school attracts students ranging from the middle to upper middle class and is annexed to Pleasant Dale Middle School. The Collegiate level spans from grade 9 to grade 13 (although by the time of this chapter's publication grade 13 will have been eliminated by provincial governmental reforms). Two specialized programs exist within Pleasant Dale: one a unique program called WiredIMAGE, which has a focus on the integration of Visual Arts and Technology; the other, a program for the gifted. Some of the students I interviewed are part of the gifted program, others are part of WiredIMAGE, and others are part of the so-called "regular" program. Screening occurs in WiredIMAGE and the Gifted Program. For the latter, screening is in the form of pupils taking IQ tests. For the former program they must undergo an elaborate interview process in which they are examined for their aptitude and interest in Visual Arts and Technology. WiredIMAGE students must obtain an average mark of 70%.

During the 1990s Pleasant Dale's reputation as a fine school had become tarnished, resulting in the hiring of a new principal who made radical

changes. She developed the mandate to “build students’ skills required for the 21st century”. One of the ways she accomplished this was to usher in technology: Pleasant Dale thus became a pilot project for its board, with the implementation of a server and the purchase of approximately 300 computers. As a result it was considered a model school. Numerous teachers left who disagreed with the changes at Pleasant Dale, creating a notorious mass exodus which is still talked about within its board of education today. The many vacancies enabled the principal to hire new educators who were far more receptive to working with technology and its integration within the curriculum.

Pleasant Dale has 10 PC computer labs for regular students with a ratio of one computer per three students. These students use such programs as Word, PowerPoint, and Excel. WiredIMAGE, though, is different. The program began in 1995 and was originally housed in the regular school until the new site was built two years later in 1997–1998. It was designed in a post-modern architectural style, housed in a newly built segment of the school. WiredIMAGE is thus set apart from the rest of Pleasant Dale. The ratio of student to computer is one to one and the platform is primarily Macintosh. Students regularly create videos, desktop publishing, animation, web design, and multimedia projects using such software programs as Final Cut Pro, Adobe After Effects, Premiere, Illustrator, Quark Express; Dreamweaver, Flash, and 3D Studio Max. The emphasis in the WiredIMAGE program is to concentrate on four major areas: Visual Arts, Computers, Communications/Literacy, and Media Technologies. Student interest spills over into the regular program in Visual Arts which has a focus on graphic art/desktop publishing courses and Communications Technology which has a specific concentration on video and film.

Support systems for teachers at Pleasant Dale are weak. Educators are not provided with their own computers. In addition teacher training has been inadequate. When computers were first brought into the school *en masse* during 1997–1998, numerous teacher workshops were provided during a two-week period by a private company. Also, during this time Photoshop classes were offered during the school day to teachers and monies were provided to bring in substitute teachers. Since then, with cutbacks of up to 55%, which included reduction in teacher training and development, little has been offered to teachers. No extra time is currently provided for educators to learn the software during the school day. In addition to this, there is only one technical assistant responsible for the smooth operation of all hardware and software and his job is being threatened as a result of continued cutbacks. Overall the area of teacher support and training is inadequate at Pleasant Dale.

In summary, while Pleasant Dale is a cutting-edge school in which students use sophisticated digital technologies, teachers are struggling with lack of monies, cutbacks, and inadequate training and technical support systems.

### 3. GLEN MANOR COLLEGE

Glen Manor College is the other institution I examined which uses cutting-edge technologies. It is a private school established in the early 1900s and is located in a small affluent city in Ontario, Canada. It has the same number of staff but half the student population of Pleasant Dale. Students span grades 7 to 12 and derive primarily from the upper classes (except for the few on scholarship programs.) Screening is as follows: teenagers must write a successful Secondary School Admission Test (SSAT), and these students' parents must have the ability to pay the \$16,000–28,000 tuition fee. I could not find statistics regarding the ethnic breakdown; however, 12% of Glen Manor students are from outside Canada. Originally Glen Manor was modeled after a traditional English boy's school with the mandate to provide students with a well-rounded education combined with rigorous academics with an emphasis on extracurricular activities, athletics, and community service. At Glen Manor, tradition changed in 1992 when the administrators opened their doors to female students; later that decade there was another monumental transformation when a headmaster ushered in the era of digital technology through the implementation of the laptop program.

Glen Manor was one of the first schools in Canada to implement a laptop program in affiliation with IBM Canada—in fact Glen Manor administrators claim it was *the* first secondary school in Canada to fully incorporate technology into its academic curriculum. Every Glen Manor student was required to purchase or lease their laptop and use it in class. Through this arrangement an added financial burden was placed on the parents at Glen Manor. The laptop implementation process occurred in three phases: in 1997, during *Phase 1*, the hardware was installed and the rooms were redesigned; in 1998–1999, during *Phase 2*, grade 9 to 11 students were expected to use laptops in the classroom; and in 1999–2000, during *Phase 3*, the laptop program was implemented throughout the entire school from grades 7 to 12 and 20 labs were set up. As a consequence of this program the ratio of student to computer is one to one.

Most of the classrooms have drops for the laptops as well as overhead computer projectors. As a result of the large investment of monies by parents and the school into new technologies, teachers feel pressure to use the computer when teaching. Administrators expect that laptops be utilized by teachers and students in every lesson. The variety of computer usage varies from teacher to teacher though I found that on the whole, the computer is regularly used as a replacement for the chalkboard. Replacing the traditional wooden desks are more corporate, chic models, bolted to the floor, with numerous ports enabling all students to connect to the internet and the school's Intranet. Hence students are able to do research from the classroom via a connection to the library, download their teacher's notes, use all software programs licensed for the school, e-mail each other easily, even in class much to the chagrin of some

of their teachers, and have online conferences. At Glen Manor it is important to note that all hardware and software used is standardized to one platform (as a result of the school's affiliation to IBM) and is similar between students and their peers, between teachers and their colleagues, and between teachers and their students for ease of use and for practical purposes. The "pay-off" for IBM is that it obtains the school's business and that the students, who will in future likely obtain high powered jobs, will use their platform. For the school the pay-off is that using the same platform can alleviate problems and that responsibility for purchasing computers is downloaded to students and their parents.

Out of all the arts classrooms I visited, including English, Media, Music, Film, and Visual Arts, it was only the latter that was not wired (however, there were immediate future plans to build a wired Visual Arts and Science building). In sum, all students have access to technology, providing the classrooms are wired—and most are.

Glen Manor College does not have a similar program to WiredIMAGE. Their Visual Arts remain traditional, with a focus on art history and art production. Any interest in utilizing digital multimedia technologies is regulated to workshop time outside of the classroom in which the Visual Art teachers have hand-picked students to conduct workshops using software programs like Adobe Photoshop and Illustrator. These workshops are not considered to be part of the classroom curriculum nor are marks given for the learning or the works produced.

Glen Manor's history in the multimedia area is quite interesting. Between 1995 and 1998 educators were able to develop a popular media program. For part of this program students studied journalism and for the other part they studied television. Many teachers remember and speak fondly of the successful and popular weekly television show produced by students called "*Glen Manor Live*" which was aired weekly to the entire school population. Macintosh computers were used but when the program was dismantled the equipment was sold. Several reasons were presented for the program's demise, ranging from it being too time consuming to the view that it was not academic enough. In addition, many teachers commented that it was too costly. This last reason appears to be most logical in light of the fact that the multimedia program was dismantled at the exact same time that *Phase 1* of the laptop program, which had great expenses attached, was implemented. The dismantling of this program is still a contentious issue for teachers at Glen Manor. If they had developed it further, the school would have had a unique program in the multimedia area which it does not have at the present time.

To indicate the shift in administrators' focus that occurred during the latter part of the 1990s, I will describe two interviewees, one a graduate and the other still attending Glen Manor. On the one hand, early on in 1995, Lyle was the student who was the catalyst in getting the multimedia program started and running specifically in the area of television. His interest was fostered

and developed by teachers at Glen Manor. Currently he is receiving major film awards while also studying film in Los Angeles. On the other hand there is Adam who is still attending Glen Manor. His experience is very different than Lyle's for he has received little support in his pursuit of another area in multimedia, animation. Adam is still at Glen Manor and is experiencing an entirely different environment than Lyle. Much to his distress, Adam was not given the option of being able to take an extra Visual Arts credit: rather, he has been told to take an athletics course in its place (which he intensely dislikes) in order to achieve a "well-balanced" curriculum. Stress is placed on such balance. As a result of a shift in focus at Glen Manor, the two schools I studied remain very distinct: Glen Manor's focus is to use technology to enhance the traditional curriculum; Pleasant Dale's is to use technology throughout the curriculum and also to enhance students' production and knowledge in the area of multimedia.

In 1998, during *Phase 2*, Glen Manor administrators provided all the teachers with laptops. This is a direct contrast to Pleasant Dale where teachers either buy their own computers or compete with other teachers for the scant resources available for educators. At Glen Manor, training and support is far better developed than at Pleasant Dale. Glen Manor has developed an Information Technology (IT) Department with a handful of full-time and part-time help who provide not only technical support if computers break down but also 1 hour bi-weekly teacher training courses; moreover, through this department, teachers also receive six additional hours of workshops every week. Educators who desire further training through professional conferences and workshops outside of the school are often provided with time and financial support to do so.

In summary, Glen Manor is a cutting-edge school in which students use sophisticated digital technologies in their classrooms. Programs, however, are limited to integrating technology within the traditional curriculum. Usage of technology for multimedia development is limited, preventing students from working in such areas as videoconferencing, animation, and desktop publishing production. Furthermore, Glen Manor excels in support and training: Teachers are offered financial backing and strong technical assistance as well as excellent workshops and seminars.

#### 4. RESEARCH DESCRIPTION: CASE STUDY

For this study I used *instrumental case study research* (Stake, 1994: 237) using a *comparative case study analysis* (Hitchcock & Hughes, 1995; Merriam, 1998; Yin 1989). I selected two schools. In one, Pleasant Dale, I worked as a teacher and I also assumed the role of researcher. In the other, Glen Manor I was solely a researcher. Glen Manor was recommended by consultants, teachers, and administrators as an excellent school because it possesses cutting-edge



technologies. Recently both schools had much press coverage for their technological innovativeness. For data collection methods I used four main sources: first and foremost, I relied heavily on interviews; secondly, I employed participant observation; thirdly, I took field notes; and lastly, I collected documents concerning the schools, ranging from media coverage (of which both schools had plenty) to brochures, newsletters, pamphlets, and websites written and issued by administrators and teachers in the school. My roles were diverse from (1) researcher as teacher, and (2) researcher as participant observer, to (3) researcher as interviewer.

I collected data over a two and a half year period. Six teachers from each of the two schools (making it 12 in all) were interviewed. They were selected on the basis that they were (1) either knowledgeable or were pressured into becoming knowledgeable about multimedia technologies in an arts area curriculum ranging from Communications Technology, Film Studies, Computer Studies and Media English, to Visual Arts. I was also concerned that educators should (2) come from different backgrounds ranging from engineering to photography and film (many of whom had worked professionally in these fields before entering the teaching profession). Moreover, I wanted to interview teachers with (3) diverse levels of teaching experiences ranging from the neophyte to individuals on the verge of retirement. Furthermore, teachers at both schools recommended students to be interviewed. I had more difficulty narrowing the high school students down as teachers recommended a large number. Eventually I selected 16 (seven from Glen Manor and nine from Pleasant Dale) on the basis that (1) they were tech-savvy; (2) had studied multimedia digital technologies in an arts based curriculum; (3) had assisted their teachers with technology in exceptional ways; and (4) were responsive and articulate during the interviews. These students also varied from the helper (the teacher's Godsend!) and the technical whiz to the computer hacker. For both teachers and students I attempted to have a gender balance between both male and female teachers and students but this was impossible at Glen Manor where all the teachers recommended I interview male students with the exception of one recommended female whom I did not use as she was shy and reluctant to share information during the interview process.

I conducted one to two interviews per person and the first set were *semi-structured* (Merriam, 1998). These interviews lasted anywhere from 50 minutes (the shortest) to numerous hours spanning several days, whenever busy teachers and students were available between classes, on breaks and during lunches. With one student, however, I corresponded over e-mail because he was in Los Angeles. If a second interview was needed, and oftentimes it was, I employed open-ended ones (Yin, 1989: 89) in order to clarify the data I had previously obtained.

All teachers and students were sent the transcripts to check, clarify, and correct. Descriptions of the school programs were sent to key administrators

at both schools to further ensure accuracy of information. I employed *data triangulation* and *methodological triangulation* (Hitchcock & Hughes, 1995). Two types of analyses were conducted: firstly, the *within-case*, and secondly, the *cross-case* analysis (Merriam, 1998: 194–196).

## 5. TEACHING IN VIRTUAL LEARNING ENVIRONMENTS

What happens to the curriculum, to the ways in which teachers teach and the ways in which students learn, when cutting-edge technologies are introduced into schools? How does the introduction of new technologies change the school learning environments? Cuban (1993) has made the observation that research is scarce concerning the manner in which educators teach using technologies in classrooms (p. 284). Based on the current research, there are numerous claims that the role of the teacher naturally alters when technology is introduced to classrooms. (Bagley *et al.*, 1994; Hannafin & Savenye, 1993; Knupfer, 1992; Schofield, 1995).

### 5.1. Teacher and Learner-Centered Approaches

The teacher-centered approach (in which educators position themselves in the front of the class and lecture through question and answer style teaching) some researchers claim is changing. The position of the teacher as the dispenser of knowledge is being eroded by technology (Doud, 1998; Gregory, 1995; Hannafin & Savenye, 1993; Jeffers, 1992; Knupfer, 1992; Knupfer, 1993; Koehn, 1986; Lai, 1993; Luke, 1996; Schofield, 1995; Silverman, 1995; Willis, 1985). Educators, it is postulated, naturally take the role of facilitator when dealing with media technologies and this is viewed by many in a favorable light (Bagley *et al.*, 1994; Carey, 1993; Hoffman, 1996; Jones *et al.*, 1995; Jordan & Follman, 1993; Knupfer, 1993; O'Neill, 1995; Pearlman, 1989; Tapscott, 1999; Wood & Smellie, 1990). Teachers (1) restructure an environment conducive to untraditional methods of teaching (as opposed to the more teacher-centered one); (2) act as helpers; and (3) make much of the work project-driven (Haycock, 1991; Sheingold & Hadley, 1990).

Many researchers discuss how virtual technologies have affected teachers so that far more teaching is done in *learner-centered classrooms* or what is commonly also called *student-centered learning environments* (Carey, 1993; Hannafin & Savenye, 1993; Lai, 1993; Masterman, 1993; Sheingold & Hadley, 1990; Sivin-Kachala & Bialo, 1994). In this model what is promoted are students learning from one another, and developing problem-solving and independent learning skills. The *constructivist approach* and cognitive–developmental theories are often discussed in relation to this model (Carey, 1993; Cuban 1993).

There are some researchers, however, who have found different results: They postulate that educators' roles have indeed not radically altered since virtual classrooms have been established. Rather than technology altering teaching methods, technology is often merely assimilated into conventional ways of teaching (Collis, 1989; O'Neil, 1995). Willis (1985) and Meinster (1990) maintain that most teaching methods still consist of teachers lecturing and students listening.

Very few researchers have postulated that different approaches can be used in the same school, within the same classroom and indeed by one individual teacher. There are however, a few. Cuban (1993) and Wiske et al. (1988) discuss how many teachers mix their teaching approaches when using technology ranging from using traditional teacher-centered approaches to student-centered ones. Saye's views corroborate with the above. He outlines three types of teachers (1997; 1998). Firstly, there is the *Accidental Tourist* who uses technology to reinforce the teacher-centered approach; secondly, there is the *Voyager* who uses technology in a more *learner-centered classroom approach*; lastly, Saye describes how teachers can also adeptly switch roles between the above two. As a result of his recent studies, he concludes that, "contrary to the expectations of many advocates, study data suggested that acceptance of educational technology may not imply a radical shift in educational practices. Although some teachers appeared to have embraced its potential for alternative approaches to schooling, others adapted technology to bolster traditional, teacher-centered instruction" (p. 223). My research corroborates with Saye's (1994; 1997 and 1998) Cuban (1993) and the AAUW's (2000). I found that teachers do not change their teaching methods or the way in which they structure their classes as a result of integrating technology in the classroom. What has the largest effect in virtual learning environments are the following (and I am not listing these in any order of importance as these vary from one teaching situation to another): (1) the philosophical mandate of schools and their administrations; (2) the mandate of programs within a school teachers are working in; (3) a teacher's philosophical approaches to teaching; (4) an educator's propensity towards and comfort level of utilizing certain teaching methodologies; and finally (5) the teacher's past background in technology and present levels of training and support which have direct co-relation to the amount of monies available in schools.

## **5.2. Models of Incorporating Technology into the Classroom**

The two schools I studied differed greatly in the way in which teachers' approach their teaching in their virtual learning environments and the way in which students respond within these environs. Recently the AAUW (2000) conducted a study in which 70 female students participated; they outlined three models in use in virtual learning classrooms. In the (1) *productivity model*,

teaching styles and curriculum into which technology is incorporated remain unchanged; (2) in the *career model* the sole reason for using technology is to prepare students for the world of work; and in the (3) *fluency model* the curriculum is restructured so that multimedia technologies are integrated throughout, with an emphasis on the development of problem-solving and critical thinking skills.

I found that at Glen Manor both the *productivity model* and the *career model* are in place. Great emphasis is laid on students at Glen Manor being trained for future leadership careers, and it is touted that Glen Manor will better prepare pupils for the 21st century. Moreover, this school fits well into the *productivity model* in that there are no great changes in curriculum structure, or within the roles of teachers and students. There are some situations, however, which differ. One of the teachers, Mr. Tyke, uses the technology for online classes after traditional school hours. Moreover, Mr. Tyke was also involved in the now defunct multimedia class, described as strongly student-centered. When I observed his classes, however, I found that he only utilized, and was a master of, the Socratic teaching method. Overall, at Glen Manor I found that the teacher-centered mode of instruction greatly predominates. Despite the introduction of the pervasive and expensive laptop program, which meant a restructuring of rooms, large scale building renovations, great amounts of monies spent on hardware, software and personnel, the mandate, nevertheless, within the school has remained unchanged. Traditional private school teaching methods are primarily utilized with teachers lecturing using Socratic methodology. Almost all the teachers at Glen Manor position themselves as authority figures. The computer is the teachers' chalk and their computer projector and whiteboard function as chalkboards. Students quietly listen to their teacher and take notes using their laptops which serve as notebooks and as walkways to their library since all student computers are connected to the internet. Most pupils work on the same material at the same time. It is no surprise that half the teachers interviewed assert that using the technology has not affected their approach to teaching. At the beginning of the 21st century, Glen Manor still follows the British school system's humanistic, well-balanced 19th century educational approach. Educators talk about having control: control in terms of the class, control in terms of students, control in terms of the technology, and control in terms of censorship, particularly regarding pornography and racism found on the internet. In addition, having a computer always available, being able to rely on technical support from the IT Department, having weekly training sessions and ongoing workshops I believe helps teachers maintain their position of authority. On the whole, teachers feel comfortable with this and the students respond well. They believe this approach works effectively.

At Pleasant Dale, teachers vary their teaching styles from class to class and from lesson to lesson. Sometimes educators at this school use a teacher-centered approach and sometimes a student-centered approach: Some

educators have a propensity for using one over the other. Sometimes they vary their approaches. Students state that they appreciate all the various teaching methods their teachers use. It is apparent that Pleasant Dale differs from Glen Manor. Overall, the school is best described as fitting into the *fluency model*, particularly where computers and technology are strongly utilized as in the WiredIMAGE program. Here, project-driven, student-centered curriculum is primarily used. Teachers have a less authoritarian approach, veering more to collaborative learning partnerships with students. Multimedia technologies primarily in the WiredIMAGE program are integrated within a number of disciplines, specifically Computers, Communications, Technology, and Visual Arts with a recent, additional component within the last two years of Geography and History. Mr. Kreighoff, the former Program Head of WiredIMAGE, discusses his teaching method:

Later on, when I brought in other technologies into the programme, then I did have to bring the students as more partners in the set-up as well as even in the skills' teaching—not only to me but to the rest of their peers. You can't help but in that modeling situation to be challenged by the students because you've now opened up the floodgates and you've shared the keys with them. And you can't all of a sudden be the authoritarian or go back to a traditional mode of teaching of the sage on the stage because those students in practice have been partnering with you in a very real way. Once that's stopped they won't allow you because it would be hypocrisy to do so—to go back into a traditional program. It helped that I was naturally comfortable with that environment of partnership and sharing rather than feel intimidated or that I have to be the last authority.

It helped because that was my personality to lend itself to that

(Black, 2002: 173)

Ms. Herbiere (Black, 2002), a teacher in WiredIMAGE and in the regular program, similarly states that her role has changed: “Well, teaching computer based technology has humbled me to a great degree because I'm not the expert anymore. I hate giving that up but that's the reality. I can't do the Socratic thing at the front of the room and give all the answers and be the big guru [for] I am just the voice of many in the classroom as we all try to figure out what the problem is, or what the solution is, or what the potential of the situation is . . .” (p. 174).

From both schools the students I interviewed react favorably to the many roles of the teacher. Teenagers generally agreed that as long as their educators were effectively teaching, whatever role they assumed was fine. Students in WiredIMAGE did note, though, that other WiredIMAGE students who wanted more of an authoritarian teacher-centered educator dropped out of courses in which it was not delivered. The vast majority of students, however, remained

and enjoyed the different teaching styles. Joe, a student in WiredIMAGE, describes his perception of the teacher's role:

The teachers in WiredIMAGE, the staff in WiredIMAGE really are like the head of the class, like the head of the table. They mediate. If you are comparing it to the dinner table: my father sits at the head of the table. He's the head of the family. He doesn't tell us what to eat first. He doesn't tell us how we should eat it. He doesn't tell us if we should put salt on our fish. They just sit there. If I want salt, then I will say, "Dad, can you pass the salt?" If you can compare it, that's the analogy. Teachers are there, and they set a tone. This is probably one of the most important things they do. They set a tone by saying nothing. That's what's amazing about the programme. Similarly to how you're sitting at the dinner table and your Dad's there and you have a certain respect. You watch your language. You make sure that your knife goes in the left hand and the fork goes in your right hand. You eat with your mouth closed. He's there, so you do certain things. You act a certain way, and you make sure to finish your plate—all those things . . . They set a mood. They make sure [things are done well]. Just by them being there you feel energized to work, you feel motivated to work (and you want to). That's what they do  
(Black, 2002: 176)

Why does Pleasant Dale Collegiate differ so much from Glen Manor College in terms of the virtual learning environment it has created? I believe there are many reasons. Firstly, many of the teachers hired who use technology are hired to teach in the WiredIMAGE program and they end up, by virtue of being at Pleasant Dale, also teaching in the regular program. WiredIMAGE has a program mandate which is student-centered and project-driven. Teachers are influenced by this. Secondly, administrators strive and are successful at having an equal representation of male and female pupils in the program. The AAUW (2000) study claims that the *fluency model* particularly attracts females, and WiredIMAGE is noted for its high female population in relation to other technology programs within the city in which it is situated. Thirdly, because of inadequate teacher training and support, a more project-driven, student-centered, less authoritarian model makes sense in this school. The student-centered approach works for the teacher struggling to keep abreast of the technologies. Koehn (1986) writes that a teacher dealing with technologies who strives to be the "all-knowing" educator either has a "very stupid bunch of students or hasn't learned that lesson that . . . [it is a] dangerous role" (p. 30). Hence it is apparent from the two very different case studies that school circumstances, situations, as well as people's backgrounds all have a role to play. It is the (1) philosophical mandates of schools and their programs, as well as (2) teachers' own comfort levels towards and

approaches to teaching, in addition to (3) the level of training and supports which all help to shape the way in which virtual learning environments are formed.

## 6. STRANGERS IN VIRTUAL LEARNING ENVIRONMENTS: RESHAPING TEACHERS AND STUDENTS

Teachers at Glen Manor and Pleasant Dale vary in their attitude towards working with digital technologies. There are teachers who are outrightly critical of and hostile towards the use of digital technology in the classroom, questioning its pedagogical benefits. Conversely, there are also teachers who praise its merits, albeit sometimes unconditionally and sometimes rather uncritically. Whatever their attitudes towards using computers, teachers are expected to use them in classrooms regularly at both schools, but the usage varies greatly. On the one hand some teachers have rarely used computers in their classes, particularly at Glen Manor and particularly with two teachers: one is on the verge of retirement so administrators are leaving him alone; the other uses excuses and she feels vindicated when using these justifications for, she reasons, there are no drops in the classroom to facilitate computer usage and those classrooms that have drops are difficult to book. Then, on the other hand, there are teachers who are extremely innovative in their technology usage. For example, in the case of Pleasant Dale, educators and students took part in an exciting project 3 years ago of implementing videoconferencing with other schools in Ontario (when videoconferencing was not so common). In another case at Glen Manor one teacher implemented a special annual digital conference for his English students in which he had online participation between his pupils and published Canadian authors.

### 6.1. Educators

Did educators perceive themselves as changing as a result of teaching in virtual learning environments? Teachers at both schools talked about what they have done to learn about the technologies. They refer to experts for help; seek out other teacher's assistance who are more knowledgeable; become more knowledgeable about digital technologies themselves; teach themselves, providing they have the resources and time (which many do not); and use problem-solving skills when faced with technological difficulties. Educators, particularly at Pleasant Dale, also observed that they had become (1) far more flexible; (2) more creative in their design of projects; (3) more focused on teaching theory rather than the technical components of a lesson; and (4) far more apt to establish community ventures. I will elucidate on these last four points further.

Firstly, Pleasant Dale teachers talk about having to be flexible when dealing with the practical problems of computers—and these are truly practical day-to-day problems—because of the temperamental nature of technology. What happens when something as mundane as the last computer projector bulb burns out and when the teacher has prepared her entire lesson based on the use of this equipment? What happens when a student is unable to cross platforms or when software they used at home is incompatible with the software at school? Teachers find practical problems affect their day-to-day teaching and as a result they often plan ahead for technology breaking down, for something not quite working; thus being adaptable and well prepared is important. In addition to this, teachers talk about becoming more flexible in terms of their assignments, particularly at Pleasant Dale. Students are given the freedom to explore and teach themselves. This is very different than how assignments are generally structured at Glen Manor in which students follow prescriptive directions and guidelines, proceeding lockstep through each phase narrowly outlined.

Secondly, educators talk about change in terms of assigning more creative projects, particularly at Pleasant Dale. They design these projects in a variety of ways, based on learners' own individual learning styles, needs, and interests. It is expected that students will research, conduct preliminary work, and document their findings as a part of every multifaceted project. Teachers basically outline the creative project, teach theory relating to it, and then hand over control to their students who design how they will undertake each project within the structure that has been set.

Thirdly, teachers find that in order to teach well at Pleasant Dale they defocus attention on the technology while at the same time they focus more on theory—specifically on the theory in which they are strong. They rely on this transferable knowledge so that, for example, if they are strong in English, they will connect English theory to the teaching of technology. Hence, in an animation project, for instance, in which students are expected to create a pixilation as their final work, a teacher who has a strong animation background will focus on animation theory, animation history, including pre-digital animations, elements of design, and examples of pixilation and the film techniques utilized. Students will use the technology at hand such as video cameras, programs such as Final Cut Pro or iMovie, but teachers will not focus on this software as a primary part of the project. Educators at both schools talk about areas they rely on from journalism and the Classics, to Visual Arts and English. Mr. Ross ruminates:

I see teachers in the classroom, particularly older teachers, who are not up to steam on the technology, and if they do not have the theoretical background or other backgrounds that apply to the subject it's a nightmare because you can't even design the course so that the kids search for answers to the technology and you deal with other issues that are



involved like design or whatever the case may be. If you don't at least have one strength to fall back on within that course you are in big trouble. I wouldn't want to be there. If I were put into that situation, if I lasted a year and things did not get better, I would leave

(Black, 2002: 244)

This vastly differs from some other types of teaching approaches in which teachers will specifically focus on the software and hardware and not on the creative and theoretical aspects.

The final change teachers have noticed, again particularly at Pleasant Dale, is their connection to the community. Here projects are created so that students work with professionals in the field. In other words, to be metaphorical, teachers have designed projects so that the walls of the schools are broken down. Students work outside of the school in the community and, vice-versa, people from the community visit the school. Pupils work with people in the industry on joint projects such as was the case when WiredIMAGE students created the website design for the "Toronto Olympic Bid" in conjunction with a major museum. On an ongoing basis, professionals visit the school in order to conduct workshops, give lectures and seminars on topics ranging from website design to how to create professional storyboards. As WiredIMAGE develops, its graduate students (many of whom are now in the workforce) return to talk to, assist, and inspire students. Mr. Kreighoff describes the benefits of this last strategy:

Currently, we just finished a project—albeit, with a very special group of kids, in the senior WiredIMAGE programme—but this was a project in conjunction with the local graphic arts museum which meant it was going to have ultimately much public profile—a strong public profile . . . The students did wonderful work that is visible on the internet in a creative fashion in an open classroom environment with a very high end quality technology that allowed them to explore their own ideas and learn more than minimal skills in various packages that are used for design that include multimedia development, sound, movies, motion and they did a wonderful job . . . Anybody, forever can see it—there is nothing more motivating than having to show your wares in public. “. . . We pride ourselves here that most things that go on, go on with students around: presentations, meetings. I take students to meetings that are high level—technically and politically high level—and charged not only because they have technical expertise that I don't have but I want them to understand what the world of the corporate suit is like as well. That is also a learning part of school. That would never have happened twenty years ago

(Black, 2002: 219–220)

At Glen Manor, only one teacher was teaching technologies in this manner. At Pleasant Dale all the teachers were working on community ventures.

## 6.2. Students

How do students perceive they have changed with the advent of technologies in their classrooms? They share some concerns with their teachers, one being the importance of volunteering within the school and greater communities. The other, particularly at Pleasant Dale, is their enjoyment of the flexible, open-ended, creative assignments enabling more control. Students are cognizant of and appreciate the notion of taking control of one's own learning, of acquiring more control over projects, and being more independent learners. As well, students are aware of teachers who connect their theoretical knowledge to technology. From the learner's perspective, they appreciate teachers who do this. Healy (1998) advises teachers not to be intimidated by students' technical "wizardry" but to impart skills and wisdom to the classes (p. 289). I found that students respect their teacher's skill and expertise in those areas that are relatable to computer learning. The one catch is that these areas of expertise must have obvious relevance to technology. If what the students learn has relevance to the learning at hand, students will respect their teachers; the converse is also true, which had been the case with one unfortunate substitute teacher at Pleasant Dale. Educators who have few relatable areas of expertise to the field of technology are particularly vulnerable to students' disdain. It is important to note that power is often granted from below and in the case of the Pleasant Dale substitute teacher it was not given to the teacher by the students.

Learning characteristics students discuss at both schools are similar: They believe they have to be inquisitive, open-minded, unafraid of failure, and risk takers. It makes sense that they would talk about these qualities in relation to the present time for these technologies are new and on the cutting-edge, and hence students are often unable to turn to their teachers for expertise and assistance. In addition, being independent learners is unanimously an important trait. This corroborates with Negroponte's research (1995) who found that our new "digital youngsters" are self-learners. The question of whether technology has shaped these students to develop these qualities or whether these are the types of students who work well with and are thus attracted to computers needs to be addressed in future literature.

## 7. RESHAPING ROLES OF STUDENT AND TEACHER

Many educators readily admit that some of their students know far more about computers than they do. Teenagers are so keenly interested in digital

technologies, many have few responsibilities, and most have ample time to play on computers, leaving their adult counterparts far behind in hands-on digital expertise.

Tech-savvy students themselves generally acknowledge that they have better technical skills and knowledge than most of their teachers. How do teenagers respond to this common situation? Much to my surprise I found that they are very forgiving. That I heard no complaints of teacher incompetence from any of the 16 students I interviewed was even more surprising. Four major reasons explaining lack of teacher knowledge are provided by the teenagers. Some observe that if a teacher developed superb technological knowledge they would not be teaching but in the computer industry where they would be making far more money. In fact one former teacher of a Glen Manor student did just that: He learned on the job with this student and then promptly left teaching for better pay at a computer company. Some students also acknowledge that teachers have a difficult time keeping up with the swift technological changes occurring in the technology field. Moreover they have little time to learn, being so busy with the day to day running of classes. In addition, the interviewees realize they are the ones growing up in the digital age. Their teachers, however, grew up in a very different world where, for most of them, having a home computer was unheard of, odd as it may seem by today's standards. Today's students are vastly different from any previous generation (Negroponte, 1995; Tapscott, 1998).

The only criticism I heard was from Lyle, a Glen Manor student who points out that it is the teachers' attitude that can be problematic. Lyle believes that even though some teachers may know very little regarding technology, educators must be willing to learn from their students in order to obtain teenagers' respect. Role modeling the learning process is very important. Teachers always expect their pupils to be willing to learn in the classroom environment. Lyle has little patience for educators who will not do the same. He reflects, "How can they expect me to learn from them when they refuse to learn from me?" (Black 2002: 243).

Two-thirds of the teachers interviewed had no previous computer training; they had to learn about digital technology while teaching. Mr. Tyke was one of three key educators to spearhead the laptop program at Glen Manor: he is not only interested in technology but utilizes it well, constantly letting his students know he is cognizant of their computer abilities and he is himself digitally adept. For example, he describes a typical (and problematic) situation at Glen Manor in which students send each other e-mails during class:

[My message to the person who sent my student an e-mail reads] 'Hi, it's Mr. Tyke and I'm replying to the e-mail you sent to so and so who is in the middle of a class and I know that you are in the middle of someone else's class too. I wonder whose? I wonder if I should tell them? Would you like to tell me what class you're in? I'd appreciate it!' Of course you

get no response at all. Those things are important as any teacher will tell you . . . It's just enough to let the kids know that not only are you interested, but you are good at it too. You'd be surprised how much they appreciate that and respect it. The last thing you want in the classroom with a bunch of technology, the kind of stuff that this is, is someone who doesn't know anything about it at all

(Black, 2002: 240–241)

Most teachers are not as tech-savvy as Mr. Tyke and therefore are unable to assert their control over students. How does this affect both teachers' and students' roles? How does this affect the student–teacher dynamic?

#### 8. DISPLACED STUDENT–TEACHER EQUILIBRIUM

If one visualizes the relationships between learners and educators in terms of a simile, this relationship would be very much a teeter-totter. In traditional pre-digital times if one placed the teacher and the student on opposite sides of this contraption one would find the weighty educator most often holding the student up in subordinate suspension. However, add the catalyst, technology, as weight and this picture changes radically. Now that teeter-totter is often in flux in an up and down, shared ride between learners and their educators. Why has this picture changed in the last 10 years?

The first reason I believe is that tech-savvy students have been asked to take a far more active role in the schools. From the research I conducted I saw students taking positions of power: they operate equipment, run labs, conduct workshops, teach their peers, collaborate, and in some cases teach their teachers in formal situations. They are taking on a variety of roles ranging from assistant and technician to workshop leader and educator. Some are paid and others volunteer. These students end up taking more leadership roles in their classrooms and in the school community.

Technical jobs are in abundance at both schools. In Pleasant Dale, two students had run the computer server and were privy to confidential information such as teachers' marks. WiredIMAGE constantly has students volunteering as troubleshooters, monitors, and technicians. One student describes how he is regularly approached in the halls by teachers who ask him for technical assistance. In fact, for this particular student, one of the consequences of taking on such an important technical role at Pleasant Dale is that he has been regularly mistaken as a teacher by his peers. At Glen Manor, students help the teacher run the schools' Intranet, volunteer at the Help Desk, and manage the school's website. One student surfs the 565 student websites, making certain that racist or sexist content is obliterated and that the server is not overloaded.

Both schools place students in positions of power. They teach their peers formally and informally. For instance, at Glen Manor, key pupils have been

singled out to conduct workshops on Photoshop after school hours of which their two Visual Arts teachers are actually taking part as learners. At Pleasant Dale, students are often asked to conduct formal workshops, particularly on software, to teachers as well as teenagers. Peer learning is also conducted on an informal basis as well. It is a general rule of WiredIMAGE that students must query three other students before they turn to their teachers for assistance. Student mentors are promoted. Ms. Hebiere labels these pupils “lead people” and she elaborates on their importance:

I’m finding more and more . . . that there is a real sense of camaraderie about sharing ideas and knowledge . . . I find they [students] are very generous with their information . . . You’re all just flying by the seat of your pants. One student knows . . . and so the exponential growth is that if one student knows it in one hour you can bet that in forty minutes another student knows it, and then another student, and then those students teach two more. So, exponentially we can move through the class within a two day period and everybody will know something. I think it is really important to talk about the exponential factor. It’s not one person and then the next person: it goes one, two, four, eight, sixteen, thirty-two. That can happen pretty quickly and I’m just coordinating the show really  
(Black, 2002: 249)

Hence, in technology classrooms at both schools there is great value placed on peer learning. Teachers find this practice invaluable, stating it makes their job easier and it enables students to succeed; indeed, in some cases the solution devised by other students is the only way teachers believe they will be able to accomplish certain tasks.

Student–teacher relationships have been affected in a second area through interesting teacher–student collaborations. I found that at Glen Manor Lyle and Mr. Tyke had collaborated in a rare manner unusual for this school: they worked together to design, implement, and run an entire course. Lyle had been placed in an uncommon situation for he was even given influential responsibilities including curriculum planning and student assessment. Similarly, at Pleasant Dale students work with teachers to help them order the best equipment, to participate in conferences, to collaborate on the launching of new activities such as videoconferencing, and to work on special events ranging from the local to international.

At both schools co-learning has a significant role. This is the process in which teachers and students learn together, tackle problems as a team, gain knowledge of technology, and connect new technologies to school situations. They develop a reciprocal exchange, a reliance on each other, and treat each other as colleagues. (In one case, Mr. Tyke exchanged business cards with an elementary student who helped him out with a conference event.) This is a process in which students and teachers work and troubleshoot together

to obtain workable solutions for pedagogical situations. Rarely, in the past, were students given the opportunities they are at present. At Glen Manor, Ms. Smith expresses her perspective on this situation:

It puts us right on the same level as the students and I think that's fabulous. I think it's going to cause a lot of problems for a lot of teachers, for the traditional teachers and their approach to education but I think it's a humbling experience for educators. A lot of educators get caught up in the fact that they know everything. The technology puts you on the same playing fields and I think it's so good for the students to see the teacher say, 'I don't know how to do this? Does anybody else know how to do it? How am I going to problem solve my way out of it?' We are right there together and we're working together as a team solving the same problems and I think that just increases the respect level. I don't think that the teachers have to know everything all the time. There's the myth that that's how you get respect from your students: that you know it all  
(Black, 2002: 310)

Included in *The Discourse of Language* (1972) Foucault extrapolates upon the interplay of power within institutions. As a result of the displacement of student–teacher equilibrium power is reorganized. One of these ways is what he terms the *principle of exclusion* in which he discusses how people in power such as teachers are given the exclusive right to talk about a topic. This right is now being redefined in virtual learning environments.

Oftentimes the relationship between learners and their teachers is not static but constantly in motion, much like in the teeter-totter analogy. Sometimes the teacher sits in the position of power, sometimes the student; sometimes they are balanced learning equally from one another. Weiss (1992) discusses this co-learning theory in which teacher/learner positions shift. In co-learning, knowledge and learning is shared and there is a co-reliance between teacher and pupil. Tom provides an apt description: “My computer teacher, Mr. Tyler knows the software programmes. He helps out and I'll figure out certain things, different ways of doing it and he'll say, “That's great!” It will go back and forth . . . I think it's more of a reciprocal exchange” (Black, 2002: 260). Co-learning situations such as these vary in terms of duration and intensity from relationship to relationship. Students describe their co-learning experiences in laudatory terms, using such adjectives as “beneficial”, “exciting”, “wonderful”, and “amazing”, often observing that co-learning personalizes their relationship with teachers.

Teachers, however, approach co-learning more cautiously because they feel that some students are unable to handle the shift of power between themselves and teachers. They warn that students not only need to be tech-savvy and able to teach but also be adaptable, respectful, sensitive, and mature. Teenagers must have “people skills” and be able to make sagacious decisions beneficial

to their school. This is a demanding role for which many are simply too young. At both schools some students take advantage of their new power. They have, for example, actively tried to undermine their teachers through the privilege of their positions. Interviewees at both schools commented on tech-savvy students who developed arrogance, feelings of superiority, and became, to borrow a phrase, “full of themselves”. Moreover, another detrimental factor with student empowerment is pupils who overstep the limits and hence further abuse their position. For example, one teenager at Pleasant Dale, Luke, broke into a security system and was banned from computer usage for a year. Another student, Michael, much trusted at the same school, served as a technician and ended up deceiving his peers who were relying on him for important technical information. Yet another pupil who was a technician at Pleasant Dale mishandled highly complex computer equipment (SGIs) which sat for a seemingly interminable length of time in disrepair. Other students at both schools illegally hacked into systems, or granted some of their peers’ favors while excluding others. Moreover, handing over power to students can place teachers in vulnerable positions as the power dynamic shifts. To begin with, teachers find that they cannot assert their authority in the traditional manner, notwithstanding the many educators who successfully empower students and do so effectively. Many students, however, do meet the demanding role and meet it well. In summary, teachers and teenagers at both schools often describe their positions as shifting: the teacher becomes the student and the student becomes the teacher in these new forged relationships.

#### 9. DISPLACED STUDENT TEACHER EQUILIBRIUM IN SCHOOLS AND IN THE WORKFORCE

Teachers are taught by teenagers in a variety of ways ranging from informal, spontaneous after class discussions, private tutorials and workshops, to more formal student led class presentations and lessons. The benefit, according to teachers, is that it is an effective way to develop skills and learn needed information. In the case of teachers at Pleasant Dale, students’ help and advice are invaluable as teachers have so little opportunity to learn the material through other avenues. One teacher even calls upon tech-savvy students for help during the night when she is grappling with technical problems. Students feel empowered through taking on a more active role in the learning process. Teenagers and their teachers have described these exciting new forged relationships in terms of a paradigm. Joe, a student in WiredIMAGE shares his perceptions:

“I think what’s important is just to understand that we are on a paradigm shift as far as the industrial revolution began [sic] in the 16th Century. Now we’re in a new revolution where computers are turning the way we

do everything and anything around: jobs are completely being turned around. What my point is that education is going to have to take a huge turn . . . Because of technology (everything ties back to technology) the way anything is done is changing including education. I think that's very important to remember: we are watching and I am part of what is going to be shaping the next hundred years of education . . .

(Black, 2002: 264)

Many students reflect that their relationships with teachers are more personal, more caring, and closer. Louise, Dylan Emma, and Zoe comment that the teacher's ultimate role is more than to simply give students marks. They share knowledge and learn together. Respect and trust are key issues. For instance, Lyle comments on his relationship he established with Mr. Tyke:

Mr. Tyke certainly had no lack of technical knowledge, but was new to some of the things that I was teaching him. Not only was he willing to put the teacher's ego aside and learn from a student, but he was a fast and enthusiastic learner. His ability to learn from me only increased my respect for him as a teacher . . . My relationship with Mr. Tyke was unusual. I think our relationship was different because we had common interest and goals for the school, and worked together to implement them. But more importantly, he always treated me with the utmost respect . . . like an adult.

I always told him that was important to me, and he said that he treats people the way they deserve to be treated. Some students need to be treated like kids, but some really deserve to be on an equal level. I completely agree, and I think that this is one of the most important components of a good student-teacher relationship. I think this was also a key in our collaboration. He trusted me completely, so it was easy for me to design the course the way I wanted to. He obviously had suggestions for formatting it appropriately for the classroom and because I respected him so much, I had no problems taking those suggestions

(Black, 2002: 275-6)

In fact, friendships have been established at both schools between students and their teachers and in most cases this lasts well past those students graduating and leaving the school: It is not uncommon for these students to keep in touch and visit their former teachers with whom they had close collaborations. Students often talk about getting to know their teacher better not only in the teacher/student role but on a more personal basis as a consequence of spending so much time working together. Hence, as a result of working with technology, a close camaraderie often develops between learners and educators which break down traditional hierarchical institutionalized school barriers.



Within this new power dynamic, students are creating a new hierarchy in their school institutions, and with this, reconfiguring their role and status. More power is being handed over to them by educators which place them in positions of power over their peers; in addition it situates them in a more powerful role with their educators; moreover, power provides tech-savvy teenagers more control to shape their virtual learning environments. Through controlling high powered technologies, the tech-savvy students affect numerous people in their pedagogical institutions. Consequently, these new techno-literate teachers and pupils are creating new positions of control and status through the redefinition of their roles and relationships. Sean reflects upon the changing times:

It's different: it's breaking down walls that were put up and have been instilled for centuries upon centuries, upon centuries, upon centuries. It's all related to the hierarchy: armies, monarchies, and royalty. It's all about, 'I'm the king and you're next in line, then you're next in line, then you're next in line.' If buddy at the top tells buddy at the bottom to do something then he'd better do it . . . it's about computers and technology being a new emerging field. It's advancing so rapidly that people are . . . trying to keep up with it because it's growing at such an exponential rate. Because of that and because of the way the technology works, it sort of changes the model of communications between people. It breaks down a lot of the barriers that were once cast in stone. The way business is done now filters down into other types of relationships and the way people have them . . . It's a different way of looking at things and it is the new world way of looking at things. The long and the short of it is that it's a change in style of communication between people . . . It ends up being more of a perspective where on everybody's front you are breaking new ground; you are going against the social norm. Nowadays at least it's the social norm but in previous generations it wasn't

(Black, 2002: 320–321)

Sean is describing the displacement of student–teacher equilibrium in virtual learning environments. This new model also extends outside of arts education classes; in fact outside of classes in all subjects using new digital technologies, and is even prevalent within our communities. The new dynamic model is visible in relationships forged within our families and within the workforce. For example, Sean talks about conflicts that have arisen with his father who lacks technological knowledge. Sean's father refuses to take any computer advice from his son even though he needs help, owing to his belief that a "father knows best". Sean also relates his experience working with digital technologies at a major public education television station. He has been hired to oversee a man at least 20 years older than himself, which is a situation requiring great diplomacy for, in some areas the man has knowledge far greater than Sean's. Nevertheless, Sean was hired to do a job and do it well,

which included his own work as well as overseeing the work of an elder. In fact, articles abound about tech-savvy teenagers starting up and running their own digital companies, creating new software, and sometimes even making fortunes (Coolidge, 1999; Ramirez, 2000).

Some students acknowledge that the new teacher–student dynamic is excellent training for the future because they may find themselves in the position in which they may know more about the technical aspect of the company they end up working for than does the president. Both Tapscott (1998) and Negroponte (1995) write about this new situation. In the media there are numerous articles and fictional portrayals of new relationships being forged between people in positions of power being helped by tech-savvy teenagers and even little children. One student I interviewed talked about an advertisement by Alta Vista in which a small child beats one of the world’s best chess players through the help of a computer chess program. Other examples are of administrators and professors seeking technical help from their students (Parrish, 1999; Smith 2000), parents being assisted by their tech-savvy children (Belkin, 2000), the elderly being taught by children their grandchildren’s age (Cantarano, 2000; Shenk, 2000; Wallace, 2000), and employees training their bosses (Orlanda Sentinel, 2000; Parrish 1999).

## CONCLUSION

In summary, relationships between the “haves” and “have-nots” of authority are being reconfigured, thus breaking traditional hierarchical and institutional barriers. These new power relationships are constantly in flux, being shaped, negotiated, reshaped, and renegotiated by tech-savvy teenagers and the authority figures with whom they form associations. In this paper I have discussed case study research in which I outlined how traditional student–teacher relationships are changing in virtual learning environments within two schools. I specifically examined how these relationships are not only reflective of what is occurring within educational institutions but also of our society as a whole as it radically transforms through the influence of digital technologies. In the last decade, newer upon newer digital technologies have constantly upstaged their predecessors while infiltrating markets at an unnervingly quick pace. As a result, new software and hardware packages have affected marketplaces, businesses, homes, and educational institutions. It remains to be seen whether digital innovators can keep up this frenzied pace. If they cannot, perhaps we will see the new power dynamic slowly shifting back to the traditional one as people holding power learn the technology, tech-whiz kids take positions of responsibility in the workforce, and new educators have obtained in their own educational training superb technological instruction and support from elementary through to high school and university. If, however, the industry can continue their innovative pace in the future we can expect topsy-turvy

relationship dynamics to occur in our society for years to come. Consequently, in the future it remains to be seen whether the teacher and student on the teeter-totter will once again revert back to the educator holding the pupil in subordinate suspension or whether they will both remain in flux, sharing the ride.

## REFERENCES

- American Association of University Women (AAUW) Educational Foundation. (April, 2000). *Tech-Savvy: Educating Girls in the Computer Age*. Washington, D.C.: AAUW.
- Bagley, C., et al. (1994). *The Shared-Ownership Technology Model: Restructuring the Classroom*. Minnesota, U.S.A.: The Technology Group.
- Belkin, L. (2000, December 6). An office tour for mom and dad. *The New York Times* (Online). Available at: <http://proquest.umi.com/pqdweb?TS=. . . &Sid=3&Idx=50&Deli=1&RQT=309&Dtp=1>.
- Black, J. (2002). Topsy-turvy teacher–student relationships: an examination of digital multimedia teaching and learning (Doctoral dissertation, University of Toronto, 2002). *Dissertation Abstracts International* 63, 06.
- Cantarano, D. (June 1, 2000). Generations bridge digital gap: seniors receive tech schooling from teenagers. *Denver Post* (Online). Available at: <http://proquest.umi.com/pqdweb?TS=. . . &Sid=15&Idx=10&Deli=1&RQT=309&Dtp=1>.
- Carey, D. (1993). Teacher roles and technology integration: moving from teacher as director to teacher as facilitator. *Computers in the Schools* 9(2/3), 105–118.
- Collis, B. (1989). *Using Information Technology to Create New Educational Situations*. Paris, France: UNESCO International Congress in Education.
- Coolidge, S. (July 26, 1999). I'll be home late, mom. Big meeting. *Christian Science Monitor* (Online). Available at: <http://proquest.umi.com/pqdweb?TS=. . . &Sid=13&Idx=1&Deli=1&RQT=309&Dtp=1>.
- Cuban, L. (1993). *How Teachers Taught: Constancy and Change in American Classrooms, 1880–1990*. New York: Teachers College Press, 205–290.
- Doud, R. (1998). *Two Essays on the Learning Paradigm*. Opinion paper, United States Department of Education.
- Foucault, M. (1972). *The Archaeology of Knowledge and the Discourse on Language*. New York: Pantheon Books, 215–238.
- Gregory, D. (1995). Art education reform and interactive integrated media. *Art Education* 48(3), 6–16.
- Greh, D. (2002). *New Technologies in the Artroom*. U.S.A.: Davis Publications.
- Hannafin, R. & Savenye, W. (1993). Technology in the classroom: the teacher's new role and resistance to it. *Education Technology* 33(6), 26–31.
- Haycock, C.-A. (1991). Resource-based learning: a shift in the roles of teacher, learner. *NASSP Bulletin* 75(535), 15–22.
- Healy, J. (1998). *Failure to Connect: How Computers Affect Our Children's Minds—For Better or For Worse*. New York: Simon and Schuster.
- Hitchcock, G. & Hughes, D. (1995). *Research and the Teacher: Qualitative Introduction to School Based Research*. New York: Routledge, 316–340.
- Hoffman, R. P. (1996). Levels of technology use and instructional innovation (Doctoral Dissertation, The Claremont Graduate School and San Diego State University, 1996). *Dissertation Abstracts International* 57, 3797.

- Jeffers, B. B. (1992). Perceptions of communication patterns in computerized classroom: a qualitative examination. *Unpublished master's thesis*, California State University, Fullerton.
- Jones, B. F., Valdez, G., Nowakowski, J., & Claudette, R. (1995). Plugging in: choosing and using educational technology. *EdtTalk* (Online). Available at: <http://www.ncrel.org/sdrs/edtalk/html>.
- Jordan, W. R. & Follman, J. M. (1993). Using technology to improve teaching and learning. *Hot Topics: Usable Research*. U.S.A.: Southeastern Regional Vision for Education.
- Knupfer, N. (1992). Educational computing and school change: influences on teachers' roles and pedagogy. In: Simonson, M. R. (Ed.) *14th Annual Proceedings of Selected Research and Development Presentations*. Washington, D.C.: Iowa State University, 462–464.
- Knupfer, N. (1993). Teachers and educational computing. Changing roles and changing pedagogy. In: Muffoletto, R. and Knupfer, N. (Ed.) *Computers in Education*. New Jersey, U.S.A.: Hampton Press Inc., 163–179.
- Koehn, H. (1986). Techtrends interview. *TechTrends* 31(2), 27–31.
- Lai, K.-W. (1993). Teachers as facilitators in a computer-supported learning environment. *Journal of Information Technology for Teacher Education* 2(2), 127–137.
- Laino, J. (1994). Staff development in the age of technology: recycling the experienced teacher. *Dissertation Abstracts International* 55, 3368.
- Luke, C. (1996). Ekstasis@cyberial. *Discourse: Studies in the Cultural Politics of Education* 17(2), 187–207.
- Len, M. (1993). The media education revolution. *Canadian Journal of Educational Communication* 22(1), 5–14.
- Meinster, B. (1990). An in-depth investigation of teachers using computers: three case studies. *Dissertation Abstracts International* 51, 3711.
- Merriam, S. B. (1998). *Case Study Research in Education: A Qualitative Approach*. San Francisco, California: Jossey-Bas, Inc.
- Negroponte, N. (1995). *Being Digital*. Toronto: Random House of Canada Limited.
- O'Neil, J. (1995). On technology schools: a conversation with Chris Dede. *Education Leadership* 53(2), 6–12.
- Parrish, K. (November 22, 1999). When a glitch strikes, students always save the days. *Morning Call* (Online). Available at: <http://proquest.umi.com/pqdweb?TS=...Sid=23&Idx=50&Deli=1&RQT=309&Dtp=1>.
- Pearlman, R. (1989). Technology's role in restructuring schools. *Electronic Learning* 8(8), 8–9, 12, 14–15, 56.
- Pelgrum, P. J. & Plomp, T. (1993). Educating the educators. In *the IEA Study of Computers in Education: Implementation of an Innovation in 21 Education Systems*. New York, U.S.A.: Pergamon Press.
- Ramirez, C. (June 25, 2000). Computer-savvy teens turn e-commerce bosses. *Detroit News* (Online). Available at: <http://proquest.umi.com/pqdweb?TS=...&Sid=14&Idx=1&Deli=1&RQT=309&Dtp=1>.
- Saye, J. W. (1994). Teachers, technology and the acceptance of innovation. *Dissertation Abstracts International* 55, 2704.
- Saye, J. W. (1997). Teaching and educational empowerment: students' perspectives. *Educational Technology, Research and Development* 45(2), 5–25.
- Saye, J. W. (1998). Technology in the classroom: the role of dispositions in teacher gatekeeping. *Journal of Curriculum and Supervision* 13(3), 210–234.
- Schofield, J. (1995). *Computer and Classroom Culture*. U.S.A.: Cambridge University Press, 94–133, 190–228.

- Sheingold, K. & Hadley, M. (1990). *Accomplished Teachers: Integrating Computers into Classroom Practice*. New York: Center for Technology and Education, Bank Street College of Education.
- Shenk, R. (November 21, 2000). Penn Manor turns kids into computer teachers for seniors. *Lancaster News Era* (Online). Available at: <http://proquest.umi.com/pqdweb?TS=. . . id=341dx=144&Deli=1&RQT=309&Dtp=1>.
- Silverman, B. (1995). Computer supported collaborative learning. *Computer Education* 25(3), 81–91.
- Sivin-Kachala, J. & Bialo, E. (1994). *Report on the Effectiveness of Technology in Schools*. New York, New York: Interactive Educational Systems, Inc.
- Smith, S. (Spring, 2000). Graduate student mentors for technology success. *Teacher Education and Special Education* (Online). Available at: <http://proquest.umi.com/pqdweb?TS=. . . Sid=23&Idx=33&Deli=1&RQT=309&Dtp=1>.
- Stake, R. (1994). Case studies. In: Denzin, N. and Lincoln, Y. (Eds.) *Handbook of Qualitative Research*. California, U.S.A.: Sage Publications Inc., 236–247.
- Tapscott, D. (1998). *Growing Up Digital: The Rise of the Net Generation*. USA: McGraw-Hill.
- Tapscott, D. (1999). Educating the net generation. *Educational Leadership* 56(5), 6–11.
- Trailblazers, not geeks lead the way (27 April, 2000). *Orlando Sentinel* (Online). Available at: <http://proquest.umi.com/pqdweb?TS=. . . Sid=15&Idx=20&Deli=1&RQT=309&Dtp=1>.
- Wallace, S. (November 19, 2000). Surfin' seniors click with new technology: teens teach older residents about computers. *Denver Post* (Online). Available at: <http://proquest.umi.com/pqdweb?TS=. . . id=34&Idx=150&Deli=1&RQT=309&Dtp=1>.
- Weiss, J. (1992). Dances with Knowledge: Co-learning as a Teaching/Learning Process. *Paper presented at the Annual Conference of the Canadian Educational Research Association on "Contemplating Co-learning: Teaching Learning Reconceptualized"*, June, 1992, Charlottetown, PEI.
- Willis, B., et al. (1985). *Technology and Learning: Changing Minds in a Changing World. Schooling and Technology*, Vol. 4. North Carolina: Southeastern Regional Council for Educational Improvement.
- Wiske, M.S., et al. (1988). *How Technology Affects Teaching*, Report No. ETC-TR87-10. Massachusetts, U.S.A.: Educational Technology Center at the Harvard Graduate School of Education and Education Development Center, Inc.
- Wood, K. & Smellie, D. (1990). *Educational Technology: Initiative for Change*. Utah, U.S.A.: Department of Instructional Technology, Utah State University.
- Yin, R. (1989). *Case Study Research: Design and Methods*. California: Sage Publications Inc.

## Chapter 21: Rural South African Teachers “Move Home” in an Online Ecology

ELIZABETH HENNING

*University of Johannesburg, Johannesburg, South Africa*

### 1. INTRODUCTION: CROSSING THE DIVIDE FROM A DIFFERENT ANGLE

This chapter presents a narrative of six rural South African teachers' first encounter with e-learning, showing how they learned to act in an ecology that required new epistemological tools. The purpose of the chapter is to address the dominant discourse in educational information and communication technology by giving a glimpse of the lived experience of the research participants who took first steps in crossing the digital divide. These first experiences have shown clearly how the online curriculum needs to be redesigned in order to capture the lifeworld of the students as scaffold for entering the online community. They began to develop both technologies of mind and of *hand*, challenging their existing learning conventions and they discovered, if only emergently, how to be part of a *distributed cognition* system. They also learned how to improvise in *situated cognition* situations (Brown, 2000; Nardi, 1996: 69–98), fashioning emergent ecologies of learning in the process. The main findings of the inquiry pertained to the way the teachers experienced this epistemological and pedagogical shift. They saw the process of *learning to e-learn* as a “move” or a relocation of their cognitive activity, while at the same time also situating their learning in a supportive social setting. They had indeed begun to make the “move”, but the process had only started, and they were struggling with many of the same issues that challenged them in advanced degree studies in conventional face-to-face situations; they continued to desire linearly structured curricula with fixed parameters of content and prescribed processes of engagement.

Despite the dominance of a legacy of rote-learning, there were nevertheless encouraging signs of the genesis of an ecology of learning, which may develop and scaffold their learning, both in electronic and face-to-face format. The catalyst for change was not so much the use of computers and of the e-learning environment itself, but the assistance and scaffolding they spontaneously provided for each other. In this chapter, I argue that working to assist each other in small blended learning communities that form spontaneously may be the preferred way forward for adult learners who encounter the technology as mature students who cannot become part of a discourse community on a campus, or directly on the *Infobahn*.

## 2. ONLINE RESOURCES FOR OPTIMAL SCHOOL AND COMMUNITY DEVELOPMENT

One of the surprising features of rural life in Southern Africa is the rate at which computers and the internet are entering people's lives. Due to numerous efforts by the private sector and Non-Government Organisations (NGO's), as well as governments, this technology is found in small telecentres such as those in the hinterland of Australia (Oliver, 1996) and in many homes and some schools. Often computers that are discarded in the corporate and the public sector find their way to villages and to farms through the system of "pass-on" and "hand-them-down" that is characteristic in a milieu where little is trashed, because someone will know of somebody who can use a tool, a piece of clothing or even food. When traveling on the main roads out of cities over weekends it is not an uncommon sight to see vehicles packed with second hand items on their way to distant villages and even to neighboring countries. In my own work in villages in the north of the country I have come across computers and internet connections in the most unlikely places. With the extension of electricity, some distant schools are now slowly acquiring computers and also internet facilities. There are also a few schools in the country where solar power is used to generate electricity for online connection. Many of these initiatives have been due to the entrepreneurship of local people who have approached funding agents to assist with the technology. There are also continuous professional development programs for teachers in different guises, making use of online learning. Many of these, however, have been launched with the aim of acquainting teachers with curriculum reform more than to scaffold their independent learning. My concern in many of these projects has been that the difficulties with full engagement with the *activity system* (Kaptelinin, 1996) of online learning has not been acknowledged sufficiently. People may learn some computer skills and also how to access information on the internet, but full participation in the medium, beyond, "clicking for survival" (a phrase from one of the interviews conducted in this study) eludes many. Hence my undertaking to explore how teachers who have not been involved in any of these very promising initiatives experience a first encounter with e-learning. I deliberately selected advanced degree students (who are practising teachers) to rule out most problems with literacy and learning. In studying a group of these teachers, I specifically wanted to find out if and how they "moved" their learning and how they changed their processes of communication and scaffolding as learners.

I thus set out to look for clues of how they embraced the activity system of online learning, cognisant of the fact that the jury is still out on e-learning uptake generally (Curtis & Lawson, 2001; Oliver & Omari, 2001). The need for such clues, searched for at grassroots level and in small groups of learners, where the detail of uptake and of learning may be observable, becomes imperative when the spread of the technology is considered and the concern

increases that the tools may be utilized within the constraints of information only. I would argue that the people who will have to be the human resources to facilitate the uptake of online learning and who will do so with wide usage of the affordances for distributed cognition, will themselves have to have had some successful e-learning experience. In my exposure to e-learning (and e-teaching) I have become aware that the teachers, also in higher education, who “transfer” their curriculum to the internet without having themselves experienced learning in this mode, are less capable of utilising the affordances of e-learning—especially the opportunities for distributed cognition. Therefore, if access is accelerated, without the acceleration of teachers’ understanding and experience of e-learning as way of doing education in distributed mode, the uptake may be slower and may even become replications of print format distance education.

Not only would this impede uptake in schools, but it would also slow down the spread of information to communities where access to information may have an impact on people’s lives at a very basic level, such as food security and health. Community education is becoming a focal point of many government agencies and has always been the focus of NGOs in the developing world. If competent teachers and their students can become sources of information and scaffold access to electronic information they may become the true community educators (Daniels, 1999). However, community education is by its nature based in small groups, and mass education of a rural population is not viable. Small emergent communities, or *ecologies* (in the metaphor of Nardi & O’Day, 1999), could slowly influence the learning and development patterns of socially vulnerable rural populations. In focusing on teachers who encounter e-learning, I am not thinking of how they can improve school education only, but how they could affect “keystone species” in emergent ecologies of information and learning (Nardi & O’Day, 1999) beyond the school as well.

### 3. IDENTIFYING THE UNIT OF ANALYSIS AND DESIGNING THE CASE STUDY

When I first contemplated an inquiry in which I could capture some of the experiences of first time adult e-learners’ engagement with online learning activities, I selected a group that would exemplify the unit of analysis: *adult learners’ first encounter with e-learning*. In selecting the master’s students, who were also teachers, as central component of the unit of analysis, I had delineated the study and the “bounded system” of the case (Henning et al., 2004; Stake, 2002). Stake’s definition of the design type, *case study*, has become an accepted description of what this type of research exemplifies, and the term “bounded system” is its most discerning characteristic. In deciding on how to go about this research I selected a group of students of whom, I believe, a case study of first time e-learners’ experiences could be conducted.



I have access to research into a number of different groups in e-learning environments, but the set of students that were most eligible for the type of research I had in mind were practising teachers in a part-time M.Ed program at a university in a South African city. The module *Qualitative Research and Writing Composition* was one of six courses in the program and was developed to simultaneously run online and face-to-face in order to accommodate especially those students who live far away from the university. Most of these students had expressed the need for more opportunities to engage with the course presenters and their peers. However, face-to-face engagement was limited to weekend workshops once or twice per month. As the University had already initiated WebCT facilitation of either complete or hybrid/blended (“brick and click”, Weigel, 2002) online courses, the partial conversion of the existing course to a parallel, interactive e-learning version could proceed. The course was adapted to provide optimal networking and interaction and to introduce the first time e-learners to the network/information society without expecting them to continue entirely on their own in a virtual learning environment—the scheduled workshops therefore continued.

I selected 6 students from the cohort of 33 students in 2001. The research group or sample consisted of three pairs of students who opted to work together closely and who lived within reasonable proximity to each other. Students in this course were encouraged to work in pairs or small groups and they selected their own partners pragmatically. The three research pairs thus already existed learning dyads when they were selected purposefully (Merriam, 1999) for the inquiry. They were chosen because they were the most uninitiated in computer tool use and suited the criteria for the case narratives—they would show the *realia* of everyday living and of studying. The following criteria were considered:

- The adult learners had returned to university for an advanced professional degree.
- Students lived at least 200 km from the university in semi-rural areas.
- Students speak at least three languages, with English having been their language of formal education since high school at least.

The data that were collected were from the students’ engagement with the course over a period of 6 months (the duration of the course). All their discussion postings, some email, their other learning artifacts, such as qualitative research designs and term papers, were also scrutinized for data pertaining to their experiences in engaging with the course. The most revealing data, however, came from their personal reflection journals. These data were narratively-rich (Bell, 2002; Clandinin & Connelly, 2000; Cotel, 2002; Pavlenko, 2002; Riessman, 2002) and had sufficient ethnographic qualities (Hammersley & Atkinson, 1995; Wolcott, 1994) to convince me that I also needed interviews in which they could tell their experiential stories—the “way of life” (Wolcott,

1994) that they had cultivated in the course. With the help of a co-researcher I therefore conducted two sets of individual interviews and also one focus group interview, asking questions related to their “lived experience” and following the same interview protocol with all the interviewees.

We worked with the data in two ways, capturing *content* as well as *discourse* and concomitant stories (Gubrium & Holstein, 2002). We anticipated that the “actual practices of talking and writing” (Woodilla in Phillips & Hardy, 2002: 3) and the “interralated set of texts, the practices of their production, dissemination and reception that brings an object into being” (Phillips & Hardy, 2002: 3) would be reflected by using different ways of analysis. The existing texts (the web-based communication) and the learning artifacts were prepared for analysis by formatting them into analysis texts and the interviews were transcribed. The processes of working/analyzing the data proceeded are set out in Table 1.

The narratives were thus constructed systematically from the different data sources via the various analysis modes (“working the data”, according to Holliday, 2002). *Content*, *discourse*, and *narrative* data were crystallized into elements of the eventual stories. In the rest of this section I will present excerpts from these stories of the three dyads. The main themes that were collated towards the end of the analysis process (in the last row of Table 1) were configured into the portraits that follow, with the title of each portrait reflecting aspects of the theme and revealing more about the unit of analysis, which is the students’ engagement with the course.

In the rest of the chapter, I will present summarized versions of the stories of the three dyads. As mentioned previously these narrative portraits were constructed from all the data sources, with emphasis on journal data. Subsequent to the narratives follows a discussion of the significance of these stories, using the framework of Bonnie Nardi and Vicki O’Day’s (1999) “information ecologies”, integrated with the aspects of activity theory, distributed cognition and with the notion of “cognitive apprenticeship” (Brown et al., 1989; Salomon, 1999). I use this construct to also illustrate an epistemological apprenticeship—learning to see knowledge and knowledge making in a new way and finding a new habitat for doing this. In Figure 1 I present a diagram of how these three theoretical sets were used to integrate my understanding of the research.

#### 4. THE STORIES OF THE TEACHERS

Each of the following three narratives comprises a portrait-like description of the two members of the dyad and of moments in their learning path over one semester. The information contained in the descriptions comes from all the data sources, although the citations are from the journals only.

Table 1. Working the data towards narrative portraits

Working Procedure	Data Source		
	Discussion Postings and Email Communication	Learning Artifacts	Interviews and Journals
<i>Content analysis:</i> coding and categorizing	The content of what they wrote—coded in units of meaning, categorized and clustered in grounded theory analysis mode	The content of their production of artifacts adjudicated and then coded according to the performance criteria of the course and clustered	What they said—coded strictly in terms of content and then categorized and clustered in grounded theory mode
<i>Discourse analysis:</i> identifying discourse markers related to how they were constructing meaning of course content and mediation, support, and social context	Locating the system of meaning from which they were expressing their own sense-making. “Marking” stretches of language with an inductive code/marker of discourse	Locating the artifact in the discourse of a theory of learning and also of activity theory levels of action (both as systems of epistemological meaning)	Locating their talk/text in a discourse and identifying references to discourses. Capturing how they were making sense of their experience by invoking these discourses
<i>Narrative analysis:</i> identifying stories of experience—locating sequential markers, characters, settings, actions, tool use	Elements of stories, episodes, and examples with a story element. Grouping story markers and chronology	Identifying whether the artifacts aligned with learning products, the stories of learning that have been told	Capturing the elements of their experience in narrative
<i>Cross method collation of content, discourse and narrative themes</i>	The main themes and categories at the level of content	The main discursive indicators reflecting the dominant discourses. Identifying the main metaphors and meaning-making structures	The stories and how they articulated in other stories. The essence of individual stories as reflected <i>across the data sources</i>

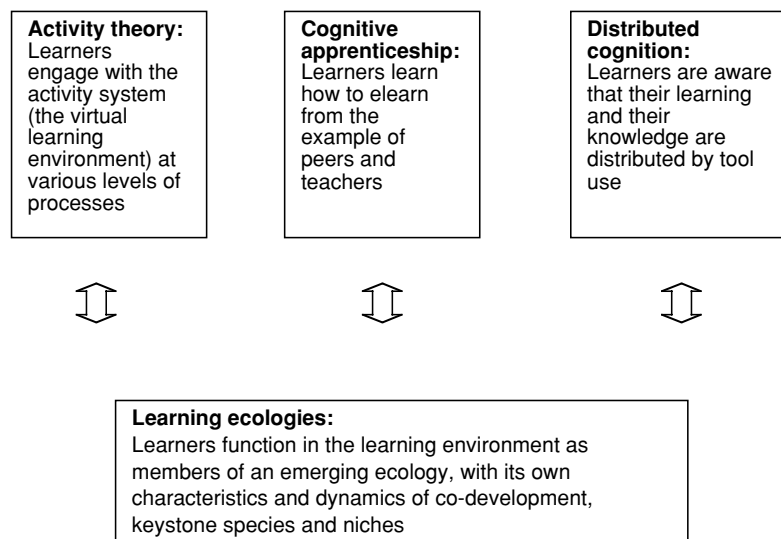

Figure 1. Connecting four theories for interpreting adult learners' e-learning narratives.

#### 4.1. Dhimpo and Penny: Are We in this Machine or Is it in Our Heads?

The first story tells of how Dhimpo and Penny engaged with the online course and what they communicated to each other. Dhimpo is a 45 year-old woman who teaches at a high school in a village that is 40 km from the nearest town. Recently electricity and running water were introduced to the village, but the infrastructure for this connection and reticulation is still poor. The school accommodates 730 students and Dhimpo is one of 19 teachers, but the only one who is licensed to teach Biology at 12th grade level. She was introduced to computers in the previous semester in the skills development program in the Faculty of Education at the institution where she is studying. She travels 344 to the university to participate in workshops and to use the library twice per month. Dhimpo speaks Sepedi, one of the eleven official African languages of South Africa. She also speaks Tsonga and Setswana and Sotho. She learned English in school and uses it only outside the village and for pedagogical purposes in the school. She completed her previous degree at the major distance education university in South Africa.

Penny lives in a town, where she teaches in a *township*<sup>1</sup> school. She is an English teacher and also encountered computers interactively for the first time during the semester prior to the one reported in this chapter. She speaks all the languages that Dhimpo speaks, but is also conversant in Afrikaans, which is a language of Dutch descent. Penny studied at the same institution and also at a university that was created for black South Africans during the apartheid era, when these institutions were established in the segregated "homelands" for different African ethnic groups.

The first entry into Dhimpo's journal already set the scene for her engagement with the course. She was wondering,

Are we in this machine or is it in our heads? I am wondering because I feel when I click and start that it is sweeping me off my feet. I feel I am watching a cinema film (movie) but that I am also in it. When I wrote my first discussion posting I was so afraid. Would this get to the others? Will they laugh? What will Prof say? I am still very much mixed up. I feel I have not the same control as before. I type and I read and I am scared to click, because when I do that I feel I am falling down—like I slip and I slide on the wet ground. I will read more. That is also not so nice. Hey—when I click and there is this magic page I feel I want to quickly print it. Before I lose it. I want to read it on paper. Maybe I don't trust the computer. Maybe I don't trust myself. And even when I read and then there is a blue part (hyperlink) I feel I must first go there, because this man he put it there because he wants me to go there too. But hey—I do that and then I'm lost because I get mixed up—I go on a different path and get lost in the bush. Where is my head—is it in the machine? Then I go back and I first read the whole one. It is hard to ignore the blues. And I can say that I am not very much confident that I will learn this way. I can't wait for the next workshop to talk and to see if there is something on the reserve in the library. And I will phone Penny. I know I must email her, but first I am going to hear her voice.

Penny was also grappling with the conflict of who was in charge in the learning environment—who was “in her head”. She, however, decided to speak to Dimpho before she wrote in her journal. In an interview they referred to this telephone conversation. Penny dialled and when Dimpho picked up the phone she was curious to know how Penny was feeling. Penny said that she was too scared to even write, because she did not “trust her mind”. She did not know whether what she was experiencing was “real”, or whether she was “dreaming up ideas just to get something on paper”. They concurred that the first online learning unit had been “terrifying, because (we) felt so hopeless and so homeless”. Penny said she felt “like I had moved my house. This machine was there in my room, but it was not mine. It was not me. My fingers walked, but I was not sure if my mind was there, walking too”. In this telephone conversation they decided to “be brave and to write up how (they) were doing in terms of the coursework in their journals”, but that they would consult each other if they were concerned or did not know what to do.

Penny eventually did make an entry in her journal. She was especially concerned with the exhibition of her work and the public scrutiny.

So at last I am writing. I still don't know how to say it, but it keeps on eating at me. . . . How will I be able to write my work when I know

that the whole class (and maybe even some others)—their friends and whoever they may want to call and say—come and look at Penny’s work. Ha-ha, she does not get it!! She is mixing things up. She is copying and she will get fined for her plagiarising. I can’t stand the thought of people reading my work. I think it (her work) is not too bad—I am not a bad student, but I want my things to be safe. So, Prof, when you one day read this—and then it will be too late because the course will be finished—please remember that I don’t think this is a good idea and that I will take feedback from you or my teachers but I really don’t trust my fellow students. Maybe they are even *skelms* (rogues) who will steal my ideas and copy them. Maybe I will even see my ideas on someone else’s distinction. So that is what I write for today. I haven’t said yet that I am slow on the computer and that the internet work is maybe fascinating and I like to travel so quickly to another place and meet with someone who I don’t know, perhaps I don’t like this person at all, and I don’t even know where the country is but I learn a bit from their page. Still, I want to do this alone rather. My head is my head—like Dimpho said—she was worried because she thinks her head is mixing with the wires, well I don’t care about that. I just don’t want others to come and sit in my head or on my head! This learning feels a bit like a jail. I miss real old classes and lectures and even the distance education by post where the lecturer wrote to you and the work was in a guide.

These two women were very careful at the outset. They both did not have a computer, and were wary to invest in one before they were sure that it would be worthwhile. Buying a computer, a printer, and keyboard and monitor amounts to 2 months of netto salary of the average state employed teacher, she assured me.

So, as a start, Dimpho used the *telecentre* next to her school. This is a privately owned enterprise, where the community can use cell phones, telephone landlines, fax machines, computers, and printing and copying facilities and also the internet. I went to the centre on two occasions to observe some of the activity and found an efficient enterprise, owned by an ex-teacher. The centre is situated next to the school and also adjacent to the local community health clinic. The newly installed telephone lines contrast strongly with the building, which was previously a two-roomed house. Inside the building the electricity connections, with wires taped to wall, ceiling, and even floor surfaces, continue to illustrate this contrast. Two youngsters dressed in uniforms with logo tee shirts advertising the enterprise work in the waiting room (translated as the “Talk-talk Shop”). There are two computers, one fax machine, a (really vintage) copy machine, two telephones, and three cell phones. It costs the equivalent of a cup of coffee in town for 10 minutes on the internet or on the phone. The cell phone is double the price.

The centre from which Penny worked looks more like an internet café and also operates along those lines. It is much more sophisticated and there are 10 computers—all internet connected. The price for services is slightly lower.

As time went by both the women decided to invest in their own computers and internet connection. They were fortunate because they could purchase the technology through a wholesale agent. They convinced each other—comparing the cost to that of cable television and video recorders and also to instalments on car payments.

Halfway through the course Penny noted in her journal:

I am now not yet used to working from my house. When I connect and “speak” to the others I am still so thrilled. I am actually quite happy. We are all in the same boat, but I think mine is a bit rockier. I forget to close the modem and I have had to pay so much. But I’m not sorry I paid all this money, because I can sit here after supper and talk to my friends in the course and I can SURF THE WEB! I don’t do general things—we were warned in the course that it is better to start from the sites that have been suggested, but I am learning to find my own ones too. And I am still worried about giving my ideas in the discussions and to put up my own work so that they can all read it and give me tips. I don’t trust it yet. But I am learning a lot. I see that most of the people in my class have the same problems.

At this time Dimpho was experiencing different problems.

I am finished—FINISHED!! Too much trouble with the connection and sometimes the university’s lines are gone! And when I post something it disappears, I feel I want to see my work in pen or printed, but like this it scares me. I am losing the control I had. I feel my mind is gone when the typing is gone.

Both Penny and Dhimpo were surprised at what they had done—both in learning to work in this mode and in purchasing the hardware and registering with an internet server. For them these were two giant steps. However, they never really engaged fully with the discussions and remained unsure of their work on display. In this there were ample signs of “cutting and pasting” and of a need for more explanatory assistance. They had begun the apprenticeship of being in a virtual learning environment, but the course itself was still not part of the change. They continued to look for content and to try to “learn” this content. Even though they were learning to navigate a personal learning path in the virtual environment they still believed that the ultimate aim was to find and then to “know content”. Penny said at one stage, and it was affirmed by Dimpho, that the “knowledge” they encountered was strange and mixed—like “our feelings”. These two teachers were fast learning the “hand technology”,

but had yet to make the shift to the technologies of the mind, in which the navigation itself would become the learning and in which, as Betty Collis and her research associates (2003) so aptly describe it, “the process constitutes the curriculum” and I would add, the “knowledge-making”.

#### **4.2. Thanyani and Tshepang: At Whose House are We Anyway?**

These two male students in the narrative sample were close friends and started the course as “brothers who do many things together since we were young kids”. They are both school principals and share a passion for teaching, because unlike many in their position, they continue to teach classes. They live in a large town, but both their schools are in villages. They speak Setswana as a first language and like Penny and Dhimpo, they encountered English in the 5th grade and mostly only in school context. These two men are also keen sportsmen and coach the schools’ football teams. Thanyani originally lived in a distant village but moved to the town when his own children had to start school. He wanted them to have access to libraries “and other things”. He therefore moved to the town, where his wife secured a position at the local government offices. Tshepang sees himself as “township man—even a city man now that I drive to Joburg so often for classes [sic!]”. They both completed their previous degrees at the “homelands university” (also known in South African educational parlance as a “Historically Disadvantaged Institution or HDI”). They are in their late thirties and wish to secure high positions in the province’s education department so that they “can have a say in how things must develop”. The drive from their hometown to Johannesburg takes three and a half hours and they usually travel together—often conversing about course topics as they commute. They jokingly refer to the “new language of curriculum reform” as a “policy patois” or a “new educational dialect”.

Thanyani did not start his journal at the outset of the course. In an interview he explained that he “was not ready yet to think and to report to himself what he was doing” because he was “too busy just trying to DO it”. He said that he could not get himself to write about his experiences and feelings when the course started because he was “too bewildered” and he wanted to feel more secure “before he bound himself to paper”. When I asked him if he could recall more of his initial experience he said, “Yah, I can—I felt I needed to press on and to click all the clicks and to learn to see where they took me—to find out in whose house I am”. Here he referred to, Scott Kerlin’s website (<http://kerlins.net/scott/edResearch.html>) which is designed like a house, and also to the work by Jim Burke, which is one of the suggested readings in the course (Burke, 2001). For him it was important to try to get an idea of the size of the network that was suggested in the course and also to get a feel of the magnitude of the internet itself (!). At one point he reflected, “You know, I was so surprised. I thought I would be able to lay my hands on it like a library,



but I just could not, because as the screen switched and I clicked the mouse I felt like I was in a catty (catapult) that shot me somewhere far away. Then I tried to find the map in my head to see the place and it would be far away from where I thought it would be. I felt it was gone". In this interview and in a subsequent interview as well as in the journal that Thanyani eventually started this theme would surface continually. He used the image of the *location of learning* consistently. He was looking for signs of the "house" that he had entered. He wanted to make a personal connection, "It seems there was nobody there in this one site—just words and pictures and in that other one there was a person—a nice person—a somebody that said to me, 'Come in, sit and talk'. And that one with the rooms—man I felt I was visiting my friend. I was in a TV movie—I was in *Generations*".<sup>2</sup> He also did not really create much in the line of interpretive or critical work and continued to gather information, which he summarized and only rarely commented on.

He emphasized that it was very difficult to start working like this without any real training in online learning. He wanted to have a trial course in which his work would not be evaluated. At the end of the course he noted in his journal:

I have learned something, but not a lot. I have to summarise everything and write it down and my class mates mostly say . . . things that I don't even want to read because they are wasting my time. I expected more of them. What I think they should do is to teach us how to behave in this sort of set-up before we do a course. I mean not just computers, but the real e-learning thing. By the time I got used to it, it was too late and I think I will fail this one. I still dream of a book and a neat study guide and I am not happy with professor . . . She thinks we are Americans who breathe through the lungs of the web.

Tshepang wrote in his journal on the first day that he accessed the course online and also often spoke about his experiences in the VLE during the workshop sessions. His third entry explains his involvement:

I phoned Thanyani, my friend and brother in oppression, when I opened the classroom door the first time. I said, "Brother, you must see this. It I like I'm going to a pub, but I don't know how to get there and I want to meet my friend. Please Man, come into the discussions, I need you there to talk to because I can't just talk to the wall, These other students will not know what I am saying. I need you there. Or come to my house so we can do it together. My wife has supplied me with the machine and the connection and the children will respect us for peace and quiet. I like this thing. I just move up and down and this way and that. I stop if I see something that I like, but I skip most of it because it looks like

a mixed up study guide and there is too much. So, now I have looked at all 14 destinations and I still don't know what to do or where to go. All the things that Prof says we must look at—I won't do it. To put your head into the discussion is far from my mind. I just listen to the others and they talk such . . . . I can't stand it. Maybe they will think that am also stupid—a *mampara*—so I am not going to. Even if we are getting a mark. But I will look at the sites and maybe if I can hook up something that is the same as the themes in the workshop I will print it out and into the file it will go. But the problem is the printer and the expensive ink. The course is now costing much more.

When Tshepang reached midway in the course and had still not submitted any of his work on the classroom board and had not posted a discussion contribution I approached him. He seemed to be well informed about the content of the course, some of which he could have accessed only via the online links. He admitted to printing articles and other texts, but being unable to become an interactive member of the VLE group. He offered the following explanation:

You see, I feel I am out of control—if I am not in my house anymore but lost on the streets. Even when Thanyani started to write in the virtual classroom I was still lost. It's not that I don't know what to say—it is just that I feel I want to first practise it—maybe I can do it in the workshop. I did not grow up like this—it is a big change and I'm stuck in my ways. My hand does the pen, not the keyboard—even if I can type a bit now. But I don't mind looking up information on the internet. Even if I don't like the links. I wish they can rather give a list of contents like a book, because it's the same in a way. So you can have an overview. Now you have to go in blind and feel around which page you want to turn to.

Towards the end of the course Tshepang communicated in the discussions and made this one pertinent contribution on the choice of data analysis methods in qualitative research—the topic of the week.

That was not right Patricia. You can't just say you are going to do content analysis like this or that because so-and-so or so-and-so said so. You must know why you want to work with the information like that. Like me—I am going to use field notes from observing a staff meeting at my school. I can't just say so-and-so suggests you must look for themes—so now I look for themes. I must first read the notes over and over and then think—h-mmm—what now? Then I can maybe see that there is a certain order to the turns people take to speak and the way they begin their speaking.

So now I may think, h-mm, this is good data for conversation analysis and I can ask myself why are people always beginning like this or why are they always looking at the principal before they speak and why does this one speak all the time and that one just shakes her head and that one frowns and smiles?

In the end he used the discussion facility very meaningfully—giving his own thoughts. He said upon being asked about his, “I was very happy at that time because I understood that she was learning like a parrot and in research if you are a parrot you are not delivering. So I could speak, but if I have to say something just to say something I can’t.”

#### **4.3. Thembi and Sipiwe: Chewing the Bones of the Mind**

This dyad was originally formed because the two students shared a first language, Zulu. The workshops invite discussion and debate in the primary languages of the students and these were the only Zulu speaking students in the group. It turned out that they had much more in common than a primary language. Thembi, a female first grade teacher, had not studied formally for more than 20 years. She had decided to register for the course because she wanted to “refresh (her) knowledge and make (her) mind alive”. She has no car and traveled to the university by public transport, often being in transit for more than 6 hours. The village school where she teaches is in a mountainous area and many of the children walk up to 10 km to school each day. She stayed with relatives in Johannesburg during the weekend workshops. Sipiwe lives about 30 km away from her and they discovered that they could travel together. He has a car and Thembi would contribute to the cost of the drive. There is no *telecentre* in the area and they would have to travel 60 km to the nearest town to make use of internet facilities. There is also no electricity in Thembi’s village. Sipiwe, who lives on a farm, has access to privately maintained electricity supply and also telephone lines. He lives on the land of his father’s employer and teaches at the local farm school, which now also boasts electricity supply.

When the course started Thembi was surprised to hear that she would use a computer and later also the internet. She had never interacted with a computer and did not really know about the existence of the internet. Sipiwe had some knowledge of the affordances of the internet, but had not worked with a computer either. He just knew “that you can connect with people all over the world”. When he found out what websites were he said, “I tell you I never thought of this. I can only think it is like a big, big *indaba* (meeting of elders), with people speaking from all over and leaving their tracks, like papers strewn all over”.

Thembi lived out her anxiety during the first part of the interactive learning. She refused to try and threatened to take the matter to the university

administration, because she had not been warned that she would have to become an e-learner. Gradually she changed her position on the matter when she started working with Sipiwe. She relied on him to mediate the process of becoming e-learning literate. Towards the end of the course she noted in her journal:

I never thought I could do this. That is why I was so angry at the beginning. Did they not know that I had no electricity? Did they not know that I had no telephone line? Did they not know that I could hardly type? Did they not know how strange this would be? But I was in luck. I met Sipiwe—he held my hand in his and he walked with me all the way—together with his daughter. First we stayed over in Joburg for an extra day when we could because that was the only way we could get to computers. We lived there in the lab for two days—with a tutor trying to help us and later his daughter came with us and just sat through it all with us. I don't know where this girl learned so much. She is only in high school. I was slow at the beginning. But every time I wanted to cry I looked at Sipiwe. He was so much younger than me and here was this man who is so intelligent and he was helping me and saying “Gogo—you can do it. Come again”. Even through my tears I could see the difference. When Prof asked me if I knew the expression of, “chewing of the bones of the mind”, I did not recognize it, but he said he knows it—it means to think about something hard. Well I have done that. I have thought hard and even though I still have no computer at home, I can say that I have learned to get information from all over. And I still don't like it, because I prefer to work from a book or from talking with people or to look at something. But at least I can do it now. And when I am in town and I have a few minutes and also some few cents I go to the post net and check my course and I also quickly post something on the discussion board. I only learned the meaning of the word virtual now. It is real, but I wish it was not.

Thembi concentrated on getting to the information that had already been listed in the course and did not venture too far away from the suggested pathway. She confirmed in the interviews that she did not want to get “confused with too many little roads to the destination”—referring her to hyperlinks. She, like so many other students, printed out as much of the material as possible and converted the electronic text to print. However, she indicated that there was still a difference—“you have to go out and get the knowledge—it does not come to you”. She also valued the learning relationship that she had developed with Sipiwe, saying “sometimes in life you just end with the right person to open the doors and even to carry you through”. Her work in the course remained at the level of information condensation, with some application and integration, but little interpretation and argumentation. She was one of the students who

used her primary language in the discussions, providing a summary in English for non-Zulu speakers. When the course ended she noted, “I am very much a stronger woman”

Sipiwe had a different experience and also demonstrated different capabilities. He commented that he learned by mediating. In his capacity as Thembi’s co-learner and mediator he explored and explained many things for himself. He also accessed the hyperlinks with courage—making notes (in a computer file) on how far “back” he should go to retrace his steps and to keep the “thread of the day”. His discussion postings were more sophisticated than the other students and he read the texts critically. He enjoyed the Burke (2001) text especially, noting that it taught him how to be an “internet student”. He also applied for private funding for two computers for his school and started literacy programs for the staff, aiming to expand this to the wider community. He is also working on a way to get more computers and to bring e-info to the classrooms. His daughter had learned to use computers in school. She was in the 11th grade at a state school that was part of an NGO computer literacy project. She assisted her father in the weekend workshops for teachers (only four). Sipiwe did not yet have sufficient funds to buy a computer, but was saving for it.

In these brief summaries of highlights in the narratives of students the events and actions are not untypical of adult students who enter the university at master’s degree level. In other classes, with many more students, the trend is the same. In the case of teachers who had to share their income with their families and extended families there is often not sufficient funds for the student to register for a degree. The students who enter the university are therefore the ones who can afford to do so.

##### 5. DISCUSSION: ECOLOGIES OF LEARNING EMERGING IN THE ONLINE ACTIVITY SYSTEM

In the summaries of students’ narratives I highlighted issues that were relevant to the unit of analysis of this inquiry, namely the adult students in their interaction and engagement with the VLE, which is identified as the *activity system* in this inquiry (Kaptelinin, 1996; Kuuti, 1996; Nardi, 1996). The descriptions were therefore by no means intended to capture full stories, although the following discussion should render them as “thick descriptions”—presenting and interpreting the data to present the *emic* as well as the *etic*<sup>3</sup> perspective of the participants’ experiences.

In order to be able to see the full picture I had to capture essential aspects of the “way of life” of this “identifiable group of people” (Wolcott, 1994; defining ethnographic research) to further my understanding through the ethnographic lens as well—thus foregrounding *the activity*—which is also *the* highest level in the hierarchy of processes in activity theory. “Activities

are oriented to motives, that is, the objects (the environment with which the human mind interacts) that are impelling by themselves” (Kaptelinin, 1996: 108). I needed to find out what happened at the interface of students and the VLE that would demonstrate the “compelling” force that drives rural teachers to become engaged and to appropriate the VLE—beyond short term goals (of *actions* in the activity theory hierarchy of processes) and immediate skills (described as *operations* in the processes described in activity theory). In other words—towards the notion of *activity*, where mind and environment (object) meet in mediated action. Kuuti (1996: 30) explains:

Activities are longer-term formations; their objects are transformed into outcomes not at once but through a process that typically consists of several steps or phases. There is also a need for shorter-term processes: activities consist of actions or chains of actions, which in turn consist of operations.

In Figure 2 examples from this case study data are presented in the activity theory hierarchy of processes.

According to Luria (Kuuti, 1996: 30) “cognitive processes occur in practical activity”, and the type of practical, observable activity indicate some of the cognitive activity. “Activity theory does not accept a dualistic conception of

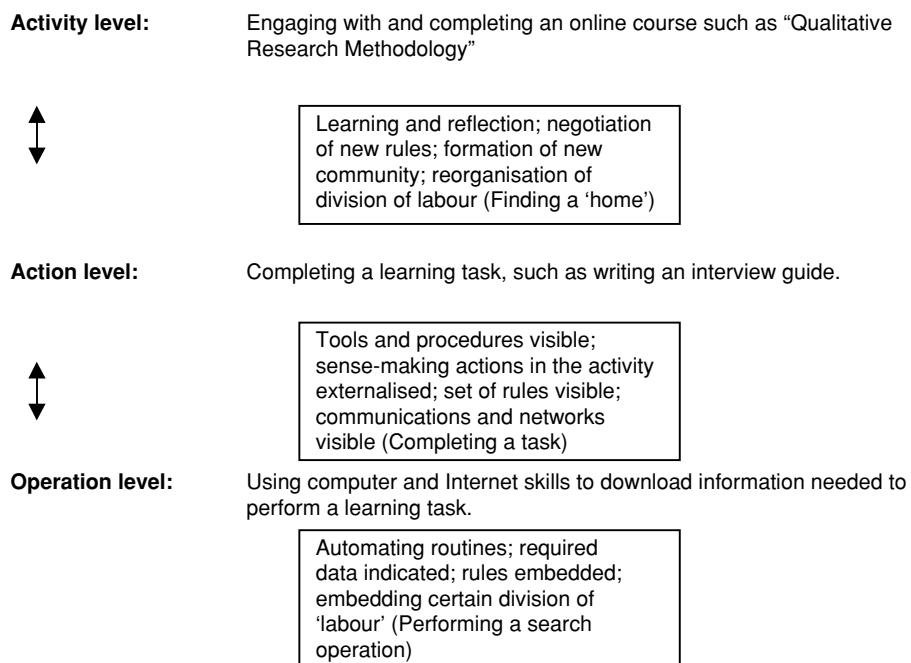

Figure 2. Activity, action, and operation in the online course. Source: (Kuuti, 1996: 33, 36).

an isolated, independent ‘mind’. It means that a person’s mental processes acquire a structure necessarily linked to sociohistorically formed means and modes, which are transmitted to him by other people through teamwork and through social intercourse”.

I thus realized that as an educational anthropologist I would have to search for understanding of the small community, where the meeting of mind and object could be witnessed and harnessed in *primary* encounters, more than of the larger system (Nardi, 1996), where evidence would be secondary and also more general.

I also sought my own space as higher education teacher in this landscape where I was trying to capture the activity; therefore elements of autoethnographic (Coffey, 1999; Reed-Danahay, 1997) writing would be evident. As designer and teacher I continually think of the design of future courses and how I will need to take cognisance of the “human and computer” *in* the world—the world of rural and semi-rural South Africa—more than of the “human” *and* the “computer in the world” (Kaptelenin, 1996).

My point is that the need for contextual research in online learning has not been addressed in such a way that design could benefit the marginalized learners of the developing world sufficiently. I reasoned that the varied data sources would give a glimpse of some of what has been missing in design by giving a picture of what happens to newcomers to the internet in their first encounter and how this happens in an everyday context.

In this regard Kuutti (1996: 37) argues that conventional Human-Computer Interaction (HCI) research, especially up to the mid-1990s, has been narrow, covering most adequately “the area of error-free execution of pre-determined sequences of actions”. She then says that humans are adaptable and learned these procedures quickly and that more research is needed in “supporting work and sense-making in work”. I would like to emphasize the notion of “sense-making”—not just in terms of the content of a course, but in the whole *activity*, as theorized in activity theory. One suggestion forwarded by Kuuti with regard to research to find the way sense is constructed is that HCI in social (everyday) context should be a focus. Kaptelinin (1996: 45–68) also takes this approach, pointing out that it is becoming a preferred view instead of the purely “cognitive” approach. I agree that the space where meaning is generated and where communities/ecologies of learning can be established is not at the interface of the face and the screen, but in the interaction of this interface with a broader system on the one hand, but also, on the other hand, with a more contained ecology. I argue that in the case of first time e-learners this is vital as it may form a bridge to a discourse community of learning in a virtual environment, which in turn could change their lives (Henning et al., 2000). If the social self, in addition to the psychological self, can be invoked in learning programs in VLEs, the distribution of cognition will go both ways—through the electronic network and through the

“landlines” where faces meet (Henning & Brown, 2002; Henning & Van Rensburg, 2002).

I decided to use Bonnie Nardi and Vicky O’Day’s (1999) metaphor of “information ecologies” as heuristic frame through which to explore the data, because in working with the data initially I realized that what I was encountering could not be placed in the broad category of HCI theory only, but had to be seen in a more specific theoretical perspective, and along with activity theory as theoretical position, the metaphor of ecologies would assist me in understanding the teachers’ engagement with the course. I was looking for a contextual explanation and position from which to work with the data and also for one that would foreground the landscape where the apprenticeship (or other form of learning) was being fostered. The sociocultural context, ultimately, would offer more “affordances” than the technical opportunities of the electronic system, I argued. I could not see how most of the students could continue without some mediation, because the concept of virtuality, more than the skills for the keyboard and the screen, was the most troubling to students that I had introduced to the VLEs previously. Creating ways to learn and using the social structures and the “way of life” of a social group affords learners the opportunity to explore and to learn because they have a sense of continuous and close support. I reasoned that without social affordances the affordances offered by the machine would be less “affording”.

Nardi,<sup>4</sup> an anthropologist who focuses on sociocultural and activity theory as theories that capture context as roleplayer in learning constructed a theory that captures activity in small learning communities. It is from this theoretical foundation that she extracts the metaphor of “ecologies”, relating it to original sociocultural theory and cultural psychology (Kozulin, 1990; Vygotsky, 1978, 1992). Later like-minded scholars (Bruner, 1990, 1996; Engeström, 1991; Rogoff, 1990; Wertsch, 1991) expanded it, always emphasising mediated action, tool utilization, culture, and language and mediation for learning in a “zone of proximal development”. An offspring of these theories has been activity theory, with Leont’ev (1976) as the scholar who gave format to this theory. Activity theory posits more than the hierarchical levels of processes that I have already referred to (operations, actions, and activity); it also holds that the mind will interact with the environment and its tools and create will new mindtools to do this. The premise of this study is that this epistemological shift (inherent in the creation of new mindtools) is not recognized in online courses for adult first time users whose mindtools originated through printed text and oral literacy. Different theories, related to the corpus of knowledge known as sociocultural and activity theory, will give different interpretations of this epistemological non-readiness, invoking related theories to explicate the integration of tool and cognition.

The difference between these related theories, such as situated cognition/action (Brown et al., 1989; Lave, 1988; Lave & Wenger, 1991), distributed



cognition (Brown, 2000; Salomon, 1993) and also activity theory itself is explored by Nardi (1996: 78–88). She comes to the conclusion that:

All three approaches to the study of context have merit. The situated action perspective has provided a much-needed corrective to the rationalistic accounts of human behavior from traditional cognitive science. It exhorts us not to depend on rigidly conceived notions of inflexible plans and goals and invites us to take careful notice of what people are actually doing in the flux of real activity. Distributed cognition has shown how detailed analyses that combine the formal and cognitive properties of artefacts with observations on how artefacts are used to understanding useful for design.

Activity theory and distributed cognition are very close in spirit, as we have seen. And it is my belief that the two approaches will mutually inform and even merge over time.

Nardi critiques *situated action* as theoretical perspective, as it purports to be goalless, but, according to her, cannot really be a view that sees action as objectified only in retrospect. I do not agree with her entirely, because I think that situated action, with its understanding of a sense of immediacy and improvisation can be used to understand what people do when they are challenged with a sudden “unknown” or a breakdown, when the broader goal or objective recedes to the background and the immediacy of the moment requires a “practical intelligence” in the situation. Situated action is, for me, the action of contingency and immediacy and only someone who is well aligned with the way the context works will be fruitful in a situation of immediately needed action. My own view is thus that these three approaches together can be used to frame learning for novice e-learners. And having said that, I see Nardi’s metaphor of “information (learning) ecologies” as a blending of the three traditions, with activity theory perhaps as the more dominant one.

From this view the context of a learning event is seen as steeped in a sociocultural context (Chaiklin & Lave, 1993; Wertsch, 1991) and also in an activity system (Engestöm, 1991). The computer as medium, mediation and as thinking tool, digital information, and the *hyperworld* in the broadest sense are part of a cultural environment created by humans as both mental and material tools to use—to be prostheses of both the hand and the mind (Bruner, 1990). But that is not the only world; in order to explore the very concept of VLE the “real” environment, including the historical context of this space, needs to be explored as well. Adult South African students, who mostly have a history of educational deprivation and segregation, and who have studied at institutions where they could get by on rote learned information, will approach a VLE in the context of their experience and their sociocultural “situatedness”, Yet they will also have to learn how to enter the e-world of distributed cognition by

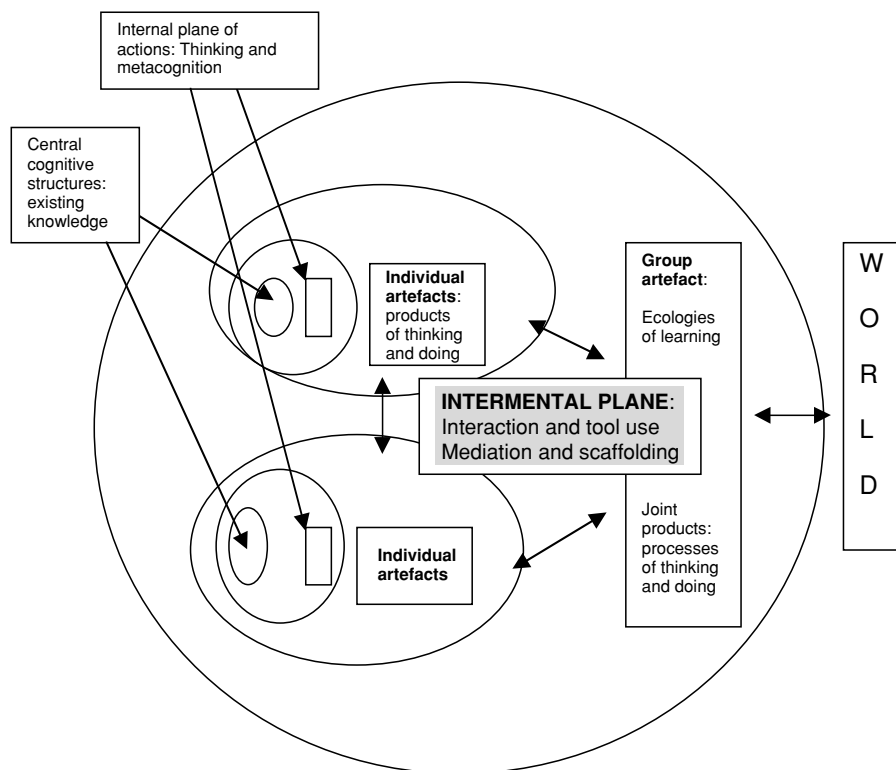

Figure 3. Computer-mediated group activity (after Kaptelinin, 1996:59).

learning to “work” at various levels in the activity theory typology of action, working both as teams and as individuals.

Kaptelinin (1996: 59) presents a visual representation of “computer mediated group activity”, or this “working” in a distributed space in “the world” (plus the *hyperworld*). In his rendering of a group activity he captures the three approaches to understanding learning (as analyzed by Nardi) in a VLE succinctly. For me the diagram that I adapted from Kaptelinin (1996: 59), and which is presented as Figure 3, shows how a learning ecology “works”: The “group artifact” is the ecology itself and not a separate “project” and “the world” interfaces with the “individual artifact and cognitive processes” on the “intermental plane”. The metaphor of the ecology is thus simultaneously, in my rendering, also a symbol for intermental processes.

The individuals in the ecology interact with each other and with the environment (but via the keyboard and the spoken and other face-to-face contact and representations of contact, such as the written word and the semiotic systems in which actions are embedded). The “intermental plane”, a Vygotskyan term that refers to the mediation from mind to mind, or from the environment to the individual is multidirectional and reciprocal. This means that individuals

change the environment as the environment changes them. In this regard Kaptelinin (1996) talks about “the world” (also “the group”) as a complex system that can contain, in Nardi’s (1999) words, “keystone species”—those that exert a strong force on the environment and who can play a key role in changing it. In this study the keystone species have set actions in motion that have compelled me, the course designer, to reconsider the introduction to the course.

The counter argument can be that this species may advance to the learners’ mental lane directly “via the screen”, and by being invited through the keyboard and the mouse—in other words, the computer as tool can be both mediated and mediation. However, where novices that I have studied are concerned, the existing familiar “species”/faces have shown to be the main proponent of mediated action—and these are facilitating and mediating *people* who act at the interface and who co-create the ecology.

Nardi & O’Day describe an “information (learning) ecology”, as “a system of people, practices, technologies and values in a local environment” and “(l)ike their biological counterparts . . . are diverse, continually evolving and complex” (1999: 49). Like these authors I have found that it is vital not only to describe *how* and *what* people encounter (in) technologies, but *why* they do so in specific contexts and learn new literacies within the social context (DiSessa, 2000; Warschauer, 1999) thereby expanding their tool use and concomitant mindtools. Because ecology is a system of balance and of change to ensure an “equilibrative” survival, one needs to find the meaning of actions—the reasons for the way people engage with an object (in activity theory parlance) in different situations and what the implications of this engagement are. In this system students need to seek the a balance between so-called “course content” and ways of doing—thus of learning to e-learn. That is also the reason why I use the concept “learning” ecology instead of “information” ecology. I thus expand on the Nardi & O’Day metaphor and explore how the teachers became apprentices and how they started to develop a way of living with e-learning in their daily lives.

In contemporary views on learning, from a constructivist perspective (Bransford & Brown, 1999; Phillips, 2000) it could easily be said that the process of a first engagement with a VLE is a matter of prior learning and exposure and that novice e-learners need an induction program and so forth. However, the complexity of the context, the “why” questions will not have been answered and future planning will therefore be based on the description of the “how/what” question only. I argue that it is not reasonable to expect novice e-learners to encounter a new course and a new medium, in effect thus a totally new way of “doing” learning, without a truly inviting and context-rich design. This inquiry and, I hope many others like it, aims to search for these “extras” that are needed in design in order to harness the resources of the new learners and not to only recognize their deficits in terms of technological literacy.

At present we use a tool for e-learning that was designed with the technologically advanced communities of the world in mind. *WebCT* is Amero-centric. Its language and its icons address the worlds of the middleclass American student and all who have been “Americanized” in this way. Unless we explore HCI at grassroots level in a different context, we may lose the learners who need the system most. That is why both observations and interviewing, as well as document analysis, at grassroots level need to be conducted and comparative data need to be assembled across nations and borders to find out how different Indigenous Knowledge Systems (IKSs) can be blended with the Western discourse and way of doing of the electronic world. My point is not that a completely “different” discourse should arise, but that there should be more of the local in the global.

To this end the ethnographic component of this inquiry aims to capture the type of information needed to explain what the local reasoning is and what local tool utilization and ecological adaptations look like. The assumption that “one glove fits all” has been dangerously erroneous in my experience of lives of e-learners (Fortuin, 2002; Henning & Van Rensburg, 2002). “Borderless courses”, I argue, are for those learners who have been initiated and inducted into the “ways of the web” over time. In the instance of the students in this inquiry, who I describe as “bordered”, they need to make the border-crossings from their side of the digital divide—also for pedagogical and empowerment reasons.

The VLE as a space for this type of inquiry is abundant in its ability to yield data of various types and sources. It is free giving, because the ecology is forever changing and this dynamics, coupled with the social change that accompanies it, can be captured optimally in some form of ethnographic research.

### **5.1. Making a Home and Greeting Each Other “Across the Valley”**

In the discussion I will now firstly indicate what the significances of the study were and then reason how the “learning ecology” metaphor could be used to argue that a specific type of apprenticeship learning and entry into the VLE is needed for specific contexts where there has been little if any initiation before. I also show how the data reflected the main finding, namely, how the notion of *making a home in a VLE* was the dominant theme that explained some of the problems the students encountered, while also mirroring *activity* more than *action* or *operations*.

The six teachers accentuated in interviews and in the journals, as well as in the discussion postings, that the implications of effective e-learning in this part of the world are far reaching. They say that no one needs to be convinced of the urgency of the need for viable information networks and virtual learning opportunities anywhere in Southern Africa. If this were to be a successful

intervention on a large scale, if the internet can truly come to villages and huts in distant areas, the sub-continent may be afforded a better chance to develop its human resources.

Thus I focus on the stories as illustrations of how the notion of information ecologies, or “learning ecologies” for the purposes of this inquiry, can become a powerful heuristic in thinking about sustainable VLEs, not only in the higher education landscape, but also at community level. What I learned from these stories is not how to teach and to set up an environment, but how to listen to the voices (and the tone of the voices) on the ground as guidelines for development. In one of the interviews a teacher said that learning to work in online format reminds her of a television advertisement of a telephone company in South Africa.

In the advertisement an old man shouts a greeting from the doorway of his hut on a hilltop to his friend across the valley, who then returns the greeting, “Hello, one of my own!” This is a daily ritual. Then telephone landlines are installed and both the old friends are equipped with a telephone. They learn to dial and to use the receiver for the first time. At last the first real phone call is made. The old man lifts the receiver and dials. He listens to the ringing and hears someone pick up on the other side. He then goes to his doorway, points to his receiver and shouts the greeting in his customary way, with echoes over the valley: “Hello, one of my own!”

This was his first effort at telephone communication. He used the information technology, but also wished to make sure that the sound traveled in the way that was customary to them. With the necessary technical support and sufficient funds, this little communication ecology will be able to sustain itself and the teacher expressed the opinion that very soon the valley will be “chatting away”.

In the same way I believe that the VLEs that we have initiated have the potential to be sustainable—not because of the technology itself, but because the people who have engaged with it found ways to get support and to reciprocate in supportive ways. The main characteristic of this developing ecosystem is that it has a good chance of sustaining itself and my argument is that a VLE intervention should have at least the potential of *sustainability*. In the three stories there is evidence of potential for sustainable development. The adult learners had all found ways to acquire knowledge and skills (and ultimately also a disposition) to learn and to get access to computers first and then also to the internet. The stories are perhaps no more than research vignettes at this stage, but they also have the potential to become powerful narratives of how, given the opportunity to bring together a societal, educational trend and a number of people, (a “fortuitous coupling” event) change can come to people

and to their social environment. However, the sustainability will be threatened if the ecology does not evolve, and with some skills and knowledge alone, I argue, the chances are that it will not prosper. It needs what Bonnie Nardi (1999) has termed, a “heart”—it needs people who can use it with discretion, but also with some intuition.

In addition to intuition the nurturing of a critical capacity is also essential, because for an ecology to develop without a critical capacity, I would argue, is to render it vulnerable to power and control (Warschauer, 1991: 74–175) and to new technological hegemonies—the fear expressed by Postman (1993) and Ellul (1964).

#### 5.1.1. *The Internet in Huts and Villages—Where are the Keystones in the Ecology?*

The first component of a learning ecology that I noticed in the data is the role of keystone *species*. According to Nardi & O’Day (1999: 53) “keystone species, whose presence is crucial to the survival of the ecology itself” is a main characteristic of ecology and “(o)ften such species are skilled people whose presence is necessary to support the effective use of technology”. These people can be facilitators, translators or teachers. I particularly like the reference to these species also being *mediators*. Nardi and O’Day (1999: 54) relate an anecdote about the unusual hiring practices of a big corporation that shows who these species could be. This corporation looked for people with a caring disposition for certain positions, despite their possible lack of background and experience in the areas of the job description. As mediators they needed certain personal qualities and interpersonal skills. As I understand the notion of keystone species, they need not be the experts, but they just need to be the “right” people for the “job”.

The keystone species in this inquiry made their presence known by acting according to the need of the situation, without having had a prior goal. Therefore the emergence of the species is typical of learning in *situated action* mode. In all of the cases the major “teacher, mediator, facilitator or translator” was a person who came to the fore organically and provided the support and the scaffolding that was needed. In each of the narrative portraits of the dyads the partner is a keystone. In the practical and epistemological struggle to get their knowledge built the presence of the reliable other learner was the ecological component that kept the system together. The learning ecology itself comprised more than the two persons, because their virtual and workshop communication webbed into the rest of the group, but the dyadic partnership was crucial. The students in these narratives may not have appropriated the course optimally as some other students with more experience and skill did in this course, but they stood out as examples of strength in unity. I also found it significant that they hardly addressed the rest of the group of 33 students in

their discussions, but spoke to each other, with only a number of references to the other students. They preferred to engage in the smaller ecology where they clearly felt more secure. They addressed the course presenter quite often, though mostly in plaintive tone. In the instance of Thembi and Sipiwe it is significant that his daughter became a keystone as well and that she remained with her father when he extended the *emergent distributed cognition* system to other teachers in his school.

My argument is that the teachers all found extra support in a keystone species and thus created the genesis for an apprenticeship in learning, VLE style. The members of the dyad found what they regarded as a “more experienced craftsperson”, who, in some way, mediated the process. The *cognitive apprenticeship* was both situated and slowly evolved and will probably become, ultimately, an example of learning in distributive mode, with a strong social component. The teachers cannot be expected to study online in global “borderless” courses as yet, before they had not completed the cultural ritual of learning in apprenticeship mode (from each other and with a body of people) how to enter this discourse community and to become empowered. For the moment they are not “borderless” in their thinking or their skills. As “bordered” learners they first had to engage in the immediate struggle together to form a viable learning ecology. At one stage the words “I click, therefore I am (not)”, and the problems involved in finding an epistemological identity and a space came to mind when I observed teachers working away. The expressions of fear and loss, the “hopelessness and the homelessness” that Dimpho referred to were often observed in workshops. The sense of being lost and not knowing how to get to a safe destination became a dominant theme in the data and I also reflected on this in my own journal:

This loss of identity was buffered by the folk that made the experience more “human”. I feel lost myself when I think of the clumsiness of this course. How did I manage to design a learning environment that has no identity—no character, no safe space? I did not see the students’ lives and how these should feature in the hyperlinks (I could have made these myself if I had given it any thought). Now I have thrown them to the global wolves and they feel strange and unsure. Maybe I should have asked colleagues at other institutions if we could perhaps share courses, so that we can be each others’ hyperworld to start with—just at the beginning. But then—our students read international textbooks and they cope. So why is this so extra hard? Why does Thanyani talk about me wanting them to “breathe like Americans through the lungs of the web”? This is painful. But how can I not introduce online learning? How can I be happy and deprive people of the opportunity to help build access routes to knowledge and to knowledge-making and, ultimately also to really valuable information ecologies? What is it really that makes them so insecure. I am not sure that it is simple fear of the unknown.

Despite these misgivings and that it took the six students nearly the whole semester to enter the environment, the fact remains that they did so successfully, even if not entirely at the process level of *activity* in the activity theory hierarchy. It does show, however, how important it is to introduce students to the environment in induction mode and to keep the pace slow at the beginning. Therefore, the fact that most of them did not advance to higher levels of engagement does not trouble me too much at this stage—the first in a longer journey. What excites me is that the role of the keystones became evident and that they would probably become a keystone in their own teaching of computers and helping more people to become active members of VLE's.

#### 5.1.2. Diversity: Each to Their own Niche

The six e-learners in the research sample have all begun to find a place in the virtual learning environment where they are comfortable and where they have started to function as e-learners. In these cases the functioning can be seen as a blending of learning from the view of *situated action*, *distributed learning*, and learning within an *activity system*. The most prevalent learning has, however, been in the category of *situatedness*.

And this makes sense, because in the close containment of the individual situations learners sculpted a niche in which they can operate “in” the moment. Dimpho and Penny, like the others, saw the dyad itself as a niche. Working together was essential for them. They also complemented each other. Dimpho found her way of doing by writing extensively in her journal and Penny was asked to share this and to comment as well. So, together these two women reflected and strategized. It is significant that it did not take them long to acquire their own computers and internet connection—bringing the technology “home” in more than one way. My sense of their experience is that they wanted to make the learning more personal and in this way they found an operating niche. At the outset, therefore, their *activity* was to not only to “meet with the computer”, but to do so on their own home turf. The course itself became secondary.

Nardi & O'Day (1999) say,

(i)n a biological ecology, different species take advantage of different ecological niches, which provide natural opportunities to grow and succeed. The complexities of biological ecologies ensure that there are niches for many different kinds of roles and functions. In an information ecology there are different kinds of people and different kinds of tools.

They continue to say that the tools and the people are complementary in a healthy system and that a monocultural system is brittle and therefore vulnerable. The members of the learning ecologies in this inquiry present



a landscape that is, indeed, as these authors argue, “teeming with different kinds of people and ideas”, with the potential of cognitive fertilization and hybridization.

In both the other dyads it did not take the students very long to establish their niche and their path where they could optimize their growth. Sipiwe’s daughter joined her father and became the third member of a learning triad; they both found fulfilment in teaching as they were learning—a specific niche for accelerated growth.

The differences in niche areas are not just at the cognitive/psychological level, but also at the level of sociocultural action. It is noteworthy that the University campus with its sophisticated computer laboratories and much faster internet connection did not become a place where people “found” their niche. The niche was found in the immediate social environment, where they felt comfortable and where there was personal support. What was more important was the linking of their everyday life and their process of entering into the VLE.

### *5.1.3. System: the Course, its Students and “Others”*

The most cogent comment on the notion of the system in the authors’ metaphor of ecology is, to my mind, that “(w)hen one element is changed, effects can be felt throughout the system” (Nardi & O’Day, 1999: 51). Whether one views the dyads and their immediate surroundings as “the system” or whether one takes a broader view and includes all the students in the course, the program and the designers and teachers, does not really matter. Small changes, if they are sustainable, change the broader phenomenon. And in this system many people have changed their way of doing. The way they appropriated the VLE as individuals has significance for how the course will grow.

Tshepang and Thanyani worked at a faster pace from the outset. They also started working beyond skills learning (at the operational process level) very soon after they had made their first posting in the discussion forum. Tshepang was one of the first students in the larger group to critique a fellow student’s discussion posting. After this, more students followed this example. Also, some of the more privileged students in the larger group, who were continuously complaining about the lack of access to computers, the expense and the need to be constantly engaged, slowly stopped their complaints when they started realising that the students in this inquiry, their peers with few of their communication and access privileges, had actually put them to shame.

Tshepang also delivered a good research design, with an outstanding design logic and with references to eight hyperlinks that he had made to set up his research proposal with its innovative design (a hybrid of ethnomethodological and ethnographic research in a school). At the process level of action he had delivered an admirable piece of work and is probably the only student in the

research sample of whom it can be said that he engaged with the *activity* system (along with six in the larger group) of the course.

The system's most significant impact has been, however, on the design. Having encountered so much data about the students' first encounter showed me how weak the design logic of the course is and how it negated the students' sociocultural context. The change in the system will impact the design of many courses at the institution.

Also, their own immediate environment has changed irrevocably. Once electronic learning happens it will not stop—if technological support is sustained. The “apprentices” have all said that they will never *disconnect* and forego the networked world. In the ecology, which gives signs of its sustainability already—the chances are that much will change in perhaps a shorter time period than is usually anticipated when forecasts about the *African network* are made.

#### 5.1.4. *Coevolution: The Electronic Village in the Global Community*

Every household or other entity that appropriates electronic communication and sustains access will be in change format as the innovations are introduced. Already the participants in this inquiry have commented on new mental tools/mindtools accompanying the use of new material tools. Though this is coupled with perturbation and often also with epistemological angst (Henning & Van Rensburg, 2002), the equilibrium that comes with the competent use of both types of tools sets a *renewed zone of proximal development* in motion. This predisposes the learners to continual evolution in learning. Even in the space of a few months there is evidence of evolution, and more specifically co-evolution. All six members of this inquiry group developed with and according to the eco-existence of at least one member of the ecology, but also because of the sociocultural context. There were not only people who influenced each other, but a telecentre, an internet café, a postal centre with internet, and a wife who bought her husband a computer. Thembi wrote in her journal towards the end of the course, “I was slow at the beginning. But every time I wanted to cry I looked at Sipiwe. He was so much younger than me and here was this man who was so intelligent and he was helping me and he was saying, ‘Gogo you can do it. Come again’. Even through my tears I could see the difference”. And in his capacity as mediator and teacher Sipiwe thrived on assisting Thembi. In their various niches they were coevolving in the learning ecology.

#### 5.1.5. *Locality: Are the Computers in our Heads?*

In this inquiry two notions of locality became evident. Firstly the *mental locality* of the newly developed learning skills, and secondly, the place of

*habitat of the computers*. The most important finding from the inquiry has, in fact, been the notion of habitat or location. In the data examples that have been included in the narrative portraits it is evident that the notion of “home” or a place to be is very strong. Dhimpho starts her journal with the words, “Are we in this machine or is it in our heads?” Penny said in one of her entries, “I felt like I had moved house” and that she felt “homeless”. Thanyani said that he felt “catapulted” and that he wished he could “lay my hands on it like a library” and that he tried to “find a map in (his) head”. He expressed the wish to enter a house and to find someone he knew there. Tshepang goes further and invites Thanyani to his physical house, because he “can’t just talk to the wall”. Later on he says that he feels lost, as if he is “not in my house anymore but lost in the streets”.

In the citation from Shakespeare’s *A Midsummer Night’s Dream*, Nardi & O’Day (1999: 54) highlight the notion of location or habitat in ecology and the role of imagination to create the location. They say,

We believe that a key to becoming an active participant in technological change lies in joining ranks with the poets, whose creativity is grounded in local settings. The notion of “local habitation and a name” captures for us the essence of information ecology. The *name* of ecology identifies what it means to the people who use it. In a sense it positions the technology more under the control of its users. We do not just refer to what the technology is called, but to how people understand the place it fills.

## 5.2. What the Portraits have to Say for Course Design and Implementation

In these narrative portraits there is sufficient evidence that the present format and content of the course do not invite the students to engage with the object—the whole envisaged learning experience. It is significant that before the teachers started to locate the VLE *in their lives* they had to locate *themselves in the VLE*. They were finding ways to name, at a personal and almost metaphysical level, the new epistemological home they were entering. So, before they even thought of locating the technology, they had to redefine their own mental habitat with regard to the technology. And why this is significant is because it indicates that the appropriation of the technology happens first at a highly personal level—much like things happen in one’s home.

It is this theme that has led me to argue that the new epistemological tools that adult learners in this type of context need can only be made if there is a sufficiently accepting and supporting ecology. That is also why I argue for a gradual process of initiation into the ways of “doing VLE” for such learners. They cannot “breathe through American lungs” as Thanyani said. They need the opportunity to appropriate the discourse, its genres and all its tools and

symbols in apprenticeship format, in which the *activity* (in the language of activity theory) is “*getting to know you*” and also “*getting to myself in this new landscape*”—finding their homes in a new “living area”.

And to this end I forward a number of suggestions for the design of first time e-learning courses for adult learners in this type of context. They are very simple and they are geared for the cultivation of learning ecologies in which the culture of learning involves a stronger blend of the familiar social environment and the virtual environment. In future, when I hope open source learning will be the way forward and will replace learning and content management systems, the students can co-design curricula and make the product the process, as Collis (Collis et al., 2003) so often argues.

*Firstly*, the life world of the students needs to be linked to the tools, signs and symbols of the e-world. For example, the discourse of the hyperworld can be linked to a local, social, or even educational discourse that can cross-articulate. Instead of having “discussion postings” (one of the least successful components of online courses I have introduced) these communications can be named in a local language. The format can be adapted as well. Visual material, icons, sounds, even a simple term like “click” could, to start with, be replaced by a local word too. The interface can be so much more “environmentally friendly”.

*Secondly*, initial tutoring, when the ecology is still in its genesis phase, needs to be focused on the students’ lives, rather than course content. In other words, the initial “course content” needs to also be a “getting to know you” and “getting to know myself in this space” (the new “home”), before the links to the *Infobahn* are introduced. I suggest that much more is made of the opportunity to hyperlink to each other and to establish *emergent personal Webpages* instead of using class email facilities and discussions. A personal webpage has an “address” and this signifies that the learner has indeed “moved house”—has relocated to a place on the internet, where millions of other people also “live”—but where the individual has a personal space.

After having learned the basic skills of working the hyperworld, and after having acquired a personal “page” (home), or *homepage*, design logic for the rest of the course can be established. My fear has always been, and has been substantiated in the courses that I have started and witnessed on the web, that the secure designer-teacher prefers to have a complete course—and that most students believe they want it too, packaged neatly with envisaged outcomes and clear standards of (so-called?) performance. At this stage I would rather see students establishing the “move” first—settling in at the new address—and then exploring the neighborhood, which does not yet include major hyperlinking. I propose a first “less is more” learning unit with secure pathways and specific signs and criteria for achievement and for self-assessment. The new learners first have to make sure that they are comfortable in their “new home”, and this is something, which only they will know. They will communicate about themselves and their “move” experience and will set

up their house/homepage with the help of instructors/tutors and visit each other before they explore. This means that the ubiquitous (and in my experience mostly unsuccessful) discussion postings become less important. I have found that organic networking and the development of a more “e-natural” ecology suits the learners in this context far better. They will communicate and share their ideas and their struggles in learning spontaneously. The formal area of threaded discussions is, for many, a daunting forum. I would argue that students who are engaged and motivated will come to share their learning when they are ready. Forcing learners to “thread” a discussion is only one way of facilitating shared processes and may, for some, exclude them in what is intended to be an inclusive project of distribution.

Does this mean that very little “course content” is introduced and that the focus is initially on getting the process going as organically as possible? My answer would be a tentative “yes”. After the first learning unit progress can be made according to the learners’ growing awareness and competence. The curriculum design would therefore never be more than “emergent” and the “packaged course” would not be made available at the outset, because it is bound to change. The design logic would be evident, however. The indicator of success of implementation would be the type of ecology that is cultivated, the way the distributed cognition system/network evolves and how learners act contingently in situated cognition mode. More than anything, the logic would display a design awareness that invites a sense of the *activity* more than a collection of disparate *actions* and *operations* in isolation. And in the case of this type of group, the activity would be to “move to the hyperworld”, with some of the belongings needed to traverse its spaces.

#### CONCLUSION: TOWARDS A SUSTAINABLE ECOLOGY OF ONLINE LEARNING

The first conclusion that can be drawn from the discussion is that ecology has been a viable metaphor for exploring online learning in its *real* context and that the understanding that has arisen from this has contextual validity. In this inquiry I was led to the notion of “moving house” because my focus was on the interaction between the mind (“consciousness” in activity theory terminology) and how it interacted with the environment. The mental tools that I was applying in looking for meaning in the data were themselves mediating and my own mind, my own thinking, was framed and mediated by the notion of *ecology* and of *activity*, and to a lesser degree by *apprenticeship*. In thinking about “activity”, I inadvertently was drawn to the realization that the teachers were at first frustrated at the operational level of processes in the *activity* of “moving house” and of finding an identity in “clicking” (I click therefore I am?). In this process the motivation, or compelling force, for becoming an e-learner was dominant—and it was also the biggest stumbling block. At other levels of processes they could learn at their own pace and would have,

eventually (and some did) become adept in the activity, some actions, and many operations. Moving house was, however, not possible because in the constraints of the course and its facilitation via WebCT the students could not “move”. They performed actions and operations that were related to the activity of moving to the online space, but they did so, except maybe for one of them, as transients who had not established an identity and a location for themselves.

Kaptelinin (1996: 108) says actions are, “the processes functionally subordinated to activities (and) they are directed at specific conscious goals”. He furthermore argues that the “objects” of the activity (moving house and feeling secure and localized on the internet in the case in this chapter) may be dissociated with the “lower” level of processes in actions, with goals (teachers writing a discussion posting to participate for grading and thus assessment, or delivering other artifacts of learning) and that such dissociation is significant. The teachers in the inquiry did not really engage with the course, because their basic motive (towards processes at the *activity* level) was not recognized by the design, which expected full course engagement. Although designed from a constructivist epistemological approach, the curriculum invited little thinking and inquiry and perpetuated rote learning and copying. Without being “at home” and appropriating the VLE, the students mostly could not identify the latent opportunities for inquiry and also did not have the courage to venture into more than default learning mode, and thus reverted to rote learning.

They did not find it difficult to perform processes at the operational level. Kaptelinin (113) says, “(w)hen *operations* are frustrated . . . people often do not even notice and automatically *adapt* themselves to a new situation”. He continues to say that at the level of *actions*, when goals are frustrated, actors have to *set new goals* and start again. The point I am trying to make is that a basic and overarching frustration was dominant in the teachers’ engagement with the online course—they had not really *engaged in the activity, because the activity was not identified as object for their learning*. The course designers did not address the *motive*, the compelling force, that the teachers spoke and wrote about in detail in the journals and the interviews—namely that they “felt homeless”. Thus the other processes were less significant than they would have been if their need at *activity* level had been addressed.

Finally, I would argue that all the best intentions might yield less fruitful outcomes if the identity of the learners who are not comfortable with the virtual world is not considered. In the very first extract from a journal entry reported in this chapter, Dimpho had said that she was not sure whether the computer had come “into their heads” or whether they had moved “to the computer”. At an ontological level she was essentially saying that she was not sure of what the *activity* was, but she was left struggling at the level of operations to find an answer to such a fundamental (activity) question. The tool can never become the mind, but the mind *and* the tool (the environment,

the object that motivates and energizes processes) are the activity. So, indeed, she had “lost some of her mind”, but not, as Postman (1993) and Ellul (1964) and others (Nardi & O’Day, 1999) argue, “to the technology”. She has engaged in meaningful, conscious tool use and in the process she has developed new mindtools—expanding her mind through tool-mediated action. Thus, she is “stretching her consciousness” as she would if she were to study, for example, Mozart music. Here too, she would enter another world where she would also have to find a home, and then an ecology, and then a niche for herself, before she would become meaningfully operational and active.

The overall conclusion of this inquiry is thus that, viewed from the perspective of an ecology of learning and using activity theory as analytical tool, adult learners such as the teachers in this context need a home and an identity as e-learners before they can engage in a course. They need to be ontologically and epistemologically secure. Additionally, they need to be introduced to online learning in a gradual apprenticeship mode that will afford them the opportunity to establish their own *location* and to *name* their experiences and their position in the ecology of learning. They need to have the opportunity to enter this discourse community from a position of strength and not of deficiency. One way of securing this position is to design courses for novice adult e-learners that invite them to establish a home, and with it an identity, on the web. In this home they can then learn many of the operations and actions needed to learn online, but, more importantly, they will have the opportunity to perform the activity—to engage with and to appropriate the environment, and not just to learn some skills and acquire some knowledge via the web. They said that they were lost and “homeless”. A personalized homepage may be the answer as foundation for further interaction with the VLE.

#### ENDNOTES

1. Racially segregated urban living areas in South Africa, designated for black people in the apartheid era.
2. This is a very popular, primetime television series drama.
3. See the edited work by Headland, Pike, and Harris (1990) for analyzes and discussions on these terms of the “insider’s view” (the emic view) as opposed to the view from social science categories (the etic view).
4. I will not include O’Day every time I refer to the authors’ metaphor.
5. In a recent paper I propose (Henning, 2003) that the borderless courses aimed at a global learning community need to take account of the “bordered” people of the world who have to follow different learning paths before their learning and the e-programs they engage with can be termed “borderless”.

## REFERENCES

- Bell, J. S. (2002). Narrative inquiry. More than just telling stories. *TESOL Quarterly* 36(2), 207–213.
- Bransford, J. D., Brown, A. L., & Cocking, R. R. (Eds.) (1999). *How People Learn. Brain, Mind and School*. Washington DC: National Academy Press.
- Brown, J. S. (2000). Growing up in a digital age. *Change* 32(2).
- Brown, J. S., Duguid, P., & Collins, A. (1989). Situated cognition and the culture of learning. *Educational Researcher* 18(1).
- Bruner, J. (1990). *Acts of Meaning*. Cambridge, MA: Harvard University press.
- Bruner, J. (1996). *The Culture of Education*. Cambridge, MA: Harvard University Press.
- Burke, J. (2001). *Illuminating Texts. How to Teach Students to Read the World*. Portsmouth, NJ: Heinemann.
- Chaiklin & Lave (1993). *Understanding practice. Perspectives on Activity and Context*. Cambridge: Cambridge University Press.
- Clandinin, D. J. & Connelly, F. M. (2000). *Narrative Inquiry: Experience and Story in Qualitative Research*. San Francisco: Jossey-Bass.
- Coffey, A. (1999). *Ethnographic Self. Fieldwork and the Representation of Identity*. London: Sage.
- Collis, B., Cook, A., & Margaryan, A. (2003). Activity-based learning in a multicultural corporation. Invited Paper Presented at the *World Conference on Elearning*. Edinburgh [Online]. Available at ([www.elearninternational.co.uk](http://www.elearninternational.co.uk)).
- Cottel, T. J. (2002). On narratives and the sense of self. *Qualitative Inquiry* 8(5).
- Curtis, D. D. & Lawson, M. J. (2001). Exploring collaborative online learning. *Journal of Asynchronous Learning Networks* 5(1), 21–34.
- Daniels, D. H. (1999). Language issues in a multilingual masters program in community education. In: Limage, L. (Ed.) *Comparative Perspectives on Language and Literacy. Selected Papers From the Work of the Language and Literacy Commission of the 10th World Congress of Comparative Education*, UNESCO-BREDA, Dakar.
- DiSessa, A. (2000). *Changing Minds. Computers, Learning and Literacy*. Cambridge, MA: MIT Press.
- Ellul, J. (1964). *The Technological Society*. New York: Alfred A Knop.
- Engeström, Y. (1991). Activity theory and individual and social transformation. *Activity Theory* 7(8), 6–17.
- Engeström, Y. (1999). Activity theory and individual and social transformation. In: Engeström, Y., Miettinen, R. and Punamäki, R. -L. (Eds.) *Perspectives on Activity Theory*. Cambridge, YK: Cambridge University Press, 19–38.
- Fortuin, B. (2002). First-time e-learners' experience in an online programme. Unpublished Master's Dissertation. Johannesburg: Rand Afrikaans University.
- Geertz, C. (1973). *The Interpretation of Cultures*. New York: Basic Books.
- Gubrium, J. F. & Holstein, J. A. (2002). From the individual interview to the interview society. In: Gubrium, J. F. and Holstein, J. A. (Eds.) *Handbook of Interview Research. Context and Method*. London: Sage.
- Hammersley, M. & Atkinson, P. (1995). *Ethnography. Principles in Practice*, 2nd ed. London: Routledge.
- Headland, T. N., Pike, K., & Harris, M. (1990). *Emics and Etics. The Insider/Outsider Debate. Frontiers of Anthropology*, Vol. 7. London: Sage.
- Henning, E. (2002). *Essay Review of: Burke, J. Illuminating Texts: How to Teach Students to Read the World*. Available at <http://www.tcrecord.org/Content.asp?ContentID=10884>.



- Henning, E. (2003). "I click, therefore I am (not)": Is cognition "distributed" or is it "contained" in borderless e-learning programmes? Paper Presented at the *World e-learning Conference*. Edinburgh, 9–12 February.>
- Henning, E. & Brown, R. (2002). Learning to learn online: epistemological perturbation when a functionalist curriculum is challenged. International Conference of the *Improving University Teaching (IUT)* Organisation. Lithuania: Vilnius Pedagogical University, 319–324.
- Henning, E. & Van Rensburg, W. (2002). Re-zoning proximal development in a parallel e-learning course. *South African Journal of Education* 22(3), 58–72.
- Henning, E., Mamiane, A., & PHEME, M. (2000). Research methodology and writing composition: two faces of emergent scholarship. *Research Report for the South African National Research Foundation*. Johannesburg: Rand Afrikaans University.
- Holliday, A. (2002). *Doing and Writing Up Qualitative Research*. London: Sage.
- Kaptelinin, V. (1996). Activity theory: implications for human-computer interaction. In: Nardi, B. (Ed.) *Context and Consciousness*. Cambridge, MA: The MIT Press, 103–116.
- Kerlin, S. (2002) Scott Kerlin's resource pages [Online]. Available. [www.geocities.com/HotSprings/4668/living.htm](http://www.geocities.com/HotSprings/4668/living.htm) / <http://kerlins.net/scott/edResearch.html>.
- Kozulin, A. (1990). *Vygotsky's Psychology. A Biography of Ideas*. Cambridge, MA: Harvard University Press.
- Kuutti, K. (1996). Activity theory as potential framework for human-computer interaction research. In: Nardi, B. (Ed.) *Context and Consciousness*. Cambridge MA: The MIT Press, 17–44.
- Lave, J. (1988). *Cognition in Practice*. Cambridge: Cambridge University Press.
- Lave, J., & Wenger, E. (1991). *Situated Learning. Legitimate Peripheral Participation*. New York: Cambridge University Press.
- Leont'ev, A. (1978). *Activity, Consciousness and Personality*. Englewood Cliffs, NJ: Prentice-Hall.
- Merriam, S. B. (1999). *Qualitative Research and Cases Studies Applications in Education*. San Francisco: Jossey-Bass.
- Nardi, B. A. (1996). *Context and Consciousness. Activity Theory and Human-Computer Interaction*. Cambridge, MA: MIT Press.
- Nardi, B. A., & O'Day, V. L. (1999). *Information Ecologies. Using Technology with Heart*. Cambridge, MA: MIT Press.
- Oliver, R. (1996). The Western Australian Tele centres Network: A model for enhancing access to education and training in rural areas. *International Journal of Educational Telecommunications* 2(4), 311–328 [Online]. Available at <http://dl.aace.org/9275>.
- Oliver, R., & Omari, A. (2001). Exploring student responses to collaborating and learning in a web-based environment. *Journal of Computer Assisted Learning* 17(1), 34–47.
- Pavlenko, A. (2002). Narrative study: whose story is it anyway? *TESOL Quarterly* 36(2).
- Phillips, D. C. (Ed.) (2000). *Constructivism in Education. Opinions and Second Opinions on Controversial Issues. Ninety-Ninth Yearbook of the National Society for the Study of Education*. University of Chicago Press: Chicago.
- Phillips, N., & Hardy, N. (2002). *Discourse Analysis. Investigating Processes of Social Construction*. London: Sage.
- Postman, N. (1993). *Technopoly. The Surrender of Culture to Technology*. New York: Vintage Books.
- Reed-Danahay, D. (Ed.) (1997). *Auto/Ethnography. Rewriting the Self and the Social*. New York: Berg.
- Riessman, C. K. (2002). Analysis of personal narratives. In: Gubrium, J. F. and Holstein, J. A. (Eds.) *Handbook of Interview Research. Context and Method*. London: Sage, 695–710.
- Rogoff, B. (1990). *Apprenticeship in Thinking. Cognitive Development in Social Context*. New York: Oxford University Press.

- Salomon, G. (1993). *Distributed Cognitions. Psychological and Educational Considerations*. Cambridge: Cambridge University Press.
- Salomon, G. (1999). Individual and societal aspects of learning [Online]. Available. <http://construct.haifa.ac.il/~gsalomon/indsoc.htm>.
- Stake, R. E. (2002). Case studies. In: Denzin, N. K. and Lincoln, Y. S. (Eds.) *Strategies of Qualitative Inquiry*. Thousand Oaks, CA: Sage.
- Vygotsky, L. (1978). Cambridge, MA: Harvard University Press.
- Vygotsky, L. (1992). *Thought and Language* (ed. and rev. A. Kozulin, 6th Edition). Cambridge, MA: MIT Press.
- Warschauer, M. (1999). *Electronic Literacies. Language, Culture and Power in Online Education*. Mahwah, NJ: Lawrence Erlbaum.
- Weigel, Van B. (2002). *Deep Learning for a Digital Age*. Jossey-Bass: San Francisco.
- Wertsch, J. V. (1991). *Voices of the Mind. A Sociocultural Approach to Mediated Action*. Cambridge MA: Harvard University Press.
- Wolcott, H. F. (1994). *Transforming Qualitative Data. Description, Analysis and Interpretation*. Thousand Oaks, CA: Sage.

## Chapter 22: Virtual Communities of Practice

KATHRYN HIBBERT AND SHARON RICH

*Faculty of Education, University of Western Ontario, 1137 Western Rd., London, Ontario, Canada N6G 1G7*

### 1. INTRODUCTION

There is an increased interest in the use of virtual technology and distance courses in professional education. Teacher education is no exception, particularly with pressures to maintain professional standards. The problem of course is that the conception of what it is to be a professional teacher influences the development of such courses and programs. If teacher is characterized as *discerner*, with the ability to “transform understanding, performance skills, or desired attitudes or values into pedagogical representations and actions” (Shulman, 1987: 4) then teacher knowledge (of content, students, and pedagogy) is of paramount importance. If however, teacher is characterized as *disseminator*, charged simply with carrying out the dictates of others, then complex forms of knowledge are not essential. The former implies a need for professional development that informs, enriches and extends teacher knowledge. The latter suggests that training in new materials is sufficient.

Current curricular conditions and a plethora of supplemental *teacher-proof* materials would seem to support a non-professional characterization of teacher as disseminator. Such a reductionist view of the teacher has led to a model of ‘professional development’ commonly referred to as *train-the-trainer*. The model provides systematic training in recently released documents, programs or materials to a target group of people. In pyramid formation, the newly ‘trained’ would then re-inscribe large groups in exactly the same fashion.

The characterization of teacher as disseminator inhibits meaningful professional growth and perpetuates curricular conditions that limit the potential of the teaching learning process. Reflecting upon the adage: *Treat people as if they were what they ought to be, and you help them become what they are capable of being*, we wondered whether characterization of teachers as discerners would lead to changes in curricular conditions and in the ways in which online courses could be constructed.

Smylie and Conyers (1991) have argued that it is necessary to shift from “deficit-based to competency-based approaches in which teachers’ knowledge, skills, and experiences are considered assets” (p. 2). The conceptualization of the online learning environment as a way to value teacher

knowledge enables the development of a critical complex epistemology (Kincheloe, 2004). This epistemology

... involves teachers as knowledge producers, knowledge workers who pursue their own intellectual development. At the same time such teachers work together in their communities of practice to sophisticate both the profession's and the public's appreciation of what it means to be an educated person. (p. 51)

As other researchers have observed, an online learning community can be designed to “support the actual practices and daily tasks of the participants” (Shultz & Cuthbert, 2002) at whatever point they may be in their learning. At the same time, it can bring professionals together to discuss new research and ways in which their learning informs their professional practice. In this chapter we draw from the work we have done with in-service teachers at the Faculty of Education, University of Western Ontario to consider the ways in which online courses can become communities of professional practice that support and extend the notion of the professional teacher as a discerner who develops a critical complex epistemology.

We begin by discussing communities of practice in both the face-to-face and virtual community, indicate the ways in which Shulman's model of pedagogic reasoning and action can be applied to the online environment, and finally use the example of our carefully designed online courses to highlight the ways in which virtual communities of practice can assist teachers to become professionals who are discerners rather than disseminators.

## 2. WHAT IS A COMMUNITY OF PROFESSIONAL PRACTICE?

Social learning theorist Etienne Wenger (1998) notes that communities of practice are celebrated by businesses within the knowledge economy while for years educators have recognized the notion of community as creating a supportive learning environment in which learners are expected to be active and involved in creating knowledge. Dewey (1963, 1966) talked about such communities and Rich (1991) referenced the concept in a study of informal teacher support groups noting that in these groups the members became excited about new knowledge as they integrated information about best teaching practice with their experiences. They shared with others and advocated for new ways of teaching language and literacy.

Wenger's model of a community of practice (Wenger, 1998) places learning in the context of social practices. For him, a community of practice has coherence created by three factors: indigenous enterprise, regime of mutual accountability, and shared repertoire. He suggests that meaning in communities is derived through the negotiation of two main components,

*participation and reification* and examines the potential for a community of practice to negotiate meaning as it respects the informed contributions of all members.

For Wenger, indigenous enterprise develops within larger historical, social, cultural, and institutional contexts with both fiscal constraints and supports. The conditions may be explicit, or implicit, but both are binding:

... even when the practice of a community is profoundly shaped by conditions outside the control of its members... its day-to-day reality is nevertheless produced by participation within the resources and constraints of their situation, and is therefore their enterprise.

(Wenger, 1998: 76)

Members of a community of practice may face common problems, but each may define and approach them differently. For example, in a learning context involving teachers, participants may tell stories about struggles encountered in meeting the expectations of curriculum documents, administrators, parents and the needs of the students. The storytelling and the responses from others, who have resolved similar issues, assist them to come to new understandings and move forward. Indigenous enterprise is always negotiated by the professional community.

The regime of mutual accountability refers to members' concerns about their professional practice and the context within which they act:

While some aspects of accountability may be reified—rules, policies, standards, and goals—those that are not are no less significant. Becoming good at something involves developing specialized sensitivities, an aesthetic sense, and refined perceptions that are brought to bear on making judgments about the qualities of a product or action. That these become shared in a community of practice is what allows the participants to negotiate the appropriateness of what they do.

(Wenger, 1998: 81–82)

Teachers in a professional course may eventually tell a story of a student(s) with whom they have had little success. Sometimes, this lack of success is blamed on external factors (poor preparation by the home, English as a Second Language, learning differences, lack of resources). While any and all of these conditions may contribute to struggles in the school setting, responses from a supportive, professional community (including the instructor) encourage the teacher to develop a sensitivity and awareness of the student's predicament, and a recognition of what can be done.

Shared repertoire is the shared pursuit of an enterprise (i.e., teaching reading well). Routines, words, tools, ways of doing things, stories and so forth all belong in this third characteristic, although the elements themselves can be

very different:

They gain their coherence not in and of themselves as specific activities, symbols, or artifacts, but from the fact that they belong to the practice of a community pursuing an enterprise. . . . It includes the discourse by which members create meaningful statements about the world, as well as the styles by which they express their forms of membership and their identities as members.

(*Ibid.*: 83)

In the online environment, teachers come together to learn ways to improve their practices in teaching. Discussions and language assume a basic level of familiarity with acronyms (i.e., Individual Education Plan—IEP) and reading practices. Through mutual engagement, participation and reification weave together. As individuals engaged in joint enterprise, they create relations of mutual, professional accountability. Through engaging in dialogue, the community becomes a resource for negotiating meaning.

The following five questions determine whether an environment has evolved into a community of practice:

1. Do group members take responsibility for their own learning?
2. Do members share their learning and the learning of the group?
3. Do group members believe that they can improve their practice?
4. Do group discussions show development of ideas?
5. Do group members see themselves as constructivist knowers?

If the answers to these questions are yes, then a community of practice has been created and members share knowledge and support one another in knowledge construction. As the group matures, the members develop a group expertise distinct from that held individually and are committed to collective goals.

Communities of practice exist inside and across institutional boundaries. The community of practice offers possibilities for transforming learning and linking individuals who share a set of problems and issues. What we consider in the next section of the paper is how the elements of a community of practice might be reflected in the virtual context. We assume that in a virtual community, those who access the web can begin to realize its potential to build knowledge and we draw on our experiences as researchers and teachers in the online environment to explicate what can and does happen in such communities.

### 3. WHAT MAKES AN EFFECTIVE VIRTUAL COMMUNITY OF PRACTICE?

Virtual communities of practice are similar to those outlined by Wenger. They share the characteristics of indigenous enterprise, regime of mutual

accountability and shared repertoire, but also provide an ‘enunciative space’ in which participants can make meaning. Enunciative space is defined as:

the opportunity to articulate what it meant to be a [professional in a particular practice]; to tangle with social issues beyond the technicalities of [the profession]; and having some agency within which to question and challenge the wider structures surrounding [the practice]; and in the process gaining some ownership of the determination of ones’ own [professional] work.

(Smyth, 2001: 159)

Many have described online learning as a “powerful tool for the development of critical thinking and deliberative skills. The dependence of current conferencing technologies on writing enables students to reflect more deeply (than the immediacy of face-to-face responses) on their ideas as they try to articulate them effectively” (Eastmond, 1998: 73). Bliss and Mazur (1996) examined ways in which technology could support the creation of a shared culture, concluding with a call to create cases to be used to support and encourage those working through constant change.

Research into online education, in general, supports successful learning attributes of adult learners (Bereiter, 2003). An online environment can offer a degree of flexibility, independence and choice that appeals to adults, many of whom are studying in addition to raising families and working outside of the home. In addition, opportunities exist for collaboration with others around a shared interest, interaction with issues that they deem to be important, application of their learning and the development of a sense of community (Eastmond, 1998). A virtual community of professional practice respects learners through its design, by capturing participants practice in a way that makes visible not only methods and techniques, but also making visible the beliefs, values, policies and institutional structures that may have informed that practice. A virtual community of professional practice:

1. Establishes and build on commonalities
2. Fosters dialogue between participants
3. Encourages links between and application of learning to practice
4. Recognizes the expertise of learners. (Rich, 2002)

Palmer (1998) argues that professional communities assist members to grow while at the same time he points out the irony that while individuals often can serve as the best resources for each other, the organizational structure of the institution often inhibits access. Online communities can help counter isolation in part through sustained and purposeful interaction outside of the structures of the individual institutions in which people work. Asynchronous online communities of professional practice provide participants with the

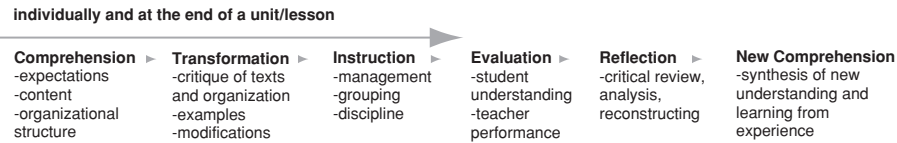

Figure 1. Linear model of pedagogic reasoning and action: individual. Source: Adapted from Shulman (1987).

ability to compose and post messages after they have had an opportunity to “digest and reflect on information” (Eastmond, 1998: 35).

In the professional practice world of the teacher, a virtual community of practice can provide an enunciative space that is not often found within schools. Shulman’s model of pedagogical reasoning and action (Figure 1) aims to assist teachers in developing a wisdom of practice that presumably leads to ‘good teaching’.

Yet this model is limited when the teacher is alone in the classroom because the individual has access to only his/her current understandings and experience. Moreover, if teachers are trying to *perform* their job in ways that have been narrowly conceptualized and presented as *best practice*, there is potential for a static understanding of teaching. In this scenario, teachers’ descriptions of practice are generally considered interpretive, highly personal and insular.

To consider our virtual communities of practice in teaching we adapted Shulman’s model to the virtual environment (see Figure 2). In the virtual context rather than reviewing practice in a systematic and hierarchical fashion alone, individuals were challenged to deliberate about their practice as they participated in it. While deliberations about practice provided a broader base of experience and circumstances, the skilful integration of theoretical and academic discourses provided an overarching framework and the tools needed to critique practice addressing larger socio-political and social justice issues.

Although Shulman (2004) did not investigate virtual communities specifically, the principles developed in studies of communities (i.e., generative content, active learning, reflective practice, collaboration, passion) apply.

#### 4. DEVELOPING A VIRTUAL COMMUNITY

Six years ago, the Faculty of Education, University of Western Ontario made a commitment to providing online in-service course for practicing teachers. As faculty members, we knew that many of the teachers we encountered in our in-service work across the province were eager to increase their level of expertise and knowledge. We also knew from a survey that we had conducted that many teachers were hesitant to embrace new technology but would do so if it were easy to access and enabled them to participate in professional





Figure 2. Online model of pedagogic reasoning and action: community. Source: Adapted from Shulman (1987).

development at their convenience. Thus one of the first issues we had to address in our move to online in-service was the technology itself. That is, what could the technology ‘do’ and did its ability to ‘do’ something overwhelm or support the interaction of the participants? We knew from our experiences with teachers that people had to matter more than the technology and we suspected that the principles discovered in face-to-face communities would be just as significant in an online context, that is, people like to talk; they rarely like to be told what to do; and, they want to learn in order to improve practice. Technical developments need to evolve in a way that supports and facilitates interaction in order to nurture the development of community.

Technological development should reflect the needs and desires of the members. In considering how technology will facilitate the development of a virtual community, we thought about how community members would access the web. The answer to this question informed decisions about the types of supportive web-based material that could be used. For example, if members access the web from rural areas without high-speed connections, streaming video and live chat could be problematic. The geographic location of users

also influenced decisions about the value of particular technologies. If users are all in one time zone then synchronous chat might be a viable option.

Issues of web security also need to be considered. Our research has indicated that closed virtual communities may provide a greater sense of security for members because they know who has access to their discussion. They can be more open and discuss a range of topics when an enunciative space is created for them to interact with each other. A private community needs a secure, password-protected site with controlled entry. On the other hand a public site can garner diverse opinions (freedom in anonymity) but may inhibit the creation of a knowledge building community.

##### 5. THE VIRTUAL COMMUNITY OF PRACTICE TRIANGLE: USING THE WEB AND ITS POTENTIAL

After experimenting with a number of commercial platforms, all of which purported to be able to deliver the type of course we wanted, the Faculty invested in the development of its own platform, eCampus. Able to work closely with information technology personnel, we developed a platform that married technology and pedagogy in ways that allowed us to be more responsive to instructors and teacher-learners. Through our work we discovered that conceptualizing our courses as triangles help to determine what has to be in place for successful evolution. We noted that to be effective virtual communities of practice use the web, online conferencing and independent reading and thinking to facilitate changes in individual community member's and groups of members' practices. In short, knowledge construction in the virtual community of practice requires:

1. A website with content specific to the target community.
2. Resources for community members' individual and shared professional development. Many of these include online readings and resources.
3. A discussion tool that can simulate the face-to-face interaction in an online context.

We learned too that in the courses that were most successful in establishing community, the group leader or facilitator plays a critical role in establishing the tone of the group and helps to move its work forward. As part of a dynamic ensemble, the instructor functions as co-learner (Rich, 2004). The entire community interacts in the learning process to negotiate meaning through discussion around readings, course content and with each other. The three points of the triangle touch on the three main components of a dynamic environment.

The content created to support a virtual community conforms to principles of good web design and provides links to areas of potential interest to the



Figure 3. Model of online learner. Source: Rich and Hibbert (2004).

group. For example, in an online community dedicated to learning more about literacy practices, specific areas might be devoted to early, middle or late years' literacy development. Controversial issues such as high stakes testing may also be featured. Embedded within the web content will be key questions that help community participants think about the issues. In other places on the website, a mouse click may spawn a daughter window that takes the community member to an online article for further reading. Still other areas of the website provide a series of resources that the community member can order or access through a local library. Each time the community member logs into the site there is possibility for conversation since a user friendly conference is linked to it. When the community member goes to the conference, he or she can see the topics that have been posted. A click on a topic provides a glance at what others have said about an issue raised on the website. A click on another topic provides an opportunity for the community members to raise questions about a reading that has just been completed. Learning occurs as a result of reading the discussion, the web content and the additional websites or local articles and actively participating in writing responses to questions and comments posed by other members of the online community. As group members write their responses they present emerging concepts and relate those to previously held ideas. As others respond to their postings ideas are clarified and refined. Over time the group members each take control and push the thinking and interaction of the group as a whole to a new level as knowledge is constructed through discussion.

## 6. THE GROUP FACILITATOR'S ROLE IN BUILDING AND MAINTAINING COMMUNITY

As noted previously, if the online environment is to move from simply knowledge dissemination towards a supportive community of practice, the facilitator plays a key role. First, a supportive learning environment must be established. Creating that environment demands a substantial time commitment that permits reflection and thoughtful responses. The facilitator establishes a series of topics in the conference area, some of which may be related to web content and some of which may arise from particular readings that members share. Each of these topics may have a defined start and end date to focus discussion. Interaction is fostered initially by the facilitator who starts the process to enable each member to share ideas, be supported and to learn. Since in an online community, discussion takes place across time and space, participants bring experiences from widely spaced communities to bear on the talk. Rich and Woolfe (2001) point out that in order to generate a socially integrated learning community, the facilitator has to help community members recognize that they are interacting with real human beings at the other end of the computer. By encouraging comments on each other's posts and occasionally summarizing the discussion, the facilitator makes the discussion more interactive and real.

The facilitator also has to recognize that electronic discourse in the virtual community has embedded within it a set of possibilities and limitations. For some, fear of writing ideas and exposing them in a semi-public forum can be an inhibiting factor that may cause them to lurk rather than get involved in the community. Expecting regular interaction and modelling the types of discourse expected, the facilitator can alleviate any initial fears. Ideally for a community of practice to develop, online expectations need to be established. For example, if a face-to-face community meets once a week, members of the virtual community should be expected to participate in virtual discussion once a week. Once those expectations are in place the group has a greater likelihood of being successful in becoming a community of practice.

As virtual community members write their responses to each other, they select words to represent their emerging understand of the issue at hand and relate those emerging concepts to ones already held. When others respond to their postings, emerging thoughts and ideas may be reconstructed to take in new information. Meaning is negotiated, a sustained history of practice is created and members can let each other know about opportunities for ongoing development. New members to the community infuse it with alternative practices and knowledge and at the same time learn from the established members about the practices of the past. The tension between new and established forms of knowledge creates a dynamic learning community. Wenger (1998) has suggested that any creative work requires personal investment and social energy. We have suggested that the online community of practice, if facilitated appropriately, can provide a space for personal investment and social

energy that can enrich lives of participants and become a site for knowledge construction.

7. WHAT CHARACTERIZES EFFECTIVE VIRTUAL COMMUNITY-BUILDING INTERACTION?

In order to sense real people in the virtual world, group members need to have opportunities to see themselves reflected in the others online. Establishing commonalities creates the sense of ‘others like me’ and sets the groundwork for later discussion of difficult concepts or complex ideas. One way of establishing commonalities is the creation of a topic that is devoted to learning about community members. In many of the contexts we have researched this common area is called a bistro. The facilitator’s modelling establishes the tone and the type of language used. For example the first post by the facilitator might look something like this:

Hi, and welcome to our online community. Grab a cup of coffee and get to know the other members of our community.

The facilitator then goes on to say:

Welcome. I have been involved with early childhood education for more years than I would like to tell you. My interest is both professional and personal since as a mom I raised three children and hope to someday be a grandmother—to something other than a puppy. I have been involved in CAYC and presently teach courses in early childhood in the public school through my work at a faculty of education.

The first post is a key one because it opens the possibility for non-threatening discussion and we know that as human beings we are interested in the personal lives, work and worlds of others. Once the introductions have been made the conversation needs to be sustained through the use of immediacy statements. Such statements comment on what is currently happening in the online discussion. For example, in one of the communities we studied a post read, “Wow! People with lives. . . babies, puppies, gardens and all of us interested in teaching.” The community member who made that post went on to comment on the previous nineteen posts prompting another community member to write,

I am really looking forward to getting to know everyone. Has anyone here read Vivian Paley? I heard that she has a new book and can’t remember the title.

The immediacy of her statement cued other members to ask for assistance and interact around their own social and professional needs.

To build an effective community of practice, the facilitator uses probes to further the discussion and get more information into the community context. Bringing additional information, challenges or different perspectives into the group forum helps the members build knowledge. For example,

Paley worked out of the University of Chicago preschool. It seems to me that some of her observations of children's language have much to tell us about the ways in which good teachers interact with children. I wonder how her observational research into children's language complements some of the more structured data that some researchers are interested in.

This probe builds on a question raised before, adds some additional information and encourages community members to think about different approaches to research with young children. Rather than imposing information on the group, the question encourages group members to take ownership and think about the questions for themselves. The probes could also be accompanied by a link to Paley's website and another link to a site in which a different type of language research is conducted. Essentially, the facilitator is modelling effective interaction for knowledge construction.

There are times too when group members and the facilitator must challenge perspectives presented in the discussion. Challenges take various forms and may include several different viewpoints that drive the discussion from a surface level to one where insight and new learning can occur. They are an important part of the repertoire of discursive practices in an online environment. The facilitator or another community member may suggest something like:

The website suggests that early years' teachers should respect ESL students' first language and culture. Some of you have provided examples of first languages and cultures clashing in the classroom. You have noted that when these biases are there you often wonder whether there should not be a place for a Canadian language and culture. How might we be sensitive and reconcile these issues as we work with the children in our care?

Participants have the opportunity (and time in an asynchronous environment) to first reflect upon the discussion, and then extend their ideas, thinking about the issues that inform their practice. By referencing the website, the facilitator encourages members to read further and draw on information from the site for further reflection and dialogue. Community members eventually construct their own knowledge within the learning environment. Their knowledge is not

borrowed from the website but through thoughtful interaction is constructed through personal and social experience, informed by external sources.

8. IN WHAT WAYS CAN VIRTUAL COMMUNICATION ENHANCE PARTICIPANTS' GROWTH?

As participants enter 'enunciative space', they are more likely to shed institutional 'cover stories' (Connelly & Clandinin, 1999) and have in-depth conversations that deal with their concerns, their fears and their feelings of vulnerability and inadequacy. For example, teaching all children to read adequately can be a monumental task, and some children (and their particular ways of learning) can challenge even the most successful, seasoned and dedicated teachers. Recognizing and facing these challenges and concerns in a supportive group of peers allows fears to be voiced and enables movement beyond them to develop strategies to cope with feelings around a lack of competency. In turn, participating in professional dialogue with others works to develop a culture of professional respect.

Developing knowledge, in the 'wisdom of practice' sense that Shulman describes is achieved through a dynamic process of negotiation: "of continuous interaction, of gradual achievement, and of give-and-take" (Wenger, 1998: 53). A significant level of intimacy and knowledge about the professional practices of the participants is achieved when the virtual community develops.

Perhaps because participants depended solely upon written language to communicate, they are obliged to lay their practice out (and in many cases this includes their struggles) in ways that allows it to be viewed, understood and critiqued by others. In some virtual communities, many report that this to be the first time they had looked closely at their own practice or had acknowledged what was not going well. The resulting scrutiny goes beyond the pedagogic model of reasoning Shulman (1987, 2004) proposed and Schön's (1983) reflection-in-action. When reflection is made public in the virtual environment, the participants' reasoning and reflection evolves into a more complex fluid process that generates a deeper understanding that is capable of leading to transformative change. A virtual community of practice can create a culture of professional respect.

Wenger's social theory of learning functions in the virtual community of practice in a way that encourages shifts in practitioners' attitudes, knowledge and identity. The components in the virtual learning community are:

1. *Making Meaning*: enables members to individually and collectively experience their lives and the world as meaningful.
2. *Discussing Practice*: provides members a way to talk about their shared historical and social resources, frameworks, and perspectives that sustain mutual engagement in action.

3. *Growing into a Community*: members become a community as the social configurations of their practice and their group is seen as worth pursuing and helping us gain competence as professional persons.
4. *Reformulating Identity*: participation in the virtual community provides a space for talking about how learning changes who we are and reshapes our personal histories within the context of our communities (adapted from Wenger, 1998: 5).

Participation in a virtual community of practice causes a shift from a singular identity, to a more complex and dynamic one. Viewing practice in critical complex ways, through the eyes of their colleagues' and facilitators' contributes to that shift in identity from a technical worker, to a more expansive identity of a professional. As 'Roz' reflects,

I find my own strengths as a teacher lie in my ability to accumulate and connect resources and ideas and integrate them across the spectrum of my teaching, however needs assessment and evaluation are areas I need work on. I think my greatest challenge ahead will be figuring out what does and doesn't work and finding a tangible means to measure it. Whereas I would have included myself among those teachers uncomfortable with the word 'teacher researcher', I see that to ask these questions and seek the answers are on the path to becoming what it means to be professional. It's an exciting journey.

This shift is important, as community members become more aware of their professional responsibilities to act, rather than simply to accept knowledge uncritically. Virtual communities of practice also encourage participants to find their 'voices', respect the voices of others and begin to take risks in their thinking and in their professional lives. Finding voice, and having opportunities to talk (write) through thinking has long been recognized as a pedagogically significant practice for learners. The mutual respect that evolves as members enter the enunciative space of the community allows them to step back and rethink their own practice as viewed through the eyes of colleagues. When online courses are designed to evolve into a virtual community of practice they provide opportunities for members to engage in transformative learning.

## 9. CONCLUSION

Just as the conception of what it is to be a professional teacher has profound implications for courses and programs, the way in which the virtual learning environment is conceptualized has similar repercussions to the courses and programs developed.



If the virtual learning environment is conceptualized merely as a vehicle for a teacher as disseminator of information then the technology and supports developed will ensure just that. Course content will be pasted into technical environments that students can access. Virtual contact with the instructor will be minimal. Assessment will depend largely on the technological tools available (i.e., electronic quizzes), rather than what may be pedagogically sound practice. The role of the instructor in this scenario is likened to that of a tutor, with participation reduced to posting announcements, clarifying instructions and responding to e-mail.

Alternatively, if the virtual learning environment is conceptualized as a site for knowledge construction, then the ways in which it is supported and designed are significantly different. The focus remains fixed on pedagogy and building learning communities. The technology responds and evolves to address those needs. Instructors/Faculty are not in place to simply manage and assess, but are invested in developing a meaningful learning environment in which they also engage intellectually in the learning and knowledge construction.

Decisions around the implementation and use of virtual learning environments are influenced and informed by political and economic factors, and often to a lesser extent, pedagogical considerations. We believe that in order to sustain the momentum experienced by many early adopters, attention to pedagogy must move to the forefront. Unless the virtual learning environment becomes an effective community of professional practice where enunciative space is created for participants to learn and grow and re-energize, technological saturation and fatigue will set in. The convenience of distance education that may have initially attracted participants to a virtual learning environment may be abandoned for something more intellectually, socially and creatively satisfying.

Further research is needed to understand this more fully. It is difficult to imagine how we can expect participants in virtual learning environments to apply their knowledge and understanding in new and innovative ways in the workplace, if we do not create such environments for them to grow professionally. We hearken back to Senge's challenge to learning organizations, to build

... organizations where people continually expand their capacity to create the results they truly desire, where new and expansive patterns of thinking are nurtured, where collective aspiration is set free, and where people are continually learning how to learn together.

(Senge, 1990: 1)

It is a notion worth revisiting. In virtual learning environments, students are already separated by time and distance. When institutions (under pressure to 'get online') design and develop courses without the necessary thought, infrastructure and planning required to create appropriate conditions for

learning in a virtual environment, they are in essence creating electronic tools and appliances that *virtually sabotage* transformational learning. Those of us working in the field where virtual learning environments are being considered, have a responsibility to our institutions, and more importantly to our students, to ensure that the appropriate conditions for meaningful and engaging learning are met.

#### REFERENCES

- Bereiter, C. (2003). Learning technology innovation in Canada. *Journal of Distance Education* 17(3, Suppl).
- Bliss, T. & Mazur, J. (1996). Crating a shared culture through cases and technology: the faceless landscape of reform. In: Desberg, P. (Ed.) *The Case for Education: Contemporary Approaches for Using Case Methods*. Needham Heights, MA: Allyn & Bacon, 15–28.
- Connelly, M. & Clandinin, D. J. (Eds.) (1999). *Shaping a Professional Identity: Stories of Educational Practice*. London, ON: Althouse Press.
- Dewey, J. (1963). *Education and Experience*. New York: Collier Books.
- Dewey, J. (1966). *Democracy and Education: An Introduction to the Philosophy of Education*. New York: The Free Press.
- Eastmond, D. (1998). Adult learners and internet-based distance education. In Cahoon B. (Ed.) *Adult Learning and the Internet*. San Francisco: Jossey-Bass.
- Kincheloe, J. (2004). The knowledges of teacher education: developing a critical complex epistemology. *Teacher Education Quarterly* 31(1), 49–67.
- Palmer, P. (1998). *The Courage to Teach: Exploring the Inner Landscape of a Teacher's Life*. San Francisco: Jossey-Bass.
- Rich, S. J. (1991). The teacher support group. *Journal of Staff Development* 23(6).
- Rich, S. J. (2002). *Handbook for Instructors of Online Learning*. London: University of Western Ontario.
- Rich, S. J. (2004). No more boundaries: narrative pedagogy and imagining who we might become. Paper presented at the *Risky Business, Shifty Paradigms: Teaching-Learning in a Phenomenological Curriculum*, Western-Fanshawe Collaborative Nursing Program Faculty Development, Ingersoll, Ontario.
- Rich, S. J. & Hibbert, K. (2004). Designing an online course for distance education course instructors and authors. In: *Proceedings of the 20th Annual Conference on Distance Teaching and Learning*, University of Wisconsin, Madison, WI, August 4–6, 2004.
- Rich, S. J. & Woolfe, A. (2001). *Creating Community Online*. Melbourne: Common Ground Press.
- Schön, D. A. (1983). *The Reflective Practitioner: How Professionals Think in Action*. New York: Basic Books.
- Senge, P. M. (1990). *The Fifth Discipline: The Art and Practice of the Learning Organization*. London: Currency Doubleday.
- Shulman, L. S. (1987). Knowledge and teaching: foundations of the new reform. *Harvard Educational Review* 57(1), 1–21.
- Shulman, L. S. (2004). *The Wisdom of Practice: Essays on Teaching, Learning and Learning to Teach*. San Francisco: Jossey-Bass.
- Shulman, L. S. & Shulman, J. H. (2004). How and what teachers learn: a shifting perspective. *Journal of Curriculum Studies* 36(2), 257–271.
- Shultz, G. & Cuthbert, A. (2002). Teacher professional development & online learning communities. Available Online: <http://www.kie.berkeley.edu/transitions/index.html>. Accessed June 2002.

- Smylie, M. A. & Conyers, J. G. (1991). Changing conceptions of teacher influence: the future of staff development. Available Online: [http://www.ed.gov/databases/ERIC\\_Digests/ed383695.html](http://www.ed.gov/databases/ERIC_Digests/ed383695.html). Accessed June 2002.
- Smyth, J. (2001). *Critical Politics of Teachers' Work: An Australian Perspective*. Oxford: Peter Lang.
- Wenger, E. (1998). *Communities of Practice: Learning, Meaning, and Identity*. Cambridge: University Press.

## Chapter 23: Increasing the Democratic Value of Research through Professional Virtual Learning Environments (VLEs)

LISA KORTEWEG\* AND JANE MITCHELL†

\**Lakehead University, Ontario, Canada*

†*Monash University, Melbourne, Australia*

“... if it (the internet) remains acephalous, then the abundance of information will be such that you will desperately need a filter... some professional filter. So you will ask somebody... an information consultant... to be your gatekeeper!”

(Eco, 1995)

One of the many promises ascribed to the internet is its potential contribution to the intellectual and the democratic life of the wired nation and the educational community (Burbules & Casllister, 2000; Barrell, 2001; Pea, 1998, 1999). We examine this potential as it is focused on the development of an education portal or a Virtual Learning Environment (VLE) that would serve teachers and researchers in the field of education. John Willinsky (2000, 2002) contends that an education portal needs “to consider how turning educational research into a more accessible public resource can further the connection between democracy and education.” An education portal that seeks to serve a larger public must pursue the goal of making more research accessible by “publishing open-access scholarly resources in an easily managed and well-indexed form” (2002). Another expression of this approach to increased e-democracy is Phil Agre’s (2001) contention that the purpose of web tools is to support the intellectual life of society:

Although the cultural language of intellectual community among non-intellectuals is not yet well-developed, internet discussion forums have obviously provided a generation of experiments in that direction. Ideally this should lead to a new kind of social (democratic) mobility: the continual building and rebuilding of intellectual community that aligns with individuals’ unfolding intellectual lives. (p. 294)

If we understand the intellectual life as one where a person has questions, thinks about them and pursues them, then it is supporting and extending these democratic functions of teachers’ professional lives that concerns this project.

One dramatic, quickly escalating use of the internet for democratic participation is the access of health research and information by patients and their families. A recent figure quoted by the University of Toronto’s Continuing

Medicine's Knowledge Transfer Project is that 58% of GPs have been approached by at least one patient with internet healthcare information and 65% of this information was new to the GPs (Wilson, 1999). The internet is a democratic means for patients to alter their knowledge relationship with their doctors.

Part of this democratic potential of the internet is its ability to post and broadcast on a global basis. The knowledge technologies developed for medical research, such as PubMed, have enabled people to come, locate, and read articles, and use them in their encounters with their doctors. The central question for our research as part of the Public Knowledge Project (PKP) at the University of British Columbia is how can we build and achieve this type of portal tool or VLE for educational research? How could we make educational research knowledge move in the same way as medical research on the internet to democratize educational encounters (parent to school district, student to teacher, teacher to researcher)?

We know that there are many real or manufactured problems in education publicized by the media. There are kids who cannot read, kids who drop out of high school and there are computers sitting in closets rarely used in the classroom (Cuban, 2001). There is also a significant amount of important substantial educational research produced every year that addresses and informs these educational crises. Yet, there are no signs that the public is taking up the cause for reading and discussing educational research, as it is with medical research. In our study, we believed we could increase public engagement with educational research if we built the right tool, the right VLE, to support the reading, discussing, and use of research by teachers and others education stakeholders.

We pursued this idea based on a conception of education where individuals explore resources freely in large multimedia databases, matching their perceived needs and interests to easily accessible research. The public users transform and synthesize this information for particular democratic purposes. The results of their intellectual work would then be evaluated by themselves and others when negotiating terms of agreement in their educational encounters. We pursued an admittedly utopian vision in which teachers and interested groups, such as parents, would pursue answers to their educational questions and problems by turning to educational portals or VLEs on the internet. The design assumption was that after reading, they would want to discuss what they have found and what they have experienced. If teachers and the public do not read and discuss, then they are just caught in the world of popular prejudices. Read and discuss is the democratic antidote. Reading and discussing research is the intellectual means by which citizens can participate online in a greater democratic education system (see Herman & Mandell, 2000; Noveck, 2005; Dahlberg, 2001).

Our two PKP projects, which we will detail below, attempted to achieve this democratic participation for two groups of teachers. We set out to test

what would happen if we gave teachers easy access to research on the topic of the social impact of educational technologies. To move academic research more thoroughly into the public domain is to create a substantial alternative source of public information. In each situation, we put most of our energies into a tool for delivering this public information, into making and constituting a database of filtered educational research that addresses questions, problems, and crises of educational technology. We, as part of the PKP research consortium, decided to create experiments that would attempt to increase public participation in educational research access, if not necessarily to the degree that is occurring in health research portals. However, our discovery is that ideas and knowledge, once made available, do not tend to circulate without additional support, even in well-managed, freely accessible technological environments, such as our two examples of VLEs. Our important discovery is that people, those with special skills called intermediaries, are needed to move these ideas and knowledge. Machines alone cannot do it.

Educational researchers know a lot about education but their research just does not travel that well out of a research archive or database. We need teacher-intermediaries who have exemplar local stories and who know how to engage fellow practitioners in intellectual conversation in order to pass on advice that is research-informed. From a teacher's point of view, such translators of knowledge or intermediaries are extremely useful. Much more than most professors or academics, they offer shared concrete experience and application into a classroom context for the teacher participants in VLEs.

We need to examine two strands of publication through the internet: the way in which web-based technology can broaden and broadcast the professional and the public value of educational research texts as well as what intellectually occurs when an educational researcher or teacher-educator enters into electronic discussion with teachers. The possibility exists that researchers can publicize their intellectual practices and influence more of the public in what is still a very public and malleable forum, the internet.

The policy entrepreneur adopts conventions of the media to make knowledge move, in order to get covered on the front page. At the same time that we want research knowledge to move into the teacher world of practice, we are going to have to figure out the conventions of teacher understanding and teacher reception of ideas. Teacher-educator intermediaries are beginning to find themselves in a position to figure this out. They are beginning to adapt academic knowledge so that it can travel into the teacher realm to make it work. As good public intellectuals, located in the university but speaking to the public on critical issues, they also know how to make knowledge move. They work as a kind of translator who makes insights and perspectives of intellectual and professional work accessible, meaningful, and relevant to as broad an audience as possible.

According to the political philosophers, Gutmann and Thompson (1996, as cited in Willinsky, 2002), the public needs to learn more about how to

participate in deliberative democracy in the following ways: “to justify one’s own actions, to criticize the actions of one’s fellow citizens, and to respond to their justifications and criticisms” (p. 65). Willinsky argues that scholarly publishing through the internet (in portals or VLEs) could do more to help people turn to research and discuss documents in this critical democratic fashion. But he adds that if we are to cultivate these critical abilities, it “will fall to the schools to teach new lessons on locating and drawing on intellectual resources that best serve these processes of justification and criticism.” (Willinsky, 2002).

Our central question in this paper is who is teaching teachers to locate and draw on intellectual resources to clarify the implications and consequences of their teaching? Who is modeling for or working with teachers on these new methods of intellectual participation through the internet? In our two case studies, we determined that it is teacher-educator intermediaries who are teaching teachers this type of intellectual engagement and social competency.

The current organization of schools does not provide teachers with the opportunities necessary to foster intellectual engagement in questions and issues arising from their practice. There are few, if any, available structures or time for sustained intellectual investigations, networks, or collaborations. The need and recognition of teachers as researchers (Cochran-Smith & Lytle, 1993; Grumet, 1990) and intellectuals (Giroux, 1988; Giroux & Shannon, 1997) have been offered in the literature but a palpable schism remains between the two institutions of schools and universities. There has been established in the research literature a clear disjunction between the educational research and the professional learning and experiences of teachers (Gore, 2001; Tom, 1997). In our study, we endeavored to examine whether an online environment and integrated digital resources could assist teachers and researchers to make connections between research and practice in ways that might extend their understanding of, in these cases, educational technology in schools. In our analysis, we sought to test and improve the accessibility and the utility of scholarly research using electronic infrastructure and knowledge management strategies (see Willinsky, 1999; 2000). After developing and implementing tools for accessing scholarship by teacher audiences, we believe it is an opportune moment to return to reflect on the primary question of what exactly is the purpose of a teacher professional portal or VLE, or, for that matter, what is the purpose of any educational portal?

The chapter describes and presents the findings from a qualitative comparison of two case studies of teachers and researchers in electronic discussion. Both groups were consulting a large digital library of electronically accessible research texts in order to participate in a threaded discussion. In both discussions, located in two different VLE platforms, academic-researchers participated in the role of guest moderator or expert leader to the discussion forum. The results of this study are based on data gathered between November 1999 and March 2000 for the first case study discussion and between August 2000 and February 2003 for the second case study.

In our analysis, we focus on ways in which teachers grapple with new technology, how teachers reflect on the educational implications of these new tools through access to research inside VLEs, and the degree to which the technology enables them to extend their professional learning and make connections between research and practice.

1. VLE #1: PKP—PRE-SERVICE TEACHER EDUCATION\*

The first PKP prototype was used in a pre-service teacher education context. This PKP prototype was a repository for resources concerned with educational technology. When first launched, the prototype linked to a series of feature articles about technology and education in the *Vancouver Sun* newspaper. In this educational situation, we worked with one instructor and the 39 student teachers in a cohort to establish an online discussion that was an assigned, credit task in an Education Studies (social foundations) course. We took an active role in this curricular situation, working with the instructor to design the task, introduce students to available electronic resources, and coordinate and participate in the online discussion.

The purpose of the “Ed. Studies Online” task was to provide a forum for students to consider the ways in which access to and uses of computer technology in schools intersected with social background and types of educational opportunity. The task set for students was to identify what they saw as crucial equity issues pertaining to technology and education and to determine action that schools and teachers can take in relation to these issues. The task asked students to bring a critical perspective, as well as some ideas for action, to an educational problem that is often based on polarized conceptions of the benefits and the drawbacks of technology. The task required students to consider the issues in a structured, electronic bulletin board discussion. Participants could draw on the PKP database to inform their ideas.

Six people external to the cohort also participated in the discussions. These people had different backgrounds and included one schoolteacher working in a local school district, a district technology consultant, but mostly, academics and graduate students working within universities. The external participants all had expertise in educational technology and/or teacher education. It was hoped that the external participants would broaden the professional scope of the discussion, and provide students with an opportunity to communicate directly with researchers, practitioners, and policy makers.

Seven discussion forums were created on an electronic bulletin board. Each forum had six students and one external participant. The forums were “public” to those with access to the bulletin board site and students were encouraged

\* Some data from this case study was originally published in Mitchell, J. (2003) Online writing: a link to learning in a teacher education program. *Teaching and Teacher Education*. 19(1), 127–143.



to read and contribute to other forums. Students were required to make a minimum of four contributions over a 7-week period. This 7 weeks comprised of 3 weeks of campus-based classes, 1 week of class-free, and 3 weeks of practicum. The guidelines for contributions were that students be succinct and address the topic; draw on web-based resources to support and provide evidence for ideas; and build on and respond to the ideas raised by other participants.

Each group chose a topic for discussion. Across the discussion forums the following topics/themes were considered: gender equity and technology; social class and technology inequities; funding for computers in schools, especially the ethics of private funding; teacher education and technology and the way that this affects educational opportunities for students; and the moral dimension of children's access to the internet. For all of these issues, there was substantial number of resources available in the PKP website.

The participants in the forum discussed in this chapter, examined issues related to technology, gender, and equity in schools. We focus our analysis on this one discussion forum because it provided clear examples of ways in which the participants used the technology to connect the research literature with their personal experience, campus-based coursework, and professional practice. It is of note that the connections that students were able to make between experience and research in this forum were more consistent and uniform than the connections made in the other forums, a point we discuss later in the paper.

The following was the first student contribution to the gender, technology, and equity discussion.

In the GenTech Research Findings Final Report by Bryson and de Castell (1998), they stated "evidence from research on gender and access to, and uses of, new information technologies (NIT's) indicates that in public schools, female staff and students (in comparison to male students) are: (a) disenfranchised with respect to access and kind of usage, (b) less likely to acquire technological competence, and (c) likely to be discouraged from assuming a leadership role in this domain." It is obvious from the references cited in this article that there is a lot of research out there regarding this statement. I think it would be interesting if we discussed any one of the three areas mentioned. A question that comes to mind is are female and male users of technology using technology for the same purposes?

If you would like to read the final report before responding, here it is:

<http://www.educ.sfu.ca/gentech/research.html>.

In this contribution the student made three intellectual moves: she quoted a research summary and identified issues worthy of discussion; she posed a question to other participants by way of starting discussion; and she provided her peers with a reference to the report that she had read, if they wanted further information. Her suggestions and questions assumed that there was more to know about this topic and that research may shed light on these issues.

Responses to this opening comment noted that typical patterns of technology use often exclude girls. These students' comments stemmed from articles and reports that they had found on the web. One student drew on a PKP resource to illustrate strategies to encourage girls to use the computer, such as Barbie Doll software.

Barbie is trying to change this situation. They have come out with Barbie software to market to the 6 to 16 girls market. What do you feel about this type of software for girls? Here is one quote from the article I read: "Anything that develops computer skills is good," says Julie Sheridan-Eng. "Even if it's just point and clicking; they don't feel intimidated by it." PKP site: <http://www.pkp.ubc.ca/sun/gender/issues/index.html>.  
*Source:* <http://www.electronic-school.com/0697f1.html>.

The above comment drew three responses including one by Caroline, the external participant. Caroline was a technology and resource teacher in an elementary school. In her response she presented her point of view on the Barbie Doll software:

Why Barbie for heaven's sake? The woman whose body proportions are so out of whack to be laughable, who has never in her fifty year lifespan had a career and who devotes herself completely to fashion... Unlike the teacher quoted in the article, this software is not something that I could ever -- in good conscience -- present to a girl in my classroom. I think the Barbie-as-airhead message undoes any of the perceived good gained by just "pointing and clicking".

Caroline rejects the argument that any use of technology is acceptable and she ties it to her own perspective in the classroom. This connection serves to contextualize the discussion and adds a critical democratic dimension.

Another part of Caroline's contribution outlined her experiences with technology and her interests in technology and gender issues. Caroline was familiar with the research conducted by Bryson and de Castell and had participated in some of their research projects conducted in schools. Thus, Caroline used this experience to make a connection to the opening comment in the discussion.

My understanding of the ideas developed by Bryson and de Castell helped me to acknowledge the power imbalance that exists around girls and technology, and I tried to ensure that this imbalance did not prevail in my classroom.

Caroline's comment provides a demonstration of ways in which a teacher can draw on research to inform classroom practice. In acknowledging Bryson and de Castell's influence on her thinking, Caroline identified power issues as being central to technology use and gender. This brought an obvious political dimension to the discussion that linked neatly with the social justice themes embedded in the Education Studies course.

The excerpt from the discussion below illustrates how one student extended the comments made by Caroline. In this case, the student worked to build ideas and connect research with experience. In the first instance, she made a link to a web-resource by way of agreeing with Caroline on Barbie Doll software and supporting her own opinion.

I agree with your opinion on the Barbie software. I feel the girls may be interested in it because the majority of them have been exposed to her since they can remember. I believe if girls are introduced to software that is engaging and thought provoking, presented in an interesting package, they would be excited about technology. After all, on the following website, <http://www.pkp.ubc.ca/sun/gender/issues/index.html>, in the article called Gender, Computing and Kids, it is stated that "girls often use computers to accomplish a goal", not just for the sake of interacting with Barbie for example.  
Source: <http://www-cse.stanford.edu/classes/cs201/Projects/gender-gap-in-education/page5.htm>.

The student also extended the discussion by asking questions about the experiences of other participants.

Have any of you observed situations in your classrooms where you felt the software was appealing to both genders? Did you observe one gender playing more than focussing on the task at hand?

The questions provided participants with an opportunity to corroborate their experiences with one another, and with the research literature they had been reading.

The student also asked Caroline some questions about power and the classroom strategies she employed in acknowledging power.

Caroline, I am also interested in hearing about the specific changes you made to your teaching style and the selection of models and mentors you made in your classroom. Also who did you allow access to in the computer lab at lunch and recess? Did you permit those students who showed initiative and productive working habits, or did you allow access to those who did not have computers at home? What were your strategies because as a pre-service teacher, I am not all that confident I would recognise the power imbalance you are talking about.

In responding Caroline talked about her position as a technology teacher and the strategies she employs to disperse and develop expertise.

During class time I intentionally pulled together small groups of girls and taught them one new skill, then asked a question like, "I wonder how you could use this in your report?" and walked away. Similarly I selected groups of students (boys and girls both) and made them experts in the use of specialised hardware like the digital camera, projection unit and the scanner. When other children needed to use one of these extras for their work, the class experts were the designated mentors.

In outlining her theories of practice, Caroline acted as a mediator for some of the research ideas presented by Bryson and de Castell. On the basis of this discussion, one student predicted how these ideas would link to her upcoming practicum experience.

I am going to be teaching computers in my practicum next week, so I will be conscious of the power struggles that may be going on, and how I can help facilitate a more equitable environment.

When we interviewed students involved in this discussion, they noted the value of the PKP site, and the factors that enabled them to make connections between the electronic resources/discussion and the school experience. With respect to PKP they made the following observations: "It just kind of backed things up and I think it helped me formulate my argument too. Like I was not exactly sure how I would feel on some things and then when I did the research I found things that I could connect with and then that added to my argument".<sup>1</sup>

With respect to factors that enabled connections students noted two key points: the topic and Caroline's contribution. Regarding gender they noted "it is in every classroom—you can see it everyday". Regarding the external participant they said, "Caroline talked about Bryson and de Castell's work . . . and then that kind of linked to what we found on some of the websites". Further, "Our person was Caroline and she knew so much about the topic we chose. So it was incredible, she had such practical information and feedback that was immediate". These connections highlight ways in which a useful teaching and learning dynamic developed in this medium. Student teachers had an opportunity to talk to a practitioner about some research. In this case, the teacher linked key concepts from the research to her classroom practice. This assisted student teachers to connect the ideas raised in the discussion to their own experiences, develop a point of view on an important educational issue, and construct a set of classroom strategies that respond to their concerns.

## 2. VLE #2: EdX—INSERVICE TEACHER EDUCATION

The second VLE prototype developed by the PKP, known as EdX or the Educators' Exchange, was a knowledge management system tailored specifically for a professional diploma program for inservice, experienced teachers. The 2-year, 30-credit university administered program was designed for teachers to learn how to enhance teaching through the integration of educational information technologies. The program is conducted in schools and credits are gained by teachers conducting self-study, action research projects investigating their own learning and teaching with new technologies. The program combines two face-to-face summer institutes with self-study during the rest of the year. The teachers' learning and progress are monitored and supported by a mentor, a teacher-leader in technology, jointly hired by the district and the university instructor. Every teacher is a member of a mentor's group that is composed of seven to eight teachers. In this particular study group, the program cohort numbered 100 teachers and 14 mentors in a suburban school district of a large metropolitan city.

Unlike most university teacher professional diploma or certificate programs, this program is structured around teachers' designing their own challenges and field studies that they implement and conduct in their classrooms. Each assignment revolves around a technological tool or application and its educational value to the teacher and the students in its classroom or curriculum use. Each assignment can be an odyssey into making a tool or application technically function in the classroom or school lab but the university instructor also consciously emphasized that the educational value must be considered. The program culminates in a demonstration festival in the third summer institute where teachers display their competencies learned through

the various projects or they can expound upon one particular meaningful and valuable project in detail.

The teachers in this specialization program needed to decide what they would take and learn of the technology in order to compliment, emphasize, or challenge what they were practicing or questioning in the classroom. The means in which they were to determine their projects, the technical steps and the reflections on the educational purpose of the technologies, were in consultation with a teacher-leader or their mentor of technology. The means for the mentor to respond supportively and resourcefully to their teacher-mentees was (ideally) to consult the field, to consult the literature and resources that would speak to, inform and guide the individual teacher questioning technology and its meaningful integration in schools. The resource base for this program and mentor support was a VLE called the Educators' Exchange (or EdX).

EdX, the knowledge management tool modified specifically for the technology diploma program and its challenges of distributed delivery, was tailored to give the teachers and the mentors as much intellectual or knowledge support as possible. EdX provided many tools for sharing knowledge and resources, for posting user profiles to build recognition and a sense of community, for participating in online discussions, and for searching and locating useful resources recommended and uploaded by other users in the system. It was the most sophisticated and expensive knowledge management system that the PKP had yet produced.

### 3. USING EdX

The participation by the mentors and the teacher-mentees on EdX was completely voluntary with no reward of credits or program recognition as a technological application for project work. Every discussion that occurred in EdX or resources that were contributed by the users were intended for lifelong learning and the users' own intellectual curiosity. The institutional setting did not support the users spending time on EdX in the manner that corporate settings might recognize and reward employees for contributing to or participating in designated knowledge management systems. This incentive issue became one of the greatest obstacles for EdX as well as one of its greatest virtues. EdX was an instrument for intellectual pursuits as part of one's lifelong learning or democratic participation in education.

Perhaps needless to say, without explicit incentives or rewards, very few mentors in the diploma program made the effort to encourage their mentees to participate in discussions, or, made the effort themselves to contribute resources to the shared digital library inside EdX. The mentors did not use the tool as a means to overcome the distributed nature and the distance between

themselves and their mentees. Many mentors complained over the course of the 2 years that they rarely saw or communicated with the teacher-mentees except at demonstration time when assessing credits. However, there was one mentor who contributed resources, initiated EdX discussions and, through her modeling and enthusiasm, convinced a core group of her mentees to participate in several EdX discussions. This mentor, Deborah, invited Lisa (author 1) to work-in-progress sessions of her teacher group at different points in the diploma program, as well as to final demonstrations of her mentees' competencies earned through their projects, and to participate in some of the online discussions.

Deborah was different and distinct from the other 13 mentors in the program due to a variety of factors. Deborah was one of only three female mentors. She did not identify as closely with the technology as the other mentors; she was committed to teaching primary grades; she believed in the increased expression of children's ideas, creativity, and imagination through artistic and multimedia representations; and she was the only mentor who had sought and completed a Masters degree at a large education graduate school. Deborah was certainly intellectually engaged in her teaching.

There were two other mentors out of the group of 14 who did contribute resources to the shared content repository of EdX, but who did not attempt to create any online discussions with their mentee groups. Deborah and her group became the case study of this VLE as they were participatory in their very use of the tool. We do not wish to emphasize this case study as an individual anomaly, a rare heroic act of individualism that leaves our question of the purpose of education portals or VLEs at an individual level of analysis. The case of Deborah's group (being the only one out of a cohort of the 14 mentor groups to actively participate in EdX) demonstrates how the institutional apparatus of the course, the credits, the incentives, and the rewards, can make a significant difference in the implementation and use of the tool. The importance of these institutional motivators (such as marks) is dramatic when we compare the rate of participation of EdX with our first case study of Ed. Studies Online.

The organizational support of the EdX implementation was one that the majority of mentors recognized and quickly ascertained as unsustainable. They understood that new IT applications would quickly disappear if not bought, endorsed, and supported at the school district level. They recognized the rippling effects that a tool of this sophistication would cause and the requirement of hours to themselves, and, in support of their mentees, to learn to navigate it effortlessly and effectively. They intuitively understood that their individual costs of time and effort would not be matched by any organizational commitment by the district. They knew there would be no rewards. And they became reluctant indeed! And their reluctance matched the reluctance of the university instructor to institutionally locate and support the tool through diploma credits. And this reluctance was matched by the school district

administration who were reluctant to endorse or even mention a prototype that was not their product of choice or purchase.

Despite these conditions of reluctance surrounding her, Deborah still saw significant intellectual value in the use of EdX for her teacher-mentees' learning, expansion of ideas, and support for the articulation of their questions and project formulation. The EdX-VLE matched Deborah's definition of what intellectual support she needed as a mentor and the need for a knowledge network in her work as a teacher-educator.

The three discussions that Deborah initiated on EdX and moderated were all similar in form. Deborah would initiate the discussion and set it up in the EdX system. She would select the topic and open the conversation with a statement or questions. She would also reference electronic documents to support and footnote the conversation.

In one discussion, echoing an objective and competency of the diploma program, Deborah wanted the teacher-mentees to engage in ongoing reflection on the educational purpose of technology. She wanted to counterbalance the tendency and tone in this and many educational technology programs of a concentrated focus on technical skills. In this first discussion, Deborah lists 11 prompter questions that she believes will be useful as a template for the teacher-mentees to engage in a depth of reflection on the learning rather than skill acquisition.

**Discussion: *Creating an overall reflection of your learning this first Term.***

**Deborah, October 19, 2000**

**SUMMARY:** Here are some questions to ask yourself when you are beginning to plan how to submit a synthesis of your learning this first term.

**REFERENCES (documents for background reading)**

**Convergence of Evolving Technologies and the Shaping of Continuing Professional Development: A Case of Institutional Change**

Technology/Pedagogy/Politics: Critical Visions of New Technologies in Education (Mount Royal College),  
December 16, 1999

*Lisa Korteweg*

**Teachers Connect Online: Professional Development Through Collaborative Networks**

n/a, December 21, 1999

*Lisa Korteweg*

Deborah: Questions to think about.

What competencies have you addressed?



What proof do you have of these competencies?  
 Summarize what you have learned, i.e., How has the learning gone beyond technology?  
 How did I learn? The processes.  
 Why is this learning important to me? This is an educational purpose.  
 What am I planning to focus on next?  
 Am I ready to begin a draft of my new Learning Plan?  
 Is there an educational purpose to my next learning Plan?  
 How would you evaluate the quality of your learning?  
 What criteria have you set to assess your quality of learning?  
 What did you learn as a technology user?  
 Lots to think of. Now is the time to begin drawing your first term's work to a close. Don't Panic, though!!!  
 We will talk about all this next Thursday from 4--6. We could go later and go out for dinner or have pizza in.  
 I'm looking forward to learning so much myself from all your Journeys. I know we could all benefit from group presentations.

REPLY: Jay

The first part of this journey has gone so quickly. As I ponder the questions posed, my mind is full of ideas and comments. I think it would be helpful as a group, if we discussed some of these questions at our next meeting. (That is probably your plan.) It is helpful to know that our thoughts are shared or supported within our group. I'm looking forward to sharing these ideas and learn more from our group. Jay

REPLY: Deborah

I have always found ending a project is more like a gateway to a new one! I hope that everyone has enjoyed their first term journey. The Horizon's conference is great! Meeting, talking and sharing with people is always such a wonderful learning experience. See you Thursday!  
 Deborah

Deborah helped the teacher-mentees realize that reflection is an ongoing process and that it can be optimized in a social collaborative setting. Deborah and her teacher-mentees believed in the give-and-take of ideas in their collaborative face-to-face settings. This teacher-mentee states the appreciation of this process and locates her own examination on how she best reflects.

TOPIC: Reflection

Bettee

As always after conferencing with you Deborah, I leave filled with many more possibilities. I'm realizing that reflection time is just as important as engaging in the "task". Tonight I've been sitting with my thoughts and thinking of ways to deliver my group presentation). I forget that the creative process does take time and like art, it usually comes together when I am relaxed and 'playing' with my ideas and having fun. As far as discussion topics? I would still love to look at your kidpix (cdrom) presentation given the server did not cooperate that day. I just love a presentation to get the juices flowin for others. Group discussion from viewing your work would be beneficial...

In another discussion, other documents were referred to that existed in the EdX content repository. Users had the ability to insert the hyperlink into the discussion messages. Readers could then click on the link for a view of the document while they were participating in the discussion board. There was no technical need to exit the system or open a new browser window.

Since you are a group interested in multimedia, I thought you might enjoy looking at this article in EdX Multimedia and Multiple Intelligences Just click on the underlined title (a hyperlink) and it will take you to the article. when you are finished reading it, just close the EdX document window and you will be back in this discussion.

Good luck to everyone. Lisa

REPLY: Deborah, August 22, 2001 08:22 PM

Lisa, Howard Gardner's work on the Multiple Intelligence is important research to consider when designing and implementing new content. Learners learn differently. Options are important. Much like in this diploma program!

REPLY: Jay, August 23, 2001 02:46 PM

Lisa, Thank you for the time and energy you spent with our group (Deborah's) in order for us to reach the level of understanding that we have reached. What a fantastic program. There is so much that it offers! What a treat to be in this program and have the opportunity to access its information. Thanks again! Jay

Deborah also used the EdX discussion boards as a means to give a mini-course or just-in-time learning sessions for her teacher-mentees. In this case, the topic was sharing ideas for upcoming field studies, the longer term, in-depth studies of the educational purpose of technology and the social issues arising from the application of tools in classrooms. Deborah began by inviting the mentees to read and visit Ricki Goldman's MERLin site for technical tips and skills for capturing images of students and classrooms immersed in the use of educational technology as well as what a digital ethnographer can do with these images. Deborah was trying to introduce her inservice mentees to the idea of ethnographic research as a means of conducting and framing a field study.

**The purpose of sharing collaboratively**

**SUMMARY**

This is a conference where we can discuss our upcoming field studies. We can share and extend ideas. Check out the MERLin site for ideas of how to use digital pics and movies in studies of classrooms.

For details, [click here](#)

**REFERENCES**

▪ **MERLin**

Articles & Reports -- ubc, November 26, 2001  
Submitted by Deborah

▪ **Ethnographic Methods in Educational Research**

Articles & Reports--, November 26, 2001  
Submitted by Deborah

▪ **Data Analysis in Ethnography**

Articles & Reports -- University of Pennsylvania,  
November 26, 2001  
Submitted by Deborah

**Projects @Educators' Exchange**

**The purpose of sharing collaboratively**

TOPIC: 2nd year

Deborah, November 27, 2001 08:03 PM

Here are the university instructor's words about field studies for second year. Please refer to the program resources to check how to write up your field study proposal. Lisa said she would look for some sites that may have some ethnographic examples. Download your form. Remember that it must answer an educational question.

We are all on the right track, but we need to refine the wording of field study proposals.

REPLY: Guiding Questions

Lisa Korteweg, December 06, 2001 02:03 PM

Guiding questions to help develop an interest into a field study may be helpful at this time. Remember, the distinction of a field study is that it must have an educational focus and purpose. Deborah and I thought a field study could be a type of ethnographic research. The basic point of ethnography is to study and gain insight into the educational worldview of a group of people or students through thick descriptions. Common formats for guiding questions might be:

- How do a particular group of students perceive of or understand a certain social or cultural phenomenon? (This is often seen through behavior of some kind.)
  - Example: How do active primary students in inner-city "Stanton" (fictional name) conceive of and negotiate the idea of a computer professional?
  - How is a certain social or cultural practice socially constructed among members of a certain group?
  - Example: How do students in a computer club control access to computers for students at lunch hour? And what happens when a new protocol is introduced such as 50% of the computers must be occupied by girls?
- I would be happy to help any of you try and answer these questions inside your own particular interests.

REPLY: Guiding Questions

Deborah, December 06, 2001 08:10 PM

Lisa, Thank-you for modelling some questions for an ethnographic field study. I know they will be helpful.

REPLY: Guiding Questions

Janice, December 06, 2001 11:40 PM

Thanks for the sample questions Lisa. I think this will help me in the wording of my field study question.

#### 4. CONNECTING WITH A RESEARCHER AND RESEARCH METHODOLOGY

While these discussions with Deborah's groups were interesting and informative, they did not attain the seminar quality of the Ed. Studies Online case. While Deborah's mentees did some reading, they did not refer directly to

articles or resources in their postings. They also did not discuss the readings in any detail, rather, they used the discussion forums to reinforce ideas of supportive and collaborative community.

When Lisa attended the diploma program's final demonstrations festival, she was surprised by the quality and depth of thought given to the educational significance of the technologies in use by the majority of teachers in Deborah's group (as compared to the other mentor group demonstrations). Each demonstration of Deborah's group focused on a situation of children expressing greater cognitive depth than the teacher had encountered in non-technological curriculum situations. Each demonstration concerned projects that integrated art forms with multimedia (KidPix slides by Grade 2 students for a critical thinking exercise to music compositions on the web by Grade 7 students). The group had coalesced around the theme of how to capture young children's thinking and experiences through multimedia images and then, as a teacher-researcher, how to capture images of young children engaged in that exploration/thinking/learning.

One presentation by a teacher-mentee, Janice, from Deborah's group presented us with the realization that online resources and discussions can plant connections between teachers and research texts that are used and implemented in classroom practice. Janice's presentation was a detailed in-depth account of how she attempted to teach her students following the video ethnography framework developed by Ricki Goldman (1998) in her book (and website), *Points of Viewing*.

In interviews with Janice and Deborah subsequent to Janice's final presentation, we discussed how Janice became interested in the ways in which Ricki Goldman's work could be used in her classroom. Janice's classroom is 80% ESL with many new immigrant children in a suburban school. As Janice states: "I'm living with this (*diverse, conflicting cultural representations and images presented by children*) all day long in my teaching." Janice was perplexed and driven by a desire to know "what do these children understand of their lives—some very traditional cultural lives—and at the same time being located in a suburban Canadian school where many different types of cultures and cultural values mix and interact." Through considerable deliberation, Janice worked out with Deborah that what she really wanted to achieve in her field study was to look through her students' eyes, to see the world in their way and from their points of view(ing). Deborah believed Ricki Goldman's work would make an important connection with Janice and could best inform Janice's thinking about these issues for her field study proposal. Deborah brought Goldman's book to the second Summer Institute for Janice to borrow and she referred Janice to Goldman's website, cataloged and accessible through EdX and referenced in one of the online discussions.

Janice's first self-directed assignment after the second summer institute was to present images that children took during a field trip. In Janice's words,

the purpose of this field study was “honouring and assessing what children capture as images.” Janice wanted to involve her students in meaning-making by imitating the pedagogical promise of Goldman’s Constellations model, without access to these sophisticated tools. Janice wanted her students to achieve the following:

- create images;
- speak about their images;
- speak to their own and others’ images in textual form;
- give opinions about the other images and how this collective bank of images/representations makes them review the topic or question.

What made the work of Ricki Goldman-Segall (1998) more meaningful for Janice was that she experienced a type of “Theatre de preuve” (a term from the French sociologist/philosopher, Bruno Latour (1987), that refers to a demonstration of proof). Janice experienced Goldman’s theories as workable and cognitively successful in a classroom like her own. When Janice attempted to film her students, cloistered away in a quiet hallway, to achieve better sound quality for an i-movie presentation. But the context for the filming resulted in her students not elaborating their ideas, not divulging much detail but rather becoming silent, timid, out of context. However, back in the middle of the classroom activity, the students freely articulated their ideas and comments using the digital tools. For Janice, it was a replica of the situation that Goldman had observed and described in her research with her own students. The intense activity atmosphere created a situation for greater expression by the students as their presentations were recorded. Janice was impressed that Goldman’s findings had been replicated in her suburban, multicultural school, and she became convinced of the framework’s validity.

What also impressed Janice was the personal–professional connection Deborah had made with Ricki Goldman. Deborah had invited Ricki to her classroom and to accompany her and her students on field trip excursions to sensitive ecological areas. Ricki Goldman did indeed come and it was apparent to Deborah that they shared a similar vision of primary education, multimedia, and artistic representations in the curriculum, and the use of digital tools.

Janice also stated that she appreciated how clear and articulate Deborah was in her interest and focus as a mentor, right from the first day of the first Summer Institute. In an interview, Janice described how the mentor group and Deborah worked well together because they formed a community of practice and interest around the pedagogical purpose of capturing children’s representations (whether visual drawing, music composition, or video clips). Deborah’s group seemed different from the others because of this expressed interest and intentional purpose in a topic that extended beyond the technical realm. Deborah was also very committed to a vision of teaching that used

representations, electronic and artistic, as a means of permitting children's ways of seeing the world. She was a strong advocate of this kind of pedagogical exploration and teaching.

When a community of practice (Wenger, 1998), such as the Deborah mentor group, is centered on a pursuit of practice clearly defined, knowledge/information is received more readily. Members are open to engaging with research on the topic and they attempt to practice it in their classrooms through situated learning (Lave & Wenger, 1991). They take great support from their fellow mentees as they teach in isolation from one another in different schools with different staff cultures. Even though each member's project, topic, grade level, or medium could have been quite different and the subsequent adhering technical problems complicated, the members knew each other's projects intimately and were willing to support each other in the quest to make it a successful experience. Knowledge traveled and knowledge stuck in this community of practice. Members helped each other with analog/digital conversion problems and they encouraged each other to pursue the goal of letting children create their own digital representations of their work, regardless of any technical obstacles. Deborah and Janice brought the ideas of Ricki Goldman to discuss with the group and each member felt reassured that they were going somewhere educationally significant and valuable with their course work with children, rather than simply in their acquisition of technological skills.

##### 5. SIMILARITIES BETWEEN THE CASES: FINDINGS FROM THE COMPARISON OF TWO VLEs

The two cases described above, Ed. Studies Online with Caroline and EdX with Deborah's mentee group, stood out from all the other discussions in each VLE. While each VLE addressed a different community of teachers, pre-service and in-service, they had similarities of purpose and intent. Each VLE was attempting to provide intellectual support to an exploration of issues concerning technology and education. Moreover, both VLEs shared many of the same documents and resources in their resource databases. Each VLE also supported a program of study. In the first case, Ed. Studies Online, it was a social foundations course for the 12-month teacher preparation program. In the second case study, EdX, a 2-year program of action research projects for teachers to increase their technology skills in the classroom and to gain a specialized certificate.

In the first case study, the pre-service participants seemed intent on understanding what could constitute important professional routines in the classroom or the lab. They were curious about the code of practice that teaching could entail. The pre-service teachers were asking Caroline to elaborate on the routines that she was implementing in the school computer lab in order to shuffle and rearrange the gender practices. They wanted to examine

alternative routines to what they had experienced as students or had observed as pre-service teachers. In the PKP-VanSun VLE, pre-service teachers were attempting to understand how their previous 5 years of university study would translate into routines of practice in a living classroom. How would their identity and roles emerge in this new situation of practice and professionalization? How would they be prepared to take on their roles and socialization given the knowledge they were being offered in their teacher education program?

In the professional diploma example, in-service teachers were attempting to understand how new technologies could be integrated into their own classroom and curriculum. How would their identity and role as teacher adjust or shift in the face of integrating these new tools into their established practices? These teachers were in-service teachers, already routinized and socialized into the professional practice of teaching. But they were entering a risky stage of learning where they knew they would be exposed to problems or new “puzzles of practice” (Munby & Russell, 1990) as they engaged with technological tools in the classroom. Depending on the mentor, these in-service teachers were offered a program designed to engage them in a process of reflection, on what technology would imply for their teaching practices and their self-directed study of themselves as practitioners teaching with technology.

The in-service teachers in Deborah’s group were merging two critical concerns or grievances related to their ongoing practice. They wanted to give the arts a greater prominence in the expression of the curriculum through their teaching and by their students and they wanted to understand how technology could help them achieve this kind of work. These were not puzzles but rather grievances as these teachers felt often misunderstood, unrecognized, and unsupported in their schools for their efforts to nurture artistic expression by their students as a legitimate way of stating their ideas. Feeling isolated in their schools for the kind of artistic integration in the curriculum that they wanted to achieve, Janice did not want to take on any more “controversial” study such as gender and technology. She felt judged enough by her colleagues in her school. She was searching for a question and a focus of study that was meaningful to her goals of culturally sensitive approaches to teaching that would not give her a controversial identity amongst the staff in her new school.

The Deborah mentees were also marginalized (and, consequently, stronger in their convictions about their technological work) as some mentors and teacher-leaders in this school district believed computers and educational technology did not belong in primary grades. Thus, these in-service teachers had two simultaneous struggles that they were engaged in pursuing through their diploma work: technology in the primary grades (for greater conceptual expression by their students) and the recognition of the arts as an important medium of expression.



All these factors contributed to the emergence of these two discussion groups as important, revelatory cases to investigate and consider in the use of teacher professional VLEs. What we determined was that there was something different about the level of connection and knowledge probing in the cases of these two teacher-educators and their discussion participants. What we wanted to understand was how these levels of intellectual engagement could be the regular intended consequences of using knowledge VLEs rather than the exception, rather than the case study. The prevalent theme in both networks became the discussion moderator as the critical intermediary between the teachers' questions and needs and the research literature available through the VLE database of resources.

We began to recognize Deborah and Caroline as intermediaries in each VLE. We follow the definition of intermediaries as described in the literature of the sociology of science. "An intermediary is an actor (of any type [i.e. human or non-human]) that stands at a place in the network between two other actors and serves to translate between the actors in such a way that their interaction can be more effectively coordinated, controlled, or otherwise articulated" (Kaghan & Bowker, 2001: p. 258). Because networks are never completely stabilized, translation is continual. This is the work of intermediaries. The actor-network theorist, Michel Callon states that "an intermediary is anything passing between actors which defines the relationship between them" (1991, p. 134). Deborah and Caroline were in a constant state of translating the resources of the knowledge network and the requirements of the program curriculum to their students. These intermediaries defined not only their own relationships with the students/mentees but they were also in a process of defining the relationships between the electronic documents and the classroom practice.

In the cases of Deborah and Caroline, we realized that they acted on the network in an unforeseen and unintended manner but that the network or machine system also acted on them and their forms of teacher education. This is the excitement and revolving door of promise of work with early VLE and knowledge technologies. We do not yet understand what form the conventions and genres of technological tool use will ultimately take but we are hopeful that they will leverage a democratic difference. We outline here below how the human-machine interaction of Deborah/Caroline with the two VLE tools created "leverages" that added value to the various technical and social functions of the VLEs.

1. Deborah and Caroline used the tools in ways that the other mentor/moderators did not. The network, the technical entity, acted on them and allowed them to perform functions that they would not have been able to do outside the boundaries of this network.
  - Created and contributed to archive-able, hyperlinked discussions.
  - Cited electronic documents.

- Invited secondary guests or knowledgeable contributors to inform the discussion.
2. Deborah and Caroline engaged in intermediary functions as information brokers and knowledge translators. They added value to the system, to the machine that was not automated in the design's configurations. They were able to connect needs of the end-users with resources of the system in a manner that the technical system could not perform on its own. Deborah and Caroline added trust and witness to the VLE, in ways that could not be automated. Yet this labor represents a powerful form of "invisible" labor or articulation work (Star & Strauss, 1999) for teacher education and the intellectual engagement of educators.
  3. Deborah and Caroline became teacher-educators in ways permitted by the PKP tools that they had not engaged in before.
    - They performed intellectual connections that were material and accessible on the screen.
    - They became public in their support of teachers, in their own teaching, and in the articulation of their reflections.
    - They connected the inside/outside of the classroom (and their teaching).
    - They posed, explored, and articulated half-formed questions/observations with their discussion participants.
    - They solicited peer review or community feedback in the process.
    - They referred to and reflected on their own observations and practices.

The VLE permitted and leveraged a type of teacher-educator interaction or way of engagement that the other moderator/mentors had not realized or imagined as they did not have their own experiences of direct researcher contact.

This study yields several important themes, exemplified by the experience of Caroline and Deborah as they negotiated their moves from classroom practitioner to translator or connector in an electronic teacher education setting. Taken together, these central themes are organized to highlight key problematics of public intellectual engagement that beginning VLE moderators or participants may experience as they attempt to connect between the texts (knowledge), the participants (people), and the technology (new tools). These themes or problematics of intellectual connection and engagement in VLEs are also instructive for designers of future VLEs who will need to consider these findings to define an intellectual space for teachers and researchers in education.

- Research becomes accessible and meaningful when a skilled intermediary helps the practitioner make connections to the research and readings.
- Skilled intermediaries in these VLEs were teacher-educators, not classroom teachers or researchers outside of classrooms.

- These intermediaries had interacted/engaged with academics in conversations about common interests (common interests, problems, campaigns) outside of course requirements or university instruction. These academic-researchers, Bryson, de Castell, and Goldman, had engaged in conversation with these teachers in their sites of practice while the researchers had been involved in field work.
- Face-to-face interactions with researchers made these research texts meaningful to the intermediaries. As teacher-educators (in VLEs), the intermediaries had a technical means of connecting texts to users (uploading the work, direct link to the full-text document—a commodity view of knowledge as comprised of discrete units). Through the VLE (and virtual library), the intermediaries could connect the teachers with the unit of knowledge, the article, and state “here it is, now read it”. It is step one in the access to knowledge. But if the interaction would stop here, it would be a zero-sum transaction. Instead, these skilled intermediaries understood how to encourage emotional investment, practical connections—intellectual engagement—with these texts.
- By presenting, explaining, and describing how the texts worked for them personally inside their practices as a teacher, the intermediaries gave “I” witness to the authority/validity of the document and its concepts. It was their vouch, their witness for this research informing their own learning, and practices that made the VLE participants want to read the documents/books, engage in discussion, and use the ideas in their practice.
- The intermediaries made visible and explicit the importance of these texts to their own understandings of themselves as teachers and the work of teaching. They gave testimonials, they gave explicit witnessing of the value of these texts or frameworks to their curriculum design, student observations and the reconsideration/reorganization of their practical work as teachers.

The present situation we have observed in our two attempts at creating knowledge networks between teachers and researchers has shown that we have new technology with old social relationships. In our two case studies, we observed a lot of labor by the two intermediaries (Ehrlich & Cash, 1999) that had to occur to establish the value of the research knowledge. Trust had to be established by the intermediaries telling stories of being there (Geertz, 1973): being in conversation with researchers, being in the classroom, being a teacher, being a technology integration specialist, being through the same observations and experiences as the teacher-participants. This authenticity convinced the in-service/pre-service teachers to trust the accounts of Deborah and Caroline and to trust their interpretations. Deborah and Caroline became the reverse of the anthropological idea of “native informants”, as they proved to be guides for the natives’ appreciation of the research community. They are between

and betwixt two communities: the research/university community of teacher educator and the practice world of teacher in classroom. Their accounts are valid and authoritative because they are still practitioners with classroom descriptions and observations.

#### CONCLUSION

Our experiments with these two VLEs were attempts to augment and enrich the university–school (academic-teacher) relationship by expanding direct access to each community’s knowledge, and, in the process, observe whether a new community of practice would develop or indicate signs of developing. We follow Nancy Van House’s idea that communities of practice arise spontaneously whenever people have common concerns and have a way to share knowledge (Van House, 2003). (We are substituting here the term VLE for Van House’s use of Digital Library.)

... it (*the VLE*) cautions us to be sensitive to the variety of communities’ existing practices of knowledge creation and work and indicators of credibility. A successful (*VLE*) has to fit with these practices. In particular, the (*VLE*) has to articulate with participants’ hierarchies of credibility and processes of establishing trustability for people to be willing to use and contribute to the (*VLE*). And these vary across communities of practice.

The world and the work that the (*VLE*) serves are continually changing; so too must the (*VLE*). Its design needs to be deliberately fluid and dynamic, to accommodate emergent work practices, and on-going enrollment and co-constitution.

(p. 272)

Many teachers are unfamiliar with these attempts at an intellectual life through VLEs. They are unaccustomed to stating and articulating half-formed questions and ideas aloud and publicly in front of their peers. Many university researchers are unfamiliar with publicly engaging in conversations with teachers from a distance and in a semi-public manner. They do not know how to make connections between content, tools, and services in a VLE in order to create an engaging electronic seminar. They are also unaccustomed with other definitions and conventions (other than a university seminar) of intellectual participation with teacher practitioners. In their work, they are generally accustomed to the conventions and genres of intellectual work that they observe in their own workplace institutions, the university.

For the most part, academic knowledge is disembodied. Caroline and Deborah represent the most local embodied form of knowledge. They can

translate the disembodied knowledge and give it authority from their own local examples. The focus in this paper became the teacher-intermediary as we observed the incredible labor and the intense service needed to move these ideas from documents, move knowledge from articles in the system's database to discussion in electronic forums, and finally (in the most successful instance) to classroom use and application. To build a set of social conventions to accompany a technological tool, like an education portal, or a teacher VLE, takes a lot of social labor. What we have attempted to do in this chapter is recover the non-constitutive events of the technology. Technological competence (in this instance, the effective and democratic use of a VLE) is a social competence. A democratic VLE is the product of the effective distribution of knowledge. But, what we have discovered from the cases of Deborah and Caroline is that technology does not cause the knowledge to move: it is the non-technological events and social circumstances that cause the technological and democratic success. In this ethnographic study, we attempted to recover the non-technological that would redress the asymmetry of the technical and the social that is occurring in many educational technology experiments.

In this chapter, we have examined the question of what the intellectual participation of teachers and teacher-educators in discussion through web tools could look like and how it could democratically effect the processes and reforms of teacher education. At this stage, no one can really determine what shape these VLE tools will ultimately take inside universities and schools. In our analysis of these two case studies of VLE participation, we attempted to be attuned to the processes of intellectual engagement by the pivotal intellectual intermediaries inside these environments. Further empirical research is needed to challenge, build upon, and modify the findings of this research. For the purposes of this study though, the analysis of Caroline's and Deborah's experiences as research intermediaries or translators in the field yields the rough start to a theoretical map that could guide further research and programmatic efforts in teacher education through VLEs. We believe it will take the sustained and participatory effort of teachers *and* researchers attempting to speak to each other as public intellectuals in VLEs that will help determine and constitute new cultural or institutional relationships between practitioners and researchers and new definitions of the intellectual life of teachers, teacher educators, and researchers.

#### ACKNOWLEDGMENT

The authors wish to thank John Willinsky for making important comments and suggestions to the paper. We would also like to thank all the teachers who gave of their time to participate in this study.

## ENDNOTE

1. It does need to be noted that the comments have been made by students in this one forum, students in other forums had differing points of view on the value of the exercise and the resources.

## REFERENCES

- Agre, P. (2001). Supporting the intellectual life of a democratic society. *Ethics and Information Technology* 3(4), 289–298.
- Barrell, B. (Ed.) (2001). *Technology, Teaching, and Learning: Issues in the Integration of Technology*. Calgary: Detselig Enterprises Ltd.
- Bryson, M. & de Castell, S. (1998). Learning to Make a Difference: New Technologies, Gender, and In/Equity. *SSHRC Final Report, September, 1998*. Accessed at: <http://www.educ.sfu.ca/gentech/sshrcreport2.html>.
- Burbules, N. C. & Casslister, T. A. (2000). *Watch IT: The Risks and Promises of Information Technologies for Education*. Boulder, CO: Westview Press.
- Callon, M. (1991). Techno-economic networks and irreversibility. In: Law, J. (Ed.) *A Sociology of Monsters: Essays on Power, Technology and Domination*. London and New York: Routledge, 132–161.
- Cochran-Smith, M. & Lytle, S. (1993). *Inside/Outside: Teacher Research and Knowledge*. New York: Teachers College Press.
- Cuban, L. (2001). *Oversold and Underused: Computers in the Classroom*. Cambridge: Harvard University Press.
- Dahlberg, L. (2001). Extending the public sphere through cyber-space: the case of Minnesota e-democracy. *First Monday*, 6(3). Accessible at: [http://firstmonday.org/issues/issue6\\_3/dahlberg.index.html](http://firstmonday.org/issues/issue6_3/dahlberg.index.html).
- Eco, U. (1995). A Conversation on Information: An interview with Umberto Eco, by Patrick Coppock, February, 1995. Accessed at: [http://carbon.cudenver.edu/~mryder/itc\\_data/eco/eco.html](http://carbon.cudenver.edu/~mryder/itc_data/eco/eco.html).
- Ehrlich, K. & Cash, D. (1999). The invisible world of intermediaries: a cautionary tale. *Computer Supported Cooperative Work* 8, 147–167.
- Geertz, C. (1973). *The Interpretation of Cultures*. New York: Basic Books.
- Giroux, H. (1988). *Teachers as Intellectuals: Toward a Critical Pedagogy of Learning*. Granby, MA: Bergin & Garvey.
- Giroux, H. & Shannon, P. (Eds.) (1997). *Education and Cultural Studies: Toward a Performative Practice*. New York: Routledge.
- Goldman-Segall, R. (1998). *Points of Viewing Children's Thinking: A Digital Ethnographer's Journey*. New Jersey: Lawrence Erlbaum Associates. Accessed at: [www.pointsofviewing.com](http://www.pointsofviewing.com).
- Gore, J. M. (2001). Beyond our differences: a reassembling of what matters in teacher education. *Journal of Teacher Education* 52(2), 124–135.
- Geurtz, M. R. (1990). Generations: reconceptualist curriculum theory and teacher education. *Journal of Teacher Education* 40(1), 13–17.
- Gutmann, A. & Thompson, D. (1996). *Democracy and Disagreement*. Cambridge, MA: Harvard University Press.
- Herman, L. & Mandell, A. (2000). The given and the made: authenticity and nature in virtual education. *First Monday*, 5(10). Accessible at: [http://firstmonday.org/issues/issue5\\_10/herman/index.html](http://firstmonday.org/issues/issue5_10/herman/index.html).

- Kaghan, W. N. & Bowker, G. C. (2001). Out of machine age: complexity, sociotechnical system and actor network theory. *The Journal of Engineering and Technology Management* 18(3&4), 253–269.
- Latour, B. (1987). *Science in Action*. Cambridge, MA: Harvard University Press.
- Lave, J. & Wenger, E. (1991). *Situated Learning: Legitimate Peripheral Participation*. Cambridge: Cambridge University Press.
- Munby, H. & Russell, T. (1990). Metaphor in the study of teachers' professional knowledge. *Theory into Practice* 29(2), 116–121.
- Noveck, B. S. (2005). A democracy of groups. *First Monday*, 10(11). Accessible at: <http://firstmonday.org/issues/issue10.11/noveck/index.html>.
- Pea, R. (1998). The Pros and Cons of Technology in the Classroom. A Debate with Larry Cuban on Reform and Technology. Accessed at: <http://www.tappedin.org/info/teachers/debate.html>.
- Pea, R. (1999). New media communications forums for improving education research and practice. In: Condliffe Lageman, E. and Shulman, L. S. (Eds.) *Issues in Education Research*. San Francisco: Jossey-Bass Publishers, 336–370.
- Star, S. L. & Strauss, A. (1999). Layers of silence, arenas of voice: the ecology of visible and invisible work. *Computer Supported Cooperative Work* 8, 104–126.
- Tom, A. (1997). *Redesigning Teacher Education*. New York: State University of New York Press.
- Van House, N. (2003). Digital libraries and collaborative knowledge construction. In: Bishop, A. P., Van House, N. A., & Buttenfield, B. P. (Eds.) *Digital Library Use: Social Practice in Design and Evaluation*. Cambridge, MA: MIT Press, 271–295.
- Wenger, E. (1998). *Communities of Practice: Learning, Meaning, and Identity*. NY: Cambridge University Press.
- Willinsky, J. (1999). *Technologies of Knowing*. Boston: Beacon Press.
- Willinsky, J. (2000). *If Only We Knew: Increasing the Public Value of Social Science Research*. New York: Routledge.
- Willinsky, J. (2002). Education and democracy: the missing link may be ours. *Harvard Educational Review* 72(3), 367–392.
- Wilson, S. (1999). Impact of the Internet on primary care staff in Glasgow. *Journal of Medical Internet Research* 1(2), e7. Accessed at: <http://www.jmir.org/1999/2/e7/>.

## Chapter 24: Virtual Learning Environments in Higher Education “Down Under”

BRIAN PAULING

*New Zealand Broadcasting School, Christchurch Polytechnic Institute of Technology,  
New Zealand*

### 1. INTRODUCTION

The use of VLEs, while not as extensive as in Europe and the U.S.A., is increasing in this part of the world. There is a rapid uptake of communications technologies in the tertiary sector of education but it is uneven and not without criticism (Brabazon, 2003). Watching developments elsewhere from this perspective on the edge of the world's stage it is difficult not to conclude that technological developments in education are driven by a complex set of forces that include not only the enabling factor of the convergence of the technologies but also the economics of globalization and the politics of techno-capitalism. There is a case to be made that the arrival of the virtual classroom whilst creating a paradigm shift in the ways teaching and learning are delivered also presents a range of opportunities and threats for both the teacher and the learner and offers significant and particular challenges for small local tertiary institutions in small countries.

New Zealand is a small country at the bottom of the world. Colonized by the British in the 19th century it remained for over 100 years a colony in reality if not in name. Until the 1970s when the U.K. became involved with the European Common Market, New Zealand was the “market garden” for the “Mother Country”. Great Britain each year took over 80% of its exports, which were almost exclusively primary products (Sutch, 1966).

Now no country takes more than 18% of its exports (Statistics NZ, 2004). New Zealand was the first Western country to completely deregulate its markets. It is possible for overseas interests to own land, businesses, and banks. There are no restrictions placed on external commercial dealings. The Government has a “hands off” approach to economic activity limiting itself to intervention in the fiscal arena to minimize taxes and control inflation by interest rates and money supply (Kelsey, 1997a).

Despite this the cultural heritage is strong. New Zealand has been, and to a greater extent still is, Eurocentric even although it has spent the last 20 years fending for itself in a competitively uneven world marketplace. Its tertiary education structures, like that of Australia our nearest neighbour, are based on the Anglo-Saxon model and the culture of England is pervasive.



However, the New Zealand culture has been strongly influenced from another direction in this period. There has been a renaissance, both cultural and nationalistic within the indigenous New Zealand race, the Maori. A belated recognition of responsibilities under the partnership Treaty of Waitangi<sup>1</sup> has led to the establishment of a bi-cultural nation with increased sharing of the political and economic processes with Maori.

Geographically New Zealand is as far removed from its historical centre of influence as it is possible to be, sited alone at the bottom of the South Pacific Ocean. The two major Islands each have over 4000 km of coastline. It is long and narrow, the widest point in the North Island being less than 300 km. Mountains, forests, rivers, lakes, glaciers, hot springs, deserts, fjords, volcanoes all make it an attractive destination for tourists.

The population is just 4 million with Maori making up 13%, Pacific Islands' communities another 8%, people of Asian origin 8% the remaining population is of European origin. Over 1 million live in the major city of Auckland at the top of the more heavily populated North Island. Around 800,000 people live in the South Island. The HE system consists of eight universities, twenty-four polytechnics, six teachers training colleges, and a large number of private providers operating under a national educational standards authority the New Zealand Qualifications Authority (NZQA).

## 2. THE ORIGINS OF THE NEW ZEALAND UNIVERSITY

According to the Oxford English Dictionary the meaning of the word "university" has been generally understood for nearly a 1000 years as being "the gathering of teachers and students in pursuit of higher learning".

The heritage of New Zealand's universities can be traced back to early 19th-century German and English philosophers. It began in the rational ideas of Kant and was applied, in the United Kingdom using the ideas of Cardinal Newman and Matthew Arnold and in Germany those of Humboldt and Schiller. Reflecting the influences of the leading personalities, in the U.K. the concentration was on literature in Germany it was philosophy. Both changed from the religious influences of the previous medieval universities based on the constraints of theology and tradition. The enlightenment broke the boundaries of these constraints with appeals to reason, inquiry, and scientific methods of discovery and experiment. The arrival of industrialization and the resulting modernism also impacted on the ideas of the 19th century. However, unlike their medieval counterparts the modern university stood aside from direct activities within the culture, maintaining a critical distance thus preserving the high culture from the excesses of the drive to industrial modernity.

The university system had remained stable for well over 100 years. There was little challenge to the accepted role of the university from without. Within, the internal structures, the behaviors of staff, faculty, administration, and

students were constant. The key change within universities during this period was the continuous trend towards subject specialization as society demanded greater expertise to meet the challenges of industrialism (Smith & Webster, 1997). Whilst universities continued to expand, both in size and diversity of disciplines and multiply in terms of the number of universities in total, the process was steady, controlled and, in organizational terms, predictable. The core business of the Anglo-Saxon university was to maintain a culture that provided for the nurturing of a meritocratic elite intellectual minority that would provide the stable leadership nations required for survival.

And so it was in New Zealand. The early settlers from the U.K. established four university colleges in the main centres of colonization. They became constituent colleges of the University of New Zealand. The term (trimester) patterns were the reverse of the northern hemisphere with summer occurring over December and January. However ties to the U.K. were so strong that even although exams were sat in October, graduation was held in May of the following year to allow time for papers for final year undergraduates to be sent to the U.K. for marking and/or moderation and returned.

Since the early 1960s the role of the modern university in New Zealand and Western societies has been changing and there has been increasing uncertainty as to the function of the modern university. During the 1980s the pace of change increased. At the millennium it was no longer clear what role the university played in society and this uncertainty was being increasingly reflected in the literature (Readings, 1996, Scott, 1997, Melody, 1997, Filmer, 1997, Kumar, 1997).

The expanded and interventionist roles of governments within society immediately following World War II, typified by the welfare state in the U.K., post-war reconstruction in Europe and immigration in the old colonies (New Zealand and Australia), saw increased funding for HE. It also led to an increase in student numbers as social policies pushed for increased access to education on the grounds of equity and arguments, both economic and political, for a well-educated society. The “new” universities were the products of this period. In the United Kingdom the number of universities doubled in the period to the end of the 1960s. In New Zealand the constituent colleges of the single entity of the University of New Zealand were reformed as four independent universities and two new universities were created.

The first signs of the stress created by these changes occurred with the student riots in France in 1968.

The election, first in the U.K. of Margaret Thatcher and then in the U.S. of Ronald Regan pioneered a radical shift to severe right wing politics driven by the strong ideological belief that the social democratic policies of the post-war period were deeply flawed. The emphasis on social cohesion, collective responsibility, and state involvement in a wide range of social, economic, and cultural activities was dramatically weakened by political beliefs that emphasized less government, individual responsibility, consumer sovereignty

and the dominant role of business and the market as the sole economic determiners.

Furthermore, rising government debt and declining incomes for most of the population in developed countries encouraged a close review of the performance of virtually all agencies of the welfare state. Universities did not escape this scrutiny. Similar shifts in political thinking and consequent changes of governments followed in Canada, Australia and, in 1984, New Zealand.

Universities sustained heavy criticism, especially from the newly dominant business sector. Previously universities had been criticized, from time to time, by other dominant institutions, historically first the church and then the state. Now it was the turn of business. They challenged the “relevance” of many university courses to the needs of the marketplace of commerce and industry. Many courses that were developed in the 1960s and 1970s as part of the expansion of university departments and growth in student numbers were considered irrelevant and often seen as threatening to the new conservatism e.g., feminism, Marxism, colonial studies, race, and cultural studies. The individual academic was criticized as being “soft” because they had a job for life (tenure) and did not have to perform to survive as most workers in the marketplace did. They saw academics as gaining large salaries (courtesy of the taxpayer), long holidays and, most critically, no accountability for their work and for their productivity. Universities were considered to be “out of touch” with the needs of the nation, slow to respond to the learning needs of the community and irrelevant to the needs of students requiring skills to make a living in the post-industrial, information technology-centred late 20th-century workplace.

Under a deregulated economy institutions of HE in New Zealand developed corporate behaviors which included heavy advertising and branding, establishing trading entities, putting in place principles and practices more in common with business operations than traditional academic activities and, most significantly, they began competing with each other for students, funding, and recognition. Such activities were previously unknown in the traditional Anglo-Saxon university.

While such behaviors have been generally maintained there have been moves in the last 5 years, particularly in New Zealand, to mitigate the excesses of commercial behavior and competition and return to a “light” regulatory environment that puts some emphasis on universities performing in the interests of national goals and strategies.<sup>2</sup>

### 3. HE'S NON-ENGAGEMENT WITH ANALOGUE TECHNOLOGY

One of the criticisms of education in general and HE in particular was that it had failed to change with the times and this was no better illustrated than in the university's use, or to be precise, non-use of technology. Someone once

said that if a person from the 19th century were to return today the only thing they would recognize would be the classroom. For over 500 years text formed the basis of every learning experience in the West.

The 100 year history of non-print based mass communications technology (radio, film, television, telecommunications, and computers) appears, until recently, to have had little impact, in New Zealand or anywhere in the world for that matter, on the ways in which teaching and learning have been delivered in formal education systems. To use an analogy, education's engagement with mass communications covers a gamut of experiences that epitomize an "on-again-off-again" relationship—attraction, excitement, fear, and loathing. But on the whole it has been an unconsummated relationship (Rushkoff, 1994).

Whilst all the aforementioned forms of mass communications have increased their influence over virtually every other aspect of human activity, there is considerable evidence to suggest that their impact on the tasks of teaching and learning in formal education have been limited. Teachers and teaching institutions either resisted these new forms or, as Australian writer Carmen Luke puts it, they were "passed over" as the non-print based communications revolution gathered pace (Luke, 1996).

Radio, cinema and film, telecommunications, television, computers, video-text, and multimedia, are all technologies located, on the whole, "outside" of mainstream pedagogy and curriculum. The notions of "technoculture" and "cyberspace" recognizable in the discourses of cultural studies, sociology, and anthropology, have not been identified in discourses on formal education (Luke, 1996).

In Luke's construction the "single-order" development of print technology over 400 years ago created an educational environment dominated by the printed text and universities stuck with the single order well past the time when just about every other aspect of society had been saturated with "second-order" media.

#### 4. THE INITIAL IMPACT OF DIGITAL

The concepts of "single order" and "dual order" in this context are used to describe the methods of distribution of stored information. In Western society, following the invention of movable type, print technology gradually replaced aural and hand-written traditions and, eventually, became the principal method used for information storage and dissemination in literate societies. Except for illustration and the development in the 19th century of photography, it was text based.

The "second-order" distributions that became possible just over 100 years ago with the invention of electronic media such as radio and television and mechanical moving pictures created a "dual-order" media and information environment, The electronic and mechanical analogue based, non-text media

on the one hand, the existing print based traditions on the other. The second-order media developed rapidly reaching the “maturity” of social saturation in very quick time (Bittner, 1985).

With the development of digital transmission the method of dissemination returns to a single order, bits and bytes being used for everything—text, sound, moving image, graphics, and illustration.

However whilst society, outside of the world of teaching and learning, increasingly operated in a dual-order mode, teachers, on the whole, eschewed the dual order and maintained the exclusivity of teacher-mediated single-order printed text. Only rarely were radio, film and television used in the teacher-mediated classroom for the storage and/or dissemination of information. This remained so despite attempts to integrate the second-order media with teaching and learning. Such attempts occasionally led to excessive claims.

Radio was going to “liberate” learning for the masses and reduce the “tyranny of distance” with educational broadcasts. Radio “. . . is a modern and . . . most efficient tool which could be used for the furtherance of the very plans (education, welfare, development) which now have priority over it” claimed a UNESCO report in 1972 (Waniewicz, 1972: 58). Further: “the role that radio can play in fundamental education is thus a matter of vital importance to the present day world” (Williams, 1950: 7).

Film and television were going to revolutionize instruction by adding pictures to voice and replace text as the dominant means of distance learning. “Educational Television is the most powerful tool of all and it won’t be so long before it is universally available. We should be planning and experimenting in anticipation of that day”. (Potts, 1979: 16). Maclean (1968) believed that television was the “most effective” channel for “straight teaching” (p. 8). Again, educationalists and broadcasters talked about “the great educational potentialities of classical open circuit broadcasting” to deliver learning to all (Robinson, 1964: 9). Schramm (1960: vi) wrote that “educational television has shown a remarkable capacity to reach, to interest, to teach, to enlighten”.

In New Zealand it was stated in the 1972 report of the Commission of Inquiry into the uses of Television in Education (Williams, 1972: 72) that “television has a valuable contribution to make to education in New Zealand”. The Commission recommended the immediate establishment of a national television channel devoted solely to education, formal and informal. It didn’t happen.

Computers were going to make teachers redundant with computer-aided learning (Stonier & Conlin, 1985). The initial development of the computer after the Second World War coincided with the strong influences of behavioral psychology on teaching and learning (Watson, 1925) and the application of “scientific” principles to the study of management. B. F Skinner applied behaviorist principles to learning and developed the concept of programmed learning

(Skinner, 1954). He pushed for the development of a “teaching machine” that would “free” the teacher. “We are on the threshold of an exciting and revolutionary period in which the scientific study of man will be put to work in man’s best interest” (p. 97).

By the mid-1960s the research and writing on the role of computers and teaching machines reached such a level that Schramm (1964) concluded that “no method of instruction has ever come into use surrounded by so much research activity”. Research peaked in 1967 (Spencer, 1988). The arrival of the personal computer saw a revival of interest in computer based learning but writers (e.g., Kulik et al., 1983) investigating computer-based learning commented that there was not “a great advantage for the computer in this role” (Spencer, 1988: 38). The expectations of over 30 years of experiments and evaluations suggest that the hopes and visions of the protagonists were not fulfilled.

To continue with the preceding analogy therefore, whilst education has “flirted” with each medium as it developed, there was never a commitment to any substantial long-term relationship.

However, since the late 80s there has been more engagement with non-print media by a myriad of educational agencies than was evident in the preceding 90 years (Watts, 1999). With the development of digital transmission and the consequent convergence of the three previously independent technologies of broadcasting, computers and telecommunications the dual-order environment has been replaced by a new single order which has broken the exclusivity of text on paper bringing together all modes, text and non-text, in a single data stream. Within this stream new hybrid textualities have been created and a new generation of young people are engaging with new forms of literacy and alternative discourses. The challenge is succinctly summed up by Luke:

Multimodality (forms of expression), multiliteracies (modes of reading/writing/representation) and multivocality (multiple author-voices and social identities)” are increasingly challenging the relevance of the traditional discourses of teaching and learning. The classroom is being forced to acknowledge the montage of difference, (the) pastiche of multiple author-voices, (the) endless criss-cross of quotation to other cultural texts, media forms and symbolic languages.

(Luke, 1996: 190)

Some theorists even argue that society is about to see the “death” of the book as we know it (Birkerts, 1996).

Furthermore, interactivity, the strength of text-based teacher mediated learning, previously denied the analogue electronic media in the old dual order, has been achieved, at least partially by the arrival of single-order delivery.

For the first time technology has demonstrated the capability of replicating the three key elements of the classroom which are:

- Student–teacher interaction
- Student–student interaction
- A repository of knowledge that can be accessed

The key to this change is the move from analogue to digital. Digitalization has removed the barriers and returned media to a single stream of zeros and ones.

#### 5. HE'S ENGAGEMENT WITH DIGITAL

A cynic could argue the case that universities eschewed second-order technologies because any perceived use for them was solely in the teaching role, the least valued role within the university. When computers were first developed their value in research became immediately apparent. The ability to sort and analyze large volumes of data had particular appeal to the quantitative research model that dominated academic research at the time. Universities were quick to install mainframe computers. As size and costs reduced the computer was embraced by academe as an essential research tool, first by the scientists and mathematicians and then, as more sophisticated software packages were developed, by the wider university community.

In 1987, Abraham Peled (1987: 57) wrote: “The way computing has permeated the fabric of purposeful intellectual and economic activity has no parallel”. This was just 4 years after the invention of the personal computer. Since then the convergence of the technologies and the creation of the internet have seen an unparalleled transformation of the worlds of business, science, entertainment, the military, government, law, banking, travel, medicine, agriculture, and education.

So, in contrast to the previous dual-order technologies universities have been to the forefront in proclaiming the information revolution and have pioneered the use of computers in a range of areas from administration, data storage and distribution, library technologies, electronic mail and as alternative tools for teaching and research. Many universities have seen the adoption of technology as a way to spread the role of teaching beyond the confines of the traditional campus and have invested heavily in the technology to provide computer enhanced or computer-based distance learning. The large number of courses available on the web is testimony to this. However, the development of the “virtual university” where time, distance, and space become irrelevant as the student interactively accesses the best university minds irrespective of location while a distinct possibility is not yet a reality.

## 6. ENGAGEMENT “DOWN UNDER”

It has been no different in this part of the world. One commentator has noted that:

The proliferation of VLEs running on desktop, networked computers, has allowed a number of institutions to offer subjects online to some extent. But, on the whole there is not a well articulated, homogenous, online learning strategy rather, “the majority . . . are patchy initiatives using piecemeal methods to deliver uncoordinated services via the web”.  
(McKey, 2003)

This criticism has some currency. Currently there is little coordination so that different institutions and even different faculties within the same institution are using different software systems based on a range of *ad hoc* decisions which include cost and using what staff skills are available. Often it’s a question of taking existing course material and “digitising” them making no changes to meet the unique opportunities offered by the new medium. Often the support and administration services offered these programmes are based on the 9am–6pm mindset of the campus institution and do not accommodate the 24/7 needs of the online student.

And while students in Australia and New Zealand are taught using an increasing variety of teaching methods, print is still by far the most common mode. For distance students it usually includes a subject outline, study guide, readings or laboratory manuals and student purchased textbooks. In some subjects, audiocassette tapes or videotapes are used as supplements to text. Increasingly faculty are using the e-mail to communicate with students and provide one-on-one feedback.

However, within these critical constraints the development of e-learning and VLEs in this part of the world can be broadly categorized into three areas:

- Traditional campus-based institutions adopting various modes of VLEs;
- Traditional distance learning institutions adding technology to their already well developed distributed learning; and
- New ventures specifically designed to take advantage, especially in the global marketplace, of VLEs.

Traditional campus-based institutions are building facilities to enhance traditional classroom-based learning using the web. It is estimated that over 60% of all courses in New Zealand now offer some web-based component (Tyler-Smith, Personal Communication, 2004). Many institutions use proprietary enterprise software such as Blackboard, First Class and WebCT to enhance both classroom learning and the distance learning offerings many are experimenting with. Most have their library information on line and provide access



to electronic databases through their web portals. Some provide for online enrolment and post results online. The majority of students at universities and full time polytechnic courses have e-mail addresses. Courses use a range of applications from simple e-mail communication to fully online programmes that provide all resources electronically and require all communication electronically. The very small number in the latter category use purpose built websites, electronic newsgroups, online interactive discussion, blogs, electronic submission of work and in some rare cases web delivered audio and video. However, many of these developments are fragmentary and lack cohesion. Some programmes have been offered only to be withdrawn and some have been criticized for unacceptable standards.

Changing student needs are seen as one of the major drivers of the traditional campus-based institutional move towards VLEs. The student profile is aging. As regular career change becomes more common the need for flexible learning increases. Because of the increased costs of education and the perceived heavy burden of student loans more students are trying to work while studying.<sup>3</sup> Also many people already in jobs see the need for regular, if not continuous up-skilling. All of this challenges the traditional campus-based institution to engage with the technologies that offer the promise of widely distributable flexible learning.

In the Anglo-Saxon world the strongest development of VLEs is occurring within institutions that are already distance education providers and they are combining VLEs with traditional distance learning methods to expand their programmes both nationally and internationally. Not surprisingly an organization like the U.K. Open University which, unlike most other universities was a very early adopter of both radio and television as media to supplement print and post, found it easier to adapt to the web. Their radio and television experiences meant that they were already skilled in screen and graphic design and understood the role of sound singularly and as a complement to vision. Videotapes and audiotapes, even slides and photographs were already widely used. They could more easily adapt to the VLE technologies than most. Furthermore, being totally committed to distance learning they had no classroom commitments to confuse the situation thus they were not adding a new dimension to their teaching methodologies. They used new technologies as a supplement to already existing delivery platforms not as a replacement. Students were eased into using e-mail and the web.

New Zealand's equivalent The Open Polytechnic of New Zealand (TOPNZ) also has been a distance education supplier for many years. The institution has 30,000 enrolled students studying in New Zealand and 40 overseas countries. Like the U.K. OU, it is an exclusive distance institution with no campus activity. TOPANZ has taken a cautious approach to engaging with digital technology. They have surveyed students and have found that an overwhelming number of them still prefer paper-based delivery. Surveys suggest that only a minority (19%) would prefer their course delivered fully online. So TOPANZ

is applying VLEs at two levels. The first is to slowly introduce e-learning as an add-on to their traditional paper-based courses. The second is to develop a suite of new courses for discrete online delivery. These are mostly in business and applied sciences. At the end of 2003, 60 courses were using VLEs for most activity. It is the stated intention of TOPNZ to expand online courses so as to eventually be able to offer most programmes in dual form (TOPNZ, 2002).

Some newer institutions are emerging as major users of VLEs as they compete against older and more traditional players in the HE marketplace. The University of Southern Queensland (USQ) is a dynamic, young university created from an institute of technology in 1990 that offers programmes at undergraduate and postgraduate level in three modes, on-campus, off-campus, and online. USQ has a number of campuses in southern Queensland offering face-to-face learning, the off-campus mode is traditional paper-based delivery enhanced with some video, audio, and digital media content and the online service is delivered exclusively via the internet requiring students to have facilities that can handle e-mail, access websites, download text, audio and video files and enable interactive engagement with faculty and other students. Many students choose different modes of delivery for different periods of their study. The University promotes flexible delivery and markets itself as a regional, national and international university (USQ, 2004).

At a third level a number of regional institutions are participating in global developments of VLEs. A strong regional influence in this regard is NextEd, a Hong Kong-based company that works with a range of public and private education institutions throughout Asia, the Pacific, the U.K., and the U.S.A. It offers in partnership a proprietary system, which uses a digital education delivery platform designed to “allow students in multiple locations throughout Asia, to access post-secondary education and training, often from course providers located in another city or country”. NextEd is the private technology partner in the Global University Alliance, a consortium of ten universities which aims to provide university-level education to people from anywhere in the world—taught entirely online. The Universities, all public (state) institutions, are from New Zealand, Australia, Europe and North America.

The purpose of the Alliance is to provide “students from around the world with accessible, rewarding educational experiences by leveraging the latest interactive web technologies”. GUA claims that it “provides students and teachers with access to course material and support services 24 hours a day, seven days a week”. A number of Australian and New Zealand institutions are partners of NextEd including TOPNZ, the Auckland University of Technology, the Royal Melbourne Institute of Technology, and the University of South Australia. All of these institutions operate extension programmes in Asia and the Pacific (NextEd, 2004).

The University of Auckland, three large Australian universities, and four universities in the U.K. are members of the international consortium called

Universitas 21. Universitas 21 is an international network of universities with the purpose of facilitating “collaboration and cooperation between the member universities and to create entrepreneurial opportunities for them on a scale that none of them would be able to achieve operating independently or through traditional bilateral alliances”. In a major alliance with global media giant Thomson Corporation it has created an online university called Universitas Global. Its first venture was to launch an MBA programme in 2003. In a unique move the degree certificate awarded by Universitas 21 Global will bear the crests of all the Universitas 21 partners (Universitas 21, 2004).

A VLE created in Australia in a specific response to the fact that other commercial LMSs were U.S.-centric is Moodle. It’s an open source software package for producing internet-based courses and web sites and is an ongoing development project designed to promote a particular “social constructionist” educational framework.

One of the greatest attractions of Moodle is that under its public license arrangements, although copyright protected, it is available for use for free if you agree to its conditions. “Moodle” stands for Modular Object-Oriented Dynamic Learning Environment and, according to it’s website, it’s also a verb that “describes the process of lazily meandering through something, doing things as it occurs to you to do them, an enjoyable tinkering that often leads to insight and creativity”. Apparently anyone who uses Moodle is considered a “Moodler” and there are a considerable number of them. Seventy-nine sites are listed as using Moodle in Australia and a further eleven in New Zealand. Internationally over 1100 sites are listed as Moodle providers. While they do not seem to have a large presence in the university market (only a few Australian universities and one New Zealand Polytechnic are listed) it appears to be very popular in schools and private learning establishments (Moodle, 2004).

As mentioned previously, there has been a return to a more regulated education sector in New Zealand and this has seen the creation of a number of central government initiatives to assist in the growth of e-learning and coordinate the development of technology and the expansion of programmes. The current government sees the need for New Zealand to adopt a cohesive, national approach to developing e-learning. It fears that global developments are impacting on the provision of tertiary education services, and that new uses of ICT to create e-learning opportunities and VLEs are creating fundamental changes in the ways learning is conceived and practised.

Accordingly, these changes are seen as having both risks and opportunities for New Zealand, in terms of its competitiveness in an increasingly globalized education market and its ability to provide relevant, high quality educational opportunities for its citizens. The government believes that the development of e-learning capability will assist in the achievement of national educational goals. While it acknowledges the many promising developments that occurred in individual institutions under deregulation it holds that there are benefits to be gained from improved co-ordination between tertiary education organizations.

Since 2002 New Zealand's Ministry of Education has been developing IT-related strategies for the tertiary education sector. These include a "tertiary information strategy" (Tertiary Information Strategy, 2003), an "interim tertiary e-learning framework" (Interim Tertiary e-learning Framework, 2004) and the creation of web portals for the tertiary sector and for tertiary e-learning (elearn, 2004; Ted, 2004). According to government statements the tertiary information strategy is based on a number of principles common to the expression of educational policies that are inclusive and favour education as a public good. They include the belief that "everyone can learn and everyone must learn". It requires "secure, seamless access to education" and seeks to remove any barriers that inhibit learning through VLEs. The government's published material states, *inter alia*, that its goals are to have all communications and dealings with external parties that relate to business transactions (including educational business) occurring electronically, that all authoritative sources of information will be accessible electronically from which legal copying can be generated on demand, that work (including much teaching) will become location-independent, that there will be access to all personalized educational information via a tertiary portal and that there will be an open interoperability of rules and standards across the sector. It is clear from documentation that the Ministry of Education sees itself as responsible for driving the strategy forward and wants to develop a coordinated approach across the sector to overcome the ad hoc developments some of which are listed above.

To this end a Tertiary Education Commission (TEC) has been established to implement this Tertiary Education Strategy. The creation of the TEC is a big step way from the previously diverse market driven education sector and returns the sector to a significant level of bureaucratic control. The TEC is responsible for allocating over \$2 billion annually to tertiary education organizations and it uses this money to assist the sector to build capability and capacity to contribute to national economic and social goals. All forms of post-school education and training come under the TEC's umbrella. These range from full-time academic study, on-job and work-related training right through to tertiary research and development, foundation education, distance education and part-time study (TEC, 2004).

However, it should be noted that these policies are not those of the national opposition parties. They favour the previous less regulated regime and espouse principles that promote education as more of a private good and view teaching institutions as a form of trading entity.

## 7. IMMEDIATE ISSUES FACING HE IN NEW ZEALAND

Despite the initiatives of the current government the conditions that will foster the development of VLEs in countries like New Zealand are heavily affected by a number of issues that can hinder or help institutions to embrace technology

and grow VLEs, and they are significant. Indeed it is hard not to observe that currently HE is challenged in every sense—epistemologically, sociologically, economically, politically, and technologically, so much so that the future of the traditional university is not assured.

The engagement with online learning that has been so noticeable over the last decade is driven by a number of forces and although it would not be possible without the technology, technology itself has never been the sole condition for any change. Technologies can languish for a number of reasons. An example could be the lack of a market. Broadcast technologies have been faced with this problem over the establishment of digital television and radio. If there is no demand, no “business model”, then the technology remains sidelined. Or a technology can be developed that people just don’t see as useful. The fax machine prototype was developed in the 1930s but it was not until the mid-1980s that they became prominent. For over 40 years it was a technology in search of a use. Also technologies have been developed that have swept into cultural maturity in very short time but the classroom has eschewed them. Analogue radio and television and cinema are examples.

Raymond Williams discussed this in relation to television when he suggested that the rise of television as a medium was not exclusively technologically driven. Strong elements of cultural history and political economy also informed the medium’s development.

It is commonly believed that inventions such as the printing press, radio and television set the stage for a more democratic society. Quite the opposite actually occurred in all instances—not because of the technology itself, but because of the interests of those who made decisions about how the technology was used.

(Williams, 1974)

So, it is argued that it is not just the technology that has driven the development of e-learning. There are other factors that have propelled the momentum towards VLEs and those factors have a lot to do with the interests of those who make the decisions about how the technology will be used in e-learning. Those decision makers are, in turn, influenced by the social, cultural, economic, and political pressures currently in the ascendancy.

## 8. THE VISION

Administrators and governors of HE have seen in the technology the chance for the first time to fully replicate the classroom. Previous technologies have fallen far short of meeting the three essential elements of classroom processes. But computer-based interactive communication comes close. Those three elements—teacher/student interaction, student/student interaction and an accessible source of stored information and knowledge have enabled the

teacher controlled classroom to dominate educational practice for centuries. The Aristotelian model of a small number of students engaging (in the truest sense of the word) with a mature, knowledgeable teacher in seclusion and for long periods of time has been the time-honoured system of the elite Anglo/Saxon universities. The poor relation at the lower end of the same system is the 500-seat lecture theatre and the 2-hour lecture.

Interactive digital technologies of the VLE provide institutions with the ability to further increase the effectiveness and efficiency (in economic and time terms at least) of this model. The vision is of much larger numbers of students engaging with their tutors via the internet thus increasing the number of students able to be accessed by one tutor and without the costs of building and maintaining more lecture theatres. More EFTS (equivalent full time students) leads to more fees and greater revenue all supposedly at less cost. Students would be off-campus thereby reducing the stress on such services as libraries, facilities, and computer suites.

Governments have also perceived value in using the technology, the contrary goals of modern states wanting to reduce the costs of education whilst at the same time wanting to achieve a better informed, educated and trained workforce could perhaps be reconciled by using technology. The increasing competition between nation states to create economically viable “product” for a marketable return in the so-called “knowledge economy” propels governments to support the development of VLEs.

Something that appeals to both governments and administrators is the increased “flexibility” of organizations delivering learning on the new platforms. More tutors would be needed for shorter periods and for easily defined tasks. The university workforce could become increasingly casualized permitting a more business oriented method of managing staff with easier hiring and firing and greater control over a more passive workforce thereby reducing the “difficulties” that tenure can bring including the “stropky” academic and the barriers of working with people that have long term institutional memories (Brabazon, 2003).

There is no doubt that a technological solution to the rapidly increasing costs of HE has strong appeal to bureaucrats and politicians regardless of educational efficacy and any demonstrated need for teachers and learners to have personal contact and real-time interaction. So this vision argues a “business case” could be made to adapt the technology and spend the money on developing VLEs because the return would be worthwhile.

However, “success has yet to come” (Williams, 2003). While convergence of the technologies can enable the vision, other events are impacting at the same time and they may be as significant as the technology. The reality is that students are not engaging with on-line learning in the numbers expected, institutions are finding the costs of creating and delivering online learning greater than expected and other forces economic, political and social are putting pressures on educational institutions at unexpected levels.

Barriers to the successful implementation of VLEs include economic issues, issues of the political economy that HE is engaged with, the nature of teaching and learning and the very essence of the university itself as it struggles to maintain relevance in an increasingly “hostile” world.

## 9. ECONOMIC ISSUES

Traditional universities had comparatively few economic worries. Budgets, often generous, were set by the state and the perceived role of the university as the provider of the culture that nurtured the meritocratic elite that would continue the supply of stable leadership required for the nation’s survival almost guaranteed security. Over the last 40 years changes both to the role of the university and the costs to the state of maintaining them have led to a raft of economic “worries” for HE administrators.

The first is the cost of IT infrastructure. The major costs of installing, maintaining, and keeping up with the rapid changes in information technology have been a strain on institutions and an inhibiting factor in growth of VLEs. Certainly HE expenditure on information technology has increased dramatically over the last 30 years but it still remains low in the overall comparison with commercial institutions. Institutions in New Zealand have struggled to remain viable facing the extra costs of IT infrastructure and this has been reported as a world-wide phenomenon. While salaries continue to be the largest expenditure item in university financial reports IT cost have steadily risen from below 1% in the late 1970s to an average of 4.6% in 2002. (University of Canterbury, 1979, 2003) Comparisons with commercial organizations show education institutions are lagging. Some international surveys suggest that telecommunications, banks and other heavy technology users spend almost three times what education does. On an even more significant ratio, that of IT spend per employee, education fares even worse. Education overall spends less than \$1000 per employee. This compares unfavourably with, for example, media companies that spend over \$5000 per employee and top spending telecommunications and banking organizations that spend in excess of \$10,000. Whilst this maybe considered an unfair comparison given the nature of education it actually signals a significant concern (Leach, 2003). As is discussed in more detail later, HE institutions internationally are facing significant challenges from newly emerging “corporate universities” whose lineage is commercial not educational. These bodies are likely to invest heavily in technology because they appear committed to delivering the online experience. Many of them are located in large transnational corporations that have branches in small countries like New Zealand and they are investing in the technologies to provide VLEs to their staff. Most, if not all, of these corporate universities are located in organizations that spend considerably more on IT development and support than universities, especially local ones, and have

the budgets to support it. Thus an alternative to the university is created. This could impact on NZ universities because a feature of the university ecology is that many organizations, governmental, industrial, and commercial, send key staff to university either part-time or full time for intensive periods to gain relevant knowledge and skills. If these institutions take their learning in-house local universities will lose custom.

There is the possibility that the cost and maintenance of delivery technologies and their infrastructures will be too great for many small and scattered learning institutions to sustain.

Secondly the fear of failure or of economic loss has become a strong factor in HE thinking. New Zealand, like other countries has had its share of IT projects that have gone horribly wrong. Following deregulation there were a number of high profile public sector IT failures and less publicized corporate IT investment debacles that have created considerable caution and anxiety in making investment in large, costly and heavily IT focused projects. Moreover, local HE institutions cannot fail to observe that a number of high profile forays by major universities in larger countries into developing online programmes have been reported as failures. According to Brabazon Columbia University and New York University both spent large sums of money (\$25 million each) on ventures that either folded or where greatly reduced. The University of Maryland, Virtual Temple (the online offering from Temple University), and the University of California closed their first attempts at online services and the London School of Economics stopped charging for its online courses and put them up for free using them as a taster for conventionally delivered programmes. The same author claiming that “e-learning has failed through the desire to make money—and quickly” cites the spending by companies supplying online material for the education market in the U.S. dropped to U.S.\$17 million from U.S.\$483 million just 2 years earlier (Brabazon, 2003). More recently, and with considerable impact in New Zealand, it was reported that the highly promoted and state of the art e-university in the U.K. (U.K.eU) had folded. With U.K.£32 million of a budgeted £62 million spent it was said to have less than 1000 students enrolled world-wide for its courses. The e-university’s activities are to be “scaled down” and most of its activities transferred to other established universities. The U.K.s Open University lost U.S.\$9 million in an attempt to enter the U.S. HE market (MacLeod, 2004).

Criticisms of the e-university failure highlighted that the underestimations of the costs of developing and delivering e-learning were substantial:

E-learning was seen as an opportunity to cut costs by automating a recognised process (learning), cutting out the middlemen (teachers and admin staff ), reducing inventory (books) and minimising real estate (classrooms).

(Williams, 2003)



John Beaumont, chief executive of U.K. eU argued that the cost-cutting aspects of online learning were so attractive that the e-university failed to invest in the technology and content design that would have made the VLE of the university a rewarding one in which to learn.

Courses should have been entirely rethought, if not rewritten to take account of the strengths and weaknesses of the new medium. This pedagogical failure was compounded by technical problems. The process was orientated towards the supply side rather than the students, and some of the early platforms were designed around the needs of academics rather than the people who would actually be trying to learn online.

(Beaumont, cited in Williams, 2003)

It is important when reviewing how a small country should move forward to try and understand what went wrong to ensure that costly mistakes are not repeated. Critics have suggested a number of things. There was some resistance from faculty both in terms of technophobia and perceived increased workload. Lack of training and at times poor technical support meant that much of the online menu was far from appetising. Course notes and lecture notes were thrown up on the web, there was little genuine interactivity either between students and lecturers or between students, and standards of design both of the content and the screen varied. The internet promised much but delivered less especially when it came to bandwidth and was often frustratingly slow. And, most importantly, it turned out to be far more expensive to establish and maintain than the early adopters believed.

These high profile first generation online mistakes have made smaller nations more cautious. Such overseas experiences have created if not scepticism certainly a strong sense of caution within local HE institutions when faced with making heavy financial commitments to online delivery.

Thirdly is the experience and threat of competition. The Anglo-Saxon university has felt the impact of market forces on the sector as institutions compete against themselves in what was once a collegial non-competitive environment. The language of the marketplace has infiltrated HE. Students are now seen as “customers” and learning has become a “product”. Major changes to the administrative structure of universities have occurred as an outcome of the market approach to HE and this has been maintained despite some return to centralized control in some countries like New Zealand. The business model of fiscal responsibility and accountability has quite quickly replaced the public service model of funding based on need. Accountability procedures such as audits, performance, and compliance reporting give primacy to the manager or administrator rather than the academic in HE leadership roles. Universities now promote and market themselves. Advertising, an activity previously unheard of in many universities, takes increasingly large slices

of institutional budgets. Universities are competing for students and, as the technology allows, seeking custom from outside of their traditional geographic boundaries.

New technologies have also created new channels of knowledge creation and dissemination, some of which are a direct challenge to the hegemony of the university. Scott (1997) identifies new forms of “knowledge” institutions not based on the same structural ideas as the university which he sees as direct rivals to the university. The university as the local repository of knowledge no longer has a monopoly when other repositories can be accessed online from around the globe (Kumar, 1997). Moreover, as Kumar points out, there are two key roles that appear to be changing as technology intervenes. The roles of the teacher and the library seem to be most under challenge. It appears that the personal quality of teaching is losing value and is slipping in status in this age of mass education and large classes.

It is not at all clear that the instruction provided through the new media technologies, especially those involving interactivity, is markedly inferior to that provided by teachers. As for libraries, for anyone who has a personal computer the best libraries in the world will soon be available to be screen-read at home. Universities need libraries but libraries do not necessarily need universities.

(Kumar, 1997: 30)

Nor does it have dominance in the distribution of knowledge. New institutions, often lacking both the traditions and value of the university are evolving that play an increasingly important role in distributing ideas and information.

Not only is the corporate university, developed for the advanced training needs of knowledge-based companies and large R&D units in both industry and government departments, a direct challenge to university exclusivity, there are new, alternative and open sources of knowledge that also claim some authority. Learning Channels owned by media companies, commercially owned and operated web portals and the web itself are current examples of a rapidly increasing field.

Recognized brands such as BBC Television, Thomson Publishing, a host of private research bodies (e.g., Gartner) and many internet sites are claiming authenticity and authority equal to such institutions as the university and openly challenge the university’s position as the sole and “rightful” place for the discovery and dissemination of knowledge. Some argue that fragmentation is inevitable when difference is such a strong factor (Smith & Webster, 1997).

In the future HE institutions may form only a part, and maybe a small part of the knowledge-producing centre. Few, if any, universities have the resources to match the large transnational media conglomerates that are staking a claim to knowledge creation and certainly none in New Zealand.

## 10. THE NATURE OF TEACHING AND LEARNING

Teachers may be forgiven if they cling to old models of teaching that have served them well in the past. All of their formal instruction and role models were driven by traditional teaching practices. Breaking away from traditional approaches to instruction means taking risks and venturing into the unknown. But this is precisely what is needed at the present time.

(NCATE, 1999)

Then there are the pedagogical issues. Universities are facing challenges to the tradition mode of educational delivery. Some educators still argue that the classroom model in which the authority and power of the teacher is paramount produces the discipline, the control and the ruthless concentration necessary to inculcate good learning. There is also considered to be a loss in the quality of the teaching and learning experience when it moves into VLEs. Computers are at their best when handling concrete ideas, ideas and content that can be neatly bundled into a series of discrete 1s and 0s. Some educators argue that they are less competent when involved with abstract and complex qualitative or philosophical ideas. Further there are elements of the classroom that still cannot be translated to VLEs, among them the senses of smell and touch and the observance of body language. Good teachers will argue that a significant part of their success is in performance. The classroom is like a stage and the lecture most engaging when the performance has elements of embedded drama—surprise, bathos, pathos that catch the listener unawares, that shock, amuse and engage with the pace and direction of the narrative. All this is harder to do *via* a computer, although not impossible. But both the unwillingness to change and the slow speed of change are significant barriers to the development of VLEs.

The traditional pedagogies which originated in the medieval university where the knowledge was passed down through generations to uncritical reception were replaced in the enlightenment with a more critical and sceptical pedagogy. However, it still was not the student's role to challenge but rather that of the researcher/teacher. Good marks were still achieved by repeating back to the teacher what the teacher wanted to hear. It was not until the student moved out of the classroom and into the higher research-based degrees that the roles of critic, innovator, and challenger were permitted.

At lower levels of learning the role of the student to listen, absorb, understand, and then do was dominant. The industrial societies of the 19th and early 20th centuries wanted workers who were skilled in replicating knowledge and actions and not thinkers who challenged them.

Over the last 30 years the litany has changed. Students are required not only to understand and do but also to think, to challenge and debate. Creativity is the buzz word. The "knowledge economy" needs original thinkers (Florida,

2002). The new product is not material or stable in nature. The new product is intangible, unstable and forever in need of reversioning or, to use the language of the media, repurposing. The users of such product need to be original, sui generis in thought and able to compete by developing original and compelling product able to sustain a return in the post-modern marketplace of ideas.

In contrast to the classroom the development of VLEs shifts the control, and to a growing extent the power, of the student teacher relationship to the student.

A number of theories and methods are being developed to provide sound pedagogical grounds for the new learning environments. These theories include the U.K. Royal Society of Arts' "learning for capability", immersion learning, cooperative education, and contract-based learning (Stephenson & Yorke, 1998) They challenge the traditional classroom pedagogy and provide foundations for new methods of delivering learning and suggest changes to the political and social thinking around the role of HE. Faculty have been slow to investigate them and even slower to accept them and much online delivery is heavily constrained from reaching its potential because of this theoretical hiatus. But universities are being warned that:

as the nation's homes acquire greater information technology power by the day and provide [students] with the chance to explore global networks and utilise increasingly sophisticated multimedia technology, so the pressure will grow for [teaching institutions] to redesign their operations.

(Lee, 1995)

## 11. THE CHANGING "NATURE" OF THE UNIVERSITY

The relationship of HE to the economy has always been ambivalent. Scott (1998) calls it "latently dominant". But prior to the massification (see below) of HE there appears to be little evidence of the sector having much economic power. Today it would appear that the economic role of the university is the key determinant to its future. It appears that HE is playing a more significant role in the political economy than previously. Just what that role is, and how it will eventuate is less clear. Issues to do with the future of HE and its role in the broader political economy are holding back developments including the development of the "virtual" university.

Right wing theories surrounding the "private good" nature of education, the emphasis of learning as a tool for employment and career options, user pays and the shift of the capitalist business values of competition and profit into the social sector are part of the changes, as are current theories surrounding the knowledge revolution and the rise of the post-industrial information-based society.

In addition to their educational role, universities had served a range of public service functions: the creation and expansion of knowledge, research and publication; advisory and servicing function for the state and professional repositories and transmitters of historical, cultural and social knowledge; and (rather too rarely) as social critics. The neo-liberal model sought to reduce that role to the production of education and training—commodities that would be bought and sold in an artificially constructed education market and driven by forces of supply and demand. Education could then be defined as a private good, with the burden of funding increasingly shifted from the state to the student.

(Kelsey, 1997: 30)

Jane Kelsey, a New Zealand academic and critic of globalization argues that the status of both HE institutions and staff are changing. She argues that a country the size of New Zealand could end up with only one or at the most two research-based universities charging elite fees to attract elite staff and students, the remainder being relegated to a form of educational industry.

Most students and staff will end up at the bottom tier. Constant cost-cutting; courses overflowing with fee-paying students; high birth and death rates as courses and qualifications pander to market demand; frequent mergers and take-overs; and minimal research.

(Kelsey, 1998)

In this regard it is salutary to remember that New Zealand has eight universities, twenty-five polytechnics, 2300 primary schools and 330 secondary schools all for a population of 4 million people, a population not much greater than Birmingham in the U.K. which has three universities and four other tertiary institutions. Among the matters challenging HE and the status of the university are issues surrounding massification, globalization, corporatization, intellectual property rights, the urge to privatise and/or make HE institutions into businesses, the reduced influence of governments and the rise of the knowledge industry and they deserve a brief discussion.

### **11.1. Massification**

There has been a dramatic increase in the tertiary student population of the Anglo-Saxon university which until recently was elitist and cloistered. The term “massification” has been coined to describe this. It was once thought exceptional to win a place at university. The later part of the last century saw Anglo-Saxon HE institutions changing to the more accessible American model of the university. The scale of the recent expansion has been

unprecedented. According to Trow (1973) a system can be called elitist when it enrolls less than 15% of the eligible population, when enrolments exceed 40% it has the potential to become a universal system. In the U.K. as late as 1987 only 17% participated in HE. This had reached 40% by 1998. The U.K. university system moved from elitist to popular more than doubling its student population in the short space of 10 years and was transformed from a relatively small and rather elitist institution into a large, diversified, multi-disciplinary organization similar to those in the United States where access to HE had for much longer been more open.

In the 1960s less than 10% of New Zealand's school leaving population went on to tertiary studies. The majority of first time job seekers left full time education in the fifth form (Year 11). A substantial number obtained their first time job at the end of the fourth form (Year 10). In New Zealand, to gain University Entrance was considered a major achievement. For those who chose it was the key to a university place, for others, the key to entry into first time appointments in highly sought after public sector institutions. By the late 1990s the majority of school leavers went on to full-time tertiary study. Most first time jobs are now accessed from varying levels of HE.

It is claimed that one of the significant effects of massification has been the increase in economic efficiency of universities. With increased staff to student ratios, more efficient use of classrooms and facilities, the automation of systems such as libraries and record keeping there have been significant productivity gains and a sharp reduction in unit costs (costs per student). One assessment in the U.K. suggests significant productivity gains with real costs per student falling about 40% in the 21 year period to 1997 (King, 2004: 16). This confirms that mass systems of education have a different economic structure than elite systems and it is demonstrated by the downstream effects on human resources, equipment, and cultural structures within the university. For example there is a "significant intensification of the academic labour process" (Scott, 1997: 39) which is not only reflected in sharp increases in staff student ratios but also in greater staff involvement in revenue generating research, students taking more responsibility for their own learning via self-directed learning, self assessment and the automation of assessment techniques. Scott argues that one of the less tangible effects can be seen in the area of personal relationships. The increased use of electronic mail, the increased time consumed by bureaucratic compliance procedures, and the dramatically increased numbers of students, particularly in the first and second year classes all contribute to an attenuation of personal relationships.

A further reason for university expansion is that it provides, in part at least, a solution to the problem of youth unemployment in western post-industrial societies. Modern, automated and information technology rich societies require less and less human labour, particularly physical labour. Delayed entry into the labour market helps reduce the unemployment figures in the same way as early retirement does at the other end.

Another reason for university expansion is the market for mature adults and continuing professional and personal education. The university is increasingly playing host to a group of mature students, often forced to return to university because of the loss of a job, the break up of a relationship or markedly changed personal economic circumstances. Brown and Scase (1994) see such students using access to HE to provide for the “reconstitution of personal networks, cultural interests and socio-political activities” (p. 98) that provide for “identity reconstruction”. They suggest that this may be as important an outcome for HE attendance as formal learning is. It may also suggest one reason why the “virtual” university will not replace, at least entirely, the traditional campus-based institution.

Scott (1997) suggests that massification moves the whole field of HE onto a plane where its very visibility creates challenges not previously faced by smaller universities. The vision of technology enabling efficient and effective access to these vast constituencies becomes not only a social but also a political and economic goal. The roles of HE in the political and economic spheres have never before been as substantial.

### **11.2. Globalization**

Globalization practices are increasingly impacting on small countries like New Zealand. State owned and operated HE is facing increased competition from private institutions set up to make a profit from the provision of learning services. Such institutions are governed by people comfortable operating in the corporate environment; they carry no “baggage” of tradition and are not limited by charters that give prominence to public non-profit activities. Such institutions embrace the opportunities that global trade in education provides. Bodies such as The World Trade Organisation (WTO) and conventions such as the General Agreement on Trade and Services (GATS) see many elements of education, particularly HE as tradable professional services. Education may be used by national trade negotiators as leverage or “trade-offs” to gain favourable access for other parts of the exporting economy to a foreign market. Universities will find it hard if not impossible to resist the trends towards the globalization and commodification of learning perhaps to the detriment of the traditional public service roles of HE. On the one hand this may mean that larger and better-resourced universities will capture a part of the international market while on the other hand smaller, less well resourced, regional or local universities may become the victims of the international market. Why would one take a business degree from the local university when a Harvard degree with all of its associated prestige can be obtained online?

There are also trends towards setting global standards in HE. Organizations such as UNESCO are strong supporters of qualifications that have an international imprimatur and a global organization called the Global Alliance for

Transnational Education (GATE) has goals of establishing a global network of learning and an international certification regime.<sup>4</sup>

Melody (1997) sees universities being forced to grapple with the global marketplace of information expanding nationally and internationally and in doing so they will tend to compete against themselves. Already education is exported from many western economies. Melody sees a weakening of the traditional relationship of universities with the ministries of education and a strengthening of ties with ministries of trade and commerce.

The nature of the student body is also influenced by this process. There has always been some sense of student internationalism on most university campuses usually determined by state foreign policy objectives but on the whole universities were local institutions serving local cohorts of students. However, as Scott (1998: 117) points out these “students flows” are no longer based on such relationships. Now Students are no longer tied to the local university and market forces determine the nature of student flows. There have been two principal outcome of the embracing of market conditions. The first is that overseas students have now become an essential contributor to the revenue stream of many universities and colleges. Some now rely on overseas full fee paying students to balance their budget. The second is that subject choice has changed. As Scott points out under the government driven model science, engineering and public administration were the topics of choice for foreign students. Under the market model business, management and accountancy now dominate.

The global flow of students moving internationally for HE is increasing exponentially. In the U.K. the number of overseas students rose from just 70,000 in 1990 to just under 200,000 by 1996 (Bruch & Barty, 1998). In New Zealand the number of overseas students enrolled in New Zealand educational institutions in 2001 was 60,000. Their economic impact is significant. Although foreign students were just 8% of enrolled students at the University of Auckland they provided 24% of the university’s fee income (Ninness, 2002).

Where previously people had relatively little choice about where to study unless they were privileged by selection to an overseas university, opportunities to enrol across borders, to take courses adjusted for part-time and short-term study, and participate in academic discourse without leaving “home” are rapidly increasing. There are now several thousand accredited courses available on the internet (Spender, 1995). Prestigious universities offer online programmes globally. The new single-order technology generates more demand for internationalized education. And while the increasingly competitive Western economies are hungry for choice and quality in education there are also growing demands for access to education from developing countries (Tiffen & Rajashingam, 1995). The number of students entering tertiary education who are also users of multimedia and the internet is increasing rapidly. This is to be expected given the strong share that computer games have in the teens and



pre-teens consumer market (Laurillard, 1996). Parker Rossman (1992) suggests that a worldwide electronic university is emerging. He gathers together a range of research reports on experiments and demonstrations that suggest technology is being used to create a global HE industry, which is gradually developing its own set of goals, priorities, values and philosophies. Partnerships in cooperative education ventures are crossing national boundaries.

Whilst the global virtual university has not yet developed perhaps there is a precursor in the phenomenon of the Open University, an example of this being the U.K. Open University. Daniels (1997) coined the phrase “mega-university” to describe such an institution. There are nearly 50 universities identified with the title “Open”. Only one The United Kingdom Open University teaches exclusively in English. These universities share a number of characteristics. They do not have teaching campuses, rather they have an administrative centre and a whole series of geographically situated “call-in” centres. They have, by current standards, huge enrolments. The UKOU has 220,000 students. The Chinese and Turkish open universities each have over half a million students and those in India and Thailand have reached a quarter of a million. They seek students over a wide geographical range (the UKOU has 80,000 students offshore). They are becoming aggressive in their local marketplace and in the case of the UKOU the global marketplace. They have embraced technology for the purposes of educational delivery (the UKOU has over 150,000 students working online). They spend large amounts of money in “front loading” their courses, that is they invest heavily in course preparation and course presentation. Costs of producing multimedia products are not cheap but the principle is that costly high production values will pay dividends by attracting students. In turn, high enrolments spread the capital development costs and reduce the need for high margins as courses reach critical mass consumption. As an example the combined budgets of the largest 11 open universities is around \$900 million. Per capita that’s just \$390. This compared with the per capita average of U.S. universities of \$12,500 and in the U.K. \$10,000. Even allowing for internal comparison, say within the U.K., the UKOU per capita cost is just less than half the average for campus universities. Open universities are all state supported and respond to state educational policies (Daniels, 1997).

### **11.3. Corporatization**

Corporatization is also a threat. Krishan Kumar (1997) suggests it is an even further barrier to the continued viability of the traditional university. The response of many universities in their attempts to remain relevant has been to promote themselves as corporations and mimic the behaviors of commercial organizations. He sees imminent failure for this strategy for universities lack the resources and skills, organizational and human to compete with experienced

private commercial organizations. “They become absurd and increasingly despised as they compete among themselves like manufacturers of washing powders, employing increasingly grotesque marketing strategies” (1997: 27).

The impact of this behavior is being seen at many levels. First there is the lessening of the status of the academic as leader of the university. Academics are increasingly being replaced by bureaucrats and corporate business people as leaders in the university system. The skills of a modern vice-chancellor lie in managing human resources, efficiently overseeing a business plan and, increasingly important, fundraising skills. As the role of the administrator increases the academic life is seen as less attractive with lower salaries, increasing redundancies, penny-pinching budgets and the increase in contract appointments as opposed to tenure. Secondly, there is heavy investment in lobbying, public relations, advertising, and the development of “mission statements” and other documentation that demonstrates accountability and claims the ability to “quantify” the activities of the institution. Thirdly, there is increasing pressure to generate income and other resources by behaving in a “business-like” manner. They seek moneymaking consultancies, profitable conferences, the setting up of companies and other business entities and the search for research projects than produce income rather than enhance knowledge. Finally they demonstrate the typical market behavior of the firm, offering themselves up to partnerships, mergers, take-overs, and cross-border activities. They confirm by their actions that they are part of the globalized economy operating in the marketplace.

Kumar suggests that they may fail as corporate entities but if they succeed they will act more and more like firms, competing with others in the knowledge industry in terms of how quickly they create knowledge, how ingeniously they configure knowledge and how well they distribute and store knowledge. In such areas will lie, if at all, their comparative advantage. Indeed, as competition increases and the pressure to behave like a firm increases, the extraction of economic benefit from university activities will become a prime objective. This may be seen less in terms of new knowledge than in terms of the commercial realization of already existing knowledge configured in varied ways. In doing so universities are becoming enmeshed in the corporate world and behaving in such a corporate manner that they are “viewed as part of a single pattern of interactions with corporations which [will] need to be fostered and maintained over the long term” (Gibbons, M. et al., 1994: 88).

#### **11.4. Intellectual Property Rights**

Intellectual property rights and the changes in the status of knowledge have a pervasive effect on the institutions that supply information. In this regard universities must now rank with the rest—newspapers, publishers, radio,

television, film, telecommunications, computers, libraries, banks. These institutions are now grappling with the tasks of assigning “property rights” to information, separating public from private information and establishing information “markets”. This change to an “information economy” has generated an extraordinary rapid growth in the global industries within the information sector. As of 1998 the communications and information sector of the world’s economies provided nearly 20% of the world’s trade (Broadcasting and Cable Yearbook, 1998). Many states are staking their economic futures on the stimulus that the communications and information industries will provide.

The concept of the private ownership of property has been central to the capitalist economic system. Coupled with a system of law that protects ownership and provides contractual responsibilities these concepts have enabled the development of capitalist economies, given them the “strength” to compete against and overcome other models (e.g., communism) and created the current phenomenon of globalization. For centuries the focus of property rights was on land and materially created products. As more abstract and symbolic elements of society emerged so did new forms of protection such as the notion of copyright (books) and patents (ideas and concepts). As capitalist society moves from an industrial-based to a knowledge-based economy universities, the traditional source and repository of much knowledge, will become more closely involved in the trade and consumption of knowledge product. The impact will be felt in a number of ways. There will be pressure on universities to use their knowledge creation and storage for revenue generation. They will be less willing to share knowledge through the traditional channels, rather they will seek protection to maximize the economic value. Knowledge which traditionally would be released quickly to the peer community for purposes of review and critique will be held back, patented and released only in a marketable form. The value of the university “product” will cease to be a public good and become a tradable property in the marketplace of ideas and knowledge.

#### **11.5. Deregulation**

Deregulation was welcomed as a precursor to privatization by many economists, businesspeople and politicians, especially those of the Right. Over the last 20 years the New Zealand government has divested itself of many functions (telecommunications, banking, insurance, and broadcasting) by selling them to private purchasers, usually wealthy overseas corporations. If this trend continues through into education it is possible that education may be bound, by policy or budget, to accept just a few sources, the diversity of the many classrooms and teachers becoming the conformity of just one or two. The rush towards the privatization of education may see a multitude of players but if other examples are any indication it is more likely

to be a cabal of a few international giants. Education may, like broadcasting, aggregate around a group of internationally respected “names”. Educational multi media may become the battle ground of a few big corporations with vast resources to invest.<sup>5</sup> Furthermore, in the push to gain market share the organizations themselves may be driven not just by educational outcomes but by other gauges of public satisfaction such as entertainment value or user friendliness. The traditional information industries (radio, television, and newspapers) have been heavily influenced by “infotainment” and many have changed formats to accommodate audience expectations. The concept of “edutainment” may develop as the education industry vies for market share.

Large multi-million dollar corporations have been created to develop “edutainment”. Disneyworld in Orlando, Florida in 2002 launched what is being referred to as an “edutainment” pavilion. Companies like Education Technology Inc. and International Multimedia Learning Corporation have been established with the view that “entertainment, technology, telecommunications and education will continue to come together to create a new dynamic for education” (Nocera, 1996).

#### 11.6. Privatization

Bernard Woods points out that the new systems will be “driven by their potential profitability, by the new markets they create and by the new solutions they offer”. (Woods, 1993: 133). We live at present in a “dual reality” between what is possible now and what we know will be possible in the near future as the technology comes on line.

Karel Tavernier, one of the founders of the International Conference of HE, a European-based agency argues that, worldwide, university funding systems need overhauling. His research suggests that

Vastly expanding opportunities, greater internationalisation, decline in the dominant position of the traditional university, sharper competition, increasing privatisation, and higher resource intensity are just a few of the recent trends which have affected modern universities.

(Tavernier, 1993: 89)

These trends separately and in combination will force major changes on the “traditional bureaucratic ways” of university operation.

Whilst organizations like the New Zealand Business Roundtable (1994) are understandably pushing for more private involvement in education, a number of academics are also lending their voice and backing it with research. D. Bruce Johnstone argues that private institutions at tertiary level can “provide HE benefits at lower costs than state-owned and state-run institutions through

their greater managerial flexibility and their independence from state civil control” (Johnstone, 1993: 19).

While there are currently constraints in place that mitigate excessive privatization agendas in New Zealand there are constant pressures to permit greater participation in HE by the private sector.

#### **11.7. Reduced State Involvement**

One of those pressures is the growing reluctance of governments to meet the spiralling cost of HE. Social services like health and education are claiming more and more of the government’s limited financial “cake”. In health the relevant features are increased technology costs and an aging population that uses more health services, in education they are greater participation rates, the need for a higher standard of education within the general population and the life-long learning needs of the aforementioned aging population. Educational economists like George Psacharopoulos at the World Bank argue that “the demand for HE and enrolments have grown by such proportions that government can no longer foot the university bill, admit to the university all those who want to enrol, or provide education of the same quality as they did before . . . The way of the future is some form of recovery or privatisation in HE” (Psacharopoulos, 1993: 61).

In support of massive restructuring of tertiary education Michael Clarke and Alan Williams quotes from *The Economist*:

Universities must adapt to a world in which governments are reluctant to fund HE; in which students are as likely to be middle-aged managers, trying to update their skills or change their careers, as impressionable school leavers; and in which knowledge-intensive industries, happily innocent of life-time tenures and union-negotiated pay scales are busy competing to buy talent.

They also draw attention to the immense growth in revenue that tertiary education is providing in some areas:

Conservative estimates for the earnings created by management education alone run at some \$US50 billion per annum. Australian estimates of export income for services for the year 1993–4 stand at some \$A14 billion, of which \$A1.2 billion was earned from educational exports.

(Clarke, 1995: 87)

The growth of private providers in education within New Zealand has been strong. Encouraged by access to some government funding, the ability to charge high fees because of student loan availability, private providers now

exist across the education spectrum, challenging even universities. They are particularly prevalent in that part of the tertiary sector previously the exclusive domain of Polytechnics (NZQA, 1995). One of the effects of the economic, market-driven, post-Fordist, and plurist philosophies that seem to drive the thought processes of bureaucrats and politicians may have on the HE structure is that a system of plural provision is developed. More than one writer (Filmer etc.) argue for a stratification in which the HE system may be broken into categories. Category one being a small number of “high end” universities involved exclusively in pure and applied research and post-graduate teaching. A middle category of small and more numerous institutions involved in smaller scale research and post graduate teaching (i.e., specialist schools) and the remainder involved primarily in undergraduate teaching, professional and vocational in-work training, and continuing education.

#### **11.8. Rise of the “Knowledge” Industry**

A further feature is the rise of knowledge industries in response to the growth of the so called “knowledge economy”. One of the anomalies of the massification of HE is that universities are producing too many highly skilled graduates for the system to itself absorb. The result is that many more people familiar with scientific and social disciplines and skilled in research, unable to find jobs in the universities are moving into commerce and industry. The number of people leaving HE with the ability to become knowledge producers themselves is increasing and will continue to do so. Many of these people will continue to engage in activities that have a research dimension.

The more of these people the university produces the more they undermine their own exclusive role as knowledge makers.

The core of the thesis is that the parallel expansion in the number of potential knowledge producers on the supply side and the expansion of the requirement of specialist knowledge on the demand side are creating the condition for the emergence of a new mode of knowledge production.

(Gibbons et al., 1994: 13)

Capitalists and capitalist enterprises have discovered that there is money to be made in the “knowledge industry”.

The requirements placed upon HE institutions by society are undergoing a massive transformation. John Stephenson (European University of Industry) talks about an economy in which the industries that survive will be those that are “knowledge capable” (Raven & Stephenson, 2001). The emerging global economy requires a workforce capable of handling an exploding knowledge base. Whilst technology has been the enabling force behind this change the discovery by the business structures of techno-capitalism

that knowledge and information have commercial value has been the driving force.

There are unique elements to this “new” commodity. On the one hand information, unlike many commodities, is not destroyed when it is consumed. It remains to be passed on from consumer to consumer. A multiplier effect means that once a critical level of consumers of the same information has been achieved (the information learned) the spread of information is rapid. Thus the cost of generating knowledge is higher than the cost of replicating it. On the other hand both the volume of knowledge and the temporary and local nature of much of it mean that the costs of generation and storage are very high. Universities have traditionally been a major source of knowledge generation. It is therefore unsurprising that they have come under intense scrutiny.

However other market forces come into play. As the cost of information generation is high there is value, in business terms, for that information to remain scarce and therefore attract premium prices. As information has become more and more important for the success of a business strong efforts to privatize the gathering of information are being made. Enormous amounts of information are now in private hands and businesses pay a high price to access it. Even universities are caught up in this process. Much funded research at universities is now carried out on behalf of private organizations and restrictions on ownership of the results of the research are severe. There have been criminal charges brought against university staff in the U.S. for violating privacy clauses in contracts (Melody, 1997).

Economic theory suggests that when there is a market in which the product is expensive to manufacture but cheap to distribute, both to existing markets and to grow new ones, the tendency is towards global conglomerations with centralized and monopolized structures (note oil as an example).

The university is mandatorially caught up in this process because of its very nature as an information provider and the process has just begun. The changes occurring now and about to occur will see an “order-of-magnitude increase in the automation of the ‘labour-intensive’ educational services sector, including the university” (Melody, 1997: 81).

With all of these threats and challenges to the university “condition” it is easy to see why the goal of a truly “virtual university” has been hard to achieve and it also explains to some degree the limited impact of VLEs on the local educational ecology.

## 12. LOCAL RESPONSES

All of these issues are creating challenges and choices for the HE sector in New Zealand that are outside of its control and it is unclear how the sector will respond. There would appear to be three broad scenarios, one pessimistic,

one less so and one which emphasizes separation between the institution as such and its academic staff.<sup>6</sup>

The pessimistic scenario predicts increasing competition within New Zealand both between local and national institutions and from overseas and these changes will be intensified with changes to the way state funding is applied. Institutions will concentrate on student numbers and offer courses to suit. Under this scenario, institutions compete for market share by seeking to be all things to all people, significantly reducing both the quality of the educational services they offer and their own financial and academic viability. Students, for their part, turn away from local institutions as they recognize the declining quality on offer and look instead to overseas institutions delivering services across the internet. During a period of heavy deregulation (1984–1998) this appeared to be the scenario most likely to eventuate in New Zealand.

(There is some historical significance to this scenario. During deregulation of the financial sector in the late 1980s institutions, relatively unused to competition, sought to expand rapidly and internationally without putting in place the necessary quality control and risk management measures and without understanding the implications of the limited New Zealand market and geographical isolation. Not only did significant business failures occur but many of these institutions ended up being substantially owned and controlled by trans-national corporations.)

In the second scenario competition is more disciplined. The state takes a strong interest in the governance and management of tertiary institutions looking to avoid excessive duplication or waste. There is a growing trend towards specialization driven by factors such as: more discriminating students, changes in research funding, responsiveness to employer concerns, recognition of the importance of developing niche rather than mass market approaches and co-operation/collaboration is valued above “no holds barred” competition. Local institutions gain some “protection” from international institutions. Since 1999 a change of government and the ascendancy of a centre-left coalition suggest that this now appears to be the current approach with the recent legislation to establish the previously mentioned Tertiary Education Commission with its wide powers to regulate and monitor all state HE institutions.

However, under both of these first two scenarios rationalization and economic efficiencies will still be sought and there will be a continuation of merger/acquisition activity in the belief that bigger must mean better, and further reduction in funding. Business modelling will continue to be applied to HE and students will increasingly be seen as consumers. There is a continuing process of development of niche oriented and specialist institutions.

The third scenario suggests that increasing technology efficiencies along with continued pressure both nationally (the main opposition parties are still free market oriented in matters of education and health) and internationally (pressure from world trade bodies such as the WTO and trading partners) to push for scenario one, creates a growing distinction between institutions



and academic staff. Under this scenario academic staff recognize that the changes in the way student funding is applied provide an opportunity for them to establish their own enterprises. For some the motive may be the opportunity of earning an increased income (breaking free from rigid salary scales which do not reflect market valuations of different areas of expertise). For others, the opportunity to take control of their own teaching environment is the main motivator—it may include a commitment to “public education” values enshrined in the use of dedicated not for profit structures. It may include the emergence of institutions intended to serve the interests of particular groups. (This would be particularly the case for Maori and Pacific Islanders in New Zealand.) This leads to the breakdown of traditional HE institutions and the emergence of new models of teaching and learning that provide the flexibility and resources to follow the demands of a fragmented and demanding student population. Partnerships and alliances may come and go in response to specific and discrete learning needs.

Understandably the university struggles to find its “rightful” place in all of this. It seems as if the post-industrial society, in particular the postmodern (post-Fordist) period, coupled with the primacy of market theory has undermined the formally privileged position of the university by creating new centres of knowledge generation, training and research. These are challenges to universities on their own territories as they come to grips with the fact that a range of new specialist organizations can offer at least as good a service to government, business and the community as they can.

If, as Readings (1996) claims the university is “in ruins” is it possible to rebuild it? Will something arise from the rubble to continue the academic traditions?

### 13. THE FUTURE

Anyone who tries to make a distinction between education and entertainment doesn't know the first thing about either.

Seen on a T-shirt and attributed to Marshall McLuhan

If the processes of globalization and techno-capitalism continue then it appears that national economies will become even more inter-dependent as technology enables information flows to increase. In other information systems, especially broadcasting but also telecommunications and the internet the market structure gravitates towards a small number of businesses with immense global power and connections. In the media environment this has ended up with a tight cartel of transnational corporations whose search for consumers is driven by profit. These large organizations are searching for new product and are taking an interest in “learning” as a product. Some are fast developing their own versions of VLEs. The range of providers capitalising on the

“learning market” include The Learning Channel, Thomson Learning, and BBC Online. These can already be observed in a variety of expressions. Examples include the BBCs interactive website for children and their interactive nature series, *Talk with the Animals*.

There are other examples of media-based competition for traditional educational institutions. Michael Milken, more readily known as a Wall Street junk bond dealer, is currently promoting a virtual education and training organization called the “Knowledge Universe” ([www.knowledgeu.com](http://www.knowledgeu.com)). Karl Jones, a prominent U.S. television cable company owner, is promoting the International University. The strong interest in education demonstrated by entertainment and communications organizations such as Microsoft (Encarta); MCI (Caliber Learning Network in association with Sylvan Learning Systems, Inc); and McGraw-Hill (McGraw-Hill World University) all indicate the high level of media influence and media production values that may push HE towards elements of “infotainment”.

Ironically, universities appear to be behaving more like broadcasters. Noam (1995) developed a theory about the three stages of television and the third stage, which he identified at the currently developing stage he called cyber-television. The characteristics of cyber-television as outlined by Noam and the characteristics of the virtual university as outlined by various commentators look very similar (see box).

Inherent in these developments are a number of threats to universities. Among them is the fact that media organizations are more financially resilient and can bounce back more readily from mistakes and failures. Witness the failures of Warner’s 500-channel experiment in Orlando in the early 1990s and the Cambridge Interactive TV Trial of the mid-1990s. Financial disasters that would sink even the most well endowed university. They just do not have the infrastructure to sustain such costly failures and recover from them. Again, media organizations have the resources and knowledge to develop compelling content in the VLE. Years of working with video and audio, graphics and text provide a solid basis for creating attractive content. Universities do not have this heritage and cannot easily compete. Moreover as media companies “discover” the knowledge economy they are moving into the territory that was previously the sole right of the educator. The aforementioned online Jones International University had its origins in cable television. Such entrepreneurs may “cherry-pick” the universities seeking out the information “commodities”, the top information creators (academic staff), the best laboratories and libraries. Such “asset stripping” may become a feature of university life and universities might be forced to play the same game.

According to a recent Merrill Lynch study quoted in a Universitas newsletter (Universitas 21, 2000) it was stated that in 1990 there were 48 million people enrolled in HE courses globally. This was predicted to grow to 97 million by 2010, and to 160 million by 2025. The principle reason for this

### *Cyber-Television*

According to this model the developing generation of television is not, as today's trends might suggest, a move from multi-channel environment to mega-channel television. This is an incorrect extrapolation. Just the opposite will happen. Distributed, decentralized cyber-television will create a one-channel world. Noam called it the "Me Channel".

Some of the features include:

1. A Barrierless Market: There will be no dominant entry points or dominant gatekeepers. Many companies, organizations, and individuals, as many as the market will support, will operate thousands of servers, making an income from a mix of usage fees, subscription charges, transaction fees, advertising charges, and sales commissions.
2. Infinite Diversity: Video servers, acting as large storage devices and holding thousands of films, documentaries, dramas, comedies and other kinds of programming, will be linked by high capacity telecommunications infrastructures and accessed by

### *The Virtual University*

Like Cyber-television, this is not just a prediction but a possible outcome of the direction of today's techno-capitalistic educational environment. This model has no campus and firmly seeks its identity in cyberspace.

Some of its characteristics are:

1. An Open Educational Market: Many institutions, as many as the market will support, will operate locally, nationally, and internationally. Students will enrol at their institution of choice after considering a range of criteria that will include not just the traditional ones of subject, institutional status, faculty quality but also ease of access, speed of delivery, levels of technology such as asynchronicity, the quality of the "bots" and perceived "value" of the "product" in the marketplace.
2. Infinite Diversity: Subjects and courses will be of a diversity limited only by human creativity. Courses will be flexible and designed or tailored for the individual student. The technologies of cyberspace will enable large storage devices to

broadband switchers and routers providing an immensely flexible access to many networks.

3. The Media Supermarket: Television programmes will become totally commodified competing against each other for purchase, positioning themselves on the “shelves” of the servers to attract attention and to become the “preference of choice”.
4. Navigators: The viewer becomes the controller of their own televisual environment employing intelligent navigational agents to search out, access and download programming that interests them. Channels will disappear or become a “virtual” individualized and seamless channel based on the viewers expressed interest, past viewing habits, influences such as friends, critics, and other media sources with a bit of randomness on the side. Viewers will interact with programmes entering into quite complex relationships which are enabled by “return path” technologies. Interactivity will be the key which engages the viewer in a range of social, cultural, commercial, and perhaps political associations.

hold thousands of courses that will be delivered over high capacity telecommunications infrastructures seamlessly organized to individualized menus.

3. The Educational Supermarket: Much learning will become commodified. Courses will compete against each other for purchase by the student. Much energy will go into “positioning” the courses to ensure attention and long “shelf life”.
4. Navigators: Students become the controllers of their own learning environment. They will employ intelligent navigational agents to search out, access, enrol, and deliver the courses that best suit the student’s needs at the time. A student may enrol at multiple institutions; seek approval for an award that is unique to their own situation. They will be much influenced by the “front window” of the possible competing institutions’ shows.

- |  |   |
|--|---|
| <p>5. Asynchronicity: Viewers will see what they want to see when they want to see it. Except for those few programmes when synchronous viewing is preferable—live sport for example, the “me channel” will give access to all programming where and when the viewer wishes it.</p>  | <p>5. Asynchronicity: Students will learn what they want to learn when they want to learn it and where they want to learn it. The university of the future will be on-line all of the time. Face-to-face tuition will be an expensive add-on option. It will be offered probably only to an elite and for specialist courses where real-time participation is essential—music, dance, drama etc.</p>  |
| <p>6. Customcasting: Broadcasting doesn’t become Narrowcasting, the prediction of the cable companies in the 1980s. The simultaneous mass media experience will be replaced by individualized experience. Interactivity will dominate as the media seeks to engage with the individual at unprecedented depth and provide customized content to individual wishes.</p> | <p>6. Customized Learning: Students will design their own learning environment and interact with it. The economic costs of learning will be balanced against such concepts as “just-in-time” learning, “life-long” learning and the needs of the workplace. Many students will just want to “get in, get out, and get a job” (Ruch, 2001: 122). They will use the technology to interact with the courses, faculty and institutions and in the process take over control of their learning experiences.</p> |

growth was online learning and globalization of programming. In 2000 it was estimated that this market was worth U.S. \$15 billion to U.S. educational institutions. Such growth rates coupled with such returns will be a prime driver of the virtual university. David Kirp, professor of public policy at the University of California at Berkeley, warned that “in this high-stakes world money, not quality, talks the loudest” (Kirp, cited in McLeod, 2004).

Perhaps an embryonic transnational university already exists. Universitas 21 is a company incorporated in the United Kingdom with a network of 18 universities in 10 countries. Collectively, it enrolls about 500,000 students each year, employs some 44,000 academics and researchers, and has a combined operating budget of almost U.S.\$9 billion.

According to their own publicity this network provides a framework for member universities to pursue agendas that would be beyond their individual capabilities, capitalising on the established reputation and operational reach of each member. The Company sees its core business as the provision of a “pre-eminent brand for educational services supported by a strong quality assurance framework”. It states that Universitas 21 has been established for the purposes of:

- Developing international curricula for graduates educated and trained to operate in a global professional workforce, with credentials that are internationally portable and accredited across a range of professional jurisdictions;
- Providing a quality assurance structure that operates globally to offer internationally valid processes for the enrolment, instruction, assessment, and certification of students, and an internationally recognized brand identifiable with a global network of high quality universities;
- Providing partnership opportunities for major new providers, including corporate universities, wishing to access a fast-growing international market for HE and advanced training;
- Bringing to such partnerships international recognition and legitimacy, premium HE branding, a demonstrable quality assurance capability, and a proven capacity for producing and delivering quality HE and training programmes. (Universitas 21, 2004)

Certainly their publicity suggests that they are in a position to leverage the reputation, resources and experience of the member universities to work for the establishment of a “global brand” and, on paper at least, they have the elementary requirements to develop the “boundary-less” virtual university. Yet they are far from being a demonstrated success. They seem to be like many others mentioned in this chapter, they have lots of potential but little actuality.

Meanwhile, the technology keeps surging ahead creating its own challenges to the shape and directions of future learning. A New Zealand academic, John Tiffin (Tiffin & Terashima, 2001) and colleagues in Japan are carrying out significant experiments on what they term “hyper-reality”. Their work suggests that the current concepts of “reality” and “virtual reality” may blend into a seamless hyper-reality where the human experience will find it difficult to know what is “real” and what is not. Learners will move between reality and virtual reality adapting to whatever suits their needs at any one time. Tiffin talks about a “world of the virtual, a place where you could be hard pressed to know if the person standing next to you is physically real or virtual or whether they have human or artificial intelligence”. Bridging the gap between the natural and the artificial creates this seamless world creating new opportunities for education, medicine, and communication. Tiffin talks

about hyper-translation—the ability to speak in one language and be heard in another and virtual reality popping out of books to create “media to co-exist with us”.

In that regard the Human Interface Technology Laboratory in New Zealand (HitLabNZ, 2004), has produced a “book” that interfaces reality and virtual reality. The lab has developed the concept of the “Magic Book”. This adds value to a “real” book by permitting the reader, through the use of glasses, to have virtual content superimposed over the real pages. Aimed especially at children, when they see a page with a scene they like they can “fly into the scene and experience it as an immersive virtual environment”. The book permits more than one reader to interact and this enables one reader to view the other as a virtual character in the scene.

These two examples show that while New Zealand searches for a clear role for VLEs in the HE environment and demonstrates both caution and uncertainty about their roles, the country is sharing in the excitement of building the technology and experimenting with the models that may yet provide the universal application to both learning and a hosts of other human activities that will be enhanced as a result.

## CONCLUSION

In seeking to understand what the emerging organizational models in 21st-century HE may be and to reflect on what digitalization, competition, and globalization may do to current institutions of HE in New Zealand this chapter concludes by suggesting that the tendencies demonstrated by media organizations to converge, expand and seek global markets may also be reflected in the behavior of universities. As learning becomes one of the fastest growing “new media” products and media organizations like BBC Online Education, The Learning Channel, The Discovery Channel, Thomson Learning, The Disney Channel, and PBS all seek to promote this new product then it may be possible that either universities will behave more like media organizations or media organizations will take over some of the roles of the university. Or, perhaps these two previously separate activities will “converge” into a yet to be conceived structure that will combine the capital wealth, technology, distribution networks and content creation skills of broadcasters with the knowledge, research skills and teaching and learning resources of HE. Such structures will overcome the barriers to the development of true online universities, create portals through the television screen to a plethora of learning opportunities all tailored, via the Noam concept of the “me channel”, to provide for the immediate learning needs of each individual.

Along the way, small countries like New Zealand will be “swallowed up”. Thirty years ago in New Zealand broadcasting and telecommunications were privileged, local, state owned and operated. Each broadcaster was independent

and reflected the culture and the community in which it resided. The telephone network was state operated and controlled. Today 80% of New Zealand's communications infrastructure is foreign owned. Conglomerates, either in the form of networks, or large multinational companies operate virtually every outlet. Many of them have alliances and other contractual arrangements with overseas operators. The amount of locally created content on television screens is extremely small compared with imported programming. The implications of this model suggest that what has happened and is happening in electronic communications is happening and will happen in HE. This suggests that the independence and localism of HE in New Zealand will eventually be lost.

#### ENDNOTES

1. The Treaty of Waitangi is New Zealand's founding document, an agreement signed in 1840 between the colonizing power Great Britain and the indigenous Maori tribes. It was an exchange of promises many of which were broken or had lapsed as immigrant populations dominated. In recent years there has been increased awareness of the pivotal nature of the Treaty and its role in protecting Maori interests and creating a partnership of equals in the nation (see <http://www.treatyofwaitangi.govt.nz>).
2. New Zealand has a short electoral cycle (3 years) and a unicameral legislature. It is rare for a government to have three successive terms. Thus the political economy is subject to quite substantial swings as oppositional parties move in and out of government. Currently (2004) a Centre-Left government is in its second term and is modifying many of the policies of the previous Centre-Right incumbents.
3. Student loans are a recent phenomenon in New Zealand. Until the early 1990s many students were paid an allowance to attend university. Also, course fees were low. Student debt is now at a record level of NZ\$7 billion and course fees are approaching, and in some cases surpassing, US levels.
4. <http://www.edugate.org/>.
5. Tendencies to consolidate are exemplified by media organizations. The last 30 years have seen the media industries collapse into eight major media conglomerates responsible for the production and distribution of over 80% of all news, information and entertainment. In New Zealand following deregulation there were more than 100 separate companies operating in the radio industry. By 2003 two large companies, both overseas owned, dominate.
6. These scenarios are built from material extrapolated from conversations with the author and from data gathered from presentations at local professional conferences, newspaper reports, and internal institutional policy documents.



## REFERENCES

- Birkerts, S. (1996). *The Gutenberg Elegies: The Fate of Reading in an Electronic Age*. London: Faber & Faber.
- Bittner, J. (1985). *Broadcasting and Communications*, 2nd ed. Englewood Cliffs: Prentice-Hall.
- Brabazon, T. (2003). *Digital Hemlock: Internet Education and the Poisoning of Teaching*. Sydney: University of New South Wales Press.
- Broadcasting & Cable Yearbook. (1998). *Broadcasting & Cable*. New York: Reed Elsevier.
- Brown, P. & Scase, R. (1994). *Higher Education and Corporate Realities: Class, Culture, and the Decline of Graduate Careers*. London: UCL Press.
- Bruch, T. & Barty, A. (1998). Internationalizing British higher education. In: Scott, P. (Ed.) *The Globalization of Higher Education*. Buckingham: Oxford University Press.
- Clarke, A. & Williams, A. (1995). *New Zealand's Future in the Global Environment*. Wellington: GP Publications.
- Daniels, J. (1997). *Mega Universities and Knowledge Media: Technology Strategies for Higher Education*. London: Kogan Page.
- elearn. (2004). elearn, NZ's Tertiary e-learning Portal retrieved from <http://www.elearn.govt.nz/elearn/elearn.portal>, June 16, 2004.
- Filmer, P. (1997). Disinterestedness and the modern university. In: Smith, A. W. F. (Ed.) *The Postmodern University*. Buckingham: Open University Press.
- Florida, R. (2002). *The Rise of the Creative Class*. New York: Basic Books.
- Gibbons, M. et al. (1994). *The New Production of Knowledge: The Dynamics of Science and Research in Contemporary Societies*. London: Sage Publications.
- Interim Tertiary e-learning Framework. (2004). New Zealand Ministry of Education, retrieved from <http://www.steo.govt.nz/download/Interim%20Tertiary%20e-Learning%20Framework%20-%20web.pdf>, June 16, 2004.
- HitLabNZ. (2004). Human Interface Technology Laboratory New Zealand, retrieved from <http://www.hitlabnz.org>, August 31, 2004.
- Johnstone, D. B. (1993). The costs of higher education: worldwide issues and trends for the 1990s. In: Altbach, G. and Johnstone, D. B. (Eds.) *The Funding of Higher Education*. New York: Garland Publishing.
- Kelsey, J. (1997a). *The New Zealand Experiment: A World Model for Structural Adjustment?* Auckland: Auckland University Press.
- Kelsey, J. (1997b). The globalisation of tertiary education: implications of GATS. In: Peters, M. (Ed.) *Cultural Politics and the University in Aotearoa/New Zealand*. Palmerston North, NZ: Dunmore Press, 2.
- Kelsey, J. (1998). *Policy Directions for Tertiary Education: A Submission on the Government Green Paper A future Tertiary Education Policy for New Zealand: Tertiary Education Review*. Auckland, NZ: Education Forum (NZ).
- King, R. (2004). *The University in the Global Age*, Basingstoke, Palgrave Macmillan.
- Kulik, J. A., Bagart, R. L., & Williams, G. W. (1983). Effects of computer based learning on secondary school students. *Journal of Educational Psychology* 75(1), 19–26.
- Kumar, K. (1997). The need for place. In: Smith, A. W. F. (Ed.) *The Postmodern University*. Buckingham: Open University Press.
- Laurillard, D. (1996). The virtual university: value and feasibility. Paper Presented at the Virtual University Conference. Senate House: University of London.
- Leach, K. (2003). Benchmarks for IT investments, trends and insights. Paper Presented to National Association of College and University Business Officers' Annual Conference, July 2003.
- Lee, M. (1995). Illiterate teachers block superhighway. *The Australian* (13 June), 47.

- Luke, C. (1996). ekstasis@cyberia. *Discourse Studies in the Cultural Politics of Education* 17(2), 96–116.
- McKey, P. (2003). The Total Student Experience retrieved from <http://www.nexted.com/nexted/white-papers/2/default.asp> on June 06, 2004.
- MacLean, R. C. (1968). *Television in Education*. London: Methuen.
- MacLeod, D. (2004). The Online revolution, mark II, *The Guardian*, Tuesday April 13, 2004, retrieved from <http://education.guardian.co.uk/elearning/story/0,10577,1190470,00.html>, June 16, 2004.
- Melody, W. (1997). Universities and public policy. In: Smith, A. W. F. (Ed.) *The Postmodern University*. Buckingham: Open University Press.
- Moodle. (2004). Moodle, Using Moodle, retrieved from <http://moodle.org/course/view.php?id=5>, June 16, 2004.
- NCATE. (1999). The Technology Task Force, retrieved from <http://www.ncate.org/projects> on August 04, 2003.
- NextEd. (2004). NextEd, About Us, retrieved from <http://www.nexted.com/nexted/about/default.asp>, August 24, 2004.
- New Zealand Business Roundtable. (1994). *The Next Decade of Change*. Wellington: New Zealand Business Roundtable.
- Ninness, G. (2002). Billion Dollar Student Boom, *Sunday Star Times* (May 19), Business Section, 5.
- Noam, E. M. (1995). Towards the third revolution in television. Symposium on Productive Regulation in the TV Market, Bertelsmann Foundation, Gütersloh, Germany, December 01, <[http://www.citi.columbia.edu/elinoam/articles/third\\_rev\\_tv.htm](http://www.citi.columbia.edu/elinoam/articles/third_rev_tv.htm)>
- Nocera, J. (1996). If Mike were 25 . . . *Fortune* 134(6), 64–69.
- NZQA. (1995). *Training Establishment Register*. Wellington: New Zealand Qualifications Authority.
- Peled, A. (1987). The next computer revolution. *Scientific American* 257(4) October, 56–68.
- Potts, J. (1979). ETV and the less developed countries. *Visual Education* (January 1979), London.
- Psacharopoulos, G. (1993). The future of higher education financing. In: Altbach, G. and Johnstone, D. B. (Eds.) *The Funding of Higher Education*. New York: Garland Publishing.
- Raven, J. & Stephenson, J. (2001). *Competence in the Learning Society*. London: Peter Lang Publishing.
- Readings, B. (1996). *The University in Ruins*. Cambridge, MA: London, Harvard University Press.
- Robinson, J. (1964). *Educational Television and Radio in Britain—A New Phase in Education*. London: BBC.
- Rossmann, P. (1992). *The Emerging Worldwide Electronic University: Information Age Global Higher Education*. Westport: Greenwood Press.
- Rushkoff, D. (1994). *Media Virus*. New York: Random House.
- Schramm, W. (1960). *The Impact of Educational Television*. Urbana: University of Illinois Press.
- Schramm, W. (1964). *Mass Media and National Development, the Role of Information in the Developing Countries*. Paris: UNESCO.
- Scott, P. (1997). Crisis: what crisis? The crisis of knowledge and the massification of higher education. In: Barnett, R. and Griffin, A. (Eds.) *The End of Knowledge in Higher Education*. London: Cassell.
- Skinner, B. F. (1954). The science of learning and the art of teaching. *Harvard Educational Review* (24), 86–97.
- Smith, A. & Webster, F. (1997). *The Postmodern University? Contested Visions of Higher Education in Society*. Philadelphia: Open University Press.

- Spencer, K. (1988). *The Psychology of Educational Technology and Instructional Media*. London: Routledge.
- Spender, D. (1995). *Nattering on the Net: Women, Power and Cyberspace*. North Melbourne: Spinifex, 1995.
- Statistics NZ. (2004). Imports and Exports, retrieved from [tp://www.stats.govt.nz/domino/external/web/nzstories.nsf/Response/Exports+and+Imports](http://www.stats.govt.nz/domino/external/web/nzstories.nsf/Response/Exports+and+Imports), August 19, 2004.
- Stephenson, J. & Yorke, M. (1998). *Capability and Quality in Higher Education*. London: Kogan Page.
- Stonier, T. & Conlin, C. (1985). *The Three C's: Children, Computers and Communications*. Chichester: Wiley & Sons.
- Sutch, W. B. (1966). *Colony or Nation? Economic Crises in New Zealand from the 1860s to 1960s*. Sydney: Sydney University Press.
- Tavernier, K. (1993). Are university funding systems in need of an overhaul? In: Altbach, G. and Johnstone, D. B. (Eds.) *The Funding of Higher Education*. New York: Garland Publishing.
- TEC. (2004). New Zealand Tertiary Education Commission, retrieved from <http://www.tec.govt.nz>, June 16, 2004.
- Ted. (2004). Ted, NZ's Tertiary Education Portal, retrieved from <http://www.ted.govt.nz/ted/ted.portal>, August 24, 2004.
- Tertiary Information Strategy. (2003). New Zealand Ministry of Education, retrieved from [www.step.govt.nz/download/tis.pdf](http://www.step.govt.nz/download/tis.pdf), June 06, 2004.
- Tiffin, J. & Rajashingham, L. (1995). *In Search of the Virtual Class*. London: Routledge.
- Tiffin, J. & Terashima, N. (2001). *Hyper-Reality: Paradigm for the Third Millennium*. London: Routledge.
- TOPANZ. (2002). *Annual Report, 2002*, The Open Polytechnic of New Zealand, retrieved from <http://www.topnz.ac.nz/aboutus/corporateinformation/publications/annualreport/auannrep6.html> on July 15, 2004.
- Trow, M. A. (1973). *Problems in the Transition from Elite to Mass Higher Education*. New York: Carnegie Commission on Higher Education.
- Tyler-Smith, K. (2004a). Manager of E-learning Services, Tertiary Accord of New Zealand, *Personal Communication*, June 06, 2004.
- Tyler-Smith, K. (2004b). *Personal Interview*, June 16, 2004.
- Universitas 21. (2000). News and Activities, retrieved from <http://www.universitas21.bham.ac.uk/news/press1.htm>.
- Universitas 21. (2004). Universitas 21, About Us, retrieved from <http://www.universitas21.com/about/>, June 06, 2004.
- University of Canterbury. (1979). *1978 Annual Report*. Christchurch: University of Canterbury.
- University of Canterbury. (2003). *2002 Annual Report*. Christchurch: University of Canterbury.
- USQ. (2004). *USQ Online, study by the Internet*, University of Southern Queensland, retrieved from <http://www.usqonline.com.au/>, August 24, 2004.
- Waniewicz, I. (1972). *Broadcasting for Adult Education—A Guidebook To World-Wide Experience*. Paris: UNESCO.
- Watson, J. B. (1925). *Behaviourism*. London: Kegan Paul.
- Watts, R. (1999). *Cyber War for Students: Competition on Campus*. *Campus Review*, 6(35) (September 11–17, Sydney).
- Williams, D. (2003). Success still in the distance. *The Guardian*, March 22, 2003 retrieved from <http://education.guardian.co.uk/elearning/story/0,10577,919318,00.html>.
- Williams, J. G. (1950). *Radio in Fundamental Education*. Paris: UNESCO.
- Williams, R. (1974). *Television, Technology and Cultural Form*. London: Fontana.
- Williams, R. M. (1972). *Report of the NZ Commission of Inquiry into the Uses of Television in Education*. Wellington: N Z Government.
- Woods, B. (1993). *Communication, Technology and the Development of People*. London: Routledge.

## Chapter 25: Technology and Culture in Online Education: Critical Reflections on a Decade of Distance Learning

TIM W. LUKE

*Department of Political Science, Virginia Polytechnic Institute and State University,  
Blacksburg, VA, U.S.A.*

This chapter is a set of critical reflections on a decade of digitally driven distance learning on the web with e-texts, online courses, and virtual faculties. It reconsiders the project of building a virtual campus for existing brick-and-mortar universities around online communities—with their many perils and prospects—amidst broader shifts in the global economy. This “brick-and-click” option has been up and running at one particular North American university: Virginia Polytechnic Institute and State University, or Virginia Tech, for a decade. And, this analysis recounts the pluses and minuses of this experience. It, first, indicates why many existing offline university practices prevent change, and, second, it suggests how some online functionalities easily accelerate change. Yet, in considering how all universities might be transformed with digitalization, it also worries about what kind of changes, change defined by whom, and change for whose benefit in the larger society?

Most importantly, however, it sees e-learning on virtual campuses as an on-going reinvention of existing university institutions. Such organizational innovation can enable universities to create new learning communities and learned discourses, while keeping many of their traditions alive. Rather than permitting corporate entities to switch societies into shoddy substitutes for present-day universities with very misguided efforts to commodify the forms of higher learning that universities historically have produced, virtual campuses can use online classes to reach both existing and new clients.

### 1. THE FOUNDATIONS

Virginia Tech began constructing its virtual campus in 1993 with the launch of the Faculty Development Initiative (FDI). This experiment depended upon the implementation of distributed computing, which was launched by the Provost’s Office and the Vice President for Information Systems. By closing down the university’s old centralized mainframe systems, the FDI gave a new

Apple desktop computer, a suite of software applications, and nearly a week's worth of hands-on training to a cadre of Arts and Sciences faculty with the hope that they, first, would quit using the old, expensive mainframe system and, second, might start playing around with these new personal computers in their teaching, research, and service. Without this first piece of almost accidental history, far less would be occurring at Virginia Tech because this one decision got computers out of the control of those who everyone once believed *should* have them—engineers, computer scientists, physicists—and into the possession of those who many thought did not need them—philosophers, political scientists, poets. Once those who supposedly did not need or allegedly could not use personal computers got a hold of them, several new virtual communities—both online and offline—were more easily “imagined” (Anderson, 1991) at Virginia Tech. And, everything began to change rapidly, fundamentally, and unpredictably.

At the same time, a small group of faculty in the College of Arts and Sciences was charged by Dr. Robert C. Bates, who had just been appointed the Dean, to think about using computers to break the credit-for-contact paradigm in response to fiscal pressures: Rising enrollments, falling numbers of faculty, and decreasing state appropriations. Led by Associate Dean Lucinda Roy, this committee advanced a proposal to construct a virtual college in November 1994 (Luke, 1994) around a series of online courses, which came to be called the Virginia Tech Cyberschool. Because of a parallel development in town, or a new off-campus online community, the Blacksburg Electronic Village, many students, and faculty had the internet access and technical skills to put this initial vision of a virtual campus into practice during summer 1995 with the first Virginia Tech Cyberschool courses. At that juncture, a major Sloan Foundation grant also allowed another team develop new computer-enhanced introductory biology courses in the ACCESS project, and a larger mix of totally online courses was offered at a distance over the Net in summer 1996 in the humanities, sciences, and social sciences.

Running parallel to these successes, the university self-study of 1996–1998 aimed at re-imagining Virginia Tech around its high technology strengths, including the enhancement of the university's online teaching capabilities. Totally online M.A. programs in physical education and political science went up on the web in 1996–1997 and 1997–1998, and Virginia Tech Online (VTO)—a full service virtual campus site—was activated in the College of Arts and Sciences to support its online courses during 1997–1998. Finally, all graduate theses and dissertations were required by the Graduate School to be archived as digital documents in 1997, and all entering students were required to have a computer during the Fall 1998 semester. And, the entire e-learning environment was anchored in Spring 1999 to a new dedicated organization—the Institute for Distance and Distributed Learning (IDDL)—that reported to the Provost's Office.

### 1.1. The Cyberschool Idea

The key issue for Cyberschool, which the founding faculty anticipated in 1994, has been how to value instruction in virtual teaching environments. Does online teaching enhance and enrich the education that university has always provided? For the most part, Virginia Tech students tend to agree that it does, both as an on-campus complement for face-to-face instruction and an off-campus virtual source of on-campus educational activities, because online technologies do create a new kind of learning community. Students consistently indicate that Cyberschool classes have increased their interactions with each other and faculty, have given them more convenient access to learning opportunities, and have enhanced their opportunities to work with course materials in a newer, more informative ways that emulate many corporate, governmental, and not-for-profit work environments.

By 1996, then, the exponents of Cyberschool-style classes could say this experiment had fulfilled most of its original design agendas. As the 1994 Cyberschool plan proposed,

The cyberschool must be designed as an experiment to change (but not increase) faculty workloads, enhance (but not decrease) student interactions, equalize (and not shortchange) the resources, prestige, and value of all disciplines, balance (and not over emphasize) the transmittal of certain vital skills, concentrate (and not scatter) the investment of institutional resources, and strengthen (and not reduce) the value of all academic services. Technologies do not have one or two good and bad promises locked within them, awaiting their right use or wrong misuse. They have multiple potentials that are structured by the existing social relations guiding their control and application. We can construct the cyberschool's virtual spaces and classrooms so that they help actualize a truly valuable (and innovative) new type of higher education.

(Luke, 1994)

There have been many rewards in creating Cyberschool-style classes. Students were enthusiastic about these innovations, and many measures of their learning showed considerable gains. Nonetheless, it also did prove to be a more punishing way to work for faculty. Instruction modules take time to develop, and most online course interactions with students are much more intense, time-consuming, and demanding than regular face-to-face teaching. Keeping machines, software packages, network links as well as course websites, listserves or chat rooms up and running was an exhausting ordeal on top of simply "teaching" the class once all of the IT components do, in fact, work online. IDDL mitigates this load considerably, but online teaching still requires different skills.

These demanding new work obligations caused friction inside of many units, because so few departments materially supported, financially rewarded, or professionally endorsed these new initiatives in e-learning. Of course, such success also brought additional expectations for publicity events as faculty colleagues and administrators made demands upon the pioneers to do demonstrations, speak their mind about the pluses and minuses of Cyberschooling work, or consult with the next wave of innovators as they launched Cyberschool-style classes. This agitprop work typically turned into “defend what you are doing” episodes as often as they served as “show me how to do it” events.

Many of the changes in workload brought to faculty by Cyberschool were, at bottom, net individual add-ons as well as basic departmental increases. Cyberschool faculty did new kinds of work, but they also did more of it. Resources were provided temporarily through infusions of one-time grants and other funds, but the university did not make changes in the basic structures of faculty rewards. And, even today in 2004, there is insufficient stable base funding for this activity. While Cyberschool used technology, its participants also have not altered an academic culture that still underappreciates, for instance, the prestige and resource needs of arts, social sciences, and humanities programs against those of the natural sciences, business, or engineering. While the College of Arts and Sciences responded positively to e-learning, the university moved very slowly to rethink the rewards (in tenure and promotion, salary raises, or departmental prestige) for this new kind of teaching-centered, research-and-development work at the heart of many Cyberschool innovations.

The combined faculty challenges—measured in terms of workloads and rewards—have led to cases of “burnout”. Most of those who first helped initiate the Cyberschool project at Virginia Tech have moved on to other interests. They feel that they cannot afford the costs that their participation incurs against professional research projects or their tenure and promotion reviews. Early Cyberschool pioneers often expressed a sense of exhaustion as they struggled to achieve excellence on both a new, and the traditional, scales used to measure teaching, research, and service success. Cyberschool was an initiative rooted in the college of Arts and Sciences with faculty from English, Philosophy, Communications, Music, Theater Arts, Art History, Psychology, Biology, Political Science, and History. Most of Cyberschool’s initial efforts focused on the classroom, but no school is merely a collection of classrooms for faculty teaching. Such e-learning activities also need an extensive administrative infrastructure to support its activities. Until given new support with online community infrastructure at the university-level through IDDL in 1999, Cyberschool did not move forward too far.

From 1994 to 1999, then, Cyberschool essentially ran on a “demonstration project” basis in one college. In times of very tight budgets, Dean Bates in Arts and Sciences supported Cyberschool with some college funds and the time of his staff. A university center, or the Center for Excellence in Undergraduate

Teaching, provided seed money for developing online courses, the FDI support staff helped immensely, and the Departments of English, Communications, Biology, Art and Art History, Music, and Political Science also contributed to the Cyberschool initiative. Yet, it was time by 1999 to move beyond the “demonstration project” stage with IDDL so that online education at Virginia Tech would not lose momentum entirely.

### 1.2. Pushing Cyberschool up to the University Level

In 1994, the Cyberschool faculty also proposed that Virginia Tech construct a set of virtual environments for online education that could provide:

- a) A set of basic orientation, enrollment, credit acquisition, syllabus, and fee payment information about all Cyberschool instructional sessions;
- b) a system of secure access and use rules to insure that students are who they represent themselves to be, are fee-paying legitimate users of the system, and are guaranteed confidentiality in their interactions with the Cyberschool, which also would guard this fair use of copyright restrictions of online materials;
- c) a series of multi-user domains, structured as online chat sessions or time-delayed bulletin board structures, that can be assigned to an instructor, a student or groups of instructors and students in order to work through pre-arranged course of instruction;
- d) a linkage to second-source educational packages switched from VPI&SU libraries, other VPI&SU college Cyberschool systems, or off-campus sources of video/audio/textual educational information; and,
- e) a means of collaborating with off-campus corporate, university, and government offices to test new networking, software, hardware, multimedia technologies, and services that might improve the VPI&SU Cyberschool campus (Luke, 1994).

Cyberschool faculty made these proposals, because their biggest needs were *logistical* or *administrative*.

The Cyberschool faculty and the College of Arts and Sciences provided the real push needed during 1994–1998 to get the university focused on online learning and its new institutional requirements. By 1996–1997, Cyberschool coordinated about fifteen online classes, and collaborated with the Vice President of Information Systems to construct VTO as Virginia Tech’s portal to distance and distributed education courses. The College of Arts and Sciences covered VTO’s administrative costs as well as paid buy-outs for faculty to teach online in 1997–1998. That year was spent as a focused pilot project to demonstrate the demand for more online instruction, which brought the Provost’s Office, Educational Technologies, and the College of Arts and



Sciences together to build the IDDL unit. A matrix organization, the IDDL was organized by the Provost's Office, but much of its personnel and resources come from the Vice President for Information Systems, Extension and Outreach, and the College of Arts and Sciences. With a teaching and research faculty executive director as well as an administrative and professional faculty director, the IDDL was assigned the task of bringing more Virginia Tech classes and programs to the web in addition to the Commonwealth's large ATM network, or Network.Virginia.

Virginia Tech by 1998–1999 had many distance and learning courses, but lacked a friction-free means of publishing distance learning course details through an online catalogue, updating an online timetable, registering students on demand for online classes with an e-commerce utility, managing the mechanics of online class enrollments, administering the demands of online student grading or major/minor/core requirements fulfillment, or paying for class credits and other student fees online. Initially, VTO in the College of Arts and Sciences provided some of these services, but it was not until 2000 under IDDL that VTO finally could manage online education as e-commerce transactions. Still, something more comprehensive was plainly needed, even 5 years into the Cyberschool project. Most of Virginia Tech's online classes were undergraduate classes, no single program of study was put entirely online until 1997, most of the courses were core curricular offerings, and no course was designed outside of the normal time/credit/work rules of conventional contact teaching. For the most part, this outcome was cost conflict and a turf question. Cyberschool was regarded as a College of Arts and Sciences project, which had very limited funding and its Liberal Arts approach was unpopular in the professional schools and more applied fields.

With scores of courses in Virginia Tech's eight colleges using Cyberschool-like methods of instruction by 1999, the university did put its e-campus on a more solid administrative footing by creating the IDDL in 1999. Its task was to develop reliable means for: (a) rewarding faculty materially for their efforts; (b) supporting departments for their engagement with these innovations; (c) consolidating new administrative software, procedures, or rules for coping with expanded online teaching; (d) preparing students for online learning by insuring "one student–one PC" access levels with adequate network and computer support for all students; (e) publishing information about distance and distributed learning course availability more widely to increase enrollment; and (f) organizing all of their activities through a central site to avoid duplication of efforts, standardize curricular planning, and reduce lead times in scaling up Cyberschool-like classes for access by anyone anywhere anytime. This involved new expenditures of time, energy, and money in the Provost's Office, but that investment was well-worth the effort.

Like many other groups elsewhere, the Cyberschool faculty at Virginia Tech operated as an advocacy organization, issue group, or social movement to criticize and popularize the use of computer-mediated communication in

university instruction. This point is important, because despite what all of the digital futurists claim, technology does nothing on its own. Technically driven change is neither automatic nor easy; and, every apparent technological innovation either is hobbled by significant anti-technological resistance or advanced by supportive pro-technical allies. Unfortunately, however, myths people share about technological inexorability make it difficult to think “outside of the box” when it comes to using most new technology (Luke, 1989).

In many ways, the virtual campus at Virginia Tech is an uneasy amalgam of post-Fordist flexible work organizations and digital network technologies (Jameson, 1991). When combined together by academics, they can provide a new model for flatter, leaner, more responsive academic work organizations. Despite such alluring prospects, however, none of the changes happened on their own. They became possible only by determined groups of people that worked to re-order how the university actually operated in 1994. In 2004, e-learning is now a routine service provided by special administrative units like Virginia Tech’s IDDL.

Given its experience from Cyberschool with online undergraduate instruction, for example, the Department of Political Science also launched the development of its fully online Masters degree program in Political Science (<http://www.olma.vt.edu>) during 1997, and individual courses were being taught through it as early as Summer 1998. The College of Arts and Sciences was asked at that time to expand its teaching presence in the state’s urban areas across Northern Virginia, and this approach seemed like a relatively cost-effective strategy for providing the M.A. in political science to non-traditional students residing in the DC area. Of course, the site is available to anyone anywhere anytime in the world, so nearly sixty students are now taking courses in the program from all over the U.S.A. as well as Europe and Asia. Most of the online M.A. students are individuals serving with the U.S. military, working for international agencies and state governments, or teaching in secondary school and community colleges. Its first full-class was admitted in 1999, and all of them graduated by 2003.

The deployment of digital technology in this program has had two aims. First, it helped to overcome the university’s place-bound qualities by making the M.A. degree offered by the Department of Political Science fully available online. And, second, it addressed the needs of place-bound students whose career and family demands made it impossible to pull up stakes to move to Blacksburg for their studies. The decisions taken by the university at-large to put much more emphasis on digitized library resources, to provide an excellent support structure for registration, enrollment, and records-management with VTOline, and to push for a campus-wide electronic thesis and dissertation requirement made it possible to produce an excellent graduate educational experience online. The first OLMA/PSCI student finished writing his M.A. thesis during Fall 2001, and he orally defended it before his committee

members in Blacksburg, Virginia, and Washington, DC from his place of work near Frankfurt, Germany during an extended videoconference in December 2001.

A majority of the faculty at all ranks in the Department of political science has participated in the online M.A. program. The common caricature of university faculty members as neo-luddite opponents to technological innovation simply is not true. Once faculty were shown the utility of new digital teaching tools, which enable them to communicate more effectively as well as allow students to learn more flexibly, they adopted such innovations. While some faculty will remain quite wary of administrative dictates from above, they enthusiastically join challenging new projects, like Cyberschool or OLMA/PSCI, that afford them fresh opportunities to try out new approaches, to learn different educational techniques, and to use better communications.

## 2. BUILDING AN ONLINE COMMUNITY FOR EDUCATION

The semester that the IDDL was launched, there were 17 distance and learning courses with under 1000 enrollments. Most of these courses originated in the College of Arts and Sciences from Cyberschool, but the IDDL gradually promoted more diversity and depth in the course offerings. In Summer 1999, there were 35 distance learning classes with 1155 enrollments; in Fall 1999, 73 distance learning classes were given with 2218 enrollments, and, Spring 2000 saw 88 distance learning courses with 3001 enrollments. The total online inventory of courses was over 100 by 2001. While it is not a huge number, 6374 enrollments in distance learning classes in 1999–2000 represented a 24% increase over 1998–1999. At the same time, the number of courses offered rose from 135 to 214, which is a 60% increase. By 2002, over 300 courses were available online, and it was possible to fulfill most of the core curricular requirements entirely online.

Much of this increase came from IDDL efforts to support distance learning in all of the colleges and departments of the university. Of the university's nearly 1500 faculty, 136 were involved in 1999–2000 as instructors in distance and distributed learning. The IDDL gave fifteen faculty summer stipends for courses in Summer 1999, and fourteen more course development fellowships were given out in 2000. An online IDDL newsletter was started to publicize distance learning achievements and developments, and the IDDL touted the merits of online teaching for faculty to their deans, directors, and department heads. New personnel were hired to manage marketing, assessment, and new course development, which also demonstrated the university's resolve to take new teaching techniques seriously.

While financial challenges are difficult, they often are easier to tackle than overcoming the entrenched routines of face-to-face interaction embedded by everyday administrative practice. Virginia Tech was teaching courses over the

web in 1995, but it still has not cycled all of its administrative and information systems (AIS) to work on internet time. The contradictions made obvious by doing coursework online, like registering for classes with paper forms, paying with a paper check, getting paper documentation of registration, and checking on records with paper archives all brought the university to a major upgrade of its AIS services in the mid-1990s. Existing AIS systems from the 1970s tended to pull data into peculiar pockets of power and privilege from which it neither circulated widely nor linked easily with other information sets.

The infiltration of net-centered thinking in the classroom as well as the desire for an enterprise level integration system moved Virginia Tech to contract with SCT. This partnership adapted Banner™ to Virginia Tech's workings in ways that it made logical to support network-based teaching and administration. Nonetheless, the IDDL still had to lobby hard to convince the Bursar's, Registrar's, and Treasurer's Offices to accept credit cards from distance learners for tuition and fee payment, dedicate specific index numbers for online classes, break apart 3-hour/3-credit courses for distance learning students, and allow flexible scheduling for online classes. All of these provisions are necessary to succeed at distance learning, but each one of them transgressed existing practices that favor on campus enrollments. The architecture of Banner™ has been modified to deal with these needs, but it would have been much more difficult to make such policy innovations without this on-going enterprise reintegration project growing alongside, albeit separate and apart, the IDDL.

Instead of starting with a clean sheet of paper to build a corporate-oriented thin, for-profit, skill competency based virtual university, like the University of Phoenix, Virginia Tech has renovated the public-supported, thick, not-for-profit, and degree granting structures of the traditional university, injecting bits of market response into its virtual campus while remaining committed to traditional education ideals. After offering their first classes in 1995, and even once IDDL was started in 1994, Cyberschool faculty have continuously worked as change agents, pushing the university to adopt many new reforms, ranging from mandatory individual computer ownership for students, new technology support fees, student peer learning and teaching, and mandatory electronic thesis and dissertation submissions to online student registration, electronic records access, digital university press publications at a digital discourse center, alumni-centered lifelong learning initiatives, and redefined faculty reward systems. At the end of the day, these reforms have effectively restructured some of the university's research, teaching, and extension services to be more responsive to changing demands off campus and new needs on campus. Virtual campuses at traditional universities, then, can advance radical changes that are far greater and much more diverse than simply deploying computer multimedia to teach workplace skills, because they build new online communities. Many visions of the virtual university do little to move past a limited changes in content delivery, while a few, including the Virginia Tech, push to make these technology-driven changes much more creative.

First, a virtual university can be in many ways an entirely new form of learning community. Anyone who has paid attention to everyday practices since 1994 in the U.S.A. should see this change. Today most colleges operate extensively through computer-mediated communications every working day. e-mail interactions are displacing telephone conversations, F2F meetings, and personal exchanges in ways that once were carried exclusively by written texts. While this traffic often is also fleeting, underdeveloped, and exhausting, it has textual, hypertextual, or multimedia qualities unknown outside of computer networks. Written words carry more and more instructional activity, while most basic information resources once printed in catalogues, mailed out as brochures, accumulated in libraries, or posted on bulletin boards now must be pulled down from websites. They can be changed more frequently, and hard copy costs are shifted to users. Physical location, synchronously shared times, and group meetings are becoming less vital to learning than network connectivity. So access to education has been quickened and broadened. In addition to everyone who would be traditionally on campus, one finds non-traditional students, clients abroad, not-for-credit students, and residential students temporarily located elsewhere all commingling together in e-learning classes at virtual campus sites in new kinds of communal interactions.

Second, new discursive possibilities are developing within, and as integral parts of, the virtual campus at this university as online technologies begin to do much more than simply electrify print documents. The WWW, CD-ROMs, hard drive software, and floppy disks all represent new communicative media whose functionalities sustain fresh modes of discourse with their own conventions, formations, and practices as well as unconventionalities, misformations, and malpractices. The electronic thesis and dissertation, online catalogues, student access to registration sites, and online advising are all good cases in point. In-house administrative discussions and external research communications on the WWW in PDF, Eudora, or Word software packages are carrying hypertextual, multimedia, or technoscientific discourses, which lead to a profusion of new logics, pragmatics, and rhetorics in their arguments that print cannot capture. Research is being conducted, written-up, peer reviewed, published professionally, and then permanently archived all in entirely online modes—often cheaper, more accessible, and much faster. This experience at Virginia Tech indicates that research, reflection, and reasoning about knowledge in almost every discipline must confront this new communicative dimension of virtualization in tertiary education.

Third, the virtual campus at a traditional university leads to new disciplinary coalitions and social networks. The pervasiveness of changes brought on by computer-mediated communication has remade, if only in part and for a while, the disciplinary divisions and canonical conceptualizations embedded in the structures of the university's essentially industrial, nationalist, and scientific organization. Globalization and marketization are reshaping economies and societies, and legitimate forms of knowledge about them also are evolving in

ways that no longer mesh as fully with the existing organizational outlines of established academic disciplines. Newer networks of knowledge production, consumption, circulation, and accumulation nest now in professional consultancies, for-profit enterprises, and state agencies. Off campus, there is a market-based sense of knowledge consumption, a quick-and-dirty approach to knowledge production, and a task-oriented sense of knowledge definition that all are reshaping what some disciplines do research on, when they do it, why they do it, and how it gets done. The virtual campus of traditional universities can import insights or experts from these parallel networks of scientific investigation off-campus as well as begin to rebuild traditional on-campus faculties to emulate these new modes of research.

A fully virtual university is technologically feasible at this juncture. Yet, there are many obdurate material practices and cultural values impeding its development. On one level, new tremendous infrastructure requirements—whose costs and complexities have not been fully grasped by most supporters of the virtual university—loom over the growth of every e-campus. In 1999–2000, barely 50% of all households in the U.S. had a personal computer with internet connectivity, and most connections moved up and down their link at baud rates of 28,800–56,600. By April 2004, things here have improved in the U.S.A. with 50% of all homes having a computer, and over 55% having a high-bandwidth connection <[http://www.pewtrusts.com/ideas/ideas\\_item.cfm?](http://www.pewtrusts.com/ideas/ideas_item.cfm?)>. More political jurisdictions in the world, following trails blazed by Commonwealth of Virginia and the city-state of Singapore in 1995–1996, are building widely available high-bandwidth networks, internet 2 level networks are spreading, and wireless technologies can address some of these problems. Nonetheless, like most traditional media, the internet creates its own inequality (Schiller, 1996). Connectivity still is geographically patchy, unequally enjoyed, and technically immature. Even then, these telecom systems can fail, charge high basic rates, and limit equipment choices in a manner that obstructs communicative ease, ready connection, and cheap websurfing.

On a second level, there is real gap between the predicted level of network use puffed up, on the one hand, by hardware producers, telco operators, and software firms and the actual numbers of users, on the other hand, that show up at the virtual campus' digital doorsteps. Most people use their PCs for doing e-mail, visiting sex sites, hitting online casinos, or visiting shopping outlets. After 3 years of intense public relations on campus, Cyberschool enrollments in Summer 1997 barely hit 350, or an average class size of about 10 students. Off-campus interest is quite intense, but total IDDL enrollments for its courses during Spring 2000 only just barely reached 3000. So F2F connections at our university's home and extended campus outreach sites still anchor Virginia Tech's enrollments. Much of this is due undoubtedly to access costs, bandwidth limitations, and hardware shortages, but institutional barriers, cultural inertia, and professional prejudices also cannot be discounted as sources of serious

resistance to virtualized instruction. Ultimately, online education with the virtual campus is a niche market for most universities and many students.

For academics, the most basic issue raised by the virtual campus is “job control”. The model of flexibilized efficiencies promised by the University of Phoenix masks a knotted tangle of serious job control questions by bundling them up with fancy technological innovations. Going online with university instruction conducted through multimedia packages does abridge many prerogatives now exercised by professors in F2F classroom teaching. These online alternatives mostly presume that professors simply are dispensing information in their traditional lectures and seminars, and therefore their information-dispensing efforts should be enhanced, extended, or even extinguished by technological surrogates.

This type of technological intervention can rob professors of their authority, and cheapen the educational experience. Nonetheless, as scale increases, many course syllabi can be designed and constructed by technical designers, panels of experts, or outside consultants, and then sold as mass media products online or in boxes by publishers. Lectures, in turn, can be automated with such multimedia replacements. Testing might be contracted out to assessment businesses, and student advising, tutorial discussions, or independent studies could be conducted by paraprofessional workers without Ph.D.s.

This image of the future is not favored by academics; instead, it is a dream of corporate players, like Microsoft or Intel, or lobbying groups, like EduCause. Behind these simplistic narratives, it is claimed that technological imperatives, economic necessity, or unserved markets “make change inevitable” for professors as researchers, teachers, and service-providers. Yet, such allegedly inexorable forces of change essentially are, in fact, lobbying campaigns by hardware manufacturers, software publishers, telecommunications vendors, and educational consultants.

At this time, online education as e-learning at Virginia Tech still works in the opposite register: small-scale, handicraft production for local use, not global exchange. Often one instructor is mapping his or her existing courses over to a self-produced or common utility website, generating computer-animated overheads, or organizing multimedia demonstrations to enliven traditional contact-style teaching and/or to experiment with asynchronous learning interactions. The material still mostly is a “home-made” production for “on-campus” circulation through “in-house” means of student consumption or at “on-site” centers of knowledge accumulation. The IDDL’s biggest project since 1999 has been a joint master’s degree in Information Technology jointly created by Computer Science, Electrical Engineering, and the School of Business. While the enterprise is larger, it too largely follows these handicraft models. Therefore, existing pedagogical practices in the university, academic department, and professional discipline still capture and contain e-learning by providing virtual flexibility and multimedia enhancements in established programs of study.

Despite the rhetoric of accessibility, democracy, flexibility, participation, or utility associated with cybernetic technologies, most networks today are, in fact, formations whose characteristic qualities in actual practice are inaccessibility, non-democracy, inflexibility, non-participation, or disutility. Many web domains are not readily accessible, and those that often are nearly worthless. Some schools like MIT have their whole suite of course curricula on the web, but quality and quantity vary widely. There are at least 2 billion pages on the WWW, but the best search engines only capture about 300 or so million of them. No one voted to empower Microsoft, Intel, IBM, or Netscape to act as our virtual world-projectors, online terrain-generators, or telematic community-organizers, but they behave as if we did by glibly re-imagining our essentially choice less purchases in monopolistic markets as freely cast votes. Inequality and powerlessness are not disappearing in the digital domain; they simply have shifted their shapes and substances as human beings virtualize their cultures, economies, and societies in networked environments.

After a decade of experience with designing, launching, and using online education applications at Virginia Tech, it is clear that many of the initial naysaying claims made by opponents of online learning have proven dead wrong. There is no significant difference between online and offline classes in terms of the quality of instruction, level of student satisfaction, effectiveness of faculty work or overall student success that can be attributed to the use of digital technologies and networks. In fact, the nature of the entire project, if anything, often shows that VT Cyberschool courses were, and still are, such that overall student success is slightly higher, faculty are more effective in communicating with students more often and directly, many students are satisfied with the flexible course environments time-wise, and the quality of instruction due to greater emphasis on clear, cogent, and continuous writing is seen as better.

Of course, the VT experience is unusual in that this institution consciously focused upon its core curricular and large enrollment courses at the undergraduate level, which was meant to keep the time-to-degree durations down and lower class sizes in F2F on-campus courses. This policy also essentially "saved" summer school as an institution, because many of its courses had the same orientation historically. From 1990 to 1994, summer enrollments were falling due to state budget cuts and economic recession: these two forces reduced both the supply of and demand for summer classes in Blacksburg. In 1995, around 25 students took courses online, or far less than 0.025% of the student body. By 2004, about 12,000 students took a course online, or nearly 45%. The Cyberschool experiment widely is acknowledged as keeping summer school alive at VT as well as making it possible for undergraduates who return home in the summer to remain enrolled on the University's "virtual campus". Beyond the summer school and core curricular foci, however, few undergraduate classes are taught online at VT.



At the graduate level, VT's location in a comparatively remote and underpopulated area of the Commonwealth with no large urban sites nearby forced it online to serve niche markets at the graduate level in masters' degree and graduate certificate programs. With five major off-campus graduate centers scattered around the state, the use of online courses also broadened and deepened the number of course choices available for such course of instruction. During the 1980s, the University did offer a handful of classes over K-band satellite uplinks as well as with "freeway flyer" instructors doing long road trips. In 1994, several scores of students took such courses, but there were few full degrees offered by VT through such means. By 2004, over 5100 graduate students were enrolled in online graduate classes, seventeen degree and certificate programs were available fully online, 85% of all departments had an online class, and the diversity of classes available for students at the five off-campus centers was enriched greatly.

Nonetheless, these 2004 enrollments constitute a 90% increase in online graduate student enrollments since 1999, and a 325% increase of graduate courses available internationally, so these innovations are starting to change a fairly traditional campus with residential requirements into one of an entirely virtual campus. There is much more resistance to starting new graduate programs now among the faculty and administration due to changes in the top academic leadership, willingness to fund such educational experiments, demand for additional degree options, and the culture of risk taking caused by draconian state budget reductions. While there is a real interest in online doctoral work, university policies and national accreditation practices make this move quite unlikely in the near future. Most master degrees entail discrete bundles of 30–48 hours of work, and only one program requires a demanding research project like a full M.A. thesis. The thesis requirement has been successfully adapted to online environments with committee structures and writing requirements equal to those of on-campus programs as well as oral defense sometimes held as videoconferences intercontinentally. Still, the faculty and administration are unwilling to push forward with online doctoral degrees at this time, even for those disciplines in the humanities, social sciences, policy studies, or arts that could easily tailor their degrees to operate in online environments.

It would be disingenuous to deny that much of the momentum behind online education at VT in the 1990s came from the excessive exuberance of the decades' dot com mania. Too many believed the spiel spun up by the time's enthusiasts about everything changing rapidly overnight; and, since not all that much did change; and, since most firms behind these changes went bust, there now is little interest in maintaining what already has been achieved, much less making any bold new moves. University administrators make their reputations by launching bold new initiatives or dismantling allegedly broken old institutions for the greater good of all. Even though existing strategic plans and mission statements are on the books at VT with online distributed and

distance learning at their core, it is obvious that the money, the commitment, and the will to push forward for Cyberschool-style instruction has fallen considerably from 1994 to 2004.

A great deal of this doubt has come after 2000–2001 with the dot com implosions, but some of it simply derives from changes in administrative focus, leadership, and will. Funding for online instruction was championed most fervently by a dean now long gone to be a provost elsewhere. A former VT provost with some commitment to online learning has been replaced by an outsider with less interest in, support for, and understanding of what VT attained from the early 1990s to 2001. And, the discretionary funds once allocated to online learning have had to be diverted elsewhere simply to keep the University running after several reductions in state monies coming to VT from Richmond. Consequently, energy and time from faculty and support personnel that once went into expansion and invention is being diverted to holding onto what already has been achieved against rising resistance to doing more.

#### CONCLUSIONS

On one level, the project of distance learning in the knowledge business is the latest promised land in many corporate market-building strategies. There are 3600 colleges and universities, for example, in the United States alone, and over 14 million FTE students are enrolled in their courses of instruction. Marketing departments share a dream: What if every department, all libraries, each dormitory, every student center, all classrooms, each faculty office, not to mention administrative and support personnel, got a personal computer and/or web appliance installed at a level of concentration approaching one per student and faculty user, then millions of new product units could be sold, installed, and serviced. Being rational entrepreneurs, then all of the world's computer builders, software packagers, and network installers are exerting tremendous pressure on colleges and universities to open their campuses to computerization so that these markets can be made, serviced, or conquered.

On a second level, however, the project of e-learning meets stiff resistance on campus. Few faculties see the merits of computerized teaching, not all students are computer literate, and most administrators are unable to find funds to pay for all of the computers and network connectivity that the private sector wants to sell them. Most people use their machines for e-mail, word processing or game playing. There are few on-campus agents of change who will ally themselves with new economic modernizers off-campus to transform education through computerization and networking as the corporations imagine it. They are aided, in part, by digital capitalists, who want to build new markets on campus for their hardware, software, and netware; in part, by the

digital mass media, which want to popularize wired cultures and informational communities; and, in part, by digitizing content providers in the entertainment and publishing industries who want to reconfigure or repackage their products for computer-mediated on-and-off-line delivery systems. Still, their effect is limited; and, after a decade of real change at Virginia Tech, only five or six packages have been created in this style.

The sale of computer-mediated communication and online multimedia to teachers, however, is not where the virtual campus starts and stops. Increasingly, as the Virginia Tech Cyberschool has illustrated, when these technologies are introduced into the practices of university administration, they create new online communities whose members can force very closed, hierarchical, and bureaucratic institutional structures to become slightly more open, egalitarian, and consensual sites of collective decision-making. Online information sources, self-paced online application forms, and user-oriented online records management can take access to bureaucratic information out of the hands of special administrative personnel and hand it over to the faculty and students who actually are using it to coproduce educational services. Universities can retain their older, closed bureaucratic structure, but online enterprise reintegration applications usually start to restructure them as looser, flatter, and more responsive entities just by deploying computer-mediated communication technology to new users as a labor-saving strategy. A virtual campus, then, does not necessarily represent business as usual plus some computer multimedia. Instead, it often marks the onset of far more fundamental organizational changes, which give many faculty and administrators on campus the opportunity to rethink and rebuild what they are doing.

The scope and depth of these moves toward e-learning on a virtual campus shows that the ideas advanced by the original pioneers at Virginia Tech in 1993–1994 do “work”. Indeed, the concept of a “virtual university” complements, questions, or even challenges the ways of the “material university” works at Virginia Tech in many fundamental ways. This collision of values and practices obviously fuels the on-going reinvention of institutions for Virginia Tech’s virtual campus. Like Lucinda Roy, many believe Virginia Tech successfully made it through the first phase, but deeper cultural contradictions still require us “to assess what we’ve learned and start anew with some new approaches” (Young, 1998: A24).

To sense the significance of using computers to teach college and university courses, and begin making a new start, as our experience at Virginia Tech shows, one ought not to fixate upon the machines themselves. Plainly, the acts and artifacts used to reproduce collective understandings among specific social groups are changing profoundly: Print discourses, face-to-face classes, paper documents are being displaced by digital discourses, online classes, electronic documents. Because they are so flexible, the former will not entirely disappear, but so too can they not be counted upon to continue uncontested.

The latter will never fully be perfected; but, so too can they not be expected to remain oddities.

Many choose to misread this shift as a classic confrontation of humans with machines (Noble, ), but it is, in fact, a conflict between two different technocultures—one older and tied to mechanism, print, and corporal embodiment, another newer and wired into electronics, codes, and hyper-real telepresences (Diebert, 1997). Building the facilities of a virtual campus is only one piece of this new technoculture, just as the first founding of medieval universities articulated the technics of yet another technoculture tied to the scriptorium, lecture hall, and auditor. While the two technics can throw much light upon each other, the workings of new university technocultures do not exhaust the full range of structural change occurring with informationalization in the global economy and society.

Without being as dismally dismayed about this shift as Birkerts is, the process of digitalization itself does bring a fundamental transformation in many fixed forms of being, especially those tied to communication, discourse, memory. With the proliferation of computer-mediated networks, “the primary human relations—to space, time, nature, and to other people—have been subjected to a warping pressure that is something new under the sun . . . We have created the technology that now only enables us to change our basic nature, but that is making such change all but inevitable” (1994: 15). Of course, the same was said about steam locomotives, telegraphy, airplanes, radio, and telephones but much still remains the same. This change does bring about a move from printed matter to digital bits as a technics to accumulate, circulate, and manipulate stores of knowledge. There are, as Turkle (1996: 17) claims, different “interface values” embedded in each particular medium, and those embodied in print inculcate a special measured, linear, introspective type of consciousness that has anchored our understandings of higher education for several decades. Yet, it took print decades to move universities in the 18th and 19th centuries out of their oral modes of operation.

Inasmuch as digital discourses with their own digital debates, documents, and disciplines supplant libraries of print, a remarkable erasure of experience can indeed occur. Again, Birkerts asserts:

our entire collective subjective history—the soul of our societal body—is encoded in print . . . if a person turns from print—finding it too slow, too hard, irrelevant to the excitements of the present—then what happens to that person’s sense of culture and continuity?

(1994: 20)

Shrewdly enough, Birkerts recognizes his worries and warnings essentially are overdetermined questions, leaving no one with an effective means for pulling single strands of this question out for easy analysis. Instead too many are left

with both a sense of profound loss and immeasurable gain as the popularity of digital modes of communication spread.

Without succumbing to Birkert's fears that everything will change forever, and mainly for the worse, when it runs through electronic circuitries, we should realize in the same moment that everything will not remain the same in online communities, only now in silicon instead of on paper. Instead of "the death of distance" (Cairncross, 1997), the internet often creates "the creation of community". Along the fractures of these faultlines, what is new and different in digital communities must be mapped to address the impact they have upon the culture of universities.

No educational technology exists simply as such with its own immanent dynamics separate and apart from the declared and implied uses for it (Bowles and Gintis, 1976). Technics remediate the pragmatics, logics, and economics in the politics of artifacts (Lyotard, 1984). Some outcomes are unintended and unanticipated, but they emerge from human use. Online learning, then, represents a cluster of much more performative technical applications that are being invested with special importance and power. So, ironically, the WWW is, and is not, just another way for delivering substantive content to content-users by content-providers. Technology is not, as many believe, "just technology". It also is culture, economics, and politics; and, when such technology is combined with education, it becomes even more culturally unstable, economically demanding, and politically threatening. On one side, many exponents of technologically enhanced teaching envision it as leading to new discursive formations, intellectual conventions, and scientific practices. On the other side, many opponents regard any efforts taken toward making such change as malformations, unconventionalities, and malpractices. Strangely enough, a decade of experience with e-learning at Virginia Tech suggests there is merit in both positions that deserves a broad hearing.

#### REFERENCES

- Anderson, B. (1991). *Imagined Communities*, rev. ed. London: Verso.
- Birkerts, S. (1994). *The Gutenberg Elegies: The Fate of Reading in an Electronic Age*. New York: Fawcett.
- Bowles, S., & Gintis, H. (1976). *Schooling in Capitalist America: Educational Reform and the Contradictions of Economic Life*. New York: Harper Colophon.
- Brockman, J. (1996). *Digerati: Encounters with the Cyber Elite*. San Francisco: Hardwired.
- Cairncross, F. (1997). *The Death of Distance: How the Communications Revolution will Change our Lives*. Boston, MA: Harvard Business School Press.
- Deibert, R. J. (1997). *Parchment, Printing, and Hypermedia: Communication in World Order Transformation*. New York: Columbia University Press.
- Jameson, F. (1991). *Postmodernism, or the Cultural Logic of Late Capitalism*. Durham: Duke University Press.
- Luke, T. W. (1994). Going Beyond the Conventions of Credit-for-Contact. Available at, <http://www.cyber.vt.edu/docs/papers.html>.

- Luke, T. W. (1989). *Screens of Power: Ideology, Domination, and Resistance in Informational Society*. Urban: University of Illinois Press.
- Lyotard, J.-F. (1984). *The Postmodern Condition: A Report on Knowledge*. Minneapolis: University of Minnesota Press.
- Noble, D. (2002). *Digital Diploma Mills: The Automation of Higher Education*. New York: Monthly Review Press.
- Reich, R. (1991). *The Work of Nations: Preparing Ourselves for 21st Century Capitalism*. New York: Knopf.
- Schiller, H. (1996). *Information Inequality: The Deepening Social Crisis in America*. New York: Routledge.
- Turkle, S. (1996). *Life on the Screen: Identity in the Age of the Internet*. New York: Touchstone.
- Young, J. (1998). Skeptical academics see perils in information technology. *The Chronicle of Higher Education* XLIV (35) (May 8), A29–30.

## Chapter 26: A Global Perspective on Political Definitions of E-learning: Commonalities and Differences in National Educational Technology Strategy Discourses

YONG ZHAO\*, JING LEI,<sup>†</sup> AND PAUL F. CONWAY<sup>‡1</sup>

\*Michigan State University; <sup>†</sup>Syracuse University; <sup>‡</sup>National University of Ireland, Cork

### 1. INTRODUCTION

*“Information Technology is friendly: it offers a helping hand; it should be embraced. We should think of it more like ET than IT”.*

(Margaret Thatcher, former U.K. Prime Minister, in an opening address at an information technology conference in the early 1980s, cited in Robins and Webster, 1989: 29)

The apparent immense educational potential of the new Information and Communication Technologies (ICTs) has captivated politicians, policy makers, educational leaders, teachers, communities, and business over the last decade around the world. For example, *Education in and for the Information Society*, a UNESCO publication, launched in conjunction with the United Nations and International Telecommunications Union-led World Summit on the Information Society (WSIS), held in Geneva in December 2003, reminded readers that educational ICTs are seen as having the capacity

... to offer unlimited access to information and invite a profound rethinking of the purpose of education and its relevance to national development. They have the potential to widen access to education at all levels, to overcome geographical distances, to multiply training opportunities, and to empower teachers and learners through access to information and innovative learning approaches—both in the classroom, from a distance, and in non-formal settings.

(UNESCO, 2003: 9)

Given the intense global interest in educational ICTs over the last decade, developed countries are now embarking on their third wave of strategic planning for ICTs in education (Conway et al., 2005). While the first wave of educational ICT planning focused on getting technology hardware into schools and upskilling teachers, the second wave concentrated on the integration of ICTs in

<sup>1</sup> Paul Conway's work on this chapter was supported by a grant from the Faculty of Arts, National University of Ireland, Cork.

the daily fabric of teaching and learning, the third wave, typically, emphasizes a more contextual understanding of ICT integration within the confines and supports of particular school cultures (Conway & Zhao, 2003b). Regardless of which wave of planning is the focus of analysis, a powerful and seductive rhetoric at national and global levels seeks to signal the importance of investing money and minds in driving the integration of ICTs in education.

The seductive power of the infinite educational benefits promised by adopting ICTs, and the unchecked fear of missing the fast ICT train to global prominence have resulted in this global chase after e-learning, a concept that has been labeled with a multitude of names, including e-education, virtual learning, or educational uses of technology. This chase would otherwise be non-consequential and discarded as typical political exercises for educators had there not been so much political roar and generous investment of both precious financial and human resources, which have significant implications for education and educators. The serious financial, political, and social commitment can substantially affect the lives of teachers, students, and others who are involved in education through policies, regulations, allocation of funding, curriculum reform, and institutional reorganization. Thus it is wise to understand what is in store for education by understanding what is being chased after politically. In other words, since e-learning or educational uses of ICT is such a vague and new concept that it can conjure up quite different images for different people, it is useful to learn what e-learning is and is not in the minds of those who promote it on behalf of a nation and whether and to what degree the promoted version is reasonable and realizable.

In an analysis of state educational technology plans of the United States, Zhao and Conway (2001) demonstrated that governmental plans for educational uses of technology is a rich source of images of e-learning that represent the minds of the government. Zhao and Conway focused on how state educational technology plans portray the four defining elements of e-learning—technology, teachers, students, and educational goals—in their analysis. After an analysis of 15 state technology plans, they found tremendous similarities across these plans and even more remarkably, these plans conspicuously reflect a techno-centric, utopian, and economic-driven mindset toward e-learning. As a result, they were able to show how the promotion of certain images shadows other viable, perhaps more reasonable, images of e-learning.

To understand how e-learning is defined in the international context, we applied the framework developed by Zhao and Conway to the analysis of national educational technology plans of 13 nations. Through comparing and contrasting national educational ICT strategic plans of these countries that differ in terms of economical development, cultural and educational traditions, and political systems, we hope to find out how e-learning is viewed in terms of the promoted images of technology, teacher, student, and educational goals so as to understand what version of e-learning is valued politically in different nations. In this chapter, we discuss our analysis of the



national educational technology plans in the wider contexts of the massive global investment in educational technologies. A prefatory comment is necessary in relation to terminology. In the U.S.A., where we undertook our initial study of educational technology strategic planning, the term of choice is educational technology. In many other countries, ICT is the preferred term. We use the term e-learning to distinguish our focus from wider discourses and strategic planning in countries in relation to cross-sectoral ICT policy for society as a whole. We focus on strategic discourses generated by governments and inevitably our discussion is partial in that various corporations (e.g., Microsoft and Intel) and transitional organizations (e.g., OECD, World Bank, APEC, etc.) have both developed and influenced strategic discourses on educational ICTs. For example, Microsoft's laptop-focused *Anywhere, Anytime Learning* initiative has garnered considerable attention in terms of the potential of more mobile and personal ICTs such as laptops and PDAs. With a somewhat different focus, Intel's *Teach to the Future* program, aimed at improving pre-service teachers' competence in the use of ICTs, has been adopted by numerous teacher education programs worldwide.

An additional impetus for this analysis is that while ICT technologies across the world are similar in the technical essence, different countries may view them differently according to their own economic development levels, culture and education traditions, and political systems, and thus may portray different images of technology, education, teachers and students, set different goals, and propose different approaches in achieving their goals. Therefore, a comparison of these national educational technology plans can not only identify the general trends in educational technology planning in a global context, but also discover the differences in strategic discourse between different countries. Furthermore, through comparing the findings from this study and Zhao and Conway's study, we can find out whether the problems existing in U.S.A. state technology strategic plans are unique to the U.S.A. because of its cultural and economic development and if other countries can avoid similar problems. Finally, an analysis of ICT in education strategic discourses provides a powerful case study of how globalization is impacting the development of educational policy.

This chapter is divided into two parts. The first part discusses emerging trends in e-learning strategies (readers are referred elsewhere for details of the 13-country study, Conway et al., 2005). The second drawing comparisons between the discourses in our 13-country study and the Zhao and Conway (2001) of educational technology planning discourse as represented in 15 state educational plans in the U.S.A. Each section ends with a summary of the key insights gained on each theme drawing comparisons where appropriate with the U.S. study. The last section discusses the implications of the findings in the context of policy discourse in guiding educators, politicians, and the public in an increasingly global world.

Our study involved an analysis of national education ICT plans of 13 countries from three economic development levels: Developed countries (Ireland,

New Zealand, Singapore, U.K., U.S.A.), emerging economies (Chile, China, India, South Africa, South Korea), and developing countries (Afghanistan and Bangladesh). The selection of these ICT plans was based on their representativeness in terms of geographical dispersion (America, Africa, Asia, Europe, Pacific), population size (from 3745 thousands to 1,266,838 thousands), technology development (phones per 100 persons ranges from 0.1 to 67.3), education development level (illiterate percentage ranges from 0 to 58.7<sup>1</sup>), and time of creation (1996–2002<sup>2</sup>). The second ICT plans, if available, were also included in this study. We used the same analytical framework developed by Zhao and Conway (2001), which identified technology, teachers, students, and educational goals as the four defining elements of e-learning. According to Zhao and Conway, how these four elements are portrayed to a large extent represents how e-learning is viewed and could be implemented. For example, when technology is viewed as networked computers only, it is reasonable to expect that wiring schools and putting multimedia computers in schools would dominate the agenda of hardware deployment. Similarly if teachers are viewed as “gate-keepers”, it is likely that the government will focus on educating the teachers to open their classroom doors to computers. The essence of this analytical framework is the idea that each of these elements can have different interpretations and by comparing the interpretation promoted in technology plans with all possible interpretations will help us identify what is promoted and what is demoted politically, hence obtain an understanding of how e-learning is defined in each nation.

The analytical framework was first developed and used by Zhao and Conway in their study of the U.S. state level educational technology plans. Using a typical grounded theory (Lincoln & Guba, 1985) approach, they generated categories from the educational literature on educational technology and the plans within four focal themes: educational goals, conceptions of technology, and images of students and teachers. For example, in relation to images of teachers as Luddites, gatekeepers, and designers, which we used to categorize images of teachers in the national plans, Zhao and Conway generated these from their review literature on how teachers had been portrayed in various waves of technological innovation in education over the last 100 years (for a detailed discussion see Conway & Zhao, 2003a; Zhao & Conway, 2001). As such, the three chosen categories in relation to images of teachers (Luddites, gatekeepers, and designers) provided a lucid and defensible set of categories with which to both analyze and discuss changes, patterns and implications of particular images of teachers across technology plans. In a similar fashion, Zhao and Conway drew up on the literature in cognitive science and educational psychology and generated three images of student learning: passive responder; active solo inquirer; and active social inquirer. Table 1 summarizes the analytic rubric we utilized in our analysis of the 13 national ICT plans. In both studies, the authors adopted conventional qualitative analysis methods, that is, individual analysis of data followed by cross-referencing of findings

Table 1. Rubric for analyzing images of educational goals, technology, students, and teachers

<b>Educational Goals</b>	<b>Technology</b>	<b>Student</b>	<b>Teacher</b>
Economic competitiveness	As “stand-alone” information machine	Passive respondent to stimuli	Luddite
Democratic equity	As “network”	Active solo inquirer Active social inquirer	Gatekeeper or filter Designer

to ensure validity of the claims being made about how to categorize the focal images in each national ICT plan.

As shown in Table 1, Zhao and Conway (2001) suggest that there can be two major educational goals for ICT integration in schools: to improve economic competitiveness and/or democratic equity. Similarly technology can be viewed either as “stand-alone” information machine and/or as networked computers. The student can be viewed as passive respondent, active solo inquirer, or active social inquirer, while the teacher can be viewed as Luddites, gatekeepers, or designers.

## 2. TRENDS IN E-LEARNING STRATEGIC DISCOURSES

In this section, we first discuss the general trends and descriptions in these national e-learning/ICT strategic plans, and then discuss the findings according to the four elements identified in our theoretical framework: educational goals, technology, students, and teachers. We will also discuss how digital divide is treated in national educational technology strategic plans. The emerging general trends in our study revolve around the following themes: economic development level and date of first ICT in education strategic plan; significant variation across strategic plans; and funding.

### 2.1. Economic Development Level and Date of First ICT in Education Strategic Plan

As noted earlier, the first and second waves of ICT planning have different emphases, with the first wave focusing investment in hardware and upskilling teachers, and the second wave while continuing to address hardware and teacher skills devote more attention to the integration of learning technologies into the daily fabric of the curriculum. It is immediately clear that a country’s economic development level has a strong influence on its stage of educational ICT planning, and thereby the content of national e-learning discourse at any given point in time. Taking Gross National Income (GNI) per capita as an index of economic development level, Table 2 shows an obvious trend that more economically developed countries developed a national educational ICT plan at an earlier time. The countries that have a GNI per capita higher than

Table 2. Economic development level and time of ICT plan

Country	Gross National Income per Head—2000 <sup>4</sup> (\$)	Year	
		1st plan	2nd plan
U.S.A.	34,637	1996	2000
Ireland	25,066	1997	2001
U.K.	24,058	1998	2002
Singapore	22,959	1997	2002
New Zealand	13,441	1998	2002
South Korea	9782	1996	2001
Chile	4669	1999	2001
South Africa	2954	1997	2001
China	866	1998	
India	476	2000	
Bangladesh	362	2002	
Afghanistan	100	2002	

U.S. \$9000 all had the first national education ICT plans before or in the year 1998, while countries with less than U.S. \$500 GNI per head had their first national ICT plans in or after the year 2000, 2–6 years later than more developed countries.

To statistically examine this observation, a correlation analysis of economic development level and date of the first educational ICT plan publicized was conducted. The Pearson correlation coefficient is  $-0.65$  and it is significant at  $p < 0.05$  level. This result suggests that there is a strong negative correlation between the economic development level and the date the first educational ICT plan was published, which means that the more economic developed countries published their national education ICT strategic plans at significantly earlier times, while the less economic developed countries had their first national education ICT plans much later.

Table 2 also shows that developed countries also tend to have more than one national education ICT plan. As current ICT develops at a tremendous rate, the first ICT plan may be out of date in only a few years. Almost all the countries that had their first ICT plan before the year 2000 now have a second ICT plan. The United States had the first ICT plan in 1996, the second plan in 2000, and now is planning the third National Education Technology Plan (Culp, Honey, & Mandinach, 2003).

## 2.2. Significant Variation Across Strategic Plans

From our analysis given the variation in detail in national plans, the specificity of e-learning discourse varies between countries. This variation has implications for the degree of elaboration in relation to the four focal categories

in our theoretical framework. As such, ICT plans vary greatly among different countries in terms of the length, coverage, and emphasis. In terms of length, a few plans are short, with only a few pages; but some others are very long, such as the South Korea ICT plan and the USA's ICT plan. In terms of coverage, some plans are general guidelines, such as Afghanistan and New Zealand, whereas some plans have very detailed strategies, such as South Korea and India. For instance, India's ICT plan not only gives detailed technology literacy standards for students at different education levels, but also provides specific curriculum guidelines and syllabus for information technology in schools. The Bangladesh plan even further specifies that "5694 and 15,748 number of junior and secondary level institutions as well as 922 colleges, 347 professional institutes and 1462 mid level technical and vocational institutes will be brought under IT education by 2010" (Bangladesh Ministry of Science and ICT, 2002).

Furthermore, some national plans include very specific strategies for addressing local situations. For example, the Bangladesh's ICT plan contains specific strategies to improve IT in the whole country based on its current economic level. For instance, it stipulates that "[E]xpatriate Bangladeshis may arrange to buy second hand computers at either free or small cost and to distribute them to schools at their home. Bangladeshi missions at abroad may collect computers from expatriates and then send them to Bangladesh by national fleet at free of cost." (Bangladesh Ministry of Science and ICT, 2002). In addition, "[H]ighly educated and skilled teachers and trainers will be brought from abroad on contract basis to meet the present shortage of IT teachers and trainers in the initial stage." (Bangladesh Ministry of Science and ICT, 2002). Considering Bangladesh's current economic development level (GDP \$39,139 million, GNI per capita \$362, and 0.3 phones per 100 persons in 2000) and education development level (overall illiterate rate 58.7%<sup>3</sup>), these strategies are very practical and pragmatic.

The China ICT plan also contains some specific strategies that address regional differences:

The network will provide a variety of channels for learning and training programs to the general public. High-quality courses will be available at low cost on islands, grasslands and in mountainous areas. More practical technology will be provided for the farmers. Distance education facilities will also be used to transmit quality courses to the economically less developed western regions in China so as to promote educational development there.

(People's Republic of China, 1998)

An interesting comment in the Afghanistan plan, which was founded by UNDP reflects an influence from Western countries. On page 6, it states "The national ICT policy should be made in Afghanistan, by Afghans, for Afghans.

It should be consistent with Afghanistan's history, economic realities, the international context, and the country's unique cultural and social requirements." (Asia-Pacific Development Information Programme, United Nations Development Programme (UNDP-APDIP), 2002). One must wonder why a national plan would make such obvious statement if it had not been written or promoted by an outside force. Overall, the main implication of the variation in the length, elaboration and coverage in strategic plans, for us as researchers endeavoring to understand policy through close reading of key policy texts, was that it drew our attention to the important issue of policies' *strategic force*. In terms of discourse, one might characterize this in similar fashion to the socio-linguistic term *illocutionary force*, that is, the impact or potential impact of utterances on target audiences.

### **2.3. Funding**

To achieve the goals proposed in these ICT plans, funding is a key issue. However, only a few plans discuss the issue of cost of putting ICT into schools. Less than half of the national plans specify sources and amount of funds needed, among which are the U.S.A., the U.K., Bangladesh, South Korea, and Ireland. Ireland's second plan not only promises an investment of €107.92 million, but also specifies how much will be spent on what, whom, and at what school level. On the other hand, South Africa and China point out possible sources of funding but do not specify the amount. The funding issue is completely omitted in other countries' ICT plans (Singapore, New Zealand, South Korea, India, and Afghanistan).

## **3. DEFINITIONS E-LEARNING: PORTRAYAL OF GOALS, TECHNOLOGY, STUDENTS, AND TEACHERS IN NATIONAL EDUCATIONAL TECHNOLOGY PLANS**

### **3.1. Portrayal of Educational Goals**

As previously discussed, we examined the goals the 13 national educational ICT plans purported to achieve through ICT in schools. That is, how national educational ICT plans justify the importance of ICT.

### **3.2. Economic Competitiveness**

Using technology to improve a nation's economic competitiveness in a globalizing marketplace is the most salient rationale across the national educational ICT plans. Without exception, the plans all argue that the rapid development of information technology is changing the world into a global village where the competition of economy among countries is more and more a competition of knowledge and technology is viewed as a powerful tool in improving the

country's competency in a global economy. Thus improving education with technology is not only essential to each citizen, but also critical to the nation's global competitiveness. The strong belief that the integration of ICT into education system is crucial to their economy and their country is ubiquitous. For instance, the first national ICT plan of the United States claims:

Our economy is characterized by rapidly changing technologies and increasing international economic competition. And, our society is complex, diverse, and mobile. Success as a nation will depend substantially on our students' ability to acquire the skills and knowledge necessary for high-technology work and informed citizenship.

(U.S. Department of Education, 1996)

Similarly, Singapore claims that technology integration in education aims at "anticipating the needs of the 21st century and producing a workforce of excellence." (Singapore Ministry of Education, 1997). In a similar vein, the South Korea plan further points out:

The future image of Korea in the new vision is that Korea plays a leading role in the world as a knowledge-based strong country. For the realization of this vision, the promotion of ICT use in education plays an essential role.

(South Korea Ministry of Education and Human Resources Development, 2001: 79)

Socio-economic development has a paramount priority for every country, but may be even more crucial to developing countries, who view the use of technology as one potential turning point in improving their global economic competitiveness. For example, Bangladesh is determined to use ICT as the key-driving element for socio-economic development. As a country with the largest population in the world, China is committed to "a new round of educational innovations which aims to change the tremendous population pressure into highly productive human resources," (People's Republic of China, 1998), and ICT is said to play a critically important role in this process.

ICT is also promoted with the fear of possible risks of not being able to catch up with other countries in using ICT. These risks are emphasized and specified in some plans. For instance, the first ICT plan of the United States asks this question: "Can schools afford the investment? The real question is, can they afford not to make the investment?" (U.S. Department of Education, 1996). In a similar fashion, South Korea also points out the potential risks of not being able to make full use of current ICT in education:

If an individual, company, or state does not keep up with the changing paradigm, it may fall behind with the times, miss the mainstream of the age, and lose global competitiveness.

### 3.3. Democratic and Human Development Goals

*“The potential of the Information Age seems overshadowed at every turn by the ancient forces that separate the rich from the poor”.*

(Dertouzos commenting on the role of ICTs in the developing world, 2002, p. 204)

Another possible goal of education is the preparation of democratic citizenship and the full development of individuals who can competently participate in democratic societies and live a happy life. Although many ICT plans do include some discussions about the potential of technology in equalizing educational opportunities, few justify the investment with arguments that ICT may better prepare and promote self-development, as exemplified by the following statement of the U.S. ICT plan:

Properly used, technology increases students’ learning opportunities, motivation, and achievement; it helps students to acquire skills that are rapidly becoming essential in the workplace; and it breaks the barriers of time and place, enabling students in any community, no matter how remote or impoverished, to have access to high-quality instruction.

(U.S. Department of Education, 1996)

Ironically, technology itself has become a major source of inequity, as Sayers (1996), among others (e.g., Sutton, 1991) pointed out, “equity in access to educational resources faces new challenges in our age of rapid technological change, threatening to produce a society of information “haves” and “have-nots” through schools where disparity in access to educational technology is already glaring” (Sayers, 1996). Instead of equalizing educational opportunities, technology may actually exacerbate the inequities it is supposed to remove because schools in affluent communities have the resources and expertise to provide efficient access to ICT while their counterparts in impoverished communities have neither. This is now known as the “digital divide”.

Most national technology plans recognize this “digital divide” and maintain that equal access to information and computer technology should be provided to all citizens, whoever they are and wherever they are (Fitzpatrick & Conway, 2005). Thus, providing equal access has become a goal of itself. Afghanistan stands out among these countries because of its extraordinary stress on democratic goals. While the plan claims that “ICT will become the medium that will provide Afghans in all parts of the country the opportunity to acquire knowledge and skills”, the plan states, “[T]he government has declared that it is a fundamental right of all citizens to have access to diverse means of communication” (p. 7) A few plans specifically address the gender inequalities. For instance, the Afghan ICT plan loudly argues that “special attention must be paid to gender to ensure that specific programmes are directed



to enhancing the capabilities of girls and women” (p. 8). The ICT plan of India addresses this issue with specific instructional strategies that may be adopted by teachers to make IT-based activities in the school “free from gender bias”.

### 3.4. Summary of Portrayal of Educational Goals

The examination of the educational goals promoted by national technology plans of 13 countries reveals a number of interesting patterns. First, current economic development level has certain influence on setting educational goals in ICT plans. Countries at different economic development levels have the same goals—to improve economic competitiveness through integrating ICT in education. For more developed countries, the goal is to maintain their current advantages in global economy. For example, the ICT plans of the United States stress “the importance of technology innovation to maintaining the economic and political dominance of the United States” (Culp et al., 2003), and the New Zealand ICT plan aims to “continue to interact at a global level”. While developing countries focus more on improving their national status in global economy competition. For instance, one of the economic goals of Bangladesh is to “emerge as a major software exporting country”. However, an important caveat in formulating a conception of links between education generally, and ICTs in particular, and economic development is, as Fägerlind and Saha (1989) have argued, that “. . . it clearly cannot be assumed that the link between education and economic growth is a direct and linear one, or that it operates in the same manner for every kind of society” (p. 80).

Second, less developed countries are under pressure to catch up with more developed countries. In the global context, countries, especially less developed countries, seem to have a “peer pressure” in integrating ICT to improve education and economical competitiveness. Therefore, one major force for integrating technologies in schools and having a national ICT plans is the pressure to catch up with countries that already have ICT plans. For example, China cited the ICT and economy development in India and United States. Citing India is because China and India are at similar levels of economic development level and thus are comparable and convincing, while citing the example of United States is somewhat setting a goal for economical development. Bangladesh clearly expresses the influence from other countries: “The developed countries have achieved a high standard of living by effectively using IT as a tool for the growth of their national economy. Upon observing the success history of some neighbour countries, Bangladesh Government has declared IT as a thrust sector.” (Bangladesh Ministry of Science and ICT, 2002). This pressure can be a double-edged sword for developing countries. On the one hand, the acknowledged difference motivates developing countries to make great efforts to catch up with more developed countries. On the other hand, the pressure may also lead developing countries to set ICT goals that are too optimistic to realize based on their current economic development.

Third, a utilitarian attitude toward using ICT is pervasive in all plans. By emphasizing the economic benefits of using ICT, all plans take a utilitarian attitude toward technology integrations in schools. The main goal for integrating technology in schools is to improve the performance of school children and thus enhance the country's competency in a global economy. This view ignores the development of human beings and how the use of technology influences the overall development of students.

Lastly, these findings are similar to those of the analysis of the state technology plans in the U.S.A., which shows that the U.S. state plans clearly favor the economic aspects of education. All plans are very concerned about the prospect that new technologies are changing the job market, placing new demands on future employers in the preparation of a productive and adaptive employee pool or technological workforce (Tyack & Cuban, 1997). Although many plans mention providing equal access along with preparing students for the 21st century, the goal of democratic equality is seldom elaborated as concretely as the goal of economic competitiveness. Nor is it anchored in as many implementation activities as economic competitiveness.

### **3.5. Portrayal of Technology**

Technology is a very ill-defined term. Just in terms of hardware, it can mean anything from pencils to microscopes, from television to DVD players, from hand-held devices to networked multimedia computers. A technology plan needs to specify or at least project an image of what technolog(ies) is under discussion.

### **3.6. What is Technology?**

#### *3.6.1. Technology as Network*

The dominant image of technology in the ICT plans is computers, especially networked computers. The internet is probably the most visible ICT innovation of the past 10 years and has attracted the most attention. Pelgrum (2001) points out that many governments have formulated explicit plans to equip schools with access to the internet before or shortly after the year 2000. This observation is well evidenced by the prominence assigned to the internet in all the ICT plans examined in this study.

For example, the Afghanistan ICT plan calls for an “interconnected and interoperable network of networks”. The U.S.A.'s Telecommunications Act of 1996 “will help ensure that every child in every classroom in the U.S.A. will be connected to the information superhighway—opening up worlds of knowledge and opportunities”. Singapore's first Master Plan envisages the internet is “becoming a key content and learning resource in schools with

its increasingly vast amount of information relevant to education”. And the second plan is to “connect all schools, colleges, universities, public libraries and as many community centres as possible to the Grid [via the internet].” Ireland’s second plan envisions that “[A] digital network for schools will be developed to provide broadband access to all schools and access to research networks.”

To achieve these goals, providing internet access is one of the main objectives of most ICT plans. The New Zealand government has initiated a project to deliver high-speed internet access (aka broadband) to all schools and to most provincial communities. South Korea revised its comprehensive plan for ICT in education to increase the budget input for LAN installation, PC distribution to teachers and classrooms, and financial aid for internet access in the schools. Similar suggestions are also made in other ICT plans.

### 3.6.2. *Stand-Alone Technologies*

However, technology, even ICT, is not only the networked computer. Many other technologies also hold great educational potentials. Unfortunately only a few countries’ ICT plans reflect this trend by including some other types of technologies such as video, television, telephone, tape recorders, cellular phone, etc. For instance, South Africa ICT plan gives a detailed and comprehensive definition to technology-ICT:

ICT encompasses all forms of electronic communication in both digital and analogue form. Digital electronic devices include computers, CD players, cellular telephony and satellite broadcasting. Analogue devices are largely confined to conventional radio broadcast technology and audio, such as tape recorders. Bandwidth, the volume of data that can flow through a communication channel, is constantly increasing. In addition, there are more and more ways of accessing this data. Due to this increased bandwidth and the different forms of connectivity, the various technologies are converging into the broad field of information and communications technology (ICT).

(South Africa Department of Education and  
Department of Communications, 2001)

Similarly, South Korea also includes technologies other than computers, such as TV, VCR, visual presenter, overhead projector and screen, printer, encoder, decoder, and so on. New Zealand’s ICT plan differentiates IT and CT. It defines IT as the kind of technologies that “allow us to access, retrieve, store, organize, manipulate, and present information by electronic means” and it includes personal computers, scanners, digital camera, and software; and CT as the kind of technologies that can seek and access information, such as

phones, faxes, modems, and computers. Calculation tools such as calculators and graphics calculators are also cited as learning tools.

In analyzing these plans, we also noticed a utopian tone, an unqualified extremely optimistic view of technology. Without exception, all technology plans operate as if technology will cure all educational ills. Technology is believed to be able to greatly facilitate education reforms, improve student achievement, and thus solve social problems and achieve democracy and economic competency. In the ICT plans we have reviewed, technology is often associated with such phrases as “key-driven element”, “essential”, “crucial”, and thus is given a “high priority” or “the highest priority”. The U.K. ICT plan believes that technology can “enrich and enhance all aspects of schooling—teaching, learning, management, and administration”. The U.S.A.’s ICT plan expresses a strong faith in technology’s power in solving education problem: “Properly used, technology can enhance the achievement of all students, increase families’ involvement in their children’s schooling, improve teachers’ skills and knowledge, and improve school administration and management.” In one U.S.A. school superintendent’s eyes, technology is “the paper, pencils, encyclopaedia, dictionary, thesaurus, textbook, and library all rolled into one.” (U.S. Department of Education, 1996).

In a similar way, the New Zealand ICT plan also portrays technology as an improvement of existing practice, or a solution to all problems in education system: teaching, learning, and school administration. It believes that ICT can provide opportunities for authentic, independent, and collaborative learning, provide access to a wide range of changing and developing information sources, enable active participation and the application of knowledge in authentic contexts, enable learners to be more focused on inquiry, problem solving, synthesis, and other higher order thinking skills, and provide opportunities to focus on the acquisition and use of information skills.

All countries embrace ICT with high expectations and great enthusiasm. Few of them mention the possible limitations of technology. One exception is the American’s first ICT plan, which, in a few occasions, points out that technology needs to be “properly used” to enhance the achievement of all students. It also goes a step further to point out:

Technology, in and of itself, is not a magic wand. Technology is not going to fix the problems associated with schooling, but, at the same time, the problems that plague our educational system are not going to be remedied without the presence of technology.

(U.S. Department of Education, 1996)

The development of new technology will bring along new and unanticipated problems, such as the violation of intellectual property rights, distribution of inappropriate information, and hacking. A few countries realize the possible undesirable outcomes of ICT use and thus discuss how to deal with these

possible problems. The Afghanistan plan points out that ICT networks will multiply the flow of information and the related privacy and security challenges must be addressed, and the principles of privacy protection may need to be enshrined in legislation. India's ICT plan stresses social and ethical issues in ICT use to students at different levels. Ireland's second plan points out the internet safety and security is of "paramount importance" and students' safety is a priority. As an exception, South Korea's ICT plan discusses this issue in great details:

But the increase of access to cyber space also increases the chances for undesirable outcomes. Vulgar words and insulting language are used in communication by abusing the anonymity of cyber space. The access to pornographic and violent sites is increasing. Criminal activities such as hacking, computer virus circulation, prostitution, and sexual violence are also promoted through interaction in cyber space.

(South Korea Ministry of Education and Human Resources Development, 2001: 73)

To promote a sound cyber culture among the youth, South Korea's ICT plan suggests three strategies: (1) reinforcement of ICT ethics education, (2) expansion of sound cyber culture, and (3) construction of harmful information filtering system; information and communication security for educational information system.

### **3.7. Summary of Portrayal of Technology**

To summarize, we found that the portrayal of technology in the 13 national ICT plans seem to have the following characteristics: reliance on newest technology as the default definition of technology; a utopian view of the potential of ICTs; myopic in relation to the long-term impact of technological innovations; and focus on "hard" aspects of ICT, that is, hardware and structure, rather than the "softer" aspects such as teacher development and school culture.

First, the ICT plans all tend to favor the newest technology. Education reforms are fickle. They always embrace the newest technology innovations with great enthusiasm and try to replace the relative older ones that were newest innovations and also advocated with passion a while ago. Favoring newest technology may have some advantages. However, since it usually takes a long time for any technology innovation to enter schools and even longer to be integrated into teaching and learning, chasing the newest technology may deprive teachers and students the opportunity of exploring, getting familiar with, and making meaningful use of available technologies. Therefore, it is important for schools to settle down with appropriate technologies and to take time to really integrate technologies into their current curriculum. Furthermore, as current technology continues to advance at a tremendous rate, it is

increasingly difficult for schools to “catch up with the moving train.” (Becker, 1998). This problem is even more serious for countries with limited resources. The most important thing should be to find the most effective and efficient technologies, but not necessarily the newest technologies.

Second, the utopian view of technology is pervasive in the plans. ICT is viewed as a silver bullet that cannot only fundamentally improve or change education, but also solve social problems. All ICT plans express high expectations on technology and great enthusiasm in technology integration in schools. However, we may need a more realistic view on technology. Technology is just another set of tools. “Properly used”, it may improve the effectiveness and efficiency of teaching and learning, but it is very unlikely to fundamentally change education. Research has found that technologies are usually used to facilitate existing practice instead of fundamentally change it (Cuban, 1986: 385; Schofield, 1995: 104). A utopian view of technology can easily lead to setting unrealistic educational goals that are actually a burden instead of a blueprint for schools.

Third, the plans seem to ignore possible problems accompanying technology use. Dominated by a utopian view of and ardent enthusiasm on technology, the technology plans rarely question or even raise cautions about the potential negative consequences associated with technology, although we know that “there is no good without evil”. Technology or any innovation for this matter certainly brings challenges to current and traditional values and practices. The rapid spread of ICT has already resulted in new social, ethical, and moral dilemmas. Additionally, the introduction of technology in schools is likely to force changes upon teachers, students, and the school as a whole. A thoughtful technology plan should raise awareness of these issues and propose strategies to minimize potential negative outcomes.

Lastly, many ICT plans primarily focus on establishing a technology infrastructure, ignoring the “soft aspects” of technology, including the knowledge and expertise to use it properly, although experiences have taught us that the claimed educational potentials of technology cannot be realized without adequate enabling conditions (Zhao et al., 2002). Only a few of them recognize that “physical access to hardware and internet connectivity is only one dimension of true technology accessibility, access to relevant and appropriate content, to adequate support and training and the ability to make use of technology to both create and consume information and ideas.” (U.S. Department of Education, 2003).

Comparing the results of Zhao and Conway’s analysis of 15 U.S. state ICT plans with the results of the current analysis found striking similarities between the two despite the different contexts of the individual nations. In the U.S. state ICT plans, technology is portrayed overwhelmingly as a communicative and networking tool, and is touted as an all-purpose, flexible tool that can be used in all educational contexts to support all types of learning. This view is shared by the national technology plans of all 13 nations in that

technology is generally viewed as the most current technologies, especially connected the computers and the World Wide Web. Furthermore, all technology plans present technology as a powerful potential fix for current and future educational problems, representing a very strong technological utopian tendency. Moreover, technology is often presented in a rather simplistic, naïvely optimistic fashion. And finally, most ICT plans leave out and devalue the more cautious views of technology.

### **3.8. Portrayal of Students**

Views of the nature of the learner and learning are another defining element of education. Thus an examination of how students are portrayed in national technology plans helps illuminate the political definition of e-learning. Generally a student can be viewed as either a passive learner, a recipient of knowledge, or an active constructor of knowledge, and the latter can be further qualified as solo constructor, the Piagetian little scientist who actively constructs by himself or as knowledge constructor through social interactions. An important finding is that about one-third of the plans do not include a discussion about the nature of the learner, which is surprising in that an educational blueprint does not talk about the learner.

Among the ICT plans that discuss students, none of them portrays students as passive learners. On the contrary, students are believed to be active, quick, competent, and confident learners. For example, The New Zealand plan describes students in the new environment this way: “Students often approach ICT with excitement and curiosity, learning to use them quickly, competently, and with confidence.” (New Zealand Ministry of Education, 2002). South Korea’s ICT plan makes it clear that technology will transform the passive learner into an active one with the statement that “The student is no longer a passive recipient of knowledge.” Accordingly, the school environment should “support activities where students change from passive recipients of knowledge to being active investigators” (South Korea Ministry of Education and Human Resources Development, 2001).

Another obvious tendency is the belief that technology enables students to be both independent and co-operative learners. This is exemplified clearly in Singapore’s first Master Plan: “Pupils will develop competencies in accessing, analysing and applying information, and develop habits of independent learning. IT-based learning strategies will also seek to develop pupils’ ability to think innovatively, to cooperate with one another and to make sound value judgments.” (Singapore Ministry of Education, 1997).

However, views of students vary along the dimension of solo and social constructor of knowledge in different countries. While some ICT plans emphasize more on students’ ability of being “co-operative”, others focus more on that of being “independent”. In some ICT plans, students are expected to

actively learn, construct knowledge and to collaborate, co-operate and interact with peers and teachers. For instance, the India ICT plan states: “Students will collaborate, publish and interact with peers, experts and others using communication technology.” (India NCERT, 2000). Similarly, the U.S. ICT plan claims that through information technology, students “can communicate their results and conclusions in a variety of media to their teacher, students in the next classroom, or students around the world.” The New Zealand ICT plan believes that ICT can “enable students and teachers to communicate and transfer data cheaply and rapidly worldwide.” (New Zealand Ministry of Education, 2002). In addition, “the internet can provide a window to the world by allowing users to interact with students from other schools, both nationally and internationally.” (New Zealand Ministry of Education, 2002).

On the other hand, some plans seem to emphasize the power of technology to cultivate creative and independent thinking, and prepare lifelong learners for the world of work. For example, although the Singapore Master Plan points out that students shall be both independent and co-operative, it emphasizes more on fostering “independent learning” and helping students become “more independent learners” (Singapore Ministry of Education, 1997). The U.K. ICT plan expects student to: “Be able to confidently take ownership of their learning,” (U.K. Department for Education and Skills, 1998), while the South Korea ICT plan advocates that education should “enhance students” ability to carry out self-directed learning.” (South Korea Ministry of Education and Human Resources Development, 2001).

### **3.9. Summary of Portrayal of Students**

A look across the portrayals of students across the 13 ICT plans reveals some general patterns of differences and commonalities:

First, the learner is overwhelmingly viewed as an active inquirer in the new environment where technology is supposed to play a major role. This view is used in two ways to justify the investment in technology: (a) because students, as active learners, demand a better learning environment that supports active inquiry as a form of learning and (b) technology can transform passive learners into active inquirers. The omnipresence of this view in technology plans across the world is also indicative of the successful penetration of modern learning theories into the political construction of a new education environment.

Second, nations do seem to differ in their views of how the students construct knowledge. Nations with an Eastern cultural and philosophical tradition, such as China, Singapore, and South Korea, tend to portray students as solo learners, while Western countries such as the U.S. and New Zealand are more likely to portray students as social learners.

Third, many national ICT plans also stress the importance of lifelong learning by promoting the idea that technology can prepare and support individuals



as lifelong learners. On the one hand, the ICT plans argue that information technology is changing the world so rapidly that individuals need to be constantly learning in order to participate in this forever changing society. On the other hand, ICT provides the means to make lifelong learning possible.

Finally, the analysis of the state ICT plan in the U.S. (Zhao & Conway, 2001) demonstrated that the state technology plans adopted outcome-oriented views of students. This emphasis is not shared by many of the national plans. In addition, although the technology plans seem to favor modern educational concepts (e.g., co-operative learning, active learning, interdisciplinary learning), few plans directly address any of the important epistemological assumptions about student learning. The technology plans were notably sparse in their description of the learning process or epistemological assumptions whereas technology or teacher professional development issues were outlined in detail in one or more chapters or sections. In this respect, the state ICT plans are similar to the national plans. In other words, the ICT plans, which are supposed to be blueprints to ICT-enabled education, fail to lay out the specific psychological and cognitive mechanism that enable ICT to improve learning.

### **3.10. Portrayal of the Teacher**

Teachers are a key component of any learning environment. All national plans recognize the critical role of the teacher, as the first U.S. educational technology plan puts it: “Indeed, without trained and experienced teachers, we know that computer equipment sits idle in classrooms, unused. . . . And we know that without high-quality software and well-trained teachers, computers alone do not help students meet challenging academic standards.” (U.S. Department of Education, 1996).

But this critical role in relation to technology can be viewed quite differently, from the ultimate resister—the Luddite to the enthusiastic embracer (Conway & Zhao, 2003a). None of the countries portray teachers as Luddites. Most ICT plans (91.7%) portray teachers as gatekeepers, and only a few countries (33.3%) hope teachers can also be designers.

### **3.11. Teacher as Gatekeeper**

The dominant image of teachers is that of a gatekeeper. Almost all the countries believe teachers are the key to the effective use of IT to enhance teaching and learning. Teachers are assumed to be able to use technology in their curricula and lead students to utilize technology, and professional development is key to effective technology integration and to increased student learning. Thus teaching training has an important place in most ICT plans. Teachers are encouraged and trained to use multimedia educational

materials and the internet in classrooms. For example, India requires all teachers be able to handle technology and integrate it into the teaching learning process.

To encourage teachers to open their classroom doors to technology, some countries have developed detailed plans to train teachers. For instance, to motivate teachers to learn and use ICT in their classrooms, South Korea has developed several programs to evaluate and certify teachers, such as the Information Ability Evaluation program, which encourages teachers to develop interest in ICT utilization and increase their use of ICT in carrying out their duties. South Korea ICT plan divides the training of teachers for ICT use into the training of prospective teachers and the training of in-service teachers, and specifies how and where to train pre-service and in-service teachers. Singapore's second ICT plan recognizes teachers at different technology proficiency levels, and provides a model that addresses the varied needs of teachers of different competency and job needs, so that teachers can be better trained according to their current technology proficiency levels.

### **3.12. Teacher as Designer**

A few countries hope teachers not only to be able to let ICT into their classrooms, but also to be able to creatively use technology based on their curricula and their students' needs, and to design educational materials in their own fields. South Korea stresses teacher's role as a designer. To encourage teacher's creativity in utilizing technology, South Korea holds software contests. At the beginning (1992), these contests were held just to improve teachers' computer literacy, which was consistent with the early requirement of teachers as a gatekeeper. Now the contests are held to encourage teachers to develop educational software and educational materials relevant to teaching activities in their field and to enhance teachers' interest in ICT use. Singapore's second ICT plan provides a platform for capable teachers to design and develop their own IT-based lessons or resources.

### **3.13. Teacher as Helper/Facilitator—Teachers' Role in Teaching with ICT**

With the rapid development of information and computer technology and its increasing integrating into education system, the role of teachers has been changing to take the opportunities and meet the challenges that ICT has brought about. Some countries also emphasize teacher's role as a helper and facilitator in students learning with technologies. For example, the South Korea plan requires teachers to be prepared to give assistance whenever learners need help. Furthermore, the India plan requires teachers to play a twofold role:

First, she is an active facilitator of children's learning processes, including those away from the computer. Secondly, she is the student's best guide on when, how and which IT tool may enhance learning.

(India NCERT, 2000)

### 3.14. Summary of Portrayal of the Teacher

In summary, we found that all ICT plans tend to view teachers mainly as gatekeepers, someone who are critical in allowing the technology into the classroom. The underlying assumption is that technology, once allowed into the classroom can release its own miracles, thus while many of the plans acknowledge that teachers are important in technology adoption but do not go as far as to espouse the "teacher as designer view". In this view, teachers, rather than taking on the role of knowledge dispensers or just adopting existing technologies, design their own teaching environment with a variety of technological tools to facilitate knowledge construction. Accordingly, teachers, like an architect, actively engage themselves in exploring the possibilities and constraints of technologies and other materials to construct the best environment to fulfill their pedagogical expectations. Technology is no longer considered a cure-all tool, but rather a component of the pedagogical ecology. From this perspective, teachers are not only adopters or implementers of technology, but also developers, evaluators, and designers. Unfortunately only a very limited number of plans adopt this view and identify ways in which teachers can be resourceful, knowledgeable, and purposeful designers of educational technology.

The national plans are very similar with the state plans in the U.S., which portray teachers mainly as gatekeepers or adopters. The view of teachers as gatekeepers often leads to a type of professional training that is expected to convince the teachers to open their doors to technology and teach them appropriate ways of technology integration.

### CONCLUSION

We set out to understand the political definitions of e-learning by examining how national educational technology plans view educational goals, technology, students, and teachers. We had hoped that different nations, given their own political, economical, and cultural differences, would have significant different views. However, the analysis proved otherwise. In essence, although national ICT plans vary greatly in their length, coverage, and some specific emphasis, generally speaking, they have the same utilitarian educational goals in technology integration in schools, similarly ardent enthusiasm and utopian expectation in technology, and the same images toward students as active

learners and teachers as gatekeepers of technology use. Despite some minor differences on some specific goals and approaches, basically we hear one voice on the educational goals, views of technology, students and teachers from thirteen countries with different economic development levels, diverse culture and education traditions, and various political systems.

This monolithic definition of technology-supported education is also very similar with that in the state technology plans in the U.S. analyzed by Zhao and Conway (2001). The technology plans studied by Zhao and Conway (2001) are from 15 states in the United States. Although these states vary to a certain degree on aspects such as size of state, technology related funds, population, percentage of trained teachers, they do not really differ much in that they share the same culture, language, educational tradition, and economic development level and are closely connected with each other. Countries included in this study differ greatly in culture, education, political system, and especially economy. The differences among these countries are much larger than those among the 15 U.S. states. However, the differences among the national ICT plans of the 13 countries are surprisingly not necessarily greater than those of the state ICT plans.

This unusual commonality across the 13 national plans is troubling in four important ways. First, the monolithic definition of e-learning itself is problematic in that its promotion of one view of educational goals, technology, students, and teachers necessarily demote other possible, and perhaps, more viable views.

Second, what is even more problematic is how widespread this view has been. It seems that technology transcends cultural, geographical, and political boundaries (Carr-Chellman, 2005). It wipes out economical and systemic differences. The universality of a single view of technology across technology plans in 13 nations demonstrates that technology has been viewed as the master, while pedagogy the obedient slave. The lack of attention to the differences in economic and educational development in different nations and simply chasing whatever the developed nations pursue may lead to unnecessary waste of already limited resources on hi-tech gadgets that may not even be properly used in less developed nations due to the lack of enabling conditions, such as electricity, class size, teacher readiness, and school building. For example, the type of "co-operative learning" activities that promote active inquiry may not be readily implemented in schools with large class sizes. It is hard to imagine how a teacher conducts an inquiry-based class with over 80 students, which is quite common in many developing nations.

Third, this commonality also indicates the seductive power of the concept of modernization and peer pressure in the international context. It is clear that national technology plans developed earlier, mostly in developed countries, influenced those developed later by developing countries. The simplistic belief that ICT has the equalizing power may have prompted developing nations to adopt what is in the national technology plans of developed nations. While it

is not unwise to learn from or engage in policy borrowing from other nations, it surely is not advisable to ignore one's own situations because ultimately ICT has to serve the local goals, contexts, and needs.

Fourth, what is unfortunate is that while the optimistic views of technology in plans of developed nations are shared by the less developed nations, it is not clear that the less developed countries have learned or even tried to learn from the lessons developed countries have had during their implementation of their educational technology plans. Many developed nations had begun investing in educational technology many years before developing countries. They have had many unsuccessful attempts that could become a rich source of things that should not be repeated. If carefully studied, these can become of tremendous value to countries that are contemplating investing in technology. However, such learning does not seem to be taking place, judging from the national technology plans of the 13 nations.

In conclusion, this chapter has situated the proliferation of strategic planning in relation to e-learning within the wider context of globalization. We conclude with two observations that emerge when we consider important in learning from our analysis of ICT planning as case study, what Goodson (2003) refers to as *conjuncture*, that is, a world movement that sweeps around the globe seeping into the policy discourses across nations, that is, convergence in e-learning policies; and second, e-learning strategic plans as a lever for educational change. First, the development of e-learning policies reflects a wider global trend or conjuncture, over the last decade, in which education has become a policy priority among both policy makers and politicians. Many governments' expansion "into ever larger areas of education and training has run parallel to their growing enthusiasm for detailed intervention" (Wolf, 2002: xiii). As such, the development of e-learning policies can be seen within this wider context. Second, the expansion of government planning in the educational sphere across many countries has encompassed the identification and use of ICTs as policy instrument to lever change in educational systems (UNESCO, 2003). The extent to which ICTs can be used as a policy instrument depends in very significant ways on the manner in which teachers, technology, students, and educational goals are conceptualized in policy and practice.

Whether policy makers are considering a small school in sparsely populated rural regions of China or busy urban schools in Delhi, Durban, or Dublin, an increasingly strong argument is being made for ubiquitous computing. As such, the appeal of ICTs as a significant policy instrument in education is not abating, rather it is gaining increasing prominence in the corridors of power at national and international levels. Consequently, it is crucial that the conceptualization of key educational factors (teaching, students, educational goals, images of technology) reflects the complexities of particular cultures and the nuances of educational change across diverse educational systems. Returning to exhortation (noted at the beginning of this chapter) made by

Margaret Thatcher in the early 1980s that “*Information Technology is friendly: it offers a helping hand; it should be embraced. We should think of it more like ET than IT*”, we can say with some conviction that ICTs in education are now, 20 years on, being thought of more like ET than IT.

#### ENDNOTES

1. *Statistical Yearbook* (46th issue) 1999, The United Nations. New York, 2002.
2. Year when the first ICT plan was developed.
3. *Statistical Yearbook* (46 issue) 1999, United Nations. New York, 2002.
4. Data retrieved from *Statistical Yearbook*, United Nations, 2003, issue 47.

#### REFERENCES

- Afghanistan Asia-Pacific Development Information Programme, United Nations Development Programme (UNDP-APDIP). (2002). *Information and Communications Technology Policy for Afghanistan*. Retrieved July 27, 2005 from [http://www.export.gov/afghanistan/pdf/ict\\_report.pdf](http://www.export.gov/afghanistan/pdf/ict_report.pdf)
- Bangladesh Ministry of Science and ICT. (2002). *National Information & Communication Policy*. Retrieved July 27, 2005 from <http://www.bccbd.org/html/itpolicy.htm>
- Becker, H. J. (1998). Running to catch a moving train: schools and information technologies. *Theory into Practice* 37(1), 20–30.
- Carr-Chellman, A. A. (2005). *Global Perspectives on E-learning: Rhetoric and Reality*. Thousand Oaks: Sage.
- Conway, P. F. & Zhao, Y. (2003a). From ludites to gatekeepers to designers: images of teachers in political documents. In: Zhao, Y. (Ed.) *What Teachers Should Know about Technology? Perspectives and Practices*. Greenwich, CT: Information Age Press.
- Conway, P. F. & Zhao, Y. (2003b). The global reach of educational technology planning: images of students and teachers. *Paper presented at the International Study Association on Teachers and Teaching (ISATT)*, July, 2003, Leiden, Netherlands.
- Conway, P. F., Zhao, Y., & Lei, J. (2005). The global reach of educational technology Planning: fault-lines in a virtual one world. *Paper presented at the American Educational Research Association (AERA) Annual Conference*, April 11–15, 2005, Montreal, Canada.
- Cuban, L. (1986). *Teachers and Machines: The Classroom Use of Technology Since 1920*. New York and London: Teachers College, Columbia University.
- Culp, M. K., Honey, M., & Mandinach, E. (2003). *A Retrospective on Twenty Years of Education Technology Policy*. U.S. Department of Education, Office of Educational Technology.
- Dertouzos, M. (2002). *The Unfinished Revolution: How to Make Technology Work for us Instead of the Other Way Around*. New York: Harper Collins.
- Fägerlind, I. & Saha, L. J. (1989). *Education and National Development: A Comparative Perspective*. Oxford: Pergamon Press.
- Fitzpatrick, S. & Conway, P. F. (2005). Online learning and differential participation in a democratic society: Ireland as a case study. In: Carr-Chellman, A. A. (Ed.) *Global Perspectives on E-learning: Rhetoric and Reality*. Thousand Oaks: Sage.

- Goodson, I. F. (2003). Change processes and historical periods: an international perspective. In: Sugrue, C. (Ed.) *Curriculum and Ideology: Irish Experiences, International Perspectives*. Dublin: The Liffey Press.
- India National Council of Educational Research and Training (NCERT). (2000). *Curriculum Guide and Syllabus for Information Technology in Schools*. Retrieved July 27, 2005 from [http://www.ncert.nic.in/sites/publication/schoolcurriculum/it\\_curri\\_content.htm](http://www.ncert.nic.in/sites/publication/schoolcurriculum/it_curri_content.htm)
- Lincoln, Y., & Guba, E. (1985). *Naturalistic inquiry*. Newbury Park, CA: Sage Publications.
- New Zealand Ministry of Education. (2002). *Digital Horizons: Learning Through ICT*.
- Pelgrum, W. J. (2001). *Infrastructure*. In *ICT and the Emerging Paradigm for Life-long Learning: An IEA Educational Assessment of Infrastructure, Goals, and Practices in Twenty-six Countries*. International Association for the Evaluation of Educational Achievement. Amsterdam: IEA.
- People's Republic of China. (1998). *Innovation of Education for the 21st Century*. Retrieved July 27, 2005 from [http://aemm.moe.edu.sg/asp/asp\\_aemmpaper/paper/14\)\\_Innovation\\_Edun\\_China.doc](http://aemm.moe.edu.sg/asp/asp_aemmpaper/paper/14)_Innovation_Edun_China.doc)
- Robins, K., & Webster, F. (1989). *The Technical Fix: Education, Computers and Industry*. New York: St. Martin's Press.
- Sayers, D. (1995). *Educational Equity Issues in an Information Age*. Teachers College Record.
- Schofield, J. W. (1995). *Computers and Classroom Culture*. Cambridge: Cambridge University Press.
- Singapore Ministry of Education. (1997). *Masterplan for IT in Education*. Retrieved July 27, 2005 from <http://www.moe.gov.sg/edumall/mpite/index.html>
- South Africa Department of Education and Department of Communications. (2001). *Strategy for Information and Communication Technology in Education*. Retrieved July 27, 2005 from <http://education.pwv.gov.za/content/documents/292.pdf>
- South Korea Ministry of Education and Human Resources Development. (2001). *Adapting Education to the Information Age—2001—Republic of Korea*. Retrieved July 27, 2005 from [http://www.logos-net.net/ilo/150\\_base/en/init/kor\\_2.htm](http://www.logos-net.net/ilo/150_base/en/init/kor_2.htm)
- Sutton, R. (1991). Equity and computers in the schools: a decade of research. *Review of Research in Education* 61(4), 475–503.
- Tyack, D. B. & Cuban, L. (1997). *Tinkering Toward Utopia: A Century of Public School Reform*. Cambridge, MA: Harvard University Press.
- U.K. Department for Education and Skills. (1998). *Fulfilling the Potential: Transforming Teaching and Learning through ICT in Schools*. Retrieved July 27, 2005 from [http://www.teachernet.gov.uk/\\_doc/4382/ICTiS%20directions.doc](http://www.teachernet.gov.uk/_doc/4382/ICTiS%20directions.doc)
- UNESCO. (2003). *Education in and for the information society*. (UNESCO Publication for the World Summit on the Information Society: Author—Cynthia Guttman). Paris: UNESCO.
- U.S. Department of Education. (1996). *Getting America's Students Ready for the 21st Century: Meeting the Technology Literacy Challenge*. Retrieved July 27, 2005 from <http://www.netc.org/cdrom/tlc/pdf/tlc.pdf>
- Wolf, A. (2002). *Does Education Matter? Myths about Education and Economic Growth*. London: Penguin.
- Zhao, Y., Byers, J. L., Pugh, K., & Sheldon, S. (2002). Conditions for classroom technology innovations. *Teachers College Record* 104(3), 482–515.
- Zhao, Y. & Conway, P. F. (2001). What's in, what's out?: an analysis of state technology plans. *Teachers College Record*. Available on line at: <http://www.tcrecord.org/Content.asp?ContentID=10717>.

## Chapter 27: An Overview of Virtual Learning Environments in the Asia-Pacific: Provisos, Issues, and Tensions

DAVID HUNG\*, DER-THANQ CHEN†, AND ANGELA F. L. WONG\*

\*National Institute of Education, Nanyang Technological University, Singapore, [wldhung@nie.edu.sg](mailto:wldhung@nie.edu.sg); †University Centre for Teaching and Learning, University of Canterbury, New Zealand, [Victor.chen@canterbury.ac.nz](mailto:Victor.chen@canterbury.ac.nz)

### 1. INTRODUCTION

Virtual Learning Environments (VLEs) have increasingly gained momentum in the Asia-Pacific region for the past decade. The aim of this chapter is to provide the reader with a range of issues, examples, and initiatives from this region on perspectives and progress made in VLEs through Information Technology (IT). The countries represented in this chapter on VLEs include Hong Kong, Taiwan, China, Korea, Japan, Singapore, Australia, and New Zealand.

One unique perspective in the Asia-Pacific region is the localized emphasis of flexible learning in Australia and New Zealand. Even though the idea of making learning more flexible goes beyond the employment of IT in education, often, it involves technology-based solutions such as the internet. Some universities have even set up flexible learning centers to promote this philosophy. The development of flexible learning in these two countries has been around since the early 1990s. Many of the experiences that they have gained in this area can be shared with the international community.

Increasingly the countries represented within this region have been witnessing a surge with VLEs with pedagogies inherent from the West. Tensions such as learning epistemologies, cultural and language differences, ease of access and effectiveness toward learning, and other tensions are becoming evident. On the other hand, as VLEs mature, we gradually witness tensions which used to be evident become less of an issue, for example, the gradual diminishing of virtual versus real-life or face-to-face presences.

In our discussions, we attempt to draw issues and implications that are relatively common and generic across the countries represented and hopefully convey significant trends and issues in terms of learning and instruction relevant to VLEs. Although not all countries in the Asia-Pacific are represented, we felt that the current reviews as depicted in the next section would suffice in terms of reflecting the concerns of this region. The descriptions that follow may also not fully represent the initiatives and efforts in the various countries, but we believe they are sufficient to provide the reader with a sense



of the developments. We recognize that even in the midst of crafting this manuscript, changes and developments in this region are continuing. A corresponding overview of the online learning developments can be found in the special issue edited by Hung and Chen (2003).

## 2. AN OVERVIEW OF THE VLE DEVELOPMENTS IN THE ASIAN COUNTRIES

### 2.1. Hong Kong

The attempt to create VLEs in Hong Kong was first started in 1994. The Chinese University of Hong Kong established the Hong Kong Education Information Network (HKEIN) (later renamed Hong Kong School Net), which aimed at promoting internet awareness among teachers by providing local dial-up internet services (e.g., e-mail, ftp) (Hong Kong School Net, <http://www.school.net.hk/services/about.shtml>).

However, the application of VLEs in education was not (pervasively) started until late 1997. Despite this, its development has been very fast, particularly in terms of infrastructural developments, which were almost completed within 3 years.

In 1998, the Hong Kong Special Administrative Region (HKSAR) Government announced its five-year strategy plan of integrating IT into teaching and learning in the schools. In this plan, students are expected to participate in staff development resources on the internet. Teachers are expected to participate in staff development programmes to contribute to the paradigm shift from teacher-centred teaching to learner-centred learning.

(Looi, 2001: 1)

In the year 2000, the Hong Kong Cyber Campus became the Hong Kong Education City as a result of the joint effort by the Education Department of Hong Kong, the Hong Kong Cyber Campus, and the Quality Education Fund. In addition to maintaining the established dial-up connection service, the Hong Kong Education City intended to provide all schools with broadband Education Network. It also planned to help promote broadband to home systems.

The Hong Kong Education City also aimed to “become the de facto information center, resources center, and community center for teachers, students, and parents” (Hong Kong Education City, <http://www.hkedcity.net>) by developing a website that provides (1) packages produced by the Education Department; (2) resources and experiences shared by schools, teachers, and the public; (3) resources collected from the public and the internet through copyright clearing; and (4) resources published by commercial software developers and content publishers.

Schools are now all linked up with fast networks and broadband linkage to the internet. However, students need to change to the constructivist-learning paradigm that includes two principles of learning: active learning and group learning (Lin, 1999a). Active learning refers to the self-directed learning process, which is facilitated by the requirement of developing knowledge from authentic tasks presented in a realistic context (Edelson et al., 1995; Lin, 1999b). The essence of group learning is to enable frequent interaction and collaboration among students toward a common goal (Lin, 1999a). However, such changes are radical in nature and deviate sharply from the usual practices. Previous curriculum reports in Hong Kong show that teachers do not like it (Lam, 1996). On the other hand, students may also not like such changes. For example, Parr (1999), reporting students' view of the change of teacher's role when learning with computers, indicated that 63% of the respondents tended to describe such changes negatively. Students seem to prefer more structured and directed activities rather than independent work (Parr, 1999). They often encounter difficulties when given more ownership and control over the pace of learning and prefer thus to be told what they ought to do (Woodrow et al., 1996). Starting with its goodwill to promote student-centered learning, Hong Kong now seems to be encountering difficulties in putting this new paradigm into practice. Whether the impediments can be overcome in the future or it will be modified to other new paradigms, such as those suggested by recent researches (see Lee, 2002; He, 1998), will have to wait until further research results can be released.

Similarly, VLE developments in Hong Kong in the area of Higher Education are also currently facing a broad challenge in terms of shifts in technology, paradigms, and resources in learning (Vogel & Klassen, 2001). As part of Hong Kong's mandate, the universities and the Special Administrative Region share the goals of assuring that teaching, learning, and assessment take advantage of new technologies. In a practical sense, this means that student-centeredness or directed learning must become a more important component in curricular and programme design. As a result, there are various interactive learning environments being created and evaluated that extend beyond the confines of the traditional classrooms.

Due to an increasing trend toward self-accessed learning supported with multimedia instructional support, students are now challenged with the responsibility and accountability for controlling their own educational discovery process. Skills of metacognition and reflection become increasingly important. Hong Kong is also seeing increasing trends in individualized learning varied according to learning styles and individual demands; cooperative learning where a variety of structures such as cross-age and disciplinary attempts are made; partnering between institutions and communities providing information access to learning; multimedia technologies to enhance interactivity and learning; and assessment portfolios in order to trace formative progress and learning processes.

## 2.2. Taiwan

In Taiwan, the most popular educational internet program is called TANet (Taiwan Academic Network). The main purpose of TANet is to support an information infrastructure for all schools and research organizations. Thus, TANet not only provides collaborative opportunities for research, but also shares network resources for teaching and learning activities. Taiwan's MOE (Ministry of Education, 2001) and NSC (National Science Council, 2001) are the two major contributors of web-based online learning, while universities and business companies are the two major developers. In Taiwan, several web-based learning programs are popular and have positive effects for learners and instructors. Essentially, many of these learning programs concentrate more on practical usage for schools and classrooms; additionally, some of them apply learning theories onto online learning. Based on this perspective, five different orientations for web-based VLEs and online learning will be discussed. They are courseware oriented, theoretical oriented, instructional oriented, community oriented, and assessment oriented directions.

Courseware oriented VLEs refer to tools that support instructional design, delivery, and management of online courses to improve course and program quality (Huang, 2000). In Taiwan, web courseware is generally developed by business companies such as, TopLearn and WBIPSS (web-based Instructional Performance Support System). Theoretical oriented direction refers to how online learners can learn actively by constructing new knowledge based on their prior knowledge personally, socially, or in combination via the web (Chou et al., 2001; Huang, 1999; 2000; Liaw, 2000).

Instructional oriented VLEs refer to how instructors can deliver content and instruction from a distance. Chou et al. (2001) designed a networked VR system to enhance students' health science learning based on the virtual reality concept. VR can be seen as a tool to provide real-time interactivity between computers and users. Chou (1999) developed web-based instruction according to the macro and micro stages of elaboration theory. The elaboration theory provides recommended techniques for analyzing instructional content in information and knowledge domains.

In the community oriented VLEs, Sun (2000) proposed an integrated concept of online learning called ASIA (Active Learning, Simulative learning, Interactive learning, and Accumulative Learning) to create learning communities. Universities in Taiwan developed web-based online learning environments to achieve learning communities such as the Learning Gas Station (<http://content.edu.tw/>), E.nctu (<http://e.nctu.edu.tw/>), IWiLL (<http://www.iwillnow.org/left/about/whatis.asp>), and EduCities (<http://www.educities.edu.tw/>). Learning Gas Station focuses on K-12 online instructional designs. It is a meaningful learning and teaching web-based environment where teaching materials are supported. Learning Gas Station also offers enormous network resources of instructional curriculum and provides discussion

groups for teachers. As for E.nctu, it is a virtual campus aimed to integrate school resources, establish a virtual community, enrich learning requirements, meet students' individual needs, and accumulate knowledge.

Assessment oriented VLEs include flexible and friendly computer-assisted testing programs to create powerful adaptive assessment environments. These programs include Dear Cat (Distance Evaluation: A Remote Computerized Assisted Testing) (Ho, 2000), concept map testing (Chang et al., 2001; Tsai et al., 2001), and WBLP (Web-based Learning Portfolio) (Chang & Tong, 2000). Web-based concept map testing is crucial in understanding learners' motivation and anxiety of using online testing systems (Tsai et al., 2001). The function of a concept map is based on the principle that meaningful learning occurs when learners construct their knowledge hierarchically and explore the possible linkages between concepts. Concept maps present the hierarchical structure of learners' ideas with an emphasis on the relations between concepts. Based on these explanations, the concept map is not only a learning or metacognitive tool, it can also be used as an evaluation tool.

From Taiwan's perspective, in order to enrich the end users' learning experience, schools must seek more efficient and effective ways to improve learning performance and reduce costs. Essentially, the web predominantly provides information, not instruction or other pedagogical supports for learning. On its own, it is completely incapable of supporting knowledge construction, or providing a context for learning, and the kind of learning communities that schools have always nurtured. Thus, activity, interactivity, and reflection by learners are the hallmarks of any effective web-based learning environment.

From her perspective, Taiwan needs to develop its own learning theory based on its race, ethnic, and linguistic backgrounds in the near future. Traditional Chinese culture has elevated the status of instructors so much that they are often considered to be sages. For instance, Confucius has enormous influence over Chinese education for thousands of years. In traditional Chinese culture, students are accustomed to learning passively, thus they demonstrate less self-confidence in social negotiations. This scenario is refreshingly different in the internet. Online learners learn actively as they construct new knowledge based on peer negotiations. In addition, online learning is based on sharing experiences, identifying practices, and offering reciprocal support for tracking daily problems that may arise in life. Since Taiwan's educational culture is greatly different from that of the western world, it is therefore crucial to develop a learning theory for Taiwan's online and VLE learners.

### **2.3. China**

Although China has yet to resolve many issues relating to VLEs and online learning, its efforts thus far are commendable. VLEs have great potentials in this vast nation. In addition, some ongoing national projects or plans have

been introduced. In particular, a concern of the digital divide (between the ones who have and the ones do not have) was raised. Other concerns include how VLE-related pedagogical methods could extend beyond the traditional “information-giving” paradigm to more active and interactive learning environments.

Online education and virtual learning has been evolving in China since the late 1990s, especially in the fields of higher education and basic education. Many higher educational institutions in China are currently encountering a great demand on enrollment due to an increasing population of education pursuers. Online education through VLEs is believed to be a fast and economical approach in meeting this demand. In basic education, the uneven distributions of educational resources and various qualities of educational service providers (e.g., quality of teachers) among different districts in China have triggered the emergence of online virtual schools (Ma, 2001). Meanwhile, some national projects initiated by the Chinese government have stimulated the development of online education in the public school system as well.

In September 1998, the Ministry of Education (MOE) started to grant online education licenses to Tsinghua University, Beijing Post and Telecommunication University, Zhejiang University, and Hunan University as the first batch of higher educational institutions pioneering online education. In the same year, the number of students enrolled in online education affiliated with these four universities reached 9000. In 1999, the Beijing University and the Central Broadcast and Television University were added to the pioneer list. In May 2002, up to 47 universities in China have received online education licenses, and the total number of student enrollment has reached over 400,000 (Mao & Zhai, 2002). Besides public schools, there have been some 200 online virtual schools in China, which are mainly sponsored by enterprises. The total number of enrollment in these online virtual schools has reached over 600,000 (Zhang, 2002). For example, in Beijing alone, there are more than 30 online virtual schools such as the 101 Online School (<http://www.chinaedu.com/>), the Jingshan Online School (<http://www.jsedu.net/>), and the Hope Online School (<http://www.hoho.edu.cn/>).

Basically, two instructional delivery models are popularly adopted in the online higher education in China. One is the distance lecturing model, and the other is the distance self-learning model (Huang & Luo, 2002). In the distance lecturing model, an instructor gives a presentation on campus and the presentation is delivered to remote learning sites through a digital satellite or an interactive video conferencing system. Meanwhile, students at remote learning sites watch and listen to the presentation, ask questions, and get immediate feedback from the local mentors or from the remote instructors through the network. Furthermore, the distance lecturing model is accompanied with asynchronous discussions among students and/or between students and instructors. Learners can also browse learning resources, take online quizzes and submit assignments through the network. The staff in local

learning sites is responsible for technical support, practicum supervision, and assessment (e.g., administering final exam). Compared to the distance lecturing model, presentations in the distance self-learning model is not delivered in real-time to remote learning sites. Rather, the presentation is pre-recorded in CD-ROMs and then mailed to the remote learning sites or learners directly. Similarly, learners can have online discussions with their peers or instructors as well.

With the rapid growth of the internet, campus networks in schools are becoming increasingly essential and significant for public schools since they can provide the learners as well as the teachers with more flexibilities in accessing instructional resources and materials. In addition, campus networks have the potential of making the school management more efficient. Currently, more than 10,000 schools in China have established campus networks, and more schools are in the process of being wired up. To promote the development of campus networks in schools, the Chinese government has initiated several projects and invested a great amount of money. Undoubtedly, this investment will help initiate and develop campus networks in the western part of China. Furthermore, the construction and improvement of the China Education and Research Network (CERNET) also accelerate the development of campus networks. As a backbone of educational network in China, the CERNET has fast internet connections. After campus networks in schools have been set up, schools can be easily connected to the internet through the CERNET. So far, the CERNET has connected more than 160 cities, with more than 900 educational institutes and more than 8 million users. More information regarding the CERNET can be found on the web site: <http://www.net.edu.cn/>.

#### **2.4. Korea**

Korea has made tremendous progress in terms of VLEs, particularly in adult education. Although Korea is mentioned generally, the descriptions here refer to South Korea in particular. Three specific applications in VLEs and education training have been predominant: the development of single-mode virtual universities, online education in conventional universities, and web-based corporate training.

In 1998, the Korean government established a 2-year Virtual University Trial Project (VUTP), which was designed to (1) create a cost-effective virtual education system without diminishing quality; (2) develop and implement web-based or other types of distance education courses; (3) identify appropriate policies and standards for running a virtual university; and (4) share experiences during the trial period, which ended in February 2000 (Jung, 2000; Ministry of Education, 1998). Sixty-five universities and five companies have now participated in the VUTP; eight conventional universities participated independently without forming a consortium, and fifty-seven universities and

five companies have formed seven consortia. Each of the eight campus-based universities has established a virtual campus within its own university system, and each of the seven consortia has established a virtual institution outside of their member organizations. The government encouraged both partnerships among universities and the private sector and the sharing of existing resources in providing distance education to university students and adults (Jung, 1999).

All the institutions involved in the VUTP have taken on the task to expand distance education throughout the country using interactive technologies. The VUTP has stimulated new experiments with various advanced technologies such as satellite broadcasting, videoconferencing, video-on-demand, the internet and the intranet in delivering distance education. Issues of quality of distance education have been raised and explored. VUTP helped integrate distance education more firmly into the formal higher education system and upgraded the status of distance education.

During its 2-year trial period, the Ministry of Education revised the Lifelong Education Law to accept private virtual universities as part of the formal higher education system. After this period ended in the year 2000 and detailed criteria for establishing a virtual university were specified in the Law, nine “cyber-universities” approved by the Korean government started operating in March 2001. Table 1 shows the list of some virtual universities.

With the expansion of online education programs nation-wide, issues of quality have been seriously discussed and pedagogical models for distance education have been sought. In addition, ways of reducing the cost of distance education using advanced technologies without a decline in quality have been explored. Quality management systems through continuous monitoring and evaluation will help identify problems in training programs and support services and suggest possible solutions. Experience also shows that organized sessions to facilitate self-directed learning are necessary to help learners develop and strengthen competencies in managing the independent learning process at the very beginning of their study. To be an effective online education institution for working adults, open policies toward access, curriculum, methods, and learning processes have to be institutionalized. In addition, providing the appropriate legal foundation is necessary for promoting VLEs and online education in various fields. Even though VLEs are becoming more and more pervasive in the Korean society, this does not mean that all adult learners have equal ease in accessing and using VLEs in their teaching or professional development. The government or institutions should make the policy decisions on access to IT at the outset of a project if it chooses to use IT in education and training. Allowing more flexibility and openness in distance education will be key issues for distance educators and policy-makers. Partnerships with business sectors may help reduce investment costs in hardware systems (such as a computer network), recruitment of students and acquiring

Table 1. List of virtual universities

University	Areas of Specialization
World Cyber University <a href="http://www.world.ac.kr">http://www.world.ac.kr</a>	Social welfare, hotel foods, E-business, and theology
Seoul Digital University <a href="http://www.sdu.ac.kr">http://www.sdu.ac.kr</a>	Law and police administration, multimedia, and China and Japan studies
Seoul Cyber University <a href="http://www.iscu.ac.kr">http://www.iscu.ac.kr</a>	Schools of social science and information technology
SeMin Digital College <a href="http://www.kcc.ac.kr">http://www.kcc.ac.kr</a>	Hotel and convention management, English translation, and digital media
Sejong Cyber University <a href="http://www.cybersejong.ac.kr">http://www.cybersejong.ac.kr</a>	Hotel and tourism management, E-business, and cartoon animation
Open Cyber University <a href="http://www.ocu.ac.kr">http://www.ocu.ac.kr</a>	Internet management and digital contents
Kunghee Cyber University <a href="http://www.khcu.ac.kr">http://www.khcu.ac.kr</a>	Media literature, E-business, and hotel and tourism management
Korea Digital University <a href="http://www.koreadu.ac.kr">http://www.koreadu.ac.kr</a>	Digital education, digital information, media design, and practical languages
Cyber Game University <a href="http://www.cybergame.ac.kr">http://www.cybergame.ac.kr</a>	Game design, game software, game audio, and game graphics
Hanyang Cyber University <a href="http://www.hanyangcyber.ac.kr">http://www.hanyangcyber.ac.kr</a>	E-business, management information, educational contents, and digital design
Korea Cyber University <a href="http://www.kcu.or.kr">http://www.kcu.or.kr</a>	Venture management, digital multimedia design, and entertainment

of advanced technical skills. Online education institutions also need to find ways of reducing the cost per graduate by improving the graduation/course completion rate.

## 2.5. Japan

Although Japan has been focusing on VLE implementations in recent years, her educational system and culture remains largely traditional based on her age-old societal values. In 1994, some researchers and teachers realized that the internet has its potential application in the design of learning environments. Thereafter, the national school networking project was started and the internet was introduced nationwide. Following this, a number of projects were initiated, some of these are 100-school project (1995–1997), New 100-school project (1997–1999), and E-square project (1999–2002). These large projects supported and introduced various experimental research projects and collaborative learning projects.

In Japan, a large amount of investment has been made in the research and development for implementation of VLEs in Education. These technologies



have yet to make a significant impact on the education sector and schools in Japan. The following are some R&D projects:

- Fujitani and Akahori (2000) inquired about the heuristics for generating the summary of online discussions with higher validity. They developed a web-based mailing list reference application with an e-mail summary browsing function.
- As a support tool for reflective learning, Funaoi et al. (2000) developed a concept-mapping software with a function that enables individuals to reconstruct the learning process using historical data.
- Yanagisawa and Akahori (1999) examined the influence of *information* in VR environments. The results show that the representation of reality is needed for those who lack sufficient practices of special cognition in a VR environment. On the other hand, too much information on real photographed images may cause failure to acquire spatial representation. These results suggest the need for the consideration of the amount of information to be provided to the learner by the creator or the designer of the VR environment for maximizing learning effectiveness.
- Inaba and Okamoto (1995) have developed a computer coordinator on Computer-Supported Collaborative Learning (CSCL) tool with expert systems technology.
- A CALL (Computer-Assisted Language Learning) system based on natural language processing (NLP) tools was developed. The system can provide descriptive feedback to the learner based on his/her input (Yang & Akahori, 1998) using NLP tools for error analysis.
- Using a technologically driven conceptual dictionary, Arai and Akahori (1998) developed a CALL system which allows various correct answers for an input sentence. With the conceptual dictionary, the system can detect synonyms of original correct words to the questions. Using cartoon strips with contextual cues (Akahori et al., 1998), the system enables a more flexible mechanism to be put into practice.

In spite of these seemingly ambitious R&D efforts, large numbers of schools in Japan have not particularly appreciated the use of VLE and online learning. In this country, there exists a deep-rooted idealism about education, which puts a lot of emphasis on acquiring knowledge through memorization and repetition. It has not been realized until now that computers and VLE applications could be used as a partner in learning (i.e., learning *with* technology). Another obstacle to the predominant use of VLEs is that teacher educators are not convinced that such technologies could bring about a real change to the age-old educational practices. A large number of teachers only believe that the internet is useful for accessing information, i.e., knowledge-acquisition. They think about computers and the internet as tools for efficient acquisition of knowledge. But these perceptions are slowly and gradually

fading as intense influences and competition from the West arises in their society.

## 2.6. Singapore

Under the auspices of the Singapore Education Ministry's IT Master Plan, schools in Singapore have been empowered with flexibility in the experimentation of VLEs and online learning. Pioneer schools in the implementation of IT have piloted innovative ideas to the curriculum. For example, some schools have even tried ideas where students do not need to come to school and where learning could take place at home. Such implementations have not been widespread but adopted in terms of short durations. Other schools have adopted IT and online learning for communication and collaboration, particularly in facilitating the understanding of literacy. Project work has also been an emphasis and some schools are capitalizing on the technology to enhance and integrate interdisciplinary or multidisciplinary content—making learning of subject areas more meaningful for the learner. The institutes of higher education have also been pioneering newer technologies such as wireless infrastructure and some of these concepts have transformed “more traditional” set-ups. Schools are also gradually finding ways to use technology to enhance their traditional ways of working in the classrooms and beyond. Students could be actively engaged in their projects at the corridors, canteens (cyber-café), and out of classroom settings.

The following are ways in which VLE tools are used in Singapore schools: (a) as an information resource; (b) as a communicative tool; (c) as a visualization tool; (d) as a constructive tool; and (e) as a cognitive tool (Hung, 2001). Increasingly, the concepts of constructivist learning environments are being infused into the school settings and variations of problem-based learning are also being emphasized. Some of the schools in Singapore are also moving away from computer labs to decentralized learning centers and corners where students can engage in their work collaboratively using wireless technologies. In a case example, PDAs are first used as the main tool for reflection of an English language lesson and subsequently as a collaboration device where student compile all notes by transmitting their reflections to one another in a group. In yet another school, students are carrying data-loggers out into the field and capturing data and subsequently comparing it with information on the World Wide Web via the internet. Data captured by the students can also be uploaded onto the Net. Various tools were used for further manipulation, analysis, and visualization. Current forms of technology, for example, web-based tools, have been adopted in relation to curriculum and pedagogy integration.

State-of-the-art video-conferencing equipment is increasingly commonplace in schools, which allows students to participate in interactive lessons

through synchronous or asynchronous conferencing. For example, in an international collaboration project, 43 pupils in a Singapore primary school took part in video-conferencing with pupils from Chile (Ministry of Education, 2000a). The project, held in 1998, provided opportunities for students in both countries to discuss issues with their counterparts who are situated in different cultural backgrounds. Lessons can also be recorded and made available through video-on-demand to other users in Singapore, making use of the broadband facility. Schools are also experimenting with a CSCL system, known as *Knowledge Forum*<sup>TM</sup>. This collaborative learning program provides a platform for students to engage in collaborative work and discussion, and at the same time records the development of ideas and tracks student's contribution for assessment purposes.

In another example, 17 primary schools and 17 secondary schools participated in the Konet Plan project, a global environment project initiated by Japan (Ministry of Education, 2000b). In this joint research project, students collected experiment data such as the density of nitrogen oxide in the air and forwarded the findings to the coordinating site. The students subsequently engaged in online conferencing and discussions.

Seemingly, Singapore has been ranked as one of the top nations in international examinations in Science and Mathematics, not due to a constructivist pedagogy *per se*, but rather from the traditional mode through which education has been formed. For this reason, the traditional emphasis on "examination results" as a focus is still predominant in the local schools. As we have seen from the IT projects undertaken by schools, the focus of online learning is not merely on tests and examinations, but also on the quality of thinking processes in activities such as project work. Maintaining this delicate balance between achieving good performances on tests and attending to the metacognitive aspect of learning has become a major challenge for the years to come. We believe that many problems and issues remain in the implementation of online learning and VLEs in Singapore schools. The most important issue probably is how VLE tools and online learning can effectively be integrated into the school curriculum over the coming years, and how IT tools in project work can be an integral part of the school curriculum.

Because of the concern related to maintaining past academic achievements, most online projects have been carefully designed to integrate both the face-to-face and the online distance education approaches. This tight integration is probably partly due to the unique Singaporean characteristics of a city country. There are virtually no suburban areas in Singapore. With the convenience of the mass rapid transport system, schools are physically and readily accessible by all. When learning goes online, there must be an imperative reason! In Singapore, integrating the face-to-face and online learning approaches seems to be taken as a given. Both face-to-face and online learning approaches warrant certain merits and the advantages of each approach should be maximized for the effectiveness of learning. The social interactions involved in face-to-face

settings are different from that of online environments, whereas online learning facilitates interactions with certain individuals and experts that may be unavailable locally or in the immediate physical context.

With Singapore's advancement of VLE-integration in the working force and its tight integration of face-to-face and online approaches to learning, there is a unique opportunity for Singapore to experiment with the participatory approach to online learning. Such an experience may only be feasible in small countries, which are flexible enough to make drastic changes at the national level.

## 2.7. Australia

VLEs can be perceived as one of the ways of making learning more accessible and flexible. However, flexible learning—where the issues of learning are emphasized—should be perceived as one of the ways of making learning more effective. A commonly accepted emphasis in Australia in recent years is flexible learning. The notion of flexible learning goes beyond how technology can facilitate the learning process, the reader will recognize in the discussions below that VLEs and flexible learning are intimately related. The definition of flexible learning within the context of higher education in Australia is that an institution provides students with flexible access to learning experiences in terms of at least one of the following tenets: *time, place, pace, learning style, content, assessment, and pathways* (e.g., Browne, 1999; Ling, et al., 2001; Macquarie University, 2001). This definition is based on the view that learning requires the active engagement of students where they should be more independent and responsible for their own learning. Different modes can be tailored according to the styles and learning patterns of individuals. In other words, flexible learning has the inherent assumption of being student-centered, rather than teacher-centered. Other characteristics of flexible learning include students' collaboration with peers and/or practitioners in the field, provision of ample resources, the learning experience being context sensitive, greater emphasis on generic skills (e.g., thinking, metacognitive, problem-solving), and the shift of the teacher's role from being a source of knowledge to a facilitator throughout the students' journey in learning (e.g., George & Luke, 1995; University of Sydney, 1999). In all these instances, different instructional modes are carried out where the responsibilities for learning rest on the individual students.

Flexible learning in Australia has been translated into different levels in implementation. For example, it could mainly focus on flexible delivery, which includes various types of mediated instruction including print, audio-visual, computer assisted or online delivery as well as traditional instructional formats such as lectures and tutorials (University of Wollongong, 2000). It can be considered in terms of course structure, course content, teaching and learning

methods, interactions between the teacher and the students, and assessment method (Monash University). Macquarie University (2001), Center for Flexible Learning, has adopted flexible learning as a university-wide initiative. This Center is set up in addition to the Center for Professional Development and the Center for Open Learning (the distance education “arm” of the University). Flexible styles to accommodate different kinds of learners seem to be still relatively unexplored. Some learners could prefer a more instructive approach, whereas other would have preference for constructivist methods.

Ling et al. (2001) surveyed 10 universities in Australia and identified 6 models of flexible provisions in higher education:

1. Removing fixed time and place constraints (e.g., off-campus programs utilizing print or digital tuition materials).
2. Moving time and/or place to suit the learner (e.g., provision in the workplace or regional campuses, study centers, or summer school).
3. Readjusting entry requirements (e.g., no academic entry requirement or recognize and give credit for prior learning).
4. Providing alternative entry and exit points appropriate to the learners.
5. Accommodating learning style, pace, and collaboration preferences (e.g., programs offered in full or in part in more than one mode; programs with flexible time schedules; courses that permit but do not require collaboration).
6. Accommodating content and assessment preferences (e.g., modularized content allowing choice in construction of a program; problem-based learning allowing some selection of content; alternative assessment tasks).

Most of the universities surveyed by Ling et al. (2001) are situated in rural areas and are predominantly distance education institutions or traditional campus-based universities with existing infrastructure to support the provision of education in alternative ways.

## **2.8. New Zealand**

New Zealand shares the same enthusiasm as Australia toward flexible learning but with a more cautious and conservative approach. This is probably due to its lower availability of resources. In New Zealand, it has been a concern that flexibility in many cases seems to become an end, rather than a means to the pursuit of quality learning. Chen (2003) at the University of Canterbury attempted to analyze the provisos underpinning various aspects of flexibility. Chen argued that every form of flexibility comes with provisos. For example, in order to make the time and space flexible for learning, pre-designed activities must be in order. All required reading or directions to collaborative activities must be sent to all participants prior to the commencement of

the course. The instruction must be clearly written with as little confusion as possible, in other words, an “inflexible” mode. The flexibility in changing the activity is greatly limited due to the slowness of the decision making process within the VLE environment. In other words, each form of flexibility as afforded by technologies and other provisions bring along certain advantages and constraints. Only when the provisos or pre-conditions are met can one enjoy the benefits of that particular aspect of flexibility.

Despite the scarce resources in New Zealand, VLEs have become a strategic developmental direction in recent years. A report on e-learning conducted by the E-learning Advisory Group (2002) outlined strategic plans to the Ministry. Three major recommendations are

- The establishment of a tertiary e-learning consortium comprising institutions with appropriate expertise in the area. The consortium would be funded by the government to coordinate the development of e-learning within the tertiary sector;
- The creation of a single electronic point of entry, a portal, for people to gain access to a wide range of information, services and resources offered by New Zealand’s tertiary education sector. Over time it is envisaged that students would be able to enroll, learn, be assessed and credit transfer between providers and programmes using this portal;
- The establishment of a Collaborative Development Fund (CDF) to provide capital for tertiary providers to access funds to develop their e-learning capability. (p. 5)

Based on the above recommendations, a fund of NZ\$ 47 million was set up in 2003 for collaborative projects to develop the nation’s e-learning capacity. A national e-learning portal for flexible access to its provision of e-learning portfolio was also introduced in early 2003. The website can be found at: <http://www.ted.govt.nz/index.jsp>.

Among all the e-learning initiatives, the Open Standard and Open Source movement is the underlying theme. There is a great emphasis on developing learning objects, which conform to the IMS open standard so that they can be shared within the education sectors. The open source movement is to tackle the long-term sustainability issue of any major development project. Open source invites people to use the developed system and grants people access to the source codes free of charge. People are free to develop the system further based on their needs in their respective local contexts. To prevent having too many versions of the same system (with minor differences), a consortium will then be set up to host the “authoritarian” version of the system. Only approved additions will become part of this “authoritarian” version. The long-term sustainability is therefore secured by the many participants from all over the world. The risks and the development cost are also shared by the consortium participants. This strategy is especially suitable for the New Zealand context due to the limited resources. Refer to the

Interact (a home-grown learning management system) open source site for an example of the open source approach adopted by the Christchurch College of Education. Details of the project can be found at the following website. <http://sourceforge.net/projects/cce-interact/>

Related to e-learning is the notion of reusable learning objects. Massey University in New Zealand has been explored in this direction. Research is underway to create solutions that are practical within the context of the courses delivered by Massey University. Learning resources cannot be just pulled out of a particular context and successfully implemented in another unless the content is designed to be configurable, incrementally extensible and restructurable to allow for change in the context. Three categories of context have been identified: *interaction* contexts within which the interaction between learning resources and learners takes place; *environmental* contexts that surround the design of the learning resource; and *objective* contexts that arise from the educational process concerned with explicit and implicit objectives of the teaching and assessment systems (Patel et al., 1998). A *web-course search engine* has been developed (Gong, 2002), which is a friendly, efficient and accurate helper for finding appropriate learning objects from the vast repository.

### 3. ANALYSIS AND DISCUSSION

From the overviews of VLE developments in the various Asian countries, we observed the phenomena of diminishing traditional boundaries due to VLE and online developments, and yet emerging tensions arising out of this phenomena. These tensions will be explained below.

First, it seems from the above review that due to the proliferation of the internet and other worldwide globalization efforts, the world has become much more interconnected. Increasingly, there is a blurring of eastern and western cultures as cross-cultural influences pervade. In the same vein, the development of VLEs is also undergoing a similar phenomenon. Underpinning many of the VLE developments, a similar orientation toward implicit notions of active learning and constructivism is evident, although currently VLEs are still “information pumping” methods (Tan & Hung, in press). Constructivism and social constructivism seem most popular as the emerging theoretical underpinnings in the Asia-Pacific regions. Due to such a dominant learning epistemological drive from the West, countries in Asia in particular are experiencing seeming inconsistencies and tensions in learning cultures. For example, Taiwan or Japan may need to develop a different epistemology of learning because their people are largely influenced by eastern ethnic values, which regards the didactic mode as rather appropriate. The Japanese and Singaporean representations also outline the difficulties with technological advancements in the area of education since the system has been deeply influenced by traditional models of learning and instruction. On the other hand, we may be creating yet

another legacy of learning that seems to be value-laden in terms of its benefits rather than its limitations. The tension between newer approaches (e.g., constructivism and active learning) and the traditional (e.g., didactic) is increasing because of distinctive learning paradigms. We would like to maintain that there is a place for differing paradigms of learning, including the cognitivist or even behaviorist approaches (Hung & Chen, 2000). Thus while active and constructivist learning is prevailing in VLEs, it should also be recognized that the tensions between pedagogy and andragogy (adult learning) are also fast diminishing. Today, both pedagogy and andragogy advocate active and independent explorations. Andragogy which advocates that adult learners thrive on an accepting, respecting, and helpful social atmosphere for learning is also similarly suggested for pedagogy. Perhaps, the only difference between the two schools of thought is the degree of prior knowledge and experiences children and adults bring to the learning process. In addition, related to the tensions arising from differing learning paradigms, the predominance of VLEs is breaking down traditional physical boundaries, and thus creating a virtual culture that is unique in its own right. While traditional cultures are being co-intermingled, we must necessarily be aware that societies may lose their uniqueness of cultural characteristics due to the pervasiveness of virtual network technologies. As implied in some of the countries as represented, while “walls are being broken down”, there remains value in preserving cultural heritages. Societies must have a balance between preserving its age-old cultural heritage and being influenced by other more dominant societies via the mass media and other forms of communication. Thus, on the one hand, cultural divides are gradually diminished due to virtual-communications’ technologies; on the other hand, tensions arise within societies when new influences run tangent with age-old traditions. These are issues that have not yet explicitly arisen but will become pertinent as VLEs mature.

Second, the English language dominance on the WWW has created a tension between those who understand the language and those who do not. At the same time, it does provide a standardized platform for communication. However, this tension is gradually fading with state-of-the-art language interpreting technologies. Those who do not speak English can increasingly access resources and VLEs in their native languages. Currently, there are intelligent web pages which are able to detect the preferred language of the user and to present information in that particular language. These systems are still in their infancy (the accuracy of interpretation being still the main developmental bottleneck) and implications of these developments are still largely uncertain. Ideally, these interpreting systems would diminish the language divide. However, how much implicit “faith” can one put into a machine translated document? Besides, the social acceptance is still a major concern even though an ideal translation system can eventually be developed.

Third, with access to resources and instructional materials, there is an increasing demand for content and communication delivered at the individual



learners' work-desk. In the past, training has been predominately conducted in out of the workplace context such as training schools and centers—commonly referred to as formal training settings. Increasingly, the WWW and the internet are blurring the distinctions between formal and informal training. Today's emphasis on “on-the-job” training with available resources via the internet is diminishing this virtuality divide between formal and informal training (for example, see Korea's proliferation of virtual universities). The decrease of formal training settings is congruent with the recent emphasis on authentic workplace learning because of the contextual nature of cognition (Brown & Duguid, 2000). Although authenticity of the learning context is crucial to learning, tensions arise because there are other advantages of leaving one's workplace to go to a formal face-to-face setting, for example, taking a break from one's work environment, meeting with other colleagues within a formal class setting, and perhaps other possible reasons. Thus, although companies may believe that VLEs can substantially reduce training costs, employees may miss out on other inherent and implicit benefits of the formal training setting.

Fourth, VLEs over the internet break the barrier of time and space making learning more flexible and accessible. VLEs are changing the landscape of how institutions provide learning and resources. Famous universities such as MIT are invariably and seemingly becoming much more accessible to a worldwide audience. The concern is that those who have access to technology may enjoy more advantages than those who do not. China and perhaps the South East Asian countries are still struggling to provide WWW connections to their people who are so dispersed in many remote areas. VLEs via the internet presume that technical infrastructure such as networks are in place. On the other hand, accessibility does not necessitate that individuals benefit in terms of effectiveness in learning from VLEs. In a sense, technology is presumed to be advantageous or, at least, not inhibiting to learning. It is usually connoted that VLEs are “better” than traditional forms of learning. Such a conception is to our mind too simplistic. Effective learning may not involve VLEs, and learning may also not involve networks and online or virtual means.

Fifth, we consider the issue of the “flexibility” divide which we discussed in relation to Australia and New Zealand. Highlighting one aspect of flexibility will inevitably make other aspects inflexible. Which aspect do we choose? The principle of uncertainty (in physics) seems to apply here. According to this principle, we can never be sure of the position and the velocity of an object at the same time. We either measure the position of the object and forgo the velocity or vice versa. Similarly, in flexible learning, if you want flexible time and space, you will have to compromise on the flexible content, for instance. If you want a flexible pace, you will have to forgo the ease of flexible access to resources and experts (for they are not always available). Hence, different institutions may decide to uphold a certain aspect of flexibility and down play other aspects. This kind of emphasis creates divides.

Sixth, the “standards” divide. With regards to this issue, whose open standard do programmers of VLEs follow? For example, IMS or IEEE for learning objects? HTML or XML for web pages? How do we prevent history from repeating itself? The infamous war between beta and VHS video tapes is a classic example of how “standards” divide. The term “open standard” itself is an oxymoron paradoxical. How can a standard be open since one must follow a particular standard? One is either in or out. Paradoxically, standards are always closed, are they not?

Lastly, there is the issue of open source. For open source programmes, development cost is shared, risk is shared, but maintenance may cost more (due to the programming bugs, etc.), no guaranteed longer-term development once individual institutions run out of money (support). In contrast, the off-the-shelf products have characteristics of lower maintenance, higher upfront capital commitment and is less flexible to amend the applications for local contexts, etc. These issues divide between open-source and non-open source off-the-self product applications.

In the above sections, we have discussed the trends in ICT and educational technology in the Asian countries, and predominately, the reader would recognize the fundamental epistemological stance of learning as influenced by Asian cultures. These Asian beliefs strongly influence the educational systems in the region. One fundamental difference between Asian and Western educational systems is the highly competitive stance toward achieving well in high stakes examinations. Singapore, for example, has students who have topped the international examinations in Science and Mathematics. Asian countries in particular have found efficient strategies for students to cope with traditional models of learning.

The issues of flexibility and the willingness to adopt less rigid structures in course delivery, to our minds, relate to culture and the belief of how learning occurs. Asian countries are heavily influenced by Asian cultures which may be less democratic compared with Western nations. Thus, culture has structured and organized activities around society in ways which impact upon the modes through which perceptions of schooling and learning occur.

In contrast, we commend the kinds of flexible learning efforts found in Australian and New Zealand educational systems which promote innovation. Asian countries need to embrace alternative modes of instruction and learning, allowing flexibility for an increasingly agile workforce. Educational systems, particularly those which support adult learning, must increasingly support the demands of life-long learning and less on efficient strategies for schooling. The systemic structures of less flexible learning mechanisms in countries such as Hong Kong, Taiwan, and Singapore, have resulted in beliefs that learning occurs only in schools and in formal settings. More flexible approaches instead encourage a belief that learning is life-long, and can accommodate different modes in order to fit into the varied patterns of the workforce.

The flexible learning approaches adopted by Australia and New Zealand are commendable and can be modeled by Asian countries. The principles for practicing flexible learning are sound and encourage a diversity of varied approaches to course deliveries. These principles are

1. Flexible time and place constraints to suit the learner;
2. Readjusting entry requirements to accommodate for work experiences;
3. Alternative entry and exit points appropriate to the learners;
4. Different learning style, pace, and collaboration preferences; and
5. Multiple assessment preferences for different learners.

#### 4. CONCLUSION

We have also observed that the trends within VLEs are not applied purely as a distance education mechanism. It is becoming an accepted norm that online learning need not be seen as purely virtual and should instead be used as a means when face-to-face interactions cannot be afforded. It is not the scope of this chapter to discuss the degree of face-to-face and virtual involvements. Increasingly, researchers and educators recognize that face-to-face interactions are critical to social and peer learning, and VLEs can be used to complement the interactions. Thus, the issue of either face-to-face *or* virtual learning is no longer the predominant concern, but rather how both approaches can be used appropriately and as a complement to each other. As VLEs mature in this region, users of these environments adopt them as a seamless process of their learning.

In the context of flexible learning and VLEs, educators are also now more cognizant of the kinds of limitations or provisos which are inherent in any “new” approach. As with any new introduction of technology, it requires some time before the hype “settles down” and a better sense in terms of pedagogical implications becomes evident.

Finally, new and innovative state of the art technologies such as virtual reality, special forms of customization and personalization, video-on-demand systems, and many other expert/AI applications are also making VLEs and flexible learning more readily available. Importantly, we highlighted that technologies *per se* and flexibility do not necessarily imply enhanced learning. There is an urgent need in our opinion for VLEs to be substantiated on the developments made in the learning sciences and not on the hype of e-learning as entertained by commercial enterprises.

#### REFERENCES

- Akahori, K., Yoshioka, R., Nitoguri, A., Furugohri, N., Katoh, K., & Usami, S. (1998). Web-based Japanese learning materials constructed using a comic strip database. *Proceedings of the 1998 Conference of Japan Society for Educ. Tech.*, 545–546.

- Arai, K. & Akahori, K. (1998). A Japanese learning system using YONKOMA-MANGA. *Proceedings of ICCE '98* 2, 250–253.
- Brown, J. S. & Duguid, P. (2000). *The Social Life of Information*. Cambridge, MA: Harvard Business School.
- Browne, C. (1999). *Academic Board: LTOP Working Party on Flexibility in Pedagogy Final Report*. Australia: Monash University.
- Chang, C. C. & Tong, E. H. (2000). Evaluation and effectiveness analysis of web-based learning portfolio. *Distance Education (in Chinese)*, 15/16, 98–111.
- Chang, K. E., Sung, Y. T., & Chen, S. F. (2001). Learning through computer-based concept mapping with scaffolding aid. *Journal of Computer Assisted Learning*, 17, 21–33.
- Chen, D. (2003). Uncovering the provisos behind flexible learning. *Educational Technology & Society* 6(2), 25–30.
- Chou, C. (1999). Developing hypertext-based learning courseware for computer networks: the macro and micro stages. *IEEE Transactions on Education* 42(1), 39–44.
- Chou, C., Tsai, C. C., & Tsai, H. F. (2001). Developing a networked VRML learning system for health science education in Taiwan. *International Journal of Educational Development* 21, 293–303.
- Edelson, D. C., Pea, R. D., & Gomez, L. (1995). Constructivism in the collaboratory. In: Wilson, B. G. (Ed.) *Constructivist Learning Environments: Case Studies in Instructional Design*. Englewood Cliffs, NJ: Educational Technology Publications.
- E-learning Advisory Group. (2002). *Highways and Pathways: Exploring New Zealand's E-Learning Opportunities*. New Zealand: Ministry of Education.
- Fujitani, S. & Akahori, K. (2000). A summary extraction method of e-mail discussion and its web-based application to mailing list review. *Educational Technology Research (in Japanese)* 23(1–2), 1–12.
- Funaoi, H., Yamaguchi, E., & Inagaki, S. (2000). Enhancement of a concept mapping software to reconstruct learning process: implementation of a function to present similar concept maps (in Japanese). *Proceedings of the 6th Joint Conference on Educational Technology (in Japanese)* 2, 371–372.
- George, R. & Luke, R. (1995). The critical place of information literacy in the trend towards flexible delivery in higher education context. Paper Presented at the Learning for Life Conference, Adelaide, Australia.
- Gong, X. (2002). Web-course search engine. Masters' Thesis, Information Systems Department, Massey University, Palmerston North, New Zealand.
- He, K. K. (1998). On Modern Educational Technology and Educational Revolution (in Chinese). <http://www.nrcce.com/Expert/HEKK/LunXianDaiJiaoYuJiShuYuJiaoYuShengHua.htm>.
- Ho, R. G. (2000). Distance testing and related issues. *2000 Workshop on Web-Based Learning Theory and Practice*. Hsinchu, Taiwan, 23–33.
- Huang, H. M. (1999). Discovering social and moral context in virtual educational world, ERIC IR 020879.
- Huang, H. M. (2000). Instructional technologies facilitating online courses. *Educational Technology* 40(4), 41–46.
- Hung, D. (2001). Theories of learning and computer-mediated technologies. *Educational Media International* 38(4), 281–288.
- Hung, D. & Chen, D.-T. (2000). Appropriating and negotiating knowledge: technologies for a community of learners. *Educational Technology* 40(3), 29–32.
- Hung, D. & Chen, D.-T. (2003). Online learning and information technology in the Asia-Pacific region. *Educational Technology* 43(3), 1–5.
- Inaba, A. & Okamoto, T. (1995). The network discussion supporting system embedded computer coordinator at the distributed places. *Educational Technology Research (in Japanese)* 18(1–2), 17–24.

- Jung, I. S. (1999). A report on current status of the virtual university trial project. *Internal Report*. Seoul, Korea: Korea National Open University.
- Jung, I. S. (2000). Korea's experiments with virtual education. *Technical Notes Series*, Vol. 5, No. 2. Washington, DC: World Bank Human Development Network.
- Lam, C. C. (1996). *Target Oriented Curriculum: A Dream that will not Come True* (Occasional Paper No. 1). Hong Kong: The Chinese University of Hong Kong, Hong Kong Institution of Educational Research. (In Chinese).
- Lee, F. L. (2002). Web-based learning for the Chinese community (in Chinese). *Invited Speech Given in the Global Chinese Conference on Computers in Education, 2002*, Beijing, China.
- Liaw, S. S. (2000). Virtual textbooks: features and implementation. *Educational Technology* 40(4), 37–40.
- Lin, C. S. (1999a). The Approaches in Integrating Curriculum and Internet Resource: Using Internet in the Classroom. Retrieved December 27, 2001 from <http://netshow.ntnrc.edu.tw/edtech99talk2.html>.
- Lin, C. S. (1999b). The Design and Practice of Integrated Distributed Learning Environments for Elementary School Students. Retrieved December 27, 2001 from <http://acbe.tku.edu.tw/iccai8/9/9.htm>.
- Ling, P., Arger, G., Smallwood, H., Toomey, R., Toomey, R., Kirkpatrick, D., & Barnard, I. (2001). The Effectiveness of Models of Flexible Provision of Higher Education. [http://www.dest.gov.au/highered/eippubs/eip01\\_9/default.htm](http://www.dest.gov.au/highered/eippubs/eip01_9/default.htm).
- Looi, C. K. (2001). Regional editorial: IT programmes and policies in the Asia-Pacific region. *Journal of Computer Assisted Learning* 17, 1–3.
- Ma, N. (2001). A Report of the Online Schools and Universities in China. <http://www.online-edu.org/article/article/57.html>.
- Macquarie University. (2001). Macquarie University Flexible Learning Plan 1999–2001. <http://www.cfl.mq.edu.au/cfl/flp/flp.html>.
- Mao, H. W. & Zhai, S. D. (2002). Online University Breaks the Wall of Conventional Universities. <http://www.net.edu.cn/20020328/3023693.shtml>.
- Ministry of Education (Korea). (1998). *A Report on the Virtual University Trial Project*. Korea: Bureau of Educational Technology.
- Ministry of Education (Singapore). (2000a). Educational Software Homepage. <http://www1.moe.edu.sg/chilesing/generalinfo.html>.
- Ministry of Education (Singapore). (2000b). Educational Software Homepage. [http://www1.moe.edu.sg/collaborate/global\\_environment\\_research\\_proj.htm](http://www1.moe.edu.sg/collaborate/global_environment_research_proj.htm).
- Ministry of Education (Taiwan). (2001). Ministry of Education. <http://www.edu.tw/>.
- National Science Council (Taiwan). (2001). National Science Council. <http://www.nsc.org.tw/>.
- Parr, J. M. (1999). Going to school the technological way: co-constructed classrooms and student perceptions of learning with technology. *Journal of Educational Computing Research* 20(4), 365–377.
- Patel, A., Russell, D., Kinshuk, Oppermann, R., & Rashev, R. (1998). An initial framework of contexts for designing usable intelligent tutoring system. *Information Services and Use* 18(1–2), 65–76.
- Sun, C. T. (2000). The trend and theory of web-based learning. *2000 Workshop on Web-based Learning Theory and Practice*, Hsinchu, Taiwan, 13–20.
- Tan, S. C. & Hung, D. (2002). Beyond information pumping: creating a constructivist e-learning environment. *Educational Technology*. 42(5), 48–54.
- Tsai, C. C., Lin, S. S. J., & Yuan, S. M. (2001). Students' use of web-based concept map testing and strategies for learning. *Journal of Computer Assisted Learning* 17, 72–84.
- University of Sydney. (1999). Academic Board Statement on Flexible, Student-Centred Learning in the University of Sydney. [http://www.usyd.edu.au/planning/policy/acad/265\\_flexlearn.html](http://www.usyd.edu.au/planning/policy/acad/265_flexlearn.html).

- University of Wollongong. (2000). Enterprise Agreement 2000. <http://cedir.uow.edu.au/NCODE/info/definitions.html#flexdef>.
- Vogel, D. & Klassen, J. (2001). Technology-supported learning: status, issues and trends. *Journal of Computer Assisted Learning* 17(1), 104–114.
- Woodrow, J. E. J., Mayer-Smith, J. A., & Pedretti, E. G. (1996). The impact of technology enhanced sciences instruction on pedagogical beliefs and practices. *Journal of Science Education and Technology* 5(3), 241–252.
- Yanagisawa, M. & Akahori, K. (1999). The effect of visual discontinuity on spatial cognition. *Journal of Human Interface Society (in Japanese)* 1(1), 37–44.
- Yang, J. C. & Akahori, K. (1998). Development and evaluation of Japanese CALL system for scientific and technical writing on WWW. *Proceedings of ED-MEDIA/ED-TELECOM 1998*, 1892–1893.
- Zhang, R. (2002). How to Select an Online School in China? <http://www.cnii.com.cn/20020228/ca30549.htm>

## Chapter 28: Global Online Education\*

STEVE McCARTY\*, BEGUM IBRAHIM†, BORIS SEDUNOV‡, AND  
RAMESH SHARMA§

\*Osaka Jogakuin College, Japan; †Mara Institute of Technology, Malaysia; ‡Moscow  
Institute of Business Administration, Russia; §Indira Gandhi National Open University, India

### 1. INTRODUCTION

This international team of online educators will show, true to the title of this chapter, that online education is already a global phenomenon. The World Wide Web, which affords so many educational applications friendly to designers as well as to the users, has lived up to its name by reaching nearly all countries through the internet infrastructure. Online education at first suggests education through the internet, but the “line” in online and offline refers more broadly to networked computers. By necessity in some countries, or by choice, Intranets and other systems of digital devices such as mobile phones, whether connected by ground wires or by satellites, can also serve as media for formal education and informal learning. Issues of access recurring in this chapter imply, however, a goal that all learners at least have the option of studying and communicating with other world citizens through the global internet, that is, online education in the fullest sense. (For more on what online education is, see McCarty, 2001).

Global online education represents not only a technical revolution in access to valuable information for people in developing countries, but also a paradigm shift from education to perpetuate elite classes of hereditary privilege—in all countries—to UNESCO’s motto of “education for all”—through the internet. Globalization in this chapter implies a positive diffusion of educational opportunities beyond Western or wealthy countries, so the geographical coverage focuses mostly on non-Western regions. But efforts behind the scenes and sometimes sacrifices of Westerners who collaborate internationally to create a level playing field open to all must not be taken for granted. At the same time, recognizing that globalization for purposes other than education can be harmful, online educators must proceed into this new frontier with intercultural sensitivity. [Cf. the chapter “Global Virtual Organizations for Online Educator Development” in the next chapter of this Handbook. It details how the World Association for Online Education (WAOE) promotes professional ethics in this new discipline along with enjoyable online cultural activities, not

\* Chapter Draft for the Case Studies Part III of the *International Handbook of Virtual Learning Environments*.

centered in any geographical region, serving as a distributed virtual learning environment (VLE) and an open source learning organization.]

“Global” also refers to global issues raised by the advent of online education. As just one provocative example, if equal opportunity for education were realized through the internet, would those who were born to comfort be able to compete with those who are hungry to learn? Conflicts of interest are bound to arise then at the tollgates where gatekeepers represent institutions profiting from the scarcity of access to expert educators and the economic consequences of credentialism. To substantiate this chapter, educators from around the world answer a questionnaire including globalization issues, with questions aimed to be phrased neutrally to elicit responses representative of their country or culture.

“Online education” also refers to learning methods that at least partly utilize the information and communication technologies (ICTs) available through the internet. Given the explosive growth of specialized knowledge and paradigm shifts in educational approaches, lifelong education is needed above all by educators themselves. For online educators not to replicate the classroom but to take advantage of new media, new ways to communicate, and to design educational experiences, renewed professional development for educators in virtually all fields of enquiry is also necessary. Educators are thus utilizing the internet for professional networking regionally and globally to learn from one another about the new media and their applications to education.

While the pendulum of opinion about e-learning may swing from pro to con in economically fortunate countries, the developing world entertains no such luxuries but looks to cyberspace to accomplish the empowerment by global knowledge that would otherwise continue to take too long to trickle down. To leapfrog to 21st century ICTs most effectively, many non-Western countries are developing virtual universities, particularly, through the National Open Universities little known in the West. Non-Western scholars also are among those benefiting from international networks of educators freely sharing expertise in educational technology. In a report adopted by the UN Economic Commission for Africa, Afele (2002) writes that “[d]istance learning has become essential to global development programming”. Thus, this chapter will take a geographical approach to case studies, presenting little-known initiatives of both local and international significance where the use of VLEs empowers educators.

The internet has allowed world citizens to bypass their government representatives to a great extent and to organize their own international relations. The world community of scholars with shared academic standards and ethics is particularly well positioned for networking to form global guilds and to reconstitute Academia in cyberspace. Are there any signs, though, that the new media are making a difference in the so-called real world of embodied human existence? With the topic of global online education already so vast, it will be important to focus on far-reaching questions. Moreover, in a world



still divided by barriers of hostility, it will be important to find out if there are emerging trends in social evolution whereby education through the internet helps to foster intercultural reconciliation.

The opportunity for education through the internet has reached at least some sectors of nearly all countries. Thus, to address such a broad field as online education worldwide, this chapter takes a multidimensional approach. To frame the issues and provide for cross-cultural comparisons of the likely diversity, results of a Global Online Education Questionnaire are first summarized and discussed. See the Appendix for the “horse’s mouth” data from respondents all over the world compiled for each question. Secondly, some key issues in online education particularly for the benefit of developing countries are crystallized from the works of Parker Rossman, a former Dean at Yale, on the future of universities, and Takeshi Utsumi, a telecommunication expert who founded the Global University System (GUS), illustrating the technology, funding, and networking challenges involved in implementing global online education. Thirdly, a geographical approach is taken, with in-depth case studies by the co-authors about their home regions, demonstrating how the quality of education worldwide is improving with widening access to learning opportunities online.

Co-authors drawn from the WAOE aim for wide geographical coverage to address recent developments in online education in the non-Western world and where there is North–South or East–West intercultural collaboration. Reporters from the field for this chapter are Begum Ibrahim for Southeast Asia and an Islamic perspective, Boris Sedunov for Russia and its region, Ramesh Sharma for India and South Asia, and Steve McCarty for the Pacific Rim and overall. All the authors use languages other than English and can therefore bring out information and perspectives from behind language barriers. The authors also have daily cross-cultural experience including on the Net to shed light on the diverse applications of VLEs.

Global issues such as gender, culture, language, economics, and access will be illustrated as to how they work out in local and international contexts. Local case studies such as virtual universities will illustrate how global issues in online education work out in specific cultural contexts. International collaborative projects are also explored for their intercultural significance. Global issues are also examined in different geographical regions to enable comparisons. Whether universality or divergence is found would in each instance help guide future practitioners of global online education.

## 2. GLOBAL ONLINE EDUCATION QUESTIONNAIRE: SUMMARY AND DISCUSSION

Knowledgeable scholars in various countries were surveyed in the fall of 2002 to compare the state of VLE use, effects of globalization on local cultures,

what institutions and associations for online education have emerged, and what obstacles are faced locally such as access to Net infrastructure. In the context of the mission of this Handbook, if the questions are expressed objectively enough, and if the responses are as representative as they seem, then some valuable information and comparisons can be discerned from the results.

Respondents were limited in number but represent some locations not covered elsewhere in this chapter, which aims for the broadest range of voices. The aim here was not to gather public opinions but rather professional opinions representative of various world regions, so the survey was distributed to a few international electronic discussion lists concerned with online education.

Here, the results are summarized and discussed, but the full and unmediated data in the Appendix may prove to be more interesting as well as valuable to investigators. Respondents answered for 16 countries or wider regions, viz. Latin America, Mexico, Argentina, Brazil, Finland, Israel, Turkey, Russia, India and South Asia, Kenya, South Africa, Lesotho and Southern Africa, The Philippines, Indonesia and Southeast Asia, Malaysia, and Japan. Respondents are identified in the Acknowledgments.

With a view to comparing trends in the world, the results will be summarized regionally into *Latin America* (Mexico to South America), *Finland, Israel, Turkey, Russia, South Asia* (mainly India), *Africa* (Sub-Saharan), *Southeast Asia*, and *Japan*. The diversity within each region or country as indicated by the respondents will also be described. In subsequent sections, furthermore, the co-authors provide details on online education in the former Soviet region, the Indian subcontinent, all countries in Southeast Asia, most of the Pacific Rim countries, and the Islamic world, thereby representing many more countries and cultures.

The questionnaire enquired first about the state of VLEs used for education in the respondent's region, whether the internet is used mainly by the elite and whether females are involved. Next, do local people feel that globalization effects threaten their culture, or is a broader cultural repertoire welcomed? Have other issues been widely debated such as language, democratization, equalizing of opportunity, or resistance to change by governments? Do leaders or the media see the internet as beneficial for education, international, and intercultural relations? Then, are there virtual universities or other such schools available, and if so, are they accredited, recognized, or considered notorious? Have many people considered studying at institutions in other countries through the internet? Have many local companies entered the e-learning business? Are there academic associations for the professional development of online educators? Finally, is web access an obstacle for many people, and what other issues affect the acceptance of VLEs or online education?

Respondents did not necessarily answer every question thoroughly. What follows here is a concise paraphrasing and quotation of the salient responses that shed light on the questions while being suggestive for regional comparisons. Investigators should refer to the Appendix for the complete and

definitive views of the respondents. At the end of each item below, there is a brief statement comparing the responses for global trends and variations. Then in the following subsection, there is further discussion of the results as a whole.

The first substantive question was, *What is the general state of the use of VLEs for education?* For *Latin America*, the four responses seemed to reflect different social strata. A professor formerly with the World Bank saw cultural antecedents in distance education (DE) for e-governance as well as e-learning in higher and continuing education, whereas others found ignorance among all but an educational elite. The latter is probably a more realistic view of the region as a whole, while also acknowledging progress in educational technology and attitudes thereof. In *Finland*, one of the most wired nations and well known for mobile phone technology, the concerns seem to be similar to North America, the United Kingdom, Australia, and New Zealand. That is, how to refine virtual learning possibilities with pedagogical considerations, and reconciling the different interests in education represented by commercial solutions versus open source. For *Israel*, the response was just for its Open University, with half the courses utilizing at least components of e-learning. Compared with open universities in other countries, though, Israel resembles nations advanced in VLE adoption. In *Turkey*, internet penetration was reported as 2% but growing. There is a demand for online education even before facing pedagogical concerns thereof. In *Russia*, VLEs are less developed than in the West because of poor telephone lines, few private educational institutions compared to under-funded public ones, and strong government-centered traditions. In multicultural *South Asia*, VLEs are being adopted rapidly for education in tandem with the infotech sector. In *Africa*, online education is mainly available at the university level. Many schools do not even have telephones and use of the internet does not necessarily extend beyond e-mail to the web. In *Southeast Asia*, for the Philippines, it was reported that virtual learning is popular with few institutions, mostly for the sake of profit. Indonesia is mainly at the public planning stage, whereas in Malaysia “many traditional public and private universities have some or all of their distance learning programmes available online”. In *Japan*, virtual environments are popular for socializing, but progress has been slow in realizing their educational potential. University and government bureaucracies are slow to accept change while companies struggle to find a market for e-learning amid so many consumer attractions. Technology tends to race ahead of pedagogy, but individual educators are well equipped to experiment with VLEs. The overall pattern seems to be that VLEs are used worldwide more or less, depending mainly on the level of economic development of the country. For more details see also the next question, the Appendix, and *Cultural and Regional Reports on the State of Online Education* later in this chapter.

*Is the internet used for education by a small elite in universities or elsewhere?* In *Latin America*, it is elsewhere to an extent, but not all universities

are online yet. In *Finland*, internet availability is ubiquitous. In *Israel*, it is used by all students to supplement classroom learning. In *Turkey*, a limited number of English-medium private universities use learning management systems (LMSs) like Blackboard and WebCT, but Turkish-language LMSs are needed for public universities. In *Russia*, the internet is used in almost every university to supplement F2F instruction with skills needed for future jobs. In *South Asia*, most universities are connected to the Net, with libraries in India interconnected. In *Africa*, progress has been slow, with bandwidth and online costs relatively expensive, but there are affluent universities with a high technological level, particularly in South Africa. In *Southeast Asia*, it is used in elite universities and affordable for students. In the Philippines, even the under-privileged can use the internet on a rental basis. In Indonesia, it is the elite among universities. In Malaysia, internet use is progressing in secondary and primary schools. In *Japan*, even elementary schools are well on the way to being wired, but internet use is still mostly supplemental to regular face-to-face education. The responses overall confirm that the internet is used in most but not all universities worldwide. For some regions above it could only be extrapolated how widespread internet use is beyond their universities. More details are available elsewhere in this chapter, particularly on internet use for all Southeast Asian countries.

*Are females much less involved?* In *Latin America*, centering on Mexico, it seemed to be yes, but the opposite for South America. In *Finland* and *Israel* they are equal. In *Russia*, “[f]emales in former USSR countries, except the Moslems, are much more active and free than males”. But rather than technical aspects, “they prefer to utilize completed and reliable software products”. In *South Asia*, the difference is rather between urban and rural. Urban females are equally involved. For Africa, the responses were varied: balanced in Kenya; women and girls still caught in traditional roles in South Africa, but females could be in the majority under certain demographic conditions in Lesotho and elsewhere. In *Southeast Asia*, females outnumber males as they do in the whole educational sector. In *Japan*, females are less involved with technology until it becomes very user friendly and fashionable like mobile phones. Having more free time than men, females may be more involved in online education than men in the future when they become comfortable with the Net. Most responses worldwide were contrary to stereotypes and may point to the role of educational cultures in bringing a surprising proportion of females into VLEs globally.

*How do people generally feel about globalization effects—do they feel their culture is threatened or do they welcome a broader cultural repertoire?* For *Latin America*, the Mexican respondent wrote that “[p]rofessionals feel it is a good thing provided our culture and values are maintained”. A broader cultural repertoire is welcomed except in places like Argentina where globalization has had ill effects. In *Finland*, there are no qualms except over whether VLEs are locally developed or not. In *Israel*, most people welcome a broader

cultural repertoire. In *Turkey*, “where Europe and Asia meet” there is a strong sense of history and their role as a would-be Muslim nation in the EU. “Globalisation, the result of the impact of technology and power, has its own pluses and minuses [depending upon] pluralist-participatory democracy, market economics, national and international transparency, and interactions”. In *Russia*, “Some young and progressive people welcome international relations, but [the] older generation with a former Soviet mentality in a large proportion still do not trust foreigners, especially because Russia after Perestroika was invaded by foreigners who managed to plunder and help some Russians steal huge amounts of capital. So in a way, the old communist accusations of uncontrolled and criminal capitalism have proven to be a reality. It will take a long time to replace that plunder with civilized international co-operation and to restore the lost trust in foreign businessmen and economic consultants.” In *South Asia*, “Both. Elders are concerned with the cyber-attack on their culture while young people are excited with the new medium, making global friends, finding communication much easier and at anytime.” For *Africa*, a Kenyan wrote “It is welcomed particularly by the elite. The tradition-bound [tribal people] however feel highly threatened.” In South Africa, “Civil society seems to be against globalisation, but as we are a country with 11 official languages and many cultures, we are working towards intercultural friendliness.” In the Southern African region, “From the cultural point of view, globalization is seen with some degree of resentment. But in the main, the newness of technological development [precludes] its general acceptability and utilization.” For *Southeast Asia*, in the Philippines, “People are taking globalization negatively, since . . . locally manufactured products and local companies have suffered from the WTO . . . In terms of culture the people are not actually that bothered.” In Indonesia, there are “mixed feelings about both issues, but there are also people who have no idea about the issues yet”. In Malaysia, “there is some fear of globalisation”. In *Japan*, the culture remains strong and well protected by an insular mentality and the language barrier. Most people would like to expand their options to select from the outside world without being overwhelmed by globalization or losing their cultural identity. Overall there were varied responses, for, against, or ambivalent, depending on how different sectors of each society see globalization affecting them. While everyone seems aware that it is a serious issue, non-Westerners do not seem to dismiss globalization pejoratively, such that they would shun educational opportunities from abroad made available through the internet.

*Can you describe any debates within your society about other issues such as language, democratization, equalizing of opportunity, or resistance to change by governments?* For *Latin America*, Mexican “people want democratization, justice, and the rule of law”. In Argentina, “[p]eople are more worried about ordinary, daily issues, such as social, economic changes badly needed at the moment, and education is one of the crucial issues”. In *Finland*, some issues are telecommuting, information overload, and Finnish versus English, but not

to the extent of protesting current trends. In *Israel*, debates are on religion versus secularism, the Jewish-Arab conflict, right versus left political orientation, and Eastern-origin versus Western-origin cultures. In *Turkey*, some issues are geopolitics, human resources, cultural wealth, social sub-groups, or regions versus national priorities. In *Russia*, “[t]he government supports new technologies and methods in education, but there is a drastic lack of money. However, a centralized mentality and system of education makes educators wait for governmental funding.” In *South Asia*, “[t]he Government of India is promoting infotech growth . . . The State is promoting internet kiosks in rural areas to promote education.” In *Africa*, one issue is language, such as in broadcasting . . . English is the main language of communications (among 11 languages in South Africa). Government control versus freedom of speech is also at issue. “Transformation, democratization, accessibility, equity, and gender sensitivity are the concepts now in vogue in societies here and common also in educational institutions.” For *Southeast Asia*, “Most Filipinos know that the only way to bridge the gap between rich and poor or to equalize opportunity is through education. Most families strive to send their children to higher education, which is why about 95% of Filipinos are literate. However, even after a proper education they suffer from unemployment because there are no job opportunities in the country, which is why they usually resort to working abroad . . . The government is not resistant to changes; it is just taking all these challenges in a step-by-step manner.” In *Indonesia*, some issues are “democratization, decentralization versus centralization, tolerance, and unity”. Malaysia is a multiracial society with an urban–rural digital divide. “There has been a major debate on the government decision to reintroduce English medium instruction for some primary school subjects. The new policy reflected the realization that falling behind in English proficiency could prove to be a serious disadvantage in this ICT era.” In *Japan*, there is a perennial tension between the attractions of the outside world and the unspoken prohibition against crossing over by being unlike other Japanese. Overall, language and democratization seem to be vital issues indeed, but rather than blame governments, the obstacles to a better life for citizens seem to be viewed more in economic terms.

*Do leaders or the media see using the internet as heading towards positive outcomes for education, international, and intercultural relations, or not?* For *Latin America*, no one replied in the negative, but progress is slow even in professional sectors. A Brazilian added that “E-mails are intensively used to spread news and sometimes also to send suggestions to politicians.” In *Finland*, the internet itself is well covered, but representative educational issues arousing interest are not VLE pedagogy but rather news about hackers, university costs, and “children’s use of computer games (are they good or do they make children passive?)”. In *Israel*, *South*, and *Southeast Asia*, it was an unequivocal “Yes.” In *Russia* and *Africa*, the public and educators want to use the internet but funding and access are limited. For *Africa*, the answers

were positive, yet even in South Africa “a lot of money seems to be allocated to help solve the situation, but I do not notice a vast improvement in South African educational resources output or the improvement in access or training of teachers”. In *Japan*, the educational potential of the Net is not widely recognized, and there is some protectionism precisely because Westerners are more advanced in online education. In media and governments worldwide, there do not seem to be significant Luddite or atavistic trends against technological advancement. The perceived problem is rather the expense, yet there may be some unspoken difficulties as the internet to some extent allows users to go beyond the nationalistic ideologies and control mechanisms that empower their leaders.

*Are there virtual universities or other virtual schools?* For *Latin America*, it was yes with two examples given for Brazil (hereinafter cf. the Appendix for names and Web URLs). But two of the four respondents did not seem to know. In *Finland*, it was yes with an example. For *Israel*, specifics were not cited, just the general embrace of e-learning. Israel’s Open University was introduced earlier. In *Turkey*, “There aren’t any virtual universities. Only some universities use virtual education for some courses.” Then quite a number of ambitious projects were listed. In *Russia*, there are very large-scale DE projects involving the web as well as video-on-demand lectures, but entirely virtual universities were not mentioned. Similar to Turkey and Russia, in *South Asia* several virtual campuses of major universities were cited. For *Africa*, in South Africa, which is not representative of the rest of Sub-Saharan Africa, it was yes, with just one private institution cited. Actually, the Kenyan respondent is associated with the African Virtual University, so it may have gone without saying beyond “Yes.” For *Southeast Asia*, in the Philippines they exist but are not popular. For Indonesia, the informant wrote “No”. For Malaysia, it was “Yes” and an example was cited. Moreover, “most public universities have incorporated elements of virtual learning to complement the traditional face-to-face classroom”. Later in this chapter, there are more details on Southeast Asia. In *Japan*, the established universities can now have virtual programs covering up to half their credits, but there are not yet any wholly virtual universities that are accredited. Overall, it seems much more common for established universities to branch into online programs. If the informants are not cognizant of virtual universities that do exist, then they have not yet made much impact. The following question elicited more details.

*If so, are they accredited or recognized, or considered notorious?* For *Latin America*, a virtual university based at the Technical University of Monterrey in Mexico was cited, which may render one-sided another response from Mexico pointing to notoriety, viz., “they are not recognized; they give their own degrees”. For Brazil, it was just written that “[t]hey work together with private high schools”. There were no responses for Finland, Israel, or Turkey recorded. For *Russia*, “The problem of recognition is understood and there are well defined quality criteria for distance education.” In *South Asia*, “many

are accepted and recognised by suitable authorities”. Some Indian institutions are formally recognized internationally with branches abroad. For *Africa*, in Kenya they are “[h]ighly recognized”. In South Africa, “[t]hey are accredited with our accreditation authority . . . and some of the courses have international accreditation”. But elsewhere in the same region there has been a perceived “infiltration of such virtual institutions from America and Australia, [which] have become issues of Cabinet debates in Parliament as to whether or not to recognize them”. For *Southeast Asia*, in the Philippines, “[t]hey are not yet accredited. The Commission on Higher Education is planning to come up with an evaluation instrument intended for ODL [Open and Distance Learning] institutions, [not yet encompassing] totally virtual universities.” In Malaysia, they are “[a]ccredited by the National Accreditation Board”. In *Japan*, since wholly virtual programs are not accredited, for-profit online programs could be considered notorious to hunt for customers in Japan. But if accredited domestic universities provide online programs, they are recognized. Overall, the trend seems to be toward educational reforms recognizing virtual universities, especially as they emanate from established institutions. Rather than stemming from pre-judgments about virtuality or distance from the instructor, notoriety, like recognition, has to be earned.

*Have many people considered studying at institutions in other countries through the internet?* For *Latin America*, there was just one response: “No, language and costs are a barrier.” For *Israel*, “Yes, and quite a few get degrees through distance learning (not necessarily through the internet).” For *Russia*, “Not so many, because Russian salaries are . . . 5–20 times lower than the salary for an equivalent job in developed countries. For many students not only knowledge, but also a formal diploma is of great importance. Free education online cannot provide a solid diploma, but to receive a foreign diploma one must spend a huge sum of money when compared with the average salary. And the language barrier is also a serious obstacle.” For *India*, “Yes, for some online certificate courses like those for corporations like Microsoft and Oracle, but not yet for traditional courses.” For *Africa*, in Kenya: “Not many, but there is a gradual increase in interest.” In South Africa, “Yes, I am currently helping some students with courses from an Australian online institution.” In the Southern African region, “not many people even in institutions of higher learning have sufficient provision of computers on their campuses while it may be a mirage for individuals to have personal computers at home with internet connectivity”. For *Southeast Asia*, in the Philippines: “Yes, however it is so expensive.” For Indonesia, the answer was just “Yes”. In Malaysia, “There is still some hesitation in this area, but foreign universities with online distance learning programmes have recorded the participation of Malaysian students.” In Japan, there have been advertisements in national publications especially for online MBAs that some working people would consider as an alternative to studying abroad.



*Are there many local companies going into the e-learning business?* For *Latin America* overall, “Yes”. In Mexico, “There are few, and we are one of them.” In Argentina, “Business companies may be more aware of the advantages of the web. There is a bit of a movement for English language acquisition due to the need for English for job applications, living abroad, and computer literacy.” In Brazil, “Yes, several, including IBM.” In *Finland*, “There are some.” In *Israel*, “Not [many].” In *Turkey*, “Many companies are going into the e-learning business.” A nationwide-scale example was cited. In *Russia*, “There are some, primarily dealers of foreign software companies, that advertise online education technologies.” For *South Asia*, “Yes.” A nationwide example was cited for India. For *Africa*, in Kenya: “Yes”. In South Africa, “Yes, but they are quite expensive and not all that user friendly.” In Lesotho, the informant did not know of any. For Southeast Asia, in the Philippines: “Only a few.” In Indonesia, “Yes”. In Malaysia, “Yes for multi-national corporations mainly, for whom e-Learning businesses span from primary education to university and even professional courses. But the 70% of the workforce in small to medium enterprises lacks the capital and expertise to invest in e-learning training solutions.” In *Japan*, yes, the big electronics companies and some entrepreneurs are trying to precipitate a market for e-learning.

*Are there academic associations working on the professional development of online educators?* For *Latin America*, “Yes, there are regional and national associations.” Yet in *Mexico*, “Mostly this work is done within each institution.” In *Brazil*, “Yes”, there is a national DE association. In *Finland*, “Yes . . . there is a national ICT Teacher Training Project.” For *South Asia*, “Yes, such as the Indian Association for Online Education.” For *Africa*, two responses from the southern region indicated that there are few online educators and hence few if any associations. For *Southeast Asia*, in Indonesia: “Yes”. Online educators in Malaysia “remain affiliated to academic associations related to their respective disciplines”. In *Japan*, educational organizations concerned with distance learning or computer-assisted language learning have changed their agendas with the advent of the Net.

*Is the infrastructure for web access an obstacle for most people or not?* For *Latin America*, “Basic literacy, infrastructure, communication costs, and computer literacy are obstacles for the population.” In Mexico, “Yes, because in Mexico only 3.36% of the population have access to the internet, but this number is growing.” In Brazil, “Yes, at our federal university, students have free access to only 8 computers.” For *Finland*, “In a very few cases; usually not.” For *Israel*, “For some, but not for most.” For *Turkey*, “the infrastructure for web access for most people is not enough”. Most users go to cyber cafes. For *Russia*, “In big cities access is affordable, but rather expensive for regular use in distance education.” For *South Asia*, “Yes, outside of institutions, slow telephone lines hinder web access.” For *Africa*, in *Kenya*: “It is an obstacle considering the fee levied which is generally not affordable to many people.” In Southern Africa, “Emphatically yes.” For *Southeast Asia*, in Indonesia:

“Yes, it is an obstacle, but also computer literacy.” In Malaysia: “Sadly, this is true.” In Japan, no, access is hardly an issue anymore. Computers, mobile phones, PDAs, game consoles, and an increasing number of appliances are becoming Net-enabled.

*What are the main obstacles to acceptance or use of the internet for education?* For *Latin America*, “Access is number one.” In Mexico, “Training, independent learning skills, and cultural perceptions.” In Argentina, “computers have become a luxurious tool at the moment”, yet e-mail use is rapidly increasing. In Brazil, “Access. Many of our students come from humble families.” In *Finland*, “Lack of knowledge about technological possibilities for helping learning.” In *Israel*, “lack of time, partial replacement of [existing] teaching/learning processes, [and] costs.” In *Russia*, “Low quality of telephone communications and high price for internet access when compared with the average salary level.” In *South Asia*, “Ignorance!” For Africa, in *Kenya*: “The cost of equipment, its maintenance and servicing.” In *South Africa*, “Access costs, infrastructure, poverty, and ignorance of what the internet has to offer for education.” In the Southern African region, “Dearth of infrastructure, financial problems, scarcity of telephone lines, and inadequate supply of electricity to many houses, districts, and villages where people live or work.” For *Southeast Asia*, in the Philippines: “The internet is already being used, but expensive infrastructure and all the equipment needed is an obstacle.” In Indonesia, “Computer literacy and computer culture, privacy of information and information rights, and ownership.” In Malaysia, “Cost of access and infrastructure.” In *Japan*, to change the status quo is usually difficult, and there needs to be much more awareness by the general public of the opportunities for education and self-improvement made possible by the internet.

*Are there any other global or local issues that affect the acceptance of online education or the use of VLEs in your region or country?* In *Latin America*, “Communication costs are very high[,] technology is more expensive than in the United States, and much of it is obsolete.” In Brazil, “The government intended to connect all public high schools by computer, but the funds were redirected to the electric company to prevent blackouts.” In *Finland*, “Commercial education is not an option, so the fear of having payments for the courses could be one issue. Another is that virtual learning takes time from other traditional learning activities, so there are worries about the quality of the content.” In *Israel*, “the academic culture”. In *Russia*, “There are strict traditions in the educational system and opposition of old teachers to new technologies. Computer classrooms in many schools have obsolete equipment, such as old PCs without internet access. There is also a lack of interest in short online courses or events, which have not yet proven their effectiveness in Russia. An exception is online courses to receive professional certificates from foreign companies, such as Microsoft. [Furthermore], there are difficulties in organizing a complete distance educational system granting professional diplomas.” In *South Asia*, “awareness and access seem to

be among the other reasons.” For *Africa*, in Kenya: “Cultural tendencies and attitudes.” In South Africa, “We currently have a severe food shortage in the region as well as high HIV/AIDS infection rates. Online education becomes a luxury . . . . Basic education itself is in crisis and very many schools do not even have electricity and books.” For the Southern African region, “Ignorance, low level of awareness, apathy, and insufficient funds.” For *Southeast Asia*, in the Philippines: “Older people are unable to use it and are very resistant to . . . ICT. They argue that nothing can really equal the value of face-to-face instruction, and that a personal human touch better encourages study, whereas the younger generation is embracing the challenges and maximizing the use of ICT.” In Indonesia, “National issues: infrastructure is expensive, therefore access is low and difficult, while the users are computer illiterate, and technical expertise is rare.” In Malaysia, “The major challenge would be having enough quality online educators who can develop good online courses that offer the kind of support that Asian students look for.” In *Japan*, mental attitudes in a traditional culture with elaborate face-to-face rituals raise many barriers. Yet, the internet allows Japanese people to browse world cultures from a safe distance and to consider becoming more involved in the outside world.

### 3. DISCUSSION OF THE OVERALL RESULTS

Factors such as the state of VLE use for education, internet infrastructure, access, and involvement of companies are closely correlated with the level of economic development of the countries reported. It can be inferred from that correlation that countries will proceed into educational and other uses of the internet insofar as they can afford to do so. On the one hand, fully developed countries like Finland and Israel are at a state-of-the-art level by all indicators surveyed. Whereas, countries like India and Russia are keen to do the same but lack the national budget to spread these opportunities to their large populations. There is no sign of a deliberate elitism to restrict wider access. From Mexico to South America, wide sectors of chronic poverty and limited infrastructure make online education a luxury that many cannot afford to discover. Much more so in Africa, more pressing public problems must be dealt with, lest awareness of what people are missing breeds further discontent.

Next to economic factors, cultural attitudes tend to determine which opportunities are embraced or avoided. Japan is fully advanced economically and in the internet infrastructure to use VLEs, but does not compare with Finland in realizing the possibilities of online education. India has meager resources but reaches out internationally, taking advantage of English-medium education, whereas Japanese people are largely content to insulate themselves in their culture and language. Cultural attitudes also extend to gender roles, yet the results were mixed. Besides a widespread tendency for women to shy away

from mechanical and technical things, or to be denied access to such education, they also may either have more free time than men or else be heavily represented in the teaching profession where they encounter opportunities for online educator development. India and Malaysia reported what points to a global issue, a city-country gap or digital divide within countries.

Then there are more nuanced issues like globalization, where individuals in each culture can take up the pros and cons and arrive at different conclusions—or ambivalence. Generally, people would like to expand their horizons but without incurring a threat to their cultural identity or acceptance by their peers. There was no sign in the responses that any sectors of societies would decline the opportunity to use the internet if it were accessible and affordable. Similarly, globalization would probably be embraced in most developing countries if it were not accompanied by a perceived exploitation that widens the gap between rich and poor. In the context of online education, it is vital that DE providers deliver the concrete benefits they promise in terms of valuable information and marketable skills, so that learners' life prospects are improved. Fast-buck operations claiming to provide knowledge, in effect from the high-tech center of world civilization to the benighted low-tech periphery, without intercultural sensitivity and due respect, can rapidly sully the frontier of global education. Whether globalization is good or bad then depends on the fruits of global initiatives, but the uncertain outcomes at this stage may account for much reported ambivalence about globalization.

Furthermore, there are local issues reflecting the circumstances in different regions and cultures that result in unique debates or variations in adopting global phenomena such as the internet. Systems of accreditation affect the development of virtual universities, and whether courses taken over the Net from other countries are recognized or marginalized. Where there tends to be suspicion about the outside world, as reported from Russia, Malaysia, and Japan, the sensitivity is liable to be greater toward bogus educational enterprises, viewing them as representative and confirming doubts rather than as the aberrations that they are. Then, language barriers loom large in many countries where English is a foreign language, compounding other barriers, making it difficult to discern spam and so forth, which reinforces distrust of strangers. While it is not surprising that literacy presents a vast barrier to internet-based education, it may be surprising the extent to which communication costs are inversely related to income, more expensive in the developing countries, which exacerbates the global digital divide.

Thanks to the representatives of countries at various stages of development, fruitful comparisons could be made and patterns discerned. An overall conclusion is that online education can represent a positive form of globalization welcomed in most of the world, provided it is not technologically or economically but rather pedagogically driven. Academic standards and ethics provide the foundation for a new professional discipline of online education.

### 3.1. Representative Global Issues and International Initiatives

#### 3.1.1. Potential Role of Universities in Global Online Education

Global issues in online education include culture, gender, language, access (-ibility), generation gaps in comfort with computers, differences in wealth or the global digital divide, and so on. The challenge is not so much to find the issues but to envision where to start, how to sort, and prioritize the issues impacting on and resulting from global online education. Some priorities of the co-authors can be seen in the questions and issues raised in this chapter. Parker Rossman takes the approach that universities are the key to mobilizing ideas and resources to work on global issues particularly by helping the developing world. He has thus made freely available a continually revised online book on the future of higher education. Due to the format, chapters are cited rather than page numbers, and it is recommended that readers access the whole online book through the URL provided in the references. The following passages from near the beginning of the online book frame the issues, highlighting priority global issues and approaches worthy of commitment at the interface of higher education, and online learning:

If some new kind of global lifelong education structure is coming into existence it is propelled not only by the new opportunities provided by communications technology, but also by the desperate needs of underdeveloped areas for better research, political action, and education (Rossman, 2002, Preface). [However,] the shape of the global virtual lifelong university may be determined or strait-jacketed by global non-education forces such as business, technological developments, and pressing government priorities.

The necessity of lifelong education has become axiomatic among Western educators, but here that goal is extended in a challenging way to the whole world. Another range of global issues is alluded to as well, non-pedagogical imperatives that tend to make educational reforms more difficult.

Quality also requires that higher education should be characterized by its international dimension: exchange of knowledge, interactive networking, mobility of teachers and students, and international research projects, while taking into account the national cultural values and circumstances (*ibid.*). Who but the universities can keep humanity from being swamped and cynically disillusioned with inadequate solutions to social problems such as the population explosion? Soon half of the world's population is going to be under age 20, and already there are a billion young people who ought to have higher education, but who can never reside on a campus or commute to one. (*ibid.*, Vol. 1–01)

Here, Rossman provides universities with an inspiring incentive to get involved with education for the less fortunate. The quality and universality of universities will be reflected in how they take up such challenges for social relevance and leadership in and beyond their local communities. Many of those whose volunteer work is presented in this chapter, moreover, have not just waited for grant money but have leveraged institutional resources for immediate results. Provided such individual efforts are organized on a much larger scale, universities do have the residual resources to have a great impact if they make helping international society an explicit part of their mission.

Tens of millions of people are already participating in distance education, open universities, and other electronic learning networks. As such programs expand globally, sharing of information and courses can be a much more affordable form of aid to the Third World. Indeed, World Bank consultations at the turn of the century have proposed that “education for all”—made possible by the internet—may be humanity’s best chance to end poverty. (*ibid.*, Preface)

Besides the great potential of universities, international organizations such as the World Bank and UNESCO could be more effective as their clientele goes online. Besides their own overhead including already-privileged personnel and consultants, their programs to reduce poverty tend to be very expensive, e.g., utilizing videoconferencing by dedicated satellites. The same money could go much further with online education *via* the internet. Educators themselves tend to be willing to share course contents and more if they do not have to travel to various countries each time to do so, but rather by wedding an open source learning approach to online educational technology skills.

The August 2000 UNESCO COURIER reported on the highly successful Village Internet program in Bangladesh, one of the world’s poorest countries. It was bringing the internet into every rural village, creating jobs, providing new product marketing opportunities, giving access to health care, creating a computer literate younger generation in rural areas and providing access to global distance education. Note also the USA Leland Initiative for Africa, and an exploding number of other such projects. It was in 2000 predicted at M.I.T. that within five years a half billion people in the developing world would be using the internet. (*ibid.*, Vol. 1–01)

Skeptics say that most Africans will not have such interactive technology for decades. John Perry Barlow (1998), however, provided evidence that they may leap ahead of developed countries. Women of Africa already show signs that they will move more quickly into wireless space, one of many unexpected surprises ahead for those of us who use wires and cables to connect. (*ibid.*)

Here, Rossman shows that some international initiatives are already working and growing in potential as more and more world citizens go online. In the above instance of African women, though it may upset the current social order based on longtime cultural practices, the empowerment of women is considered a universal value that can enhance human resource development beyond present expectations.

UNESCO's global higher education vision included: Equity of access with no discrimination on grounds of race, gender, language or religion, or economic, cultural or social distinctions, or physical disabilities in partnership with all levels of education, starting with early childhood and primary education and continuing through life; in active partnership with parents, schools, students, socio-economic groups and communities; should also enhance the participation of women. Higher education, the UNESCO declaration said, should "reinforce its role of service to society, especially its activities aimed at eliminating poverty, intolerance, violence, illiteracy, hunger, environmental degradation and disease, mainly through an interdisciplinary and transdisciplinary approach in the analysis of problems and issues. Ultimately, higher education should aim at the creation of a new society—non-violent and non-exploitative—consisting of highly cultivated, motivated and integrated individuals, inspired by love for humanity and guided by wisdom." (*ibid.*, Preface)

UNESCO's vision comprehensively lists global educational issues, and a further challenge would be to apply online education toward each of the above goals. The last citation from Rossman below points to such a synthesis and presents educators with a challenging horizon:

The rapid breakthroughs in new information and communication technologies will further change the way knowledge is developed, acquired and delivered. Engaging in networks, technology transfer, capacity-building; developing teaching materials and sharing experience of their application in teaching, training and research, making knowledge accessible to all; UNESCO urges: "creating new learning environments, ranging from distance education facilities to complete virtual higher education institutions and systems, based on regional, continental or global networks, functioning in a way that respects cultural and social identities. The principle of solidarity and true partnership amongst higher education institutions worldwide is crucial for education and training in all fields that encourage an understanding of global issues, the role of democratic governance and skilled human resources in their resolution, and the need for living together with different cultures and values." (*ibid.*)

### 3.1.2. *The GUS: Implementing Global Online Education*

This chapter treats global and local issues interacting in educational institutions and societies around the world. Online education is by no means fully realized yet globally, but current promising trends point in that direction. Even so, global online education is not an inevitable outcome that everyone can wait passively to enjoy. Knowing the enormity of the task of making it happen or just hastening the trend, this section examines what it is like in practical terms to work toward global online education.

The “trend” aspect points to various forces combining so that most humans at least have the option of connecting to the global internet infrastructure for learning. One huge organization for this purpose may not be as effective in galvanizing individual efforts as specialized teams contributing their resources and co-operating in a division of labor. Many groups like to be the umbrella organization but not to be subsumed under another’s umbrella. In the experience of the WAOE ([www.waoe.org](http://www.waoe.org)), an organization can play a unique role if it is neither too new and diminutive to be effective nor too large and established to be unfettered by bureaucracy and the slow pace of paper-based traditions. Yet to bring about global online education, stakeholders from all sectors of society in many countries must agree to align their forces in such areas as technical expertise, funding priorities, and ethical standards.

The GUS illustrates many of these factors and challenges. GUS was founded by one of the first non-Westerners to use ICTs. Takeshi Utsumi, a Japanese engineer with lecturer privileges at Columbia University, early saw the internet as a path toward world peace, and his continual sacrifices to help other non-Westerners in developing countries have earned their trust.

Westerners have also contributed their time and expertise, such that UNESCO has recognized the GUS base at the University of Tampere in Finland among the universities in its UNITWIN program. Perhaps the first NGO to be so recognized, GUS could also be described as a meta-virtual university to incubate online education projects for local community development and global networking.

The most recent formulation of GUS is “Creating the Global University System”, a chapter in a book aimed to coincide with the UNESCO Conference on Teaching and Learning for Intercultural Understanding, Human Rights, and a Culture of Peace, Jyväskylä, Finland, 15–18 June 2003. It takes a broader approach than just promoting educational technology:

The Global University System (GUS) is a worldwide initiative to create a telecommunications infrastructure for access to educational resources across national and cultural boundaries for global peace. The GUS helps higher educational institutions in remote/rural areas of developing countries to deploy broadband internet in order for them to close the digital divide and act as the knowledge center of their community for the



eradication of poverty and isolation. The GUS has task forces working in various regions of the globe with partnerships of higher education and healthcare institutions. Learners in these regions will be able to take their courses, *via* advanced broadband internet, from member institutions around the world to receive a GUS degree. These learners and their professors from participating institutions will form a global forum for exchange of ideas and information and for conducting collaborative research and development. The aim is to achieve “education and healthcare for all,” anywhere, anytime and at any pace (Utsumi et al., 2003).

The mission of GUS has three specific thrusts, to:

- identify, test, and facilitate the deployment of broadband internet and related technologies that are affordable and accessible for underdeveloped areas of the world;
- coordinate the delivery of content and rich educational experiences leading to a GUS degree;
- provide a global infrastructure for collaboration among faculty, students, graduates, and policy makers in universities, healthcare institutions, corporations, and governments.

GUS aims to help equip youngsters around the world to be competitive and to strive for excellence. GUS aims to prepare them for a world that seems to be changing from the industrial age where obedience predominated to a knowledge age where creativity and competence predominate. (*ibid.*)

An earlier (unpublished) draft for a mid-east conference had put it this way: “The mission of GUS is not the mere enhancement of job skills with e-learning, but the creation of youngsters aiming for world peace and the eradication of poverty and isolation through the use of advanced ICT in remote/rural areas around the world.”

For decades Utsumi has expended substantial time and his own private funds to achieve a

pioneering role in extending U.S. data communication networks to other countries, particularly to Japan, and deregulating Japanese telecommunication policies for the use of e-mail through ARPANET, Telenet and internet (thanks to help from the Late Commerce Secretary Malcolm Baldrige)—which is now called “closing the digital divide.” This triggered the de-monopolization and privatization of Japanese telecommunication industries. This liberalization of the telecommunication industry has been emulated and has now created a more enabling environment for economic and social development in many other countries. (*ibid.*)

After Global Lecture Hall videoconferences around the world from 1986, an International Workshop and Conference on “Emerging Global Electronic Distance Learning” was held in August, 1999 at the University of Tampere, Finland: [www.uta.fi/EGEDL](http://www.uta.fi/EGEDL).

About 60 decision-makers and leaders in e-learning and telemedicine from 14 underserved countries brainstormed, and the workshop recommended the formation of the Global University System (GUS)<sup>TM</sup> with Global Broadband Internet (GBI). The group also formulated specific pilot projects focused on major regions of the world to reduce the growing digital divide between information-rich and information-poor populations, in order to realize education and healthcare for all, anywhere, anytime and at any pace. (*ibid.*)

We can expect GUS to provide the following benefits to students and participating universities:

- Broadband Internet will support sophisticated pedagogy *via* the World Wide Web.
- Member universities can build a network of facilitators to support e-learners.
- Learners may take courses from member universities and get their degree from the GUS, thus freeing them from being confined to one academic culture of a single university and country.
- Learners and faculties can promote the exchange of ideas, information, knowledge, and joint research and development of web-based teaching materials.
- Learners, faculties, and public policy makers can promote community development and many other advances locally, regionally, and even on a global scale.
- Researchers in developing countries can partner with colleagues in advanced countries to perform joint collaborative research and development (*ibid.*).

The GUS illustrates the comprehensive vision, co-ordination of stakeholders, and fund-raising efforts necessary to hasten the advent of global online education. Utsumi describes one recent phase in the following electronic distribution list message:

I then suggested to high echelons of the Japanese parliament and government to direct Japanese Official Development Assistance (ODA) funds for e-learning and e-healthcare to improve the image of Japan, whenever I have visited Japan in the past several years. Subsequently, I helped the Japanese government pledge US\$15 billion to close the digital divide in developing countries during the Okinawa Summit in July of 2000. Mr. Koizumi, Prime Minister of Japan, made another pledge of

US\$2 billion to aid education and healthcare in developing countries during the G8 Summit in Canada in June of 2002 and at the Environment Summit in Johannesburg, South Africa in September.

Our proposed Amazon project is to combine the Japanese government's ODA funds and electronic equipment (computers, transceivers, dish antennas, etc.) from Japan with the internet technology and content development of North America to help underserved people in rural and remote areas of developing countries. The Global University System (GUS) will follow this approach in other developing countries around the world in the future (Utsumi, 2002).

Progress of GUS projects and daily correspondence can be accessed from the home page: [www.friends-partners.org/utsumi/](http://www.friends-partners.org/utsumi/).

### **3.2. Cultural and Regional Reports on the State of Online Education**

#### *3.2.1. An Islamic Perspective on Virtual Education*

To seek knowledge is a sacred duty, obligatory for every Muslim, male or female. The first word revealed of the Quran was “*Iqra*” READ! Seek knowledge! Educate yourselves! Be educated! This should say a lot for the importance of education in Islam; and online learning will certainly make education more accessible.

The WWW has made it possible for organizations big and small to spread Islamic education. There are many non-formal educational sites such as Islam Online that provide comprehensive Islamic education in the form of practical guides to living and learning Islam: [www.islam-online.net/English/index.shtml](http://www.islam-online.net/English/index.shtml). Many institutions in the Western world do offer formal and non-formal online courses on various aspects of Islam. As one such example, Technology-Assisted Lifelong Learning (TALL) of Oxford University's Department for Continuing Education has students who now live in Indonesia, Iran, Pakistan, and other countries where a large majority are Muslims.

In Malaysia, the International Islamic University of Malaysia (IIUM) was one of the early adopters of online learning: [www.iiu.edu.my](http://www.iiu.edu.my). Some of its distance learning programs have been made available online: [www.iiu.edu.my/c-excel/index.htm](http://www.iiu.edu.my/c-excel/index.htm). The Arab Academy based in Egypt, with partners in the United States, which claims to be the world's first and only professional online site for learning Arabic as a foreign language, has students from Muslim countries including Malaysia, Turkey, Pakistan, Indonesia, Kuwait, Bangladesh, Iran, Qatar, Oman, Palestine, Bahrain, Yemen, Libya, and several others: [www.arabacademy.com/about\\_e.htm](http://www.arabacademy.com/about_e.htm). This does show that the Muslim world is embracing online education quite readily.

In Southeast Asia, however, Islam cannot be considered as an engine for virtual education. Education in this part of the world is very tightly controlled by the respective governments, and in Malaysia for instance, any initiative on Islamic education has to adhere to strict government guidelines. Yet while Malaysia and Indonesia have predominantly Muslim populations, these countries have been quite aggressive in getting online to cyberspace to promote education in general. For details see the section on Southeast Asia later in this chapter. There has been no recorded opposition to virtual education in the Islamic world; in fact, the WWW has given a voice to Muslims who wish to express or spread their views to contest the blanket views of the mass media.

#### 4. ONLINE EDUCATION IN THE FORMER USSR

##### 4.1. Leading Distance Learning Developments in Russia

DE programs of typical Russian institutes are a mixture of mailing print and CD educational materials with face-to-face exams at local affiliates of the institutes. So they do not use online methods widely, but in their advertizements the online methods are starting to be mentioned.

Nevertheless, the Russian Ministry of Higher Education has stimulated an experiment in DE development with the participation of about 15 educational institutions. A report about this experiment (in Russian) published in 2001 shows that DE in Russia is quickly developing and the most active institutions are world class.

Among other institutions, two leaders in DE stand out:

- The Moscow State University of Economics, Statistics, and Informatics (MESI) has been prominent for more than 70 years and now is quickly developing its distance educational network all over Russia. MESI <http://www.mesi.ru/eng/index.asp> has more than 56,000 students learning through distance technologies. Through 150 affiliates in different educational institutions of Russia and the former Soviet Union, this institute spreads its educational technologies, thus promoting DE in governmental institutions in this region.
- The Modern University for the Humanities (MUH) is a non-governmental institution that bases its educational technologies primarily on video and computer technologies, with satellite transmissions of educational programs to 180 affiliates spread all over Russia and the former Soviet Union, appearing even in European countries. MUH has more than 110,000 students involved in DE.

The students of MUH ([www.muh.ru](http://www.muh.ru)) (in Russian) even on its main campus work through the same standardized computer and video technologies as the students in affiliates. Their approach is to work out the best educational

technologies for the whole university system and to test them immediately. MUH has a number of scientific institutes working on the psychological issues and methods of DE, working on perfecting their video courses, their computer courses, and their methods of educational quality control. MUH attracts for its courses the leading professors in Moscow and elsewhere in Russia, then records their courses on video and computer memories.

The MUH dispatches its own team of long-distance representatives who facilitate satellite courses in remote regions of our planet. The well-known Russian adventurer Fedor Konioukhov performs his educational experiments while sailing or rowing alone across the seas (Konioukhov, 1999), riding a camel caravan along the old Great Silk Road (Konioukhov, 2002), or with a dog sled team along the Arctic Circle. These experiments help psychologists in selecting the best educational methods. The expeditions attract the attention of local people to the MUH distance educational technologies, thus promoting new affiliates to open in remote regions.

The MUH has its own-patented system of computer testing. They produce more than 500 educational video courses annually. The students also record their coursework on videotapes, and then upper class students evaluate the quality of these works. This institution, concentrating on distance educational technologies, spreads its programs through satellite receiving centers in affiliates and delivers the courses to students with the help of certified tutors in affiliates.

#### **4.2. The International Virtual University Project**

Moscow State Institute of Business Administration (MSIBA) is working on a project to create the International Virtual University. The impetus of this innovation includes the following factors:

- expectations of an institute with very competitive admissions;
- limits of existing buildings to expand educational activities;
- the necessity to foster modern economic and business knowledge and skills among Russian students more rapidly through the internet;
- the need for a way to make it possible for very busy entrepreneurs and business persons to improve their economics and business knowledge and skills through a hybrid system of education, joining together face-to-face interaction with computerized self-learning.

Here in a prominent educational institution, online learning may be affordable both for highly motivated students and for successful business persons.

MSIBA presented at an online exhibition representing the region of the former Soviet Union (MSIBA GLD6 Gallery, 2002). This participation was very motivational for the students involved, helping them to improve their computer and internet navigation skills, fluency in English, teamwork, and presentation

techniques. Thus the students' involvement in international events though the internet is itself a powerful method of online education. After all, the student is not a vessel to be filled, but a torch to be lit.

#### 4.3. Further Initiatives of the MSIBA

The MSIBA campus in the Moscow suburb of Zelenograd plans to create an affiliate in central Moscow to exchange lessons with high-quality professors, connecting *via* the Moscow fiber optic network. Currently, there is a 24-hour telephone connection to the internet and e-mail. This connection is good for a limited number of users, but for three full classes to work in the internet simultaneously is sometimes stifling. In time to launch the Virtual University in 2003, a broadband connection to the fiber optic net is desired. Currently, there are about 50 Pentium-2 and around 50 486 personal computers (PCs) connected in a local area network with phone modem access to the internet.

The level of business information skills of graduates meets Russian business sphere requirements. Some graduates are involved in e-trade projects; some in the computerization of banks; others in publishing, advertizing, or consultation businesses; and yet others in the computerization of management systems at manufacturing or trading companies.

More than half of the students have home computers that are better than those at the Institute. Many upper class students have part-time jobs at enterprises where they have access to business computer technologies. Orientation of students to features of computer technologies in business offices need not exceed 2 days.

Moscow Mayor Yury Luzhkov commissioned MSIBA to create a DE system for Russian speaking students from the states of the former USSR, hence the internet-based International Virtual University. This writer (Boris Sedunov) as manager of the project sees the Institute as a laboratory to work out the methodology for a virtual university in its educational practice.

The Institute is ready to provide some distance courses with a special certificate for Western students who plan to work with Russia in the future, providing them with lessons on Russian culture, language, and business particulars. The Institute has experience in this respect, having been for some years a training base for United States Peace Corps volunteers.

The Institute has an evening department for adult students, who are very busy with their occupations. Some of them may prefer to study online or to use asynchronous online methods for a part of their courses.

MSIBA also plans to create an International Business School jointly with a respected University abroad to grant MBA diplomas to its graduates. There is a great demand for MBA degrees among prominent business persons in

Russia, who want high-level business knowledge and skills (not an MBA degree from a diploma mill), joining together Western theory and Russian practice. Such co-operative education may benefit from distance educational technologies. Here MSIBA tutors, certified by the Western partner, would provide face-to-face communication with the graduate students while they have e-mail and internet consultations with the Western partner professors. The latter may come to Moscow from time to time for F2F exams, training, and certification of trainers.

A hybrid system is deemed best for a high-level business education at this stage of computer and communication technologies in Russia. Face-to-face interaction aims to provide active business and communication training and business simulations to students. Some business lessons, training, and gaming may be performed in online versions, but not all. For example, to train conversational skills in foreign languages, video and audio tape recorders, and listening to the radio still seem more effective than by computer. By computer-based methods, including online education, a controlled self-study of routine aspects of business education can be provided. For such purposes, having lessons and tests on CD-ROMs along with consultations at a distance by e-mail and so forth seems suitable. For a philosophy of management and business education, predicting its future development (see Sedunov, n.d.).

About 30 former MSIBA students have gone to Japan to finish their studies at Niigata University of Commerce (Sangyo). They wish to receive an MSIBA diploma as well. At such a distance only the use of DE technologies can help them finish their studies. They can take F2F exams once a year in Zelenograd when they visit their families. In October 2002, an MSIBA delegation visited Niigata for a conference presentation and to work out a scheme for this DE system (cf. Kostina et al., 2002).

#### **4.4. Analysis of the Market for Online Education**

Considering online education development in different countries and in different social strata, an approach should be based on some methodological principles. Proposed here is the positioning of a student in a “knowledge—diploma” diagram. Another principle is positioning a student in a “motivation—resources” diagram. And a third principle is investigating online education accessibility in terms of a “cost of learning-to-revenue” ratio.

#### **4.5. A “Knowledge—Diploma” Diagram**

Here, a distribution of students in a two-dimensional diagram is considered, one axis representing the desire to obtain new knowledge and

skills, and another axis indicating the desire to obtain a new diploma or certificate.

<b>“Knowledge–Diploma” Diagram</b>	<b>Degree of Desire to Obtain a New Diploma or Certificate</b>	
Degree of desire to obtain new knowledge and skills	Low	High
High	Students possess a solid position in their families or workplaces	Students see that both knowledge and a diploma are needed
Low	Students study under family pressure	Students believe in the magic of a diploma for their future life

In this system of classification, the students of typical primary and middle schools fall mainly in the lower left square. It is difficult to hope that they will be interested in online learning that requires a high degree of self-motivation. For them it does not make much difference to what type a system of education belongs. Only a small amount of children from these schools possess their own desire to obtain new knowledge or a certificate.

Students of professional education in the lower-right corner do not bother about self-education. Their main problem is to spend 4–5 years until they receive their desired diploma. They may be clients of different forms of DE that do not require their own efforts to obtain new knowledge and skills. So, online learning is not for them either.

Students in the upper-right corner may be interested in online learning if these courses provide valuable certificates for the job market and if they can afford the fee level for this type of learning. In general, they are not from prosperous families and do not make such money as would cover expenses for online learning.

Students most interested in online education would be in the category of the upper-left square. These students do not bother about diplomas or certificates; they have great self-motivation to acquire new knowledge and skills. For them, short online courses bring the most satisfaction, if they can provide needed knowledge and skills. In this category fall talented children, wives from prosperous families free from work and school graduates at modern companies whose work has shown them a urgent need for wider knowledge and improved skills.

In the territory of the former USSR, this category is not as populous as in economically developed countries. There are not so many prosperous families, and sophisticated, successful companies are not very many. So, the social base for online learning in this territory is not developed enough.



**4.6. A “Motivation—Resources” Diagram**

“Motivation— Resources” Diagram	Degree of Financial and Time Resources	
Degree of Motivation for Self-learning	Low	High
High	Students possess a great motivation to overcome poverty	Students can use their family’s resources for their education
Low	Students from poor families study under family pressure	Students expect family support for their future life

In this system of classification, the students from lower squares cannot readily be clients of an online system of education that requires a high degree of self-motivation.

Students in the upper-left corner might wish to take online courses, but do not have the resources to cover such expenses.

Students in upper-right corner would be the most interested in online learning. They are from prosperous families, but such families are not so numerous in the territory under consideration.

**4.7. Dependence of Online Education Access on A  
“Cost of Learning-To-Revenue”: Ratio**

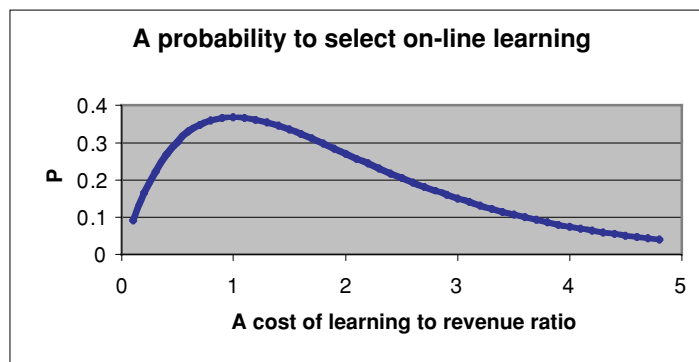

If we take the cost of learning-to-revenue ratio in the United States as a unit, then in the former USSR countries, this ratio exceeds five. A simple mathematical model shows that in these conditions the probability to pay for education falls drastically. So, what seems to a citizen of a developed country as a natural process—to buy courses, for citizens of the former Soviet Union becomes impossible.

The main factors influencing this ratio are

- the cost of internet access being almost the same in developed and undeveloped countries; and
- the average salary level in less developed countries being 5–20 times lower than in developed ones.

The situation cannot be redeemed by the fact that the instructors in less developed countries are paid less, because the price for internet access with unlimited time exceeds the anticipated increase in income. Even if the level of income in less developed countries is sufficient for e-mail communication or for internet access limited in time, for online learning a constant access to the internet is needed that is generally not affordable. This analysis following some specifics on online education in the region of the former USSR should help readers see the situation and future prospects realistically.

## 5. ONLINE EDUCATION IN INDIA AND THE SOUTH ASIAN REGION

### 5.1. Introduction

Online education has been one of the most significant happenings in Indian IT life. Online delivery of programs through the internet in India and its vicinity is fast emerging, opening new gates for knowledge dissemination to learners placed geographically in remote places. This “anytime anywhere” education has provided both an opportunity and a challenge for South Asian countries, especially to India, in creating a niche for itself in the huge market of offering online courseware. The onslaught of universities from the United States, the United Kingdom, and Europe has flooded these countries by providing accredited and non-accredited courses online. For example, Yale, Massachusetts Institute of Technology, Stanford, University of California, Los Angeles, the University of Wisconsin, Capella University, etc., offer good quality programs in different disciplines. Staying ahead in such a cutthroat environment has become a challenge, particularly with the impact of globalization, WTO initiatives, and the General Agreement on Trade in Services (GATS).

The higher education system in India has grown phenomenally and has witnessed great changes. At the time of Indian independence, there were only 19 universities and 700 colleges. Today, India has 13,150 colleges of different kind and nearly 250 universities. The number of students and teachers has also grown from about 1 million and 15,000 to over 88 millions and 4 millions, respectively. In spite of this massive system of higher education, a large segment of the population is not covered under educational services. A population explosion and financial constraints have put great stress on the traditional educational system. It was in the third Five Year Plan (1961–1966) that the proposal for establishing evening colleges and correspondence

courses was proposed, and as a result a School of Correspondence Courses and Continuing Education was established in 1962 at Delhi University. After that, many conventional universities started programs through correspondence, but a thorough-going teaching and learning system was first initiated in 1982 with the establishment of the Andhra Pradesh Open University (now renamed the Dr. B. R. Ambedkar Open University) at Hyderabad (<http://www.braou.ac.in/>).

The most significant milestone in the history of Indian education was in 1985 when the Indian Parliament passed the Act for establishment of the Indira Gandhi National Open University (IGNOU). IGNOU ([www.ignou.ac.in](http://www.ignou.ac.in)) has national jurisdiction and is at the apex in offering high-quality DE courses. As a result of the success of this system, the individual States followed suit and set up state open universities (OUs). Currently, there are 10 of them and 1 National Open University. In addition, there is a National Institute of Open Schooling ([www.nos.org](http://www.nos.org)) to cater to secondary education, which offers academic and vocational courses all over the country.

## **5.2. The Beginning**

Toward the end of 1990s, the educational system again observed a paradigm shift and ICT became the hub of services. It was this period when access to the internet increased and private ISPs entered the game.

To meet the challenges and to keep pace with emerging international standards for online course content, leading companies like Aptechn and National Institute of Information Technology (NIIT) and educational institutions like IGNOU, Indian Institute of Management, etc., established their presence in the online learning space. The NIIT established its [netvarsity.com](http://netvarsity.com) as early as 1996 to offer completely online infotech-related modules, and adopted a “brick-and-portal learning” model. Very soon, [zeelearn.com](http://zeelearn.com), [classteacher.com](http://classteacher.com), [school-circle.com](http://school-circle.com), [egurucool.com](http://egurucool.com), [vidyainfo.com](http://vidyainfo.com), and [entranceguru.com](http://entranceguru.com) and more followed the trend and became informational and e-learning portals. The NIIT has a 35% stake in [classteacher.com](http://classteacher.com) and has also taken over [egurucool.com](http://egurucool.com). Intel-India has been providing free training to teachers on the use of computers. Such projects indicate that e-learning is being treated a major component of the educational sector.

The Government of India also took initiatives to provide its citizens world-class “on-click” education on demand, and thus a National Task Force on Information Technology (IT) and Software Development was constituted in May 1998 by the Prime Minister of India. The prime mission of this taskforce was to formulate a long-term Indian National IT Policy to develop India into an IT software superpower. According to an estimate by Skoch, an IT Consultancy and Strategy Firm, in revenues the Indian IT industry grew 19% in 2003 at U.S. \$2 billion (Times of India, 2004). The firm further reported 21% growth of the IT industry in 2003 to log \$16.4 billion in sales, of which

\$3.6 billion pertained to hardware and \$10.4 billion for software exports. The PC industry also grew 32% with 2.3 million units sold, including 87,499 notebooks, up to 78% largely because of introduction of sub- \$1000 products. The recommendations of the Task Force were documented in the form of an “IT Action Plan: Long Term National IT Policy”. Among other major recommendations, thought was given to IT-enabled education. The Policy states

- viii.** All Companies, in IT as well as other sectors, will be encouraged to set aside 6% of their value added revenue (sum of salaries, perquisites and net profit) to support the IT HRD [Human Resource Development] sector in offering IT as well as IT-enabled education through investment in infrastructure establishment/upgrading in educational/training institutes, providing endowments, catering to the recurring expenditures of the institute such as salaries/honoraria to faculty, scholarships to students, providing part-time instructors, etc. These companies will have full freedom to allocate such funds to any institution of their choice and to be utilized specifically in the manner desired by them.
- ix.** Government in association with IT HRD companies will aim to achieve 100% IT literacy at senior secondary level (10 + 2) in 5 years and at secondary level in 10 years.
- ix.** All institutes offering engineering education, including Polytechnics and ITIs [Industrial Training Institutes] will ensure that within 3 years all engineering students in the country will acquire IT knowledge to be able to serve in the IT-enabled Services sector besides serving in the IT industry directly ([www.nasscom.org](http://www.nasscom.org)).

### **5.3. E-Learning Initiatives**

In India, e-learning is being adopted in most institutions in different forms. Kumar (2004) reported that in the state of Kerala the textbooks where Malayalam or English is the medium of instruction are available online [[www.keralaeducation.org](http://www.keralaeducation.org) or [www.education.kerala.gov.in](http://www.education.kerala.gov.in)]. Even the Government has taken a decision to provide all textbooks for students of Class 10 on the internet from the academic year (2004–2005). These materials (in pdf) are offered free of cost provided they are used only for educational purposes. Kumar also expresses some concern for the private tuitions by teachers and note taking tendencies by the students, but is optimistic also as if e-learning comes of age in Kerala, then the students need not pay for private tuitions in addition to avoiding traveling long distances for going to classes.

Downloading reports, presentations, and documents for teaching and learning is the most common practice. Trends in IT development globally and within India are expected to be reflected in an expanding e-learning market. According to a market analysis of the American e-learning industry done by Brandon-hall.com, the e-learning market in the United States alone will grow to \$212.9 billion in 2011 from the current \$10.3 billion, as reported by Center of Education Technology (CET), CMC Ltd. (2002). Although there has been a global slowdown in the IT sector, its impact was much more visible in the United States (up to 44% according to an estimate by the CET, CMC). The Information Technology Association of America (ITAA) reported that 1 out of every 14 workers in the United States is in the IT sector and 1 in every 12 IT sector jobs remains vacant for want of skilled personnel.

India has always been one of the major sources of trained manpower to developed countries. The reasons include cheap labor, good English speaking skills, and hard-working nature of Indians. To cater to the requirements of IT industries abroad, organizations in India have taken some initiatives to establish training centers to produce trained manpower in the field of e-learning. The setting up of cmcvarsity.com by CMC, netvarsity.com by NIIT ([www.niit.com](http://www.niit.com)), zeelearn.com by Zee Learning, zeeeducation.com/online by Zee TV's online training, learnatsatyam.com, the virtual campus initiative of ignou.ac.in, the Tamil Virtual University, The Birla Institute of Technology and Science (BITS), Pilani virtual university <http://vu.bits-pilani.ac.in/>, and gurukulonline.co.in by Gurukulonline Learning Solutions are some of the prominent examples indicating preparedness by Indian universities and IT industries to meet the growing demand. They offer degree programs or training courses in e-learning or multimedia, empowering personnel to handle e-learning technologies and methodologies. NASSCOM (2002) has also reported a significant growth in the IT and IT-enabled services sector, with an estimated \$10 billion in annual e-commerce sales. But this figure is very low when compared with other Asian countries, e.g., China, the only country that exceeds India's population of a billion.

One of the reasons for the boom in online learning in India is the need for and emergence of anytime, anywhere learning. Owing to modern lifestyles and job requirements, people attempt to gain knowledge within their limited available time duration. There is a preference for specified learning in a specified time period. Learning at one's own pace whenever time is available is the main factor in the growth of online education. Indian soil has been found to be very fertile for the growth of online education. Although the state of online education in developed countries like the United States, Australia, and European countries is far better, certainly India stands out as a leader among Asian countries. In fact, India has become one of the largest producers of CBT and WBT (computer- and web-based training), and this has given rise to occupations in learning technologies, opportunities for instructional designers, web designers, technical writers, and educational subject matter experts. Owing to

the high level of scientific and technical skills of Indian professionals, more than 25% of the world's custom software was Indian in 2002. Currently, Indian software professionals are employed by all major firms and most of the global giants have their presence in India. (Giovannetti et al. 2001, p. 99) reported that the Indian software industry is providing its services to nearly 40% of the Fortune 500 corporations.

Higher education institutions in India are also establishing paperless procedures. Universities like Hyderabad University, the University of Rajasthan, the Indian Institute of Science in Bangalore, the Variable Energy Cyclotron Centre in Kolkata, the Indian Institute of Technology in Chennai and Kanpur, the Inter-University Centre for Astronomy and Astrophysics in Pune, and the Orissa Computer Application Centre in Bhubaneswar are among those selected as Education and Research Network (ERNET) components. This enables these universities to actively collaborate in international research projects, sharing the latest editions of research journals and databases.

In addition to local players, global leaders are also not far behind in their bid to provide e-learning technologies in India. For example, Mentergy Limited (NASDAQ: MNTE), which is a full service global e-learning company, in association with Hindustan Technologies Limited (a subsidiary of Skysat Holdings of Singapore) is providing the TrainNet interactive virtual classroom environment in India for video-based training *via* satellite delivery ([www.usdla.org/html/journal/SEP01\\_issue/techex05.html](http://www.usdla.org/html/journal/SEP01_issue/techex05.html)). Manipal Academy of Higher Education (MAHE) as their client offers IT training in India. Another instance is of Carnegie Mellon University's project of Virtual Centre for Technology Enhanced Learning (VCTEL) to provide better access to IT education with active support by the Government of India. VCTEL has been established to serve as an "information clearinghouse" for Indian educational institutions (Gerson, 2002).

Toward the end of the year 2000, a Virtual Learning Campus "learnatsatyam.com" was launched by Satyam Education Services Limited, a subsidiary of Satyam Infoway Limited (NASDAQ National Market: SIFY) to provide education and training to corporate employees and students on a par with the international community. Students can get in touch with virtual instructors or web gurus through the "Electronic Instructor-Led Training" system. Other features of this online endeavor include virtual field trips, message boards, real-life application sites, and a round-the-clock online reference facility from Element-K ([www.elementk.com](http://www.elementk.com)) in addition to journals and web resources.

Another emerging trend is the growth of the non-IT educational content market. According to International Data Corporation (IDC), of the worldwide demand, 72% was related to the IT segment, but by 2004 the non-IT content market will overshadow it. Online education has been found to transform learning, with local students undertaking global homework, for one thing. In addition to [egurucool.com](http://egurucool.com), NIIT's [netvarsity.com](http://netvarsity.com), and [onlinevarsity.com](http://onlinevarsity.com)

[www.onlinevarsity.com:81/ovc/ovdbhome.nsf/eIndex.ani?OpenFrameset], other dotcoms that provide online content to learners in ways including digital libraries and discussion forums are classteacher.com, studentsguild.com, brainvisa.com, and more. Online education is seen to have limitations as well. Collaboration among fellow students scattered geographically is provided for by educational technologies, but sometimes effective interaction does not occur between them. Another limitation seen in practice is the lack of tutor-learner contact. The most common method of such contact has been found to be through e-mail in the Indian online educational system, where sometimes a communication gap remains between what is communicated and what is understood. Cultural expectations have been shaped by the face-to-face classroom experience and good practices in online education exceed the interactivity of face-to-face classes, so the development of online pedagogy will be the key to overcoming such perceived limitations of the media.

Another obstacle in the growth of e-learning in India is the high prices of computers and the low penetration of the internet and even telephones. According to International Telecommunications Union (ITU) (2002) figures, the PC and the telephone penetration are very low in India.

*Status of ICT in South Asian Countries*

Parameter	Sri							South Asia
	India	Pakistan	Bangladesh	Lanka	Maldives	Bhutan	Nepal	
Population (mid-2001) in millions	1033.4	141.5	133.4	19.6	0.28	0.83	23.6	1379.8
Adult Literacy (%)	58.0	44.1	42.0	91.9	96.9	—	42.9	55.5
Telephone main line per 1000 persons (2000)	32	22	4	41	91	20	12	27
Personal computer per 1000 persons	4.5	4.2	1.5	7.1	20.4	5.2	3.0	4.2
Internet Users (2000) in thousands in 2001	7000	133.9	100.0	121.5	6.0	1.5	50.0	5412.9

*Sources:* ITU and NASSCOM.

According to a Nielson Net report (August 2002), there were 553 million internet users worldwide with the United States topping the list with 166 million (30%), then Europe (24%), and Asia-Pacific (14%). India represented only 1% (5 million) of the global internet users. So India as a whole

cannot be called a progressive state. Even after 7 years of internet development, there is only a 0.5% internet penetration rate in India with a population of 1 billion. High internet usage charges and unequal distribution of telephone networks are major factors in this stagnation. By 2002, there were 7 million mobile phone connections and 42 million landline connections in India. Internet usage charges in India are among the highest in the world, in the sense that users have to pay for both ISP charges and dial-up charges. Kumar (2002) reported that 20 hours of monthly Net access in India could be equivalent to 16.8% of the per-capita gross domestic product (GDP), as compared to 0.65% in the United States, 1.30% in Germany, 0.91% in the United Kingdom, 0.77% in Canada, and 0.12% in Sweden.

According to a survey conducted by eduempire.com in the city of Bangalore, Chennai, and Hyderabad, it was found that only 7% of school students had access to the internet on a regular basis. To reach this un-connected clientele, the entrepreneurs developed different models, e.g., provision of smart cards by eduempire.com to be used for e-commerce and development of e-books by connectschool.com (a venture of Mumbai-based Navneet Publications).

#### **5.4. Social Impact of e-Initiatives**

One of the digital revolutions in India from the field of online enterprises can be seen taking place in the lives of farmers in remote Indian villages. In such villages where lack of electricity and telephone lines are common, with very low literacy rates among the farmers, the dream of e-business has come through an initiative called “e-chaupal” undertaken by Indian Tobacco Company (ITC). “Chaupal” means “village gathering place” in Hindi. E-chaupal can be thought of as an Internet Kiosk, established at a place where villagers gather and discuss business and social issues. This experiment was designed by providing desktop computers powered by batteries charged with solar energy panels and through local telephone exchanges with upgraded equipment through ITC’s finances. The e-chaupal services have been found to be very effective, reaching more than a million farmers across 9000 villages in the states of Andhra Pradesh, Madhya Pradesh, Uttar Pradesh, and Karnataka. This initiative helped farmers to earn more at lower transaction costs by eliminating intermediaries and selling their products directly to the ITC. Other advantages of this initiative to the farmers were access to the latest information on crop prices, weather, and scientific farming practices. Although the plans are ambitious, starting modestly with a definite value proposition, there seem to be some bottlenecks to sustaining success such as unreliable networks, costs of telecommunication infrastructure, and limited IT experience of persons handling these e-chaupals.

E-learning has also been found to be an effective mode of bridging the digital divide in rural areas and smaller townships in states like Maharashtra.



The Maharashtra Industrial and Technical Consultancy Services (MITCON) initiated computer courses through e-learning with 530 centers in the interior locales of Maharashtra. Learners can register themselves at any of their e-schools and access the course content either at these e-schools, a cyber-cafe of their convenience, or at home. Another MITCON experiment in e-learning is launching of e-vidya in the Marathi language in the Maharashtra State, targeted to benefit more than 7500 students. They plan to extend this experiment, in the next phase, to Madhya Pradesh, Chattisgarh, and Gurjarat States. Gurukulonline Learning Solutions also offer courses through their e-schools. Srinivasan (2002) reported the launching of online DE in under- and post-graduate courses by the accredited university Sri Chandrasekharendra Saraswati Viswamahavidyalaya. Instructional material is to be provided online and through a cable TV network (2 or 3 days a week) in addition to sending assignments and so forth by post. The students are also to receive audiocassettes, CD-ROMs, and to participate in scheduled classes by videoconferencing.

Another successful implementation of e-learning modules is noted in Haryana state, where Tata Infotech developed modules for school students with a voice-over in local language and dialect. However, the company puts a word of caution to have e-learning facilitated through a physical instructor for success. Creating content that is tailored to the needs of rural learners also seems to be another sound strategy as shown by Mentrionix Learning Technologies. Haeems (2002) emphasizes the need for multiple access points with easy pay-off options. Multiple channels like cybercafes, local community centers, and e-learning centers can make this approach effective. He further supports the development of localized content to be used for e-learning, as has been done in Europe, for greater effectiveness. Other factors to consider in taking e-learning to remote areas include the development of relevant courseware, the infrastructure, and the provision of trained manpower for tutorial support. In India, there are already Websites in regional languages, as fonts for Indian languages have been developed.

E-learning may further be promoted in rural areas through the launch of e-post services, where the facility of sending and receiving e-mails are now available at post offices in the cities. The users would have to write down their message on a paper and handover it at any of the designated post offices. The message would be e-mailed to the designated address. The connectivity of the post offices across the country has been made through the general post offices located at the district level. This service has been tested on a pilot basis in the states of Maharashtra, Gujarat, Kerala, Punjab, and Andhra Pradesh. The hardware to receive the e-mails has been developed by the National Informatics Center. Efforts are also being made to develop software that could translate the message of the sender into any of the main languages used in India. Currently, the software works in English and Hindi. This will serve those who do not have access either to internet or to a computer.

### 5.5. Projects Initiated by the Government of India

Some projects initiated by the Government of India (Department of Information Technology, Ministry of Communication and Information Technology) are

- The Virtual Campus Initiative of IGNOU ([www.ignou.ac.in](http://www.ignou.ac.in)).
- Small Industries Service Institute, Government of India, Ministry of Small Scale Industries, Chennai, has also launched some courses that are of 4/6/8 months duration. These courses are offered online through distance learning. Few examples of the courses are Diploma in Export Import Law and Management, Diploma in Company, Tax Law and Management, Diploma in Media Law and Management, Diploma in Trade Mark Law and Management, Diploma in Drugs Law and Management, Diploma in Travels Law and Management, and Diploma in Labour Law and Management ([www.sisi-chennai.com](http://www.sisi-chennai.com)).
- Developing a Web-Based Digitized Collection for Distance and Continuing Education in IT—A Demonstration Project on Internet-Based Online Interactive Courseware, by IIT Delhi ([www.iitd.ac.in/courses](http://www.iitd.ac.in/courses)).
- Design and Development of Internet-Enabled Multimedia Courseware for a Virtual University, Pilani ([www.bits-pilani.ac.in](http://www.bits-pilani.ac.in)).
- National Resource Centre for Online Learning NCST, Mumbai ([www.ncst.ernet.in/vidyakash](http://www.ncst.ernet.in/vidyakash)).
- Development of Interactive Multimedia Information Services over a Hybrid Internet and Broadcast Digital TV networks, IIT Kanpur (<http://www.iitk.ernet.in/>).
- Developing Web-Based Intelligent Interactive Tutoring (webIIT), IIT Delhi ([www.iitd.ac.in/courses](http://www.iitd.ac.in/courses)).
- Design and Development of Component-Based Functionality in E-learning tools C-DAC, Hyderabad (<http://www.cdacindia.com/html/events/esci/esci.asp#3>).
- Multimodel Digital Distance Education for IT and Other Critical Technologies, School of Educational Technology, Jadavpur University, Kolkata ([www.jadavpur.edu](http://www.jadavpur.edu)).

The above discussion clearly demonstrates that online education is poised to grow in India. Considerable efforts are being made by the government and non-governmental agencies to establish and promote online education.

## 6. THE FUTURE OF ONLINE LEARNING IN SOUTHEAST ASIA

Southeast Asia covers an area of about 4,100,000 km<sup>2</sup> containing the following countries: Brunei, Burma (Myanmar), Cambodia, Indonesia, Laos, Malaysia, the Philippines, Singapore, Thailand, and Viet Nam (for general

information on these countries, see [sunsite.nus.edu.sg/asiasvc.html](http://sunsite.nus.edu.sg/asiasvc.html)). Some of these countries could be classified as early adopters of the internet but more than half have been plagued with economic and infrastructure problems and were unable to get on the bandwagon as early as the others. The internet eludes the vast majority of inhabitants in Southeast Asia, as they cannot afford individual internet access—that is, a telephone line, a PC, plus internet access in their home.

A recent UN economic and societal survey of Asia and the Pacific reports that in tandem with the world trade growth slowdown, GDP growth declined sharply in 2001 globally, and in the Asia-Pacific region. This is of relevance because the slowdown was particularly evident in the ICT sector and economies with a preponderance of ICT-related manufacturing activities and with high trade-to-GDP ratios, as in East and Southeast Asia, were most affected by the slowdown. This may have resulted in direct cutbacks in ICT expenditures, a crucial component of virtual learning. The events of 11th September 2001 aggravated the slowdown through a loss of business and consumer confidence.

The slowdown in 2001 needs to be seen against the background of achieving the millennium development goals in the areas of poverty eradication, universal primary education, promotion of gender equality and empowerment of women, reduction of child mortality, and improvement of maternal health. In this regard, there are grounds for optimism that most of the goals, including better ICT and internet penetration can be achieved in the Asian region. As of early March 2002, signs of a global and regional upturn are mixed. However, on balance, evidence of a gentle recovery in both the global and regional economies is becoming more discernible. Most Southeast Asian economies are expected to exceed their 2001 GDP growth rates in 2002. For fuller information on rates of economic growth projected to 2004, see UN (2002a).

Varying factors affect the percentage of online users, the most critical being urban/rural concentration, wealth and affordability, telecom infrastructure, familiarity with computers (as internet access is still broadly PC based until remote devices fully exploit it), and IT sophistication. Other significant factors include culture, government policy, a competitive national telecom business sector, English familiarity (as most internet applications and content are mainly in English), and education. The questionnaire results in the Appendix provide more specifics on these factors in the context of online education.

In online reports to date, some countries like Malaysia, Singapore, Thailand, and the Philippines give accounts of public and private participation in e-learning and virtual learning, but several of the more recent adopters like Viet Nam and Indonesia appear to be dependent on private entities for the development of virtual learning in their countries. This could be due to lack of expertise in ICT and of English language skills. For several of the Southeast Asian countries, for which data are not available on the present status of virtual

learning, their future prospects will have to be extrapolated from the extent of internet use.

### 6.1. Malaysia

The medium of instruction in schools and institutions of higher learning was changed from English to the national language Bahasa Melayu—the Malay Language—in the late 1970s. At that time the policy change was an earnest attempt at nation-building, unity, and to preserve cultural identity through the use of the language. However, in 2002 the government decided to reintroduce English as a medium of instruction in primary schools. The impetus for this came with the realization that the citizens of this country may well be left behind in this age of information where English prevails. The government of Malaysia is committed to ensuring that its citizens will be ICT literate in this knowledge economy and information age.

A path has already been defined by the National IT Agenda (NITC Malaysia, 2001) to accelerate the objective to transform Malaysia into a knowledge-based society by 2020 through seven areas of applications currently being developed in the Multimedia Super Corridor (MSC) by international and domestic companies. These are known as Flagship Applications. The *smart school* is one of Malaysia's Multimedia Development Flagship Applications. The Smart School Flagship Application is driven by the need for Malaysia to make the transformation from an industrial to an information-based economy. The smart school is envisaged to meet the requirements of a technologically literate thinking workforce which is well able to perform in a global environment and to use information age tools and technology to improve productivity. As of 2nd May 2002, technology infrastructure has been completed in 9 urban schools and 81 suburban schools (69 secondary, 21 primary) with Data Center and Help desk fully operational. There are plans for nationwide implementation.

In addition, non-governmental agencies are very much involved in the drive to introduce ICT into schools, with The Chinese Smart Schools project, aiming to set up computer laboratories in more than 100 selected Chinese stream primary schools throughout the country, and Private Smart Schools, incorporating multimedia technology and World Wide Web networking, in addition to using ICT as part of the teaching–learning environment and as a subject in its own right.

There are also several commercial initiatives to provide supplementary online tuition for primary and secondary school children. I-Tutor.net, an e-ASEAN endorsed project [my.i-tutor.net/english/](http://my.i-tutor.net/english/) available in Malaysia, Singapore, Indonesia, and Brunei, is one such initiative. There are others offering similar online lessons.

Malaysia's success story has not gone without recognition. In *The Global Information Technology Report 2001–2002: Readiness for the Networked World* released by the World Economic Forum, a collaboration with the Centre for International Development of Harvard University, Malaysia is ranked 35th among 75 countries included in the survey in terms of "Network Use" readiness. This ranking is way above India (60th), the Philippines (63rd) and China (70th) . . . the ranking was based on an index that measured the extent of ICT proliferation using such variables as internet users and cellular phone subscribers per 100 inhabitants, the percentage of computers connected to the internet, and the availability of public access to the internet (Ooi & Jaya, 2002).

Most public universities have incorporated elements of virtual learning to complement the traditional face-to-face classroom. Most distance learning departments in these institutions have adopted some form of virtual LMSs, whether developed in-house, with technology partners, or proprietary systems. In cases where there are technology partners, content is provided by the university concerned, but the virtual program is managed and delivered by the technology partner. Academics from the respective universities are often expected to be the online learning facilitators. If online learning has not taken off in a big way within institutions, it could be partly due to Luddite academics who see online learning as a threat to their position or those who magnify the limitations of online learning to avoid even participating in trial programs.

MSC Status is the recognition awarded by the Government of Malaysia through the Multimedia Development Corporation for organizations that participate and undertake their ICT activities through the MSC. Organizations with MSC Status are entitled to enjoy a set of financial and non-financial incentives [www.msc.com.my/mdc/cs/gc/incentives.asp](http://www.msc.com.my/mdc/cs/gc/incentives.asp) and benefits from the government [www.msc.com.my/mdc/msc/bog.asp](http://www.msc.com.my/mdc/msc/bog.asp). Currently there are 24 higher education institutions with MSC Status.

Students residing in urban areas in Malaysia are able to take advantage of readily available free web resources, in the form of lecture notes, self-access exercises, and internet projects hosted by institutions all over the world.

A leading training institute in the public sector INTAN offers online learning to facilitate learning the English language for officers in the professional and managerial category of the Malaysian public sector: [www.intanbk.intan.my/online/main.htm](http://www.intanbk.intan.my/online/main.htm).

The government is very serious about ICT penetration in the country. Statistics show that ICT initiatives in Singapore and Malaysia account for 6% and 50%, respectively, of each economy's GDP. The government is about to set up 100 internet centers in villages by the end of 2003 to bridge the digital divide between rural and urban areas. Sixteen such centers have been set up to date, with about 60 people making use of each center daily to learn about computers and to access the internet. An allocation of 50 million Malaysian ringgits

(about U.S. \$13 million) was set aside this year to ensure that schools in Sabah and Sarawak on the island of Borneo have internet access, and another RM30 million (RM = ringgits) was provided for infrastructure nationwide. Hence, it is clear that there is strong government investment in communications and IT infrastructure. Internet usage is very high in relation to telephone line provision at 2395 internet users per 10,000 people, with significant levels of local content (Lambe, 2002).

The Government is in the early stages of developing a National Broadband Plan for implementing an infrastructure to support and speed up deployment of broadband services and facilities nationwide. The move to provide high-speed internet access connections *via* the broadband infrastructure is deemed crucial to cater to increasing internet traffic as well as to help spur development of applications and content in the country. This inevitably will be crucial in catalyzing economic growth.

Although the learning demand appears to be quite high, just over 10% of the higher education age range (18–23 years) is in some form of higher education, and this demographic group will grow over the next two decades. However, demand for education is not so sharply defined as it is in the more rapidly developing economies of India and China, for example. Even though there is strong government backing for e-learning and virtual learning, based on the prevailing environment the e-learning market watchers are not very optimistic that virtual learning solutions will take off in a big way in Malaysia in the near future.

## **6.2. Thailand**

IT arrived in Thailand before her neighbors. The first two computers were installed in Thailand in 1964 when only one computer was installed in Singapore and none in Malaysia. The internet was introduced in Thailand in the year 1987. Utilization of computers and the internet is growing steadily every year. As of 2002, about 3 million computers have been installed, and about 3.6 million people in a population of 62 million are using the internet in Thailand. One survey noted that over 70% of the internet users in Thailand are college students who do not own PC's but get access to the internet at cybercafés or university facilities.

In Thailand, the incumbent domestic telephone operator provides free internet access to national Websites and e-mail through a short, four-digit number (1222) to sites located in the country. The government has also announced that by the end of the year 2002, all high schools will be equipped with computers connected to the internet.

Many government and private organizations have introduced e-learning. The first generation of DE in the form of correspondence study was started in the year 1971 and later developed into the 15th generation of Internet DE. For

example, Assumption University has established the College of Internet DE, to start by offering 10 degree programs through the internet, and it plans to eventually provide e-learning to 100,000 students per year. One report asserts that IT and e-learning have been fully adopted in Thailand (Charmonman & Chorpothong, 2002).

In 2000, the Thailand Graduate Institute of Science and Technology, a unit of the government's National Science and Technology Development Agency, offered courses, delivered *via* satellite and the internet, from various Thai universities. In conjunction with Mahidol University, the institute also has begun to offer distance learning Master's and Doctoral degrees in areas such as bio-informatics.

In addition, the National Science and Technology Development Agency has requested funds from the World Bank for a new DE program that is designed to develop a competent workforce in Thailand. The proposal envisions using the Thailand Training Network for continuing education for professionals and a system of post-graduate education for engineers, scientists, and other technical personnel through the private sector or colleges outside Thailand.

There is strong government investment in communications and IT infrastructure. Thailand is also improving PC provision in schools, with almost 60% of students accommodated by better than a 15:1 pupil-to-computer ratio (by comparison, in Malaysia and Indonesia such coverage is 6% and in the Philippines, 14%). Since 1998, schools all over the country enjoy free access to the network. The government has also created a large-scale nationwide education infrastructure. Four thousand two hundred and seventy-four schools were online as of early 2002 and this is projected to continue to expand. internet usage of 556 internet users per 10,000 people is relatively high in relation to telephone provision and is the highest of the lower tier in Asia (including India, Indonesia, China, and the Philippines) but has yet to grow to significant proportions. Malaysia with only double the phone access has five times more internet users.

Thailand has experienced a "pre-paid revolution", with over 70% of internet accounts being pre-paid. Launched in 1998, pre-paid cards are very convenient for users, who can purchase them from a variety of retail outlets, recharge them online or at automatic teller machines (ATMs) and purchase them in a variety of denominations.

Seventy percent of the Thai population is rural. Although there are initiatives to connect the rural communities to the internet, there are many disablers that have to be tackled: the problems involved in reaching rural communities, limited infrastructure (electricity and telephone lines), a high illiteracy rate, limited technological know-how, small demand and supply (from rural people), high costs to invest, and culture: tending not to read and write, but loving story-telling (Sopchokchai, 2002). There is a teledensity of 43 telephone lines per 100 inhabitants in Bangkok but only 6 per 100 in rural areas. Put simply, in 2001 it appears difficult to ensure that each rural village has telephone lines,

and until that teledensity is increased, it may be almost impossible to deliver lifelong learning by IT means to rural and remote areas.

In addition, language continues to pose a significant barrier, because there are not enough tutors to translate information from English to Thai.

Nevertheless, universities and schools in Thailand are connected to the internet. The UniNet ([www.uni.net.th/index\\_e.html](http://www.uni.net.th/index_e.html)) supports and connects all universities and higher education institutions of Thailand. The SchoolNet ([www.school.net.th/index.php3](http://www.school.net.th/index.php3)) project provides and manages a network for schools. As of the end of 2002, 4180 secondary schools are expected to be in the SchoolNet with 3 accounts per school and 40 hours per account, each having a storage capacity of 7 megabytes per school (cf. UNESCO, 2002).

### **6.3. Singapore**

In April 1997, the Singapore Ministry of Education launched a “Masterplan” for IT in education to equip every school with hardware and expertise for e-learning over 6 years (Chua, 2001). The Singapore government recognized that school children were future e-citizens and put its efforts into the school sector. It also recognized that adults would stand on “the other side” of the digital divide unless they could be ferried across to the side where the info-society lives. Singapore intends to have one computer for every two children in school, with one-third of curriculum time involved in IT and e-learning. On the adult side, it is the Singapore government’s intention to have 70% of adults making use of information and communications technology by 2002 (Chua, 2001). An interesting point is that industry is involved in this process not only on the supply side but also in generating a PC reuse scheme for the private sector and members of the public, bundled with free internet access, and e-learning courses.

IDC [www.idc.com](http://www.idc.com) forecast in a press release that there would be 270,000 broadband access service subscribers in Singapore by the end of 2002. This compares with 1.8 million dial-up access subscribers in the country. According to IDC, cable modem is the dominant broadband service in Singapore with Asymmetric Digital Subscriber Line (ADSL) a close second. The research company estimates that there will be 140,000 cable modem subscribers by the end of 2002, compared to 130,000 ADSL subscribers. The overall Singapore telecom services market will exceed U.S. \$4 billion in 2003.

Singapore also has a high learning demand. Provision of tertiary education covers 18% of the higher education age range (18–23 years), with demand exceeding supply, and this demographic group will grow in size over the next two decades. There is a strong cultural pre-disposition to favor advanced learning primarily in economically pragmatic areas, which have traditionally



centered around engineering and IT, but are now increasingly focusing on life sciences and biotechnology.

On the surface, virtual learning appears to be poised to go to great heights in Singapore. A more recent report however paints a bleak picture. At the close of Online Learning 2002, Asia, an e-learning summit in the region, analysts said Singapore companies were reluctant to spend training dollars on e-learning, despite a big push from the Government (Basu, 2002).

#### **6.4. The Philippines**

As in Thailand, the introduction of pre-paid internet access cards has led to an increase in the number of people going online in the Philippines. According to a late 2002 report in the Philippine star [www.philstar.com](http://www.philstar.com), around 70% of internet users in the Philippines are pre-paid card users. The report indicates that the local internet population has reached 4.5 million, of which 3.1 million are pre-paid card users. While the internet has been available since the mid-1990s, the high cost of internet service providers and monthly fees meant that Filipinos have been slow to get online. However, the introduction of pre-paid cards that allow users to go online in internet kiosks, schools and at home has led to a dramatic increase in the numbers of internet users in the region.

Around 40% of online Filipinos are aged between 20 and 29 years, while 12% of internet users are aged 40 or above. The report also indicates that 40% of internet users are based in the capital, Manila.

The Philippines has embarked on the Infotech project for remote areas. Infotech was piloted in six schools and two division offices in the two contiguous provinces of Antique and Guimaras in the West Visayas. Two central schools with access to the internet serve as the downloading stations that access teachers' lessons from the UNICEF Websites, [www.unicef.org/teachers](http://www.unicef.org/teachers) and [www.unicef.org/voy](http://www.unicef.org/voy) as well as other Websites focused on student learning. Downloaded materials are shared with the other schools and the division office. The aim of the Infotech project is to provide teachers and students from far-flung areas of the country with the knowledge, the skills, the facilities, and the materials to use IT and with access to information from the internet.

#### **6.5. Brunei**

There appears to be a strong government commitment to promote ICT within the country. The government spent 11.3 million Brunei Dollars (about U.S. \$7 million) to provide computers to government schools nationwide. Brunei, the smallest yet richest APEC economy, has relatively low internet uptake compared with other developed economies. One government project aimed to increase computer literacy among the younger generation, in the hope that

it could stimulate their interest to learn more about the functions and uses of IT and thus produce IT-skilled Bruneians. From this it can be inferred that Brunei still lacks IT-skilled professionals.

Brunei has a high telecommunication penetration, both for households and mobile phones—95% for households and 30% for mobile phones. And yet PC penetration stands only at 10% and internet penetration is only 7%.

The government introduced the first ISP in Brunei on October 10, 1995. As of November 2001, there were 15,000 BruNet users, of which 14,000 users have subscribed for the dial-up connection and another 1000 are ADSL e-speed subscribers. Introduction of pre-paid internet access cards has also gained popularity among Brunei Internet subscribers. The actual number of internet users in the country is not available, as there are also pre-paid internet services in the form of cards. Pre-paid cards were introduced to cater to the demand of the less heavy user and low-end users as well as to enable users, especially students, to browse the internet within their budget.

A random survey showed that the majority of the users in the low-end category comprised young adults and students, meanwhile the high end users are made up of professionals, especially those involved in the business, multimedia, and academic fields (Garip, 2001).

Unlike in countries like Viet Nam where internet charges are seen to be coming down, in Brunei charges went up early in 2002 by about 20% for dial-up access and 100% for pre-paid cards. Furthermore, there have been recent press attacks on Brunei's ISP for its inefficient administration. In fact, worries have been expressed about the country's march toward the e-future coming to a grinding halt, which would bear on the advent of virtual learning in Brunei.

#### **6.6. Myanmar**

Reuters reports that internet usage in Myanmar is expected to increase 10-fold from 2002 to 2004, from 20,000 to as many as 200,000 people. According to an official from a state-run agency, restrictions have been lifted, which will allow more people in the region to go online. However, blocks on certain political and pornographic Websites will remain in place. The military junta first allowed people to go online in January 2002. However, high costs have meant that the majority of people cannot afford to access the Net.

The military junta in Myanmar has recently approved the setting up of a second ISP, in which private enterprises will be allowed to invest. At present, only domestic e-commerce is possible in Myanmar as the junta has forbidden cross-border online purchases. These kinds of restrictions do pose questions as to whether virtual education originating outside the country will be allowed into Myanmar.

### **6.7. Indonesia**

Indonesia was one of the lowest ranking countries in IDC's study, which tracked 55 countries that account for 98% of IT adoption in the world. IDC based this study on 23 indicators, including the number of PCs per capita, percentage of networked PCs, and the extent of e-commerce.

IDC attributed inconsistent IT progress of lower ranking countries, including Indonesia, to limited financial resources in relation to the vast population. Indonesia's IT market was said to have "expanded vigorously" to achieve 42% growth in 2000 but this figure nose-dived to 1% in 2001. However, this performance is seen to be far better than some countries in the region (Loo, 2002).

Both fixed telephone lines provision in Indonesia at 3.7 per 100 people and internet usage at 186 internet users per 10,000 people are considered low. In addition there are language challenges with literacy in English being low, but fortunately with no script/character set problems as in the case of Thai. The written Indonesian language is based on Romanized Greek.

### **6.8. Viet Nam**

Viet Nam hooked up to the internet in late 1997, but high fees for slow connections and download times have kept the majority of Vietnamese from using it (Borton, 2002). According to NUA Internet surveys, the number of registered internet users in Viet Nam rose by 30% from June 2001 to June 2002. That is, around 175,000 registered internet users were recorded in Viet Nam, equivalent to just 0.4% of the total Vietnamese population. However, it is estimated that as many as 1 million people access the Net through the country's 4000-plus internet cafes (NUA, 2002b). At present Viet Nam remains the lowest in overall per-subscriber and per-capita bandwidth in all of Southeast Asia, and thus suffers both the slowest connection speed and far above median cost for that privilege. There are foreign private corporations who are distributors of e-learning solutions in Viet Nam.

### **6.9. Cambodia**

The first ISP which began operation in 1997 in Cambodia provides various internet packages: dial-up e-mail only, full access, leased line, and wireless access connection with lease of the necessary wireless equipment. In the current offer, after 40 months the equipment will belong to the customer. This means internet connectivity is not restricted to phone line availability (cf. [www.camnet.com.kh](http://www.camnet.com.kh)). The Cambodia National ICT Policy ([www.nida.gov.kh](http://www.nida.gov.kh)) has recently been proposed within the framework of the

eASEAN Agreement. The four main areas of the proposed policy are enhancing information infrastructure, developing human resources, developing local content, and creating the necessary legal and regulatory environment. Goals include creating mass awareness among selected groups by sensitizing decision-makers and government workers to ICT, and introducing the use of computers at schools. The source does not elaborate on the details of how computers will be introduced.

In Cambodia, the status of females is very low and they are faced with considerable oppression. It is difficult for women to enter the public sphere and there are only a few female journalists. The Women's Media Centre (WMC) recognizes the power of media to facilitate social and behavioral change—by giving a voice to women. WMC aims to reduce these inequalities.

#### **6.10. Summation on Southeast Asia**

Some conventional indicators discussed when comparing ICT penetration are fixed and mobile telephone subscribers in the population, internet users as a percentage of the population, and PC ownership. For full and up-to-date information on these indicators in ASEAN countries and elsewhere, see UN (2002b). The ITU reports that in 2000, internet users as a percentage of population in SE Asian countries were as follows: Singapore 24.9%, Malaysia 15.8%, Thailand 3.8%, Philippines 2.0%, Indonesia 0.9%, Viet Nam 0.3%, Cambodia 0.1%, and Lao P.D.R. 0.1% (Minges, 2001). No statistics were given for Brunei. More recent statistics (NUA, 2002a) show growth in internet penetration; for example, Singapore has risen to 51.84 as of April 2002; Malaysia has charted 21.15% as of December 2001; Brunei 9.97; the Philippines 7.77% as of September 2002, Thailand 5.76% in 2001, Indonesia 1.93% as of January 2002, and Viet Nam 0.49% as of December 2001. There has been substantial growth in several countries. Even in countries like Thailand and Vietnam, where language is seen as a disabler, the number of internet users has risen more than 30% recently.

As seen from the above, the vast majority of inhabitants in Southeast Asia do not enjoy internet access, and this is probably because they cannot afford ownership of individual internet access—that is, a telephone line, a PC, and internet access in their home. If internet access is to be boosted, it will have to be through public locations such as schools, universities, and internet cafés. Indonesia has been a trendsetter in this respect.

The growth of virtual learning can be said to be broadly pegged on internet usage. The data above can give a rough indication as to which countries are potential growth centers for virtual education. However, another driver would be the demand for higher and lifelong education. Malaysia, one of the Southeast Asian countries with good growth in internet penetration, does not have that great a demand for formal education sufficient to spur virtual

education. Anecdotal evidence shows that when the virtual arm of a distance learning program was introduced in 1999 in a local institution in Malaysia, there was good response in enrollment, but which sadly dwindled the following semesters. Perhaps, the learning culture is still very much dominated by F2F instructor-led programs. In countries like Indonesia, Thailand, Malaysia, and even Singapore, where a major proportion of the workforce works in small or medium enterprises, which tend to lack access to capital and talent, it is less likely for large slices of the corporate sector to invest in e-learning training solutions.

It is inarguably also a fact that language continues to play an important role in internet usage, and correspondingly in virtual education. Since the internet is led by English language content, some countries, where English is widely spoken (such as Singapore, Malaysia, and the Philippines), have a strategic advantage *vis-à-vis* their neighbors. Thailand and the Indochinese countries especially face extra barriers because their alphabets are Sanskrit-based, making them difficult to adapt to computers. Most policy makers seem to agree that while content development in the local language is very important, the promotion of second languages, especially English, is an effective way of increasing internet usage.

Apart from Singapore, the less wealthy countries of Southeast Asia—Thailand, Indonesia, and the Philippines—have a much lower proportion of the population online, though Malaysia is clearly leading this group due to relative wealth, English speaking capabilities and a higher urban population. However, Malaysian growth, especially for the poorer population segments, is hampered by per-minute phone charges for dial-up access and relatively higher internet access fees. Southeast Asia can expect some strong growth in virtual education if demand for education increases as a whole, if telecom facilities become more sophisticated, and if monopolies in the sector are reduced.

## 7. PACIFIC RIM OPEN AND DISTANCE EDUCATION ONLINE

Asia holds about half of humanity, and it quickly becomes apparent that various assumptions based on Western culture cannot be taken for granted as universally human. The use of educational technology for distance learning is viewed through culture-colored lenses before manifesting in diverse ways.

The Open University of Hong Kong has surveyed Open and Distance Education (ODE) in much of the Asia-Pacific region (Jegade & Shive, 2001), including Northeast Asia from Mongolia to Taiwan, Southeast Asia, South Asia from Pakistan to Sri Lanka, and the Pacific Rim: Australia, New Zealand, the South Pacific, Canada, and the United States. Most countries in Asia have large OUs, having drawn inspiration from the United Kingdom Open University. But they are little-known abroad, and not many have moved far beyond

correspondence by post. OUs in the developing countries are often dependent on outside financial aid to make progress.

It is apparent that the economic level of the country correlates with its use of educational technology and access to online education. Canada and Australia were among the first to adopt DE to challenge the tyranny of distance separating their citizens, and to provide equitable access to educational opportunities. While Canadians are most inclined to form domestic consortia, universities in most countries in Asia are competing among themselves and wary of foreign entrants taking their potential customers with web-based approaches. Meanwhile the United States, seemingly content with its huge domestic market, as in other areas of trade, has put relatively little thought into going international with DE.

Other themes running through the book are the emphasis on quality assurance and the need for teamwork among content specialists, curriculum designers, and computer support staff. When correspondence education goes online, in order to go beyond the so-called shovelware, the application of instructional design principles, much time, experimentation, and expenditures are required. Online media have bared the teacher-dependent learning styles in East Asia, the lack of facilitating skills among veteran teachers, and therefore the need for hands-on in-service teacher training as well as technical support staff. Recognition is also increasing for many other new needs: modularization or standardization for transferability, market surveys, multilingual courses, cultural sensitivity, the need for continuous lifelong education, interactive web-based approaches, and above all, learner support utilizing every available means of communication.

In Japan, the personnel system in public universities has not yet allowed for new occupational categories such as media or learner support staff or instructional designer. Media literacy is recognized as a problem for faculty, not students, contrary to the traditional masterly image of “sensei” that makes faculty development a sensitive issue. Quality assurance also presents an obstacle when fastidious administrators examine a new approach. While progress is deliberate, there is considerable demand for DE programs among teachers, who recognize that computer literacy will be expected of them in the future.

South Korea has made remarkable progress, for example, providing even non-degree programs for teacher training, and aiming for Net-based, government-supported teacher education programs with their own software platform. But they have found teachers not facilitating learning, with students passive, using the PC just for information processing, not as a communication tool.

Similarly in Taiwan, 70% of adult students were found to be teacher-dependent. This finding by the Taiwanese themselves is important, especially for those ready to teach Asians with Western assumptions about student-centered learning. What was found for Taiwanese adults in continuing education is liable to hold more so for traditional students through university age

and across the originally Confucian cultures of China, Korea, and Japan, plus Vietnam, and other parts of Southeast Asia to some extent.

Moving to Southeast Asia, countries may know what to do but lack the resources or funding. The elite minorities, however, who do get a university education, stamp ODE as second class. This was brought out in the Indonesian context but will be a global issue until there is a paradigm shift realizing that “education for all” can only be achieved by ODE.

Malaysia is trying to retool its workforce for the information age, but too few local institutions are preparing ODE materials. Yet, there is a wariness in their questioning if international DE programs can cater to the needs for learning support and regular interaction with instructors. A similar undercurrent is seen in New Zealand. Their government has encouraged open competition, but local universities fear competition from foreign low-cost web-based educational providers. Educators lament that other countries protect their local educational industry.

In Papua New Guinea, where most do not have Net access, officials want those who do have access to take advantage of it with multimedia delivered over the web, but there are also voices criticizing how it serves a privileged minority.

Across the Pacific Rim, North America presents quite a contrast, for example, with Canada’s CANARIE aiming to bring fiber cable connections to the whole country. In the United States the big issue identified is commercialization of higher education, in the “volatile technology sector of the ‘new economy’” (Shive & Dirr, in Jegede & Shive, 2001: 435) where the bubble ended up bursting as commentators in Pacific Asia had long warned. “[F]or-profit educational service companies (*ibid.*) can staff up with many adjunct instructors, [which] trend haunts teaching staff of mainstream universities and fuels their skepticism and anxiety . . . which they tend to associate directly with DL” (distance learning).

The poorer countries show that the above considerations are a luxury, as they have little choice but to admit their need for assistance in getting onto the playing field before asking that it be level. The Jegede and Shive book goes some distance in showing nonetheless that East–West learning should be two-way and interactive like the educational technologies that can facilitate such exchanges.

## CONCLUSION

This chapter has demonstrated that online education is already a global phenomenon. The rapidity of its growth is partly due to the lifelong updating of knowledge and other shared ethics of the global community of scholars, which makes the educational sector ready-made for networking. Indeed this Handbook itself exemplifies the collaboration of co-authors, editors, and the

publisher all in different regions of the world. This chapter and “Virtual Organizations for Online Educator Empowerment” in this chapter and the next one were organized through the WAOE, readily bringing together writers in Japan, Malaysia, Russia, India, the United Kingdom, and Canada. Besides the citations from existing scholarly literature, news sources, and other online resources, the informants thanked in the Acknowledgments below could be rapidly mobilized to present the most up-to-date picture of the emerging discipline of online education.

The world is too large a place to be covered by any chapter, however. Further research, besides gathering more details in more regions on the professional and public issues treated in this chapter, could seek wider perspectives such as those of students and the general public worldwide who could choose to access online educational opportunities in the future. Technologies *per se*, often requiring hand-on experience or training, are accessories or utilities of the global social phenomenon of online education described here. So while any amount of attention could be given to the plethora of software and connectivity alternatives available, more research is needed on how educational objectives are to go through an instructional design process, translated into technologies suitable to the purposes of educators in a given scene of instruction or cultural context. New chapters will be written more rapidly in practice than can be chronicled, so rather than a static field to be surveyed, the ongoing process of scholarly networking itself needs to be recognized as an essential part of the discipline of online education.

#### ACKNOWLEDGMENTS

The authors wish to thank Parker Rossman and Takeshi Utsumi who permitted extensive citation of their work, and those aside from the co-authors whose replies to the Global Online Education Questionnaire are quoted in this chapter: Yolanda Gayol for Latin America, Jesus Granados for Mexico, Rita Zeinstejer for Argentina, Roberto Mueller for Brazil, Miia Suoranta for Finland, Sarah Guri-Rosenblit for Israel, Bunyamin Atici for Turkey, Cecilia Junio-Sabio for the Philippines, Paulina Pannen for Indonesia, Maggie Verster for South Africa, and Dele Braimoh for Lesotho, Nigeria and the Southern African region. The informant for Kenya preferred to remain anonymous.

#### REFERENCES

- Afele, J. (2002). Major ICT Knowledge for Development Initiatives which Impact Africa, Global Knowledge Partnership Annual Meeting, April 2002, Addis Ababa, Ethiopia. Available from: [http://www.globalknowledge.org/gkps\\_portal/africa\\_regional\\_day/ICT4D\\_John\\_Afele.doc](http://www.globalknowledge.org/gkps_portal/africa_regional_day/ICT4D_John_Afele.doc).



- Basu, R. (May 22, 2002). Taking it Slowly: Despite Lavish Government Subsidies, Companies are Refusing to Invest in Corporate E-learning. *Computer Times*. Retrieved from: <http://computertimes.asia1.com.sg/v20020522/updt04.shtml>.
- Borton, J. (February 22, 2002). Vietnam Joins the Internet Revolution. *Asia Times Online*. Retrieved from: <http://atimes.com/se-asia/DB22Ae02.html>.
- Center of Education Technology. (November 18, 2002). Innovative Learning: E-learning. *IT People Evolve* 7(8), 9.
- Charmonman, S. & Chorpothong, S. (2002). IT and e-learning in Thailand. *Presentation at the Conference on E-Learning Utilization in Southeast Asia*, July 22–27, 2002, Tokyo, Japan, Center of the International Cooperation for Computerization.
- Chua, J. (2001). Utilising E-learning to Bridge the Digital Divide: Public/Private Partnerships in Education. Taiwan.APEC.Edu 01–06.
- Garip, S. (2001). Govt Committed to IT Development. Brunei Government. Retrieved from: <http://www.bit.gov.bn/archives/press/2001/nov/govt.committed.to.it.development.htm>.
- Gerson, B. (April 11, 2002). University Helping to Improve Education for Thousands in India. *Carnegie Mellon News*. Retrieved from: [http://www.cmu.edu/cmnews/020411/020411\\_helpindia.html](http://www.cmu.edu/cmnews/020411/020411_helpindia.html).
- Giovannetti, E., Kuttuman, P. & McDaniel, T. (2001). Summary of the UK Team. In: Kagami, M. & Tsuji, M. (eds.), *The 'IT' Revolution and Developing Countries: Late-comer Advantage?* Chiba, Japan: Institute of Developing Economies, Japan External Trade Organization. Retrieved July 28, 2005 from [http://www.adb.org/Documents/Conference/Technology\\_Poverty\\_AP/adb6.pdf](http://www.adb.org/Documents/Conference/Technology_Poverty_AP/adb6.pdf)
- Haecms, M. (November 25, 2002). Taking e-learning to the interiors. *IT People Evolve* 7(9), 2.
- International Telecommunication Union. (2002). Internet Indicators: Hosts, Users and Number of PCs, 2000 and 2001. Retrieved from: <http://www.itu.int/ITU-D/ict/statistics/>.
- Jegade, O. & Shive, G. (Eds.) (2001). *Open and Distance Education in the Asia Pacific Region*. Hong Kong, China: Open University of Hong Kong.
- Konioukhov, F. (1999). Results of AROUND ALONE Ecological Program Implementation: F. Konioukhov's Circumnavigation Project, 1998–1999. Retrieved from: [http://www.greenhed.orc.ru/REPORT%20UNEP%20around\\_alone.htm](http://www.greenhed.orc.ru/REPORT%20UNEP%20around_alone.htm).
- Konioukhov, F. (2002). Following The Great Silk Road: Bactrian Camels Caravan Expeditionary Project. Retrieved from: <http://www.greenhed.orc.ru/Great%20Silk%20Road.htm>.
- Kostina, T., Mamedov, N., & Sedunov, B. (2002). An Innovative Approach to Prepare Specialists for Russian–Japanese Cooperation at the Start of a New Type of Civilization. Retrieved from: [http://www.waoe.org/russia/to\\_japan.html](http://www.waoe.org/russia/to_japan.html).
- Kumar, A. (September 5, 2002). Seven Years of Internet in India—Reliving the Incumbency Factor. *CIOL*. Retrieved from: <http://www.ciol.com/content/search/showarticle.asp?arid=38320&way=search>.
- Kumar, K. G. (March 15, 2004). Open Courses and E-learning. Business Line (Internet Edition), Financial Daily from THE HINDU Group of Publications. Available from: <http://www.thehindubusinessline.com/2004/03/15/stories/2004031500711300.htm>.
- Lambe, P. (2002). E-learning Adoption Factors in Asia Pacific. Malaysia: Straits Knowledge. Retrieved from: <http://www.straitsknowledge.com/Calendar/elearnasiapac.pdf>.
- Loo, P. L. (May 27, 2002). Indonesia's IT Fortunes Begin to Stabilize. CMPnet.Asia. Retrieved from: <http://www.cmpnetasia.com/ViewArt.cfm?Artid=15149&Catid=2&subcat=20>.
- McCarty, S. (2001). What Online Education is *OLS (Open Learning Systems) News* (77), 54–55. Magazine article based on a WAOE Views electronic discussion list message available at: <http://groups.yahoo.com/group/waoe-views/message/1808>.
- Minges, M. (2001). Measuring the Internet in Southeast Asia. Retrieved from: <http://www.itu.int/asean2001/documents/pdf/Document-25.pdf>.

- MSIBA (Moscow State Institute of Business Administration) GLD6 Gallery. (2002). Retrieved from: <http://www.miba.ru/english/index1024.asp>.
- NASSCOM. (June 11, 2002). NASSCOM-McKinsey Report Predicts Robust Growth for Indian IT Services and IT Enabled Services Industry. Press Release. Retrieved from: [http://www.nasscom.org/mediaroom/press\\_rls.asp?PRCode=265 &Type=PR](http://www.nasscom.org/mediaroom/press_rls.asp?PRCode=265 &Type=PR).
- NITC (National IT Council) Malaysia. (2001). National IT Agenda. Retrieved from: <http://www.nitc.org.my/nita/index.shtml>.
- NUA. (2002a). Nua Internet How Many Online. Retrieved from: [http://www.nua.ie/surveys/how\\_many\\_online/asia.html](http://www.nua.ie/surveys/how_many_online/asia.html).
- NUA. (September 13, 2002b). Rise in Number of Internet Users in Vietnam. Retrieved from: [http://www.nua.com/surveys/index.cgi?f=VS &art\\_id=905358376 &rel=true](http://www.nua.com/surveys/index.cgi?f=VS &art_id=905358376 &rel=true).
- Ooi, J. & Jaya, S. (August 29, 2002). Get Right Perspective of Our IT Infrastructure. *Malaysia, The Star Online*. Retrieved from: <http://star-techcentral.com/tech/story.asp?file=/2002/8/29/corpit/ooitray &sec=technology>.
- Rossmann, P. (2002). The Future of Higher Education: For All Worldwide, A Holistic View. A Continually Revised Online Book in Three Volumes, Accessed in 2002. Retrieved from: <http://ecolecon.missouri.edu/globalresearch/chapters/>.
- Sedunov, B. (n.d.). Philosophy of Management. EarthNet Institute. Retrieved from: <http://www.eni.edu/page6.html>.
- Sopchokchai, O. (2002). IT for Good Governance and New Public Services in Thailand. Retrieved from: <http://unpan1.un.org/intradoc/groups/public/documents/apcity/unpan003378.pdf>.
- Srinivasan, B. (November 25—December 1, 2002). Online Distance Education. *University News* 40(47), 18.
- Times of India. (2004). IT Sticks to Growth Path. Thursday, February 19, 2004. p. 11.
- UN. (2002a). Summary of the Economic and Social Survey of Asia and the Pacific, 2002. Retrieved from: <http://www.unescap.org/drpad/publication/survey2002/survey2002.pdf>.
- UN. (2002b). United Nations Statistics Division: Millenium Goal Indicators. Retrieved from: [http://unstats.un.org/unsd/mi/mi\\_goals.asp](http://unstats.un.org/unsd/mi/mi_goals.asp).
- UNESCO. (2002). ICT Policies of Selected Countries in Asia-Pacific: Thailand. Retrieved from: [http://www.unesco.org/bangkok/education/ict/ict.enabling/ap\\_policy/thailand.htm](http://www.unesco.org/bangkok/education/ict/ict.enabling/ap_policy/thailand.htm).
- Utsumi, T. (September 5, 2002). [gu-1] (09/05/02) R&D of Peace Gaming and Global University System. Electronic Mailing List Message Available Online at: <http://www.friends-partners.org/pipermail/gu-1/2002q3/000148.html>.
- Utsumi, T., Varis, P. T., & Klemm, W. R. (2003). Creating the Global University System. Global Peace through the Global University System. Tampere, Finland: University of Tampere Press. Retrieved from: [http://www.friends-partners.org/GLOSAS/Global\\_University/Global%20University%20System/UNESCO\\_Chair\\_Book/Bk\\_outline-D13.html](http://www.friends-partners.org/GLOSAS/Global_University/Global%20University%20System/UNESCO_Chair_Book/Bk_outline-D13.html).

#### APPENDIX: GLOBAL ONLINE EDUCATION QUESTIONNAIRE DATA

Questionnaire responses were streamlined and discussed above, but here is all the data considered valid in the respondents' own words. Respondents are mainly non-native users of English, so some responses are edited for clarity or paraphrased without quotation marks, with additions in brackets, also for clarity. Responses that seemed subjective or unrepresentative of a geographical region have been eliminated. The questionnaire was distributed in September 2002 and most responses were received shortly thereafter.

The questionnaire first asked: *1a. What is your name, organization, country of origin and residence? 1b. What country, region or culture are you answering for?* As for question 1a, respondents cited besides the co-authors have all been identified in the Acknowledgments. As for 1b, the responses below are identified according to the country or region indicated by the respondents.

*2a. What is the general state of the use of virtual learning environments for education?*

*Latin America:* “Regionally well developed, with multiple actors, a tradition, a culture in distance education and the use of e-learning for higher education, continuing education, and e-governance.” *Mexico:* “Some universities are trying to develop courses in this methodology, but very few are taking serious steps to get there.” There is not much knowledge about it among public education officials nor the formal politics to authorize online studies. *Argentina* (“educated middle class”): “Virtual learning environments are still being ignored by most teachers. Educators seem to ignore/reject/fear the inclusion of computers for learning, in general.” *Brazil* (Vicosa, Minas Gerais region): “Its popularity is increasing slowly for a large group and rapidly for a small group.” *Finland:* “There are plenty of development projects around the country and ambition exists to build up communication and coordination for providing more virtual learning possibilities. However, there is a lot of work to do, for example best practises with pedagogy with networking and having enough competence in making good use of technological possibilities in teaching and learning. Also heterogeneity of learning environments and philosophies (open source vs. commercial solutions) is sometimes making cooperation harder.” *Israel* (and Israeli culture): “Our Open University of Israel has a special center for integrating information technologies into our courses. More than half of our courses (about 250) have some components of e-learning.” *Turkey:* “The Internet usage penetration rate is approximately 2% in Turkey. Primary demand must increase. There is an increasing demand for online education but less pedagogical concerns.” *Russia:* “Virtual learning environments in former USSR are not so widely used as in Western countries. There are some causes: bad telephone lines, small amount of private educational institutions as compared to public, lack of money in public institutions to develop distance learning technologies, methods and departments, strong traditions in old governmental schools and institutes.” *India* (“the South Asian region, a multicultural society”): “India in specific and South Asia in general is fast adopting VLEs for education. Already universities and private organisations are going online. Even some universities like Tamil Virtual University provide culture-specific orientation education to the younger generations of learners to tell them about their cultural heritage. Indira Gandhi National Open University (IGNOU) also launched the Virtual Campus Initiative to meet the demand–supply equation for the infotech industry way back in 1999.” *Kenya:* “It is picking up steadily.” *South Africa:* “Very poor. Online education is basically restricted to the university level. Our organisation was

formed by teachers wishing to improve the use of the Internet as a tool for sharing maths resources in order to try to improve the poor maths performance in our country. Computer usage in some disadvantaged areas is limited indeed as quite a few schools do not even have telephones, let alone pc's! Even with 'advantaged' teachers and students, use of the Internet is largely restricted to e-mail." *Lesotho and Southern African region*: "At an embryonic level, with some countries in the lead, but not widespread." *The Philippines*, "Southeast Asian Region and Filipino culture": "In the Philippines, virtual learning is not yet that popular and only a few institutions, mostly profit-oriented groups, venture into such business." *Indonesia* ("and Southeast Asia"): "There are some efforts taken by various institutions—public as well as private institutions, and government. However, they are still at the initial stage of planning and preparation of the infrastructure, structures, etc." *Malaysia*: "Promising. A National IT Agenda aims to transform Malaysia into a knowledge-based society by 2020 [see details in the section on Southeast Asia]. Many traditional public and private universities have some or all of their distance learning programmes available online." *Japan*: Virtual environments have become popular for socializing, but progress has been slow in realizing their educational potential. University and government bureaucracies maintain control and want to know a new territory before allowing it to be popularized. Therefore, a deliberate pace has started with top universities experimenting with virtual university projects and electronics companies doing R &D to supply a perceived future market in e-learning. Technology tends to race ahead of the reasons for its use, with products such as learning management systems appearing before people know what to do with them in terms of pedagogy. While individual educators are experimenting with virtual learning environments, there is not yet a systematic acceptance of online education by the authorities or the general public.

*2b. Is the Internet used for education by a small elite in universities or elsewhere?*

*Latin America*: "Elsewhere." *Mexico*: "Some of them." *Argentina*: "Very few schools have Computer Labs, and out of these, few make good use of them." *Brazil*: "Internet is used a little by many universities." *Finland*: "Internet is definitely not used only by a small elite, but it's widely used nationally regardless of where the user is working, studying or living." *Israel*: "No, it is used by all students in the relevant courses, but for small and specific portions of the teaching/learning process." *Turkey*: "A limited number of universities have used virtual learning environments for education. Most private universities are based on the English language. But most public universities cannot use software like Blackboard and WebCT because their teaching language is Turkish." *Russia*: "Internet is used in almost every university, but not in place of face-to-face teaching. It is only to give students the skills needed for their future jobs, because many workplaces require Internet skills, and the proportion of such jobs will grow very quickly. Graduates of universities,

colleges, and professional schools need the knowledge and skills of Internet utilization to improve their competitiveness in the job market.” *India*: “Most of the universities are connected to the Net. There are also many ISPs. In some regions even cable modems have started functioning. Libraries are also connected through DelNet.” *Kenya*: “The population of users is still negligible.” *South Africa*: “Indeed. The government has started putting measures in place to make Internet access available to all students and teachers, but progress has been slow. Bandwidth and online costs are enormous.” *Southern African region*: “Yes, in some of the affluent universities with a high technological level.” *The Philippines*: “Only a few institutions are using it. At [Polytech] PUP, I encourage students to use the Internet for research. A recent study by our [Open University] PUP OU revealed that 80% of our subject facilitators and students are using the Internet in their teaching-learning process. It is very affordable for students. Not just the elite or those well off but also the underprivileged or marginalized sector of the Philippine society can use the Internet. Computer rentals with Internet cost only 10 pesos or around US 20 cents.” *Indonesia*: “There are some universities that have required all students to use the Internet, but in most places it is used only by some faculty members and students.” *Malaysia*: “Not only universities. Smart Schools with IT infrastructure have reached 69 secondary and 21 primary schools, and the plan is to go nationwide. 100 Internet Centres are to be set up in villages by the end of 2003.” *Japan*: The government has aimed to connect all schools, so even some elementary schools have started web investigations or exchanges with other schools. It is almost all supplemental to regular face-to-face education at this stage.

*2c. Are females much less involved?*

*Latin America*: “Yes.” *Mexico*: “About 60%–40% (men–women).” *Argentina*: “Females are more involved in education than males all across the country.” *Brazil*: “Females are more involved.” *Finland*: “Females use computers as much as males. There’s no difference in the school world.” *Israel*: “Not at all.” *Russia*: “Females in former USSR countries, except the Moslems, are much more active and free than males. There are no cultural or official limitations on women’s activities in business. They can use modern technologies equally with men. But they do not like to get involved in programming. Instead, they prefer to utilize completed and reliable software products. And in this utilization they can be more active than men.” *India*: “If at all, the difference may be of urban vs. rural rather than males vs. females. We have found that females in urban areas are involved to an equal extent.” *Kenya*: “The status is balanced.” *South Africa*: “We are trying to encourage equal access between sexes, but women and girls are still caught in traditional roles.” *Southern African region*: “Females are sometimes in the majority because of the population ratio between males and females.” *The Philippines*: “Research has revealed that females outnumber males in terms of access and familiarity with the Internet. Females know a lot more about computer technology than

males. And most of the students in the open learning system in the Philippines are female.” *Indonesia*: “Yes.” *Malaysia*: “Female students outnumber males students in tertiary education. The same can be said about the academicians.” *Japan*: There is still a tendency for females to be less involved with technology until it becomes very user friendly and fashionable like mobile phones. Although they are Net-enabled, the phones have not been used for much more than e-mail messaging yet. Sex roles will be slow to change, but housewives have the most free time for accessing the Net, so they could be more involved in online education than men in the future when they become comfortable with the Net.

3a. *How do people generally feel about globalization effects—do they feel their culture is threatened or do they welcome a broader cultural repertoire?*

*Latin America*: “Academics are aware of the differences in cosmovisions between developed and developing worlds, speak them out, and are able to negotiate international networks and participation in global projects.” *Mexico*: “Professionals feel it is a good thing provided our culture and values are maintained.” *Argentina*: “Due to the critical times the country is going through, globalization is rather regarded with distrust. Yet, many welcome a broader cultural repertoire.” *Brazil*: “They welcome a broader cultural repertoire.” *Finland*: “There seem to be both opinions; in universities there is little resistance toward a broader cultural repertoire, although there are some disagreements among developers that we should use virtual learning environments developed here in Finland, as they are more flexible.” *Israel*: “Most Israelis do welcome a broader cultural repertoire.” *Turkey*: “The Turks are among the most important nations who have played a role over thousands of years of history. Turkey is situated at an important geographical location, where Europe and Asia meet. The secular state of Turkey has the largest Muslim population in Europe. Globalisation, the result of the impact of technology and power, has its own pluses and minuses like all social and economic facts. The effective operation of the global system with a minimum of errors depends upon the functioning of pluralist-participatory democracy, market economics, national and international transparency and interactions.” *Russia*: “Some young and progressive people welcome international relations, but those who do not know foreign languages or are affected by the former communist propaganda are wary of foreigners. The older generation with a former Soviet mentality in a large proportion still do not trust foreigners, especially because Russia after Perestroika was invaded by foreigners who managed to plunder and help some Russians steal huge amounts of capital. So in a way the old communist accusations of uncontrolled and criminal capitalism have proven to be a reality. It will take a long time to replace that plunder with civilized international cooperation and to restore the lost trust in foreign businessmen and economic consultants.” *India*: “Both. Elders are concerned with the cyber-attack on their culture, while young people are excited with the new medium, making global friends, finding communication much easier and at anytime.”

*Kenya*: “It is welcomed particularly by the elite. The tradition-bound [tribal people] however feel highly threatened.” *South Africa*: “Civil society seems to be against globalisation, but as we are a country with 11 official languages and many cultures, we are working towards intercultural friendliness.” *Southern African region*: “From the cultural point of view, globalization is seen with some degree of resentment. But in the main, the newness of technological development [precludes] its general acceptability and utilization.” *The Philippines*: “People are taking globalization negatively, since they are seeing the effects of it especially in trade and industry and in business. In terms of culture the people are not actually that bothered. But in terms of business (as in import–export) they are actually threatened because currently they are seeing how locally manufactured products and local companies have suffered from the WTO, which is a form of globalization.” *Indonesia*: “Mixed feelings about both issues, but there are also people who have no idea about the issues yet.” *Malaysia*: “There seems to be some demonstration of this fear [of globalisation].” *Japan*: Japanese culture remains strong and well protected by an insular mentality and the language barrier. Most people would like to expand their options to select from the outside world without being overwhelmed by globalization or losing their cultural identity.

*3b. Can you describe any debates within your society about other issues such as language, democratization, equalizing of opportunity, or resistance to change by governments?*

*Latin America*: “There is a permanent debate at the citizens’ level led by municipal organizations on all the above-mentioned issues.” *Mexico*: “With President Fox a lot of things have changed; people want democratization, justice and the rule of law.” *Argentina*: “People are more worried about ordinary, daily issues, such as social, economic changes badly needed at the moment, and education is one of the crucial issues as well. Teachers are concerned with making ends meet, unfortunately.” *Brazil*: “The public online university at URL [www.unirede.br](http://www.unirede.br) maintains a list of discussions involving distance education subjects.” *Finland*: “Telecommuting is one of the things people are trying to solve, both technically and psychologically. Knowledge-intensive work has been very much debated because of the burnout phenomenon that is usual in IT work. Information overflow also has been a very popular debate, how to cope with ever-increasing amounts of information. Of course there has been a debate about our language vs. English, because more and more new words are born that don’t have good Finnish translations. But no concrete changes have been demanded to abate this trend so far.” *Israel*: “There are many debates as to religion–secularism, Jewish–Arab conflict, right–left political orientation, Eastern-origin vs. Western-origin cultures, etc.” *Turkey*: “Turkey could be among those societies shaping the future of the world if it efficiently utilises its geopolitical location, physical and social capital, human resources and cultural wealth. It is also important that people believe and share the goal of Turkey becoming one of the most effective countries

of the world in the coming 10–20 years and their participation in the efforts to this end have to be ensured. In this respect, the general outlook of the country should be presented to the public to enable them to harmonise the requirements and priorities of their own social sub-groups or regions with national priorities. They will then be able to influence the decision-making and implementation processes in this direction.” *Russia*: “The government supports new technologies and methods in education, but there is a drastic lack of money. However, a centralized mentality and system of education makes educators wait for governmental funding for a transition to distance education.” *India*: “The Government of India is promoting infotech growth. Very recently Internet telephony has been opened to the public. The State is promoting Internet kiosks in rural areas to promote education. Just a few days ago the Indian Army gave training to girls and adults on computer fundamentals in terrorist affected areas of Jammu. So the government is fully backing this for the advancement of society.” *South Africa*: “A current debate is one of language in broadcasting as our new broadcasting bill is coming under the spotlight. English is the main language of communications (67% of broadcasting) and we do have 11 languages. Also, the government is seeking to gain more control over broadcasting issues, with the fear being that freedom of speech may be impaired. Our ‘Internet Act’ has just come into effect recently, and the same fears surfaced with regard to government control. As we fought hard for our democracy, we fear that our current government will repeat the ills of the past.” *Southern African region*: “Transformation, democratization, accessibility, equity and gender sensitivity are the concepts now in vogue in societies here and common also in educational institutions.” *The Philippines*: “Most Filipinos know that the only way to bridge the gap between rich and poor or to equalize opportunity is through education. Most families strive to send their children to higher education, which is why about 95% of Filipinos are literate. However, even after a proper education they suffer from unemployment because there are no job opportunities in the country, which is why they usually resort to working abroad. Efforts are being made by the government in embracing the challenges of Information and Communication Technologies. Laws have been made about e-commerce and ICT, and several offices and commissions has been set up to work on government modernization, particularly e-government in the whole bureaucratic system. Filipinos can get a passport, birth certificate and many other services through the Net. The government is not resistant to changes; it is just taking all these challenges in a step-by-step manner.” *Indonesia*: “Issues of democratization, decentralization versus centralization, tolerance and unity.” *Malaysia*: “The importance of ICT is generally well acknowledged by all levels of the society. But the digital divide between the rural and urban population remains a problem. Since Malaysia is a multiracial society, there has been a major debate on the government decision to reintroduce English medium instruction for some primary school subjects. The new policy reflected the realization that falling



behind in English proficiency could prove to be a serious disadvantage in this ICT era.” *Japan*: There is often a tension between the attractions of the outside world and the unspoken prohibition against crossing over by being too unlike other Japanese. Being poor at English and other languages is quite acceptable as a badge of cultural allegiance, but it makes international relations difficult. There is always resistance to change by vested interests, and change can imply that something was lacking in the lifestyle arranged by the paternalistic authorities.

*3c. Do leaders or the media see using the Internet as heading toward positive outcomes for education, international and intercultural relations, or not?*

*Latin America*: “Yes.” *Mexico*: “Yes, they see it, but the change is going too slowly and will take time.” *Argentina*: “Very few professionals appreciate the benefits of Internet.” *Brazil*: “Yes, especially those with an open mind. E-mails are intensively used to spread news and sometimes also to send suggestions to politicians.” *Finland*: “Leading public media are not very much interested yet in virtual learning environments. They cover more about the Internet itself, news about hackers and costs for universities around the world, children’s use of computer games (are they good or do they make children passive?) . . . So I think it has been quite neutral in the media.” *Israel*: “Yes.” *Russia*: “Russian education still is one of the best in the world, in spite of extremely low salaries of teachers equivalent to \$100–200 per month. Private schools and institutes pay much more and can develop new technologies, but there are relatively few private institutions.” *India*: “Yes, with more and more schools and universities going in for online education, it is certainly poised for positive outcomes.” *Kenya*: “Definitely yes.” *South Africa*: “Yes, definitely, and a lot of money seems to be allocated to help solve the situation, but I do not notice a vast improvement in South African educational resources output or the improvement in access or training of teachers.” *Southern African region*: “Especially the elites may be open to using it, but the problem remains that the Internet is inaccessible to the majority who may be inclined to use it.” *The Philippines*: “Yes.” *Indonesia*: “Yes.” *Malaysia*: “Absolutely. The Malaysian Prime Minister has been strongly behind efforts to make the use of the Internet a success in the country. Malaysia has also embarked on an online Continuing Medical Education programme.” *Japan*: The first reaction tends to be protectionism from outsiders, knowing that Westerners are more advanced in online education, so foreign institutions are denied accreditation or recognition in a credentialistic society. What Japanese can accomplish among themselves profitably is fine. Authorities and purists do not want intercultural relations to get out of control, but for now the language barrier provides enough protection.

*4a. Are there virtual universities or other virtual schools?*

*Latin America*: “Yes.” *Brazil*: “Yes, for example Escola do Futuro, Universidade de Sao Paulo at URL [www.futuro.usp.br/mapa/mapadosite.htm](http://www.futuro.usp.br/mapa/mapadosite.htm) or the Post-graduate program in Information and Education at Universi-

dade Federal do Rio Grande do Sul: [www.pgie.ufrgs.br](http://www.pgie.ufrgs.br).” *Finland*: “Yes, a Finnish Virtual University is starting as a framework for providing on-line courses and support services: [www.virtuaaliyliopisto.fi](http://www.virtuaaliyliopisto.fi).” *Israel*: “Altogether e-learning and computer-enhanced learning is viewed positively.” *Turkey*: “There aren’t any virtual universities. Only some universities use virtual education for some courses. For example, there is a virtual education centre at in Bogazici University at [www.tekmer.boun.edu.tr/sem.htm](http://www.tekmer.boun.edu.tr/sem.htm), an education project in virtual environments at Istanbul Technical University at [http://www.saneg.itu.edu.tr/sanalegitim/turk/proje/amac/amac\\_ana.htm](http://www.saneg.itu.edu.tr/sanalegitim/turk/proje/amac/amac_ana.htm), an Internet-based education program at Middle East Technical University at <http://idea.metu.edu.tr/>, and a virtual campus of Anadolu university at <http://bde.anadolu.edu.tr/sanalkampus/webct.html>. I implement my courses from the Firat University Virtual Learning Environment which I developed, at <http://fuvle.firat.edu.tr> and <http://fuvle.firat.edu.tr>. Also, there is an Internet committee in Turkey at <http://kurul.ubak.gov.tr/>.” *Russia*: “Among governmental institutes there are some that have some support for experimental development of distance education technologies. Private universities are working actively and have noticeable results. The largest and the most prominent Russian university working in distance education is the Modern University for Humanity (MUH). It has 100,000 students all over Russia and even abroad. Educational programs are delivered via satellite transmission. They produce more than 500 educational videos a year, have an electronic library, excellent computer classes, hundreds of affiliates, and their own original system of electronic testing. They get the best educators involved and record their lectures. Their sites [www.muh.ru](http://www.muh.ru) and [www.video.muh.ru](http://www.video.muh.ru) have English versions.” *India*: “Yes, like IGNOU’s Virtual Campus Initiative, Tamil Virtual University, NIIT’s virtual university, Punjab Technical University online, and many more.” *Kenya*: “Yes.” *South Africa*: “Yes, quite a few universities locally are taking their courses online. Also a few private institutions are setting up online courses, e.g., [www.elearn.co.za](http://www.elearn.co.za). Distance education, which has always been popular in our country, is definitely moving online fast.” *Southern African region*: “This is a new phenomenon just gaining ground, but not commonly known even among educational institutions.” *The Philippines*: “Yes, but I do not know them and they are not actually popular here.” *Indonesia*: “No.” *Malaysia*: “Yes, UNITAR: [www.unitar.edu.my](http://www.unitar.edu.my). And most public universities have incorporated elements of virtual learning to complement the traditional face-to-face classroom.” *Japan*: The established universities can have virtual programs covering up to half their credits, but there are not yet any wholly virtual universities that are accredited.

*4b. If so, are they accredited or recognized, or considered notorious?*

*Latin America*: “Yes, ITESM is the most visible example” [a virtual university based at the Technical University of Monterrey]. *Mexico*: “No, they are not recognized; they give their own degrees.” *Brazil*: “They work together with private high schools.” *Russia*: “The problem of recognition is understood

and there are well defined quality criteria for distance education.” *India*: “IG-NOU has a Memo of Understanding with Edexcel foundation of UK, NIIT has a strong reputation in the global industry with many branches abroad also. So many are accepted and recognised by suitable authorities.” *Kenya*: “Highly recognised.” *South Africa*: “They are accredited with our accreditation authority SAQA [www.saqa.org.za](http://www.saqa.org.za) and some of the courses have international accreditation.” *Southern African region*: “In some countries of the Southern region there has been an infiltration of such virtual institutions from America and Australia, and have become issues of Cabinet debates in Parliament as to whether or not to recognize them.” *The Philippines*: “They are not yet accredited. The Commission on Higher Education is planning to come up with an evaluation instrument intended for ODL [Open and Distance Learning] institutions, [not yet encompassing] totally virtual universities.” *Malaysia*: “Accredited by the National Accreditation Board.” *Japan*: Since wholly virtual programs are not recognized, for-profit online programs could be considered notorious to look for customers in Japan. But if accredited domestic universities provide online programs, they are recognized.

*4c. Have many people considered studying at institutions in other countries through the Internet?*

*Latin America*: “No, language and costs are a barrier.” *Israel*: “Yes, and quite a few get degrees through distance learning (not necessarily through the Internet).” *Russia*: “Not so many, because Russian salaries are so low that only a small proportion of the population could pay for that kind of education. There is no currency problem, as the country is saturated with currency exchange kiosks. The main problem is that a Russian salary converted into hard currency is 5–20 times lower than the salary for an equivalent job in developed countries. For many students not only knowledge, but also a formal diploma is of great importance. Free education online cannot provide a solid diploma, but to receive a foreign diploma one must spend a huge sum of money as compared with the average salary. And the language barrier is also a serious obstacle.” *India*: “Yes, for some online certificate courses like those for corporations like Microsoft and Oracle, but not yet for traditional courses.” *Kenya*: “Not many, but there is a gradual increase in interest.” *South Africa*: “Yes, I am currently helping some students with courses from an Australian online institution.” *Southern African region*: “People may have such dreams, but the reality is that not many people even in institutions of higher learning have sufficient provision of computers on their campuses, while it may be a mirage for individuals to have personal computers at home with Internet connectivity. This has implications for the awareness level and socio-economic development.” *The Philippines*: “Yes, however it is so expensive.” *Indonesia*: “Yes.” *Malaysia*: “There is still some hesitation in this area, but foreign universities with online distance learning programmes have recorded the participation of Malaysian students.” *Japan*: There have been advertizements in

national publications especially for online MBAs that some working people would consider as an alternative to studying abroad.

*4d. Are there many local companies going into the e-learning business?*

*Latin America:* "Yes." *Mexico:* "There are few, and we are one of them." *Argentina:* "Business companies may be more aware of the advantages of the web. There is a bit of a movement for English language acquisition due to the need for English for job applications, living abroad, and computer literacy." *Brazil:* "Yes, several, including IBM in Brazil." *Finland:* "There are some." *Israel:* "Not [many]." *Turkey:* "Many companies are going into the e-learning business. Some of them are going into institutional e-learning solutions such as Humanitas at [www.humanitas.com.tr/sem.htm](http://www.humanitas.com.tr/sem.htm)." *Russia:* "There are some, primarily dealers of foreign software companies, that advertise online education technologies. Many successful young businesspersons are selling the best foreign products, including computer hardware and software. Most of them do not work for affiliates of foreign companies, but have trade contracts with foreign suppliers." *India:* "Yes, one example is NIIT (National Institute of Information Technology)." *Kenya:* "Yes." *South Africa:* "Yes, but they are quite expensive and not all that user friendly, in my view as a teacher." *Southern African region:* "Not that I know of around here [Lesotho]." *The Philippines:* "Only a few." *Indonesia:* "Yes." *Malaysia:* "Yes for multi-national corporations mainly, for whom e-Learning businesses span from primary education to university and even professional courses. But the 70% of the workforce in small to medium enterprises lacks the capital and expertise to invest in e-learning training solutions." *Japan:* Yes, the big electronics companies and some entrepreneurs, although the dotcom boom has fizzled for the time being.

*4e. Are there academic associations working on the professional development of online educators?*

*Latin America:* "Yes, there are regional and national associations promoting it." *Mexico:* "Mostly this work is done within each institution." *Brazil:* "Yes, see the Associacao Brasileira de Educacao a Distancia: [www.abed.org.br](http://www.abed.org.br)." *Finland:* "Yes. For example there is a national ICT Teacher Training Project OPE.FI: [www.edu.fi/koulutus/opefi/english.htm](http://www.edu.fi/koulutus/opefi/english.htm)." *India:* "Yes, such as the Indian Association for Online Education, whose chief architect is Dr. Sanjaya Mishra." *South Africa:* "What online educators? I am currently struggling to get teachers to use the Internet as an educational resource; teaching them to 'educate online' would present major difficulties." *Southern African region:* "Few if any at all." *Indonesia:* "Yes." *Malaysia:* "Not clearly defined. Online educators still very much remain affiliated to academic associations related to their respective disciplines." *Japan:* Educational organizations concerned with distance learning or computer-assisted language learning have changed their agendas with the advent of the Net, while the government maintains a window to the academic and business aspects of e-learning with the Advanced Learning Infrastructure Consortium: [www.alic.gr.jp/eng/index.htm](http://www.alic.gr.jp/eng/index.htm).

5a. *Is the infrastructure for web access an obstacle for most people or not?*

*Latin America:* "Basic literacy, infrastructure, communication costs and computer literacy are obstacles for the population." *Mexico:* "Yes, because in Mexico only 3.36% of the population have access to the Internet, but this number is growing." *Brazil:* "Yes, at our federal university, students have free access to only 8 computers." *Finland:* "In a very few cases; usually not." *Israel:* "For some, but not for most." *Turkey:* "the infrastructure for web access for most people is not enough. There are a lot of cyber cafes in Turkey. Most people access the Internet from there." *Russia:* "In big cities access is affordable, but rather expensive for regular use in distance education." *India:* "Yes, outside of institutions, slow telephone lines hinder web access. In some areas availability of an ISP or telephone infrastructure may be a barrier." *Kenya:* "It is an obstacle considering the fee levied which is generally not affordable to many people." *South Africa:* "Emphatically yes. The highest speed our national phone line provider allows us is  $\pm 28$ bps, and if you want faster access, ISDN is quite costly to set up. Leased lines are very expensive and out of reach for even advantaged teachers and students. Only larger businesses (25 or more pc's) can afford leased lines." *Southern African region:* "Certainly yes." *Indonesia:* "Yes, it is an obstacle, but also computer literacy and computer culture." *Malaysia:* "Sadly, this is true." *Japan:* No, access is hardly an issue anymore. Computers, mobile phones, PDAs, game consoles and an increasing number of appliances are becoming Net-enabled.

5b. *What are the main obstacles to acceptance or use of the Internet for education?*

*Latin America:* "Access is number one." *Mexico:* "Training, independent learning skills, and cultural perceptions." *Argentina:* "With the rise of the dollar (4 times our "peso" in a few months), computers have become a luxurious tool at the moment. Yet, only three years ago very few people had an e-mail address, while now almost everybody does, which is a step forward." *Brazil:* "Access. Many of our students come from humble families." *Finland:* "Lack of knowledge about technological possibilities for helping learning, learner-centered pedagogy, and lack of good software." *Israel:* "Many difficulties, dilemmas and paradoxes—lack of time, partial replacement of teaching/learning processes, costs, etc." *Russia:* "Low quality of telephone communications and high price for Internet access as compared with the average salary level." *India:* "Ignorance!" *Kenya:* "The cost of equipment, its maintenance and servicing." *South Africa:* "Access costs, infrastructure, poverty, and ignorance of what the Internet has to offer for education." *Southern African region:* "Dearth of infrastructure, financial problems, scarcity of telephone lines, and inadequate supply of electricity to many houses, districts, and villages where people live or work." *The Philippines:* "The Internet is already being used, but expensive infrastructure and all the equipment needed is an obstacle." *Indonesia:* "Computer literacy and computer culture, privacy of information and information rights, and ownership." *Malaysia:* "Cost of access

and infrastructure.” *Japan*: To change the status quo is usually difficult, and there needs to be much more awareness by the general public of the opportunities for education and self-improvement made possible by the Internet. Beyond educational activities among Japanese people exclusively, there is still great cultural insularity and the language barrier when it comes to the outside world.

*5c. Are there any other global or local issues that affect the acceptance of online education or the use of virtual learning environments in your region or country?*

*Latin America*: “Communication costs are very high in Latin American countries; technology is more expensive than in the U.S., and much of it is obsolete.” *Brazil*: “In big cities with high demographic density there are non-governmental organizations interacting with young people in the “favelas” and spreading basic computer use. The government intended to connect all public high schools by computer, but the funds were redirected to the electric company to prevent blackouts.” *Finland*: “Commercial education is not an option for Finland, so the fear of having payments for the courses could be one issue. Another is that virtual learning takes time from other traditional learning activities, so there are worries about the quality of the content.” *Israel*: “Yes, the academic culture in each national setting.” *Russia*: “There are strict traditions in the educational system and opposition of old teachers to new technologies. Computer classrooms in many schools have obsolete equipment, such as old PCs without Internet access. There is also a lack of interest in short online courses or events, which have not yet proven their effectiveness in Russia. An exception is online courses to receive professional certificates from foreign companies, such as Microsoft. These courses provide a quick return on investment: they are very short and the gain in salary after taking them is very high. Maybe it will be the main direction of online education development in Russia, while the salary gap between a certified professional and an ordinary worker remains at a level of 5:1. How much gain in salary and how quickly may be the main criterion for Russian users to select a particular course. Finally, there are difficulties in organizing a complete distance educational system granting professional diplomas.” *India*: “Yes, awareness and access seem to be among the other reasons.” *Kenya*: “Cultural tendencies and attitudes.” *South Africa*: “We currently have a severe food shortage in the region as well as high HIV/AIDS infection rates. Online education becomes a luxury when seen in the light of the suffering and food shortages experienced by a vast number in the Southern African region. Basic education itself is in crisis and very many schools do not even have electricity and books.” *Southern African region*: “Ignorance, low level of awareness, apathy, and insufficient funds.” *The Philippines*: “Older people are unable to use it and are very resistant to [acquiring] knowledge of the use of ICT. They argue that nothing can really equal the value of face-to-face instruction, and that a personal human touch better encourages study, whereas the younger generation is embracing

the challenges and maximizing the use of ICT.” *Indonesia*: “National issues: infrastructure is expensive, therefore access is low and difficult, while the users are computer illiterate, and technical expertise is rare.” *Malaysia*: “The major challenge would be having enough quality online educators who can develop good online courses that offer the kind of support that Asian students look for.” *Japan*: On the one hand, mental attitudes in a traditional culture with elaborate face-to-face rituals raise many barriers. Living in a social world where relationships are all important, new commitments are problematical because they incur heavy obligations. On the other hand, the dynamics of the Internet itself will attract Japanese people and allow them to browse world cultures from a safe distance. The Net-connected screen may thus provide a 21st century version of the traditional hand-held fan or folding screen, buying the time necessary, uncommitted and free, to consider becoming more involved in the outside world.

## Chapter 29: Global Virtual Organizations for Online Educator Empowerment

NICK BOWSKILL\*, ROBERT LUKE†, AND STEVE McCARTY‡

\*University of Sheffield, England; †University of Toronto, Canada; ‡Kagawa JC, Japan

### 1. INTRODUCTION

The authors of this text have never met. We live in different continents and different time zones. We do however share the same space and the same organization for at least some of our professional development. We are all members of the World Association for Online Education (WAOE), which is a virtual and voluntary organization for those interested in online education. Entirely virtual organizations represent a significant new form of social organization. The world community of scholars with shared academic standards and ethics is well poised to utilize the online medium for mutual empowerment and relevant social action in the so-called real world that originates, organizes and builds strength in cyberspace. So as a virtual organization and professional development vehicle for educators, WAOE itself can also be understood as a virtual learning environment (VLE).

In this text, we conceptualize the WAOE as a VLE not in the sense of another WebCT or Blackboard (or similar software system), but rather as a perceptual home for learning in virtual spaces. The organization is an online venue for global all-comers who share similar values and interests in professional development and online education. As such the software used is not the central issue. By providing activities, events and resources within the online community we become a VLE in the manner of a floating venue for globally accessible interaction, offering learning opportunities for all. We thereby extend and re-conceptualize the more traditional understanding of VLE as based on a set of tools into a conceptual and cognitive apparatus. This re-visioning fits more tightly with the ideas of empowerment that we explore in more detail below.

Two leitmotifs run through this discussion. One is about the concept of transfer into self and the other is about informal learning as a vehicle for professional development. Taken together, we believe there are interesting messages for the empowerment of individuals and groups within communities of practice. We will discuss this goal of transfer into self as a holistic and constructivist goal and as an idea that marks a contrast to the more popular goal of transfer into practice. Our discussion of transfer to self *vis-à-vis* transfer to practice is intended to elucidate how online communities of practice can function in a distributed environment such as WAOE to empower participants.



This chapter also stresses the importance of informal learning in contrast to, yet in conjunction with formal learning processes. After highlighting the significance of informal learning, we will move on to talk about how this kind of method can be supported, and discuss some of the mechanisms for both individual educator and group development. The method used to develop the case study was the development of a rich description of our collaborative activity accompanied by autobiographical accounts of those involved. These accounts help toward any wish to assess the validity of the particular case study and also function as a reflective and developmental apparatus. We use our own collaborative experience within a voluntary online community as a case study of these ideas being put into practice. The aim is to convey this framework as an architecture for empowerment and as a form of distributed learning. Defined as that learning which is distributed in time and space and enabled by new technologies (such as VLEs), distributed learning is a particular catchphrase for learning within the networked relations of the digital world. Distributed learning may be formal or informal; it is marked by the “any time, any place” ubiquity afforded by the internet and the World Wide Web, and the manner in which people engage and interact in learning activities both locally and globally. The WAOE functions as a distributed learning environment—a VLE in support of learning about learning and learning about learning online.

We begin with a brief discussion of the transfer of experiences into learning whereby experience is made personally meaningful. This has much to do with the identity of the learner. We use the term “Transfer into Self” in opposition to the more current and popular learning goal of transfer into practice. We advocate a focus on transfer into the self for a number of reasons. The first of these has to do with the changes in the world that many of us experience first hand. These changes are external changes over which we often have little control. Economic changes and altered career prospects have an enormous impact upon individual lives. Likewise, political and technological environments are equally volatile, and in such circumstances our sense of identity is vulnerable to disruption. To invest in a focus upon practice is fine and has value, but it should not be the primary focus of learning. If you no longer have a job or a practice in a month or a year’s time, the focus of development needs to be intrinsic to the self.

Another reason for looking beyond transfer into practice is the implicit behaviorist or instrumentalist view this takes of learning and knowledge. How we practice is a manifestation of what we think and know, but the rationale for that practice may be hidden from view. In addition, our practice is different according to context, so to view only the practice is too situated a position from which to make generalizations. A focus on the transfer into the self is much more portable and humanistic in the context of concepts such as lifelong learning and holistic development. We will make the case for transfer into self and show how this might be achieved through writing processes and autonomous approaches to professional development within online communities. This will

be considered in our own context of collaboration *within* a community of practice. We offer this as a model for empowerment.

We are concerned with the development of individual and collective autonomy/autonomies and therefore attach importance to mutual support and informal learning development. The value of informal learning beyond or together with formal learning will be more evident in this context. We believe that each strategy offers unique resources and learning opportunities. We describe our own informal learning activities that are supported and sustained within a voluntary virtual learning community that provides global access to professional development activities. This particular community, the WAOE, is a collaborative initiative offering a range of events, activities and resources for members to access independently at any time or to utilize together at scheduled events.

The WAOE encourages, and thereby hopefully empowers people across the world to participate and to shape the activities and development of the community. We will describe the range of such activities to give a flavor of this infrastructure for collective empowerment and also go on to talk about one particular shared event. This event will serve to illustrate the use of the community to identify common interests and to co-construct a learning project to address those interests in an equitable relationship with benefits for all. This example illustrates how autonomy and power relationships can be addressed and developed outside formal educational systems. We believe that although there are clearly times when formal learning plays a vital role in learning and development, formal systems can also be an inhibitor to learning. A simple example would be when a casual conversation with a colleague or friend results in some valuable but unplanned learning. One of the conversational participants observes that such conversations are too few and therefore proposes another meeting on a set date at a set time. When that appointment comes around, it is quite possible that one or other of the participants is not ready for an in-depth discussion or has forgotten the origins of the initial idea. The formalizing of the casual conversation has killed the learning in this instance. When shared concerns are housed within systems that need to follow schedules and external criteria as well as also needing to work within course structures and designs, they can be barriers to learning. Such an environment can add psychological noise to learning projects. Informal learning, at its most effective, can offer a low noise environment conducive to exploration, discussion, and creative learning. We will illustrate this with our own case study drawn from our shared experiences.

Learning communities like WAOE can be part of a vital and valuable informal learning support framework. They can support top down and bottom up ideas and projects and they can support a move along the axis of development from dependency to autonomy. For some participants, it is enough to be a vicarious learner acting as a learning audience in discussions and events. For others, they may participate in some events more actively, and for yet others it

offers an opportunity to identify needs and interests, to collaborate with others to design and deliver events for others in the community. We will give an example of this from within the WAOE. This community-based environment is one way of supporting informal learning.

Another method for the support of informal learning is to intermittently crystallize understandings into a communicable form. This means to be able to externalize tacit knowledge and it also means to crystallize and share understandings amongst a wider audience. We will show how this is done within the WAOE community through shared autobiographical reflections upon learning events constructed amongst members. This is elaborated in published writing that explores and refines initial understandings into conceptual frameworks that support further research and development in the community. We have already published some initial work reporting on our learning activity elsewhere (see Bowskill et al., 2000) and here we reflect on that in greater depth and begin to theorize around that initial work together. These different approaches to the use of writing are a by-product and further evidence of informal learning. It is also a very empowering approach, both individually and collectively, in the way it feeds into other areas of professional activities.

We begin with a very brief overview of the WAOE as the heart of our own informal learning environment before moving on to explore more general issues in informal learning. We will give a wider historical view of the organization later as a means of conceptualizing our case study of empowerment. Following the section on informal learning, we look at issues of support. We consider support and development beyond formal education systems. The community model is used to show the empowerment opportunities for global participants who may have no access, money or qualifications to participate in formalized arenas.

### **1.1. Overview of the WAOE**

The WAOE is a non-profit public benefit corporation registered in the state of California, but its membership spans five continents without being dominated by any geographical region. The WAOE is chiefly a virtual association serving the needs of academics and educators concerned with turning online education into a professional discipline. The WAOE focuses on combining dedication to online learning with social and cultural exchange. The objectives and purposes of the WAOE explicitly promote humanistic ethics and global collaboration in online education, specifically:

- (i) to maintain a global perspective as a world organization, supporting multilingualism and multiculturalism in online education, preserving human rights to diversity and mutual respect despite differences, and encouraging intercultural sensitivity and world reconciliation through intercultural communication among global citizens;

- (ii) to be as inclusive as possible in scope, serving the aspirations of all members and working for equitable access to online education and to membership.

For more information see: <http://www.waoe.org/npo/bylaw.htm>.

WAOE is an informal learning environment, a space where its members can collaborate, learn from each other, and engage in meaningful dialogue across cultures on the nature of learning, learning online, and of online culture in general. Educators have a special responsibility to acknowledge and analyze how “cultural practices relate to future vision[s] of community life” (Giroux, 1992: 239). Undertaking this analysis in practice means cultivating critical communities of practice that have common goals and respect for difference. WAOE represents a critical step toward acknowledging how active participation in the networked society can create meaningful conditions for cultural difference and diversity to be celebrated and incorporated within the logic of the digital era. This active participation includes the exploration of how the self relates to broader practices within online education, and the further refraction of this within broader communities of practice.

The WAOE originated appropriately at an entirely online conference (McCarty, 1997; Shimabukuro, 2000). At the First Annual Teaching in the Community Colleges Online Conference in April 1996, McCarty contributed a “paper” to the conference Website, exchanged asynchronous e-mail discussion list messages automatically posted to web archives *via* hypernews, and joined other presenters not only in synchronous MOO (Multiuser chat rooms utilizing Object-Oriented programming) sessions to discuss papers, but also in “digging” one’s own Webbed MOO room accessible either by chat programs or *via* a web interface. In such text chat, descriptions of the environment and a repertoire of communication gambits rely mostly on the imagination of literate participants to share a virtual reality in the VLE. To the extent that participants took advantage of opportunities to interact with one another at a distance through such communication tools, evaluations showed that little was left to be desired compared to face-to-face conferences. Such online conferences were open to all kinds of educators, especially those outside of North America, with the access, content, and educational technologies all empowering to participants.

So then, with such tools available, why not try to network with educators globally all year round? The keynote address of the Third Annual Teaching in the Community Colleges Online Conference (McCarty, 1998) proposed the need for an organization to turn the new frontier of online education into a professional discipline. Online conference discussions continued for months until an independent, almost completely online organization was born, the WAOE. Through an Estonian organization the [www.waoe.org](http://www.waoe.org) domain was registered, and a professor in California’s capital registered the WAOE as an NPO. However, the location of web servers makes little difference,

and NPO status turned out to involve no tax savings but to represent the WAOE's idealism. An e-democracy from the start, the founding principles, then Bylaws and Directors were voted upon entirely online with impartial procedures supervised by a Cyber-Parliamentarian.

WAOE was announced in November 1998 and quickly approached 1000 participants from 50 countries, showing that a need had indeed been met". [O]fficers hail from nine countries thus far, so WAOE is not dominated by any geographical region. WAOE is open to all those who are committed to pedagogical principles and interested in networking with other online educators worldwide (McCarty, 1999). Wandering from list to list, Website to Website, like so many nomadic masterless samurai, what online educators have been missing is a real organization".

That WAOE has shown sustainability belies the notion in business circles that a virtual organization is *ad hoc* and temporary. Communities of practice such as WAOE are organic wellsprings of like-minded people engaged in learning together. Though people do not meet face-to-face, a virtual organization like WAOE using all sorts of electronic means of communication to bring people together for information exchange, mutual support, and collaboration in a new field demonstrably serves real needs.

It is human nature to shy away from trying something new, and educators are no less susceptible to technophobia. So WAOE has made conscious efforts to use the widest range of VLEs. WAOE officers have also expected to field questions about the options available or comparisons thereof. Even the legitimacy or motives of VLE vendors and purveyors of experiences therein have been at issue. So WAOE officers have had to be particularly bold and take every opportunity such as executive meetings to try mastering yet another VLE.

e-mail discussion lists have provided a sort of environment for WAOE communications and, archived on the WWW, have left a trail of WAOE's proceedings. During and after the TCC Online Conference, from April to October 1998, 320 messages still available at the University of Hawaii at URL <http://leahi.kcc.hawaii.edu/org/tcon98/discuss/keyone-l/> show how WAOE was incubated by the conference registrants. Within weeks of the conference *per se* a moderated news list for the nascent organization was secured at the University of Idaho, with 71 messages from April 1998 to June 1999, recording milestones still available at URL: <http://www.uidaho.edu/list-archives/waoe-news/>. In July 1998, the unmoderated discussion list WAOE Views, open to anyone interested, was established and continues to this day with over 2500 messages as of September 2002 available at URL: <http://groups.yahoo.com/group/waoe-views/>.

While the Views discussion list has been archived through Yahoo Groups, the listserv has actually been based at WAOE's ISPs. In terms of environments, the new organization needed a (virtual) home, especially with no particular office in so-called real life. About a month after the online conference, in early

May 1998, Mihkel Pilv in Estonia registered the domain name [www.waoe.org](http://www.waoe.org) and found an economical ISP in the U.S. Among the Charter Members and a Steering Committee that gathered, some of the latter started developing the Website to give the group a permanent central residence in cyberspace.

Other VLEs were nevertheless utilized as the ISP could not serve all the kinds of communication called for by WAOE activities. An unconventional Constitutional Convention was convened at a bulletin board system in Connecticut. There was also a cgi form with which to respond to messages from one's browser. Already a pattern was emerging of leveraging the skills and institutional resources of active members' institutions rather than waiting for grants or other types of funding. Also in May 1998, the WAOE-affiliated Journal of Online Education was established at New York University, available at URL <http://www.nyu.edu/classes/keefer/waoe/waoej.html>.

In June 1998, Prof. Jenna Seehafer of California State University started incorporating WAOE in Sacramento as an NPO, after intense discussions on what kind of organization WAOE should be. In August 1998, Charter Members voted to approve WAOE Founding Propositions and the first slate of elected Directors, with a view to establishing formal Bylaws. A cyberspace equivalent of non-partisan face-to-face parliamentary procedures was developed to hold all voting and elections online, through web forms feeding into confirming e-mail messages, conducted by disinterested scholars. The State of California Attorney General's office readily accepted the WAOE Bylaws despite all the Directors being in different countries, never meeting in person as is customary for NPO proceedings. Rather the State was watching WAOE with a view to future online elections.

American facilities were conspicuous at the beginning, with Westerners providing most of the VLEs, but always sensitive to the international membership. A wholly positive form of globalization has been evidenced in the way Westerners have often stayed behind the scenes, amplifying non-Western voices and encouraging their ownership of the organization, which has manifested in a balanced geographical and cultural composition of the officers. WAOE-commissioned Websites in an increasing number of countries lent a palpable sense of a deliberately distributed organization actively avoiding centralization in any geographical region or cultural norm. The intent of the W in WAOE was to start from that goal.

In 1999, the Multilingual WAOE project was launched, strengthening the commitment to multiculturalism. A number of cultural events were also planned from that year so that members worldwide could learn from one another and exhibit cultural diversity while enjoying their shared interest in online education. The WAOE World Culture Festival in February 1999 utilized an array of VLEs, with synchronous chats and WebBoard events along with asynchronous e-mail discussions. Web-based presentations with photos captured festivals taking place at that time of the year from Balkans to Brazil. In July 1999, WAOE collaborated with the Child Research Net on Summer

Festivals in Japan, discussions accompanying a web presentation. At the end of 1999, New Year's greetings for the year 2000 were compiled in 20 languages with photos of Brazil and an interactive game by Prof. Roberto Mueller.

WAOE's affiliations have followed a similar pattern, promoting online educational efforts in Latin America and Malaysia as well as the U.S. and Japan. While some founding members had donated funds to start WAOE's online presence, dues were deemed necessary from mid-1999. But paying the U.S. \$10 yearly figure online was problematical especially for those using other currencies, so there was a significant loss of participation. Within a year WAOE found modest sponsorship through officers' services to a Tokyo educational NPO, so in mid-2000 WAOE abolished dues and returned to its desired ideal of access for all concerned with the improvement of online learning. All along WAOE maintained a dual mission of serving international society as well as serving members, so there was always free access to WAOE's information and the public discussion list Views.

Prof. Jenna Seehafer conceived of the mid-1999 Annual Members' Meeting in the form of a web tutorial, where members could follow a certain sequence of steps, and visitors could learn about the organization in that way from then on. Remaining valid so long as WAOE needed membership dues, the tutorial format intuitively appealed to the human need for an orientating structure to navigate the complex labyrinth of cyberspace with a sense of situatedness.

## **1.2. Informal & Formal Learning**

“The existence, significance and necessity of informal learning needs to be more widely acknowledged by policy makers, practitioners, employers and researchers.”

(Coffield, 2000: 8)

Common conceptions of the WWW as an educational setting are largely predicated on the formal, directed use of technology. However, informal aspects of learning often go unacknowledged within formal educational settings (Apple, 1990; Cherryholmes, 1988; Giroux, 1983, 1988, 1996, 2000). Informal learning is important in itself; important in the way it is connected to formal provision; it is important within a course and institutional context and also within a wider community context. This section will explain these positions in more detail and consider issues about recognizing the significance of informal development through the provision of appropriate support. It will lead into a discussion of WAOE as an open learning environment.

We begin by looking at informal learning in contrast to stereotypical models of formal learning provided by Eraut. A brief overview of the literature shows the difficulty in trying to define informal learning. For some, it is defined in contrast to formal learning. The list below is a re-phrasing of one view of

Table 1. Overview of the relationship between formal and informal learning

	<b>Formal</b>	<b>Informal</b>
Percentage of all learning (Masie, 2002 cited on Managers Forum)		50–70%
In an average week (Livingstone, 1999 in Long, 2001: 18)		15 hours per week
In first 3 months of starting employment in a company (Bishop, 1991 in Long, 2001: 18)	8%	92%

formal learning (Eraut, 2000: 12) available as a basis for considering all that sits outside or in contrast to such a model:

- Set learning environment.
- Organized events or packages.
- Presence of teacher or trainer.
- Accredited.
- Someone else's outcomes.

If we use this model to construct an initial definition of informal learning this may help us understand the relationship between and use of the two modes. There are some interesting statistics in the literature that indicate the relationship between the two ends of the range. The table (Table 1: Derived from Long, 2001) below gives an overview of the use of formal and informal learning from different studies in the literature.

The key point that emerges here is that although formal learning may be very important in providing opportunities and space to develop learning and to seek accreditation for instance, it plays a comparatively small part in the totality of our learning. Whether we look at this based on an average week, the initial stages of new employment or across a lifetime, the message is the same. Informal learning is the major part of our learning activities and yet receives much less recognition and much less support. Part of this lack of support has to do with the obvious difficulty in pinpointing how to offer support and what kinds of support might be most useful. There is a need to make a rich enough provision to address different levels of need and different areas of interest.

Learning may begin with a discussion at the informal end of the range and move through to registering for a course. Informal learning may sit alone or as part of a progression toward participation in more formal provision. People may also be at certain points in this range and have no need to move from those positions. Informal learners may feel they can address all their needs this way, and likewise a formal course may be all that is required to resolve a problem. Our argument here is that one of the best ways that a learning



community can support informal learning amongst its members is by facilitating discussion amongst its members. Beyond this, learning communities can more usefully facilitate focused discussions on the particular needs and interests of collaborating members.

The uses of casual conversational opportunities are important within this range, hence the highlighting of discussions in the table. Rowland (1993) talks about the potential of such discussions as learning conversations. These are both timely and sense-making opportunities when they are available. This issue about availability is key for thinking about the provision of support for informal learning. Smith (1999: 12) mentions a need to offer “a range of accessible and useable opportunities for self-education” as a guide for such support. In what follows, we begin with a possible scenario in which institutional support is provided for informal learning. This is partly drawn from practice, but the main reason for offering this is to relate a vision of how support for informal learning might be developed and implemented. Support for informal learning needs to look beyond accessibility issues toward issues of self-management and support for greater control. Learners might define their own needs and address them in different ways using different resources.

In his discussion of self-managed learning, Cunningham (1994) relates different scenarios wherein a learner calls upon a community to support personal learning goals and uses a course to provide a framework in which to learn within a course community. This description indicates ways in which support for personal concerns can be drawn from fellow learners and community members as well as from tutors, etc. Smith and Cunningham share a view of the significance of discussions and community support as vital to the development of informal learning. Indeed, we hold the facilitation of focused discussions and the value and role of a learning community to be vital issues in the support of informal learning. We therefore hold these issues in the foreground of this text as we seek to explain and explore the value of informal learning in our own context.

Smith talks about accessibility to learning opportunities. Boud (1981) on the other hand highlights the role of a learning community as available support. Boud (1981) goes on to discuss the goal of supporting and developing autonomy. He defines autonomy as learners becoming their “own person in context with others” and Cunningham’s self-managed learning is referring to self-directedness within a mutually supportive wider group context. The missing link is the development of a recognition in the learner of the potential implicitly available within an online community and the factors that contribute toward the development of awareness in the learner. It is not enough to suggest this potential to the learner. Much of it comes from experience but it the kinds of experiences and the support provided can also be influential.

Boud and Cunningham discuss their theories in the context of a course-based model. It is our contention that this is entirely reasonable but that

perhaps the real test of self-management and autonomy is within a more open setting. This is important in a lifelong learning context. In a networked world, learners are afforded and demand a wider view of the possibilities for development. The boundaries for interaction are not imposed at the edge of the campus for example. It is possible to associate and collaborate with highly distributed people with shared interests. The form of collaboration is also flexible in terms of time and purpose. Local provision may also be inadequate for addressing the needs of particular people and expertise may be more limited in its availability. Jobs and careers may also be more prone to fracture and professional development needs may span different contexts. A new perception of learning communities as sustainable meeting places for professional development activities is required. This may already be partly in place but we suggest a need for such communities to look beyond being context providers and toward becoming informal project centers is more useful.

So far, we have looked at a sampling of the literature that makes extensive reference to course-based informal learning and we have outlined an institutional scenario of informal learning and support. In a networked world, the sources of informal learning may be internal and external and with those possibilities in mind we turn now to look at online voluntary communities as another extension of that informal support. These communities are a valuable source of resources, knowledge, and most importantly, dialogue opportunities. When local informal opportunities are exhausted or unavailable or inappropriate the value of such communities is high. Such communities are part of the bridge between informal development and formal development and they also extend the resources and accessibility of them for informal learners. The role of these communities as part of the informal support system becomes much clearer in this model and its accessibility provides an alternative and/or complementary learning arena.

To connect the social setting of the online community with the individual interacting within the community we are interested in the role of autobiographical accounts. Such accounts contribute toward the individual and collective knowledge management task. In the following section, we look at the issue of capturing knowledge and supporting reflection on experience. We will show how this can be done at an individual and a group level through the use of autobiographical writing and research.

### **1.3. Autobiographical Research**

The use and validity of autobiographical research methods are becoming more widely valued and accepted (Dhunpath, 2000; Merrill, 2002) but what are these methods? Perhaps, we should begin by saying that autobiographical methods, used for research purposes, are quite distinct from the use of autobiographical writing as a general contribution to literature (Griffiths, 1994). In the research

community they have a specific purpose and, broadly speaking, that is to understand the meaning of experience(s).

There are similar but distinct variations within this area of research methods that include life histories, biographical research, narrative inquiry, and more. There are differences between these methods and implications resulting from the selection of any one. It is not our purpose to explore the different flavors and distinctions between them, but for those interested we would point to a useful overview provided by Dhunpath (2000). Here our purpose is to explain and argue for our use of autobiography as both a personal and collective professional development and research method.

The use of narrative forms of inquiry offers the author and reader “the inside story”. This means we have a view of the experience as it is understood by those involved. This approach may be more respectful of the individual’s views and culture. It may also be a more accurate way of investigating the experience in contrast with a template of questions given to each participant. This is in contrast to the more interpretative view of a given researcher as an outsider to the actions and thinking processes involved. This method is distinct in its narrative form having an explanatory role for the self and others. Oral history is a related methodology, and interviews are sometimes involved in the capturing of the story, but such methods have other implications for control, publication, and development. The written form is particularly significant in this kind of approach. It is therefore quite distinct from oral traditions, for example, although it has much in common with other forms of self-explanation in general as a communicative act. Autobiographical approaches bestow some control upon the subject and may thereby help to overcome the feeling of being perceived as a data mine for other people’s research.

These strategies can be positioned within an action research framework to form part of an overall development process that may include other strategies in the study. We believe that the use of autobiographical methods within an action research approach offers the best chance for the development of a voice for all concerned (Winter, 1998). In the following section, we position such strategies alongside other possibilities in order to further explain our reasoning for valuing this method.

Above all we should hold in mind that any approach to research cannot be considered neutral. The researcher in any study comes with an agenda and accordingly frames the data and the research project in a particular way. The researcher is always involved in a selective process, and subjective responses and individual perceptions are as much a part of quantitative strategies as they are in qualitative methods. It is quite likely that two researchers replicating the same experiment will act differently, select differently, perceive significance to be located differently, and will understand or frame the context differently. We would argue that any research strategy has a subjective element, and it is valuable to understand more about the subjective nature of any research. This should go part way to justifying the use of autobiographical methods, but

rather than simply defend the use of this strategy, we should perhaps explain some of its benefits and its appeal to us. Moreover, all reports from any study are constructions framed in particular ways for particular needs and with a particular audience in mind. We must not be blinded by the apparent authority of any given research method.

One of the roles of autobiographical approaches is to explain the meaning of phenomena. This approach can show how people subjectively experience institutions, organizations and other phenomena (Gitlin et al., 1992: 32). Equally important in our decision to adopt narrative methods is the unique way that it affords a view of both the individual and the collective in context. More importantly, this kind of approach has particular value in considering the tensions and relationships between the private and the public domains.

“... the life history approach is probably the only authentic means of understanding how motives and practices reflect the intimate intersection of institutional and individual experience in the postmodern world.”  
(Dhunpath, 2000)

An authored text is constructed in personal, social, and historical time. Any story created will involve and represent influences from outside—and is therefore colored and influenced by the social context. This situated text is valuable for all concerned in the way that it provides a learning resource for the individual, the group and those beyond.

#### **1.4. Autobiography and Groups**

Autobiographies are important and relevant to research on groups and organizations. There are several reasons for this.

*They are an expression of a group experience.* The author is situated in a group and the discourse of the group. What is written often contains parts of that discourse and is situated within the culture of the group. The narrative becomes what Goodson (1988: 201) refers to as a grounded phenomenon of the totality.

*They contribute toward a group identity.* Through an awareness of these artifacts the group comes to know its members and a profile of the group emerges. The group is also changed over time by the self-development of the authors along with the addition of new authors and new voices.

*They constitute a resource for the group.* The collection of autobiographies produces a resource not only for members of the current generation of a given group but also for future generations. The same might be true among groups of an existing generation, for example, across groups in a course.

*They construct a memory for the group.* The collection of narratives when shared constitutes not only a shared memory of time spent together but they

also contribute to the defining of that group at that time. In this respect, the narratives and the significance assigned to them construct a group identity. Giddens (1987) refers to this as the narrative as a cultural resource. Such a resource for researchers represents “a sophisticated stock of interpretive procedures for relating the personal and the social” (Wengraf et al., 2002).

*The group acts as an audience for the autobiography.* The text is shaped according to a sense of the audience in the author’s mind. In this way the group is a significant influence on the author and the narrative. As Merrill (2002) points out, “biography is, therefore, never fully individual.” They are a sampling of phenomena at a moment in time that is made public either to the self or to a wider audience.

In addition, the relationship between the personal and social in autobiographical approaches offers a unique window on the dialectical relationship between the two positions. As suggested by Dhunpath (2000), this is a unique opportunity afforded to the researcher as well as to those involved in the study.

### **1.5. Autobiography and Personal Empowerment**

There are different ways in which autobiography can be viewed as empowering and therefore justifying support for further learner development. The list below is not exhaustive and there are more developed lists like this in the literature (see for example Rainwater in Giddens, 1997: 74)

#### *1.5.1. Narratives as Explanation*

Autobiographies construct a narrative that does more than simply communicating the past. The author makes a selection from the available pool of personal experience and creates a new story with that sampling process. As part of the process the author is selecting events that have personal significance and gives the selected content new meaning. It is an act involving externalization of those events, communication of them into a narrative form and an explanation. Self-explanation or explanation to others is recognized as a valuable learning experience and method (Chi et al., 1994). Amongst the reasons for this is the requirement to tailor the explanation and the author’s current knowledge to the perceived audience. This involves several shifts in perspective and therefore increases the cognitive effort and processing (Dillenbourg & Schneider, 1998). This is an act that gives form to thoughts and experience and shapes them into a communicable form. It therefore involves considerable cognitive effort to conceptualize the thoughts into a sensible form that gives rise to new understandings.

#### *1.5.2. Narratives and Constructivism*

In learning, constructivism involves recall of the current understanding that is changed through an encounter with new knowledge that appears not to fit into the person's current schema. This gives rise to cognitive dissonance and through a learning activity the new is assimilated into the old view to extend the original understanding or develop new concepts. The authoring of autobiographical narratives is a similar project. The past is re-visited, de-constructed, and re-assembled to create a new construction with new meaning.

#### *1.5.3. Narrative and Continuous/Lifelong Learning*

Through the construction of several narratives authors become aware of themes and interests that emerge from the texts. These interests and themes are available as projects that begin to inform the identity of the author. The self, understood as a reflexive project (Giddens, 1997), is a process over time that uncovers, shapes, and develops identity in a dynamic process. This process is within the author's control despite the numerous influences and demands made upon an individual.

#### *1.5.4. Narrative and the Development of a Voice*

Autobiographical writing and research is a means of developing personal views and interests. Through the writing of journals and autobiographical pieces authors develop a voice. Even where the narrative is communicated only to the self, it is a process of establishing one's own interests and emphases. Authors begin to generate a voice for personal change and this will impact upon the groups in which the individual interacts. Especially for those from non-Western countries or less privileged communities, this is an empowering process.

#### *1.5.5. Narratives as Political Acts*

The writer can frame a different view attaching his or her own meaning to the phenomenon. This is important if people are to feel that they have a valued role in society and that they have a voice that is heard. The alternative is that people risk becoming dejected or alienated. The system must "connect teachers to the system and society in an activist way, where they can see themselves not just as effects of the context, but as part of the context, contributors to it, and

as agents who can and must influence how others perceive, shape, and support their work.” (Bascia & Hargreaves, 2000 in Tait, 2002)

By writing in this way, authors take control in a political act that thereby resists dominant discourses and views. Writing privileges personal time over actual time (Rainwater in Giddens, 1997: 77). By taking control in this way, authors create a space for their own voice to be heard.

## 2. THE WAOE AS A CASE STUDY

In this part of the chapter, we present our own educational involvements as a case study to illustrate one implementation of the theoretical perspectives articulated above. We begin with a view of the organization as a learning community and an Open Source Learning (OSL) environment. We then describe the range of our professional development provision before going from there to present one co-constructed event in some detail. Section 3 will offer a summary and a refinement of theory based on our practice.

### 2.1. Open Source Learning: The WAOE as a Virtual Learning Environment

WAOE is itself a VLE. Constructed as a network, existing within networked relations, the WAOE is a virtual organization for learning about online education in general. The network, and the networked relations that comprise WAOE’s membership, constitute an environment, an information ecology that organically serves the needs of its constituents. Just as distributed computing marshals a vast array of resources to create greater computational power than the sum of its parts, so too does a community of practice like WAOE create educational value by bringing together people from various cultures and institutions. Whereas distributed learning is generally defined as the use of a range of media and technologies to distribute teaching and learning over time and space, WAOE exemplifies learning as distributed within the network itself. WAOE is an environment, an information, or a knowledge ecology wherein the constituents are an amorphous yet coherent whole that is greater than the sum of its parts.

The WAOE is a distributed virtual organization that uses VLEs as a means of communication and interaction. These include WWW courseware technologies (WebBoard, Blackboard), and also basic web pages and e-mail as a means of further communication. WAOE is an open environment, an “OSL” environment distributed globally and connected *via* network relations and a shared concern for online education: “Open Source Learning (OSL), the theory of knowledge sharing and production in both formal and informal settings, typifies how the free availability of information and the sharing of knowledge can benefit communities” (Luke, 2002). OSL is congruent with how Lave and

Wenger construe “learning in terms of participation [that] focuses attention on ways in which it is an evolving, continuously renewed set of relations” (Lave & Wenger, 1991: 50). This participation is marked by a supplementarity that is always situated within a given context, be this personal, community, civic, or otherwise. This “pedagogy of the supplement” (Trifonas, 2000) is contextual, continual, and situated within communities of practice. The iterative, autobiographical approach expounded above is one way for the individual members of WAOE to relate their own personal experience to the broader concerns of the online educational community.

As an OSL environment, WAOE resembles the open source communities that have in common the free sharing of knowledge and information for the public good. Open Source programming is defined by its iterative process. It produces products (programs, software) that are open documents, works-in-progress, that are continually updated and augmented. This additive and iterative process exemplifies the manner in which WAOE’s members work and learn together within the virtual space of the Internet and WWW. The open source movement, supported by the philosophy of open access to information and the sharing of information and knowledge, forms communities of practice that share and work together for the public good (Castells, 2002). Open Source is an apt metaphor for the iterative *process* of collective intelligence and shared knowledge production that is congruent with current conceptions of lifelong learning. OSL is one way to describe how open environments of knowledge sharing for the public good create opportunities for people to learn about ICTs and learn how to use ICTs. For WAOE this includes learning how to use ICTs in education, and includes learning about other cultures while acknowledging social difference as an important feature of global culture.

In a business context, Goleman (1998: 183) discusses leveraging diversity, but there is still a top-down sense of center to periphery for the benefit of the former. One of WAOE’s defining characteristics is its not being centered in any geographical region. WAOE operates as a distributed learning environment in and of itself; in Derridean terms WAOE is “not a fixed locus but a function” (Derrida, 1978: 280) of global knowledge on education. Nor is WAOE even pre-occupied with non-Western concerns like a development NGO or, for that matter, any unidirectional agendas. Rather WAOE’s orientation or basic stance is intercultural, in the knowledge that intercultural communication among the widest diversity of participants is of the greatest educational benefit for mutual learning, whether east-west or north-south, but going both ways in mutual respect. The immediate subject matter of online education cannot command balanced global participation, nor can WAOE wait for that, but fortunately pioneers have gathered from every continent who are living examples of intercultural online education.

Interpreting information means bringing it into context and producing meaning and relevance. Knowledge constructed within the new digital environment can be part of an ongoing interactive and iterative process within the



social contexts particular to time and place. Contextual understanding of new technologies and their role in mediating knowledge is particularly important for understanding media effects and the informal structures of learning that characterize everyday life. This context is very much predicated on the various disciplines and cultures that comprise the globally networked culture(s) online. And it is within this context that WAOE fills an important need by offering a space for the sharing of knowledge and information across disciplines and cultures, collaboratively contributing to the creation of diverse—and geographically dispersed—networks of educators. As a VLE in itself, WAOE exemplifies how learning within a community of practice, though globally distributed, can be localized and relevant to individual needs and practices congruent with the larger learning community. The global sharing of information and knowledge with WAOE (as in other organizations) is sensitive to its context within the framework of each individual member. WAOE as VLE is thus situated within each iteration of its constituent members. It is this global context that gives WAOE its strength.

WAOE is a VLE—and not just an organization—that fosters collegiality and shared respect for diversity in the digital world. A fundamental premise operating here is the recognition that active participation in the networked world is *socio-technical* in nature (Agre, 1994; Lave & Wenger, 1991; Wise, 1997). Recognition of the socio-technical nature of ICT development and use, and the ways in which the social construction of knowledge is part of an ongoing process of living within technologically mediated interactions can aid in the formation of digital pedagogies and literacies that are relevant to communities, both locally and globally. The social contexts of learning (about/with ICTs and cultures) are important aspects of socialization within communities of practice, particularly as regards open learning environments. For knowledge constructed within open environments and communities of practice is part of an ongoing interactive and iterative process within the social contexts particular to time and place (Luke, 2002). Communities of practice, whether online or off, are constructed, mediated, and conducted within a complex system of community exchange that is a combination of social and technological forces (Lave & Wenger, 1991). More to the point, communities of practice legitimize knowledge, providing context to information and the basis for community relevance. WAOE as a VLE constructs legitimacy for participating individuals, offering an organizational context for the personal experience with online learning to be connected to broader concerns around the world.

## **2.2. Diversity of Informal Learning Support with the WAOE**

In this section, we present a view of the range of different ways the WAOE has utilized the online environment to support informal learning in a professional

development context. We present a historical view of the organization to show this diversity in a clearer context. This case study will highlight our conception of WAOE as an OSL VLE—how WAOE operates as a locus for learning utilizing various VLE tools.

In 1999, Nick Bowskill proposed the idea of a notional WAOE Online Educators Course as a shared experiment to explore the issues and concerns to be contained within such a course. It was also a problem-solving professional development exercise for sharing ideas and to try and make a pilot implementation to apply some of the learning in a meaningful context. This was done with the BlackBoard learning management system (LMS) free version, and a number of officers were eager to evaluate its functionality and possibilities. The guiding concept of a library of experience meshed well with the sense of responsibility among officers to know the terrain of a new discipline and to provide signposts for others who follow. An organizational library of experience could be found in web-based records of the collaboration of individuals through WAOE. This library would function as an OSL document, continually updated as a living archive. Officers have shared access to different LMSs among each other and then freely to members during the Annual Members' Meetings mandated of an NPO but held online.

Officers have learned from each other in a continuous process of professional development. The WAOE Coordinating Ring had its own listserv for organizational communications first based at California State University, then with WAOE's ISP. But there was a constant effort to reach out to other VLEs to explore how WAOE's mission could be better fulfilled. In this process it was discovered, for example, that an issue was the cobbling of free or nearly free VLEs, which was a very economical form of empowerment but with a lingering sense of frustration. The fragmentary inability of various tools to add up to a coherent experience led to unrealistic expectations that some LMS would provide a satisfying answer. That is, human nature in cyberspace yearned for a seamless and consistent VLE that would fulfill all the knowledge-building, interactive and communicative needs one would envision or expect. But the reality was that prices soared as the imperfections of such systems were reduced but not eliminated. Discussions in the free Blackboard environment and later with an inexpensive version of the MetaCollege LMS leased by WAOE have been pre-occupied with what the systems cannot do in terms of functionality and so forth. But these realizations about human nature were necessarily the fruits of collective experience, which each individual can then pass on. The nature of this collective intelligence reinforces the contextual and situated nature of learning online within a community of practice. WAOE thus functions to legitimize knowledge production within this context, particularly as it relates to the personal professional development of each participant.

If there were now wholly virtual organizations, there should be virtual organization software for all of an online organization's needs in a networked infrastructure. But there, too, it was found that only fragments of such

functions were available. WAOE officers therefore investigated what groupware or teamware was available for free. There was already a WAOE WebBoard at Embry-Riddle Aeronautical University available for formal events in addition to the Ring discussion list, but WAOE explored the possibilities of virtual organization environments by selecting QuickTeam as the venue for the February–March 2000 Board of Directors’ Meeting. Limitations in functionality again resulted in a gain mostly of experience, while QuickTeam was eventually absorbed into another company, as its business model of advertisements in the free VLE proved unsustainable.

In a somewhat similar instance, WAOE officers investigated what LMS could be used so that WAOE could operate on the model of a virtual university. Vendors such as WebCT were found to be too expensive for WAOE in their minimum services, so officers selected the free version of MetaCollege for an Online Educator Development Practicum that was opened to members at the Annual Members’ Meeting in mid-2000 (AMM2000). Later MetaCollege also apparently found advertising revenue insufficient, and WAOE decided to start paying for the minimum service. A danger of VLE freeware was discovered, in that the companies are vulnerable to going out of business or starting to charge for formerly free services, so educators may lose the work invested in good faith in a certain VLE. This marks a clear need for open source courseware systems that can be sustained by non-profits such as WAOE.

For the following Annual Members’ Meeting in mid-2001 (AMM2001), members were challenged to utilize various online venues, voting through web forms, discussing by mailing list and by logging into WAOE’s WebBoard, plus members were e-mailed access codes to enter the MetaCollege Advanced Site. While most individuals would not lease their own LMS, the organization could leverage a tiny budget to provide such experiences to members.

Synchronous events of AMM2001 were held in the combination chat room and whiteboard of WAOE’s online seminar course in MetaCollege, hosted by four Asian colleagues and Steve McCarty in Japan. Again the discussion quickly turned to the lack of functionality, such as being disconnected from chat after using the whiteboard for illustrations. With current technology, officers have found that it is still better to separate those communication tools.

Also at AMM2001, Prof. Mike Holmwood offered open house to visit the WebCT VLE at his college in Vancouver, for WAOE members who had only heard of WebCT and wished to experience it. Such individual contributions can increase the services to members, expanding collective expertise and a growing library of experience. And a continuously learning organization is an increasingly empowered educational organization. The iterative process of a learning organization such as WAOE reveals the fact that, to a large extent, any particular VLE is almost incidental to the working of an online community of practice. For it is the aggregate knowledge produced as part of the OSL process that marks WAOE as a learning environment in and of itself.

WAOE was cited as a model for collaboration at a conference in China by K. Narayanan of the Commonwealth Educational Media Center for Asia in New Delhi: "Various patterns of collaboration can be envisaged. They range from individuals voluntarily sharing resources to institutionalized collaboration in course and credit sharing" (Narayanan, 2001). He quotes extensively from Bowskill et al. (2000), including two of WAOE's 22 stated Objectives and Purposes (see URL: <http://www.waoe.org/npo/bylaw.htm#a2>). "The reference to WAOE has been made to highlight voluntary collaboration for offering professional development courses online, with a concern for multilingualism and multiculturalism in online education. The success of the WAOE as a voluntary organisation would suggest that similar organisations with like objectives be multiplied for deeper collaboration amongst educationists for offering online courses of study, training or professional development" (Narayanan, 2001).

As part of WAOE's dual mission to serve international society as well as members' professional needs, a global digital divide policy was passed at the 2001 Annual Members' Meeting. The idea was to leverage the services offered for the same fee by WAOE's ISP to offer many more free services to members and even to non-members in developing countries. WAOE officers just needed to master the web-based functions offered, and to volunteer the time. WAOE paid for four mailing lists, so four different types were set up. e-mail accounts, aliases thereof and web directories were virtually unlimited, so officers were encouraged to make the most of them or to help others.

Those who were using free e-mail accounts or web services with limits and intrusive advertisements were thus invited to have addresses at waoe.org. e-mail aliases further serve to form sub-groups of the Coordinating Ring: For example, e-mails sent to [membership@waoe.org](mailto:membership@waoe.org) are forwarded to everyone in that Committee for better service. Aliases are also better than individuals' e-mails for mailto: Links on WAOE's web pages.

In 2002, the WAOE Websites and e-mail accounts of officers have become quite numerous and have been extended to general members. The Indian Association for Online Education (IAOE) inspired by WAOE is led by WAOE member Dr. Sanjaya Mishra who has changed to WAOE's web-based e-mail and is one of those who receives e-mail to the alias [journal@waoe.org](mailto:journal@waoe.org). In a similar vein, at the Annual Members' Meeting in mid-2002 (AMM2002) officers resolved to step up WAOE publications to institute more visibility for WAOE as a VLE. An e-mail newsletter WAOE Electronic Bulletin (WEB) will be hard pressed to keep up with new developments, while an e-journal is under discussion, with volunteers already for languages in addition to English, and a suggested title of Intercultural Cyberspace Journal.

Another virtual environment WAOE would like to expand into is a relational database whereby members could manage their own membership status through a web interface and network with other members having similar research interests through the database of members' information.

On the agenda of AMM2002, business included elections, with candidates from Singapore, the U.S., an Indian in Germany and a Mexican in Hawaii, which showed that non-Westerners are identifying with WAOE and making the organization their own. Aside from business, WAOE annual meetings also feature discussions on the Views mailing list and other venues. At AMM2002, the discussion of online education turned deeply philosophical with balanced participation from all over the world. Prof. Asif Daya specifically led a discussion on accessibility and e-health technology. As a result, it was decided at the following Board of Directors' Meeting in July–August to hand over the designer role of WAOE's MetaCollege LMS license to Prof. Daya for courses in of Kenya.

Another topic of discussion was the Future of Universities, with Dr. Parker Rossman, formerly a dean at Yale, to discuss his online book. WAOE collaborated with the TappedIn Summer Carnival 2002, holding a synchronous discussion in their MOO. The transcript is available at: <http://waoe.org/president/future.html>. This in turn led to Dr. Rossman deciding to accept the offer of the WAOE WebBoard for continuing asynchronous discussions of his online book and specifically how to attain education for all in developing countries through the internet. As with TappedIn, which is predominantly at the K-12 level, this discussion starting in August 2002 is also not particularly for WAOE members but has WAOE's cooperation. WAOE provides the venue for the invited participants with international development experience, and offers orientation for those new to the technology.

When Dr. John Afele, on the Executive Board of the Global Knowledge Partnership and a prolific author of original scholarship, lost his International Program for Africa at a Canadian university, it was WAOE's privilege to revive its web presence in August 2002, available at: <http://www.waoe.org/africanknowledge/index.html>.

These are some of the milestones of WAOE's brief history as a virtual organization delivering palpable results, seen through WAOE's use of VLEs. In sum, this history reveals WAOE itself as an expansive VLE serving those concerned with online education. The open knowledge structure of WAOE exemplifies how OSL environments are those that foster collegiality, cooperation, and learning within shared interests of communities of practice.

### **2.3. An Informal Learning Event in More Detail**

In this section, we provide details of a collaborative learning event in which a group of volunteers within the WAOE used the construction and testing of a notional online course as a developmental apparatus. This apparatus scaffolded our discussions and explorations around key issues in any implementation rather like a problem-solving exercise. The details of the course we

co-constructed are discussed in more detail elsewhere (Bowskill et al., 2000). Here, we offer an overview of the course and discuss the issue of assessment as important in a voluntary informal context, and from the point of view of empowerment for non-Westerners and Westerners alike. It should be noted that our model of empowerment is one that considers non-Westerners both in isolation and together with Westerners.

#### **2.4. The Course Design Details**

The ability to work collaboratively is a key skill for networked teaching and learning (see for example, Sherry, 1996; Tompkins, 1997). In recognition of this need, the course design offers a collaborative, experiential approach to understanding and working in a dispersed teaching team. It is also an online apprenticeship, as learners experience the course to understand the content and structure before perhaps having an opportunity to apply their learning from the course in tutoring roles as they support another generation of learners.

As learners, the participants proceed through the course and discuss concerns about online team teaching as well as completing related activities in each unit. Having completed the course, participants are invited to become part of the teaching team (subject to their having satisfied the assessment conditions) in order to teach what they have experienced to the next generation.

#### **2.5. The Course Structure**

The course contains a set of five online units that model different online teaching and learning strategies along with a discussion space. During the 16-week course, real-time chat sessions are also held whenever required.

Unit 1: Acclimatization and Introductions.

Unit 2: Collaborative Tutoring.

Unit 3: Reflecting Upon Real-Time Sessions.

Unit 4: Online Guest Expert/Case Study.

Unit 5: From Learning to Teaching.

#### **2.6. Assessment**

Participants are required to complete a written report discussing their experiences during the course and setting this experience in the context of their own working lives. This contribution is then made publicly available for all future generations of course participants in the Library of Experience. Participants must complete the activities and the reflective report before being eligible for consideration to join the tutoring team next time round.

### **2.7. The Design and Development Process**

The course design has gone through a number of cycles of development and changes of online environment/location. An invitation was extended to members of the WAOE's Ring discussion list (board and committee members' list) along with a request for volunteers to role-play a sample unit.

A core group of five members from California, Arizona, Canada, New Zealand, and Japan role-played a chosen unit over a 4-week period. All participants successfully completed the unit activities and a resource base was collaboratively developed as an outcome. Two real-time sessions were held: One between participants in Canada, England, and Japan; and another between participants in California and England.

### **2.8. Pilot Implementation/Environment**

The course was constructed on Blackboard ([www.blackboard.com](http://www.blackboard.com)), which is an integrated courseware environment for hosting online courses. Blackboard was chosen for the WAOE Online Educators Course because "Blackboard.com is a FREE service that enables instructors to add an online component to their classes, or even host an entire course on the web. Without knowing any HTML, you can quickly create your own CourseSite—a Website that brings your learning materials, class discussions, and even tests online" (<http://company.blackboard.com/Bb/index.html>). Since the WAOE is a virtual organization with limited resources, Blackboard was the most attractive alternative that would enable us to get the Online Educators Course up and running while at the same time eliminating the need to administer our own environment.

An overview of the implementation for the Online Educators Course that covers some basic features of the courseware is shown in Figure 1.

### **2.9. Discussion of the Course Design as an Exercise**

There are a number of issues arising from this collaborative exercise and the design process. Not least of these is that the course design and construction provided an informal learning opportunity for a group of members within the community. It arose from a series of casual online discussions about the need and interest in such a course and that led on to discussions about what such a course might look like.

Those involved in the design and construction process worked together because we had found a common interest and each person brought different skills, experiences and ideas to the activity. The activity was a slight formalization of the casual learning conversation that we had as a group, as indeed

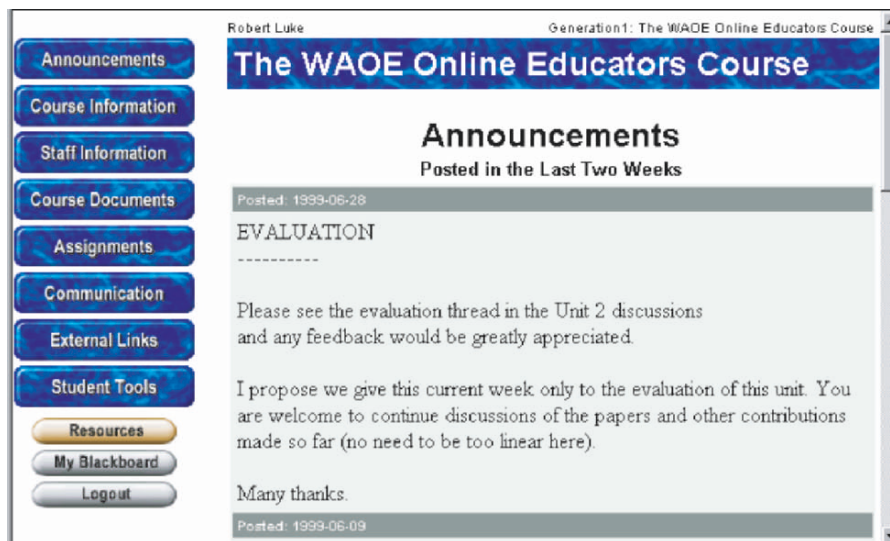

Figure 1. The WAOE online educators course home page.

was the idea to publish our activities and findings in a journal. Writing has become an important part of our activities together and this is reflected at other levels most notably within the course.

We were concerned to keep in mind that people were volunteers and that although we might offer advice and ideas to each other, we should in no way be judgmental. The idea of inviting participants in this notional course to construct an autobiographical piece aims to help them reflect and re-conceptualize their experiences. In providing such a document this activity simultaneously also offers the voluntary learning community a resource. This resource facilitates evaluation of the course design and the course experience and also provides a deeper insight into the membership of the community written by the members themselves. In the following section, we also think about the role of writing in a community as well as in informal learning and empowerment.

### 3. DISCUSSION

“Self-identity . . . is not something that is just given, as a result of the continuities of the individual’s action-system, but something that has to be routinely created and sustained in the reflexive activities of the individual”.

(Giddens, 1991 in McConnell, 2000: 250)

We have highlighted the role of informal learning as a possible aid to personal empowerment. We have also considered informal learning in isolation and



alongside formal provision within an institutional context and beyond. We have described a means of supporting the development of informal learning and extended a traditional view of that support to encompass online learning communities in order to accommodate global involvement.

There is an important issue in the power relationship between participants in any learning event. Others involved perceive the tutor in a formal course differently. There is much talk in the literature about the role of online learning communities as an alternative model for development. However, many of these are conceptualized and delivered within a course or institutional context. Pedlar (1981) for example, talks about the problematic nature of the tutor in such a model of community. Although the tutor may move from a central position to one of facilitating, that role does nonetheless come pre-loaded with assumptions and expectations. There is a difference in power relationships in such cases that may militate against equal participation and discussion. Where events are constructed within a voluntary virtual community, relationships are more equitable. Everyone is participating in a spirit of willingness and shared interest, and there is certainly little coercion that can be applied in a voluntary context. As such, a model such as we have described above offers greater empowerment both of the group and of the individuals. Pedlar (1981) also talks about the goal of promoting autonomy through a supportive structure that allows for different learning goals and outcomes. We have shown through the earlier description of the diversity of events and resources how this is facilitated across the WAOE as well as in the particular example described in detail. The WAOE, as a voluntary virtual organization, functions as a supportive environment for informal learning and autonomy in a variety of ways, empowering all concerned by accommodating different learning projects (Tough, 1971).

A key part in our work together is writing. This is a means of personalizing understandings and sharing them with others both within and outside a community event. We believe that writing and sharing documents supports the transfer of experience and learning into the self. Reflective writing is a sense-making process in the language of the individual authors and a process under their own control. The act of externalizing tacit knowledge reflectively is constructivist and contributes toward the formation of identity in a way less vulnerable to external change (accepting that such change remains a factor). The author has the control of the document, what is included and what is left out. The same is true collaboratively in the way that a shared collection of autobiographies and of articles acts as a learning method and a learning resource.

It is therefore culturally more sensitive and thereby empowering. Examples were given within one event of this principle being applied. We find that this is a process that supports people transferring an external event into the self through reflective writing. The sharing of these documents provides a learning resource for all involved and informs the identity of participants and organization alike. This is central to the organizational aim of facilitating learner development at

an individual and collective level in a culturally respectful manner and very much a part of the empowering process. Marsick and Watkins (1990: 221) discuss the importance in informal learning of raising automatic actions to the surface for examination, and they rightly see this as part of learning how to learn. They also note that such approaches are “indeed empowering and potentially transformative”. We believe that working in online communities in informal learning activities is not enough. It does need to be reflected upon, and the use of autobiographies in the way we describe above accommodates the transfer of learning into the self.

This principle of transfer into the self manifests in different ways and through different documents. It includes writing articles and other texts together, online text-based discussions, and support for others to contribute autobiographies as part of a shared learning process. All of these documents empower both the individuals involved and the community at large to become a learning organization. Those documents that are published also share knowledge and experiences with a wider audience, and the sum of our writing goes some way to the development of our identity as educators. The collection helps the organization to better understand the people that make up the membership and to recognize the knowledge located within.

#### SUMMARY

In this chapter, we have presented a life history of a virtual voluntary organization, and as a VLE in its own right. We have shown activities at an organizational level and taken them to the individual level. Life history methods use different research methods and may contain autobiographical accounts as a grounded phenomenon of the totality (Giddens, 1997). This chapter crystallizes our understanding of the organization at a moment in time taking an ethnographic approach to the production of a “thick” case study. This approach seeks to develop and share an understanding of a culture from the inside and in some detail. It is therefore important to reflect and think about what might be generalizable from our experience and our attempts to facilitate empowerment.

Our model then has six key parts that support autonomy within a global learning community context. These elements (in no order of priority) constitute our emergent architecture for empowerment in networked professional development:

*Informal learning has unique advantages and features in relation to formal methods.* These features should be considered in comparison with and in connection with formal methods. These features offer a viable framework for those unable to access formal provision in a supported self-help model.

*The need to facilitate transfer into the self, not just transfer into practice.* This is to overcome the often temporary nature of employment, economics,

and political uncertainty. It is also to move toward an intrinsically motivated model of professional development through professional activities and writing.

*The need for online communities to be a vehicle for supporting diversity of culture and interest that accommodates a dynamic global learning community.* This can be done through self-reflection and self-assessment of participation.

*The need for online communities to allow for different opportunities and access for all.* This means working toward accommodating autonomy at different stages of development wherein people can move from being a vicarious learner (McKendree et al., 1998) to an active co-constructor of events and experiences within the virtual organization.

*The idea that informal professional development should not and could not be limited to local provision or formal provision in a networked world.* This is particularly true of those interested to understand the nature of online education and its impact on both local and global contexts. It is also particularly important in the context of the non-Western world where access and needs may vary enormously.

*The idea of supporting individual diversity that also supports and feeds into research at the distributed center.* This means that writing is shared so that it can function as a resource for both further learner development and research at different levels within the virtual organization.

We have demonstrated how the WAOE has empowered members in a number of ways through its unique, OSL approach. This is centered upon an informal learning framework that allows for shaping and direction in an equitable, mutually respectful, and supportive framework. At its heart is support for the transfer of learning and experience into the self through shared reflective writing. Shared reflective writing supports further research in a voluntary virtual organizational context. As such, this text is our latest contribution to our library of experience and learning.

## REFERENCES

- Apple, M. W. (1990). *Ideology and Curriculum*, 2nd ed. New York and London: Routledge.
- Boud, D. (1981). Moving towards autonomy. In: Boud, D. (Ed.) *Developing Student Autonomy in Learning*, 2nd ed. London: Kogan Page; New York: Nichols Publishing Co., 17–39.
- Bowskill, N., McCarty, S., Luke, R., Kinshuk, & Hand, K. (2000). Cultural sensitivity in voluntary virtual professional development communities. *Indian Journal of Open Learning* 9(3) (September), 361–379.
- Castells, M. (1996). *The Information Age: Economy, Society and Culture. Vol. 1: The Rise of the Network Society*. London: Blackwell.
- Castells, M. (1997). *The Information Age: Economy, Society and Culture. Vol. 2: The Power of Identity*. London: Blackwell.
- Cherryholmes, C. H. (1988). *Power and Criticism: Poststructural Investigations in Education*. New York and London: Teachers College Press.

- Chi, M. T. H., deLeeuw, N., Chiu, M.-H., & LaVancher, C. (1994). Eliciting self-explanations improves understanding. *Cognitive Science* 18, 439–477.
- Coffield, F. (2000). Introduction: the structure below the surface: reassessing the significance of informal learning. In: Coffield, F. (Ed.) *The Necessity of Informal Learning*. University of Bristol, Policy Press, 1–11.
- Cunningham, I. (1994). Self-managed learning. In: Prior, J. (Ed.) *Handbook of Training and Development*, 2nd ed., Chapter 25. Aldershot: Gower, 317–330.
- Derrida, J. (1978). Structure, sign and play in the discourse of the human sciences. In: Bass, A. (Trans.) *Writing and Difference*. Chicago: The University of Chicago Press, 278–294.
- Dhunpath, R. (2000). Life history methodology: narradigm regained. *Qualitative Studies in Education* 3(5), 543–551.
- Eraut, M. (2000). Non-formal learning, implicit learning and tacit knowledge in professional work. In: Coffield, F. (Ed.) *The Necessity of Informal Learning*. University of Bristol, Policy Press, 12–31.
- Giddens, A. (1997). *Modernity and Self-Identity: Self and Society in the Late Modern Age*. California: Stanford University Press.
- Gitlin, A., Bringham, K., Burns, M., Cooley, V., Myers, B., Price, K., Russell, R., & Tiess, P. (1992). *Teachers' Voices for School Change: An Introduction to Educative Research*. London: Routledge.
- Giroux, H. A. (1983). *Theory and Resistance in Education: A Pedagogy for the Opposition*. Massachusetts: Bergin & Garvey.
- Giroux, H. A. (1988). *Teachers as Intellectuals: Toward a Critical Pedagogy of Learning*. Massachusetts: Bergin & Garvey.
- Giroux, H. A. (1992). *Border Crossings: Cultural Workers and the Politics of Education*. New York and London: Routledge.
- Giroux, H. A. (1993). *Living Dangerously: Multiculturalism and the Politics of Difference*. New York: Peter Lang.
- Giroux, H. A. (1996). Is there a place for cultural studies in colleges of education? In: Giroux, H., Lankshear, C., McLaren, P., and Peters, M. (Eds.) *Counternarratives: Cultural Studies and Critical Pedagogies in Postmodern Spaces*. New York and London: Routledge, 41–58.
- Giroux, H. A. (2000). Postmodern education and disposable youth. In: Trifonas, P. P. (Ed.) *Revolutionary Pedagogies: Cultural Politics, Instituting Education, and the Discourse of Theory*. New York and London: Routledge, 174–195.
- Goleman, D. (1998). *Working with Emotional Intelligence*. New York City: Bantam Books.
- Goodson, I. (1988). *The Making of Curriculum: Collected Essays, Studies in Curriculum History Series: 21*. Washington D.C. and London: The Falmer Press.
- Goodson, I. & Walker, R. (1991). *Biography, Identity & Schooling: Episodes in Educational Research*. London, New York, Philadelphia: The Falmer Press.
- Gurstein, M. (Ed.) (2000). *Community Informatics: Enabling Communities with Information and Communications Technologies*. Hershey, PA; London, UK: Idea Group Publishing.
- Hawisher, G. E. & Selfe, C. L. (Eds.) (2000). Conclusion: hybrid and transgressive literacy practices on the web. *Global Literacies and the World-Wide Web*. London and New York: Routledge, 277–290 (Literacies).
- Huber, B. R. & Schofield, J. W. (1998). I like computers, but many girls don't: gender and the sociocultural context of computing. In: Bromley, H. and Apple, M. W. (Eds.) *Education/Technology/Power: Educational Computing as a Social Practice*. Albany, New York: State University of New York Press, 103–131.
- Lane, B. & Dorfman, D. (1997). *Strengthening Community Networks: The Basis for Sustainable Community Renewal*. Retrieved 2 July 2001, from <http://www.nwrel.org/ruraled/strengthening.html>.
- Lave, J. & Wenger, E. (1991). *Situated Learning: Legitimate Peripheral Participation*.

- Long, M. (2001). Training and economic returns to workers. In: Smith, A. (Ed.) *Return on Investment in Training: Research Readings*. National Centre for Vocational Education Research Ltd, 17–34. Retrieved 18 October 2002, from <http://www.ncver.edu.au/research/proj/nr1002.pdf>.
- Luke, R. (2002). Open source learning & digital literacy: education *In Formation*. *SNOW-board e-Journal* 16(April). Retrieved 23 August 2002, from <http://snow.utoronto.ca/snow-board/osl.html>.
- McCarty, S. (1997). Opening the Conference Gates to K-12 and Worldwide Educators. *Global SchoolNet: The Well Connected Educator* (February 1997). Available online at URL: [http://www.techlearning.com/db\\_area/archives/WCE/archives/mccarty1.htm](http://www.techlearning.com/db_area/archives/WCE/archives/mccarty1.htm).
- McCarty, S. (1998). Voluntaristic Online Education and the Future with Japan. *Third Annual Teaching in the Community Colleges Online Conference Keynote Address*, April 1998. Available online at URL: <http://leahi.kcc.hawaii.edu/org/tcon98/keynote/mccarty.html>.
- McCarty, S. (1999). *Introducing the World Association for Online Education (WAOE)*. Egypt/United Arab Emirates: Papyrus News. Available online at URL: <http://vstevens.tripod.com/papyrus/13oct99a.htm>.
- McKendree, J., Stenning, K., Mayes, T., Lee, J., & Cox, R. (1998). Why observing a dialogue may benefit learning. *Journal of Computer Assisted Learning* 14(2), 110–119. JCAL98.RTF.
- McConnell, D. (2000). *Implementing Computer Supported Cooperative Learning*, 2nd ed. London: Kogan Page; Sterling, VA: Stylus Publishing.
- Marsick, V. J. & Watkins, K. E. (1990). *Informal and Incidental Learning in the Workplace*. London and New York: Routledge.
- Managers Forum: <http://www.managersforum.com/eLearning/Statistics.htm#masie>. Accessed 12th August 2004.
- Merrill, B. (2002). Biographies as Collective Experience? *Proceedings of ESREA the Biography and Life History Network Conference*, Geneva, 7–9 March.
- Miedema, S. & Wardekker, W. L. (1999). Emergent identity versus consistent identity: possibilities for a postmodern repoliticization of critical pedagogy. In: Popkewitz, T. S. and Fendler, L. (Eds.) *Critical Theories in Education: Changing Terrains of Knowledge and Politics*. London and New York: Routledge, 67–83.
- Morley, D. (2000). *Home Territories: Media, Mobility and Identity*. London and New York: Routledge.
- Narayanan, K. (2001). Strategies for web-based instruction in distance education. *International Conference on Learning and Teaching Online*. Guangzhou: South China Normal University, January 2001. The whole passage about WAOE is available at URL: <http://waoe.org/president/ijol.html>. The original Web page in China is preserved in the Internet Archives at URL: <http://web.archive.org/web/20010411053948/http://ltol.scnu.edu.cn/fullpaper/303-f.html>.
- Pedlar, M. (1981). Developing the learning community. In: Boydell, T. and Pedlar, M. (Eds.) *Management Self Development: Concepts and Practices*. Aldershot: Gower, 68–84.
- Rheingold, H. (1993). *The Virtual Community: Homesteading on the Electronic*. Reading, Massachusetts: Addison-Wesley Pub. Co.
- Rowland, S. (1993). *The Enquiring Tutor: Exploring the Process of Professional Learning*. London & Washington D.C.: The Falmer Press.
- Shimabukuro, J. (2000). What is an Online Conference? The Technology Source, January/February 2000. Available online at URL: <http://ts.mivu.org/default.asp?show=article&id=665>.
- Smith, M. (1999). Informal Learning. Retrieved 18 October 2002, from: <http://www.infed.org/biblio/inf-lrn.htm>.
- Sofia, Z. (1998). The mythic machine: gendered irrationalities and computer culture. In: Bromley, H. and Apple, M. W. (Eds.) *Education/Technology/Power: Educational*

- Computing as a Social Practice*. Albany, New York: State University of New York Press, 29–51.
- Starkey, B. A. (1998). Using computers to connect across cultural divides. In: Bromley, H. and Apple, M. W. (Eds.) *Education/Technology/Power: Educational Computing as a Social Practice*. Albany, New York: State University of New York Press, 175–185.
- The New London Group. (2000). A pedagogy of multiliteracies designing social futures. In: Cope, B. and Kalantzis, M. (Eds.) *Multiliteracies: Literacy Learning and the Design of Social Futures*. London and New York: Routledge, 9–38 (Literacies).
- Tough, A. (1971). *The Adult's Learning Projects: A Fresh Approach to Theory and Practice in Adult Learning*. Toronto: OISE.
- Trifonas, P. P. (2000). Derrida and Rousseau: deconstructing the ethics of a pedagogy of the supplement. *The Review of Education/Pedagogy/Cultural studies* 22(3), 243–265.
- Turkle, S. (1995). *Life on the Screen*. New York: Simon & Schuster.
- Turkle, S. (1999). Commodity and community in personal computing. In: Schön, D. A., Sanyal, B., and Mitchell, W. J. (Eds.) *High Technology and Low Income Communities: Prospects for the Positive Use of Advanced Information Technology*. Cambridge, Massachusetts & London, England: The MIT Press, 337–347.
- Weinstein, M. (1998). Computer advertising and the construction of gender. In: Bromley, H. and Apple, M. W. (Eds.) *Education/Technology/Power: Educational Computing as a Social Practice*. Albany, New York: State University of New York Press, 85–100.
- Wengraf, T., Chamberlayne, P., & Bornat, J. A. (2002). Biographical turn in the social sciences? *A British-European View, Cultural Studies-Critical Methodologies* 2(2), 245–269.
- Winter, R. (1998). Finding a voice-thinking with others: a conception of action-research. *Educational Action Research* 6,1 (Winter).

## Chapter 30: An Online Journal as a Virtual Learning Environment: The Case of the *Teachers College Record*

GARY NATRIELLO AND MICHAEL RENNICK

*Teachers College, Columbia University*

The *Teachers College Record* is an academic journal that has been published by Teachers College at Columbia University since 1900. For most of its first 95 years the journal appeared in print on at least a quarterly basis. During that time it has featured the work of most of the leading names in the field of education and educational research, including early papers by Thorndike (1901), Dewey (1914), Kilpatrick (1918) and more recently articles by Berliner (1997), Apple (1993), and Greene (1994), among many others.

Over the years the journal has taken seriously its mission as a vehicle for education. In its earliest volumes, the journal published original syllabi drawn from courses in such areas as the principles of education (Butler, 1900), the history of education (Monroe, 1900) and school administration (Dutton, 1900) offered as part of the curriculum of Teachers College. The journal has also co-ordinated its publishing program with various workshops and colloquia in conjunction with degree and non-degree programs at the College. It has published sets of papers and special issues derived from conferences and special educational events. Throughout its existence, the journal has sought to maximize its educational impact.

In this article, we report on recent efforts to extend the educational impact of the journal through online publishing activities. We begin by reviewing our early attempts at establishing an online presence for the journal. We then consider the impact of developments in academic publishing, the changing online experiences of readers, and our educational goals on the design of our current online journal site. We discuss the current publishing site in detail and examine data on user patterns over the past several years. Finally, we outline the major features of a next generation publishing site designed to enhance and expand the educational program of the journal.

### 1. EARLY EFFORTS AT PUBLISHING ONLINE

The 1990s marked the beginning of efforts to produce fully online academic journals. As the decade progressed, there was a remarkable growth in the number of journals publishing online. In the early 1990s, most online efforts made use of electronic networks to distribute papers to defined lists of readers.

Following the advent of accessible browsers and the explosive growth of internet use, this gave way to publishing papers on the web. The Association of Research Libraries began tracking online journals in 1991 with the publication of the *Directory of Electronic Journals, Newsletters, and Academic Discussion Lists*. The 1991 edition included 110 electronic journals and newsletters. The number of entries grew to 240 in 1993, 675 in 1995, and 3400 in 1997 (Mogge, 1999).

In the field of educational research, perhaps the best example of an early electronic journal is the *Educational Policy Analysis Archives (EPAA)*, an online journal started in 1993 as a listserv and later moved to gopher and then to the web. The *EPAA* had 800 subscribers within 3 weeks of its founding, and by 1994 it was being accessed by over 600 readers each weekday (Glass, 1994), a number that continued to grow throughout the 1990s (Glass, 1999). Although *EPAA* was publishing online early in the 1990s and attracting readers, established print journals in education were not yet moving online.

In the mid-1990s with the emergence of opportunities for online publishing made possible by the internet and the World Wide Web, we decided to take advantage of new online publishing and communications tools to pursue the original educational mission of the *Teachers College Record* in new ways. We viewed the online environment as offering new means to reach those scholars, researchers, and graduate students who had been the traditional audience for the journal. We also anticipated that publishing online might allow the journal to expand somewhat beyond its audience of scholars to reach educators and even the general public.

Although the history of the journal as a deliberately educational vehicle provided both some orientation and a rationale for our efforts to move online at a time when educational offerings were moving in the same direction (Lewis et al., 1999), along with that same history came a sense of tradition that made it difficult to depart from what had become a rather standard pattern for an academic journal. As we considered our initial move online we confronted resistance from our editorial board of established scholars in the field and from our readers, who as of 1995 did not have much experience with online journals. Indeed, if we had polled our board and our readers in 1995 about whether we should move the journal online, we would have received either blank stares or outright warnings of the dangers of devaluing the entire journal enterprise. Perhaps most importantly, we had concerns that our authors would be reluctant to submit manuscripts to an online journal, both because they considered online publication less legitimate and because they feared that promotion and tenure committees at their institutions would think likewise in evaluating their work (Kling & Covi, 1995; Sweeney, 2000).

We began publishing online in the most limited way. Our first online site for the journal consisted of the name and contact information for the journal along with some basic information on how to order a subscription by calling the journal office. At the time this seemed like quite an accomplishment, but,



of course, we quickly grew discontented with our single page and decided to try to do more.

Our second online site had multiple pages and included tables of contents from recent print issues together with abstracts of at least some of the articles. It also included detailed directions for authors interested in submitting materials to the journal. The design of the entire site reflected the design and organization of the paper journal. We did implement one feature at this point that reached out to authors by allowing them to consult a page listing all papers under review by an identification number along with the status of the number of external reviews completed. This allowed authors to interact with the journal through the online site and reduced the number of phone calls or e-mail messages coming into the editorial office.

For a time, we built on this basic site by adding new tables of contents and abstracts whenever a new issue of the print journal was released. Perhaps more significantly, we added a new feature that listed basic information on the major journals in education as a resource to authors who wished to find the right outlet for their work. This marked a departure for the journal because we became a conduit for authors to reach other journals and for the first time we offered something other than our exclusive content.

At this same time, we made a decision to begin putting the full text of the lead article from each print issue online at the time the print issue was released. This generated greater interest in our online site, and the immediate response of readers was to ask for more full text content online. We investigated offering both more current content online and the possibilities for bringing articles from past issues online as well. In retrospect, both moves seem like straightforward decisions to give readers what they want and need, but in 1996 things were not so clear. Members of our editorial board and others at the College questioned the wisdom of offering full text articles online without charging while we were trying to increase revenue from our print product.

In the spring of 1997, all of our efforts to add content to our online site resulted in another re-design that became our third online site in as many years. This version looked and felt more like the print journal than anything we had done online in the past. Readers were able to page through tables of contents of each issue and read the full-text of lead articles, editor's columns, and all book reviews. Although the model for organizing the online site was the print journal, about this same time, we began to re-design the print journal based on what we were learning from our experience with the online journal. The best example of this impact of publishing online was the re-design of the table of contents for our print journal to include short descriptions for each article in the issue. These same short descriptions were first added to our online content pages to give readers an easier way to learn about our content before clicking on the link to move to the abstract or the entire article.

In the summer of 1997, we embarked upon a major project of producing a cumulative index for the journal since its inception in 1900. We had always had

an appreciation of the history of the journal and its unique role in publishing the major voices in the field in the 20th century. However, prior to the advent of the web and the opportunities for online publishing, we had never had a real opportunity to capitalize on the extraordinary collection of materials published over the years. Once we began publishing online, we quickly realized both that the online environment can require vast quantities of content in order to generate sufficiently broad and valuable resources for readers and that we had such content in the historical archives of the journal. This all came together in the cumulative index project in 1997. Once the index was completed, we quickly configured it so that readers could search it online from our web site. Of course, putting the index online only served to highlight just how far we had to go to get even a fraction of the journal's past content online in full text. The growth of our online content also placed a new set of problems before us. Up to this time, we had been relying on the organization of the print journal to orient our online publishing efforts. By 1997, our online site looked as much like our print journal as we could make it. But, it was clear that our plans to publish more new content online as well as to make more content available from the archives would require a totally different approach to organizing our efforts on the online site.

In the summer and fall of 1998 and the winter and spring of 1999, we worked on creating an entirely new approach to publishing online. This time our site reflected not the organization of the print journal, but the orientation of the growing number of online sites in all areas. We designed the site to meet the needs of readers to move through large number of articles; and in so doing, we jettisoned the use of issues of the print journal as an organizing device. Instead, we created a home page that displayed content drawn from different sources, including, new online only articles, book reviews, articles from the current print issue, and related articles from prior print issues. We also added a set of new online only features including, calls for papers, an opportunity for readers to join our e-mail list to receive e-mail updates, an online advice column for graduate students, a feature that highlighted an educational research site of the week, a feature noting new journals added to our journals database, and announcements of recently accepted papers that would be forthcoming in the print journal. This new online site, our fourth major design, was deliberately livelier, more engaging, and more oriented to the online environment. Most importantly from an editorial office standpoint, we promised to publish online weekly, a dramatic change from our quarterly print schedule, and our infrequent updating of our earlier online sites. We launched this site after many months of work in the fall of 1999. It generated great interest among our readers and generally positive responses. Almost immediately, we began to see new ways to improve this latest version of our online site.

Our early efforts at online publishing were experimental in all senses. We clung tightly to our print journal for its format through most of the early web

site designs. We also clung tightly to the print journal both for the legitimacy it offered our authors and for the revenue stream it provided to support our editorial activities. Even through most of 2000, we never made a commitment to continuing our online publishing activities. By the time we did make such a commitment with the launch of our fifth online site in November 2000, we acted because we understood not only that online publishing met the needs of our readers (Vrasidas, 2000), but also because it had become clear that our online presence was largely responsible for raising the profile of our entire publishing effort and for increasing the number of high-quality manuscripts submitted for our print journal. The online site had become an integral and essential part of our publishing program. By the fall of 2000, we had ceased to become a journal with a web site; from then on, we were a publisher with both online and print products.

## 2. INFLUENCES ON THE DEVELOPMENT OF TCR ONLINE-2000

As it became clear that the *Teachers College Record* would become a permanent online publishing operation, we focused even more intently on ways to make our online efforts truly educational. Our goal was to create an online site where readers would have an opportunity to learn something at each visit. By this time, our planning for the next generation of the online publishing site was influenced not only by our growing appreciation of the educational opportunities available to an online journal, but also by changes in academic publishing and changes in the experiences our readers and the general population were having online.

### 2.1. Emerging Forms in Academic Publishing

Our commitment to permanent online publishing was made in the context of major forces affecting academic publishing in general at the turn of the century. These forces included the growing costs and growing number of academic journals, the declining individual subscription base for many journals in education, the growing resistance of institutional subscribers such as academic libraries in the face of stable or shrinking budgets, the development of online journals in a range of fields, and the realization that scholars were taking advantage of other means of communicating the results of their work to colleagues. Each of these shaped our understanding of the challenge of developing a successful online journal.

The growing cost of academic journals is a widely recognized problem confronting higher education (e.g., Association of Research Libraries, the Association of American Universities, the Pew Higher Education Roundtable, 1998; Born & Van Orsdel, 2001). This problem is felt acutely by libraries

forced to deal with a 207% increase in the price of journals between 1986 and 1999. The problem of the rising costs of existing core journals is exacerbated by the growth of new journals in virtually all areas of scholarship, as each specialized group seeks a means to communicate its work to those both in the specialized area and outside the area. Between 1986 and 1999, the number of journals increased by 55% (Smith, 2001). Library budgets are failing to keep pace with both the increase in journal costs and the growth in the number of available journals.

In the face of growing costs and the growing number of journals, some librarians and campus leaders have called for various new approaches to cost-control (Association of Research Libraries, the Association of American Universities, the Pew Higher Education Roundtable, 1998). Suggestions include pressuring commercial publishers to contain costs (Kiernan, 1999), weighing in on decisions regarding the issue of mergers among the already small group of academic publishers (McNabe, 1998), the creation of new alternative journals based in universities and libraries that have lower subscription rates (Kiernan, 1999), and the use of online publishing technologies to reduce at least the cost of producing a print product (Association of Research Libraries, the Association of American Universities, the Pew Higher Education Roundtable, 1998).

Although online publishing has been viewed as means to contain or reduce the costs of academic journals, a number of analysts have argued that publishing online or in print does not affect the cost of producing a journal. These analysts point out that a large part of the cost of any journal lies in the editorial work to prepare manuscripts for publication, and these costs are typically not affected in a substantial way by the shift to publishing online. However, these analysts have typically not devoted sufficient attention to the costs that institutions such as libraries must bear in making print journals available to patrons, costs not associated with online journals (Odlyzko, 1997). These include staff costs for processing print products into a catalog and checking to make sure that all physical print issues are delivered as well as costs for binding annual volumes and placing and replacing them (after use) on library shelves. In addition, online subscriptions do not require library shelf space, shelf space that is becoming more expensive and less readily available as library collections grow. Thus, publishing academic journals online offers a number of efficiencies for libraries that are hard to resist. Many libraries are now moving as quickly as possible to subscribe to online journals as a way to reduce processing and storage costs even if publishers are maintaining basic subscription fees.

The movement of academic journals online, driven by library needs, has resulted in a fairly direct translation of the standard journal format to the online environment. The vast majority of print journals moving online are offering their regular content in the regular format, often through pdf files that present the exact images of the articles that might appear in the print version

of a journal. These files are collected in large repositories by companies that publish large numbers of journals. The databases of journal content are offered to subscribers for fees that track the regular subscription fees, sometimes a bit more for combined print and online versions, sometimes a bit less for the online version only. The organization of these databases allows readers to access an entire collection of journals for articles on a subject, but at the individual journal level, the articles are organized through traditional volumes and issues with tables of contents that mimic the print versions. Despite the online availability of journals that published exclusively in print in the past, there has been a notable lack of innovation in the use of online tools as these journals simply seek to replace print issues with online issues to meet the needs of libraries.

While print journals have moved online in a rather traditional format, new online only journals have been a bit more innovative at times in exploiting the advantages of the online publishing environment (Vrasidas, 2000). These journals often invite authors to make use of new online technologies to make more extensive use of graphics and simulations. They also often depart from the rigid publishing schedule, formerly dictated by shipping needs, to release or publish articles individually when they are ready. Despite efforts to utilize online opportunities, most online only academic journals still mimic the form and functions of a traditional academic journal. Our own experience leads us to suspect that one reason they maintain journal conventions is because radically divergent approaches raise questions of legitimacy that create problems for academic authors seeking favorable tenure and promotion reviews.

## **2.2. Changing Online Experiences**

While we were influenced by developments in academic journal publishing as we designed the fifth generation of the TCR online site, we were also influenced by the changing online experiences that our readers were encountering as general users of the internet. By 2000 when readers of TCR went online, they encountered sites that promised broad and deep collections of materials, whether those materials were consumer goods, news stories, or more specialized properties for niche audiences. They also were increasingly likely to find opportunities to interact with other readers or with the purveyors of the online fare. This interaction included opportunities to voice opinions about products as in the readers' reviews of books on Amazon.com or the critiques of electronic products on CNET.com. In fact, entire sites such as Epinions.com were devoted to the opinions of users.

In addition to broad content, choice, and opportunities to voice opinions, our readers were also increasingly likely to encounter content personalized for them individually. Sometimes, the personalized views were created automatically as in the pages of related materials offered by Amazon.com. At other

times, the personalized views were deliberately selected by users as in the case of hometown weather reports offered by MSNBC.com. Online sites also began coupling content with a range of services as in the case of the greeting card site Hallmark.com that offered to maintain a list of important dates and remind users when they needed to send cards.

The evolving online sector was evidencing what Hage and Powers (1992: 60) had noted as the characteristics of post-industrial society, namely, a focus on “customization, quality, and innovation” in the services delivered to increasingly well educated and discerning consumers. This focus on the consumer of online products introduced a new challenge to our publishing program if we wanted to find a broader audience for educational scholarship. We had always catered to authors and sold primarily to other scholars, but the web made it possible to reach an entirely new kind of audience. That audience, however, was becoming accustomed to entirely new levels of service every time they went online.

### **2.3. Educational Perspectives to Guide Online Publishing**

Our interest in reaching beyond our traditional audience of scholars was driven only in part by the possibilities afforded us by online publishing. Perhaps more important was our historic goal of educating the broader public about the promise and possibilities of education. In considering our educational mission, we sought to embody a certain set of educational principles long associated both with the journal and with Teachers College, contributed by scholars from Dewey (1938) to Cremin (1976).

First, we viewed ourselves, along with our authors, as teachers with something to teach or convey to the broad audience of students of education. Thus, we sought to maintain a strong voice for authors and for the editorial team. Moreover, we sought to ensure that the teaching functions of the journal would drive its technical development and not the reverse. This meant that we would evaluate each new technical opportunity from a teaching framework. If a newly possible practice contributed to effective teaching and learning, we would consider adopting it. If a new technical possibility contributed little to the creation of a better teaching environment, we would shun the investment of scarce resources. So, for example, we would be more inclined to invest in better editorial development of content than in flashy display technologies that communicated less well than simple text presentations.

This emphasis on quality teaching and investing in authors was a particularly important issue at a time when the role of the author was being diminished in some online venues and when the role of the teacher was being decomposed and parceled out as numerous online educational operations sought to divide the labor of teaching and assign it to actors in diverse roles, including content developer, instructional designer, platform presenter, etc. (Burbules &

Callister, 2000; Noble, 1998). As part of our effort to reinforce the primacy of the teacher or the author of material on the journal site, we re-doubled our efforts to make the journal experience congenial to authors and their interests and to provide opportunities for authors to engage with readers. We remained on the watch for opportunities to highlight the role of authors.

Interacting with readers or learners was the second major aspect of our approach to education through the online journal. Editing a print journal for which the print production and shipping processes meant that months would elapse between the time, an article was edited and the time it arrived at the offices of readers left little or no immediate opportunity for serious interaction with readers. Despite an occasional letter to the editor or more formal response to an article, the level of interaction with readers was minimal. Moving the journal online opened up the possibility for more immediate and more regular contact between authors and readers and between the editorial team and everyone else involved with the journal.

Increasing opportunities for interaction was consistent with long-held perspectives on the importance of interaction and engagement to create the conditions necessary for effective teaching and learning, perspectives that had been reflected in early articles in the journal itself (Dewey, 1914). Moreover, the importance of interaction and engagement for learning has found increasing support in contemporary work on cognition (Bransford et al., 1999; Pea, 1994; Resnick & Klopfer, 1989). Accordingly, we sought to engage in lively interaction with the readers of the journal and hoped that the readers would become co-creators of the online publishing effort.

Third, in pursuit of the first two principles, we were prepared to share control of the online journal not only with our authors but also with our readers. Ideally, our readers would join with us to construct the online journal in a more immediate and interactive way than had ever been possible with the print journal. We hoped to create an online community (Hafner, 2001; Rheingold, 2000) of those interested in education and educational scholarship. We anticipated that such a community of practice (Wenger, 1998) focused on evolving scholarship in education would lead to powerful learning experiences for all concerned, including the journal staff.

### 3. THE DESIGN OF TCR ONLINE

To pursue our educational goals for our online publishing effort, we designed an entirely new online site. This site drew on recent developments in online academic journal publishing, on emerging conventions in online sites in general, and perhaps most importantly, on our educational goals. Because it was our educational agenda that had the most influence, we discuss the design of the publishing site in terms of central aspects of the educational enterprise. Bernstein (1975) identifies three such aspects—curriculum, pedagogy, and

assessment. We begin by considering curriculum and pedagogy in the design of the site and then move to a discussion of how the operations of the editorial office allowed us to assess reader responses.

### **3.1. An Expanded Curriculum**

As a long established academic journal we had a clear conception of the content or the curriculum of our educational enterprise. For nearly 100 years, we had published the very best scholarship in all areas of the field of education, and we would continue to do so as we moved online. But publishing online allowed us to do something that we could never do in print; it allowed us to make available simultaneously all of the content that had ever been published in the journal. Over the century that the journal had been published, over 10,000 articles had appeared in its pages, and any of this could now be available to the editorial team and to our readers.

Having the entire corpus of TCR materials online opened up several exciting new educational possibilities and posed a few problems as well. First, the accessibility of the material from earlier issues allowed any piece of content to be shown in a related content area of a page on which a new article appeared. This convention had arisen in general online sites, but it seemed particularly suited to our purpose of showing readers how new articles built upon or departed from earlier work. We anticipated that this would allow readers to learn not only from individual articles, but also from the relationships the editorial team discovered between new material and older papers. For the first time in the history of the journal, we were able to demonstrate the intellectual heritage of a paper or set of ideas by reminding readers of earlier work and then taking them directly to the full text of that work. This allowed us to emphasize the connected nature of knowledge.

Second, the availability of potentially every paper ever published in the journal allowed us to think very differently about grouping papers across issues and even volumes to create thematic special issues of papers published years or even decades apart. In creating special issues in the print journal, we often struggled to get just the right set of papers in a limited amount of time to produce an issue. By drawing on both our archival materials and the latest papers online, we were able to exercise much greater editorial discretion in assembling sets of papers. This allowed us to reveal different aspects of papers by embedding them in different knowledge contexts.

Along with the new possibilities came at least two new challenges associated with the large collection of published articles. First, since digital files were not available for most of the papers published in the print journal, such files would have to be created each time we decided to use an older article online. We approached this challenge by securing funds to digitize articles from the most recent 20 years since these articles were the most in demand.



For articles published even earlier, we developed an on-the-fly system for digitizing an article whenever we had an editorial need to use it. This allowed the editorial team to use the entire online catalog to find related materials and then request digital copies to be placed on line.

A second challenge of working with the large number of articles from the history of the journal was to develop a way to make this content archive accessible to readers. By linking from current articles to older materials, we could direct readers to selected pieces from the past and by assembling online special issues we could attempt to teach the intellectual heritage of an idea. However, in keeping with our educational goal of sharing control over the content and its presentation, we needed strategies to allow readers to access the content in response to their individual needs.

By the time we designed our site, there had been plenty of examples of sites using search engines to allow readers to seek content by topic or theme, and so we quickly decided that our new journal site would have both a quick search and a more complex advanced search function readily accessible on the home page. This strategy addressed at least part of our goal of giving readers control over content.

With special online issues and links from new papers to older ones, we had succeeded in giving the editorial team control over the presentation of materials on the new site. With the quick and advanced search functions, we had succeeded in giving readers control over materials as well. But we felt that we needed something in between these two options that would allow for sharing of control.

We arrived at a design solution that we eventually labeled as a set of edited “content collections” on the journal home page. These collections brought together different types of materials all related to a certain topic or theme. The set of content collections grew to over 70 during the first 2 years of the online site; examples include collections in alternative assessment, adult literacy, educational psychology, urban education, and technology in the classroom. Each collection includes TCR articles and book reviews, related journals that publish on the topic, related research centers, articles available on the web on the same topic, new books on the topic, and a discussion board to hold the comments of readers on the theme of the collection and the materials that appear in the collection. To organize the set of collections we devised a small set of 18 major headings that cover most aspects of scholarship in education.

Creating the set of content collections required us to survey the field and make some editorial decisions about which topics were major ones and could serve as organizing areas for the collections. It also required us to designate the collections themselves. This forced us to make many editorial decisions regarding what was important for readers to focus on in examining the archives of TCR. These are not final decisions, and it is clear in discussions with our editorial board that different scholars might devise different sets of collections.

By featuring the content collections on the journal home page we provided readers with another point of entry into the large archive of material from the journal as well as related materials from other sources identified by the editorial team. Readers were able to begin with a collection close to an area of interest and then delve into the various resources as they saw fit. In effect, each content collection page becomes a new home page of the journal organized around a new theme.

### 3.2. A New Pedagogy

As we found ourselves in the midst of designing the new online home for the journal, we also found ourselves developing a new pedagogy suited to the online world. This pedagogy began with the look and feel of the site and extended to the arrangement of content on pages and the scheduling of the home page. The online site gave us the opportunity to orchestrate the entire environment to achieve our educational goals.

We began inevitably with the look and feel elements of the online site, those design features that would characterize the journal in the online environment and immediately let web surfers know that they had found us. Having only recently re-designed the print journal, we were reasonably well versed in the issues of design, but the online world presented some new challenges. We had to balance the need to position ourselves among the new and somewhat experimental online publications and general sites while retaining some connection to our heritage as an academic journal. We had witnessed other publications with long histories struggle with the same tension. For example, the *New York Times* had begun publishing online by providing readers with an exact replica of its traditional front page in a downloadable graphic file, but soon moved to a quite different but more web appropriate design that was consonant with the feel of the print product while making good use of the online venue.

The design we arrived at organized the home page in three columns with new features at the top of the center column, new book reviews at the top of the left column, and utilities for interacting with the journal on the top right. Further down the center column readers could find our list of content collections, and a community bulletin board occupied the lower portion of the left column.

The design was deliberately fashioned to avoid looking like our traditional print journal table of contents since we would not be using volumes and issues to organize material online. The design was also deliberately text-heavy compared to other online sites since we wanted to maintain the primacy of text to reinforce the authoritative and somewhat traditional approach to academic work represented by the journal. As one of our students noted, we looked

“more like the *Wall Street Journal* than *People Magazine*”. The home page had only one graphic in the masthead to identify the journal site clearly and consistently.

The design was deliberately simple with none of the bells and whistles that were appearing on other online sites at the time. This strategy was designed both to keep technical wizardry from overwhelming the content and to make our site accessible to the broadest possible audience, particularly those with slow connections and without multimedia computers. The design of the look and feel of the online site was a deliberate attempt to convey our first lesson that the journal was a place to come for ready access to the best content in education and educational research.

The focus on the content or the substance of the journal was conveyed also through the way each content page on the site was designed. Each article appeared in the large center column of a three-column page. This signaled again the central role of articles. The title of the article appeared at the top of the center column, followed immediately by the name of the author and his or her institutional affiliation. Beneath the author and affiliation line were two links, one to a short biography of the author and the other that popped up a window with a form to send an e-mail message to the author. We hoped to encourage dialog among readers and authors by making the e-mail process an integral part of the page on which the article appeared.

In the left column, immediately adjacent to the main body of the article were various kinds of related materials: related articles from TCR, related content collections, and related books. These related materials provided the intellectual context for considering the focal article, and each entry for related materials was a link to take readers directly to the related pieces.

On the right column on each article page were a set of tools for working with the content. These included a utility to send a link to the article to a colleague. This kind of utility had started to appear on other online sites, and we believed that sharing our articles among colleagues was a key part of enhancing scholarly communication. We also believed that it would help expand the base of readers for the journal. Also included in the right column was a utility to allow readers to create a printer ready version of the article. This version created a page with only the article without the TCR masthead and the related content and tools columns. We hoped that readers would use this utility to create printed copies of TCR articles for use in class or for their own files. Finally, the right column also offered readers a link to a discussion board for the article. The discussion board held comments from any and all readers who wished to react to the piece in question. Since encouraging interaction among readers was one of our educational goals, we hoped that offering readers online space to comment would generate online discussion.

We believed that the online journal would allow for much greater interaction among the editorial team, the authors, and the readers of the journal.

A key aspect of our approach to encouraging such interaction was a fundamental re-thinking of the timing and parceling of our content. For our print journal, we had been limited to publishing six to eight articles in issues sent by mail four times each year. When we approached online publishing, we had an opportunity to re-think both the way we packaged our content and the frequency with which we made it available to readers.

The tremendous flexibility afforded in the online venue was both liberating and confusing. We had no guidelines to help us think about how often to publish new content or how to organize it. Certainly, it made little sense to replicate our print schedule and issue structure. We approached the question with our educational goals in mind. We wanted to engage readers with each article we published. We began to think in terms of lessons and finally decided that each article was in some sense a single lesson. With this in mind, we decided to publish one new feature article at a time and later decided to include several book reviews as well. This seemed like enough to attract readers but not so much that they would find themselves unable to make their way through the material in a reasonable amount of time.

We also had to decide on a publishing schedule. We had published our print journal four times each year, but online publishing allowed us to publish as often as we wished. We could publish quarterly, monthly, weekly, or even daily if we chose. To arrive at a schedule we tried to imagine a typical reader and asked ourselves how much time a reader interested in education and educational scholarship might devote to any single publication. Our best guess, and it was literally a guess since we had no hard data to guide us, was that a faithful reader could not be expected to peruse our journal more than once or twice a week at the most. We also believed that publishing less than once a week online would allow the journal to fade from the readers' minds or easily drop from their set of habits.

With these considerations we decided to publish new content online once each week. This allowed us to feature a single article and a few book reviews. By featuring a single article, each of the articles we published became the "lead article" for a week. This allowed us to focus reader attention on the lessons to be gained from that article. We released a new edition with a new feature article every Monday.

We also decided to create a second weekly edition that would highlight sets of articles from our archives. This edition, which we designated as the "weekend" edition, was released every Friday. This second edition gave us another opportunity to focus reader attention on the rich collection of previously published material.

With our strategy of publishing new content every week in place, we decided to add one more element to allow us to reach out to our readers in an active way. We launched a weekly e-mail newsletter designed to remind readers of the journal and to introduce them to the new articles appearing that week. This newsletter gave us another opportunity to teach readers by focusing their

attention on certain aspects of the new papers being released. The newsletter became an additional set of “mini-lessons” designed to compete for reader attention in a very short amount of time. Although we always thought of the newsletter as an important element of our online publishing effort, we did not fully appreciate just how important it was until we learned from the comments of at least some readers that they valued the newsletter alone and seldom or never visited the journal site to get more detail on the topics covered in the newsletter.

In addition to the regular weekly publishing schedule and all of the related content, content collections, and resources, the online journal has given us unanticipated opportunities to engage readers in special educational events. Three such events illustrate just some of the possibilities for enhancing the educational impact of the journal.

When we launched the re-designed journal site in the fall of 2000, we were also offering a course in educational policy at Teachers College in both campus-based and distance-learning modes. The lectures for this course were delivered by a diverse group of faculty at the College, and the course served as a general introduction to the field of policy. The lectures were transcribed and digitized to make them available to the students in the distance-learning section of the course and as a reference tool for students in the campus-based section. We also offered the set of lectures as new content on the online site for the *Teachers College Record*. We treated the lectures as articles with multimedia components and encouraged readers to respond to the lectures using the integrated discussion boards on TCR in the same way we encouraged students registered for the distance-learning section of the course to discuss the material on the online course site. This experiment in online learning as part of the online journal proved popular for readers and suggests the possibilities for additional educational experiments with a hybrid journal-course format.

A second educational experiment was launched for the holiday season between the fall 2000 and spring 2001 semesters and has been repeated annually. Each holiday season we have devoted several weeks to featuring materials related to a major figure in the field of education and educational research. One year we focused on John Dewey and published papers by and about John Dewey from the TCR archives. In subsequent years, we have done the same thing focusing on Edward Thorndike and Maxine Greene. Each of these experiments has generated reader interest and attention during a normally quite time for academic publications.

A third experiment illustrates the power of seizing the teachable moment through rapid online publishing. In the immediate aftermath of the attacks on the World Trade Center and the Pentagon, we understood the great need of educators to make sense of the tragedy and help their students deal with it as well. We quickly posted a call for papers on the responses of educators and the educational system to this national emergency. As part of this call, we included a call for educators to submit examples of the artwork and writing

of students in response to the attacks. While we waited for our readers and authors to respond to the call, we also put online a series of articles from our archives dealing with the responses of educators to World War II in the aftermath of the attack on Pearl Harbor, the last major surprise attack on the United States. These articles dealt with the full range of issues that were strikingly parallel to those arising after 9/11. One of the lessons we took from this experiment is that the value of our archival materials can rise rapidly, as new events occur for which they carry special relevance. There was probably no other time in the last few decades when the papers on educators' responses to World War II would have gained such careful attention, and we happened to have the materials and the means to republish them online.

The design and operation of our online publishing platform has allowed us to advance our educational goals. We have done much more to allow the editorial team to reach out to readers. We have seized new opportunities to use all of the assets of the journal to enrich the conversation about educational scholarship and practice. We have found new means to share control of the journal with its readers and to engage them in the publishing effort.

### **3.3. Integrating Submissions and the Automated Editorial Office**

We have already discussed doing many things online that we were not able to do with our print journal. Indeed, since we began regular online publishing at *Teachers College Record*, we have done much more than ever before. We have published more content more frequently and provided more related resources in more diverse formats. We have done this by working harder to some extent, but we have also used our online publishing platform to achieve productivity gains in the operation of the editorial office.

When we launched the online publishing platform in the fall of 2000, we also moved our entire editorial operation online. We began requiring authors to submit all papers online, and we started handling all correspondence with reviewers online as well. From the time a paper is submitted, throughout the review process, and up to and including publication, all processing is handled on the computer desktop. This system also provides a complete record that allows us to track each manuscript at every stage in the process. The result has been a large gain in our capacity to receive, review, prepare, and publish papers with a smaller staff than we had before we began publishing online.

The integration of all journal operations through our online publishing platform has also allowed us to address problems that plague many academic journals. First, we have used our online publishing program to solicit manuscripts more widely than ever before. We provide complete and easy online directions for any author interested in submitting a manuscript to the journal. We also use the online site to issue special calls for papers. The fully online

process reduces submission costs for authors who no longer need to make multiple copies and pay for postage to submit manuscripts. This has led to a dramatic increase in the number of papers submitted annually. In particular, we have received many more papers from authors outside of the United States than we did before we began publishing online.

A good illustration of the effectiveness of using the online platform to solicit content for the journal comes from our efforts to expand the number of book reviews we publish. To develop a list of potential book reviewers, we put out a call for book reviewers on the online site and asked those who might be interested to complete a brief survey describing their interests and their expertise. We also gave them the option of providing a link to their online vita, so we could understand their background more fully. Over 1200 individuals volunteered to become book reviewers in response to this call, and we have been able to invite many of these scholars to become book reviewers. This has allowed us to involve individuals who might not have been involved in the past.

A second problem addressed by the online publishing system is the need to find and invite experts to serve as reviewers for the manuscripts submitted. Because our entire readership is registered in our member database, we are able to identify a large pool of qualified reviewers. We can query the database on any topic and find scholars with appropriate credentials to invite to become reviewers. The invitations are sent from the online platform, and reviewers can accept or decline our invitation and then, if they have accepted, download the paper at their convenience. After they have read a paper, they can submit the review again using the online system. By using an automated system for finding and inviting reviewers, we have been able to expand dramatically the pool of individuals involved in the review process.

The system tracks all manuscripts and all reviews and presents them to editors upon request. Editors can use the system to communicate decisions to authors, and authors can follow-up by submitting revised versions for publication. The system incorporates the copy-editing process, and the copy editors retrieve manuscripts and submit copyedited versions online. Finally, copy-edited manuscripts can be moved to the online publishing site quickly and with little staff effort. Versions of papers scheduled for the print journal can also be sent to the printer.

The dramatic efficiency gains we achieved from using the online system together with the far greater reach of the journal has allowed us to do something we did not contemplate prior to moving online. With more manuscripts being submitted and more capacity to process them, we have expanded our schedule of print issues from four per year to 12 per year. At the outset, one of our concerns was that we might have to choose between publishing in print and publishing online. Thus far in our experience, moving online has allowed us to do both at a higher level.

#### 4. PATTERNS OF USER EXPERIENCE

We have discussed our approach to the curriculum and the pedagogy of online publishing. In this section, we consider the third of Bernstein's (1975) elements of education, assessment. We do this by examining the behavior of users or members of the *Teachers College Record* online site over the 30-month period from its launch in November of 2000 through April of 2003. We address three questions that we have interested us since the outset of our online activities: how we might build an audience, how we can learn more about our readers, and how we can gain a greater understanding of what our readers want in an academic journal?

##### 4.1. Building an Audience

One of our goals in moving the journal online was to expand and diversify the readership. We wanted to reach more scholars than we had been able to do with our print journal, and we hoped that providing our content online would make it more accessible to educators and the general public. Of course, we also understood that there was no guarantee that we could achieve either of these goals.

With our print journal received by several thousand libraries and other institutional subscribers and with fewer than a thousand individual subscribers, we believed that the opportunity to increase readership was substantial.

When we launched the new online publishing site for TCR in the fall of 2000, we began requiring users of the site to register by providing a name and an e-mail address. This allowed us to track not only overall use of the site in terms of page views, but also the number of unique individuals accessing the content of the online journal. In October 2000, we began with about 8000 individual members largely gathered from users of our earlier online sites, subscribers to the print journal, and individuals who had submitted papers. By the spring of 2001, the membership totaled about 17,000. By the spring of 2002, the number of members of the online site reached 34,000, and by the spring of 2003, the number of members exceeded 65,000.

In addition to keeping track of the total number of individuals who had registered as users of the online journal site, we also monitored unique visitors to the site. Figure 1 shows the number of unique visitors for each month from June 2002 through May 2003. The site received nearly 6000 unique visitors in June 2002, and this number rose to well over 9000 unique visitors in May 2003. The increase in monthly unique visitors rose throughout the year with notable declines during the summer month of August and the holiday dominated month of December.

With the reading audience growing rapidly, we were interesting in knowing whether the audience was becoming more diversified and whether we



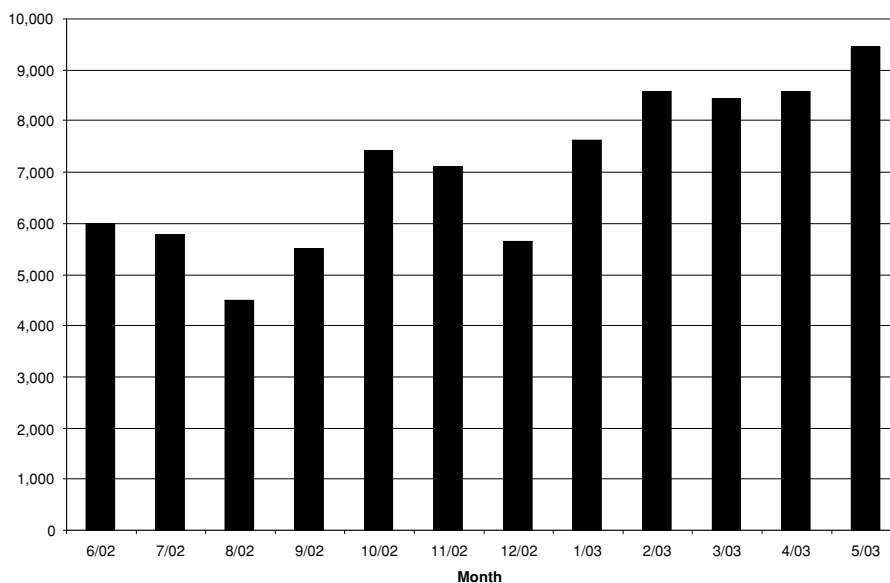

Figure 1. Unique visitors to the Teachers College Record online site—June 2002 through May 2003.

were reaching readers outside our traditional audience of scholars in institutions of higher education. To gain some understanding of the distribution of readers, we drew a random sample of 1000 members and examined their e-mail addresses and institutional affiliations for those who provided such information. Because individuals often provide a personal e-mail address instead of a business e-mail address and because many members decline to provide affiliation information, this analysis is less than ideal. Nevertheless, it does provide some indication of the diversity of the reader audience for TCR. About 27% of readers can be identified as associated with institutions of higher education. These are the readers traditionally reached by the journal. About 21% of the readers can be identified as being employed by k-12 school districts, and 10% identify themselves as students in higher education institutions. Smaller proportions of members were employees of research and development organizations or foundations (7%), independent professionals in education, and other sectors such as publishing or nursing (6.4%), and employees of a government agency (3.1%). For nearly one-fourth of the sample, we were unable to classify members according to sector.

Our monitoring of web site traffic also allowed us to understand the impact of the weekly newsletter that we typically send to those members who request it once each week on either Tuesday or Wednesday. As Figure 2 indicates, on those days when the newsletter announcing new content is sent to readers, the traffic is about three times as great as on the day prior to the newsletter.

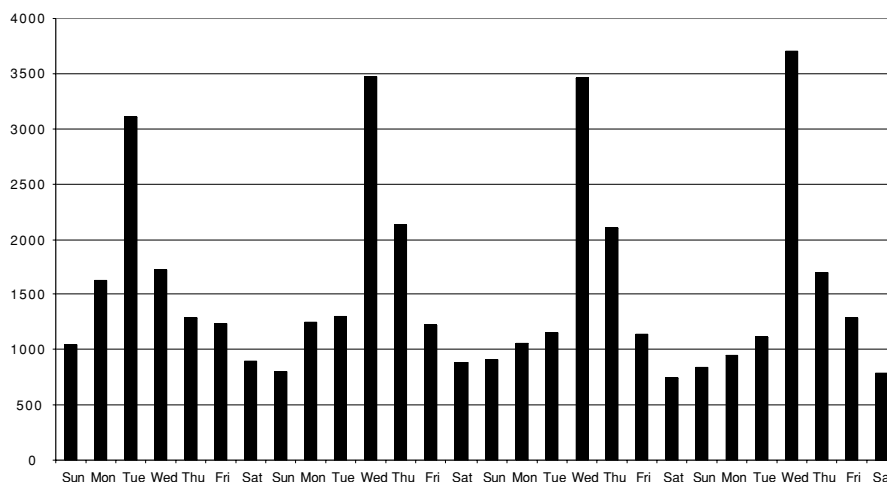

Figure 2. Unique visitors to the Teachers College Record online site by day—Sunday, May 4, 2003 through Saturday, May 31, 2003.

The traffic typically peaks on the day the newsletter is released, but it remains higher than normal for a second day.

An unanticipated byproduct of the dramatically larger audience for the journal has been an equally dramatic increase in the quantity and quality of manuscripts submitted for review. In the year prior to the introduction of the new online system, we received about 200 manuscripts. During 2001, the first full year of operations under the new system, we received over 300 manuscripts. This number increased to nearly 450 manuscripts in 2002, and nearly 300 manuscripts have been received during the first 6 months of 2003.

Our analysis of the level of use of the online site indicates that readership is growing over time, that the readership is extending beyond those scholars at institutions of higher education who have formed the traditional audience for the journal, and that the weekly newsletter serves to increase use of the materials available at the online site. Thus, moving the journal online is serving to build a larger and more diverse audience.

#### 4.2. Understanding Online Behavior

In addition to following the growth in the readership of the journal, we used the online publishing site to gain a greater understanding of reader interests by tracking reader behavior online. During the 12-month period from June 1, 2002 through May 31, 2003, there were 36,229 unique readers of the online journal, and these readers generated 1,955,452 page views on the journal site. (We have used page views as the unit for measuring use of the site since a

*Table 1. Activities of readers of the Teachers College Record online site—June 1, 2002 through May 31, 2003*

Articles viewed	409,067
Home page	224,826
Collections	148,256
General searches	87,348
PDF files downloaded	61,199
Articles printed	50,814
Collection posts read	39,016
Journals catalog	26,067
Links to external articles	24,745
Journals search	19,496
Links to Amazon.com	16,371
Articles e-mailed to a friend	10,417
Content posts read	8547
Views of the TCR index	7906
R&D centers viewed	5319
My account	5132
Collection posts made	475
Content posts made	285

view of an entire page is more meaningful than the often cited hit statistic what counts every graphic element on a page as an additional hit.)

Table 1 indicates the resources on the journal site that were used by readers during this 1-year period. Users viewed individual articles 409,067 times during the 12-month period. These include any of the over 1000 full-text articles from the past 20 years that are available online as well as older articles for which only a title or an abstract might be available. Readers viewed the journal's home page 224,826 times during this same time.

The next two most frequent uses relate to the two major ways of finding materials on the journal site, collections and searching. Readers accessed a content collection 148,256 times, and they used the general search utility 87,348 times. If we consider the content collections as the result of searches conducted by the editorial team, then the editorial voice represented in the collections appears to offer some value to readers, and they appeal to those collections in searching to meet their own needs more frequently than they use the general search.

The next two most frequently used resources, downloadable portable document files and the print article utility, allow readers to make print copies of journal articles. The portable document files are available for many articles and offer the same format as the print journal; the print article utility provides a full-page printer ready version of articles in html.

The next most frequently used resource on the site, collection posts, refers to readers accessing the comments of other readers posted on the discussion

boards in the content collections. Readers accessed the 475 comments of other readers in the content collections 39,016 times. Looking further down the table, we see that readers accessed the 285 comments of other readers attached to individual articles 8547 times.

The online catalog of journals in education was used 26,047 times, and the search utility attached to the journals catalog was used 19,496 times. Other resources not directly connected to the content of the *Teachers College Record* were also accessed by online readers. Links to external articles from the content collections were followed 24,745 times, links from content collections or book reviews to book information on Amazon.com were followed 16,371 times, and links to research and development centers from the content collections were followed 5319 times. Together, these other resources constitute a substantial portion of user activity on the journal site.

The utility that allows readers to send a link to an article to a friend or colleague was used 10,417 times during the year. This utility engages readers in promoting the content of the journal. The annual index that provides a view of journal content by volume was accessed 7906 times, and the page that allows users to manage the options on the online account, such as whether they wish to receive the weekly newsletter and whether they wish to serve as a peer reviewer, was used 5132 times.

Following reader behavior online also allowed us to gain some understanding of the topics within the fields of education and educational research that were of most interest to readers of the journal. We did this by tallying the reader visits to the various content collections displayed on the home page. Table 2 shows the number of reader accesses of the content collections organized by

*Table 2. Reader accesses of the Teachers College Record content collections—2001 through 2002*

Policy	19,924
Curriculum	15,635
Social context	13,724
Student diversity	13,449
Assessment and evaluation	12,079
Technology	10,956
Research methods	10,177
Administration	9896
Teacher education	8905
Learning	7956
Teaching	7674
Early childhood	6424
Adult education	5892
Higher education	4444
International education	3629
Counseling	2662

the 16 broad categories we created to organize articles and other resources. As Table 2 indicates, collections in two broad categories, policy (19,924 visits) and curriculum (15,635 visits), received more than 15,000 visits. Collections in five categories, social context (13,724 visits), student diversity (13,449 visits), assessment and evaluation (12,079 visits), technology (10,956 visits), and research methods (10,177 visits), received between 10,000 and 15,000 visits. Collections in administration (9896 visits), teacher education (8905 visits), learning (7956 visits), teaching (7674 visits), early childhood (6424 visits), and adult education (5892 visits) received between 5000 and 10,000 visits. Finally, collections in higher education (4444 visits), international education (3629 visits), and counseling (2226 visits) received fewer than 5000 visits during 2001 and 2002.

#### **4.3. Lessons Learned**

Several things are clear as a result of our analysis of patterns of use of the online journal site. First, the online site for the journal is a powerful tool for increasing readership and generating both more and higher quality submissions. The growth in readers appears to involve both drawing more readers from our traditional base among faculty members and students from institutions of higher education and engaging new readers from k-12 school districts, and from foundations, government agencies, and other sectors such as publishing. Second, our weekly newsletter appears to work very effectively to bring registered users of the site back to the site to view new content.

Third, once readers are using the online site, as might be expected, they are most interested in the content provided in the form of articles. Fourth, again as might be expected, the home page is the most popular single page on the site. Fifth, the content collections of articles and resources organized by topic or theme are the next most frequently used resource and appear to be substantially more likely to be used by readers than the general search function.

The pattern of use of topics related to the discussion boards led us to several additional conclusions. Sixth, the rate of user comments differs by venue of discussion board with discussion boards attached to content collections generating more user comments than those attached to individual articles. This could be the result of our practice of featuring reader comments from the content collections prominently on the home page or it could be the result of readers being more inclined to comment on the more general topics represented by the content collections than the specific issues raised by individual articles. Seventh, there is substantial reader interest in the comments of other readers with each comment on individual articles being read an average of 30 times by other readers and each comment within a content collection

being read an average of 82 times by other readers. Again in explaining the seemingly greater popularity of the comments attached to the content collections, it is not possible at this point to disentangle the impact of the venue of the discussion board from our efforts to promote such discussions on the home page.

Eighth, readers at the online site did make use of other resources provided, including those not directly produced by the editorial team such as links to other online resources, although the use of such resources was less frequent than the use of *Teachers College Record* resources.

Ninth, reader interests as reflected in visits to the content collections are broad-based but concentrate on some collections such as policy and curriculum substantially more than others such as international education and counseling. The editorial implications of this pattern are at least twofold. On the one hand, substantial reader interest might suggest that greater investments should be made in editorial content in high use areas. On the other hand, if our goal is to create a broad-based journal in the field of education we might decide to invest greater effort in areas that receive less reader attention in the hope of increasing the utility of the journal to readers in these areas. The data available from the online site at this point do not allow us to understand the impact of enhanced content in an area on reader use.

## 5. NEW HORIZONS AND NEXT STEPS

Our experience thus far in creating an online venue for the *Teachers College Record* leads us to be very optimistic regarding the future of the online journal as an educational environment. We have used online tools to empower a small editorial team to build a large and still-growing audience with diverse interests in high-quality content and a willingness to participate in the continuing creation of the online site as an educational resource. The broad use of the online resources and the growing number of submissions attest to the self-reinforcing and self-sustaining nature of the enterprise. We anticipate significant further development of the online site in terms of its content or curriculum, its publishing or pedagogical approach, and in terms of its business and technology infrastructure.

Our success in operating the online journal has allowed us to address two enduring issues. First, despite initial reservations on the part of a substantial portion of our editorial board, the success of the online journal in reaching a larger and more diverse audience of educators, policy makers, and scholars has led the board to become more supportive of additional online efforts. Meetings of the editorial board are now dominated by discussion of our online initiatives, and board members regularly offer a range of suggestions for new online activities. Second, the popularity of the online journal has allowed us to improve the overall financial position of the *Teachers College*

*Record*. For many years, the *Record* operated with a subsidy from Teachers College. The online journal led to increases in both readership and the number of submissions received each year and allowed us to increase the number of print issues from 4 per year to 12 per year while enhancing the selectivity and the quality of the journal. The increase in subscription rates associated with more frequent publication has allowed the journal to cover all of the operating costs for the editorial office. Thus, although the online journal is available to readers without charge, the greater prominence of the journal overall has strengthened its financial position and made its future more secure.

Building on the expanded print journal, there is a very substantial opportunity to expand the content provided through the online journal site. With the growth in high-quality submissions, the journal will be able to provide more material of a higher quality. Moreover, the weekly publishing schedule allows us to do more to highlight every paper published. As the content grows, we will consider segmenting and targeting the weekly e-mail newsletter to subgroups among the readers so that those interested in a particular topic will receive information most relevant to their interests. Based on our analysis of reader online behavior, we will be re-doubling efforts to publish in areas where we offer relatively little and where our online audience has the potential to grow. This will necessarily involve some experimentation as we move forward. For example, we will be issuing calls for papers in areas such as counseling where we currently offer relatively little to determine if more content in an area will draw more readers to that area.

We also anticipate investing effort to create more powerful tools for readers to move through the sizable collections of content on the journal site. In addition to our current organization of content collections and search functions, we anticipate allowing readers to move through the different segments of articles, once those articles are online in full text html as opposed to the portable document files that now provide page images that cannot be searched. For example, we plan to allow readers to search for all articles referencing particular items.

In terms of our pedagogical approach at the online journal site, we are sufficiently encouraged by the results of our early efforts to stimulate reader engagement and participation to expand those efforts. In addition to our current discussion boards attached to each individual article and to the content collections, we plan to introduce a site-wide discussion board to attempt to create a critical mass of reader/discussants across all areas covered in the journal. The discussions attached to individual articles are scattered across the more than 10,000 individual pieces, and the discussion boards attached to the content collections are spread throughout over 70 collections. We want to experiment with a discussion or commentary area of the online site that will bring together provocative peer reviewed commentaries with reader comments. We hope to use this area of the journal to share even more control with users.

As part of our instructional mission, we also plan to introduce a new section devoted to authors that would contain a range of resources to assist them in preparing articles for publication through *Teachers College Record* or through other journal outlets. This new section will bring together current resources such as the journals catalog with short instructional pieces on how to prepare journal articles. We are also engaged in the early stages of exploring the development of an automated system of providing feedback to authors before their paper enters the review stream. Such a tool could link diagnostic feedback on a paper to available online resources for authors. We view this new set of resources as both a service to authors and as a way to enhance the quality of papers submitted even further.

Encouraged by our experience in mixing *Teachers College Record* resources with those from other sources, we plan to seek new opportunities to collaborate with others engaged in teaching either through classes or workshops or through conferences on important topics in the field. These joint ventures will inevitably blur the lines between teaching and publishing in ways that have the potential to enrich the educational program of the journal. Other online journals are also obvious candidates for collaborative ventures that would draw on resources from multiple journal sources. Publishers handling multiple journals may also be in a good position to present resources from groups of journals. For example, Taylor and Francis has organized collections of journals that it publishes in web arenas that offer access to articles for all journals in a content area such as education (<http://www.tandf.co.uk/journals/arenas.asp>).

One of the unanticipated byproducts of our work to create the online journal has been a continuing interest in the creation of online environments and the development of tools to reduce the costs and enhance the functionality of such environments. When we created the 2000 version of the *Teachers College Record* online publishing platform, we built a hand-crafted system to publish a single journal. This platform has served us well, but we no sooner completed the technical development of the platform than we discovered many reasons to change and enhance it. Rather than continue to invest in improving a single dedicated platform, we embarked upon a course to create a general publishing and education platform creation tool. This tool allows us to create any number of journals or other educational environments quickly and inexpensively. (For more information on this platform, see [www.frameworkers.com](http://www.frameworkers.com), named, incidentally, to honor those cottage weavers whose work was transformed by the industrial revolution and moved into factories where they labored attached to frames of one sort or another.)

The flexible, re-configurable publishing platform that will form the basis for the next generation of the *Teachers College Record* online site will allow us to engage in more experimentation as we position and re-position content and utilities to engage readers and then assess their response. It will also allow us to create new online journals or parts of journals at low cost. This will make it possible to do things such as creating instant journals to chronicle the



work of particular projects or events. It will also allow us to experiment with journals devoted to new topics to determine if there is a sufficient audience to justify further development. In the case of the *Teachers College Record*, it will allow us to mount new projects with ease. For example, we might create new content collections tailored for individual courses or we might allow each registered member of the online site to create collections for any course they might be teaching. This is but one of a host of strategies that might be pursued to make the resources of the journal more relevant to the needs of its readers.

We began this chapter by highlighting the educational mission and history of the journal. We end it after having demonstrated our record of early activities and after speculating on the next stages in the educational development of our online publishing venue. However, our presentation would be incomplete if we did not also note the importance of our own learning experience along the way. What began in the mid-1990s as a traditional academic journal has been transformed by the effort devoted to creating and sustaining an online-publishing operation. We have learned more than we ever imagined we might when we began, and it is clear that there is much more to learn about the educational role of our journal and the educational needs of our readers in the years ahead.

#### REFERENCES

- Apple, M. (1993). The politics of official knowledge: does a national curriculum make sense? *Teachers College Record* 92(2), 222–241. Retrieved July 11, 2003.
- Association of Research Libraries, the Association of American Universities, & the Pew Higher Education Roundtable. (1998). To publish and perish. *Policy Perspectives* 7(4). Retrieved June 2, 2003.
- Berliner, D. (1997). Educational psychology meets the Christian right: differing views of children, schooling, teaching, and learning. *Teachers College Record* 98(3), 381–416. Retrieved July 11, 2003.
- Bernstein, B. (1975). *Class, Codes and Control, Volume 3, Towards a Theory of Educational Transmissions*. London: Routledge and Kegan Paul.
- Born, K. & Van Orsdel, L. (2001). Periodical price survey 2001: searching for serials Utopia. *Library Journal* 126(7), 53–58.
- Bransford, J., Brown, A., & Cocking, A. (Eds.) (1999). *How People Learn: Brain, Mind, Experience, and School*. Washington, DC: National Academy Press. Available at: <http://books.nap.edu/openbook/0309070368/html/index.html>.
- Burbules, N. C. & Callister, T. A. (2000). Universities in transition: the promise and the challenge of new technologies. *Teachers College Record* 102(2), 271–293. Available at: <http://www.tcrecord.org/Content.asp?ContentID=10362>.
- Butler, N. M. (1900). Syllabi for Teachers College courses in education: principles of education. *Teachers College Record* 1(4), 205–223.
- Cremin, L. A. (1976). *Public Education*. New York: Basic Books.
- Dewey, J. (1914). Reasoning in early childhood. *Teachers College Record* 15(1), 9–15. Retrieved July 11, 2003.

- Dewey, J. (1938). *Experience and Education*. New York: Macmillan.
- Dutton, S. T. (1900). Syllabi for Teachers College courses in education: school administration. *Teachers College Record* 1(4), 225–236.
- Glass, G. V. (1994). Papyrophiles vs. cybernators: the future of scholarly publication. Paper presented at the *Annual Meeting of the Mid-Western Educational Research Association*, Chicago, IL, October 13. Available at: <http://glass.ed.asu.edu/gene/papers/papvcyb.html>. Retrieved March 7, 2004.
- Glass, G. V. (1999). A new day in how scholars communicate. *Current Issues in Education* [Online] 2(2) (September 8). Available at: <http://cie.ed.asu.edu/volume2/number2/>. Retrieved March 7, 2004.
- Greene, M. (1994). The arts and school restructuring. *Teachers College Record* 95(4), 494–507. Retrieved July 11, 2003.
- Hafner, K. (2001). *The Well*. New York: Carroll and Graf.
- Hage, J. & Powers, C. H. (1992). *Post-industrial Lives: Roles and Relationships in the 21st Century*. Newbury Park, CA: Sage Publications.
- Kiernan, V. (1999). ‘Open archives’ project promises alternative to costly journals. *The Chronicle of Higher Education*, A43 (December 3). Available at: <http://chronicle.com/prm/weekly/v46/i15/15a04301.htm>
- Kilpatrick, W. H. (1918). The project method. *Teachers College Record* 19(4), 319–335. Retrieved July 11, 2003.
- Kling, R. & Covi, L. (1995). Electronic journals and legitimate media in the systems of scholarly communication. *The Information Society* 11(4), 261–271.
- Lewis, L., Snow, K., Farris, E., & Levin, D. (1999). *Distance Education at Postsecondary Education Institutions, 1997–98*. Washington, DC: National Center for Education Statistics.
- McNabe, M. (1998). The impact of publisher mergers on journal prices: a preliminary report. *ARL Newsletter* 200. Retrieved June 3, 2003. Available at: <http://www.arl.org/newsltr/200/mccabe.html>
- Mogge, D. (1999). Seven years of tracking electronic publishing: the ARL directory of electronic journals, newsletters, and academic discussions lists. *Library Hi Tech* 17, 12–25.
- Monroe, P. (1900). Syllabi for Teachers College courses in education: history of education. *Teachers College Record* 1(4), 193–204. Retrieved July 11, 2003.
- Noble, D. F. (1998). Digital diploma mills: the automation of higher education. *First Monday* 3(1). Available at: [http://www.firstmonday.org/issues/issue3\\_1/noble/index.html](http://www.firstmonday.org/issues/issue3_1/noble/index.html).
- Odlyzko, A. (1997). The economics of electronic journals. *First Monday* 2(8). Retrieved June 3, 2003.
- Pea, R. (1994). Seeing what we built together: distributed multimedia learning environments for transformative communications. *Journal of the Learning Sciences* 3(3), 219–225.
- Resnick, L. B. & Klopfer, L. E. (Eds.) (1989). *Toward the thinking curriculum: current cognitive research*. Alexandria, VA: Association for Supervision and Curriculum Development.
- Rheingold, H. (2000). *The Virtual Community: Homesteading on the Electronic Frontier* (Revised Edition). Cambridge, MA: MIT Press.
- Smith, R. (2001). Electronic publishing in science. *British Medical Journal* 322, 627–629.
- Sweeney, A. E. (2000). Should you publish in electronic journals? *The Journal of Electronic Publishing* 6(2). Retrieved May 29, 2003.
- Thorndike, E. L. (1901). The study of children. *Teachers College Record* 2(3), 165. Retrieved July 11, 2003.
- Vrasidas, C. (2000). Promises of electronic forms of data representation and scholarly publication. *Teachers College Record*. Retrieved July 11, 2003.
- Wenger, E. (1998). *Communities of Practice*. Cambridge, U.K.: Cambridge University Press.

# Chapter 31: Professional Development & Knowledge Management via Virtual Spaces\*

NORIKO HARA AND ROB KLING

*Center for Social Informatics, School of Library & Information Science, Indiana University, Bloomington, IN 47405.*

## 1. INTRODUCTION

In the U.S., the mid and late 1990s was a boom period in many ways that included an expanding economy, a growing emphasis upon the value of people's working knowledge, and a range of new Information Technology (IT) applications and information services that depended upon computer networking—often the internet. These themes were represented in professional discourse by a special emphasis upon “knowledge work”, “knowledge workers”, and new practices, such as “knowledge management”. While genuine referents for the “knowledge categories” are often elusive, at best they refer to serious efforts of managers to improve their staff's abilities to become more knowledgeable by sharing information and insights within organizations and to leverage their enhanced knowledge for organizational value.

For example, in *Microsoft Secrets*, Cusumano and Selby (1995: 330–339) report the ways in which Microsoft's managers and software developers reviewed major software development projects through extensive and relatively open “project post-mortems” with the aim of improving future software developments. In *Working Knowledge*, Davenport and Prusak (1998: 6) mention the efforts of managers at Chrysler to develop “Engineering Books of Knowledge” for each new car platform to help to better inform designers of future platforms about more effective design strategies. While Microsoft's post-mortems were based primarily upon written reports and intensive face-to-face meetings, Chrysler's “Engineering Books of Knowledge” represent a 1990s move to use electronic environments as integral elements for helping professionals to share their information and knowledge with others in their organizations.

They also illustrate important forms of professional development. The elastic term “professional development” can refer to almost any way that working professionals are supported in efforts to increase their capabilities and competencies including courses, mentoring, workshops with experts, discussions with peers, and (in some cases) onsite observation, etc. In this chapter, we

\* To appear in: Joel Weiss, Jason Nolan, and Peter Trifonas (Eds.) *International Handbook of Virtual Learning Environments*. Kluwer Academic Publishers.

will focus on forms of professional development that overlap with knowledge management strategies—especially discussions with peers.

This chapter is divided into five sections. In the first section, new terms, such as knowledge management, professional development, and virtual spaces are introduced. The second section addresses discourses about professional development and knowledge management including e-learning—primarily because e-learning is a means to support professional development with IT and currently receiving intensive attention. For the third section, four case examples are described in order to depict possibilities and problems with professional development in virtual spaces. The fourth section discusses these cases and the implications they have for professional development in virtual spaces. Finally, we conclude the chapter by pointing out the hype surrounding knowledge management and noting that knowledge management is not just an IT system.

In the 1990s, the development of varied IT applications that enabled professionals to share ideas and information at work flourished. These ranged from new forms of groupware (Kirkpatrick, 1993), such as Lotus Notes, which consist of online documentary repositories that enabled web-conferencing systems. In educational communities, these were often called Virtual Learning Environments, while in corporate settings these knowledge management systems were often referred to as groupware. In this chapter, we use the term Virtual Spaces to refer to this diverse collection of artifacts. We view learning and sharing professional knowledge as accomplishments that can (sometimes) be facilitated by Virtual Spaces. For example, there were a number of projects that supported professional development via peer conferencing for K-12 teachers, such as LabNet (Ruopp et al., 1993; Spitzer & Wedding, 1995), “Tapped In” (Schlager et al., 1998), and the Internet Learning Forum (Barab et al., 2000).

Many of these projects were IT-driven; they tended to focus the majority of their resources on developing the supporting information technologies. However, as we shall show below, the research has found that learning and knowledge sharing are not automatic consequences of the development and deployment of Virtual Spaces. The more successful projects are based on an integrated socio-technical intervention in which supporting social processes are given as much attention as the technological design of the Virtual Space.

## 2. DISCOURSES ABOUT PROFESSIONAL DEVELOPMENT AND KNOWLEDGE MANAGEMENT IN VIRTUAL SPACES

There are several discourses about innovative organizational practices. One set of discourses is very public and appears in mainstream business and professional publications. In the 1990s, much of the professional and popular writing about internet support activities, including e-commerce, e-learning,

and knowledge management was promotional and tinged with technological utopianism (Kling, 1994). In a study of management fashions, Abrahamson (1996) observed:

fashionable management techniques must appear both rational (efficient means to important ends) and progressive (new as well improved relative to older management techniques). Many management fashion setters—consulting firms, management gurus, business mass-media publications, and business schools—compete in a race to define which management techniques lead rational management progress (p. 254).

The term, “knowledge management” appears to be one of today’s fashionable management techniques. Lambe (2002) justifies this perception by listing several indicators: new topical magazines have sprung up; institutes and societies have appeared out of nowhere; new job titles, such as Chief Knowledge Officer, are being invented; etc. He concludes his essay by saying that some knowledge management practices that were adopted as a part of a fashion move may disappear, but that many leading companies have taken knowledge management rather seriously.

We searched the practitioner literature for articles that mentioned the term “knowledge management” in the information service Factiva that includes articles from approximately 8000 sources such as major international newspapers and business magazines. On October 27, 2002, a search for “knowledge management” on Factiva retrieved 40,203 articles. We further plotted the numbers of articles that mentioned knowledge management between 1988 and 2001 (see Figure 1). The number started small, i.e., 3 references in 1988,

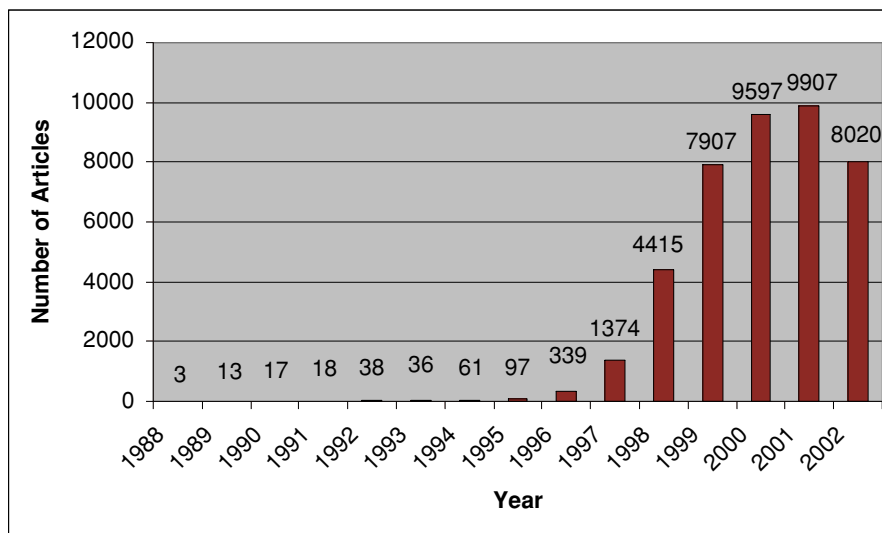

Figure 1. Number of articles in Factiva that mentioned knowledge management.

13 references in 1989, and 17 references in 1990. In this early stage, most of the articles that referred to knowledge management discussed Knowledge Management Systems, databases, and expert systems. The number of articles in 1996 was more than triple the amount of knowledge management articles written in 1995. During this stage, articles related to consulting practices and strategic management began to appear. The tremendous increase of knowledge management articles did not stop until 2000, when it dropped to a 3% annual increase compared to a 21% increase between 1999 and 2000. In 2002, the number declined approximately 20% from 9907 in the previous year to 8020.

E-learning is another trend that seems to attract many companies. The term e-learning is subject to many slightly varied definitions, but they all emphasize the centrality of some kinds of electronic information technologies to support learning, from CDs to computer networks. E-learning is also used to support professional development with distance education. It has been discussed rather enthusiastically, but without much empirical evidence to support important claims. For example, Davis and Botkin (1994) preached about the vast possibilities of education with technology. However, their focus was more on promoting the technology use in education and less on pedagogies and practical implications. Empirical research conducted by Anderson and Kanuka (1997) found that students who used online forums for professional development reported that they had a difficult time socializing with others and getting their ideas across compared to the use of face-to-face forums. Research (Howell & Stinson, 2001) suggests that a hybrid type of e-learning (i.e., use both face-to-face and online learning) would be more effective than either online or face-to-face alone. In addition, we need to consider specific pedagogies applicable to online environments. Bonk and Cummings (1998) introduced a dozen recommendations for making web-based instruction student-centered.

Although both the field of e-learning and that of knowledge management deal with techno-enthusiasts, the issue of professional development via e-learning and that of knowledge management are slightly different. In distance education, knowledge is “available” in teaching materials, whereas knowledge management projects often require participants to share, not just to “receive” (c.f., Kling & Hara, 2004).

Unfortunately, the literature on professional development is scarce and tends to be clustered around different professions. It is a rather application-driven field. Due to rapidly changing technology and increasing knowledge in recent years, professional development has become crucial to various professions (including teachers, physicians, lawyers, and engineers) even though technologies have supported professional development efforts throughout years. For example, Feenberg (1993) described his efforts to support a course offered to corporate executives in the 1980s with computer conferencing. This kind of effort, along with Hiltz and Turoff’s (Turoff, 1991), stimulated the use

of computer conferencing for professional development, and these ventures did not begin with the public access of the internet.

A good deal of the professional literature concerning professional development via web conferencing and IT support for knowledge management is written with a high level of normative enthusiasm and relatively little attention to the socio-technical complexities of achieving the desired outcomes. In many cases, IT was characterized as a “magic bullet” (Markus & Benjamin, 1997) that could readily enable important kinds of organizational change without much pain. For example, Davenport and Prusak (1998) used the efforts of managers in five different locations at Chrysler to develop “Engineering Books of Knowledge” for each new car platform to illustrate their approach to knowledge management. But they never discussed the ease or difficulty that the managers faced in persuading busy engineers to effectively contribute to these “Engineering Books of Knowledge”, nor did they ever discuss the actual quality and value of any of these “Engineering Books of Knowledge” whose contents were based on “altruism”, i.e., the engineers could not bill their writing time to their own projects. Rather, Davenport and Prusak’s readers are encouraged to believe in the quality and value of Chrysler’s Engineering Books by implication. Some of Chrysler’s managers took these “Engineering Books of Knowledge” very seriously, and Davenport and Prusak saw them as useful examples of knowledge management. However, Davenport and Prusak do not provide evidence on how useful the “Engineering Books of Knowledge” had been to the engineers at Chrysler. They are treating this example of knowledge management strategy as a “black box”. In other words, they do not tell us what is happening with the strategy and the tool. They merely present the black box and mention the outcomes of the black box, but not the internal mechanics.

On the other hand, this example also works as a romantic lure that implies that electronically shared Engineering Books in a Lotus Notes database can be used as a technological fix for effectively improving the design expertise of an automobile manufacturer whose products usually had notably more manufacturing defects than their competitors in the late 1990s. In a similar way, much of the professional writing about web conferencing for professional development has amplified the lure of possibilities rather than examined complex socio-technical realities.

One might expect the scholarly research literature to provide a richer and more nuanced understanding of professional development and knowledge management with electronic support. Unfortunately, the research literature concerning knowledge management via Virtual Spaces is very mixed at best. Schultze and Leidner (2002) systematically examined the character of research that was published in six international information systems journals that focused on knowledge management between 1990 and 2000. Over 70% of the 75 studies that they examined were primarily normative, involved consensus-based findings, and were written from the perspective of organizational elites.

Studies of this sort would echo Davenport and Prusak and supported knowledge sharing projects such as the “Engineering Books of Knowledge”. Only 28% of the studies (21 out of 75) examined knowledge management from the perspective of multiple participating groups and knowledge management practices as seen by these groups. On the other hand, knowledge management projects, such as Chrysler’s “Engineering Books of Knowledge”, place critical emphasis upon the participation of non-management groups, such as the engineers whose expertise is being sought. It is unfortunate that so little of the knowledge management literature helps us to understand how knowledge management projects look from the vantage point of the participants who have to be mobilized to share their knowledge.

In this chapter, we will briefly describe four empirical case studies of professional development that were supported by Virtual Spaces, such as Lotus Notes, web-based conferencing systems, or LISTSERVs. These include

- (a) the efforts to use Lotus Notes to support knowledge sharing by the consultants of major consulting firms;
- (b) the creation of a web-based conferencing system to support online classroom visits and discussions of teaching practices by secondary school science and math teachers;
- (c) the efforts of public defenders in a metropolitan county court to improve their skills via discussions with other public defenders; and
- (d) the experiences of in-service teachers who took an online graduate course as part of their professional development.

### 3. CASE EXAMPLES

#### 3.1. Lotus Notes in Consulting Firms

One way to illustrate a contextual inquiry of IT and social behavior is to examine case studies of organizations. Examples can be found in studies of how some consulting firms have adopted and used computerized documentary systems. The following two cases illustrate the importance of incentive systems. In one case, reported by Orlikowski (1993), the consulting firm did not provide effective rewarding for consultants to share their knowledge. By contrast, a case reported by Ernst & Young (E&Y) revealed that incentive systems promoted knowledge sharing.

One major consulting firm, identified by the alias Alpha Consulting, bought specialized equipment and 10,000 copies of Lotus Notes for their staff in 1989 (Orlikowski, 1993). Lotus Notes, a documentary support system, is superficially similar to an internet system, with bulletin boards, posting mechanisms, discussion groups, and electronic mail for organizations. Depending upon how Notes is used, it can act as an e-mail system, a discussion system, an electronic publishing system, and/or a set of digital libraries.



Alpha Consulting is an international consulting firm with tens of thousands of employees worldwide (about 10,000 of those employees are located in the United States). Their director of information and technology believed that Lotus Notes was such a powerful technology that its usefulness would be patently evident, and that the main thing to do was to rapidly make it available to the consulting staff and let them use it to find creative ways to share information. The director of information and technology felt that Lotus Notes was so revolutionarily valuable that people did not even have to be shown illustrative business examples of its use, and that providing examples would, in fact, be counterproductive as it might stunt employees' imaginations. The consultants, by being given an opportunity to use it, would learn how to use it in creative ways.

The line consultants were intended to be Lotus Notes' primary users. Organizational informatics researchers found that the senior line consultants, who were partners in the firm, tended to be modest users, while the more numerous junior line consultants, called associates, were low users. These junior consultants often seemed uninterested in learning how to use Lotus Notes, readily gave up if they faced early frustrations with Notes, and as a group, did not spend much time with the software. What can explain the differences in practices of use of Lotus Notes between two different groups in the same organization?

One explanation focuses upon the incentive systems in the firm, and starts with an analysis of the different ways that the associate consultants and partners were rewarded. Alpha Consulting, like many other large consulting firms in North America, reviews its consultants via a demanding promotion system. The associates receive an "up or out" performance review every 2 years. In the first few career reviews at major consulting firms, about half of the associates are fired. Associate consultants, afraid of these major layoffs and wanting to be made partners, will not spend the time to learn Lotus Notes due to the lack of company incentive. Once consultants are promoted to the status of partners, they can expect annual incomes of over \$300,000 at these major firms. Partnerships are the golden ring that these firms use to motivate their associate consultants, and partnerships are earned by performance.

The way many consultants in E&Y, another major consulting firm, organized Lotus Notes as a more integrated socio-technical intervention is equally instructive (Davenport, 1997; Gierkink & Ruggles, 2002). In brief, E&Y created an organization (Center for Business Knowledge) whose charter was to organize E&Y's consultants' know-how in specific high-profile areas. The new organization was staffed with consultants from other E&Y offices who were given 6-month assignments to play a special role as "knowledge networkers". By 1997, E&Y had developed 22 distinct cross-office networks of consultants with expertise in certain industries, organizational reforms, or technologies that were a focus of E&Y's business. Each consultant network was assigned a half-time person (the knowledge networker) to codify

the insights from specific consulting projects in Lotus Notes databases, to prompt line consultants to add their own insights, and to edit and prune a project's discussion and document databases. In some cases, they developed topical "Power Packs" in Lotus Notes. These are structured and filtered sets of online materials, including sales presentations and proposal templates. Davenport (1997) observed that these knowledge networkers understood their consultant network's topics, and that since these were short-term assignments for the consultants, they expected to utilize any newly gained expertise to advance their own careers when they returned to their consulting positions.

In this case, E&Y designed a human organizational "intelligence system" for sharing insights, ideas, and materials in specific topical areas. Lotus Notes served as an information support system—a medium for storing, organizing, and communicating these materials, rather than as a magnet to mobilize consultants to capture their knowledge so it could be shared with others.

### **3.2. E-Forums for Professional Development Among Teachers**

This case describes the difficulty of community building in an online environment. The Inquiry Learning Forum (ILF) was created in 1999 by researchers at Indiana University's School of Education as an online forum to support inquiry-based teaching and learning practices among Indiana science and math teachers at the secondary school level (see <http://ilf.crlt.indiana.edu>). The underlying conception was to provide a set of interesting teaching materials, including videos of a class, lesson plans for that class and the teacher's reflections about the class. Each specific class (such as teaching the Pythagorean theorem) was organized in a separate unmoderated forum with its own threaded discussion list. Teachers could register at any time. While the registrants were screened to insure that they were appropriate teachers (or student teachers), the e-ILF was "open" in the sense that its membership could continually expand. New teachers could join and participate in any of the online forums, long after their discussions had started.

The ILF's organizers expected teachers to discuss the teaching materials, reflect on their own teaching practices, and function as a "community of practice" (Barab et al., 2000). "Communities of practice are informal networks that support professional practitioners to develop a shared meaning and engage in knowledge building among the members" (Hara, 2000: 11).<sup>1</sup> By mid-2001, the ILF's support staff worked with 17 teachers to develop videotaped "classrooms" on the ILF's web site (which we call the e-ILF). Over 200 in-service teachers out of approximately 26,000 secondary math and science teachers in Indiana had registered for the e-ILF, along with nearly 200 student teachers at Indiana University. However, participation in the e-ILF

has not reflected the breadth of this membership: statistics collected in March 2001 show that only 29 teachers had logged in five or more times, and 19 had logged in ten or more times. Most discussion in the online forum has been limited to a relatively small group: 31 of the registered in-service teachers had posted five or more messages, and 14 posted ten or more messages. The number of posted messages connected to each “classroom” vary widely, but a typical set of 15 posts is threaded into 6–7 topics with anywhere from 0 to 3 responses each. The “lounge” section of the web site contains general topics for discussion, with a typical topic taking up 15–30 posts over a 1-year period.

Unfortunately, the difficulties of supporting reflective dialog and community building in online forums seem to be under-appreciated within the educational technology communities. Sherry (2000) is all too typical in unreflectively reporting claims that:

One advantage of text-based communication is that written communication tends to be more reflective than spoken interaction. ‘The very act of assembling one’s thoughts and articulating them in writing for a conference audience appears to involve deeper cognitive processing’.

(Berge, 1997: 10)

Arguments framed in this way make it appear that the use of text-based electronic communication will almost certainly lead to reflective dialogs where assumptions are evaluated, alternatives discussed, contexts carefully explored, etc. However, according to research on typical teaching practices in the U.S., teachers rarely engage in this kind of discussion when they are meeting face-to-face (Little, 1982; 1985; 1990). Perhaps we should not be surprised to find that such reflective discussion does not spontaneously arise in the e-ILF.

Our observations of the e-ILF discussions are consistent with mid-1990s research findings from the LabNet project, an e-forum designed to support the professional development of science teachers. DiMauro and Gal (1994) examined the online discussions of a group of science teacher leaders who were acting as liaisons with the staff of an online professional development project. A network infrastructure was designed to enable these teachers to “exchange messages to reflect upon their peer support”. The messages were characterized as informative, responsive (to a query), or reflective (one in which a participant “thinks out loud” about some teaching practice and different ways of approaching it). DiMauro and Gal note that reflective postings were very infrequent. With shrewd insight, they observe that:

“Reflective responses are difficult to formulate and risky to post because of the personal nature of the content . . .”

They speculate about the conditions that support reflective postings, and suggest that they include “protected workspace for reflection, retrieved text base, collaborative research, access and response to messages, structure dialogue, linking action with reflection, forming reflective practice inquiry, and participatory motivation”. Some of these conditions are found on the e-ILF (i.e., retrieved text base). However, only the Bounded Groups have a protected workspace for reflection. In contrast, postings in the virtual classrooms may be read by any teacher who joins the e-ILF in the future.

By mid-2000, the ILFs designers expanded the range of forums to include some for “bounded groups” where reading and posting were restricted to a specific membership (Kling & Coutright, 2004). The bounded groups included teachers who were engaged in a specific curricular reform, as well as classes of student teachers. The bounded groups proved to be much more viable than the open-ended classrooms. The participants of each bounded group usually knew each other and had some reason to believe that their postings would not be read by people who did not belong to the group (other than ILF researchers). Most importantly, members of the bounded groups met face-to-face periodically, and developed some workable trusting relationships in various face-to-face encounters. The e-ILF and its support staff did not face the challenge of developing trust and a sense of community within an exclusively electronic environment. As was the case of E&Y’s organization of professional knowledge sharing through Lotus Notes, the technology was seen as supporting complex human relationships that were developed offline.

Developing high levels of collegiality and critical engagement among K-12 teachers has long been perceived as a major challenge. In fact, the nature of the e-ILF interactions described above is consistent with empirical research on teachers’ interactions in general, which are characterized by a lack of direct advice or criticism (Ellis, 1993; Little, 1985; 1990). Overcoming this “etiquette” (Little, 1985) and promoting greater critical engagement and sense of group identity might require mechanisms—both online and offline—conducive to forging greater trust among e-ILF’s members for open, frank discussions, and engagement.<sup>2</sup> In order for the ILF to build strong mutual ties among members so that it represents a vibrant community instead of a dispassionately used online discussion site, certain structural changes might be necessary to stimulate such engagement, trust, and group identity. Community development is likely to be an accomplishment that is difficult to initiate without purposive interventions from some kind of leader or steward. This will rarely happen spontaneously in online forums.

### **3.3. Listserv for Sharing Knowledge Among Public Defenders**

Hara (2000) examined how two public defenders’ offices shared and constructed their knowledge and how they used collaborative IT to learn from

each other. It was estimated that 20% of the attorneys in a large metropolitan public defender's office used the listserv provided by the state public defender council for defense attorneys in this state. A listserv is an e-mail list which can be subscribed by multiple people and allow them to engage in online discussions. The study used the pseudonym "pubdef-L" for this listserv. About 250 attorneys subscribe to this listserv in order to share information. It is not open to the public. In order to be a part of pubdef-L, a user must be a member of the state public defender council and send in a request to join pubdef-L. The traffic in pubdef-L is relatively heavy. For instance, there were 214 messages within 2 weeks, between October 1, 1999 and October 16, 1999. Linda Ellis,<sup>3</sup> a misdemeanor attorney who subscribed to pubdef-L, summarized its characteristics: "There are a lot of experienced lawyers on there, so you get different information. A lot of wisdom comes through pubdef-L to help solve problems and give suggestions, and cite and find cases. It's a good asset". Roy Stewart, a major felony attorney, also had high regard for pubdef-L:

[The listserv is] great because attorneys all over the state are on that, and it's not uncommon for an attorney in a small county to ask a question, "how do I deal with the situation"? and he'll get responses. Other defense attorneys are willing to help. The attorneys all over the state give him some ideas. So, that's really helpful. That's like being able to brainstorm with your whole community of defense attorneys. It all came together within about the last three or four years. Before that, I don't know how people kept in touch (interview with Roy Stewart).

Roy was an experienced attorney, yet he valued the information coming through pubdef-L because he considered it a brainstorming tool within the community of defense attorneys. Further, we infer that pubdef-L helps connect the defense attorneys throughout the state and creates a sense of a community among them.

Pickering and King (1995) examined the motivation for e-mail use in interorganizational communication. They note that "most of the messages posted to Usenet newsgroups are requests for particular information and assistance with problem-solving" (p. 481); the discussions in pubdef-L have similar characteristics. Pickering and King further argue that Interorganizational computer-mediated communication supports dispersed occupational communities. Pubdef-L appears to uphold this function.

In addition to information sharing and problem solving, Cathy, a less experienced attorney, sees pubdef-L as a great learning resource: "Since I'm new, I just learn a lot, I'm not at a point where [I'm responding much] . . . But I just learn a lot from hearing about different issues". Hence, pubdef-L provides a learning space for less experienced attorneys as well as the more experienced ones.

Angela, an experienced attorney, cautioned that pubdef-L can reduce the opportunities for less experienced attorneys to conduct research by themselves, because the listserv is only for question-and-answer sessions, not for research. There might also be a danger of relying on the information from pubdef-L too much without critically judging its quality. Alex Gordon, supervisor of the major felony attorneys, warned that attorneys needed to be selective about the information that can be obtained through pubdef-L by saying there is “lots of junk in it”. Therefore, these attorneys who are on pubdef-L have to evaluate the quality of the information obtained through it. Both Alex and Angela mentioned that their criteria for judging the information was based on the message senders, e.g., whether they are good courtroom attorneys. They both emphasized the importance of knowing court performance. They have been practicing in this field long enough to know most of the other attorneys and their reputations. On the other hand, less experienced attorneys did not mention this type of evaluation process while reading messages on pubdef-L.

In summary, the attorneys appear to use pubdef-L for many purposes: to ask questions, share updated information, brainstorm strategies in trials, discuss current legal issues, and learn from the discussions. The study found that the characteristics of pubdef-L resemble the attributes of the communities of practice.<sup>4</sup> Significantly, this online community of practice appears to have been developed to share legal expertise, partially because it is a closed listserv and most of the attorneys knew each other in courts. However, there are some components that do not exist in this online community of practice. For example, it is difficult to confirm that these defense attorneys develop a shared vision because all members of the community were not necessarily public defenders. Some of the members are contract (part-time) public defenders who are private attorneys.

#### **3.4. Coordination Issues in Distance Education**

The following case describes coordination issues in a web-based distance education course, B3002 (Hara & Kling, 2000). It is an ethnographic case study of students’ experiences in this course undertaken in 1997. One major aim of the study was to understand the experience of taking an asynchronous text-based, internet-enabled course from the point of view of its student participants. At the time, very few such studies had been completed. While students’ perspectives are sometimes represented in the research literature, they are generally gleaned through course evaluation forms (Rossman, 1999) and concise characterizations based on students’ comments or experiences.

In this case, the students and instructor relied upon e-mail as a primary means of communication. In fact, the instructor required that students post e-mail to the class discussion forum “at least five times during

the course". Her syllabus also noted: "Participants are expected to check the list daily". The students and the instructor in B3002 generated intensive online discussions through e-mail, and all of the students posted far more than 5 one-to-two page-long messages. During the week of October 19th, they posted 35 messages; this volume was common throughout the semester. On the surface, this volume of discussion indicates a lively class. However, we found that there were some underlying problems with the reliance on e-mail.

First, it was evident that some students did not read other people's postings before writing their own e-mail messages. Second, some students were unable to make time to read and post e-mail during short intensive discussion periods. For example, one student did not post any comments when the other students intensively discussed a particular topic for 2 days in the middle of the semester. After another student summarized the overall discussion in his e-mail, she sent an e-mail that had a subject line saying, "Ah . . . I cannot catch up with all of you : ("She was one of the students who posted the fewest number of e-mail messages to the online class discussion. Some other students also reported that they were overwhelmed by the volume of e-mail, and that they fell behind in reading and responding online. The research literature indicates this complication of asynchronous computer-mediated communication. Wegerif (1998) also reports a student's comment of the "daunting prospect" of being behind reading messages. In this course, the instructor and students did not discuss the question: how much posting is sufficient to satisfy the course requirements?

As noted in the above example, the discrepancies between students' behaviors and the instructor's expectations were a major issue. Another example is of a student who was working at night alone in a computer lab and had not received specifications for the assignments from the instructor; he was confused about the instructor's expectations. In this course, the students and instructor did not have discussions about each other's expectations, e.g., how long it takes for the instructor to get back to students' questions in general. The students did not know whether they should expect to receive replies within 24 hours, 72 hours, or a week.

A major advantage of asynchronous computer-mediated communication is that it reduces the constraints of time and location (Ahern & Repman, 1994; Burge, 1994; Harasim, 1990; McIsaac & Gunawardena, 1996). However, it can be very demanding for students and instructors to read all their messages and to respond thoughtfully (Hara et al., 2000; Hiltz, 1998; Kang, 1988; Wiesenber & Hutton, 1995). The instructor also commented that at the beginning of the semester she was spending all day doing nothing but reading and responding to e-mail messages. Later in the semester, she was able to reduce her workload, because she became familiar with how to handle e-mail messages for the course (i.e., not spending too much time on individual messages), but still spent a large amount of time on this course.

## 4. DISCUSSION

### 4.1. Social Processes in Virtual Space

One of the key issues that has not gained attention in the research, and particularly in practice, is that workers' incentive structures influence the level of knowledge sharing within Virtual Spaces. This issue is not specific to the activities within Virtual Spaces. In general, people in certain organizations are hesitant to share their knowledge because they might lose their competitive edge. An article in *The Wall Street Journal* reports a view from the shop floor on knowledge management (Aeppel, 2002). It reports that many workers resist sharing their knowledge in workplaces, because they are afraid of losing their jobs once the companies have the knowledge. In order to encourage knowledge sharing, incentive systems need to be changed, so that workers will be rewarded, instead of punished, when they share expertise. This incentive issue was illustrated by the first two cases: the Alpha Consulting firm (Orlikowski, 1993) and E&Y (Davenport, 1997). The former case did not succeed in supporting the sharing mechanism because the management did not take the incentive structures into consideration. Conversely, E&Y altered their original incentive structure in order to reward the knowledge sharing process.

As Markus and Benjamin (1997) note, many IT practitioners perceive IT as an enabler "magic bullet". However, IT applications are not sufficient by themselves; one needs an associated social process to encourage participation. As illustrated in the case of E&Y, social processes, such as incentive structure and organizational structure, need to be architected so that people participate in intended activities—in this case, knowledge sharing. In the ILF case, the tool was developed without consulting with the actual users, i.e., teachers. ILF did not have the materials that the teachers needed for their immediate use, did not consider the time constraints of teachers, and did not engage in community building to offer a safe environment for teachers to give each other critical feedback. As a result, ILF suffered from low participation. These two cases vividly illustrate the importance of installing social processes as well as technical applications.

Trust issues also have to be worked out between participants to enable sharing potentially embarrassing "knowledge" and practices. This issue was described in the ILF case, in which teachers were afraid to criticize other teachers' teaching or postings. Once they posted their messages in the classroom e-forums, they could be viewed by any teacher who registered for the e-ILF. However, they were not given opportunities to get to know each other very well, and hence, were unable to develop the trust necessary for meaningful rapport. Consequently, their postings ended up becoming self-reflection, rather than more useful mutual feedback. It is very difficult to establish trust in virtual environments (see Jarvenpaa & Liedner, 1999). One way to facilitate the development of trust is through face-to-face meetings.



On the other hand, the pubdef-L listserv provided an online space in which participants who worked in many different city and county courts were willing to share certain legal knowledge. Some of the participating lawyers knew each other personally; and they participated in a relatively small, relatively stable professional world of public defenders in their medium-sized state. Violations of trust could be readily known and “come back to haunt” the violators.

Coordination issues can be complicated in distance education courses. Hara and Kling (2000) emphasize that students’ ongoing desire for “prompt unambiguous feedback” is much more difficult to achieve in text-based asynchronous courses than in face-to-face conditions. For instance, students working on the course during late evenings and weekends had to wait longer for the instructor’s feedback. This issue could be even more amplified in larger classes. What is needed is for students and instructors to learn how to negotiate their expectations about when they should be able to have reliable, fast communicative responses.

Part of the communicative complexity of constructing adequately unambiguous conversations via text-based media comes from trying to anticipate the level of detail and phrasing that will be sufficiently helpful to others. But, as Hara and Kling noted, their informants were also unsure what meta-communicative conventions would be appropriate in their online conversations. e-mail that represents the nodded heads of a face-to-face group could be valuable to an instructor to confirm others’ understanding. Or it could result in yet more e-mail glut. These kinds of practices need to be negotiated within each group. In B3002 and many other courses, both face-to-face and online, participants do not explicitly question and negotiate meta-communicative conventions—even when they are confused and frustrated. These discussions and negotiations require a higher level of social skills from all participants, and their enactment (for instance, the creation of a strong social presence in a written medium) also requires time and expressive capabilities. This is not well explained in the literatures of e-learning or distance education.

Both authors taught online Ph.D. seminars for short-terms. The seminars were 2-week long. One author was contacted by a person at the university about teaching a 2-week online seminar during the fall semester. Since she had other teaching obligations during the regular semesters, she specifically asked to teach it over the summer, but was told that it was not possible. She was then contacted by a coordinator of the Ph.D. program to post some instructions for the students in their online space. Shortly after that, she was asked to contact a technical support person. While waiting to receive log-in information from technical support, she was frequently asked to log-in to the system by the coordinator. This instance indicated that the technical support person and the coordinator had not interacted with each other. When she was finally able to log-in to the system, more than 10 messages from the students were posted. One of the messages said that the students had been given an article in July and had been waiting for the seminar to start

since that time. Apparently there was miscoordination, miscommunication, and misunderstanding among the instructor, the students, the technical support person, the person who originally contacted the instructor, and the coordinator. The other author taught the same online seminar during the previous summer. He experienced other coordination issues with his students since they did not know what the expectations were with regard to a time frame for responding to messages. Therefore, it is important to note that distance education courses require substantial forethought about communications and coordination that are usually not problematic in face-to-face classes.

#### **4.2. Differing Social Organization of E-Forums Across Types and Within Types**

E-forums can be a component of Virtual Spaces. One way to facilitate e-forums is to consider five socio-technical issues.

1. E-forums organizers and participants need to determine who can participate and who is excluded. For example, the listserv among public defenders was restricted to defense attorneys. Thus, the attorneys felt comfortable brainstorming strategies for trials and asking questions about judges and prosecutors. If they were uncertain about who was reading the messages, they would not have freely discussed the above matters. Similarly, the bounded groups of the e-ILF facilitated discussion by restricting their membership.
2. The genres of acceptable communication need to be established in e-forums. Some Virtual Spaces make it more explicit than others. For example, a mailing list among educational researchers facilitated by American Educational Research Association periodically sent out messages that listed the rules for the mailing list, such as what and what not to send to the list. E-forums need to articulate what topics are appropriate for their e-forums.
3. Participants' activities (e.g., speak/post, read, role-play, buy, sell, etc.) need to be identified. For instance, eBay clarifies the roles of participants with their accounts. The users need to create separate accounts for sellers and buyers. Sellers' information is available in public for buyers to make decisions whether they want to buy items from particular sellers. Some e-forums have restricted speakers, yet other people are allowed to view their activities without participating in the discussions.
4. Acceptable communication conventions should be determined. This category concerns norms for online behaviors. Do you politely correct others or flame them? These questions need to be discussed. On the other hand, if participants are not certain about the expectations of the e-forums, the participation rate might be reduced. In the case of the ILF, the teachers did not have a clear understanding of what comprised acceptable communications within the e-forum. They were

not sure whether the video clips were supposed to be bad examples or good examples of teaching practice, or how much criticism would be acceptable in that type of e-forum. There were no discussions about this point among the participants, and it was not explicitly explained to them at the beginning.

5. Social control agents and practices need to be clarified. Some e-forums are established and enforced by e-forum organizers and some are by participants.

More often than not, designers of Virtual Spaces tend to overlook the fact that these socio-technical factors need to be in place. These five issues must be effectively addressed if an e-forum is to be successfully implemented. For example, e-ILF did not consider these issues. As such, there was little participation in the forum.

Hara's (2000) study of the listserv among public defenders identifies different types of working knowledge including book knowledge, practical knowledge, and cultural knowledge. Cultural knowledge is very difficult to share online. Consequently, we need to identify what kinds of knowledge to share and what types of tools to support such knowledge sharing.

Hara coined the term "cultural knowledge" in reference to the social nuances of the role public defenders play; it includes their professional identities as defenders of indigent people who often have been mistreated. Most of the tacit knowledge that is necessary to become a full member of the community of public defenders is embedded in the culture of the public defender's offices. Therefore, younger attorneys learn how to be public defenders by observing more experienced attorneys and by talking with them. As Huseman and Goodman state, "culture is one of the most powerful stores of knowledge" (Huseman & Goodman, 1999: 121).

In a community of practice, knowledge is constructed socially rather than individually. There are three types of knowledge that the members have to learn: cultural knowledge and two kinds of subject-matter knowledge.

Hara further classified subject-matter knowledge as either book knowledge or practical knowledge (see Hara, 2000). Book knowledge refers to mere facts, such as case laws and statutes. In contrast, practical knowledge refers to using the book knowledge in practice; for example, how to use the latest case that an attorney found in Lexis-Nexis<sup>5</sup> in a bench trial. The attorneys have learned most of their fundamental book knowledge in law school, but they also have to keep learning new book knowledge because criminal laws are rapidly changing. In addition, they have to learn how to use their book knowledge, which will eventually become practical knowledge. In some communities of practice, the subject-matter changes rapidly (e.g., communities of practice among lawyers) and sometimes cultures change rapidly, perhaps because of the high rate of turnovers.<sup>6</sup> Therefore, it is imperative

to address the learning of subject-matter knowledge in communities of practice.

Different types of knowledge require different learning formulas. Cultural knowledge and partial practical knowledge are tacit. Apparently, the mechanism of learning cultural knowledge and some practical knowledge relies on observing experts doing their work. On the other hand, parts of practical knowledge and book knowledge are explicit. Therefore, explicit practical knowledge and book knowledge can be shared through documents and electronic formats, such as messages exchanged through a listserv. As mentioned, not all kinds of knowledge are easy to share in online environments. The designers of Virtual Spaces ought to be aware of these limitations when providing learning opportunities in Virtual Spaces.

In our view, Virtual Spaces needs to be designed socio-technically (Kling, 2000). Designers may try technical means (such as IP-address checking or personally-reviewed registration) to limit participation to some kinds of people or groups. An e-forum's charter may describe the kinds of acceptable communications, but, without human review, it may be difficult to enforce. The e-forum may enable some specific kinds of activities while providing no explicit support for others. Also, the e-forum may be designed so that any group of participants may easily form their own (private) group, or they may require the assistance of an e-forum administrator, or it may be effectively impossible. It is easy to set up an online conferencing system on the internet for people to participate. However, the technology itself does not facilitate the process by which people share thoughts and ideas and build a community. There needs to be social support mechanisms embedded in the e-forum.

## 5. CONCLUSIONS

As noted earlier, knowledge management and professional development in virtual environments is much more difficult than in face-to-face settings. We suggest that the notion of knowledge management is too narrow to support knowledge creation and sharing activities in workplaces, and that incorporating the socio-technical perspective would enrich the online community and thus create a supportive learning environment. Knowledge management literature as well as e-learning and other technical focused fields are likely to focus too much on the technological issues. We strongly support the socio-technical perspective that considers social processes that would support the intended activities in addition to the technology itself. It is easy to develop a piece of software and name it Virtual Spaces, but it requires more effort and consideration to develop Virtual Spaces that *facilitate learning*. When IT fails to facilitate social processes, its effect on knowledge management is limited.

In the literature of knowledge management, knowledge management itself is often “black boxed”. A large portion of the literature does not address the workplace issues as experienced by potential participants, such as incentives for participating, trust that their communications will not hurt their status in their workplaces, the commitments of others to participate, and time to participate. As represented by the case of “Engineering Books of Knowledge” at Chrysler, knowledge management strategies or technologies are described, but these cases do not address the issues of the people who are involved in, and influenced by, the knowledge management initiatives. We certainly need to understand how the people on the floor use the technologies, what are the problems are that they face, what works, and what does not work. In the framework of Schultze and Leidner’s study (2002), we need more studies with local perspectives.

By understanding local perspectives, we can fully incorporate socio-technical considerations into design and implement virtual spaces that support professional development and knowledge sharing. The socio-technical aspects that we need to pay attention to include: identifying needs of users/learners; developing trust among users; installing incentive structures for knowledge sharing; and determining users, their communication topics, norms, and behaviors. It is important to recognize that virtual spaces are more than an IT system allowing communication and data exchange.

As a field that is focused on technologies, it is easy to jump on the bandwagon of newly fashionable technology-based techniques, such as e-learning or knowledge management. Professionals who organize professional development through virtual spaces need to remember that the technology does not make learning better, but rather it is that the pedagogy and social processes that facilitate better learning. If this is not the case, many IT applications for virtual learning environments will end up going through a cycle of high expectations followed by relatively uneven and low participation rates; and these in turn will be followed by disillusion and disappointment.

#### ACKNOWLEDGMENTS

We thank the editors, Joel Weiss, Jason Nolan, and Peter Trifonas, for their careful reviews and insightful feedback. In addition, Zilia Estrada and Phil Eskew provided helpful comments.

#### ENDNOTES

1. This definition is based on the Wenger’s elements of communities of practice (CoPs): negotiating meaning between participants; preserving and creating knowledge; and supporting the development of identities (Wenger, 1998).

2. The best research that we have found about trust building for on-line groups has been conducted by Information Systems faculty who study teamwork online (c.f., Jarvenpaa & Leidner, 1998).
3. All of the names in this case description are aliases.
4. Hara (2000) studied four different communities of practice: one in a small office, one among experienced attorneys in a larger office, one among less experienced attorneys in the larger office, and one in online.
5. Lexis-Nexis is a database that provides full-text access to a variety of topics. In this case, attorneys use it to search information about state law.
6. The original definition of a community of practice by Lave and Wenger (1991) appeared to be concerned about only static cultural knowledge and subject-matter knowledge. However, many jobs require the learning of subject matter that frequently changes.

#### REFERENCES

- Abrahamson, E. (1996). Management fashion. *Academy of Management Review* 21, 254–285.
- Aepfel, T. (2002, July 1). Tricks of the trade: on factory floors, top workers hide secrets to success. *The Wall Street Journal*, p. A1.
- Ahern, T. C. & Repman, J. (1994). The effects of technology on online education. *Journal of Research on Computing in Education* 26(4), 537–546.
- Anderson, T. & Kanuka, H. (1997). On-line forums: new platforms for professional development and group collaboration. *Journal of Computer-Mediated Communication* 3(3). Retrieved August 20, 2003, from <http://www.ascusc.org/jcmc/vol3/issue3/anderson.html>.
- Barab, S., Moore, J., Cunningham, D., & the ILF Design Team (2000). *The Internet Learning Forum: A New Model for Online Professional Development* (presented at the Annual Meeting of the American Educational Research Association, New Orleans, LA). Bloomington, IN: Indiana University.
- Berge, Z. (1997). Computer conferencing and the on-line classroom. *International Journal of Educational Telecommunications* 3(1), 3–21.
- Bonk, C. J. & Cummings, J. A. (1998). A dozen recommendations for placing the student at the center of Web-based instruction. *Educational Media International* 35(2), 82–89.
- Burge, E. J. (1994). Learning in computer conferenced contexts: the learners' perspective. *Journal of Distance Education* 9(1), 19–43.
- Cusumano, M. A. & Selby, R. W. (1995). *Microsoft Secrets: How the World's Most Powerful Software Company Creates Technology, Shapes Markets, and Manages People*. New York: The Free Press.
- Davenport, T. (1997). Knowledge Management Case Study: Knowledge Management at Ernst & Young. Retrieved December 14, 2002, from <http://www.bus.utexas.edu/kman/E&Y.htm>.
- Davenport, T. H. & Prusak, L. (1998). *Working Knowledge*. Cambridge, MA: Harvard Business School Press.
- Davis, S. & Botkin, J. (1994). *The Monster Under the Bed: How Business is Mastering the Opportunity of Knowledge for Profit*. New York: Simon & Schuster.
- DiMauro, V. & Gal, S. (1994). The use of telecommunications for reflective discourse of science teacher leaders. *Journal of Science Education and Technology* 3(2). Retrieved January 28, 2003 from <http://www.terc.edu/papers/labnet/Articles/Reflective/reflective.html>.

- Ellis, N. E. (1993). Collegiality from the teacher's perspective: Social contexts for professional development. *Action in Teacher Education* 15(1), 42–48.
- Feenberg, A. (1993). Building a global network: the WBSI experience. In: Harasim, L. (Ed.) *Global Networks*. Cambridge, MA: MIT Press.
- Gierkink, T. & Ruggles, R. (2002). Leveraging Knowledge for Business Value: Creating Living Knowledge Representations through the Power of Communities. Retrieved, December 14, 2002, from <http://www.cbi.cgey.com/pub/docs/LeveragingKnowledge>. PDF.
- Hara, N. (2000). Social construction of knowledge in professional communities of practice: Tales in courtrooms. Unpublished Doctoral Dissertation, Indiana University, Bloomington, IN.
- Hara, N., Bonk, C. J., & Angeli, C. (2000). Content analysis of an on-line discussion in an applied educational psychology course. *Instructional Science* 28, 115–152.
- Hara, N. & Kling, R. (2000). Students' distress with a web-based distance education course. *Information, Communication and Society* 3(4), 557–579. Retrieved December 14, 2002, from <http://www.slis.indiana.edu/CSI/Wp/wp00-01B.html>
- Harasim, L. M. (1990). Online education: an environment for collaboration and intellectual amplification. In: Harasim, L. M. (Ed.) *Online Education: Perspectives on a New Environment*. New York, NY: Praeger, 39–64.
- Hiltz, S. R. (1998). *Teaching in a Virtual Classroom. Vol. 2: A Virtual Classroom on EIES: Final Evaluation Report*. Newark, NJ: New Jersey Institute of Technology.
- Howell, D. & Stinson, B. (2001). Blending online strategies into traditional staff development training. *Distance Learning 2001: Proceedings of the 17th Annual Conference on Distance Teaching and Learning*. Madison: University of Wisconsin.
- Huseman, R. C. & Goodman, J. P. (1999). *Leading with Knowledge: The Nature of Competition in the 21st Century*. Thousand Oaks, CA: Sage.
- Jarvenpaa, S. L. & Leidner, D. E. (1998). Communication and trust in global virtual teams. *Journal of Computer-Mediated Communication* 3(4). Retrieved July 11, 2001, from the World Wide Web: <http://www.ascusc.org/jcmc/vol3/issue4/jarvenpaa.html>.
- Jarvenpaa, S. L. & Liedner, D. E. (1999). Communication and trust in global virtual teams. *Organization Science* 10(6), 791–815.
- Kang, I. (1988). The use of computer-mediated communication: electronic collaboration and interactivity. In: Bonk, C. J. and King, K. (Eds.) *Electronic Collaborators: Learner-Centered Technologies for Literacy, Apprenticeship, and Discourse*. Mahwah, NJ: Erlbaum, 315–337.
- Kirkpatrick, D. (1993). Groupware goes boom: effects of groupware software packages on corporations. *Fortune* 128(16), 99–103. (Reprinted in Kling, 1996.)
- Kling, R. (1994). Reading “all about” computerization: how genre conventions shape nonfiction social analysis. *The Information Society* 10(3) (Jul–Sep), 147–172.
- Kling, R. (2000). Learning about information technologies and social change: the contribution of social informatics. *The Information Society* 16(3), 217–232.
- Kling, R. & Courtright, C. (2004). Group behavior and learning in electronic forums: a socio-technical approach. In: Barab, S. A., Kling, R., and Gray, J. H. (Eds.) *Designing for Virtual Communities in the Service of Learning*. Cambridge: Cambridge University Press, 91–119.
- Kling, R. & Hara, N. (2004). Informatics and distributed learning. In: DiStefano, A., Rudestam, K., Silverman, R., and Taira, S. (Eds.) *Encyclopedia of Distributed Learning* (pp. 225–227). Thousand Oaks, CA: Sage Publications.
- Lambe, P. (2002). *Fashion, Magic, and Knowledge Management*. Retrieved December 14, 2002, from <http://greenchameleon.com/thoughtpieces/fashionkm.pdf>.
- Lave, J. & Wenger, E. (1991). *Situated Learning: Legitimate Peripheral Participation*. Cambridge: Cambridge University Press.

- Little, J. W. (1982). Norms of collegiality and experimentation: workplace conditions of school success. *American Educational Research Journal* 19, 325–340.
- Little, J. W. (1985). Teachers as teacher advisors: the delicacy of collegial leadership. *Educational Leadership* (November), 43(3), 34–36.
- Little, J. W. (1990). The persistence of privacy: autonomy and initiative in teachers' professional relations. *Teachers College Record* 91(4), 509–536.
- Markus, M. L. & Benjamin, R. (1997). The magic bullet theory in IT-enabled transformation. *Sloan Management Review* 38(2), 55–68.
- McIsaac, M. S. & Gunawardena, C. N. (1996). Distance education. In: Johnassen, D. (Ed.) *Handbook of Research for Educational Communications and Technology*. New York, NY: Macmillan, 403–437.
- Orlikowski, W. J. (1993). Learning from notes: organizational issues in groupware implementation. *The Information Society* 9(3), 237–250. (Reprinted in Kling, 1996.)
- Pickering, J. M. & King, J. L. (1995). Hardwiring weak ties: interorganizational computer-mediated communication, occupational communities, and organizational change. *Organization Science* 6(4), 479–486.
- Rossmann, M. H. (1999). Successful online teaching using an asynchronous learner discussion forum. *Journal of Asynchronous Learning Networks* 3(2). Retrieved December 14, 2002, from <http://www.aln.org/alnweb/journal/jaln-vol3issue2.htm>.
- Ruopp, R., Gal, S., Drayton, B., and Pfister, M. (1993). *LabNet: Toward a Community of Practice*. Hillsdale, NJ: Erlbaum.
- Schlager, M., Fusco, J., & Schank, P. (1998). Cornerstones for an on-line community of education professionals. *IEEE Technology and Society* 17(4), 15–21.
- Schultze, U. & Leidner, D. E. (2002). Studying knowledge management in information systems research: discourses and theoretical assumptions. *MIS Quarterly* 26(3), 213–242.
- Sherry, L. (2000). The nature and purpose of online conversations: a brief synthesis of current research. *International Journal of Educational Telecommunications* 6(1), 19–52.
- Spitzer, W. & Wedding, K. (1995). LabNet: an intentional electronic community for professional development. *Computers and Education* 24(3), 247–255.
- Turoff, M. (1991). Computer mediated communication requirements for group support. *Journal of Organizational Computing* 1, 85–113.
- Wegerif, R. (1998). The social dimension of asynchronous learning networks. *Journal of Asynchronous Learning Networks* 2(1). Retrieved December 14, 2002, from [http://www.aln.org/alnweb/journal/vol2\\_issue1/wegerif.htm](http://www.aln.org/alnweb/journal/vol2_issue1/wegerif.htm).
- Wenger, E. (1998). *Communities of Practice: Learning, Meaning, and Identity*. Cambridge: Cambridge University Press.
- Wiesenberg, F. & Hutton, S. (1995). Teaching a graduate program using computer mediated conferencing software. Paper Presented at the *Annual Meeting of the American Association for Adult and Continuing Education*, Kansas City, MU, November.



# **Part III**

## **Out-Of-School Virtual Learning Environments**

## Chapter 32: Cemeteries, Oak Trees, and Black and White Cows: Newcomers' Understandings of the Networked World

VICKI L. O'DAY\*, MIZUKO ITO<sup>†</sup>, ANNETTE ADLER<sup>‡</sup>,  
CHARLOTTE LINDE<sup>§</sup>, AND ELIZABETH D. MYNATT\*\*

*\*Department of Anthropology, University of California, Santa Cruz; <sup>†</sup>Annenberg Center for Communication, University of Southern California; <sup>‡</sup>Agilent Laboratories; <sup>§</sup>NASA Ames Research Center; \*\*College of Computing, Georgia Institute of Technology*

### 1. INTRODUCTION

The internet, in its proliferating forms, continues to attract an increasingly diverse set of users. Since the explosion of the World Wide Web and the broadening of internet access in the mid-1990s, the internet is no longer dominated by Euro-American software developers, academics, and government agencies. It is currently estimated that 10% of the world's population is online—an astonishing figure that includes a large proportion of youth in many countries, as well as many seniors like those in our study (Cyberatlas, 2003). Over half of the Internet's users are from non-English-speaking countries (*Global internet statistics by language*, 2003). And of course, most of today's users of the internet are not professionals or students in computer science and related fields, as was the case in the early years of networked computing.

Diversification of populations with internet access will continue, as will the influx of internet newcomers spanning a wide social and cultural range. When newcomers make their first online forays, they are confronted with a strange and often incomprehensible “networked world”, a social, technical, and cultural system built up through an idiosyncratic history and shaped by the unique perspectives and backgrounds of early participants. While the technical and social features of the internet are in perpetual flux, many of the deeply embedded technical and cultural assumptions that have been part of the internet since its inception continue to shape user experience. For example, the ASCII encoding of text makes it easy to exchange e-mail or documents in European languages, but it is a real ordeal to do the same thing in Japanese, since ASCII is not large enough to encompass the Japanese character set (Nolan, 2005). Similarly, Lessig (1999) points out that the early design decision to make networking protocols decentralized (so the network itself would be more resistant to total failure) also makes it difficult for corporate interests to police network traffic, as we have seen in recent music industry cases. In numerous instances, the technological choices and assumptions of the early internet are associated with cultural biases of one kind or another. Manuel Castells (2001) argues

that the internet continues to be characterized by a youth-identified technoutopianism, even after the addition of corporate interests, entrepreneurs, and communitarians to the ranks of internet architects.

We are interested in how newcomers meet the internet under these conditions. In particular, what do newcomers need to learn about the social and technical features of the networked world if they want to become fluent participants? How do their experiences with other communication and information technologies (such as telephones and postal mail) help or hinder them as they learn how to navigate their way through online activities and services? In this paper, we explore these issues, drawing on data from an ethnographic study of SeniorNet, an organization that supports senior citizens in gaining access to computing.

Our analytical approach is centered on a close examination of the questions seniors asked in computing courses as they learned about the networked world. The seniors in these courses were situated largely outside the frame of reference of “locals” of the networked world—those people (such as their teachers) who had acquired enough online experience to feel comfortable and knowledgeable about the way things work on the internet. When the seniors asked questions from their outsider’s perspective, they shed light on what an insider’s perspective looks like. Because newcomers do not take things for granted, they are in a privileged position to make visible the implicit assumptions that organize a culture or community, which are no longer apparent to long-time participants. We argue that looking closely at newcomers’ questions can help developers of internet software and services to reflect on their own assumptions, which may help them to design networked applications that are more readily understandable to new users.

This study was conducted in 1998, before the years of inflated internet hype that accompanied the dotcom bubble and the mainstreaming of the internet user base in the United States. Yet we believe that our findings regarding the experiences of new internet users still apply. The goal of this chapter is to unpack some of the underlying cultural assumptions that organize the networked world. These assumptions are keyed to the context of 1998, but they continue to be relevant as the internet extends its reach.

Several prior studies have investigated what newcomers to the networked world do when they first gain online access (e.g., Bier et al., 1996; Kraut et al., 1996; 1998). In each of these studies, researchers provided families with home computers and network access to investigate the use and the impact of home-based access to online services. These studies demonstrate how newcomers from a variety of backgrounds make use of the networked world when they get there, but the studies do not focus on the processes through which people make sense of these new experiences. In contrast to the HomeNet research that analyzes internet usage patterns in terms of demographic, psychological, and temporal variables, we describe the cultural contexts of internet use through qualitative observations of literacy, learning, and community practices.

### 1.1. Cultural Contact or Notes on Ethnographic Method

Our analysis mobilizes a metaphor of cultural contact based in anthropological theory and method. While touted as a universalizing medium, the internet is actually formed through a set of metaphors (Stefik, 1996), political commitments (Lovink, 2002), and governance structures (Lessig, 1999) that results in a particular set of “information ecologies” (Nardi & O’Day, 1999). Despite the diversity of these ecologies, life mediated by the internet is grounded in a common (though differentiated) *system* of meaning, or what anthropologists would call culture in the most foundational sense (Schneider, 1968). It is the technical architecture of the internet that comprises much of this taken-for-granted system of meaning for the online world. This system of meaning comes to feel “natural”, much as we accept certain notions of gender and procreation as “natural” despite the considerable cultural work that brought us these notions in the first place (Yanagisako & Delaney, 1995).

From a newcomer’s perspective, the internet seems at first to be a hodge-podge of sites, applications, and services, within which it is not easy to tell the difference between the deeply embedded and more transient or superficial characteristics. Old-timers make sense of the internet as a *cultural system*, albeit an evolving one, rather than seeing it as a set of discrete features and components. Experienced internet participants recognize that certain capabilities and conventions are more stable and widespread than others. Their fluency is based on their adaptation to the taken-for-granted architectures that ground internet experience.

One instructor of an online class we observed encouraged his students to focus their attention on the more durable features of the internet by drawing a distinction between cemeteries and oak trees and black and white cows. He pointed out that in early days of automobile driving, road maps were not readily available to guide travelers to their destinations. Instead, there were guidebooks that used local landmarks as reference points. The guidebooks, he said, were careful to use relatively persistent landmarks, rather than mobile ones. For example, a guidebook might advise a driver to turn left at a cemetery or right at an old oak tree, but it probably would not include a reference to a herd of black and white cows. In any landscape, it is more useful to navigate by some features than others. The instructor urged students to look for landmarks that are both stable and pervasive across the networked world. “If you focus on what button to push,” he told them, “you’ll be focusing on the black and white cows.” He pointed out that the topic of privacy, by contrast, is a cemetery and oak tree that will always be important to internet users, even though the details of addressing privacy will change over time.

It is the challenging task of internet newcomers to discern which features of the online landscape and culture are currently considered long-lived and meaningful to the “locals” of the networked world—those who have absorbed certain local traditions and beliefs and know how to bring them to bear on

current practice. In this process, the newcomers are like anthropologists who go out to live in a culture they do not yet understand, asking questions that will help them see how the locals view the world in their particular time and place. To achieve true fluency, they must not only master the tools of the realm such as language and ritual, but also begin to understand the worldview that lies behind the particular utterances and actions of the natives. To make the newcomers' task more complicated, they cannot simply ask the natives to tell them everything they need to know, since the natives usually have forgotten what did and did not make sense when they were newcomers themselves.

An example from a more classic anthropological encounter may bring this dynamic to life. Within anthropology, there has been a controversy as to whether or not certain Pacific islanders recognized the role of coitus in procreation (Delaney, 1986; Leach, 1966–1967; Schneider, 1968). Islanders reported their belief that conception was arranged by the husband's ancestral ghosts, and that coitus was not relevant. As he ponders this debate, David Schneider, in his fieldwork among the Yap, discovers some men removing the testicles from a pig. In the ensuing conversation, he determines that the men recognize that both the testicles and the copulation are necessary for a sow to get pregnant. Why is it, then, that everyone has been telling him that coitus does not make women pregnant? It is the Islanders turn to be confused, until one man finally sees what the anthropologist's problem is: "But people are not pigs!" Schneider writes: "Once that point was made, the rest followed in happy, logical order. I had obviously assumed that biological processes operate for all animals and had included man among them. But they had assumed that no one but a fool would equate people and pigs." (Schneider, 1968)

Like Schneider, students in the classes we observed asked questions to discover local understandings, motivated by their own curiosity and practical objectives. They persisted in their inquiry, although sometimes the categories and distinctions seemed unfamiliar and peculiar. In the process, they questioned the logic of computing systems. The questions have the effect of "denaturalizing" (Yanagisako & Delaney, 1995) our understandings, by refusing to take as given the deeply held structures and beliefs of the networked world. And like Schneider's focus on a "fact" of procreation, student questions will often begin with a seemingly simple particularity, which, when unpacked, reveals striking dimensions of an entire cosmology. Our analysis, in this chapter, is to describe how these apparent confusions about "simple facts" point to naturalized, systemic assumptions that are both obvious and invisible to locals.

We emphasize that the questions the students asked were reasonable and informed, not naive. No one comes to computing as a blank slate. The seniors we met in our study were mature people who had valuable experience with a variety of technologies at work and at home. Sometimes their experience with earlier technologies such as telephones and paper-based mail systems helped them in understanding the internet, and sometimes it provided interference instead. The students' questions illuminate the networked world as it appears

to many new internet users (in schools, libraries, senior centers, and homes), and they provide us with material to reflect critically on the design of current computing systems.

### 1.2. The Internet as a Site of Cultural Change

Although we focus in this chapter on long-lived technological and cultural frameworks that shape user experience on the internet, we do not mean to suggest that the internet is standing still, even for the purpose of our analysis. The distributed technologies that comprise the internet are always in a state of transition, as are network-based business models and legal codes. New technical and social models for the networked world such as web logs (blogs) and the mobile internet have a profound impact on how the internet is perceived and used. Clearly, notions of stability and systematicity must be understood as relative terms when referring to features of the internet.

Rapid change and heterogeneous standards are part of what newcomers have to learn about the internet—they are cemeteries and oak trees. Ongoing learning, therefore, is a necessity for internet users, since even internet old-timers continue to encounter the new and unfamiliar in their online experiences. Because of the pace of change, each successive generation of newcomers is situated in a reconfigured learning context. Even if old-timers could remember each “aha” moment when they elucidated some key ontological distinction in the networked world, their recollections might not translate into useful tips for today’s newcomers. While many nuts-and-bolts characteristics of the internet persist over time, the contextual details that color a new user’s experience tend to change in ways that render the experience opaque to the next generation.

We argue that the moment of cultural contact with the internet is important and interesting. It is also brief, since motivated newcomers quickly begin to adapt to local ways—the category of “newcomer” is a stage everyone goes through, rather than a permanent identity. Our analysis focuses on the details of newcomers’ encounters with the networked world, in order to see more clearly the tacit, embedded models that structure experience for all internet users.

## 2. THE SENIORNET PROJECT

The SeniorNet organization was founded in 1986 to help seniors gain access to computing technology (*About Seniornet*, 2003). SeniorNet supports robust network communities on the web and on America On-Line (AOL), and it sponsors over 200 volunteer-staffed “Learning Centers” throughout the United States, where seniors can take computer classes on a variety of subjects,

including how to buy a computer, how to use financial software, and how to get online. At the time of our research, there were about 25,000 members; SeniorNet now has grown to 32,000. Most SeniorNet members (about three-quarters) are retired, but about a quarter of the members work at least part time. There are more women (58%) than men (42%) in SeniorNet. The age span of SeniorNet members is very broad; anyone who is at least 50 is eligible to join. About half of the members are between 65 and 75. Another 27% are between 75 and 85, and 20% are between 55 and 65. Small percentages of members are in their late 80s and early 90s, and an even smaller percentage in their early 50s. Among the individual members we met during our research, we found that a surprising number were writers or teachers.

In 1998, we engaged in a year-long ethnographic study of SeniorNet. We are interested in the issue of broad access to computing. We chose to study SeniorNet as a case of long-lived, successful computer access among a population that is not commonly thought to be adept at learning new technologies (though the SeniorNet members belie this stereotype). The themes of our research center on understanding the social and technical features that support access and help people become fluent in online participation.

SeniorNet is a distributed enterprise, with activity in different online and physical locations. We carried out observations and interviews in a variety of sites, to develop a better sense of SeniorNet's membership and practices than any single location could provide. We interviewed SeniorNet staff members, observed three multiweek computing classes (each of which took place at a different Learning Center), observed online activity in discussion forums (newsgroups) both on the Web and AOL over a period of months, participated in chat regularly on the web for a week, interviewed 30 members drawn from both network communities, interviewed nine students from two of the classes we had observed (several months after their classes had ended), and interviewed one student weekly, after each of her class sessions. We also posted questions and research themes on an online forum created for us by the SeniorNet staff, to generate discussion among members on topics of interest to the project.

We have research findings in several areas, including access issues, network communities, online fieldwork practices, and learning to become an online participant. In this paper, we focus on the last area: understanding what is involved in learning to use the internet.

### **2.1. Learning Center Observations**

During our study, we observed three classes, each of which took place at a different Learning Center. Two of the classes were introductions to computing. One of the introductory classes took place over 4 weeks and one over 5 weeks; in each of these classes, the weekly class meetings were 2 hours long. One

class was an introduction to online access, consisting of 82-hour sessions. All of the classes were taught by SeniorNet volunteers. Each of the Learning Centers we visited was situated within a senior center, where many activities and classes of all kinds were available to seniors.

The Learning Center classes we observed were “hands-on”. Students were assigned to work in pairs on the classroom computers, and they practiced what they learned both in class and at home, if they already owned their own computers. Each of the students taking the 8-week online class already owned a home computer and had home access to the internet through AOL. There were 27 students altogether in the three classes we observed.

To complement the face-to-face class observations, we observed the Newcomers’ Forum, an online discussion group in the SeniorNet network community on AOL, for a period of 1 month. We were interested in learning how the questions posted by people who were already online contrasted with the questions asked by people in Learning Center classes. They turned out to be similar to (and in some cases duplicates of) the classroom questions, so we folded them into our analysis.

### 3. ANALYTICAL APPROACH

As we observed Learning Center classes, we were struck by the multiple literacies required for online access and by the interesting nature of the students’ questions in class. The questions often struck us as being a bit “sideways” to our own way of looking at the networked world. To understand the students’ perspectives better, we collected all of their questions from our fieldnotes of the four classes we observed and added to this collection the questions from the Newcomers’ Forum discussion group. Here are some examples that illustrate the breadth of topics covered:

*If the file was saved, why is it still on the screen?*  
*Does the person who sent you mail know whether you’ve opened it?*  
*When are you supposed to double click?*

The questions covered six topical areas: (1) hardware (computer, mouse, modem, memory, printer, keyboard); (2) Graphical user interface conventions and capabilities (dialog boxes, highlighting, scrolling, windows); (3) specific application features (changing margins or fonts, cc’ing someone on a mail message); (4) social conventions (courtesy, privacy, censorship); (5) computer ownership (upgrades, phone lines, internet service providers, costs, technical support); and (6) networked world (the web, e-mail, downloading). We chose to do a close examination of the questions about the networked world (about 30 of the 125 questions), because they cover new territory that has not been addressed in studies of individual applications or systems.



The students' questions often pointed to areas of complexity or ambiguity, where meanings are unclear and unresolved even to the locals. Usually the questions could be answered with procedural or ontological information—each question was a basis for learning a few more cemeteries and oak trees. But seen in another light, the students' questions point to the technological and cultural frameworks that help us understand how the internet operates. Many of the questions also highlight areas where these frameworks are currently under stress, due to the changing technologies and populations of the internet. As the authors of this paper discussed the questions, we groped for the “right” answers to them. Our answers often felt arbitrary in the technical particulars, but they reflected the broader social and cultural context that organizes the networked world.

We found that the networked world questions clustered into four themes:

- Identity and the nature of public participation on the internet;
- Boundaries and scope of the internet;
- Boundaries and scope of a personal computer; and
- Organizing the networked world and understanding the roles of different providers.

We discuss each theme in the sections below through some of the student questions that fit into that theme. As we examine each student question, we try to elucidate its internal logic. We reflect on the inferences students are making as they attempt to link the workings of the internet to other technologies they already understand, and we point to the gaps that are revealed when students' inferences do not hold up. We draw attention to the differences between newcomers' and locals' perspectives, to make visible some of the idiosyncratic features and frameworks of the networked world.

Our analysis in this chapter specifically does not revolve around the notion of the “digital divide”, which refers to the demographics associated with whether or not people have access to the internet (NTIA, 2000). Internet participation figures vary from country to country, but it is typical to find that there are more youths than seniors and more middle class than poor people online. Discussions about the digital divide are concerned with how to provide access for groups who currently have insufficient access. Our study focuses on seniors, and seniors are one of these underserved groups; in some of our other work, we look at how age-based identity relates to seniors' online participation in SeniorNet (Ito et al., 2001). However, in our analysis here we do not attribute differences in understanding between newcomers and old-timers (on the internet) to demographic constructs such as gender, nationality, or age. Rather, we argue that it is membership—or not—in the culture of the networked world that differentiates people's understanding of what happens there. Membership does not imply that experienced participants know everything about how the internet works; it just implies that they know enough (and

continue to learn enough) to get along in the regions of the networked world they have chosen to occupy.

#### 4. IDENTITY ON THE INTERNET

People who enter the networked world begin to formulate an identity there, just as they do in other settings where social exchanges take place. Using the internet has something in common with other communication media, such as postal mail, telephones, broadcast television, and cable television. Each of these media has its own conventions for establishing who its subscribers are (names, addresses, and other information), and the internet is different from all of them.

Student questions about identity revolve around the idea that an internet identity is persistent and public, and it is constructed in part through the actions you take online.

##### 4.1. Persistent Identity

*How is it that you can get e-mail even when you're not logged into AOL?*

At first glance, your new computer looks like a telephone. Using your modem, you dial your internet provider. While you're connected, you can interact over the network. It would be reasonable for a newcomer to assume that this active connection gives you a presence on the internet, similar to being present in a telephone call, but using the computer rather than a telephone as a portal. When the portal is not in use, it simply waits to be connected again.

But on the internet, you can receive e-mail even when you are not actively connected. To complicate the picture, if you are an AOL subscriber, you can download your e-mail to your own computer and read it offline, and the students had practiced this activity in class. The student who asked this question was querying the relationship between her mailbox and AOL. In more general terms, this question asks: Where does e-mail live, and what is my role in managing its arrival? The student's confusion results from an assumption that e-mail works in a fashion similar to the telephone. While you are connected (phone is plugged in), you are putting a bucket out waiting for e-mail to be delivered. But if there is no connection, there is no bucket. Both sender and receiver (or an answering machine as a substitute for the receiver) have to be present for the delivery to happen.

However, the locals' assumption is that your identity is different from either your active connection or your computer. AOL holds your identity for you, in the form of an e-mail address. This identity is persistent, independent of your connection. Identity is more than a name on a roster—it can be used to carry

out a limited interaction with you even when you are not present. In this case, it can be used to deliver e-mail to you.

#### 4.2. Public Identity

*I am getting junk mail on AOL. How did they get my name?  
Does the person who sent you mail know whether you've opened it? Can  
it make junk mail worse to read it?*

A more general version of the first junk mail question is: How is my identity made known to others in the networked world? Implicit in the student's question is the idea that e-mail works like postal mail—your own correspondents know your address (and they might sell it to other people), but in general, your identity is not made known to others simply because you are an inhabitant of a particular place.

In contrast, the prevailing notion on the internet is that participating in the internet is a public act and gives you a public identity. It is extremely difficult to have an unlisted number on the internet. It is also easier to send e-mail to a thousand people than to place phone calls to that same thousand people.

Although there is growing concern about privacy on the internet, the technology making up the internet has been instrumental in overriding many of the privacy assumptions people carry over from physical mail or telephone use. Corresponding legal and social protections are not yet available in the online world, although the proliferation of spam traffic is prompting more public discussion and proposals for legal solutions.

The second junk mail question points to another interesting characteristic of life in the networked world. This is an advanced question—the student knows it is possible that her actions may be known to others, though she is not sure about the particular action of reading mail. She is looking for strategies to ensure a certain level of privacy—she wants to reduce, or at least not increase, the amount of junk e-mail she is receiving. Some communication media (such as the telephone) do tell the sender when the receiver is listening, while others (such as physical mail) do not. Since the time of our SeniorNet research, the increasing use of e-mail attachments with active content (and sometimes viruses) has made this an even more pressing concern.

Locals understand that the identity of a net participant is persistent and public, but it is not static. As you perform actions on the internet (such as shopping, reading the news, or making travel arrangements), information about your activities can be broadcast to an unknown audience. Understanding the limits of your privacy and knowing strategies to ensure your privacy are complex, unending issues for residents of the internet.

The fact of persistent and public internet identity points to a general cultural value placed on maximizing connectivity and accessibility. Although this value is being challenged by the commercial internet, it has persisted from the early days of the internet, when uses were largely non-profit, professional, and confined to a comparatively small, homogeneous, and self-governing community.

## 5. BOUNDARIES AND SCOPE OF THE INTERNET

When you visit a famous geographical site, such as a national park or an important historical landmark, you can usually tell when you get there. You read signs that mark the approach to the site, you cross a border or threshold to enter, and you look around and recognize significant features when you are there. The internet is different. The internet is a desirable destination, but it is not easy for newcomers to the internet to know when they have arrived.

Some of the most persistent and searching questions students asked throughout their courses were those that explored the boundaries and scope of the internet. Where does it begin and end? What does it mean to be on the internet? What does the internet consist of? People are drawn to the internet because they are supposed to be able to encounter novel and useful experiences and resources, but there are few clear markers that tell people where and what the internet is.

### 5.1. Crossing Over to the Internet

An instructor noted that you need a certain modem speed to “surf the web.” A student asked, “*What about the Internet?*”

In a message on the Newcomers Forum, an SN member said that he *just knew how to do e-mail and was now “trying to get web or internet.”*

The general question here is, “Are we there yet?” People expect there to be a there when they reach the internet, but which are the features that tell people where they are? More familiar consumer technologies correspond to some kind of physical gadget—consider telephones, televisions, and cellular phones. There are invisible signals traveling around to support these technologies, but there is also something tangible to hold onto. The internet does not have the same kind of physical presence, so its nature is more mysterious. Web pages are referenced on billboards, radio, and product labels, but the relationship between the web and the internet is fuzzy. It is easy to see why some newcomers assume that the internet is the same as web content, since at least that is something you can point to.

For locals, the internet is space of possibilities for encountering different forms of information and communication. Although interesting material is part of the internet, the internet is primarily defined by connectivity to a broad set of activities and audiences. The different genres of communication (e-mail, the web, instant messaging, music exchanges, newsgroups) are recognizable as distinct locales, but they are also bound together by being part of the internet as a whole—these different genres both define and are defined by their association with the internet as a new territory.

#### *5.1.1. Geography, Boundaries, and the Net*

*Is the whole country in this particular chat room?*

*If you want to send mail outside the country, do you have to use http?*

A tangled set of metaphors is commonly used to describe the internet. Sometimes it is a highway, sometimes a library, sometimes a hotline. Often it appears to be some kind of place, as when we talk about visiting a web site or getting into a chat room. How far does this geographic metaphor extend? Both of the student questions above suggest that physical geography goes beyond metaphor, and that physical regions are salient in the networked world. The locals in the technology community would probably agree, though there are differences in the ways newcomers and old-timers bring physical geography into the picture.

The question of whether the “whole country” is in this chat room implies that geography is relevant and that geographic places correspond to virtual spaces. It is a question about scope—who can be here in this chat room, and what are its limits? An implicit assumption in this question is that the relevant limits are spatial.

For the locals in the networked world, the most important limit on participation in chat rooms, multiplayer online games, and other synchronous activities is temporal, not spatial. In a chat room, you can only be together with other people if you are there at the same time. Geography provides relevant information, but need not be a significant boundary on the internet.

The student question about how to send mail outside the country implies that similar assumptions are at work. This question suggests that geography is a significant boundary for addressing e-mail messages. But for locals, the Internet’s reach is independent of physical distance; it is just as complicated (or simple) to address a message to someone in a nearby town as to a nearby country. Some e-mail addresses do explicitly refer to geographic entities, especially outside the United States, but this form of addressing is a particular feature, not a generally organizing one. This question exposes a seam where geographic regions and the networked world are explicitly related, though geographic borders are not among the cemeteries and oak trees for locals.

Locals understand the internet through space-based metaphors, but the space and its boundaries are organized by activity and connectivity, rather than physical geography.

Boundaries in the networked world have implications for particular audiences, or who can take part in which networked activities. It is clear from recent technological and legal developments that the locals' sense of audience is subject to renegotiation. Web catalogs (such as those provided by Yahoo and AOL) are useful because they create new localities on top of the Web's chaos, using familiar signposts. (Often these new localities are branded; there is strong competition for capturing users' attention on the web, and meta-sites are one avenue for doing this.) web crawlers and search engines also can radically alter the sense of locality for newsgroups and web sites. We saw an example of this when ancient Usenet news postings became easily searchable on the web; Usenet postings that had disappeared many years ago from their newsgroups acquired new life and visibility when archived versions were made available on the Dejanews web site (and subsequently on Google). The locality of newsgroups can also shift for other reasons, as when a Silicon Valley company's internal newsgroups were subpoenaed by a competitor in a court case. Boundaries on the internet are subject to technological, legal, and social drift.

There are important boundary crossings in the internet, but few of them are marked in ways newcomers can see. They are social and functional boundaries for the most part, rather than physical ones. Native fluency in the networked world involves managing one's own presence, as well as awareness of the presence of others, in an expanding range of synchronous and asynchronous communication possibilities.

## 6. BOUNDARIES AND SCOPE OF A PERSONAL COMPUTER

The third theme is complementary to the previous one. Just as people work to understand the boundaries and scope of the internet, they also work to understand the boundaries and scope of their own personal computers. Where does my computer end and the network begin, and when does it matter? What makes one personal computer different from another and what are the implications of these differences? In the questions related to this theme, we can see that students are trying to understand the nature of the personal computer. Sometimes a computer is regarded mainly as an entry point for the internet, such as in public libraries or internet cafes. But a personal computer typically is also a site for storing private information and doing personal tasks, like managing finances and creating photo albums. To complicate the situation for newcomers, many tasks (such as paying bills or filing taxes) that people used to handle by installing software on their own computers now can be managed by web-based applications. But even though the boundaries between personal

computing and networked computing are shifting, it is still important for newcomers to understand (at least to some extent) what is happening where.

### 6.1. Locality and Customization

*Why doesn't Flashmail work for me at home, but it does in class?*

In general, this question asks: How do different personal computers behave differently? Although this student's home computer was the same type as the classroom computer and he was using the same online service as the one used in class, he found that an express method of sending and receiving mail on AOL (called Flashmail) did not work for him at home.

As we saw in the discussion of the first theme, identity (who you are in the networked world) is not maintained on your local computer, but is maintained in its narrowest sense by the internet service provider through which you access the networked world. In a wider sense, identity is maintained through all of your public actions on the internet, which often leave persistent records that collectively say something about who you are. The student reasoned that Flashmail should have worked because he knew that his identity was independent of the particular computer he was using for access. He was the same person, even when he was using two different computers, and he should have been able to read his mail through both access points.

For locals, the networked world operates apart from the computers used for access, but these computers are what enable local intelligibility. In a public library, for example, you can browse the web, but your personal list of bookmarked sites will not be available. Similarly, locals see a distinction between the persistent identity as maintained by the access provider (an e-mail account) and the software used for the e-mail application (Flashmail). The general operating logic is that content and identity are universal (cross-platform), but they need to be endlessly translated and customized to be locally meaningful and accessible. A premium is placed on diversity at the local level, while seamless accessibility to shared content is also highly valued. In fact, locals are known to retain this belief that content should translate across local manifestations in the face of often monumental difficulties in being able to decode content locally. (Witness the difficulties of dealing with e-mail attachments across platforms.)

Customization is an important feature of most current applications, even simple ones. But it is so pervasive that it is virtually invisible. It is often buried in a catch-all menu under a name like "Preferences", "Options", or "Settings"—none of which suggest how crucial it is to do appropriate customization. Customized content is increasingly available from a number of web sites and applications, such as shopping and news sites that recognize repeat users and adjust the presentation according to users' previous interaction histories. This can be quite useful when it works well, but the

behind-the-scenes nature of this customization makes it harder for newcomers to the internet to learn which aspects of their online experiences are changeable or controllable. Software designers can help by making it more obvious to the new user that an application has not yet been individually customized, to advertize the fact that there is a distinction between an off-the-shelf or default version of the application and the user's own personal version.

## 6.2. Residence and Control

*Why don't we have to sign onto AOL to see the files we've downloaded?*

This is a rather ambiguous question. The student who asked this question had just learned how to download files in class and had also practiced reading one of his downloaded files using a word processing program on the classroom computer. The student might be reasoning that the file is owned by AOL, is still located on AOL, or is in a format that only AOL can decode; in any case, the student's question clearly implies that AOL is the guardian of that file. In general, this question is concerned with the boundary between the local computer and the AOL online service. The student assumes AOL should continue to be involved in accessing files, since it was the gateway through which the files were originally obtained.

*I use my Favorite Places so much I'm afraid of losing it sometime. Is there a way of putting it on a floppy disk? I've gotten a lot of good links that I'd hate to lose in case of a 'crash'.  
Is there any way to read this forum offline?*

These questions ask: To what extent can I manipulate network "stuff" on my local computer? In the Favorite Places question, the user is concerned about what she can or should do to protect herself from losing valuable information, but she is not sure where this information is and who takes care of it. This question is complicated, because it is a case of trying to understand customization as it is controlled remotely (by AOL). In both of these questions, the users are seeking to use the local computer to give them more control over interactions in the networked world.

The rise in web-based applications has led to a partial decoupling of locality and user control, since users usually do have some control over the non-local applications they use. That is, users don't need to feel that information has to be resident on their computers in order to be able to manage it. On the other hand, they do need to understand the limits of their choices and responsibilities in managing their own information, wherever it lives.

It is often not clear to newcomers how information objects can be transported around the networked world. For example, a file in an AOL library or ftp (file transfer) directory can migrate in its current form. A web page can be locally printed (one form of migration) or saved in its HTML source format



(another form of migration), but if it is stored locally it loses its identity as an active web page. In general, locals assume is that most online objects should be able to migrate (through various translations), but then the content might cease to be shared and networked and instead become personal and local.

Designers need to help users understand when and why migration of a document is useful from a user's perspective, and whether a document can preserve its "essential" features when it migrates between the networked world and a local computer. Designers should consider ways to mark more explicitly when content is local or remote, and what kinds of translations it might take to make remote content locally intelligible.

## 7. ORGANIZING THE NETWORKED WORLD

This final theme addresses the various organizations that are involved in the networked world, which include content, service, and access providers, and hybrids thereof. How are the different functions of the internet distributed across and managed by different organizational entities, and how does an internet participant interact with these different organizations?

In the Learning Center classes we observed, students are exposed to a variety of organizations as part of their entry into the networked world. Typically, these include America Online and SeniorNet, as well as particular content providers that students may encounter on AOL or the web, such as Elderhostel or *USA Today*. Some students had already arranged for e-mail accounts through free services such as Yahoo. Through the students' experiences outside of class, they may also be aware of other access and service providers. It is far from clear to newcomers what role each provider plays in the networked world. As we have seen in other areas, the students' questions point to aspects of the internet that are especially ambiguous and subject to rapid change. Locals may take the ambiguities for granted, but newcomers' questions remind us of the fluidity of organizational distinctions in the competitive business environment of the internet.

### 7.1. Parts and Wholes

*Is SeniorNet part of AOL?*

*If you are on AOL, are you automatically on the internet?*

*What is the difference between SeniorNet and AOL?*

These questions ask: What are the relationships between content providers, service providers, access providers, and the internet? And who plays which roles? Many of the student questions in this area assume a model of parts and wholes to understand the structure of net organizations. For example, is

SeniorNet in a part/whole relation to AOL? Is AOL in a part/whole relation to the internet? Given that the different organizations that comprise the networked world appear to have different scales, this is a reasonable assumption to make. Content may be related as chapters to a book, and organizations may be subdivided in a hierarchical model. Newcomers to the networked world assume and perhaps hope for an elegance of design that would allow them to identify supersets and subsets that are in some logical and accountable relation to one another.

By contrast, locals to the networked world have long resigned themselves to the patchy, *ad hoc*, and chaotic nature of net organizations. Internet users work with a myriad of parts that do not resolve into wholes, and any proposed hierarchy is always under contestation. Service, access, and content providers are constantly jockeying for position and voice while forming fragile alliances that are on always on the verge of collapse, and we call this chimera the internet, giving it an illusion of organizational stability.

The networked world is further complicated when online services such as AOL provide content that is separate and distinct from the internet at large, available only to subscribers. This content is not part of the public internet; instead, it is alongside the internet. The networked world is an assembly of different kinds of parts, and they do not constitute a single whole.

#### 7.1.1. *The Medium and the Message*

*Is USA Today on the web the same as USA Today on AOL?*

Many of the student questions, especially when working from a part/whole model, assume that the medium and content are provided as a piece, and that they are organizationally whole at the point of access. This is an entirely reasonable assumption when beginning with the models provided by other media technologies, utilities, or even destinations. For example, a printed book involves various organizations and individuals in its production and distribution. But at the point of access, the product is unproblematically whole, with the content integrated into its material form. (However, electronic books and audio books do decouple a book's content from its form.) Utilities such as electricity or water are accessed through a single organization, which provides the "content" as well as any associated services, such as repair. Finally, one might consider certain content-based destinations such as theme parks or even libraries, where a single organization again manages the content as well as the service and the space.

The question about *USA Today* is from a student who has already discovered that online content is often organizationally decoupled from the medium. In the networked world, locals are almost always dealing with multiple organizations when accessing any given piece of content. Further, these organizational distinctions matter in the relationship the user has to the content. You may need

to “contract” separately with three different organizations to access a given piece of content. For example, you might access the web through a connection provided by your local internet provider, arrange for an e-mail account through a network service provider such as Yahoo, and pay a membership fee to SeniorNet while participating in the SeniorNet network community on the web. In short, in the networked world, access, service, and content are organizationally separable.

## 7.2. Implications of Organizational Arrangements

*Could I access SeniorNet on AOL through Microsoft?*

[When looking up chocolate cake recipes using different web search engines] *What is the role of AOL in all this?*

In general, these questions (and all of the questions we include in this theme) ask: How do different providers affect what I want to do? The ways in which organizations carve up their responsibilities in the networked world reverberate throughout the online experiences of internet participants. Soon after their introduction to the internet, new users realize that these organizational affiliations matter, that it is not simply a matter of branding (Coke versus Pepsi, but you still get cola), or even of choosing a particular informational venue (the *New York Times* has the best book review section). Rather, organizational structure governs in complicated ways not only the brand and content, but also the form, functionality, and general informational access. The newcomers’ questions point to the complexity of these organizational arrangements.

One of the ways newcomers try to understand the role of different organizations is to discern the particular value they are providing to users. A familiar kind of value is exclusive access to interesting content—for example, book reviews you can read nowhere else. But content and access can be related in myriad ways on the internet. The student looking for *USA Today* found that the *USA Today* content was independent of both her access provider (AOL) and a provider of community services (SeniorNet). In the question about Microsoft, the student wonders if both AOL and Microsoft could provide access to SeniorNet content—this is possible, since access and content are separable. But at this time, SeniorNet and AOL were organizationally symbiotic, and the SeniorNet/AOL network community was not accessible through a third party provider.

This line of questioning reveals an even deeper assumption that is held by newcomers to the networked world: organizational affiliation must determine in some way how, whom, and what I can communicate with. Even if you accept that you might be getting access or service through a different organization than the one providing the content, surely the former organization must have

some role in determining how communication and information access work. The economic exchange with the access provider must shape content in some logical way, and it seems sensible to assume that you are paying for more and better content. Indeed, what is the role of AOL in all of this?

By contrast, locals to the networked world increasingly see the value of organizational affiliation less in terms of the volume or nature of content that is accessible (all paths lead to the web anyway), and more in terms of how that content is presented. If “information wants to be free”, then value must reside in the services that help manage that free-flowing information. Local understanding is organized by the value placed on open exchange of information on one hand, and the desperate need to limit and organize this information on the other. With the ascendancy of networked content like blogs, the operative metaphors are inflected further towards service, filtering, searching, linking, and ranking, rather than content within boundaries.

#### CONCLUSION

Many of the seniors in our study became enthusiastic and successful users of the internet—it does not take long for newcomers to lose their fresh perspective on the networked world as they move toward becoming locals themselves. But by listening carefully to the questions of these newcomers in their early encounters, we catch glimpses of how the networked world might appear to inquisitive and puzzled visitors from afar. We begin to see curiosities and quirks, as well as deeply held general beliefs that organize the networked world. These aspects of the networked world have become invisible to more experienced users through tradition and habit, but they are strange, interesting, or challenging to newcomers. This perspective can be useful to designers in two ways. First, we should look more closely at the metaphors, explanations, and basic assumptions that are embedded in the user models and interfaces of networked applications, to see where they can be clarified and made explicit to newcomers. Second, it may be fruitful to turn our customary assumptions upside down from time to time, to see if there are new ways of organizing the networked world keyed to increasingly diverse populations and changing technical capabilities. Finally, the underlying approach towards analyzing and denaturalizing internet cultural assumptions is more pertinent than ever if we take seriously the contention that “code is law” (Lessig, 1999). The architectures and ontologies of the internet have far-reaching social and legal implications that extend far beyond the seemingly obscure technical details.

#### ACKNOWLEDGMENTS

This research has been funded by the National Science Foundation under Grant #SBR-9712414. During the project, three of the authors (O’Day, Adler, and

Mynatt) were located at Xerox PARC and two (Ito and Linde) were located at the Institute for Research on Learning, and this research was also supported in part by these institutions. We are grateful to the SeniorNet staff who supported us in this project, especially Marcie Schwartz and Ann Wrixon, and to all of the SeniorNet members who generously shared their network communities and classes with us. We appreciate the contributions of our Advisory Board members, Claude Fischer, Malcolm McCullough, Sim Sitkin, and Terry Winograd, and our Xerox PARC colleagues Paul Dourish and Steve Harrison.

#### REFERENCES

- About SeniorNet*. (2003). Retrieved November 2003, from SeniorNet website: <http://www.seniornet.org/php/default.php?PageID=5005>.
- Bier, M. C., Sherblom, S. A., & Gallo, M. A. (1996). Ethical issues in a study of Internet use: uncertainty, responsibility, and the spirit of research relationships. *Ethics and Behavior* 6(2), 141–151.
- Castells, M. (2001). *The Internet Galaxy: Reflections on the Internet, Business, and Society*. Oxford: Oxford University Press.
- Cyberatlas staff. (2003). The Big Picture Geographics: Population Explosion. Retrieved November 2003 from CyberAtlas website: [http://cyberatlas.internet.com/big\\_picture/geographics/article/0,1323,5911\\_151151,00.html](http://cyberatlas.internet.com/big_picture/geographics/article/0,1323,5911_151151,00.html).
- Delaney, C. (1986). The Meaning of Paternity and the Virgin Birth Debate. *Man* 21(3), 494–513.
- Global Internet statistics by language. (2003). Retrieved November 2003 from Global Reach website: <http://www.glreach.com/globstats/>.
- Ito, M., O'Day, V., Adler, A., Linde, C., & Mynatt, E. (2001). Making a place for seniors on the Net: SeniorNet, senior identity, and the digital divide. *ACM SIGCAS Computers and Society* 30(3), 15–21.
- Kraut, R., Mukhopadhyay, T., Szczypula, J., Kiesler, S., & Scherlis, W. (1998). Communication and information: alternative uses of the Internet in households. *Proceedings of Human Factors in Computing Systems*, 368–375.
- Kraut, R., Scherlis, W., Mukhopadhyay, T., Manning, J., & Kiesler, S. (1996). HomeNet: A field trial of residential Internet services. *Proceedings of Human Factors in Computing Systems*, 284–291.
- Leach, E. (1966–1967). Virgin birth. *Proceedings of the Royal Anthropological Institute*, 1966–1967, 39–48.
- Lessig, L. (1999). *Code and Other Laws of Cyberspace*. New York: Perseus.
- Lovink, G. (2002). *Dark Fiber: Tracking Critical Internet Culture*. Cambridge: MIT Press.
- Nardi, B. & O'Day, V. (1999). *Information Ecologies: Using Technology with Heart*. Cambridge: MIT Press.
- Nolan, J. (2005). The technology of difference: ASCII, hegemony and the internet. In: *Communities of Difference: Culture, Language, Technology*, Trifonas, P. (Ed.), New York: Palgrave.
- NTIA. (2000). Falling through the Net: Defining the Digital Divide. Available at the website of the National Telecommunications and Information Administration of the U.S. Department of Commerce: <http://www.ntia.doc.gov/ntiahome/ftn99/contents.html>.

- O'Day, V., Ito, M., Linde, C., Adder, A., & Mynatt, E. (1999). Cemeteries, oak trees, and black and white cows: Learning to participate on the Internet. *Proceedings of Computer Support for Collaborative Learning*, 360–367.
- Schneider, D. M. (1968). Virgin birth. *Man* 3(1), 126–129.
- Stefik, M. (Ed.) (1996). *Internet Dreams: Archetypes, Myths, and Metaphors*. Cambridge: MIT Press.
- Yanagisako, S. & Delaney, C. (1995). Naturalizing power. In: Yanagisako, S. and Delaney, C. (Eds.) *Naturalizing Power: Essays in Feminist Cultural Analysis*. New York: Routledge, 1–24.

## Chapter 33: The eLibrary and Learning

PETER BROPHY

*Centre for Research in Library and Information Management (CERLIM),  
The Manchester Metropolitan University, U.K.*

**“I have always imagined that Paradise will be a kind of library . . .”**

Jorge Luis Borges

### 1. INTRODUCTION

. . . although, one might add, not every library will be Paradise!

Discussion of libraries in general and eLibraries in particular can be found across a wide range of literatures, from the professional through the fictional to the fantastical (Terry Pratchett’s librarian, it will be recalled, is an orangutan whose limbs are ideally designed for retrieving books from the remotest shelf). The more serious literature may be less far-fetched—although some accounts of future libraries run Pratchett close—but its terminology frequently conspires to compromise communication. In a recent review of the literature on linkages between virtual learning environments (VLEs) and digital libraries, we noted:

“An immediate problem encountered when searching for published literature was differing terminology. The ‘digital library’, it quickly became clear, is known . . . as the ‘electronic library’, the ‘virtual library’, the ‘distance library’ or the ‘online library’; the VLE as a ‘learning management system’, a ‘course management system’ (a subtle difference in emphasis!), a ‘managed learning environment’ (MLE), an ‘online learning system’ or ‘learning environment’, ‘instructional management system’, ‘courseware’, ‘learnware’ . . . .”

(Markland & Brophy, 2003)

Of course, in each case the favored term contains many layers of meaning. They are capable of, and indeed encourage, different interpretations by different observers in different contexts. To give but one example, in the U.K. the concept of the “electronic library” emerged in the early 1990s. But then it became fused with a major funding program in the higher education sector (the *eLib Programme*) which, while generally successful, revealed some of

the shortcomings of the purely electronic approach. As a result the term now carries an amalgam of negative as well as positive connotations in that country. It will, to the initiated, inevitably bring to mind the Programme's conclusion that a "hybrid" library, delivering both digital and traditional sources, is most likely to meet users' needs. To someone who had never come across the Programme such inferences would be far from obvious.

Yet all this is not to deny the validity of the eLibrary concept (the term will be used generically throughout this chapter). It merely points to some of the connotations the term may carry in certain communities and some of the limitations it may signify. The perfectly valid question remains: How might we define and design an effective "eLibrary" which would contribute fully to the achievement of broadly based learning objectives? What, at its best, would an eLibrary look like? Although some might argue that the starting point should be elsewhere, we can begin to answer that question by exploring more traditional understandings of the "library", examining electronic "equivalents" and then considering the question of and how, and in what manner, such models might be applied in the context of learning and eLearning.

## 2. LIBRARIES

"Before the invention of paper the thin inner bark of certain trees was used for writing on; this was in Latin called *liber*, which came in time to signify a 'book'. Hence our *library*, the place for books; and *librarian*, the keeper of books."

(Brewer's, 1970)

It is common, at least in the academic sector, to refer to the library as the "heart of the university". The origins of this phrase are unclear, although Grimes (1998) suggests that it is to Charles William Eliot, President of Harvard University from 1869 to 1909, that the first documented occurrence should be attributed. The metaphor was picked up in the U.K. and used in various reports, including the influential Parry Report of 1967 (University Grants Committee, 1967), which led to considerable investment in university libraries. However, as Grimes points out, the phrase has been used loosely and there is little evidence that it reflects thinking at a strategic level:

"The metaphor implies that the academic library is of unparalleled importance. Despite its persistence for more than one hundred years, there is a considerable distance between the relationship it implies and institutional opinion and practice. Evidence of this difference is found in a number of areas. . . . Students and faculty alike fail to involve library resources and services in regular learning and instruction,



turning to the library primarily as an undergraduate study hall or reserve book room. . . . (libraries) remain, for the most part, on the periphery of decision-making and innovative processes. . . . In all, the ‘library is the heart of the university’ metaphor leads librarians and academics to erroneous conclusions about the real relationships between the library and the university.”

(Grimes, 1998)

These are appropriate words of caution, if perhaps a little over-pessimistic, for all too often it is simply assumed that “a library is a good thing” without appropriate evidence. It is also helpful to be reminded that the current position of the university library at the center of the physical campus is a relatively recent innovation:

“The traditional library organisation was characterised by a decentralised structure in which individual libraries were found in the locations where teaching and research activities actually took place (mostly in the professors’ rooms). In order to improve efficiency, to solve logistic problems, and, above all, to cut costs, books and magazines were relocated to central or faculty libraries. Double subscriptions were cancelled. While obviously provoking some protest from among faculty members, this operation was in many cases inevitable.

(Savenije & Grygierczyk, 2001)

Savenije and Grygierczyk remind us that for very many years libraries in academic institutions were highly distributed and the departmental library was jealously guarded by professors, lecturers, and students alike. The monolithic library, though now well established, is but one model for organizing the institution’s information resources.

It is both interesting and useful to note that in recent years many commentators have started to see a return to a more user-centered view of the “library”, as the emphasis has shifted from a concentration on buildings and on large local collections of physical books and other objects toward a primary concern with the provision of access, whether or not the library owns the information content in physical form.

These ideas have led quite naturally to a model which emphasizes the social role of the library. For Shera

“A library is . . . a system designed to preserve and facilitate the use of graphic records. It is a social system created to form a link in the communication system that is essential to any society or culture. . . . Its fundamental concern is with the communication of knowledge, ideas, thought . . . .”

(Shera, 1980)

and for Borgman

“Libraries are social institutions that have evolved over a period of many centuries. They serve the information needs of their user communities, adapting collections and services as those needs change. Libraries tend not to be autonomous institutions. Rather, most are funded by governments to serve a defined community; by schools or universities to serve students, teachers and staff; or by businesses, hospitals, museums, or other organizations to serve their employees and other constituents.”

(Borgman, 2000)

The conception of a library as in essence a social organization, entwined within (but not necessarily the heart of) the broader society and community it serves, is a vital one which guards against a mechanistic view which could too easily become prominent within environments which are dominated by technology. Bearing it in mind, let us examine some of the conceptions of the eLibrary (again ignoring for this purpose the terminological niceties), which are revealed in the literature.

### 3. ELIBRARIES

One starting point is the so-called “digital library”, using a term that has tended to be favored mainly by computing science practitioners. Take the New Zealand Digital Library project as an example. It describes the concept as follows:

“A digital library is made up of a set of collections. Each collection of information comprises several (typically several thousand, or even several million) documents, which share a uniform searching and browsing interface.”

(New Zealand Digital Library, 2003)

Here the twin foci are large sets of documents and a common interface. Others stress the importance of the shift from ownership to access that we have already noted:

“The digital world has . . . caused a shift in the perceptions of users and librarians, and in the underlying paradigms upon which libraries are based, which means that owning and controlling resources on a local basis is no longer the only efficient or effective way of satisfying information needs.”

(Deegan & Tanner, 2002)

Arms goes a stage further in his definition, stressing the need for the documents to be managed and organized, and pointing to the heterogeneity of the community served:

“An informal definition of a digital library is a managed collection of information, with associated services, where the information is stored in digital formats and accessible over a network. A crucial part of this definition is that the information is managed. A stream of data sent to earth from a satellite is not a library. The same data, when organized systematically, becomes a digital library collection. . . . Digital libraries contain diverse collections of information for use by many different users.”

(Arms, 2000: 2)

A still more formal definition is provided by the Council on Library and Information Resources (CLIR) in the U.S.A.:

“Digital libraries are organizations that provide the resources, including the specialized staff, to select, structure, offer intellectual access to, interpret, distribute, preserve the integrity of, and ensure the persistence over time of collections of digital works so that they are readily and economically available for use by a defined community or set of communities.”

(Waters, 1998).

Arms' concern that to constitute a “library” the content must be managed is repeated here, and with it comes a reminder that libraries have always made intensive use of human intellectual capacity to make sense of the vast wealth of information resources available. As this potential content has grown in volume in recent decades, and particularly with the explosion in quantity of information in electronic form, the complexity of deciding on appropriate sources, not to own but to point users towards, has multiplied. Of course tools have been developed to assist in this process, but do Google and other search engines really replace this expertise? That is a question to which we must return later. But before moving on, look again at Waters' definition, and note that other roles of the library emerge. Ensuring “persistence over time” occupied much of the effort and not a little of the available budget of the traditional library—here we are reminded that the electronic era does not automatically resolve such questions. Indeed the loss of content, even over short periods, has emerged as a critical issue for the eLibrary community.

But so far the eLibrary has been defined only in functional terms. Just as the traditional library has come to be seen as a social system, so too many commentators have started to examine the role of the eLibrary within its social setting. Owen and Wiercx in the Netherlands, in a supporting study to the European Commission's *Telematics for Libraries* Programme, saw the

digital library as a key component of the scholarly communication chain, and suggested that it might best be characterized as a “knowledge mediator”. They built on this concept to suggest that the eLibrary needs to perform three related tasks:

- “Making available various types of knowledge resources.
- Providing resource discovery mechanisms, which allow users to identify relevant or requested resources and their locations.
- Providing mechanisms for delivery of specific resources to the user; delivery includes both obtaining a resource when it is not already available in the library, and passing it on to the user in a suitable way.” (Owen & Wiercx, 1996)

So the idea starts to emerge that, just as the traditional library is an integral part of its parent social organization, so too the eLibrary, to be fully understood, needs to be thought of in terms of social and personal, as well as technological, processes. This brings us to the question of the relationship between the eLibrary and learning.

#### 4. LEARNING

It is not the place of this chapter to discuss learning itself, nor for that matter eLearning, yet it would be remiss not to make some observations which provide background to the discussion of the eLibrary within its learning community—without a learning intent among providers and users of the eLibrary it would be difficult to find its rationale.

The first point is that since learning is not a monolithic concept, eLibraries must be designed to support variety, actively encouraging a range of approaches to learning both from an institutional and from a user perspective. This suggests that the pedagogical models behind the learning being supported need to be a strong driver in the design of eLibrary services.

Elsewhere in this volume there is discussion of pedagogy in the electronic environment and a number of theoretical perspectives are examined. Among these, the ongoing debate concerning objectivist and constructivist pedagogies provides an important example of how eLibraries need to be designed within a context of learning theory. As I have observed elsewhere, libraries have tended to assume an objectivist approach, perhaps led astray by the intricacies of their beloved classification systems:

“(objectivism) views the world as an ordered structure of entities which exists and has meaning quite apart from the observer or participant. Much of science and technology is taught on this basis: what needs to be achieved by learning is a closer and closer approach to complete (and

thus ‘correct’) understanding. As Duffy and Jonassen (1993: 3) observe, in this understanding ‘the goal of instruction is to help the learner acquire the entities and relations and the attributes of each—to build “the” correct propositional structure’ . . . very often an underlying assumption of information and library service delivery can lie very much within this frame of reference—references to ‘bibliographic instruction’, for example, reveal an objectivist approach in which the student is instructed in the ‘correct’ view of the world—perhaps that devised by Melvil Dewey!”

(Brophy, 2001b)

If, on the other hand, the challenge comes from constructivist pedagogies, would we expect to find very different eLibraries?

“learning is a constructive process in which the learner is building an internal representation of knowledge, a personal interpretation of experience. This representation is constantly open to change, its structure and linkages forming the foundation to which other knowledge structures are appended. Learning is an active process in which meaning is developed on the basis of experience. This view of knowledge does not necessarily deny the existence of the real world . . . but contends that all we know of the world are human interpretations of our experience of the world. . . . learning must be situated in a rich context, reflective of real world contexts for this constructive process to occur.” (Bednar et al., 1993: 21)

Goodyear (2002) suggests that six characteristics of “good learning” can be identified—learning is “active, cumulative, individual, self-regulated, goal-oriented, and situated”—and recommends (in the context of development activities designed to bring together electronic information services and learning) that these “can help members of a project team discuss and clarify key issues about how the resource on which they are working is intended to help students learn”.

Surely the only possible conclusion for librarians, viewing the debates and battles raging over pedagogical theory and practice, is that their role is to act as facilitators for *whatever* learning is taking place within *whatever* pedagogical frameworks teachers devise and students adopt (not at all the same thing, of course!), and that in responding to this call they must be sensitive to the styles, preferences, and approaches of the individual learner. So part of the role may well be to support the delivery of highly structured packages which contain all the information and resources a learner might need to gain knowledge of a specific subject; but another part is to facilitate access, not to a specific, closed set of texts, but to the widest possible range of information resources, providing systems which will encourage users to explore the literature and

enhance their learning experiences by engagement with recorded knowledge in all its variety.

It is this concern—to support the reality of eLearning across the full spectrum of its practice—which needs to lie at the heart of developing eLibraries, and it is a central concern to which I return later. What kind of eLibrary might be required to support both objectivist and constructivist—and other—approaches to learning?

## 5. THE ELEARNER IN THE NETWORKED INFORMATION WORLD

Before turning directly to this question it is worth examining briefly the ways in which learners act in networked information spaces. Much of the evidence for information behaviors comes from the pre-internet age and thus it is to more recent studies that we must turn to obtain clues as to information seeking, information handling, and information using behaviors. While there is not space to examine this literature in depth here, the following functional model summarizes the approach, which has underpinned the majority of recent developments in eLibraries (adapted from Brophy, 2001a).

### 5.1. Formulate Query

Users begin by formulating some kind of query to represent the information that they require. This representation of their requirements could be in the form of specific terms that describe a subject or an author, or may be quite vague—a “book like the one I had last week”—or could be highly directed, as when the user simply clicks on a likely looking link provided by the tutor within the learning package. The library has traditionally played a role in helping users express their requirements in ways that can be used within the subsequent retrieval system, whether it is human, electronic, or both. Whether or not the user employs a controlled vocabulary may be an important determinant in the success of the subsequent search process; this also raises the question of how users are guided to use such terminologies and the tools, aid and advice that the eLibrary may need to provide.

### 5.2. Browse Descriptions

Once the query has been submitted to the information system the normal pattern is for a set of descriptions of information objects (the term “information object” is used to denote the generic case) which *may* meet the requirement, and the user examines them. In the physical library this process would formerly have taken place by browsing through a section of the card or other printed catalog; currently the Online Public Access Catalogue or OPAC, together

with a wide variety of online indexes and other tools, provides much more sophisticated ways of retrieving bibliographic information. Use of World Wide Web search engines such as Google will involve browsing among lists of descriptions of possibly relevant items, before narrowing down the search. Descriptions may also be delivered to the user automatically, for example, through an alerting service.

The user may not need to go beyond this stage if, for example, the descriptions returned by the system include abstracts or if the query was to establish that a particular author had written a particular book.

### **5.3. Discover**

The next step, closely entwined with browsing descriptions, is to identify a particular item as being of potential interest and finding sufficient data about it to enable it to be identified uniquely. With a “known-item” search, where a user is following up a specific bibliographic reference, this may replace browsing of descriptions. The result is that the user has identified a specific item, which he or she wishes to see.

### **5.4. Locate**

The next step is to locate an instance of the desired item. In the traditional library this could have been within a special collection or in a particular bay of shelving or maybe in the “short loan” collection of items held against heavy student demand. Libraries have usually concatenated subject descriptors with locators to a large extent, so that the Library of Congress (or whatever) classification can be used, with other details, to locate the item. Where the item is not held locally, the library may itself take on the responsibility for identifying a suitable location. In the electronic environment there are a number of issues to resolve, of which one of the most challenging is what has become known as the “appropriate copy problem”. This occurs because users may have multiple rights depending not just on who they are but on what they are doing. So access to an e-journal may have been negotiated for students registered on a particular course and undertaking it by distance learning but not for those based on-campus; the publisher might also offer a fee-based article delivery service. eLibrary systems need to detect that rather than offering the fee-based alternative, or pointing to the paper-based version in the campus library, the most appropriate location of a copy for this particular student would be the specially negotiated online “deal”. Just to compound the problem, some students might have professional body membership, which provides yet more alternative entitlements to the same journal, regardless of the courses or institutions to which they belong.

### **5.5. Browse Objects**

In a traditional library, once a location had been identified it would be possible to browse through shelves of books or through the issues of a journal, not necessarily to find one in particular, but perhaps to look for ideas. There is some equivalence in browsing through items selected by a web search engine, although in general electronic services are not particularly supportive of this function—it is very difficult to undertake the equivalent of flicking through the pages of a shelf of books on a PC. Line (2000) remarks: “Browsing electronic sources has its own merits, but it is a different process from browsing print; it may prove impossible to offer a good electronic surrogate for book browsing”.

### **5.6. Request**

If the identified objects are not immediately available to the user (as they may be if it is simply a matter of clicking a link—or at least one that works!) a request for them has to be initiated. In a traditional library with closed access collections a form may have to be completed to request staff to retrieve the item from the stacks. With electronic services offering access to subscription and other paid-for services, where delivery of a resource depends increasingly on software systems “negotiating” to enable users to be given access, the request function is a core process.

### **5.7. Authenticate**

The system needs to know that the users are who they say they are (authentication) and that they are authorized to access the material requested (authorization). It then needs to ensure that the appropriate “business process” is put in place to deal with the transaction. Is the user a member with a right to request inter-library loans, for example? In the electronic environment, this might include checking that the user has enough credit to use the system (maybe in appropriate cases by taking credit card details), and then setting up a transaction with appropriate non-repudiation features.

The stage at which authentication and authorization are carried out is dependent on a number of factors. Ideally, in the electronic environment, it occurs when the user logs into the system so that the permissions can be carried through until the end of the session. However, there is also a parallel with traditional services where it is desirable to offer free and open access to many resources without requiring users to identify themselves. In these cases the authentication and authorization may be delayed until the user first generates a request for a restricted item—“restricted” in this sense meaning that it is not open to all users without question.



### 5.8. Deliver

This is the actual process of delivering the requested item to the user. With a book this might involve the completion of a lending transaction; equally it could involve delivering an electronic document via the web or as an e-mail attachment in a form in which it can be displayed at the user's workstation. The electronic environment imposes some additional complexities in that there may be various kinds of incompatibilities and duplication between the objects returned. For example, it is fairly obvious that if a library issues a particular user with a book, a video, and an audio CD then various different types of equipment will be needed to make sense of those objects—such as a pair of spectacles, a video recorder and a CD player. In the electronic environment the equivalent processes need to be handled automatically, and may in addition require methods of synchronizing the delivery of different objects (for example, where a digital video and its audio track are in fact separate “objects” which are only combined when received at the user's workstation). Delivery must therefore interpose some processing in such environments.

### 5.9. Use

The final process which the eLibrary facilitates is use of the information which has been delivered. “Use” includes the processes of extracting and analyzing information, applying it to specific problems, questions and tasks, personal storage and indexing of files and links, and, in essence, the creation of personal eLibraries with all the processes that they imply.

The above theoretical analysis can be observed in practice in a wide variety of settings, although studies of students' use of electronic information sources suggest that such deliberate searching is perhaps the minority approach. Many commentators have expressed concern that the majority of students do little more than insert a few, often ill-chosen, terms in a search engine and then make what they can of the results. In a report of a national study in the U.K., Armstrong et al. described how few students made use of the more sophisticated information services, such as subject gateways of “quality-assured” resources, provided for them:

“The effect of the internet on information seeking by students is hugely significant; search engines are the first resort for most academic queries . . . subject gateways are notable only for their lack of mention among students.”

(Armstrong et al., 2001: 259–60)

One of Armstrong et al.'s interviewees illustrated the problem nicely:

*“Interviewer: you do internet searches for your coursework, is that the most common sort of information source you use? . . . Student . . . I don’t really use anything else.”*

(Armstrong et al., 2001: 259)

In a contemporaneous study (Griffiths & Brophy, 2002) we reported very similar findings: “Students either have little awareness of alternative ways of finding information to the search engine route or have tried other methods and still prefer to use Google—a situation we now refer to as the Googling phenomenon”. What appears to be happening is that students, faced with time pressures and a huge plethora of information sources, adopt a strategy best described as “satisficing”—what can be found on Google is deemed “good enough”.

## 6. DEVELOPING THE ELIBRARY

“Information technology makes possible all sorts of new activities and new ways of doing old activities. But people do not discard all their old habits and practices with the advent of each new technology. Nor are new technologies created without some expectations of how they will be employed. The probable scenario is neither revolution or evolution, but co-evolution of information technology, human behaviour, and organizations. . . . Products evolve in parallel with the uses for which they are employed.”

(Borgman, 2000: 4)

As we have seen, the eLibrary is, or should be, a complex entity, which is closely integrated with the learning it is intended to support. Borgman is surely right to emphasize co-evolution: we are still discovering the real benefits of eLearning, as well as its disadvantages, and we are still experimenting with different ways of providing learners with access to information resources. A critical issue is to bring the eLearning and eLibrary communities of practice closer together.

As an aside it is worth commenting that one of the curious aspects of the development of eLearning and eLibraries is that the two communities seem to spend so little time talking to one another. Few functional models of eLearning have much to say about the organization of published information—it usually merits a “black box” approach, relegated to the periphery of functional descriptions of VLEs. At the same time digital library commentators seem to spend little time on the actual purpose of their subject—as an example, three key monograph contributions to the digital library debate published in recent years, all with an academic background and referred to earlier in this chapter,

(Arms, 2000; Borgman, 2000; Deegan & Tanner, 2002) do not contain a single reference to either “learning” or “eLearning” in their indexes.

It is easy to devise simplistic solutions to the problems of providing integrated access to information resources within VLEs, and Arms’ earlier caution that libraries are *managed* collections must be taken to heart. However, since the “space” in which we live and learn is now global, a fundamental question is how a localized service (even if its customers are distributed widely across the globe) can in any real sense manage information resources. The integration of the eLibrary into learning, remembering our earlier emphasis on the library as part of a social system, demands local solutions. There is no such thing as a single, universally implementable blueprint. Yet the context is the global information resource. Global reach within local communities provides the locus of the challenge.

## 7. TOWARDS EFFECTIVE ELIBRARIES

### 7.1. Local and Regional and National and Global

The effective eLibrary is local to its constituents—in terms of their relationship to the learning environment rather than physical location. It is engaged with the pedagogical underpinning of the learning which has been designed—the high level pedagogy such as, say, problem-based learning; the pedagogical strategy which includes the broad plans for delivering and engaging in learning; and the pedagogical tactics such as ploys to encourage reluctant learners to participate (see CSALT, 2000). But it is also a window onto the broad universe of information and it sits within a managed framework of information resources. To achieve this it does not stand alone, but plays an active role in creating and maintaining an information environment on which to draw.

A good example of the planned development of a managed information environment is provided by the U.K.’s higher education community, led by its Joint Information Systems Committee (JISC). For over 10 years the JISC has engaged in a program of development which provides shared services and shared content at national level, available to be drawn into local eLibraries and local learning environments as and when required. The technical infrastructure to achieve this is complex and is articulated in the JISC Information Environment Architecture—see <http://www.ukoln.ac.uk/distributed-systems/jisc-ie/arch/>. In essence it is a collaborative venture in which those services which can better be provided nationally, such as access to large datasets, with all the accompanying user authentication and authorization requirements, are handled at that level while localization ensures fitness for the individual institution, department, course, and class. It is this collaboration—which goes far beyond the warm sentiment and limited action which characterizes so

much “collaboration” between institutions—which will mark out the successful eLibrary of the future. In the United States many similar characteristics can be seen in services provided by, or through, longstanding co-operative systems like OCLC with its mission “to further access to the world’s information and reduce library costs by offering services for libraries and their users”. (see <http://www.oclc.org/about/>).

## 7.2. The Importance of Quality

Quality is frequently defined as “fitness for the user’s purpose”. It requires, in essence, a judgment, which links together the object and the task; the information resource and the learning event. We can provide clues and guidelines but in essence quality remains a matter of individual judgment, of the student or tutor. It may be, as with a refereed journal paper, a judgment supported by experts in the field. It may be judgment informed by prior reputation, as when we accept a reputable publishers’ offering over that of an unknown house. It may be mechanistic, as when Google offers hints based on the number of other resources to which a target information source is linked. But at the end of the day there is an intellectual imperative on the user.

The eLibrary helps in two ways. Firstly it tries—and on the basis of long experience hopefully succeeds—to filter out the more obviously poor quality resources. Unlike the mechanistic search engine, it is able to distinguish between the medical paper on “breast cancer” and the web site which offers inexpensive options for the enlargement of body parts! But further than this, it enters into the learning process by providing opportunities for users to develop their own analytical and critical skills—in the emerging argot, to become “information literate”. This must be a true partnership activity between those responsible for designing learning and those with particular expertise in the structure and organization of published information in order to ensure that the learning activity is fully situated within the broader domain of interest. As Virkus (2003) has written:

“information-related competencies may be viewed as context- and content-dependent competencies which are integral elements in a constructive learning environment and are closely related with the characteristics of constructive learners (prior knowledge, metacognition, motivation, and the complex variable ‘learning style’). However, the term ‘information literacy’ might be a useful research construct or umbrella term covering information-related competencies and also as a strategic concept or goal—a political, economic and educational one.”

Perhaps it is in the centering of information literacy within the curriculum that the answer to student “satisficing” can be found.

### 7.3. Personalization

We have already discussed the need for localization of eLibrary services, but there is also considerable activity to take this a stage further by offering the individual personalized access to services. These are seen most obviously in the various “MyLibrary” developments (“MyLibrary@NCState” being the best known and perhaps original example—see <http://my.lib.ncsu.edu/>) and more broadly in the widespread move to develop portals. Service providers like Yahoo and Amazon are keen to address the individual’s needs through personal content, and see this as a way of providing added value. It is also worth noting that the development currently of web services approaches (which enable machine to machine interrogation and retrieval of content for manipulation and presentation) and in the near future of the semantic web (which enables content to carry processable meaning) will provide the means forever more sophisticated personalization. The eLibrary needs to be involved closely in these developments.

### 7.4. Describing Information

Librarians are used to the lack of enthusiasm of the layperson for the intricacies of cataloging, which can appear an arcane craft with limited benefit to the world at large. Yet the catalog record, or to generalize and bring the terminology up to date, the meta-data, is the key which unlocks the information universe. Without accurate meta-data, complex retrieval which brings together the content of a particular information object (be it book, video, web page, or multimedia presentation) with the need of a particular individual is, to put it mildly, difficult. Libraries have well-established schema, such as MARC (<http://lcweb.loc.gov/cds/marcdoc.html>), and in the electronic environment the Dublin Core Meta-data Initiative (<http://dublincore.org/>) is now well established.

Of course it is not only libraries and publishing houses which create and use meta-data; learning systems do too. The IMS and other bodies have expended considerable resources to establish meta-data schema (see <http://www.imsglobal.org/metadata/index.cfm>), and there is an enormous body of ongoing research on ontologies, vocabularies, and the like. Nor is meta-data purely descriptive—it is used to record information on rights (who may use, who may copy, who may resell, and on what terms), on suitability (the Platform for Internet Content Selection (PICS) system, for example—see <http://www.w3.org/PICS/>) and for many other purposes.

In seeking to bring together eLibraries and learning systems, considerable work is being undertaken to map the different schema and to reach agreement on common approaches (see, for example, Richardson & Powell, 2003). This is vital work if we are to achieve interoperability between different kinds of

object and different kinds of system. Furthermore, among the many challenges is the need to provide persistence, so that the information source my learning object points to today will be the same information source tomorrow—even if it has moved from one server to another, from one university to another, from one country to another. The list of challenges which meta-data poses is almost endless, and the complexities can be mind-boggling. As Pugh (2003: 56) put it: “metadata reminds me of the Schleswig Holstein question in European history: of the three people who understood it, one died, one forgot and the other went mad.” Yet it is challenge that we must tackle, and tackle together.

#### 7.5. Preservation: Our Responsibility to Posterity

The networked information world and the eLibrary tend to operate in the present tense. The imperative, as we have seen, is access, and the user wants that access to be instantaneous. It is all too easy to neglect the question of who is going to ensure that the resources we point our eLibrary users towards remain accessible, not just for the short term of our envisaged use—the duration of a course or even the period between major revisions of that course—but for future learners, researchers, and historians.

Part of the answer to that question lies in the role that major libraries, such as the national libraries, have played for many years now, receiving and storing copies of all the works printed and published in their region of responsibility. This needs to be extended to electronic publications. The Chief Executive of the British Library has commented:

“at the core of the British Library’s future relevance and mission to assemble a comprehensive record of the output of the nation and to make it accessible for current and future generations, is the continuing effort going in to ensure that the UK will have an adequate system of legal deposit for an electronic age.”

(Brindley, 2000)

However, it is highly unlikely that national libraries will be able to shoulder the whole burden, and in any case the locus of responsibility when so much publishing is global is unclear. Rather, institutions and their eLibraries will have to play a role. There are a number of straws in the wind to be noted here—for example, the movement towards institutional e-print archives and towards repositories of learning objects (one example is the recently established JORUM project—“a practical ‘test-bed’ investigation into a digital repository for learning materials, one that is both capable of providing the technical infrastructure for storage and retrieval of learning objects, and stimulating the re-use of learning materials for UK further and higher education”—see <http://www.jorum.ac.uk/>).

## 7.6. The Human eLibrarian

As yet, the tools which provide the electronic equivalent of the human librarian are in their infancy. We need to remember that some of the characteristics of electronic systems are innately problematic and that it will be a very long time before these limitations are overcome. The problems can be illustrated by reference to what is known as “brittleness”, which in essence is the concern with whether a system is capable of responding when faced with a situation outside its core domain, and whether as the difficulties mount the system degrades “gracefully”. Human beings are very good at handling problems outside their core area of expertise. Ask a human being who is playing chess where you can get a cup of coffee and you will get directions to the drinks machine or a suggestion as to who else to ask for directions—well, you will if you are not berated for interrupting at the crucial moment! Ask a chess-playing computer where to get a cup of coffee and you are liable to be told either “P-Q7” or “Error 6935462: rebooting”! Human beings are extremely flexible, and librarians are trained not to pretend to have all the answers, but to know where to go—and how to find the answer when they get there.

In eLearning environments it is also important to remember that learners are human beings too. There is ample evidence to show that some individuals cope better with online environments than do others—as a simple yet by no means trivial example the CSALT report referred to earlier pointed out that synchronous “conversation” in online environments may proceed too quickly for some students and too slowly for others (CSALT, 2000). We cannot assume that putting in place monolithic services, and removing the flexibility of human support, will adequately answer the learners’ needs.

## CONCLUSIONS

This Chapter has discussed the development of eLibraries within the context of VLEs, suggesting that the essence of the eLibrary lies in its ability to become an integral part of the localized, and essentially social, learning environment while at the same time mediating between the individual learner and the global information universe. The eLibrary will be built on the foundations of the libraries which have served learners so well for so long—but which need to be renewed and reinvigorated. The strategic, managerial, and technological difficulties are daunting, yet around the world innovative librarians and teachers are rising to the challenge.

Perhaps the late Rob Kling of Indiana University can have the last word: “The libraries of your future are not “out there” waiting to be discovered. They will develop as they are envisioned and developed by librarians and others. These visions and developments are likely to be local, incremental and opportunistic.” (Kling, 2000)

## ENDNOTE

1. I should perhaps note here that the discussion in this Chapter does not attempt to address all the possible roles of a 'library' beyond the support of learning: for this broader discussion the reader is referred to Brophy (2001a).

## REFERENCES

- Arms, W. Y. (2000). *Digital Libraries*. Cambridge, MA: MIT Press.
- Armstrong, C., et al. (2001). A study of the use of electronic information systems by higher education students in the UK. *Program* 35(3), 241–262.
- Bednar, A., Cunningham, D., Duffy, T., & Perry, J. D. (1993). Theory into practice: how do we link? In: Duffy, T. and Jonassen, D. (Eds.) *Constructivism and the Technology of Instruction*. Hillsdale, NJ: Lawrence Erlbaum Associates.
- Borgman, C. L. (2000). *From Gutenberg to the Global Information Infrastructure: Access to Information in the Networked World*. Cambridge, MA: MIT Press.
- Brewer's dictionary of phrase and fable. (1970). (Centenary Ed.) London: Cassell.
- Brindley, L. (2000). National Libraries in the e-World. Available at: [http://www.bl.uk/concord/otherpubs\\_speeches03.html](http://www.bl.uk/concord/otherpubs_speeches03.html) (31.12.2000).
- Brophy, P. (2001a). *The Library in the Twenty-first Century*. London: Facet.
- Brophy, P. (2001b). Networked learning. *Journal of Documentation* 57(1), 130–156.
- Centre for Studies in Advanced Learning Technology (CSALT). (2000). *Effective Networked Learning in Higher Education: Notes and Guidelines*. Lancaster: Lancaster University. Available at: [http://csalt.lancs.ac.uk/jisc/guidelines\\_final.doc](http://csalt.lancs.ac.uk/jisc/guidelines_final.doc).
- Deegan, M. & Tanner, S. (2002). *Digital Futures: Strategies for the Information Age*. London: Library Association Publishing.
- Duffy, T. M. & Jonassen, D. H. (1993). Constructivism: new implications for instructional technology. In: Duffy, T. and Jonassen, D. (Eds.) *Constructivism and the Technology of Instruction*. Hillsdale, NJ: Lawrence Erlbaum Associates.
- Goodyear, P. (2002). How Students Learn: Ways of Thinking About 'Good Learning' in HE. *EDNER Project Issues Papers No. 1*. Available at: <http://www.cerlim.ac.uk/edner/ip/ip01.rtf>.
- Griffiths, J. R. & Brophy, P. (2002). Student Searching Behaviour in the JISC Information Environment. *Ariadne* 33. Available at: <http://www.ariadne.ac.uk/issue33/edner/>.
- Grimes, D. J. (1998). *Academic Library Centrality: User Success through Service, Access and Tradition*. Chicago: American Library Association.
- Kling, R. (2000). Information Technologies and the Strategic Reconfiguration of Libraries In Communication Networks. *CSI Working Paper WP-00-04, Indiana University*. Available at: <http://www.slis.indiana.edu/CSI/WP/wp00-04B.html>.
- Line, M. B. (2000). The lifelong learner and the future library. *The New Review of Libraries and Lifelong Learning* 1, 65–80.
- Markland, M. & Brophy, P. (2003). Link<sup>ER</sup>: Linking Digital Libraries and Virtual Learning Environments: Evaluation and Review. *Deliverable D1, Link<sup>ER</sup> Project*, CERLIM Centre for Research in Library & Information Management. Available at: [http://www.cerlim.ac.uk/projects/linker/d1\\_master.doc](http://www.cerlim.ac.uk/projects/linker/d1_master.doc).
- New Zealand Digital Library. (2003). Available at: <http://www.nzdl.org/cgi-bin/library>.



- Owen, J. M. & Wiercx, A. (1996). *Knowledge Models for Networked Library Services*. Luxembourg: European Commission. Available at: <http://cf.hum.uva.nl/bai/home/jmackenzie/pubs/kms4.zip>.
- Pugh, L. (2003). The calm of my life ended there. *Multimedia Information and technology* 29(2), 55–57.
- Richardson, S. & Powell, A. (2003). Exposing information resources for e-learning—harvesting and searching IMS metadata using the OAI protocol for metadata harvesting and Z39.50. *Ariadne*, 34. Available at: <http://www.ariadne.ac.uk/issue34/powell/>.
- Savenije, B. & Grygierczyk, N. (2001). Libraries without resources: towards personal collections. *Collection Building* 20(1), 18–24.
- Shera, J. H. (1980). Librarianship, philosophy of. In: Wedgeworth, R. (Ed.) *ALA World Encyclopedia of Library and Information Services*. Chicago, U.S.A.: American Library Association, 314.
- University Grants Committee. (1967). The Parry Report. *Report of the Committee on Libraries*. London: HMSO.
- Virkus, S. (2003). Information literacy in Europe: a literature review. *Information Research*. <http://informationr.net/ir/8-4/paper159.html>.
- Waters, D. J. (1998). What are Digital Libraries? *Council on Library and Information Resources (CLIR) Issues, No. 4*. Available at: <http://www.clir.org/pubs/issues/issues04.html>.

## Chapter 34: Beyond Museum Walls: An Exploration of the Origins and Futures of Web-Based, Museum Education Outreach

KEVIN SUMPTION

*Powerhouse Museum, Sydney*

*“An effective educational museum might be described as a collection of labels bearing instructions, each of them illustrated by a carefully selected specimen.”*

*George Brown Goode, Assistant Secretary at the Smithsonian, 1896.<sup>1</sup>*

Although Goode’s assertion may look naive by contemporary pedagogical and museological standards, I still sometimes wish that the process of museum education was indeed that easy. However, in truth I know that such assertions are anathema, as both the primacy of museum objects, and our understanding of learning, has advanced considerably in the last 100 years. The museum emerged in the mid-19th century as a general archive, enclosing in one place, all times, all epochs, all forms, and all tastes.<sup>2</sup> Established in 1879 my museum, the Powerhouse Museum, embodied this vision. Up until the 1940s our displays used evolutionary narratives, to move visitors forward through predominantly artifactual learning environments. However, the preponderance of artifacts and their position within the exhibition medium began to change after World War II. An influx of cheap, pulp mass media, and later the arrival of television, significantly altered visitor’s media preferences. To keep pace, we quickly assimilated within exhibitions; photographs to give objects a sense of time and place; posters to provide ambience and atmosphere; and electro-mechanical interactives to increase visitor participation. Since the 1940s, the discipline of exhibition design has further evolved to provide shape, form, and structure to these otherwise dissonant media. Importantly as the discipline matured, the role and value of objects far from diminishing, was enhanced. Traditionally, these media were deployed to enhance and enliven communication between museum objects and the visitor. Then in the space of 10 years video and personal computing technologies inculcated our homes and later museums. And together these dynamic media contrived to tip the balance away from artifactual learning environments. And together propelled contemporary museums to look to harness the exciting potential of interactive multimedia (IMM) learning environments. And, it is the most recent of these media arrivals, computer-based IMM and its assimilation, both within and beyond the Museum’s walls that I wish to explore. As we shall see this ubiquitous media has in a few short years had a profound impact on museums.

Within many it is now the pre-eminent interpretive and education media. And beyond the museum's walls—through the World Wide Web—it now provides museum educators and curators, with direct access to homes and classrooms around the world.

Computer-based IMM was born in the mid-1980s, when film, radio, and television converged with computers and gave rise firstly to videodisks, CDROMs, Internet and most recently high definition television. The first computer-based IMM appeared in Australian museums in the mid-1980s and now proliferate to a point where they constitute exhibitions in their own right.<sup>3</sup> The popularity of IMM is no accident and is just as much a consequence of museums' new visitor orientation as it is technological appetite. What attracts visitors and likewise museums is IMM's combination of interactivity and sensory appeal. It is now rare to find any display at the Powerhouse Museum without at least one IMM installation. However, as we move into the 21st century, the impact of IMM on the core business of museums is becoming more profound. Six years after the development of hypertext transmission protocol (HTTP),<sup>4</sup> museums all over the world clambered aboard the latest IMM juggernaut—the web. Museums' were willing to embrace the web for it offered the tantalizing opportunity to simplify and expand distribution networks, as well as lower costs for scholarly outreach. Most public museums in Australia are charged with the social responsibility of engaging as many and varied an audience as possible. Many of our museums are large, centralized entities situated in the middle of major cities and so they have had to tour exhibitions or publish and distribute their research, in order to capture these audiences. These are often expensive and time-consuming undertakings that in Australia are further hampered by the vast physical distances touring exhibitions have to traverse.

So it is not surprising that museums have embraced the World Wide Web. But as an epiphenomenon that cannot be meaningfully located in space or time, the web presents a unique set of problems to institutions whose very existence, is predicated on the primacy of the "real". Consequently, many museums are struggling to come to terms with a medium that is rapidly changing form demands they supplant aspects of their material and permanent selves, with that of the ephemeral, hyperreal, and transient. These demands are confronting as they seriously question whether or not the education and media practices, carefully crafted in the museum over the last 100 years, can or even should be, carried over into the realms of the virtual. In addition, museums are increasingly catering for the tastes and preferences of younger audiences. Many of these young people make few distinctions between mediated and primary experiences. Thus, for these particular audiences, museums are having to renegotiate the role and value of their collections in new digital domains. In so doing they are being forced to examine the effects of the voracious web medium on "the status of objects . . . and hence their authority to speak within a hegemonic system of representation."<sup>5</sup> What follows is an exploration of

one museum's journey, my museum, as we confronted these challenges. Looking back we, like many, had our fair share of successes and failures trying to design and deploy effective online learning environments. Drawing on these historical lessons from across the cultural sector an array of virtual learning typologies is beginning to mature. And many of these now exhibit cognitive strategies, affordances technologies, and original content, that I believe have considerable worth to others, outside of museums, charged with creating digital learning environments.

#### 1. AUSTRALIANS—EMBRACING THE WORLD WIDE WEB

The consensual hallucination imagined by William Gibson in his visionary text *Neuromancer*, is now a reality, with over 930 million people using the internet in 2004. As well as being a ubiquitous publishing, communication, design, and research tool, the internet has emerged as a powerful teaching medium. As such museums are not alone in exploiting this potential. However, the learning products and services they have created have been truly unique. This is a consequence of the distinctive partnership museums have forged with this epiphenomenon, where over 100 years of object-based teaching has melded with the interactive affordances of chat rooms, multiuser dimensions, news groups, e-mail forums, and videoconferencing technologies.

The term affordance was coined by the psychologist James Gibson to describe the potential for action, the perceived capacity of an object to enable the assertive will of the actor. The term is now commonly used, particularly in new media and industrial design, where it refers to an object or system that has been specifically designed to work with the intentions, perceptions, and abilities of users. Working within these parameters, good affordance technologies reduce the probability of confusing or non-productive user behavior. Thus, they specifically promote efficient, productive, and ultimately creative interventions by users. Technology and media are affordances to the extent that they promise extended human capabilities of seeing, hearing, and uttering.<sup>6</sup> However, as we have seen the successful deployment of these is predicated on an intimate understanding of user needs, perceptions, and abilities. However, the problem for museums, like many institutions, is that until recently we knew very little about our online audiences. Not surprisingly then many museums struggled to develop and deploy affordance technologies to support online learning.

Before, we can explore the history of museum web affordances, we need to acknowledge the differences between the web and the traditional museum as sites of communication. As a communication agent we should place the real museum in the same company as newspapers, photography, and cinema. Like these illusionary mediums, the traditional museum, (one not incarnate with IMM), is unidirectional. That is, its messages go one way from the museum to

the visitor.<sup>7</sup> In contrast, the web's combination of mimetic and collaborative affordance technologies, offer the possibility of delivering highly personalized information that can promote learning by engaging learners in a dialog of minds-on, problem solving.<sup>8</sup> In essence web affordances offer the exciting possibility of delivering a genuinely constructivist learning experience.

So not surprisingly the World Wide Web has captivated the imagination of many working in museums. As a communication medium the web allows educators and curators to enter the homes and schools of students without them ever needing to visit the museum. In 2004, over 13 million Australians surfed the Net and depending on age, between 40% and 60% used the internet to engage in some form of learning. Many chose to visit museum websites and last year the Powerhouse Museum received over 1.5 million unique visitors. It could be argued that all of these partook of a virtual learning experience by simply accessing the museum's website. However, a closer analysis of browsing preferences revealed some intriguing trends. The vast majority of our current virtual visitors used the website to help them plan a visit to the real museum. Only 25% are currently attending to education services to conduct online research or partake of a digital exhibition. However, this still represents over 300,000 visitors and compares to the 320,000 students and teachers currently visiting the Museum building and its exhibitions and programs. Significantly, the number of virtual education visitors is also growing by over 30% a year and so we are constantly looking to enhance the efficacy of our online education services. To achieve this has required a process of reinvention and self-exploration, as the museum has turned in on its self to find models, theories, processes, and work practices that could provide a way forward.

Next to the United States, Australians are the second largest user of internet services per capita. This enthusiasm continues a long tradition of embracing technologies that help straddle what we Australians fondly refer to as the tyranny of distance. By the turn of the century Australians had earned a reputation as prolific users of telegraphic services and by the early 1960s led the world in television consumption per capita. In the first 4 years of television in Australia, from 1956 to 1960, over 1.2 million Australians, out of a population of 10 million, purchased TV sets. This compares to the 2 million TV sets sold in the first 4 years of television in the U.S.A., from 1946 to 1950, with the U.S.A.'s population of 150 million.

The advent of broadcast television in Australia in the 1950s not only fed this insatiable appetite, but also fast-tracked the development of a domestic television production industry. And like the U.S.A. and Britain, early Australian television borrowed extensively from other older media like theater and radio, to create new and popular forms. From these, television consciously assimilated familiar formats and symbols, to develop program schema for news services, current affairs, variety shows, etc. Similarly early Australian education television consciously borrowed didactic instructional, as well as factual and interpretive questioning techniques, from traditional classroom teaching

practices. Over time these techniques were synthesized, adapted, and enhanced to form the basis of today's distinctive television genre.

And so history repeats itself. If we go back to the early days of the internet we see the very same process of recycling and assimilating the signs and symbols of older media. In the late 1990s, both formal and informal education sectors attempted to develop their own distinctive set of online education services, in large part based on their own teaching and learning heritage. Through this process museums began to develop a set of distinctive website typologies, which by the late 1990s had coalesced to form three basic typologies. The first of these, the *electronic brochure*, was primarily a marketing vehicle, whilst the other two were specifically designed to support informal learning.

## 2. THE EARLY YEARS—THREE MUSEUM WEBSITE TYPOLOGIES

The three major museum website forms of the 1990s made varying use of imagery, text, and interpretational techniques, much of which was originally created for the corporeal and its exhibitions and print publications. The most common form of museum website, then and still today, is the *electronic brochure*. Typically between 1 and 10 pages, these sites characteristically contained scant details, other than information on museum opening times, location, public programs schedules, and a basic collection overview. The market orientation of these sites was a derivative of the “just in case” reasoning espoused by the first wave of e-businesses. Just in case a visitor surfing the web wished to visit, then information was available to persuade them that their impulse could easily be realized. The major distinctive characteristic of these sites tended to be their reference to, and reliance on the real museum. These were websites that operated primarily to encourage people to visit and use the real museum. As such they rarely provided rich, or what could be described as learning environments. This function was wholly the preserve of the first-generation of museum *tour* and *interactive* websites.

*Tour* websites typically employed more complex information structures than *electronic brochures*, as they deliberately sought to simulate the informal education experience that one might encounter within an exhibition or gallery. *Tour* websites often used especially composed images and text to give an accented, albeit abridged overview of the museum. Typically, they attempted to provide a sense of the corporeal through expansive use of images of exhibitions. For this very reason the Powerhouse Museum chose this form, when it launched its first website back in 1997.

## 3. FIRST-GENERATION ONLINE LEARNING ENVIRONMENTS

In 1997, we estimated that internationally there were approximately 8000 other museum websites. Ambitiously the Powerhouse Museum set out to create a

site that would operate as more than just a promotional vehicle, and importantly offer regional, education outreach services. In addition the site was intended to fulfill an important institutional objective—to increase access to the museum's collection by establishing a representative virtual collection. In essence, the challenge for the site's designers was to use digital simulacrum of the museum's exhibitions, to allow virtual visitors to learn about Australian history, science, and design.

Despite the proliferation of online museums, few at the time had attempted to reconcile both intra-institutional collection objectives, simultaneous to providing education outreach services. In the absence of a suitable web model, designers turned to the real museum. This selection was naively based on our assumption that the web, like exhibition media, was simply a text and pictorially driven medium. Thus, it seemed by using labels and images originally created for exhibitions, it would be a straightforward task to simulate and place online all the museum's exhibitions. The primary vehicle we used to achieve this was a series of 200 captioned images of significant objects from our permanent collection.

Looking back the Powerhouse's decision to adopt artifactual images as signifier of the corporeal, demonstrated a fundamental confusion of reproduction and simulative media. By simply placing online images of artifacts the museum overlooked the fundamental pedagogical shifts that occur when artifacts are mediated, first by the camera and later by the computer screen. To the authorial intervention of the lens and photographer, is added the compromising intervention of at least two external, or user, determined factors. Back in 1997, the majority of the museum's web users, particularly in schools, utilized low resolution, small-scale (14") screens. In addition most were incumbered by second generation browser technologies that commonly distorted the layout of webpages. Together these contrived to significantly distort the appearance of artifacts onscreen. Reduced to such shallow simulacrum, it is inconceivable that this qualitative diminishment did not have an impact on the learning efficacy of these early digital collections. Museums are now acutely aware of this diminishment, but to this day struggle to find appropriate ways to represent collections. This is because a website devoid of digital artifacts calls into question not only the role and value of the real collection but the value of the museum's extensive teaching and learning heritage.

### **3.1. THE HERITAGE OF OBJECT-LESSONS**

For all but 8 of its first 100 years the Powerhouse Museum was a part of the New South Wales Department of Education. Thus, it was almost exclusively concerned with education, through the process of collecting, conserving, and displaying material culture. Epistemological interest in the use of objects in teaching and learning at the museum has a long and diverse history dating back

to the mid-1890s. At this time the approach to public teaching in Australia was in part predicated on the *tabula rasa* theories of learning, espoused in the writings of John Locke and Jean-Jacques Rousseau. The “object-lesson” was a feature of schooling across many curriculums and thus it is no coincidence that in the 19th century, small collections, cabinets, and museums were established in secondary education institutions,<sup>9</sup> and in the case of my museum in 1893, in the grounds of Sydney’s Technical College.

For over a century, object-based teaching has been central to Powerhouse education practice. However, our understanding of the complex interplay among visitor and object that gives rise to learning has changed markedly as epistemological and pedagogical research has evolved. From this a number of education theories have developed, of which the direct-experience-based model is the one most widely used, especially within the United States and European science and technology museums. Direct-experience-based learning divides our world into two distinct realms: the physical world where objects exist and events happen, and our minds, which are capable of memory and conscious thought. By allowing visitors to encounter real objects, labels, and a variety of media, museums traditionally immerse visitors in a physical world, where they see, hear, touch, taste, smell, and do. It is human nature that visitors should then seek to understand these direct experiences. This means they must use their minds to find regularities and relationships between these new primary experiences and existing concepts and principles.<sup>10</sup> The Powerhouse Museum is rich in such direct experiences. Parents and young children standing beneath our Boulton and Watt engine will hear and smell an 18th century steam engine, whilst a secondary school geography class, studying navigational aids, can examine the face of our Strasbourg Clock to elucidate how 16th century navigators used the stars to guide ships. These direct experiences with real objects, help visitors develop a range of skills from observation and reporting to deduction. According to Sue Wilkinson, real objects provide a concrete experience that illuminates or aids abstract thought . . . they are real rather than abstract, and thus they aid the memory . . . [and] may remain much longer in the mind than word or simple image gained facts, ideas, or reproductions.<sup>11</sup> Exponents of the direct-experience model contend that it is the tactile, spatial, and visual stimulus of these primary experiences that promotes learning by engaging visitors in ways that other methods and media fail to do.

Whilst I am not suggesting that it is impossible for the over 200 digital object images on the museum’s original website to have significantly contributed to some kind of learning experience, it is inconceivable that their lack of detail, inconsistent coloring, and loss of tactility, along with misrepresentation of scale and weight, would not have had some qualitative impact on learning. After all simulations and models are basically analogies, and are meaningful only if there is prior experience that allows the analogy to be understood. Take for example, the simulated Strasbourg Clock that back in 1997 appeared on the museum’s highlights page. Recently, reviewing the archive record I was



struck by the manner in which the web had compromised both the aesthetic and intellectual integrity of this magnificent object. Reduced to 72 dpi, unaccompanied by a volunteer's interpretive oration and scaled down to 1/200 of its original size, the digital facsimile bore little resemblance to the original. Looking back we can clearly see that these simulacrum are no substitute for the real thing. Indeed, they can be dangerous as they propagate false and misleading interpretations. Quickly we realized that some virtual objects, similar to some IT objects, are afflicted by a major interpretive dilemma, what in the text *Simulations* Baudrillard saw as the inevitable consequence of the eruption of the binary scheme. And in more recent times has become known in museums as the diminished authority of digital objects.<sup>12</sup>

### 3.2. THE DIMINISHED AUTHORITY OF DIGITAL OBJECTS

*The eruption of the binary scheme . . . renders inarticulate every discourse. It short-circuits all that was, in a golden age come again, the dialectic of signifier and signified, of a representing and a represented. It is the end of objects whose meaning would be function.*<sup>13</sup>

In *Simulations* Baudrillard riles against the captious forces of then emerging digital media. He warns that these will perpetrate confusing ambiguities that blur the distinction between object and representations and things and ideas. This confusion was apparent at a recent Loebner Prize. This AI competition challenges human judges to distinguish between natural language processing programs and people. Of the 10 judges, 5 believed that the winning DataFlex C++ program "Albert", was a 30 something Monty Python fan, hailing from Cedartown, Georgia, U.S.A. Such misreadings lend weight to Baudrillard's assertion that if left unchecked digital technologies propagate a potentially dangerous confusion of the real and the imaginary. What is more, the degree to which people will accept computer simulations as being equivalent, and in some cases preferable to, raw experiences, raises important questions concerning the relationship of virtual environments to the real world. And poses significant challenges for the traditional custodians of the real, namely museums. After all in a digital age objects, images, and resources all have equal status. But critically—as we have seen—they are not all equally valuable.

As well as being cognizant of the diminished authority of digital objects, the Powerhouse Museum's current web design has learnt further lessons from these early experiments. Just as we are now acutely aware of the need to carefully construct digital representations of our collection, we are also mindful of the imperative to better understand the needs and motivations of learners. The museum's preference for the *Tour* form back in 1997, was in part based on the promise it held out to meet the perceived needs of students, teachers,

historians, and academics, and specifically those that had never visited the museum before. In attempting to place on line an overview of the museum's exhibitions and collections, we had sought to overcome the geographical and logistical obstacles we assumed had hindered them from visiting the museum in the first place. Fundamentally this approach presumed that people in the past that had been unable, or unwilling to attend the real museum, would instead find the virtual compelling. What is more the kinds of learning environments we naively developed for their consumption, took as their primary metaphor, the exhibition. Of course, we now know that the social and the cognitive complexity involved with a visit to a real exhibition cannot in its entirety be replicated online. As Falk and Dierking observed when defining the parameters of an effective educational visit, each is determined by the visitor's unique personal, physical and social attributes, and contexts. Each one of which is mediated by senses engaged by the material reality of the visitor's social and physical surroundings. Thus, the direct replication of real with virtual experiences is a questionable undertaking. After all would we accept that a family visit to the Louvre could be reasonably simulated and replaced by a television documentary? We know that it cannot. However, there are attributes of the television documentary which are unique and privileged, even above that of a real visit. A television camera can take us inside the working components of an exhibit, or provide an expert oratory taking us behind-the-scenes of an exhibition. It is these privileged affordances, often unique to individual media that we are now aware, must be sought to create effective online learning experiences.

Looking back it is easy to see how many frustrated by the web's perceived lack of sophistication, retreated to the safe, and familiar territory of their collection. However, these primitive learning affordances were not a barrier to all cultural institutions. And significantly many of the early pioneering works that did emerge were not conceived by either museums or galleries, but science centers. Science centers are primarily concerned with the teaching of scientific principles and theories through instructive technologies and few if any use artifactual collections. One of the most innovative was and still remains, the Exploratorium in San Francisco. In the late 1990s, the Exploratorium provided an important lead in the search for effective online learning models and was a pioneering exponent of the first-generation of *interactive* websites.

The Exploratorium sits adjacent Bernard Maybeck's masterpiece The Palace of Fine Arts, in a pavilion left over from the Panama-Pacific International Exposition of 1915. Within it are housed 200 exquisitely crafted mechanical and electro-mechanical interactives and it was to these the Exploratorium turned for inspiration. In essence, the Exploratorium recognized that even within the then limited affordances of the web it was still possible to create a set of basic, but compelling interactive learning experiences. The result was a website structured around a series of web-cast programs and internet chat rooms. In August 1999, the Exploratorium dispatched a team to Turkey

to film a solar eclipse. Hearing of this I visited the site and eavesdropped on a group of science teachers watching the eclipse unfold. I was enthralled to see how images of a solar eclipse could generate such animated and rich exchanges. In the same year, the Exploratorium conducted a series of web casts on the occasion of the 10th anniversary of the Loma Prieta Earthquake, and later hosted a web-cast program on the science of wine.<sup>14</sup>

It is now difficult to appreciate what a breakthrough the Exploratorium's early experimental web programs represented. But inspired by these achievements and supported by a maturing web medium, this relatively simple *interactive* form has, as we shall see, quickly burgeoned into an array of complex online learning typologies. In part these relatively new metacenter; creative play; electronic field trip; learning network; and videoconferencing forms, have emerged on the back of new web programming and animation technologies. Chief amongst these are Flash programs that for the first time are allowing the interactive microworlds created online, to also be used within exhibitions. In essence these programs are breaking down the distinctions, between the real and virtual museum. However, it is no accident that when we examine the operation, structure, and education effectiveness of these contemporary online learning experiences, we find yet again that they are unique to the cultural sector. This time instead of aping collections and exhibitions, they have sourced the forms, concepts, and theoretical approaches, found in computer-based IMM, which now thrive within many museums.

Since the pioneering work of McLuhan and Parker in the 1960s, museums have recognized the value of creating media rich, stimulating environments for visitors. This awareness spurred the development of a specialist design trade, one focused on the creation of mechanical, electro-mechanical, and more recently computer interactive installations. In part the emergence of this new IMM design discipline in museums, paralleled the rise of mass media within western society and shifts in our appetite away from textual, toward visual literacy forms. Importantly, for this polemic in order to fully understand how museums have arrived at their current array of web-based learning environments, it is imperative to understand what makes the task of designing interactive experiences within museums unique. It is only when we can comprehend the challenges designers face creating computer-based IMM within museums that we can understand how these have come to influence the unique IMM learning environments museums now deploy beyond their walls.

#### 4. INTERACTIVITY WITHIN THE MUSEUM'S WALLS

IMM is neither a specific technology nor a product. Instead it is a visual communications system; a mechanism of delivering information in intuitive, predominantly graphic ways. However, it is neither the aestheticism nor quality of its images that have helped it usurp the role of traditional pictorial or text

media. Rather it is IMM's unique malleability, editability, or what we more commonly refer to as interactivity. The animations, photorealistic images, and special effects that dominate contemporary IMM are dynamic. That is they provide an active stimuli that elicit responses, which in turn changes either audio or visual content. As such interactivity in museums is not just about person to machine dialog, but also refers to the exchanges that take place amongst museum visitors. It is the essence of human communications, an essential ingredient of face-to-face teaching and learning.<sup>15</sup>

Whilst this face-to-face interactivity remains an important component of the museum visit, nowadays this is not the kind of interactivity that many, particularly younger visitors, seek in museums. They are much more concerned with automated or mediated interactivity. Mediated interactivity in museums has been popular since 1969,<sup>16</sup> when McLuhan and Parker first demonstrated how new communication technologies could enhance visitor participation in exhibits. They asserted that visitor understanding and interest in linear artifactual story lines was limited. This discovery marked a turning point in curatorial and exhibition design practice. To increase visitor interest they advocated bombarding visitors' senses with a variety of media to stimulate them into absorbing more information. Critically, McLuhan and Parker's faith in IMM was not merely as an entertaining alternative to artifacts. Rather they believed it operated in ways that reflected how people think. This was not the first time this fit between cognition and media operation had been articulated. Vannevar Bush's seminal article, "As we may think"<sup>17</sup> was the first to raise the idea of using IMM technology to help us learn. In it Bush described a fictitious machine called the MEMEX which would allow a user to quickly and easily access any information they needed through an intricate web of associative links. Bush envisioned the MEMEX to be a multimedia machine equipped with a keyboard and microfilm reader. Importantly, it could store and link vast amounts of information in the same way he understood people to think, that is by association. With one item in its grasp, it snaps instantly to the next that is suggested by the association of thoughts, in accordance with some intricate web of trails carried by the cells of the brain.<sup>18</sup>

This associative analogy to learning is one of the main reasons why IMM has become so popular in museums. However, it is an oversimplification to state that all IMM technologies have manifestly the same learning or entertainment potential. It would be like suggesting that cinema and television operate identically as they share a common audio and visual form. As semiotics and psychology have so ably demonstrated, the social, narrative, and structural symbolism of cinema and television are fundamentally different. Similarly, it is an oversimplification to assume that there is one discrete set of lessons museums have learnt developing IMM. The assumption that all museum-based IMM and the web are similar and thus techniques interchangeable is a compelling one. But this interchange is predicated on a perceived parity between internal and external computer use. That is computer-based IMM in the

corporeal, has the same function and attraction to visitors as that of the web. Nowadays, there is an increasing awareness that this is both a simplification of the complexities inherent in museum-based IMM, and at the same time overlooks the sophistication of contemporary web affordances.

An interactive exhibit is a device in which the visitor's response . . . produces a change in the exhibit<sup>19</sup> and is explicitly designed to focus visitor attention and therefore increase their interest. Although Bitgood limits his definition to physical rather than mental interaction, his three categories of interactivity are those we still use to classify exhibits in museums. These are *Hands On*, *Participatory*, and *Interactive*. Simple *Hands On* refers to exhibits like the "Touch and Feel" children's trails found throughout the Powerhouse Museum. Here, we utilize clothing swatches and fake animal fur etc., to provide visitors with tactile feedback. Alternatively, those interactive experiences Bitgood describes as *Participatory* are designed to intellectually stimulate visitors to make comparisons between their own instinctive responses and those of a programed norm. An example of this type is an activity that invites visitors to identify an advertizing jingle. Here, an audio loop from a television advertizement is activated by a visitor who is invited to select the product they think was advertized by the jingle. An unsuccessful selection results in a pre-recorded voice asking the visitor to try again. This kind of *Participatory* experience is the most common found throughout contemporary museums and currently makes up over three quarter of all the Powerhouse Museum's interactive installations.<sup>20</sup>

Of critical importance when considering the popularity of the *Participatory* model within museums is that its selection is driven by the practical considerations of how museum educators want visitors to use IMM in museums. Because within physical exhibitions there are often space considerations, which limit numbers of interactive installations, controlling the time any one visitor spends on an interactive is important.

In part the popularity of the *participatory* model within museums is a consequence of their structured approach to knowledge creation i.e., philosophically they are explicitly instructional (also known as Objectivism) devices. Consequently, they tend to have closed-architectures, where interactive dialog is deliberately curtailed to arrive at a set of pre-conceived outcomes. However, since Jonassen's paper *Objectivism versus Constructivism*.<sup>21</sup> The education effectiveness of such instructional perspectives has been seriously questioned. Jonassen argued that in attempting to simplify learning in order to improve instructional efficiency and effectiveness, instructional systems may be short-circuiting the relevant mental processing required in learners. Jonassen also believed that if designers continued to simplify learning they risked ignoring its inherent complexity.

In the last 10 years an alternative teaching and learning philosophy has emerged within museums to challenge instructional IMM design—constructivism. As a faction within cognitive psychology, associated with Piagetian learning theory, constructivism is characterized by discovery and

experiential learning. Rather than attempting to map an external reality onto learners, constructivists attempt to assist learners to construct their own conceptual framework. Those museum educators and designers favoring the constructivist approach have sought to tap the computational power of modern personal computers, to create environments in which learners can experience and develop sophisticated ideas from a variety of domains. As a consequence of the extensive in-built choices and diversity that these systems require, constructivist IMM exhibits, or what Bitgood describes as truly *interactive* installations, are still rare within museums. At the Powerhouse Museum there are few that support a truly dynamic dialog between visitor and display.<sup>22</sup>

##### 5. RECONCEPTUALIZING THE COMPUTER—FROM TOOL TO MEDIUM

Despite McLuhan's and Parker's contention that IMM operates in ways sympathetic to how people think, it is often unclear exactly what computer-based IMM adds to a museum visit. Do they or could they enhance existing interpretive practices by making learning more effective? Can they lead to new educational paradigms in which the traditional roles of curators and visitors are reversed? Common to these questions is the metaphor of computer as tool. As a tool the role of the computer in the museum is to help visitors learn and enjoy by creating something, including the solution to a problem. However, as with *participatory* IMM, the dynamics of the interactive process are often constrained. This is because designers of IMM in real museums often have to work within the technological confines of existing software and hardware, and the attention-span and time constraints of visitors. Thus as we have seen, designers often have little choice but to adopt closed-architectures. Consequently, visitor experiences of most computer-based IMM within exhibitions are characterized by a set of discrete and limited outcomes that ordinarily have limited interactive or communication potential.

It is this re-conceptualization of the computer and with it the web, as a communication rather than unidirectional presentational medium that has begun to take place beyond the museums walls. Viewed as a medium, the computer can enhance the very nature of how and what we communicate. Critically such a re-conceptualization also allows the museum to cross-over into the constructivist arena of online learning. As a medium the computer not only facilitates inter-subjectivity, that is communication between learners, but also intra-subjectivity, which is, communication between the learner and him/herself.<sup>23</sup>

As we have seen museum web developers face a dilemma. Whilst artifactual simulacra modeled on the real museum can be ineffectual, simulacra modeled on computer-based IMM are also problematic. Whilst their multimedia content and dynamic interactivity are certainly improvements, the inherent objectivism of most *Participatory* models limit their usefulness online. So where if anywhere can the museum turn for an effective model? In truth there

is no single model and instead museums have assimilated all these interactive archetypes, along with their object-based learning heritage and constructivist aspirations, to create a series of hybrid learning environments.

## 6. LEARNING ENVIRONMENTS BEYOND MUSEUM WALLS

Since the privatization of the internet here in Australia in 1995 museums have increasingly sought to use the web to service the learning needs of predominantly secondary school students. To do so they have harnessed the communication affordances of personal computers, *via* the web, to create a plethora of learning environments. These environments strive to attract and hold students by supplanting the inherent pedagogically weak “digital object” with more engaging interactive experiences. This shift away from artifacts has liberated many museum educators who can now concentrate on the development of education products, at the center of which are not just objects, but students themselves. For evidence of this shift one need look no further than the education winners of the Best of the web. In 1998, the *Odyssey* website ([www.cc.emory.edu/CARLOS/ODYSSEY/index.html](http://www.cc.emory.edu/CARLOS/ODYSSEY/index.html)), utilized museum object images and stories to “inform” students of the daily life of Middle Eastern and sub-Saharan peoples. In 2003, the Smithsonian Institute’s “Campfire Stories with George Catlin” website, ([catlinclassroom.si.edu/](http://catlinclassroom.si.edu/)) equipped students with research tools to interrogate and extrapolate historical data to help them build personalized interpretations of the life of Native Americans in the early part of the 19th century. This shift from seeing the web as an information medium, to that of a dynamic learning environment, now abounds. Now more than ever, museums are creating web-based learning environments within which users, not just educators, are empowered to make decisions about the tasks, content, navigation, presentation, and assessment activities they undertake. Thus, it is not surprising that a diverse range of learning web typologies has begun to emerge. These typologies range from mature education meta-center products, which continue to utilize digital object images and records, through to expository resources. As we shall see what distinguishes one typology from the next is not just content and affordance technology, but also the cognitive strategies each employs. These are the generative, problem-based, creative play, and expository methodologies that assist learners to build on their own knowledge structures (schema) in order to construct new knowledge and understanding. As we have seen many of these schemas are consciously, and sometimes unconsciously, borrowed from the experiences of the designers and educators in the real museum.

### 6.1. EDUCATION METACENTERS

Of the six museum education typologies currently identified, Education metacenters, along with Creative play environments, are still predominantly

concerned with teaching and learning via museum objects. However, best practice in both is now exemplified by activities that subjugate the diminished authority of digital objects. Most now utilize complex Online Public Access Catalogues (OPAC), to provide access to collection images and information. However, we appreciate that the mere accessibility of raw data alone does not in itself guarantee learning. And in order to move beyond the limitations of objective physical form and function, museums have augmented artifacts with affordances that empower users to create useful intellectual content. To accomplish this many education metacenters utilize interrogational tools with which students can convert raw data into useful and highly personal knowledge products. A good example is Museum Victoria's *Butterfly* site ([www.museum.vic.gov.au/bioinformatics/butter/](http://www.museum.vic.gov.au/bioinformatics/butter/)). This website allows middle and upper high school students to access a database of 40,000 Victorian butterfly records via seven discrete searches. Each search is designed for students of a particular age, studying a specific syllabus. At the culmination of each search, students undertake a series of comparative activities that allow them to mentally experiment (generative) by overlaying data sets. In *Butterfly*, this generative experience is supported by a java-based mapping tool. This application allows species distribution data to be overlaid onto vegetation, altitude, river, and zoogeographic information. The result is a unique schematic of species and topological data, which students can endlessly modify and interrogate. Potentially this allows them to develop learning outcomes built around their own interests, which in turn can result in a deeper conceptual understanding and affinity with the subject.

## 6.2. CREATIVE PLAY ENVIRONMENTS

It is a peculiar anomaly that nearly all online museum learning environments are targeted at secondary and tertiary students. Disappointingly there are few museums developing learning environments for under eights. One of the exceptions is the Museum of Modern Art, New York (MOMA). MOMA has led the way with the development of online resources for this age group and through their website, *Art Safari*, has helped define a learning approach I call Creative play. *Art Safari* ([artsafari.moma.org/](http://artsafari.moma.org/)) uses paintings and sculpture from MOMA's collection to help children develop their observation skills. *Art Safari* has been specially designed with activities that encourage students to examine and creatively respond to the forms, stories, and characters that populate the artworks of Rousseau, Kahlo, Rivera, and Picasso.

Early childhood learning research points to the value of activities that stimulate and support creative play. Creative play is an important part of young children's learning and describes those experiences that encourage them to explore and test ideas through the process of making. Most project-based websites offer some degree of creative play if they allow students to create original written or oral compositions. However, for young children drawing



and painting-based activities are often the most effective. *Art Safari* supports this kind of activity by helping children draw a portrait of a pet or fantastic animal, using a downloadable palette. Young children find this specific activity very stimulating, particularly as it allows them to explore subjects that are close to their hearts. Pets, parents, brothers and sisters, etc. are all subjects of deep personal interest to young children, and when combined with creative play, excite children to keep on investigating, listening, talking, designing, constructing, asking questions, reading, and writing.<sup>24</sup>

### 6.3. ELECTRONIC FIELD TRIPS

Where Creative play learning environments are ideal for helping develop observation and hand eye co-ordination skills, electronic field trips are best suited for teaching complex cyclic or relational concepts, by immersing students in credible microworlds. Credible microworlds convincingly “transport” students through time to historical sites; through space to the museum; or through their imagination to fictitious and fantastic worlds. The effectiveness of this transportation is in part dependent on the utilization of audiovisual materials and interactive technologies to realistically simulate an experience or environment. Be they imaginary planets, tropical rainforest or a civil war battlefield, all these microworlds need to not only capture the attention of students, but also engage them in activities that are stimulating enough to sustain attention for long periods of time. To achieve this, many *electronic field trips* utilize anchored instruction techniques.

Anchored instruction activities borrow extensively from *participatory IMM* from within the museum and utilize sets of interconnected problems to encourage users to activate their reasoning, deduction, and investigative faculties. An excellent example is Brookfield Zoo’s *Go Wild* field trip ([www.brookfieldzoo.org](http://www.brookfieldzoo.org)). *Go Wild* challenges students to overcome the problem of finding a safe way through the Ituri forest of central Africa. To help solve this problem developers have provided four avatar guides who drive the narrative by bombarding users with questions. As with all anchored instruction activities, *Go Wild* challenges are based on real problems, be it using a compass and map, making bark cloth or choosing suitable forest foods to eat. The realistic nature of these problems is imperative, as it can encourage students to take ownership of their dilemma, and in turn, responsibility for actively overcoming their problems.

### 6.4. VIDEOCONFERENCING

Like electronic field trips, videoconferencing activities utilize the connectivity of the web to transport students and teachers beyond their classroom or home.

However, unlike current electronic field trips, videoconferencing can utilize synchronous affordance technologies to connect students and teachers to the real museum's staff and exhibits, in real time. Here, the microworlds created are not based around animations, but utilize the performances and "scenery" of staff and exhibits. And ultimately it is the photogenic nature of these displays, together with the affability and open-endedness of the student presenter dialog, which determines the level of meaningful engagement.

Videoconferencing consciously builds on the breakthrough web-cast work of the Exploratorium and similarly is dependent on the availability of significant bandwidth. For maximum image quality and minimum image lag, museums ideally have to access high-speed networks, like that of the New Jersey Department of Education's Distance Learning Network. This statewide ISDN/ATM network allows schools from across New Jersey to link to the state's principal science center, the Liberty Science Center (LSC). As well as specially equipped videoconferencing facilities, students can access LSC exhibits *via* a series of e-connection programs, e.g., the aquatic ecosystems package. This videoconferencing activity links a class of upper primary students studying river ecosystems to a biologist based in the LSC's Hudson River aquarium. After a brief introduction a camera scans tanks of toadfish, eels, and spider crabs. A series of carefully choreographed activities follow to prompt students to ask questions about the habitat and behavior of each species. Quickly a dialog begins as the biologist moves from presenter to conversation facilitator. As well as the presenter's conversational ability, their in-depth knowledge is essential if a rich and open-ended dialog is to ensue. To achieve this, research has demonstrated that digital resources need to be sophisticated enough to: (1) encourage children to respond in thoughtful ways; (2) offer response to children's answers; (3) offer variations that are child-controlled; (4) cater for individual children's ability, cognitive development, and computer skills; and finally (5) take into account the child's cultural background and language competencies.<sup>25</sup> For all these reasons human facilitation of genuinely open-ended learning experiences is irreplaceable.

## 6.5. MUSEUM LEARNING NETWORKS

In internet terms, museum learning networks have been around for a relatively long time. But surprisingly they have yet to flourish. The problem is that most museums are still pre-occupied with developing resources for independent students working either from home or within a classroom. This is understandable as the complexities of building resources to accommodate multiple and simultaneous learners are considerable. Learning networks characteristically provide aggregated access to an array of field trip and expository resources, themed around a single discipline like science, contemporary art, or environment. In 1996, 12 science centers from across Asia, Europe, and the Americas

pooled content and expertise to develop the Science Learning Network (SLN). Within SLN ([www.sln.org/](http://www.sln.org/)), students are able to conduct a series of genetic, solar, aviation, and oceanographic experiments or participate in one of three collaborative projects. One of the most popular is *Monarchs and Migration* ([www.sci.mus.mn.us/sln/monarchs](http://www.sci.mus.mn.us/sln/monarchs)).

Conceptually, *Monarchs and Migration* uses the natural phenomenon of migration to encourage an international community to build a rich textual, artistic, and photographic record of Monarch butterfly migration. Students in the U.S.A., Mexico, New Zealand, and Australia, use online picture galleries and tracking tools, to share observations and photographs of migrating butterflies. However, whilst offering excellent content and tools, *Monarchs and Migration*, like many learning network activities, is still limited in the genuinely collaborative opportunities it offers.

Over the last 10 years museum researchers, including Falk and Dierking<sup>26</sup> and Uzzell<sup>27</sup> have successfully demonstrated that families and children in school groups, use *real* museums as important collaborative learning environments. In 1993, Uzzell published the results of a series of museum visitor studies, which compared and contrasted the accuracy of students working alone to those in groups. Uzzell observed that group performance was significantly superior to individual performance. Uzzell found the social interaction and exchanges facilitated in groups allowed students to move beyond individual experience and could equip them with the accumulative interpretations of others. The scope and value of this co-operative learning approach is only just beginning to be acknowledged by educators working online. Jamieson MacKenzie's Virtual Museum<sup>28</sup> project for upper-secondary students is one which led the way in using asynchronous and synchronous IRC, see-you-see-me and e-mail technologies to encourage collaborative problem solving. Already his research is pointing to the education potential of a number of specific collaborative activities, including information searches, electronic process writing, and sequential creations. All these are activities that foster co-operative solution finding, through continuous communication. Ideally, this kind of collaboration is best facilitated *via* face-to-face meetings, or in chat rooms, within which the process of creating a joint product is negotiated. An excellent example of a museum-facilitated, collaborative learning experience can be found on the National Museum of Science and Industry's STEM (Students and Teachers Educational Materials) website. (<http://www.sciencemuseum.org.uk/education/stem/stem/stemintro.asp>).

The STEM project is a learning network with a difference. Instead of museum educators and curators producing content, students and teachers do this work. Students and teachers who visit one of the National Museum of Science and Industry's three museums are invited to compete with one another to create a web resource based on their visit. Invariably those teachers and students that take up the challenges, work in teams both real and virtual. In this way, STEM students create products that explore issues, ideas, and problems that

have their roots in their own unique experiences, interests, and opinions. As with any learning activity, given the opportunity to directly control content, students are much more likely to be internally motivated to explore issues and ideas close to their heart. The bonus is that these very same issues are much more likely to be of interest to the resources' intended audience—other students.

#### 6.6. EXPOSITORY TEACHING ENVIRONMENTS

Often found on science and technology museum websites, the closed architectural approaches of expository teaching resources are analogous to in-house *participatory* IMM. Primarily developed for children 12 or younger, expository resources ordinarily comprise a series of highly structured, computer-directed activities, through which a set of principles, laws, or theories are taught (expository). The Australian National Science and Technology Centre's *Funzone* is typical. *Funzone* ([http://www.questacon.edu.au/fun\\_zone.html](http://www.questacon.edu.au/fun_zone.html)) features a series of Flash-based puzzles, activities, and laboratories, wherein students can conduct web-based experiments. One of these experiments asks students to observe a series of animated lines moving across a screen. After 60 seconds the lines stop moving, however students observe a motion-after-effect. That is the lines “seem” to continue to move across the screen, because their brain is so accustomed to the movement.

Interaction with other students, and the Flash animation itself, has been deliberately constrained in *Funzone*. Where this may seem at odds with constructivist learning principles, these “closed” learning resources are not without merit. Potentially they can alleviate some of the metacognition problems often encountered by young children. Metacognition problems can occur when people lose sight of, or can no longer accurately monitor, the success or failure of their own learning because activities are not stimulating, or are too complex. A number of studies have indicated that metacognition problems can also arise when students fail to develop clear-cut learning goals because they are given total control of learning experiences. However, metacognition problems can be addressed through careful navigation and interface design, coupled with rigorous remedial evaluation.

Therefore, the dilemma for expository environment developers is to find solutions that accommodate both a student's explorative preferences and need for learning guidance. Whilst there are no easy answers, one possible approach is to try to enrich “experiments” with layers of additional activity. In the case of *Funzone*, students could have been offered extension exercises, wherein different colored lines, or lines moving at different speeds, could if the student desired, have been introduced. This kind of “value adding” to expository resources has the potential to lessen the likelihood of metacognition problems as it supports limited student exploration. Critically, this layering also has the

potential to expand student understanding, as it clearly defines the limitations within which phenomena such as motion-after-effect operate. An excellent example of this kind of expository layering is the National Museum of Australia's *Ann Fibian* website <http://www.nma.gov.au/education/ann/index.htm>). Here students investigate soil erosion and deforestation phenomenon via a series of expository activities. Critically these activities provide the student with a set of incrementally more challenging exercises, or alternatively the ability to opt out at any time. Either way valuable results emerge from the interaction.

#### 6.7. DO THEY WORK?

As these typologies demonstrate, there is no such thing as a sure fire way to guarantee learning or teaching, only methods or devices which together facilitate the individual's endeavor.<sup>29</sup> Indeed, the deployment of any one of the cognitive strategies discussed is not in itself a guarantee students will mindfully attend to any of these activities. The best museum educators and designers can do is to carefully combine pedagogically appropriate content and affordance strategies. But even then we recognize that learning is still a process beyond the total control of museums, and one predominantly invested in the learner herself. So even when this mix has been carefully prepared, work can still be undone by the relatively unknown impact of users' unique cognitive, environmental, and cultural characteristics. This is why it is imperative that we continue to support research activities, particularly remedial and summative evaluations. Without these we have little chance of building understanding and ensuring the efficacy of future online learning environments.

Where the responsibility to better understand learners and their needs is incumbent on all of us working with IMM, museums have another particular responsibility if they are to negotiate this challenging period. If museums are indeed to make a successful transition from predominantly artifactual, to IMM learning environments, they will need to continue to renegotiate and reinvent the role of the artifact. I do not believe that these two learning environments are mutually exclusive because the increasing virtuality of our world seems to demand its own counterpoint in the materiality of those objects that have withstood time. Far from diminishing, the multiplication of IMM will surely intensify the need for emblematic objects that signify the extraordinariness and ever-rarer primary human experiences. This desire I believe will secure the future of object-orientated museums. However, I am not so conceited to take this for granted. For in an increasingly mediated world there is little doubt that *virtual* museums will continue to thrive alongside the *real*. But is this separation sustainable? When I look at our current crop of learning environments, I suspect not. So long as we continue to allow learning typologies, particularly the electronic field trip and videoconferencing forms, to evolve in the absence of a collection, then I suspect we could be left with rather shallow simulacrum.

That is why from a cultural historian's perspective, it is imperative that we continue to find affordances that reuse, recycle, and revisit the intellectual capital of museum collections. If we cannot I wonder what if any useful role virtual museums will play in increasing society's knowledge and understanding?

#### ENDNOTES

1. From Alexander, 1979.
2. Foucault, 1986.
3. Museum of Victoria's Science works exhibition *Cyberzone* did not contain a single object, but instead incorporated over 40 multimedia interactives. (Toured Australia 1996–1999.)
4. HTTP is the principal enabling technology of the World Wide Web. Work on HTTP began in 1989 at CERN, a particle physics laboratory in Geneva, Switzerland.
5. Witcomb, 1996.
6. Ryder & Wilson, 1996.
7. Gere.
8. Hein, 1989.
9. Busse, 1994.
10. David Ausbel and colleagues defined “meaningful learning” as the linking of new information to existing concepts and principles in a learner's knowledge structure. The network of relationships formed during this process enables a learner to recall learned material after extended periods of time and apply the material to new situations or problems. From Ausubel et al. 1978.
11. Wilkinson, 1990.
12. Swade, 1991 first used this term to describe the diminished authority of some contemporary IT objects. Because of their small scale and abstraction, Swade identified that many objects like microprocessors, posed particular difficulties for curators and visitors to understand.
13. Baudrillard, 1981.
14. Jim Spadaccini's (2000) article *Creating Online Experiences in Broadband Environments* discusses in detail the technical challenges of these early Exploratorium programs.
15. Nash, 1992.
16. Alexander, 1979.
17. Bush, 1945.
18. *Ibid.*
19. Bitgood, 1991.
20. Even here there are diverse ranges of *Participatory* typologies. Two of the most common are what the International Council of Museums Multimedia Working Group; refer to as *Explainer* and *Emotive* trigger

presentations. *Explainer* multimedia technologies typically explain or interpret specific exhibits or gallery themes and include monograph collections of textual and visual information, hierarchically arranged. Alternatively *emotive* trigger multimedia are much less concerned with the interpretation of specific ideas or objects, than they are with eliciting emotional responses or providing ambience. From Davis and Trant (1996).

21. Jonassen, 1991.
22. Currently our *Make a firework* installation in our chemistry exhibition is the only interactive that comes close to fulfilling Bitgood's criteria. Here, visitors use a database to build 1 of 6 different fireworks from 22 different ingredients. A computer provides a range of choices and combinations of chemicals and despite the seeming endless potential outcomes, the program only partially supports a continual and changing dialog.
23. Repenning et al.
24. Downes et al., 1999.
25. *Ibid.*
26. Dierking and Falk, 1994.
27. Uzzell, 1993.
28. See MacKenzie's detailed discussion of the project at <http://fromnowon.org/FNOJan95.html>.
29. Whalley, 1995.

#### REFERENCES

- Alexander, E. (1979). *Museums in Motion, An Introduction to the History and Functions of Museums*. Nashville: American Association for State and Local History.
- Ausubel, D. P., Novak, J., & Hanesian, H. (1978). *Education Psychology: A Cognitive View*. New York: Holt, Rinehart & Winston.
- Baudrillard, J. (1983). *Simulations*, Foss, P., Patton, P., and Beitchman, P. (Trans.) New York: Semiotex (e) Inc., 122 (original work produced in 1981).
- Bitgood, S. (1991). Suggested guidelines for designing interactive exhibits. *Visitor Behaviour* 4.
- Bush, V. (1945). As we may think. *Atlantic Monthly* 176, 101–108.
- Busse, G. (1994). *Museum Education from The Educational Role of the Museum*. London: Routledge, 231 (quoted in Eilean Hooper-Greenhill).
- Davis, B. & Trant, J. (Eds.) (1996) *Multi Media in Exhibitions—Introduction to Multimedia in Museums, A report by the International Council of Museums Committee on Documentation*. (ICOM/CIDOC) Multimedia Working Group, The Hague, The Netherlands.
- Dierking, L. D. Falk, J. H. (1994). Family behaviour and learning in informal science settings: a review of the research. *Science Education* 78(1), 57–72.
- Downes, T., Arthur, L., Beecher, B., & Kemp, L. (1999). *Appropriate EdNa Services for Children Eight Years and Younger*. Education Network Australia. Available at: <http://www.edna.edu.au/EdNA>.
- Foucault, M. (1986). Of Other Spaces. *Diacritics* Spring, 26.
- Gere, C. (1997). Museums, Contact Zones and the Internet. Available at: <http://www.hart.bbk.ac.uk/~charlie/ICHIM.htm>.

- Hein, G. (1989). *Learning in the Museum*. Routledge, London, 34.
- Jonassen, D. H. (1991). Objectivism versus constructivism: Do we need a new philosophical paradigm? *Educational Technology, Research and Development* 39(3), 5–14.
- Nash, C. J. (1992). Interactive media in museum: looking backwards, forwards and sideways. In: Kavanagh, G. (Ed.) *Museum Management and Curatorship*. London: Routledge press, 172.
- Repenning, A., Ioannidou, A., & Ambach, J. (1998). *Learn to Communicate and Communicate to Learn*. Department of Computer Science and Centre for lifelong Learning and Design, University of Colorado, Boulder.
- Ryder, M. & Wilson, B. (1996). Affordances and Constraints of the Internet for Learning and Instruction. *Association for Educational Communications Technology Conference*, February 14–18, 1996, Division of Learning and Performance Environments Research and Theory Division, Indianapolis.
- Spadaccini, J. (2000). *Museums and the Web 2000: Proceedings, Archives and Museum Informatics*, 53–58.
- Swade, D. (1991). *Museum Collecting Policies in Modern Science and Technology Museums*. London: Science Museum.
- Uzzell, D. (1993). Contrasting psychological perspectives on exhibition evaluation. In: Bicknell, S. and Farmelo, G. (Eds.) *Museum Visitor Studies in the 90s*. London: Science Museum, 125–129.
- Whalley, B. (1995). Teaching and learning on the Internet. *Active learning Journal* (Institute for learning and Teaching in Higher Education, U.K.) (2).
- Wilkinson, S. (1990). *A Teacher's Guide to Learning from Objects*. London: English Heritage, 5.
- Witcomb, A. (1996). Museums and Electronic Technologies—the end of the Mausoleum, *Museums Australia Conference*, Darling Harbour.



## Chapter 35: Genealogical Education: Finding Internet-Based Educational Content for Hobbyist Genealogists

KYLIE VEALE

### 1. INTRODUCTION

The hobby of genealogy is today one of the most popular leisure pursuits for everyday people. Not since the mid-19th century's period of fluctuating genealogical popularity (Taylor & Crandal, 1986) have we seen so many people in the western world tracing their family tree. In the United States alone, Maritz reports a rise in genealogical interest from 45% in 1996 to 60% in 2000 (genealogy.com, 2000), and since that date, the figure has been steadily rising to 75% in 2003 (Pew Research Centre, 2004). Not only are people of all ages, from all over the world, adopting the hobby as their own, many (Hornblower, 1999; Tedeschi, 2001) report that millions of genealogists use the internet for their research. Although, as Wellman and Haythornthwaite (2003) declare, the internet has grown to be of common use in our everyday lives, it has also "revolutionised genealogy" (Willard & Willard, 2001); a catch phrase utilized no less than four thousand times on the internet.<sup>1</sup>

Genealogy is the science of studying family origins, generally utilizing pedigrees. A genealogist is, at the very minimum, one who collects vital statistics about birth, marriage, and death events and organizes these facts into pedigree charts and family trees. The hobby can be a personal endeavour and social phenomenon; though it is also extremely methods- and learning-based; a fact-finding and information-seeking pursuit requiring knowledge in family structures, life records, history, and methods. This education need is generally not satiated by reading one book or attending one course; genealogical education is constant (Hinckley, 2003a). In fact, the hobby requires continual increase and upgrading of skills as different geographic regions, time periods, and family scenarios present themselves during the genealogists' research. Therefore as genealogists today are using the internet to conduct their genealogy research, are they using the internet as an environment to learn genealogical methods? Is the internet a forum for genealogical education?

In the words of Neustadt, Robinson, and Kestnbaum (2003), "the internet is many things to many people", and as an educational environment, evidence abounds of its use. Organizations (Fry, 2001), schools (Foster, 2003; Lopez,

2003), e-commerce (Joia, 2002), and healthcare and medicine (Beer et al., 2002; Gray et al., 2000) are amongst the many genres using the internet as a virtual learning environment (VLE). For hobbies and leisure pursuits, of which the genre of genealogy can be considered a part, there is minimal scholarly literature about the use of the internet for education.<sup>2</sup> The popular press however have been discussing online hobbyist education for many years (see Cohen, 1999; Munro, 2003; Pollak, 2001; Thomas, 2003) and a brief empirical investigation for the purposes of this study finds thousands of online courses and educational content in this genre. Book binding (Jones, 1995), wood burning (Dulaney & Dulaney, 2003), ribbon crafting (*Offray Ribbon: How To's*, n.d.), quill pen making (Safran, n.d.), and cold process soap making are amongst the many hobbies using the internet for education. Perhaps due to hobby searching being a popular activity in the online world since Pew Research Centre (2003) started measuring in March 2000, many education providers have set-up suites of online courses and learning directories for the hobbyist genre. One such provider, Universal Class (*Classes in Crafts/Hobbies—Online Learning*, n.d.), offers over fifty different online courses for hobbies as diverse as decorating, cooking, Aromatherapy, and trick horse training.

While the above discussion indicates the internet can be used as a forum for general and hobbyist learning, we return to the purpose of this study and the online education of genealogists. As one participant in the newsgroup soc.genealogy.britain explains:

I know everyone has to start somewhere, but trying to participate in genealogy on the internet before you have familiarised yourself with the basic methodology of . . . research and sources is like trying to drive a Formula 1 racing car before you've learned to ride a bike.

(Stockdill, 2000)

As a result, a study was completed using a grounded theory approach to find and categorize current practices for internet-based education for genealogy. A discovery methodology such as grounded theory was chosen for the study as genealogy is a topic that can be considered a broad and general phenomenon: As demonstrated in part by the fifteen million websites returned by google.com containing the term “genealogy”. Grounded theory allowed the study, as Myers (2004) in citing Martin and Turner (1986) explains:

. . . to develop a theoretical account of the general features of a topic while simultaneously grounding the account in empirical observations or data.

Using theoretical sampling, an initial case of data for the study was created from evolving search engine queries at google.com, commencing with “genealog\* education” and “genealog\* learning”. Online content found to

appear as items of genealogical education were recorded in a spreadsheet, and the following descriptive characteristics evolved: title, author, content, learning mode, and learning outcomes. A grounded analysis of this first case led to a subsequent sampling in the form of the available literature on the subject of online GE, in addition to the comments of over 330 genealogists about their online education experiences, obtained during the week 27 April 2004 to 04 May 2004.

## 2. RESULTS

The grounded theory approach of the study allowed online GE to be interpreted as three emerging themes—scholarly, topical, and ad-hoc—in conjunction with three underlying learning paradigm shifts: class- to session-oriented; subject- to task-oriented; and fact- to problem-oriented learning, respectively. Scholarly education is described as formal courses and lessons provided by reputable organizations. In turn, topical education is generally separate, though sometimes linked, units of information that are topic- or task-based. Lastly, ad-hoc education represents the need for “just-in-time” help and knowledge.

### 2.1. Scholarly Genealogy Education

Genealogy societies, universities, and motivated individuals currently offer a number of online genealogical courses, adhering to a broad set of common characteristics interpreted as the theme of “scholarly”. They are generally fee- and module-based; prescriptively paced; inclusive of online assignments, exercises, and quizzes; and can also include facilitated interaction between the tutor and other students. They address a broad need of genealogists for formal, theoretical education about genealogical methods and records, and they can be interpreted as a paradigm shift from class-oriented learning to session-oriented learning. Scholarly GE range in structure from two-step theory/exam presentation, to fully-functioning courses, and it is with their structure that I begin the discussion.

In the first instance, at a minimum, the structure of scholarly GE content can be described as a two-step process: provide theory, and then test the learning. For example, the National Genealogy Society (commonly known as “NGS”, the largest genealogy society in the United States), offers three online courses: Introduction to Genealogy; Federal Population Census Schedules; and Special Federal Census Schedules. Course content is delivered as a step-by-step series of web pages containing text and images. There are no provided assignments or homework, though tests of student learning are conducted via a mandatory interactive exam or “quiz” at the end of each lesson, requiring a 70% or greater grade to pass. Certificates of completion are mailed to the student once all exams are passed.

At the other end of the structure scale, the National Institute of Genealogical Studies (n.d.) or “NIGS” provide fully functioning courses for their students. Although course content is limited to text, images, and downloadable PDF files, interactive bulletin boards are available to enable students to discuss weekly study topics with their classmates. “My Briefcase” functionality allows for a central repository of course, homework and assignment material; formal assignment and exam grades; and links to the aforementioned discussion groups. Similarly, the Genealogy Online Training Courses by Myfamily.com (2004) provides interactive chat and scheduled online class meetings to complement their text- and image-based course content to provide immediate feedback. The Genealogy Classes (genealogy.com, 2003) within Genealogy.com’s Learning Centre, broaden the immediate learning environment to the internet at large by including links to relevant reference material and website tools. Finally, the Basic Genealogy Course (Gould, n.d.) is delivered completely via Yahoo! Groups,<sup>3</sup> allowing the publishing of course material, management of students, provision of handouts, and collection of assignments in a manner similar to a traditional classroom environment.

The aforementioned examples of genealogical learning demonstrate online scholarly courses provided by genealogical societies, companies, and virtual genealogy organizations. Though if we consider the debate about academia and history versus genealogy (see Mills, 1983; O’Hare, 2002), it is surprising to find several of the scholarly GE are by universities. In 1983, Elizabeth Shown Mills declared “the academic advancement of genealogy . . . needs the wholehearted but judicious participation of . . . colleges and universities”. This study found six universities offer GE, and three of those in two countries offer their complete courses online. The University of Toronto offers “the world’s oldest comprehensive web-based certificate programs in genealogical studies”, in collaboration with the NIGS. The programs are similar in structure to university courses, to “support the needs of both amateur family historians and aspiring professional genealogists, for reliable and comprehensive education”. Thus each of their certificates is divided into three levels: basic, intermediate, and advanced. Students can major in the records of a specific country or librarianship by completing a minimum of eight 6-weeks subjects or “courses” for that country, and subjects can also be completed individually without the end result of a certificate. Brigham Young University and the Open University follow in NIGS’s footsteps by also providing university-based scholarly GE online.

Education in the scholarly theme generally requires payment, as represented by the 60% found in the sample, though not all are available for a fee. The aforementioned Basic Genealogy Course by journalist, writer, genealogist, and guest speaker Carolyn Gould is completely free to the student, as she explains (*Bio—Carolyn Gould*, n.d.):

A very special cousin helped me with my genealogical research when I was just starting out”, Ms. Gould said. “This is my way of paying him back and honoring my ancestors—by passing on that help to others.

Moreover, Brigham Young University (*BYU Independent Study*, n.d.), located near the genealogical Mecca of Salt Lake City in Utah, offer their suite of Independent Study courses for free.

Online scholarly GE was also found in this study to be largely theory-based. That is, the underlying basis is in the theoretical cornerstones of genealogical methods, rather than practice-based research advice—a very different characteristic to the audience in the other two themes. The objectives stated for Introduction to Genealogy (National Genealogical Society, 2004) for example, demonstrates a learning baseline from which the participant can obtain general methodological GE:

... record genealogical information; get started with information in family and published sources; find twentieth-century vital records; find birth, death, and marriage information for ancestors who lived in earlier centuries; use online finding aids and library catalogs; and write source citations for birth, death, and marriage information.

Likewise, Beginning Genealogy (MyFamily.com, n.d.) commences with a lesson entitled “Mapping the Course and Equipment for the Hunt”, with later topics devoted to more specific and advanced theory on country-specific civil registration. Lynn Mann (personal communication, April 29, 2004) offers her view on how an online scholarly course built her genealogical theory knowledge:

Recently I did the Open University short course No. A173, Writing Family History. Probably more suitable for people like myself who had already started some research and had some of their own materials to use as example in the assignments. It went into far more than just building a family tree, but aimed to help you think about how you conducted different types of research and what their value would be.

All students are given a class-like environment in the GE of this theme, we see an example of an underlying paradigm shift from class-oriented learning to session-oriented learning, given the asynchronous availability of the courses. That is, the student does not have to physically sit within the bounds of a classroom for the complete lesson, as per traditional offline class-based learning. Genealogists can now complete theoretical coursework in one or many sessions at their computer, absorbing the material at their own pace, though still within the time limits of the specific course.

Genealogists are motivated by the need for formal theoretically based education in this theme, however the comments of some genealogists seem to indicate the existence of barriers to their use of online education within this theme. Issues such as internet connection service or the level of computer expertise of the student may be a reason for topical and ad-hoc GE to be used instead of scholarly. For example, Anita Walker (personal communication, April 29, 2004) advises:

I did look into doing a course online at one stage, but our internet connection wasn't too good at that time so I gave up, before I started.

Additionally, Guy Howell (personal communication, April 27, 2004) offers this insight into possible frustrations with interactive scholarly GE:

The course was interactive and one was required to answer questions and group talks. As a slow two finger typist and elderly person I felt that I could not keep up with younger computer literate students and gave up.

Further research is required to uncover if and why genealogists are using online scholarly GE as presented in this theme, though it is outside the scope of this chapter. Such research could uncover whether these issues or others lead genealogists to pursue other themes, such as the following topical theme.

## **2.2. Topical Genealogy Education**

A large number of companies and individuals offer content online under the theme of "topical" GE. This study finds separate, though sometimes hyper-linked units of educational information for genealogy that are theory-based, lesson-based, or structured by topic or access, in ways that are more informal than the scholarly theme. They manifest more as an online reference system than a prescribed once-off course, are almost always free, and are examples of an underlying paradigm shift from subject-oriented learning to topic- or task-oriented learning. The ease of publishing to the internet is found as a possible explanation for the personal research experience of the author influencing some content in this theme.

In the first instance, topical GE on the internet can be lesson-based, though not as formally as the scholarly theme. Specifically, although topical GE can facilitate the formation of a methodological process, as some linear structure is implied through presentation, each "lesson" is generally a stand-alone webpage that can be accessed via a search engine and utilized individually as topic-based learning. The Courtenay and District Museum Tutorial (*COURTENAY MUSEUM: Genealogy Tutorial*, n.d.) is one such example. The tutorial is

presented to the genealogist as a series of four lessons: Preparation and Documentation; Search at Home; Paper Trail; and Guide Lines. Clicking through to each lesson however uncovers a stand-alone webpage containing text, images and hyperlinks. Similarly, web pages such as Genealogy for Beginners On and Off Line (Curtis, 1997) organize their topical content in numbered lists, suggesting the content is teaching a methodological step-by-step process. On closer inspection however, numbering is conveniently separating and ordering the display of the content, rather than building a research process. To explain, each “step” could be taken individually, in a random manner, and the genealogist could still gain important educational content at each numbered paragraph.

In the second instance, topical GE on the internet can be structured by topic, task, access, or even randomly, in ways again informal in comparison to the linear-structure of the scholarly theme. Firstly, while scholarly GE is obtained through a specific course of lesson-based or module-linked theoretical content, topical GE is found as libraries of articles bundled by task, to more informal informational and advice-based items bundled together in online and e-mail newsletters, columns, and streaming radio. For topic-structured topical GE, the genealogist may be presented with high-level categories of information from which they can click through. One such example is the A–Z of British Genealogical Research (Emery, 1999), a topic-based portal to hypertext and articles on researching British ancestry. In the same way, GenHelp (Partridge et al., n.d.) uses categories to organize and structure their growing library of task-related help articles. Other web sites (see Isaacson, 2003; *USGW—Help for Researchers*, n.d.) employ a portal concept for access to GE topics. Secondly, topical GE can be structured by the very mechanism it is delivered, in the form of push or pull newsletters, Internet Radio, and web logs or “blogs”. In this respect we find genealogists seeking or receiving topical education as ongoing GE, as Margaret Read (personal communication, April 29, 2004) explains:

The greatest help for me as a beginner, even after taking a . . . class . . . , was to receive a “daily dose of genealogy” online with suggestions, sites to visit and articles. Becoming familiar with what is available online and how to use what you find is an important step in learning how to work in genealogy.

The Global Gazette (Global Heritage Press Inc., n.d.) can be read online or pushed to the genealogist via subscription, and is “filled with helpful family history ‘How-To’ articles and heritage news for everyone interested in genealogy and history”. Other newsletters (*Family Tree Magazine Update*, n.d.) send newsletters containing hyperlinked pointers to online educational content. The online Expert Advice series in Family Tree Magazine has in the past included task-based content on grave markers (“Expert Advice: Types of

Grave Markers”, 2003), slave ancestor identification (“Expert Advice: Solving Slave Surnames”, 2003), and how to search a census (“Expert Advice: Census Research Strategies”, 2002). Similar in nature to newsletters, topical GE is also delivered via the streaming audio of Myrtles Family History Hour (<http://www.dearmyrtle.com/>). Pat Richley, the presenter, interviews guests and refers listeners to the best places to learn and do genealogy on the internet, while supporting the radio program with her own columns and task-based lessons. A show by Dick Eastman (Good, 2002) is a similar for-fee internet radio program. Additionally, blogs have become popular outlets for genealogical research progress and news in the last 6 months, as “tools that can ignite knowledge contribution and sharing in many different settings” (Heritage Creations, n.d.). Genealogy Blog, (Brandi, n.d.), Genealogy (Lythgoe, n.d.), Family Preserves (Zdenek, n.d.), and a blog at Enriching Lives with Ancestral Ties (2002) offer alternative and topical ways for genealogists to keep up to date with the latest genealogy announcements, news, and tips.

Finally, topical GE may be randomly structured by way of individually authored web pages, accessed via search engines or direct URL. One such manifestation is the web site of Mary Trevan (2002); in part a repository her genealogical research output, and in part topical GE through her pages titled “Basic Approach to Genealogy”. Deborah Russes (personal communication, April 29, 2004) explains that a majority of her genealogical learning has come via visits to different web sites and reading. In fact, this type of learning is Trevan’s motivation for providing such a personal contribution to online GE:

Over the few years since people have found my web site on the Trevan family history I have received a small number of emails asking how to do family history. Then in the first week of the new millen[n]ium 3 separate people asked me! Rather than reply in separate emails I decided to write these pages instead.

This chapter to date has generalized that all learning structures in the topical theme can be lesson-based, or topic, task or access-based, though before moving onto the third characteristic of topical GE, there are examples of more structured learning within the topical theme which warrant discussion. For example, using the Genealogy “How-To” Guide (Family Tree Maker, n.d.), a genealogist can access a library of hundreds of task-based how-to articles via any search engine (assuming their query links them to the topic of the article). Though if they access the library via the company’s specific guide home page, that we find an implied though informal structure is evident. The umbrella “Step 1-2-3” concept acts as a portal to hundreds of genealogy task-based how-to articles. Each article is hyperlinked to others, allowing the genealogist to further hone their requirement for learning on a specific topic or set of tasks. It is important to note however that although there is a hyperlink



structure to the content in this example and all other content in the topical theme, it is non-prescriptive in nature, which separates it from the scholarly theme. That is, education in the scholarly theme is rigid and linear, whereas using the example of the Genealogy “How-To” Guide, the genealogists’ experience is topic-based, indirect, and more personalized, as they choose their path through the content.

Returning to the characteristics of the topical theme, in the third instance, the above examples of topical GE support a finding that the internet is a vast library of educational items, an example of an underlying paradigm shift in learning from subject-oriented to topic- or task-based learning. Just as Wellman & Haythornthwaite (2003: 4) explain the internet is “embedded in everyday life”, and Neustadtl et al. (2003: 186) describe the internet as “the world’s largest library”, genealogist Mary Fyock (personal communication, April 29, 2004) describes her use of online topical GE as an often visited library resource:

Most reputable websites have great tutorials for the beginning researcher. I have used them off and on when I strike an area of research that I am most unfamiliar with.

Similarly, Marilyn Whiteman (personal communication, May 01, 2004) often bookmarks articles from Ancestry.com newsletters, to make a handy topic-based reference notebook. Jan Carr’s (personal communication, May 01, 2004) experience is similar:

I have been an avid and regular [reader] of a wide variety of “how to” articles published by Ancestry.com for about 4 years. Many of these articles I’ve downloaded and keep in a file for future reference.

The above examples of GE theory used on a needs basis demonstrates that the topical theme can be interpreted as a blend of the scholarly theme’s “whole picture” theoretical perspective, in addition to “just-in-time” topic- or task-based problem solving. To be exact, in the fourth instance, genealogical learning on the internet can be informal and theory-based, while also offering informal methodological education. General topic-based news articles about the hobby of genealogy have become high-level theoretical pieces with informal task-based methodological underpinnings, such as one written by Siân Busby (2000) for the *Financial Times*. While Busby commences her article as a summary of the motivations and process of the hobby, the article itself evolves as a reference piece for the genealogical process: headings include “Start with what you know”, “Primary sources and vital records”, and “Public records—the basics”. Likewise, articles such as one created for Americans of Swiss descent (Zentralstelle für Genealogie, n.d.) outline in-depth theory

and background for genealogists researching a specific topic, though in the format of an informal task-based How-To article.

While topical GE online is a blend of the scholarly themes theoretical learning and a step in the direction of just-in-time learning, it is with the final theme, ad-hoc, that this chapter reports the greatest concentration of personalized, just-in-time education online for genealogy, and an example of a shift to problem-oriented learning.

### 3. AD-HOC GENEALOGY EDUCATION

In 1998, Robin Mason declared free-for-all open discussions had largely been abandoned for serious teaching purposes, although they continued to flourish in social areas. Lavooy and Newlin (2003) cite Dede and Kremer (1999) that student–student interaction is especially crucial for the development of web-based learning communities that increase student learning. Both statements are especially evident in the ad-hoc education of the online genealogical community. Rootsweb alone hosts over 28,000 genealogical mailing lists; GenForum (<http://genforum.genealogy.com/>) has thousands of online forums, and the author counted over forty genealogy newsgroups on her local news server. Genealogists use the internet to access the combined expertise of the online genealogical community and to obtain personalized “just-in-time” education. GE was found in the form of discussions about current events, controversies, readings, common experiments, and many other genealogical issues. GE in this theme is used by genealogists to present and describe their research to others, and as a forum for seeking feedback or advice on their research from other participants. The third and final theme of GE, “ad-hoc”, has little or no structure or planning, and is generally based on the personal advice or experience of individuals. It is found to be less a part of the “whole picture” and very much motivated by immediate usage for specific activity problem solving; an example of an underlying paradigm shift from fact-based learning to problem-based learning.

Firstly, in comparison to both the scholarly and topical themes, ad-hoc GE on the internet can be described as having little or no pre-planned structure. While it can be said that the technology of the internet behind such education is certainly structured (in terms of setting up newsgroups, forums, and IRC channels, for example), the mode of learning conducted in this theme is not. That is, the act of learning creates the content in this theme, rather than the content coming first and leading the learning experience. To further explain, this study found two instances in which ad-hoc genealogical learning can be considered—at the very maximum—to be influenced by structure; by the topic of the ad-hoc forum; and netiquette.

In the same manner that topical GE on the internet was found to be topic- or task-based items of information, ad-hoc genealogical learning can

be structured at the very highest-level by the topic or task of the forum of learning. Every newsgroup, mailing list and online forum is characterized by the setting of a topic that sets the tone of the forum. While the topic guides (and sometimes restricts, as the discussion on netiquette will point out) the interaction and content within the forum, it is important to say that it does not imply a structure to the learning experiences of the genealogists within the forum. As one anonymous genealogist (personal communication, May 02, 2004) explains:

I have learned not through reading genealogy tips on websites but from being on the lists with the people that do this or have done this for years. Sometimes it goes, as they say, “off topic”, but eve[r]yone is still sharing experiences.

Additionally, this study found that most genealogical newsgroups have FAQs published on the internet and regularly posted to the newsgroup, reminding participants about behavior (netiquette), the topic of the forum, and outlining common questions that have reached the newsgroup in the past. Although it could be argued that by guiding genealogists to read a FAQ, their online learning experience in the ad-hoc environment is altered, this scenario requires further research. However, despite this possibility, many genealogists (see Mouallem, 2003) still post to specific forums they participate in, sharing what they have learned about getting the most out of ad-hoc GE. Similarly, another anonymous genealogist explains (personal communication, April 29, 2004):

[Mailing lists are] far more useful than . . . faq’s as specific questions that are often locality based are answered quickly at zero cost by experts in the area.

Returning to the second characteristic, ad-hoc GE on the internet is generally limited to advice, personal lessons learnt, and personal adaptations of pre-learnt theory; an environment as an example of problem-based learning. For example, a posting to soc-genealogy.jewish describes one genealogist’s lesson learnt in contacting long lost family:

I believe the best approach, beyond e-mail, is to send a personalized letter via snail mail to this person (if at all possible). In my experience, I have gotten the best results from my mailings. I think most people just tend to delete emails that are not from someone familiar, but letters are somewhat more intriguing and less threatening. (see “How to request help”, 1998)

While another example demonstrates a genealogists' personal experience in response to a request for information about problems researching Cherokee ancestors:

Oh, and regarding Cherokee ancestry; in my experience, which granted is limited to my own family and the families of those Cherokees whom I know personally, tracing the maternal line is exceedingly easy as it's usually well-documented. It's much harder to find a paper trail for my father's paternal line, which is not Cherokee. That's another reason I can't help but be skeptical [sic] of all the legions of people who claim Cherokee ancestry but can't find proof. In my experience, Cherokees have been meticulous record-keepers, and that includes all those who stayed behind when the others were forced to undergo the long walk.

(“Re: Re: Cherokee Ancestors”, 1999)

One participant in a study by Duff and Johnson (2003) suggested that general conversation between genealogists can result in the sharing of knowledge about records and research techniques. As a result, and in comparison to the theoretically based scholarly theme, and the hybrid theory/topic-based learning of the topical theme, ad-hoc GE exposes genealogists to more informal though personalized learning from other hobbyists and interested professionals who wish to share their learning experiences. Several other genealogists concur:

As far as the chat room is concerned, people are pretty good about offering ideas of places to look for info if you hit a roadblock. (Deborah Russes, personal communication, May 04, 2004)

I [use] message boards for help with individual questions that I can't find an answer to in published articles. (Kate Young, personal communication, April 27, 2004)

Thirdly, in having access to the combined expertise of the online genealogical community, it is the range of expertise that is found to vary greatly within the ad-hoc theme in comparison to the other two themes. As any interested genealogist, expert or beginner with internet access can join and participate in a newsgroup, chat or online forum, that person can also become a provider of GE to the community. On the one hand, for example, Everton's Family History (n.d.) provide the service Ask-a-Pro, an online forum with which genealogists can ask questions and receive personalized responses from a panel of genealogy experts. In contrast, some genealogists like Michael Harding (personal communication, April 29, 2004) have their own informal private network of online genealogists to address their ad-hoc GE needs:

I have hundreds of people I can contact over a variety of genealogy subjects, places and people.

Furthermore, thousands of everyday people participate in thousands of newsgroup and mailing lists available for genealogy. Given the quantity of input to the ad-hoc theme, it is perhaps not surprising in the final characteristic of the ad-hoc theme that many ad-hoc GE forums are being archived. In the case of the aforementioned Ask-a-Pro service from Everton's Family History, past question and answer sets are added to their online database so that others may search for topical help, and those general enough for the larger audience are also published in Family History Magazine. Ad-hoc GE can also be published in discussion forums with motivations fitting the topical theme. That is, genealogists contribute ad-hoc educational material in anticipation of someone needing it now or in the future:

I have just run across the following web site for Hungarian genealogy. It is quite comprehensive, including a User Guide to the Archives, information on the Hungarian data bases available at or from the site, an index register of Hungarian names, a bulletin board for posting requests for help, help with finding professional genealogists to do research, advice for doing research in Hungary, a set of international links for genealogy throughout the world with an extensive listing all in one place, and more.  
(Esterson, 2000)

In 2001, Google.com finished archiving 20 years of newsgroup messages ("Google archive opens up internet history", 2001), and since that date, has captured every message to pass through to present day into an online searchable archive at Google Groups (<http://groups.google.com>). Genealogists can therefore search for topical GE as reference material that started out as ad-hoc GE, as one online GE theme comes full circle to represent another.

#### 4. DISCUSSION

This study has interpreted online GE as one of three themes—scholarly, topical, and ad-hoc—and briefly intimated examples of learning paradigms underlying each. The presence of structure, fees, and genealogical theory and methods is most saturate in the session-oriented learning of the scholarly theme, and these characteristics lessen as we move from scholarly to topical GE, and then from the topical to ad-hoc theme. Ad-hoc GE has its strengths in personalized learning experiences, immediate availability due to sheer numbers of people powering the effort, and a problem-oriented learning environment, though it lacks the assurance of correctness and authenticity that scholarly GE provides. Topical GE allows genealogists to learn with

specific topics or tasks in mind, a shift in the direction of task-oriented learning, in ways that are more informal than the scholarly theme, though more formal than ad-hoc. Both topical and ad-hoc GE (through the archiving of ad-hoc content) are available as reference items to the genealogist on the internet, though scholarly learning must be considered once-off, unless paid for again. With these findings in mind, how do they compare to the available literature? Is the internet being used to the best of its potential for online GE?

Despite the 1999 audience profiler survey of over 11,000 visitors to the rootsweb.com website (“Who Are We? Preliminary Survey Results”, 1999) which reports 53% of participant’s time online was dedicated to GE, the available literature to compare to the results of this grounded theory study is minimal. This chapter already reports in the introduction that the popular press has published the widest body of knowledge on online education for hobbies and leisure pursuits, and the same can be said for online genealogical education. Thus we introduce some of the available literature for comparative analysis for this study, by genealogical journalists Mark Howells and Kathleen Hinckley.

In his most recent article about online GE, Mark Howells (2002) declares the genealogical community is not utilizing the internet to best teach genealogy, and that genealogical content only emulates traditional forms of instruction. Evidence from this study supports Howells’ view—GE for the most part does not extend past direct manifestations of traditional or pre-internet forms of instruction. To explain, using Howell’s examples of traditional GE, we see his first example of traditional one-on-one instructional content emulated in the scholarly theme in this study. His second, “self-read materials on methods, skills, and record types” certainly matches the content found in the topical theme. And the third, “skills refreshment through practice or by assisting or instructing others”, is demonstrable in the content of the ad-hoc theme. Similarly, the three themes found in this study align with a three-part GE series by Kathleen Hinckley. The scholarly theme aligns with her discussion on online tuition course content (Hinckley, 2003c); topical GE is represented in her article regarding magazines and journals (Hinckley, 2003a); and the communicative nature of the ad-hoc theme is addressed in her article about national conferences, institutes, and societies (Hinckley, 2003b).

While Howells thinks that a more advanced use of the internet for GE would see the genealogical community “use the strengths of the internet to the advantage of the educational process, instead of simply duplicating traditional teaching methods in a new medium”, we first look outside of the genealogical community to get an accurate understanding of what could be considered advanced learning.

Using Twigg’s (2001) assessment of the problems with online courses, we find firstly that existing GE cannot be considered advanced learning:

The vast majority of online courses are organized in much the same manner as are their campus counterparts . . . [and] most follow traditional academic practices (“Here’s the syllabus, go off and read or do research, come back and discuss”).

Twiggs’s viewpoint is supported by the comments of course producers such as Ken Innes (personal communication, April 29, 2004) who advise the format of his course Introduction to Genealogy on the internet (Innes, n.d.) derives from the content of original, hard-copy course notes. Additionally, online GE does not seem to have evolved in line with the research of Glenn, Jones, and Hoyt (2003):

Browser-based delivery has evolved in less than ten years from static HTML pages coupled with e-mail and list-serves to integrated course management suites.

Furthermore, online GE also fails to demonstrate three of the five key features Twiggs offers as indicators of improvement in the quality of learning beyond traditional forms of education. Addressing two of Twiggs’s indicators, some scholarly themed resources in this study demonstrate built-in, continuous feedback and varied kinds of online human interaction such as e-mail, message boards, and chat; and the course suite offered by University of Toronto demonstrates the beginnings of individualized study plans. However this study finds no GE online with an initial assessment of each student’s knowledge of skill level and preferred learning style, nor feedback in the form of audio or video. Additionally, no GE resources in this study can be described as having Twiggs’s fifth characteristic—an “array of high-quality, interactive learning materials and activities”—with the exception of the Free Web Courses by Brigham Young University ([http://ce.byu.edu/is/site/special\\_offers/freecourses.dhtml](http://ce.byu.edu/is/site/special_offers/freecourses.dhtml)). These scholarly courses are paving the way for other courses in the provision of Flash-based animation content to help explain genealogical concepts and principles. By placing online GE within the domain of general online learning, this study finds current online GE falling short of improved or advanced education.

Returning to the literature on genealogical education, the resources found in this study also fall short to address Howell’s notions of advanced online GE. He expects advanced GE content such as animated map graphics showing how to walk a cemetery for recording purposes; video clips on tombstone rubbing; audio clips of how to interview a relative; or even interactive demonstrations with circles and arrows showing how to cite particular sources. He also states a specific example in guided discovery—a series of statements or questions that direct the learner step by logical step, into making discoveries, which lead to an answer. Although this study found four instances of this “advanced” form

of online GE content (Barry, n.d.; genealogy.com, n.d.; Intellectual Reserve Inc., n.d.; *Irish Ancestors / Where to start*, n.d.), they are outliers to the sample of this study, thus GE cannot be generally labelled “advanced” learning.

More over, in an article by Krasner-Khait (2002), various genealogical visionaries prophesise about the future of online GE. Matthew Helm envisions increased interaction through technology, and believes that genealogists should be able to input information on ancestors when using online census records and be guided to a relevant piece of content. Accredited genealogist and instructor Janet Reakes predicts:

The multimedia aspect of computers will change the face of genealogy classes. We will soon be able to talk to each other via camcorder in a chat room. Already there is voice chat and visual interaction will be next.

Michael Leclerc adds:

In the not-too-distant future, we’ll be able to use the capabilities of graphics and streaming video, and live lectures through webcast.

It is evident from the words of these genealogists that “tailoring an approach with customized, interactive programs” is the future direction for online GE, and an inroad to making Howell’s notions of advanced online GE content come true. The broader genre of hobbies and crafts is certainly paving the way, incorporating animated graphics and Flash demonstrations to teach other budding hobbyists about their craft (*Animated Chinese Characters*, n.d.; *Knitting Techniques*, 2001; *Painting Interior Rooms*, n.d.; *A short guide to star hopping*, 2004; *Shutter Bee, The Animated Online Camera Tutorial*, 2003)

The challenge for GE however, as Krasner-Khait concludes, is to meet the hunger for instant gratification while simultaneously teaching problem-solving. Thus the more interactive the content and experience, genealogical educators will be able to draw people with limited experience in basic methodologies and increase the general online education level within the hobbyist genre.

... The learning never stops [in genealogy. And] the internet has changed the way we research. It will also continue to change the way we educate [in the future].

#### ENDNOTES

1. Entering the query “revolutionised genealogy” and “revolutionized genealogy” through google.com retrieves 556 and 4285 search results, respectively.



2. One of the very few scholarly studies on the use of the internet for hobbies and leisure pursuits reports that amateur radio enthusiasts “have learnt tricks of the trade from video magazines and the internet” (Isomursu et al., 2004).
3. Yahoo themselves entered the VLE market in 2002 with Yahoo!Education (Wilson, 2002).

#### REFERENCES

- Animated Chinese Characters*. (n.d.). Retrieved 19 May 2004 from ocrat.com Web site: <http://www.ocrat.com/ocrat/chargif/>.
- Barry, D. K. (n.d.). *Free genealogy search advice based on your ancestry*. Retrieved 17 May 2004 from Genealogy Search Advice Web site: <http://www.genealogy-search-advice.com/>.
- Beer, M., Green, S., Armitt, G., van Bruggen, J., Daniels, R., Ghyselen, L., et al. (2002). The provision of education and training for health care professionals through the medium of the Internet. *Campus—Wide Information Systems* 19(4), 135–144.
- Bio—Carolyn Gould*. (n.d.). Retrieved 13 May 2004 from Carolyn Gould Web site: <http://www.geocities.com/carolynegould/>.
- Brandi, R. (n.d.). *Genealogy*. Retrieved 19 May 2004 from brandi.org Web site: <http://www.brandi.org/genealogy/>.
- Busby, S. (2000). Life on the net/genealogy—online resources: genealogy on the net. *Financial Times*. Retrieved 18 May 2004 from <http://specials.ft.com/lifeonthenet/FT3NW20CUCC.html>.
- BYU Independent Study*. (n.d.). Retrieved 18 May 2004 from Brigham Young University Web site: [http://ce.byu.edu/is/site/special\\_offers/freecourses.dhtm](http://ce.byu.edu/is/site/special_offers/freecourses.dhtm).
- Classes in Crafts/Hobbies—Online Learning*. (n.d.). Retrieved 19 May 2004 from Universal Class Web site: <http://home.universalclass.com/i/subjects/artsandcrafts.htm>.
- Cohen, J. (1999, 25 November). Origami sites show how to fold them. *New York Times*, G. 8.
- COURTENAY MUSEUM: Genealogy Tutorial*. (n.d.). Retrieved 16 May 2004 from Courtenay Museum Web site: <http://www.courtenaymuseum.ca/genealogy/tutorial.html>.
- Curtis, L. J. (1997). *Genealogy for Beginners On and Off Line*. Retrieved 14 May 2004 from the R. Prost Web site: <http://members.aol.com/rprost/new.html>.
- Dede, C. & Kremer, A. (1999). Increasing students’ participation via multiple interactive media. *Inventio* 1(1).
- Doriott, C. L. (2000). Privacy in genealogy: a progress report. *Genealogical Computing* 20(2). Retrieved 03 April 2003 from <http://www.ancestry.com/library/view/gencomp/4383.asp>.
- Duff, W. M. & Johnson, C. A. (2003). Where is the list with all the names? Information-seeking behavior of genealogists. *The American Archivist* 66(Spring/Summer 2003), 79–95.
- Dulaney, R. E. & Dulaney, D. L. (2003). *Pyrography: Learning Woodburning on the Web!* Retrieved 19 May 2004 from The Woodburner Web site: <http://woodburner.com/start.html>.
- Emery, A. (1999, 03 April 2004). *A-Z of British Genealogical Research*. Retrieved 19 May 2004 from GENUKI Web site: <http://www.genuki.org.uk/big/EmeryPaper.html>.
- Esterson, G. L. (2000, 27 March). *Excellent Site for Hungarian Research*. [Msg. ID: <4.2.0.58.20000327184811.00a934a0@vms.huji.ac.il>#1/1]. Message posted to soc. genealogy.jewish.
- Everton’s Family History. (n.d.). *Ask-A-Pro*. Retrieved 19 May 2004 from Family History Network Web site: [http://www.familyhistorynetwork.net/online\\_helper/ask\\_a\\_pro.php](http://www.familyhistorynetwork.net/online_helper/ask_a_pro.php).

- Expert Advice: Census Research Strategies. (2002, 24 October). *Family Tree Magazine Update [Online Newsletter]*. Retrieved 18 May 2004 from <http://www.familytreemagazine.com/newsarchive/viewarticle.asp?id=2573&ref=index>.
- Expert Advice: Solving Slave Surnames. (2003, 06 February). *Family Tree Magazine Update [Newsletter]*. Retrieved 18 May 2004 from <http://www.familytreemagazine.com/newsarchive/viewarticle.asp?id=2648&ref=index>.
- Expert Advice: Types of Grave Markers. (2003, 27 March). *Family Tree Magazine Update [Newsletter]*. Retrieved 18 May 2004 from <http://www.familytreemagazine.com/newsarchive/viewarticle.asp?id=2685&ref=index>.
- Family Tree Magazine Update*. (n.d.). Retrieved 19 May 2004 from Family Tree Magazine Web site: <http://www.familytreemagazine.com/newsarchive/>.
- Family Tree Maker. (n.d.). *Genealogy "How-To" Guide*. Retrieved 19 May 2004 from Genealogy.com Web site: <http://familytreemaker.genealogy.com/mainmenu.html>.
- Foster, B. (2003). On-line teaching of mathematics and statistics. *Teaching Mathematics and its Applications* 22(3), 145.
- Fry, K. (2001). E-learning markets and providers: some issues and prospects. *Education & Training* 43(4/5), 233–240.
- genealogy.com. (2000, 16 May). *Recent Maritz poll shows explosion in popularity of genealogy*. Retrieved 11 January 2004 from Genealogy.com Web site: <http://www.genealogy.com/genealogy/press-051600.html>.
- genealogy.com. (2003). *Genealogy Classes*. Retrieved 19 May 2004 from genealogy.com Web site: <http://www.genealogy.com/university.html>.
- genealogy.com. (n.d.). *Biography Assistant*. Retrieved 18 May 2004 from MyFamily.com Web site: <http://www.genealogy.com/bio/index.html>.
- Glenn, L. M., Jones, C. G., & Hoyt, J. E. (2003). The effect of interaction levels on student performance: a comparative analysis of web-mediated versus traditional delivery. *Journal of Interactive Learning Research* 14(3), 285.
- Global Heritage Press Inc. (n.d.). *The Global Gazette, The Online Family History Magazine*. Retrieved 19 May 2004 from The Global Gazette Web site: <http://globalgenealogy.com/globalgazette/>.
- Good, R. (2002, 31 October). *Use of Blogs and WebLogs for Online Learning and Education*. Retrieved 30 April 2004 from Master New Media—IKONOS New Media Web site: [http://www.masternewmedia.org/2002/10/31/use\\_of\\_blogs\\_and\\_weblogs\\_for\\_online\\_learning\\_and\\_education.htm](http://www.masternewmedia.org/2002/10/31/use_of_blogs_and_weblogs_for_online_learning_and_education.htm).
- Google archive opens up Internet history. (2001). *internet magazine*. Retrieved 18 May 2004 from <http://www.internet-magazine.com/news/view.asp?id=2119>.
- Gould, C. (n.d.). *Yahoo! Groups : yahoo-cls-basicgenealogy*. Retrieved 19 May 2004 from Yahoo! Groups Web site: <http://groups.yahoo.com/group/yahoo-cls-basicgenealogy/>.
- Gray, J. E., Safran, C., Davis, R. B., Pompilio-Weitzner, G., Stewart, J. E., Zaccagnini, L., et al. (2000). Baby carelink: using the Internet and telemedicine to improve care for high-risk infants. *Pediatrics* 106(6), 1318–1324.
- Heritage Creations. (n.d.). *Genealogy Blog*. Retrieved 19 May 2004 from <http://www.genealogyblog.com/>.
- Hinckley, K. W. (2003a). *Genealogical Education: Magazines and Journals*. Retrieved 29 April 2004 from genealogy.com Web site: [http://www.genealogy.com/63\\_kathy.html](http://www.genealogy.com/63_kathy.html).
- Hinckley, K. W. (2003b). *Genealogical Education: National Conferences and Institutes*. Retrieved 29 April 2004 from genealogy.com Web site: [http://www.genealogy.com/59\\_kathy.html](http://www.genealogy.com/59_kathy.html).
- Hinckley, K. W. (2003c). *Genealogical Education: Online and Home Study Courses*. Retrieved 29 April 2004 from genealogy.com Web site: [http://www.genealogy.com/genealogy/57\\_kathy.html?priority=0000900](http://www.genealogy.com/genealogy/57_kathy.html?priority=0000900).

- Hornblower, M. (1999). Roots Mania. *Time* 153(15), 54–63.
- How to request help. (1998, 01 June). [Msg. ID: <6kuh02\$rfi@bl-5.rootsweb.com>#1/1]. Message posted to soc.genealogy.methods.
- Howells, M. (2002). Why Johnny can't do genealogy: the case for improvement in online education [electronic version]. *New England Ancestors Magazine* (Fall).
- Innes, K. (n.d.). *Introduction to Genealogy on the Internet—Class Notes and Exercises*. Retrieved 30 April 2004 from McInnes/Lawson and Trotter/Plunkett Families of Victoria Australia Web site: <http://freepages.genealogy.rootsweb.com/~kenmac/igoti/Genie1.htm>.
- Intellectual Reserve Inc. (n.d.). *Research Guidance v2.0*. Retrieved 15 May 2004 from Family Search: The Church of Jesus Christ of Latter-day Saints Web site: [http://www.familysearch.org/Eng/Search/RG/frameset\\_rg.asp](http://www.familysearch.org/Eng/Search/RG/frameset_rg.asp).
- Irish Ancestors/Where to Start*. (n.d.). Retrieved 19 May 2004 from ireland.com Web site: <http://scripts.ireland.com/ancestor/browse/howto/index.htm>.
- Isaacson, K. E. (2003, 18 March). *ROOTS-L Resources: Info and Tips for Beginning Genealogy*. Retrieved 19 May 2004 from Rootsweb Web site: <http://www.rootsweb.com/roots-l/starting.html>.
- Isomursu, P., Tasajärvi, L., Perälä, M., & Isomursu, M. (2004). Internet-based amateur video delivery: the users and their requirements. Paper Presented at the 37th Hawaii International Conference on System Sciences.
- Joia, L. A. (2002). Analysing a Web-based e-commerce learning community: a case study in Brazil. *Internet Research*, 12(4), 305–317.
- Jones, D. W. (1995, 01 August 2002). *Bookbinding: A Tutorial*. Retrieved 19 May 2004 from University of Iowa Web site: <http://www.cs.uiowa.edu/~jones/book/>.
- Knitting Techniques*. (2001, 24 November). Retrieved 19 May 2004 from Knitting Patterns for Toys Web site: <http://www.dnt-inc.com/barhtmls/knittech.html>.
- Krasner-Khait, B. (2002). The future of genealogical education [electronic version]. *Genealogical Computing* 22(1).
- Lavooy, M. J. & Newlin, M. H. (2003). Computer mediated communication: online instruction and interactivity [Electronic version]. *Journal of Interactive Learning Research* 14(2), 157.
- Lopez, J. (2003). Learning in virtual environments. *The Science Teacher* 70(7), 58–61.
- Lythgoe, D. (n.d.). *Family Preserves: A Family History Weblog & Genealogy Website*. Retrieved 19 May 2004 from Family Preserves Web site: <http://www.familypreserves.com>.
- Martin, P. Y. & Turner, B. A. (1986). Grounded theory and organizational research. *The Journal of Applied Behavioral Science* 22(2), 141–157.
- Mason, R. (1998). Models of online courses. *ALN Magazine* 2(2). Retrieved 18 May 2004 from <http://www.sloan-c.org/publications/magazine/v2n2/mason.asp>.
- Mills, E. S. (1983). Academia vs. genealogy: prospects for reconciliation and process. *National Genealogical Society Quarterly* 71(June 1983), 99–106.
- Mouallem, C. (2003, 01 May). How to approach long lost family. [Msg. ID: 000801c30fb2\$51793880\$d2c5580c@hppav]. Message posted to soc.genealogy.jewish.
- Munro, J. (2003). Build a better robot ; robotics is serious technology, but it also can be a truly cool hobby, fulfilling the need to create, control, and compete. *PC Magazine*, 22(4), 148.
- MyFamily.com. (2004). *Genealogy Online Training Courses*. Retrieved 19 May 2004 from MyFamily.com Web site: <http://www.myfamily.com/isapi.dll?c=h&htx=onlinetraining&school=GEN>.
- MyFamily.com. (n.d.). *Introduction to Genealogy Research, Vital Records, and U.S. Census Data*. Retrieved 17 May 2004 from MyFamily.com Web site: <http://www.genealogy.com/uni-begin.html>.
- National Genealogical Society. (2004). *National Genealogical Society—Course One “Introduction to Genealogy”, Lesson One “Genealogical Basics”*. Retrieved 17 May

- 2004 from National Genealogical Society Web site: <http://www.ngsgenealogy.org/Courses/Course.cfm?CID=1>.
- National Institute for Genealogical Studies. (n.d.). *National Institute for Genealogical Studies*. Retrieved 19 May 2004 from <http://www.genealogicalstudies.com/eng/main.asp>.
- Neustadt, A., Robinson, J. P., & Kestnbaum, M. (2003). Doing social research online. In: Wellman, B. and Haythornthwaite, C. (Eds.) *The Internet in Everyday Life*. Malden, MA: Blackwell Publishing.
- Offray Ribbon: How To's*. (n.d.). Retrieved 19 May 2004 from C. M. Offray & Son Inc. Web site: <http://www.offray.com/howto.html>.
- O'Hare, S. (2002). Genealogy and history. *Common-place: The Interactive Journal of Early American Life* 2(3). Retrieved 10 May 2004 from <http://www.common-place.org/vol-02/no-03/ohare/>.
- Painting Interior Rooms*. (n.d.). Retrieved 18 May 2004 from Easy2.com Web site: [http://www.easy2diy.com/cm/easy/diy\\_ht\\_index.asp?page\\_id=35694166](http://www.easy2diy.com/cm/easy/diy_ht_index.asp?page_id=35694166).
- Partridge, D., Cribbs, W., Schulze, L., White, J., & Reid, K. (n.d.). *GenHelp: Genealogy Help at Your Fingertips*. Retrieved 19 May 2004 from Genhelp.org Web site: <http://www.genhelp.org/index.php>.
- Pew Research Centre. (2003). *America's Online Pursuits: The Changing Picture of Who's Online and What They Do [PDF]*. Retrieved 19 May 2004 from Pew Internet & American Life Project Web site: [http://www.pewinternet.org/reports/pdfs/PIP\\_Online\\_Pursuits\\_Final.PDF](http://www.pewinternet.org/reports/pdfs/PIP_Online_Pursuits_Final.PDF).
- Pew Research Centre. (2004, 23 April). *Pew Internet & American Life Project Tracking Surveys (March 2000–present)*. Retrieved 18 May 2004 from Pew Internet & American Life Project Web site: [http://www.pewinternet.org/reports/chart.asp?img=Internet\\_Activities\\_4.23.04.htm](http://www.pewinternet.org/reports/chart.asp?img=Internet_Activities_4.23.04.htm).
- Pollak, M. (2001, 13 June). Pick a hobby, and there's a web site. *New York Times*, H.18.
- Re: Cherokee Ancestors. (1999, 28 December). [Msg. ID: 19991228030710.11594.00000058@nso-fp.aol.com]. Message posted to alt.native.
- Safran, J. (n.d.). *The Online Quill Pen Studio*. Retrieved 19 May 2004 from Janice Safran Web site: <http://www.geocities.com/Athens/Delphi/7958/quill-page-color.htm>.
- A Short Guide to Star Hopping*. (2004, 09 May). Retrieved 17 May 2004 from Astrocentral Web site: <http://www.astrocentral.co.uk/starting.html>.
- Shutter Bee, The Animated Online Camera Tutorial*. (2003). Retrieved 18 May 2004 from T. Random Web site: <http://shutterbee.thinkrandom.com/>.
- Stockdill, R. (2000, 02 May). Advice for newbies. [Msg. ID: <200005020508\_MC2-A365-90FE@compuserve.com>#1/1]. Message posted to soc.genealogy.britain.
- Taylor, R. M. & Crandal, R. J. (Eds.). (1986). *Generations and Change: Genealogical Perspectives in Social History*. Macon, GA: Mercer University Press.
- Tedeschi, B. (2001, 03 October 2002). *Popularity of Online Genealogy*. Retrieved 02 March 2004 from Czarnik Surname Resource Centre (SRC) Web site: [http://www.tovegin.com.au/src/articles/20020923\\_online\\_genealogy\\_nytimes.htm](http://www.tovegin.com.au/src/articles/20020923_online_genealogy_nytimes.htm).
- Thomas, T. Q. (2003, 14 September). Internet flows with vinous knowledge. *Denver Post*, p. L.05.
- Treva, M. (2002, 07 August). *FAQ—Family History Research in (South West) England*. Retrieved 03 May 2004 from Genealogy—Treva and Related Families Web site: <http://home.wxs.nl/~treva000/tutorials/faq.htm#why>.
- Twigg, C. A. (2001). *Innovations in Online Learning: Moving Beyond No Significant Difference*. Troy, NY: Center for Academic Transformation, Rensselaer Polytechnic Institute.
- USGW—Help for Researchers*. (n.d.). Retrieved 19 May 2004 from The USGenWeb Project Web site: <http://www.usgenweb.org/researchers/researcher.html>.

- Wellman, B. & Haythornthwaite, C. (2003). Introduction. In: Wellman, B. and Haythornthwaite, C. (Eds.), *The Internet in Everyday Life*. Malden, MA: Blackwell Publishing.
- Who Are We? Preliminary Survey Results. (1999, 23 June). *Roostweb Review*. Retrieved 29 April 2004 from <http://ftp.roostweb.com/pub/review/19990623.txt>.
- Willard, T. & Willard, J. (2001). Online Research. *Ancestry Magazine*, 19(5). Retrieved 19 May 2004 from <http://www.ancestry.com/library/view/ancmag/4786.asp?rc=locale%7E&us=0>.
- Wilson, S. (2002). Yahoo! enter the VLE market. *CETIS*. from <http://www.cetis.ac.uk/content/20020207142924>.
- Zdenek, K. (n.d.). *Enriching Lives with Ancestral Ties*. Retrieved 19 May 2004 from Suburban Library System Web site: <http://www2.sls.lib.il.us/mt/enriching/>.
- Zentralstelle für Genealogie. (n.d.). *A Genealogical How-to for Americans of Swiss descent [PDF]*. Retrieved 18 May 2004 from Federal Department of Foreign Affairs (DFA) Web site: [http://www.eda.admin.ch/washington\\_emb/e/home/legaff/howto.Par.0002.UpFile.pdf/Genealogy.pdf](http://www.eda.admin.ch/washington_emb/e/home/legaff/howto.Par.0002.UpFile.pdf/Genealogy.pdf).

## Chapter 36: Downtime on the Net: The Rise of Virtual Leisure Industries

JACKIE COOK

*School of Communication, Information and New Media, University of South Australia,  
St Bernard's Road, Magill, South Australia*

When Manuel Castells in 2001 came to focus on the culture of the internet, attempting to describe its curious amalgam of origins and influences, and their persistence in the values present in its manifold operations, he suggested that it was in many ways a culturally schizoid medium. On the one hand, as maintained for instance in the many myths of its APARNET military foundation, it presents as a scientific, pragmatic, rational, communicative instrument; a standardized, and so regulatory set of operations to facilitate and accelerate data flows. But at the same time, given its long conception in a largely informal and highly collegial set of laboratory backrooms and University graduate-assistant work zones, it has inbuilt elements of the sorts of libertarianism or radical communitarianism identified by Bauman (2000). It retains a playfulness, a feisty independence, and an innovative edge, among the enduring marks of its operations.

Perhaps then it should come as less of a surprise that we have come to see leisure pursuits: pastimes popularly conceived as belonging in the personal domain of self-expressiveness, private recreation or “downtime” sociability; as prominent agents of the Net’s development. In some cases, whether desired or not as part of any “official” history of this currently central cultural medium, online recreation or “virtual leisure” has been positioned among the dominant elements within the internet’s development. Consider for instance persistent suggestions that the technologization of online pornography has contributed new forms of interactivity to webcam and online video use (Slater, 1998; Williams, 1990); innovations introduced at least as early as those for scientized telemedicine for instance, and rather more widely used. In some of the very earliest academic analyses of online content and services—often published in screen journals, before the rise of more specialized publishing sources—analysts and researchers were already aware of powerful online communities working around such “unrespectable”, unproductive or even illicit activities as sex, game play, or just plain sociability.

What remains surprising then is the very slow rise of interest in the full range of leisure pursuits on the internet as itself a site for study. Here is a topic with the potential not only to alter public and even policy-framing perspectives of what the internet “is”, or to alert business to new interactive-communications paradigms and opportunities arising from the creativity of the private user,

but also able to open a whole new set of perspectives around ideas of leisure, recreation, self-expression, popular culture, and social life. While each of these elements has evoked in its own ambit a wide range of debates, theorizations, and academic interest, by focusing them all through the lens of the current drive in the leisure industries toward a rich mix of public events, private responses, and merchandised resources, a new and useful field for examining the role and power of the internet itself, as agent of their interaction, is exposed.

What then “counts” as virtual leisure? And are there already industries and consumer groups which could be considered to be operating, principally or in significant ways, through the “disembodied” interactive networks of the internet? What is it about such new zones and experiences which make “virtual” leisure any different from existing forms? Are we talking about one, or many, models of “virtual leisure”? Are there clear typologies or developmental pathways arising which characterize all online recreative pursuits, or are there multiple modes and stages? And what above all, makes this a worthwhile way to constitute inquiry into 21st century patterns of leisure use?

These are the questions which most immediately arose when, in 1998, I was asked to consider ways of structuring graduate curriculum around the then new idea of Internet Studies. I immediately proposed a course focused on virtual leisure industries. In some cases, this term was used to accommodate study of existing recreational pursuits then rapidly extending into online presences of various forms (sport, gambling, shopping, sex). In other instances, it enabled new forms of scrutiny of activities evolving from already-mediated leisure formats from within related electronic fields (video games for home or arcade use; mediated chat moving from talkback radio or telephone “conference call” lines; fandom; self-expressive display spaces for art, photography, writing—whether DIY or wannabe professional). The immediate response was hesitant: Was this a field for serious analysis and study? How would a university react to a course which specialized in the study of computer games; fan activities, pornographic websites? In Australia, this nervousness had added salience from rising degrees of public-media criticism over research into “private” or popular-culture activities and products:<sup>1</sup> right-wing political attacks through the media, on published or funded research into issues of everyday culture—including of course, inquiry into internet-based pursuits. Above all, how could this be argued as suitable to the graduate-level preparation and research training of senior professionals within the communications industries?

In turn, I found these responses surprising. Those industries which had already, and so quickly, entered virtual leisure fields were not only being widely acknowledged as major sectors of the new economy, but also constantly held up around the world as among the most central and innovative.<sup>2</sup> Indeed, many of the most dominant global communications and media enterprises were at that time intent on mergers, takeovers, and vertical-integration ventures with Net-based VLIs.

These charges of non-seriousness, leveled at both leisure activities and popular or private internet uses, seemed to me indicative of a persistent miscueing of web-based activities, within both the economy and society at large. In an ironic reprise of Frankfurt School responses to the rise of Modernist forms of screened, sound recorded, and broadcast popular media, Net-based activities outside the direct regulatory control of the “old” economy and its institutions were still being read as trivial, if not dangerous, private pursuits. Perversely, at the public level at least, those very forms of old media industries (print, radio, television, cinema) most ardently promoting and themselves taking up the digital hardware and infrastructure which enabled large sweeps of the population to access the new media, were the same ones denouncing its private uses as immoral, illegal, unhealthy, anti-social, anti-educational, or unproductive.

Immediately, this raised for me the still-intriguing issue of the positioning of the leisure industries—online just as elsewhere—within a privatized and consumerist ethic. Here was a field that crossed two problematic social and cultural divides: the public/private, and production/consumption—with all of the complex articulations each has been shown to accommodate. But above all, and here specifically within the Australian–Asian regional context in which I live and work, how could it remain possible not to acknowledge the key social and economic development focus on new media and especially online industries as both annexing old, and developing new, leisure industries. Surely this was at the core of the creative industries movement so strongly expressed within Australian Cultural and Media Studies, and even more powerfully, within the national development policy frameworks of the Asian “Tiger economies”?<sup>3</sup>

I outlined a course in which graduate students, at every stage selecting a focus of interest and research which suited their own professional needs and personal interests, would review both this emergent centrality of “private”, self-tailored or “pull” uses of the new media *via* the internet, and the relative degree to which a given industry was fulfilling, acknowledged or otherwise, the demands of Government, commerce and community alike, for new media content, creative product and an open, responsive, “enterprise” culture.

I began by suggesting that students take up the last contributions of re-theorization research into the idea of the “active audience” from traditional Media Studies [see especially Ang (1996) and Nightingale (1996) on active-response television viewing, and Tulloch (2000) and Jenkins (1992) on active fan culture] which had helped to position the theorizations and methodologies behind emergent online-ethnographic studies of the central new-media concept of interactivity. Within this conceptual frame for observation of actual Net practices and behaviors, I created opportunities for my students to examine not only what was available for the pursuit of leisure online, but also how this was taken up, and how it differed from or was continuous with activities pursued in the physical world. The very title: *Virtual Leisure Industries*, played across this complex set of paradoxes, to set up from the outset an analytical



project—one which would be forced to confront ongoing cultural beliefs and separations between private life and production, public commerce, and personal modes of consumption. Not only are these increasingly untenable in an era of interactive and mobile communications, given the enhanced capacities of digitized communication platforms such as the internet and related technologies to penetrate domestic and private spheres of life, but also the very divisions between them move, re-form and are themselves taken up in ways which actually promote new technological interventions, applications, and services.<sup>4</sup> Indeed, this newly exposed role for a collaborating and co-productive “prosumer” public within commodity and service innovation and the ever-accelerating cycles of fashion and product obsolescence has been central to the rise of the new economy. As Lury (1996, 2004) has pointed out, without the capacities of the new CMC technologies to deliver very fast feedback-loops into style culture, the older consumer industries would not have achieved the market massing which has kept profitability levels high enough to support a growing middle class of leisure and style consumers. Within this, it is the ever-accelerating “trend” drive which maintains forward momentum; which keeps product-desire evolving—and along with it, the many 1990s/2000s myths of online product innovation and crossover from private leisure pursuit to commercial innovation and profit. From *Geekgirl* to Matt Drudge (The Drudge Report), Jennicam to SaveToby.com, individuals have successfully moved their obscure personal pastimes to international prominence, and even to entrepreneurial success.

Studying virtual leisure industries thus requires an examination of a set of fields in which leisure pastimes, or recreational opportunities, or activities in support of them, are offered online, *via* the internet, or related activities within mobile telephony. Open-ended, the course has potential for the clip-on of further industries, or consideration of activities with potential for commercialization and industry uptake: for instance, animation, animatronics, and cinematic special effects; digital broadcasting; recreational applications of online imaging and remote sensing; the authoring of webpages, webcams, blogs, online journaling for fun or profit, software modding; even those spin-off activities from online contact which move back into and impact upon the physical realm: warchalking, moblogging, Lomo. But in each case, it begins by examining four different ways in which an understanding of online experiences benefits from study of internet uses and behaviors, and leisure and recreational institutions and practices, more generally.

Overall, the approach to the idea of VLIs is founded on use of a backgrounding series of texts and studies, each of which in itself may or may not focus upon consideration of the internet, or even on digital-media content and practice. Instead, it might introduce broader issues, relating for instance to our current understandings of leisure, or of symbolic versus material culture, or of creativity and innovation, and the commercialization of ideas. This works to extend attention beyond the rapidly accreting “research literature” around

the internet; to build-in a form of inclusivity and range, and to keep this field alert to the new and disregarded. If Castells is even partly right in his analysis of the characteristics of internet culture, it is from here that the most interesting, least likely innovations arise—in the “trivia” of personalized, social, non-corporate activity.

Each segment of the course also, however, seeks to build a sensitivity to both the innovations and the cultural continuities apparent on the internet: The degree to which any newly observed Net-leisure pursuit is “new” as both a conceptual totality, and as simply another example of an existing set of products, services, applications, or capacities. In this it seeks to illustrate Castells’ (1996) call for a renewed focus on what he terms the “applications and specifications” levels of the new CMC industries and their institutional and corporate structures. These are the upper-mid-level decision-making spaces of today’s “information-era” workforces; those working to position the innovations of research and design into markets, professional uses, communities, populations. It is here that the creativity unleashed through the internet’s direct-appeal to a “testbed” of users can be registered and recognized, aligned with market goals, fostered in the release of new hardware/software technologization or services licensing and franchising. And it is here that my graduate students, whether in Government, corporate industry, specialist cultural/subcultural communities, or those new forms of SME/consultancy “indie”-enterprise productivity enabled by the efficiencies of digital media contact, are for the most part positioned. They work as the interpreters of the technologies to the markets, and *vice versa*: What Lefebvre (1991) once called the *decoupeurs et agenceurs*, who move between concept and practice, idea, and product.

In sequence, I ask this group to consider from the perspective of their own agency: their own professional power to activate innovation opportunities; a range of those social and cultural changes occurring alongside the rise of the internet, and impacting upon the structures and potentials with which it has come to be invested. These are not by any means exhaustive, and can be replaced as focal-shift requires, but in the first instance include the following four issues:

- virtuality and disembodiment* as conceptual markers of a major shift from material to symbolic productivity;
- “*remediation*” of internet “content”, or the view that it predominantly reprises existing formats and genres, rather than inventing totally new forms;
- online leisure* as taking up those forms already oriented toward the symbolic, as opposed to irreducibly “physical” or material recreational activities;
- “*Creative Industries*” as a key concept organizing the new, digital, informational economy, and online leisure’s already-evident centrality to both their content and their operations.

1. VIRTUALITY AND DISEMBODIMENT: "LOSING ONE/SELF ONLINE"

Firstly, how might those issues most dominant in study of the new digital media experience: virtuality and disembodiment, be positioned by reviewing how the often very physically centered activities of leisure and recreation are being arrayed and practiced within them?

Further, even where online-mediated leisure activities appear relatively unaffected by disembodiment—as in the case of online games, chat, or blogging—how has the enhanced privacy of “virtual” participation from within secure personal or domestic spaces been reported, diagnosed, and positioned for re-integration into new applications or service design? Should we understand the “virtuality” of these pursuits as perhaps a temporary phase, to be “corrected” by later technological moves (voice enhancement; improved broadband capacity allowing richer visual “habitats”; improved simultaneous language translation; non-intrusive interface design; 4G telephony; and ultimate portability)—or do the popularity and fascination of these processes inherently depend upon their technological distantiation? Rather than side effects of early, primitive forms of CMC interactivity are the various forms of “virtuality” more than spurs for remedial creativity? Do they have things to tell us about our own favored forms of sociability?

Early visions of internet experience focused intently on the capacity of the “virtual” or symbolic spaces of electronic communication to disembody users: to replace physical contact and activity and the identity formations produced within them, with far more malleable forms of textualized and graphic digitally mediated contact. For some, this was immediately a preferred state of being:

For couch potatoes, video game addicts, and surrogate travellers of cyberspace alike, an organic body just gets in the way.

(Morse, 1998: 125)

Even within less extreme formulations of this new mediated interactivity, the number of online transactive spaces and procedures that arose and the speed of their popular uptake suggest that the “virtual” as a space conceived of as between the two “lived” spaces of communication was something familiar, rather than something entirely new.<sup>5</sup> The virtual, whether encountered in game play, the computer-enabled simulated spaces of theme parks or entertainment arcades, online MUDs, MOOs or Habitats, can be argued to have been extending already existent tendencies in consumer culture and the mediated symbolic culture of traditional media, toward recreation of the self.

This identity play, once commodified and recoded into its myriad forms: games; chat; the *bricolage* of self-selecting online shopping; personalized MP3 compilations or mobile phone pop-tune ringtones; “privileged” reader-viewer news services or behind-the-scenes “director’s cut” DVD movie previews, then became an even more high-status activity. Where once only

Hollywood stars or the very wealthy could re-invent themselves; act out new social roles; express personalized style across a wide range of daily activities, now it seemed everyone could.

Electronic communications seemed to have created a new “space”, where many of the social rules—even physical restrictions—ceased to operate. The reality of the internet user: the physical self, did not appear to be “uploaded” into the system. When we went online, “the meat” was left behind (see endless discussion of this in the 1990s new media magazine *Mondo 2000*)—or so it seemed. New “old-media” attempts at imagining, or creating, virtual beings—such as the simulacrum newsreader Annanova; sci-fi novelist William Gibson’s *Idoru*, or Hollywood’s versus Japanese anime’s various attempts at the enacting the cyborg,<sup>6</sup> all acted as models of a new experience, shared at some level by many ordinary internet users: the sense of “making contact” with others, without physical presence, or at least full physical presence.

Already, as researchers were quick to point out, a paradox had opened inside the idea of achieving the disembodied, infinitely changing self of cyber space. To dream such dreams took a society and a culture so obsessed with the physical, as to want to perfect it, even if only in the symbolic form of images or fantasy narratives. In other words, a medium which was said to be about non-body was obsessed by the body—as counter-commentaries constructed over ethnographic work on web-use began to prove. Even on the internet itself, ordinary self-expressive users began to use their upload facilities to “broadcast physical self” in various forms. From the “Jennicam” phenomenon to the rise of the “a/s/l” introductory convention in IRC, the body had proven itself irreducible.

There were, however, other hints at the interconnection between “disembodiment” and already existing experiences of mediated self. This was not the first medium which had offered the dream of re-writing, or re-scripting, or re-imagining the self—processes learned in advertising promises, infinitely deferred; in entertainment centered on glamorous performers, ultra-fit elite athletes, impossibly beautiful fashion models, obsessive body builders. Whether securely in the physical side—sport and fitness—or in the image culture of film, TV magazines, fiction, the “recreation” we are promised in all the various forms of leisure has come to center on “re-creation”—on dreaming or constructing new selves, at the level of body. And as those dreaming, desiring, and constructing activities moved from the artifacts of the physical world to the digitized image-and-text universes of the new media, the “recreation” mode went with them.

Other paradoxes abound. While cyberspace was in fact being set up as a place we all worked in, and through (e-mail, online banking, file transfers, data bases: as Castells (1996) expressed it, a “real virtuality” of everyday use) it was at the same time being “imagined” as a free, “new frontier” space, in which it seemed anything and everything was possible: even the dissolving of our physical selves, and the chance to “transform” into something else.

Was this then a space for more of the same, rather than for something inherently new; in Foucault's terms a slow and broken continuity, rather than a new beginning? Castells (1996) describes the development of a digitized, informational economy, both in its industrial and its personal-private manifestations, as a stage in a much longer process: a movement from high-volume/low-value production (iron ore, wheat, wool) to low-volume/high-value services (data management, information and promotional industries, new media content)—what Bauman has called the commodities of a “liquid modernity”. Many “soundings” or observational studies of this general phenomenon of entry to a symbolic or “weightless” economy have been extracted throughout the past two decades—any of which can serve as a departure point, providing cases and concepts and a vocabulary for discussion of this “symbolization” or “disembodiment”. Taking any one of a range of book-length studies; for instance Morse (1998), on media, art, and cyberculture; Springer (1996) on cinema imaging of virtual sex; Bukatman (1994), on scifi and cyber-self, or Turkle's (see for instance Turkle, 1995) various studies into online identity-play, it becomes possible to locate and analyze powerful examples of internet sites and contemporary user-behaviors, within existing repertoires of cultural explanation.

To this degree, study of online pursuits and virtual leisure is consistent with existing scholarly repertoires, and provided by them with a rich set of explanatory resources. But does this indicate a dangerous accommodation: an appropriation of something as yet unexplored, into the structures, definitions, and pre-dispositions of existing fields? Is this simply to describe the new on behalf of the old: to carry over the concerns and issues raised in one field, into another? Will it lead us to miss as much as we catch?

One way of raising that possibility, and testing it against how online leisure is practiced, is to consider the second conceptual base proposed for this area: whether or not Net pastimes have in fact “created” anew, in the sense of introducing entirely novel concepts, activities, and content—or whether they are re-applying and innovating within existing formats.

## 2. DO NEW MEDIA “RE-MEDIATE” OLDER MEDIA?

This initial focus in itself raises the question of whether critical and analytical perspectives established for and within older conceptual frames may or may not capture all of the nuances or potentialities of new media use. The course sets out to examine how, and how far, digital media and internet practices replicate or transform established aspects of symbolic culture: how far “new” media are in fact new. Calling on Bolter and Grusin's (1999) suggestion that the textual and graphic modes at least around which internet sites are designed “re-mediate” already established text and image genres, this section of study suggests that students submit those websites most promoted as exceptional creative departures to the sorts of analysis Bolter and Grusin model.

For instance, students are invited to take on close analysis of the structure and design of a range of websites, by transferring analytical schemas evolved elsewhere. One example involves work by Kress and van Leeuwen (1998), which suggests that tabloid print-news formats have settled into a predictable structure of left-to-right, top-to-bottom viewing perspectives. This can be used in cross-over mode to challenge website design for the same or similar conventions, to review multimedia design texts, to establish how far the recurrent structures observed online arise from informal cultural consensus, or are in-built within design software. Returning to now-classic pre-digital media analysis of the rise of such once-dominant cultural text-forms as the novel [see for instance Watts (1951), *The rise of the novel*], it is even possible to evoke consideration of whether any communications genre or format arrives in the world *ex nihilo*, rather than, in its early phases at least, being constructed from an amalgam of existing forms.

Once past the glamorous myths of innovation which accompany most new scientific endeavors and into an appreciation of the longer, slower historical evolution of technologies (see especially Winston, 1998) it seems logical to position VLIs, at least in their current manifestation, as somewhere within this “re-mediation” phase of new media development: a moment in which older and existing genres, formats and uses are being re-positioned for online application.

The Bolter and Grusin “re-mediation” hypothesis, however, is worth investigating not simply to help with scrutiny of the evolution of various online text-and-graphic genres (website design; e-mail; webcam use) but as a means for considering the broader online activities and services the internet has fostered. Are these inherently new, or extensions of existing behaviors?

Brody (1999), assessing the progress made so far in the development of multimedia design, suggests that we have yet to find the person or people who can really push these media to their limits: who can make them work to the edge of their potential, creating totally new products, activities, or experiences. He points out that in the early days of movie production, it took decades for the arrival of the Russian film maker Serge Eisenstein, who invented ways of editing and sequencing shots into the sorts of expressive and dramatic narratives we see in film today. Brody asks: where is the Serge Eisenstein of multimedia?<sup>7</sup>

Put these comments together, and we have to consider the possibility that we are still working with a major set of limitations in relation to new media communications—and not just technical ones. Culturally, have we yet really learned what is possible in this new communicative “space” for the play of symbolic activity? Is it the total breach with the past we have been led to expect, or just an intensified stage of a process in train over centuries: from speech to writing, to print, to film and radio and recorded sound, to television, which combined them all, and so to the internet and multimedia, which allow us to interact with, and through, our multiple-image spaces.

This tends to suggest then that those activities we are accustomed to within physical space will recur, and versions of them be reproduced, in virtual space—at least in a transitional moment, but maybe permanently.

And if the recreation of the self, imagining, or even reforming identity into the images and behaviors and social contacts we learn to desire from our engagement with the dreamed selves of our symbolic world of media, is actually the same as the recreation activities we are encouraged into during our leisure time, then the new media are just another space for these activities. We should perhaps already stop thinking of “virtual reality” as a second-order or unreal place, and instead use Castells’ term “real virtuality”. That suggests instead the more accurate view that since we spend more and more of our work and our leisure time online or in mediated symbolic spaces, then these are in fact our new “real”.

### 3. LEISURE AND RECREATION AS “TIME OUT”

A third consideration of online culture focuses on this already well-established reputation for leisure as engagement in a lesser, or less productive “real”. It is here that it is especially interesting to engage these charges of secondary status, or triviality, leveled at online pursuits, with similar conceptualizations bedeviling the fields of leisure and recreation.

All of the words contemporary society uses to discuss leisure time reveal something interesting about its connection with ideas of “time out” from the serious pursuits of life: work, productivity, politics, public activities.

Look for instance at the following:

- Holiday: the “holy days” or religious festivals marked by a break in work, or even by bans on productive work.
- Vacation: a “vacant” or emptied period.
- Leave: an abandonment of the “normal” round.
- Break: a breach in the usual pattern of activity.
- Retirement: falling back from important or central activity: literally, to “draw away”.
- Retreat: often used in religious communities, but also in military strategy, as a move away from fully active engagement.

In other words, there has long been a deep conviction that “real” life is mostly about work and production. Any change in this is seen as a temporary state of abandonment into the less-serious private space of play and self-indulgent pursuit of pleasure.

This focus requires attention to contemporary theories of recreation and leisure, as they have developed in industrializing economies. In part, such theorization rests on Marxian accounts of socio-economic history in Western economies, relating to the split in how households and businesses were

arranged, as productive work moved from the subsistence economy of the family household, or the skilled artisan's "workshop household" of the pre-industrial period, to the mass "manufactory" or mill, or the specialist banking house, shop or store. It addresses the rise of a renewed gendered and age-differentiated social order, removing the wife and children from the daily round of productive labor, into patterns of domestic consumption which included recreative pastimes (health regimes, educational and spiritual programs, and the practice of folk arts and self-expressive crafts). Sociability itself, within the cultural historical work of Western commentators, was included in this gendered division of labor: from the coffee-house public-forums of the *homme et citoyen* who drove economic life (see especially Habermas, 1989), to the formalized "visits" and "conversaciones" and "routs" of 18th and 19th century gentry entertainments (consider the ongoing categorization of the works of novelist Jane Austen, whether in print or screen format, as forms of superior "Mills & Boon-ish", "chick-flick" material).

As this arrangement crept down from the wealthy middle class business owners of the 18th and 19th centuries and into the homes of all, production appeared to have become locked into the public world of work; consumption into the private world of the home. Even more significantly, the pre-digital mass communication systems arising across the 20th century, in particular, are now commonly seen to have promoted and preserved such divisions (see especially Thompson, 1995). They maintained a "stay-at-home house-wife" for the mid-century period at least, by "de-sequestering" the consuming female from the isolation of those dormitory suburb developments enabled by public transport, reconnecting her to consumption activity through radio and magazine marketing, visits by traveling salesmen, and introducing the domestic telephone for discussion of consumer commodities and entertainment events.

Is leisure then inherently feminized—a product of unproductive, interior, affective, domestic space, considered only as an element of consumer behavior? The work of Celia Lury (*Consumer culture*, Cambridge, Polity Press, 1996) suggests that it has been, but that—along with the added "de-sequestrational" powers of digital media including the internet—it is no longer.

"Holidays", originally centered on festivals of consuming: special food, special clothes, special objects such as extravagant lanterns, or floral decorations, or non-productive "artistic" creations or activities: dancing, music, art, had been mostly produced inside the home, and so outside the world of productive (financially rewarded) work. These had been objects and activities disruptive to the cycle of productive work. They meant a short period of non-productivity, which served to mark the usual daily working round as even more central and important. They were domestically and community based, and associated with women and children: the non-productive labor categories.



Across the 20th century however, they too became “industrialized” and certainly commercialized; repositioned inside the consumer industries, as brands moved to insert their products into peak-period “holiday” domestic consumption, and festival originating organizations—including religions—commercialized and merchandised their locations, activities, and souvenirs. As spiritual centers from Lourdes to Mandalay became surrounded by organized commerce, commodity producers such as Coca Cola inverted the process; for instance re-imagining the figure of Santa Claus to place a popular leisure beverage within the celebration of Christmas, by dressing its central gift-giving figure in its red-and-white brand livery. The chocolate trade moved to specialist identification of products with specific holidays, including Easter, Halloween, and Valentine’s Day.<sup>8</sup> In contemporary Malaysia commodity production is booming around the Islamic festival of Aed Al Fitri, celebrating the end of Ramadan. Singapore releases an annual video pop-anthem for celebration of its National Day. Australia has adjusted the timing of the annual Melbourne Cup horse race to accommodate international TV audiences and web-based punting. Each in its distinctive historical time and cultural space signals the re-appropriation of “time out” leisure activities into the commercialized enterprises of productive economic development.

This re-appropriation of the private into productivity is of course reliant on the contrast-formula which defined its position as a space reserved for non-economic activity in the first place. Bakhtin’s (1981) formulation of “the carnivalesque” as a period of symbolic but praxical “mis-rule”, where for a brief time masters serve servants, or bulls run loose in the city streets, or the country comes to the town, or office staff spend the afternoon watching a horse race on TV, drinking, eating, betting, and wearing silly hats, encourages a (temporary) emphasis on breaking the usual social rules, but it ultimately restores the normal social order, and so serves to show how “necessary” those rules must be. But such a revelation also has much to say of how far the concept of leisure as “time-out” is equally filled with unexpected inversions. The seemingly enduring distinctions between leisure and private life, work and public, were eroded well before the capacities of the internet to dissolve physical boundaries.

#### 4. LEISURE ORGANIZED ON BEHALF OF INDUSTRY

As wages and disposable income increase in advanced industrial nations, so does the availability of leisure activities for those now massed in housing in urban areas. Workers living close to workplaces, are far from the traditional spaces for “holiday”. Increasingly, these new mass societies move away from shared cultures of celebration of old rituals, as religions, language groups, and people from different origins mix in the new industrial cities.

Such massed populations were seen as dangerous—in much the same ways unregulated internet users have been—if not always organized and controlled. Both are considered especially dangerous during breaks into “carnival”. An industrial economy set up ways of controlling the carnivalesque: typically, by turning it into another industry—called “leisure”.

The space for non-production—the time for consumption only—itself became formed into productive industries. One after another, the types of celebratory activity that were always connected with recreative pleasure became organized into new industries.

#### **4.1. Organized Sports**

Games, once played in different traditional ways in different locations, but mostly loose in their organization and participant activities, became codified into “sports” for the masses—along the lines of the “sporting gentleman’s” life. Those un-productive time-consuming activities which had once been for the aristocrats: hunting, shooting, fishing, riding—became re-structured: shooting clubs, weekend fishing on the industrial canal banks instead of in expensive trout streams in Scotland, bicycle riding instead of horses . . . “Royal tennis”, played in a complex purpose-built courtyard, became a weekend game in public parks or middle-class family gardens. Football, cricket, hockey, and many others evolved from village rituals or children’s games into health and fitness activities, and then into mass spectacles for huge industrial urban populations.

As the 20th century arrived, providing mass print, audio and visual media to expand those audiences and introduce profitable cash flows, professional sports people and sports industries arrived. So powerful did sports spectatorship become: physical sport experienced vicariously through national or local heroic performances and organized annual rounds of competition, that entire national regimes felt compelled by mid century to set up “participation” institutions as well—from totalitarian health and fitness organizations to campaigns such as Australia’s 1970s “Life: Be In It” promotion, with its “keen sportsman” “Norm”, finally persuaded to abandon the couch and TV for a little therapeutic walking.

#### **4.2. Organized Travel and Tourism**

Travel and tourism, once the preserve of the rich, also spread out as disposable incomes rose—especially at the end of the 19th century, as first the railways and steamships, then road transport, then air travel, made more and more destinations available for a reasonable cost, and in a reasonable time frame—for instance, the 2 weeks of annual holiday most industrial and commercial workers had now negotiated through the labor Trades Unions. Where

originally travel had been long term, modeled on the “Grand Tour” undertaken by the sons of wealthy English aristocratic and gentry families seeking education and “improvement” from contact with European art and high culture, usually a 2-year trip with a private tutor, now ordinary people set out for a week at a seaside resort, or a “charabanc” daytrip to a pleasure spot. But the idea of “improvement” from travel remained—as it does to this day. Views that “recreation leave” renews the spirits and the energy for work are central to promotional discourses within the travel industries, as well as within medicine and fitness, while longer trips—such as the young person’s “gap” year of travel between school and work, or Prince Harry’s “work holiday” in Australia—are thought to teach maturity and self-reliance.

#### **4.3. Recreation Through the Self-expressive or “Imaginative” Arts**

The imagination, or the private and introspective “fancy”, as opposed to the pragmatic and public “reason” had been considered the part of the mind which led to indulgent daydreaming—licensed in creative artists or artisans such as poets, painters, or musicians when they constructed their works, but not advisable for ordinary people, who had manual or skilled work to perform in their public lives, and family support activities in the private realm of the home. The rational mind was thus superior, and the imagination released only in exceptional persons (persons possessed by “genius” in a process disturbingly close to insanity). But as sectors of the social order were one after the other removed from productive labor, the imagination became a space which they were encouraged to enter in order to “recreate” or occupy time (preferably by consuming some new “imaginative” product there—from sheet music for the piano to penny-dreadful novels and cartoons and comic books for the urban masses; from parlor board-games to sketching or amateur photography; from pre-printed embroidery patterns to assembly kit radio “crystal-sets” or “Meccano” construction kits for boys . . .).

Fantasy became a part of this “space of the imagination”, opened first to children, as fairy stories (Hans Christian Andersen, the Brothers Grimm), children’s books, films, animated cartoons, elaborate mechanical toys, radio, and TV for children came to have their own special market. The “imaginative spaces” of symbolic texts and products (books, comics, TV shows, recorded music) were added to with public physical space for play: pleasure gardens, playgrounds, theme parks, games parlors, franchised restaurants such as MacDonalds—and then multimedia products, designed largely with a child audience in mind.

So in terms of both time and space, leisure has been positioned as the “not everyday”: as the place where productive work is suspended, and the self is “recreated” by a change of place, a change into imagination and fantasy and out of physical reality and rational thought, or a “simulated” place for

unproductive and potentially disruptive and dangerous body activities such as sport—or sex for pleasure, or chat for sociability.

As the social order produces new media activities for internet consumption, it can be seen to “re-mediate” these older forms and spaces and their contrasts between production and consumption; the rational and the imaginative; the everyday and the holiday. Those very technologies that most unsettle old divides between private and public, work and holiday, productive and consuming activity are still re-working activities and genres established in much older spaces and cultures. From *Mortal Kombat* to *The Sims*, online games still present heavy degrees of gender-division in their design—even where they are played by both males and females. IRC spaces, notorious for claims of cross-gender deception, show heavy levels of gender-segregation in both their searchable topic selections and their online “chat” styles. And while the click-count registrations, which rate websites for the calculation of advertising revenue returns, act as a powerful acknowledgement of how far even recreational internet use is now linked in to productivity, the degree to which this remains a covert technologization, invisible to website visitors, maintains the old distinctions between “work” and “leisure”.

How then might these distinctions be overcome—and is internet experience, itself technologizing a re-integration, able to signal the importance of that move? Are we aware of what we are “doing” online—and, as many online commentators have suggested, are we giving too much away?

## 5. LEISURE AND THE CREATIVE INDUSTRIES

New media industries, their operations carried by the penetrative powers of the internet, drive further in than ever toward private, consuming spaces—re-tracing them as “symbolic” spaces of recreation; spaces given over to activities promoting “affect” or intangible emotional and imaginative responses. This new amalgam of the organized leisure industries and “personal” interests, with emphasis on identity work or transformation of “the self”, makes their operation part of the newly conceived “creative industries”.<sup>9</sup>

The “new economy” produced within the “information society” is, as Castells (1996, 1997) tells us, about information, global connectedness of production and consumption, and networking. This constructs inter-penetrability, able to carry desire and demand outwards (“pull”) and supply and promotion inwards (“push”). Knowledge—or at least information—is thus important in all sectors of both production and consumption. Only such a weightless form can drive “push” and “pull” at the speeds needed in the new economy. The internet, along with its many peripheral forms, is prime platform for these new flows.

The “culture industries”, a term which in the mid 20th century referred to “popular culture” or “mass media” such as movies, music recording, fashion,

the media, magazines, and advertising, were originally conceived as providing commodified, debased, inferior, and reproduced art and leisure pursuits for the recreation of the industrial masses. But by the later 20th century, these products, and the style and taste codes schooled by them, had become increasingly dominant, building up successful bricks and mortar industries and business corporations, as agents providing the key symbols of personal, national, and cultural identity. With media industries among the giants of the global economy, “symbolic” production itself was becoming dominant. No longer seen as a secondary space of trivial play, it was now an aspirational space for both work and recreation.

This new role meant that the “recreated” self was now commodified in “leisure industries”, such as tourism, entertainment, fashion and design, food and hospitality—and the growth of the services sector in world economies demonstrated how powerful this sector had become.

As design and style spread out: no longer just the marker of the wealthy, but used across the social spectrum, an estheticization of everyday life becomes central. Consumer finance and so the industries to service it turn increasingly to issues of “style”. Material needs are largely met, so consumer desire turns instead to “the aesthetic”, or versions of beauty, image, and fashion. And Governments seeking to develop industrial production in a saturated commodities market also have to take this turn toward the symbolic product. Terry Flew, in *The new media*, Allen & Unwin, Sydney, 2002, shows how for instance the Blair Government in Britain moved to the development of “creative industries” in 1997:

The role of creative enterprise and cultural contribution, is a key economic issue. The value stemming from the creation of intellectual capital is becoming increasingly important as an economic component of national wealth. Industries, many of them new, that rely on creativity and imaginative intellectual property, are becoming the most rapidly growing and important part of our national economy. They are where the jobs and wealth of the future are going to be generated (Smith, 1998).

New high-value enterprises include content provision for improved, high-speed but content-hungry broadband services: old and new media linking together in producing content that crosses media platforms (and will do so more easily once radio and TV join print and graphics in a wholly digitized technology). Flew shows how in 1997, copyright became the USA’s largest export earner: 414 billion dollars worth of books, music, films, TV. The Spice Girls and associated products were Britain’s biggest export that year. Pop culture rules.

But creative industries are still not fully engaged in the economic models and systems which drive national economies—and according to Flew, may never be. He cites Caves (2000) who has outlined seven reasons for this:

1. Problems in assessing demand for creative product, where selection by consumers is subjective, based only on experience of the commodity after it has been produced.
2. Satisfaction flowing to creative producers from factors other than profit: artistic expressiveness for instance—yet the need to reconcile this with profits and income and deadlines and auditing and accountability.
3. The large creative teams needed for creative media products, with many different specialist skills, often arising in different value cultures (to test this note how long the credits are on today's major movies, as opposed to those of only 30 years ago).
4. The huge variety of products both within categories (e.g., individual music tracks) and across categories (music on CDs or DVDs). How do consumers remain expert enough to choose? Or even to choose experts who advise?
5. Vertically differentiated skills: there are hierarchies of talent, and disagreements on how it is assessed.
6. Co-ordinating different creative activities in tight production timelines. There is often loss of cult style power in long productions runs, or over long celebrity careers.
7. Durability of products, especially in new media technologies, which have the potential for taking up archived and re-issued product, and so a capacity to extract new profit over longer periods.

Each of these leads to specific instances of major risk and uncertainty within the creative industries—one reason why public funding or corporate sponsorship is still sought. Such problems then move these creative production activities to models outside the standard industry experience. Creative industries may always be “special”—not like organizations involved in physical commodity production.

Do they then suffer from the same sorts of “unpredictability” as the internet: victim of their own accessibility, variability, and potential for fast-feedback and obsolescence? And are they, like the layers of failed “Big Enterprise” ventures already littering the new economy, doomed to share the “one project” lifespans of traditional arts and creative ventures? Certainly, as Flew points out, new media are mostly produced in start-up or SME companies (small-to-medium enterprises), and not in big industries, such as Hollywood movie companies, or the big music recording labels. The much smaller new-media firms contract to larger mixed-media corporations, who in turn manage their risk, marketing, advertising, and so on.

Is this a slow movement toward establishing large industries? Are we just looking at a stage in the “new media” industries? Media history tells us that film and radio developed in just these ways—as the start ups and SMEs of their era—although TV demonstrated elements of the giant media-company

structure, founded on its predecessor industries, film and radio. So is the “creative industries” view correct or are media giants such as PBL or Time Warner already stepping in?

One argument in the “creative industries” account of new media productivity centers on debates over the fact that information flowing through the new digital networks produces little, until “communities of practice” establish to apply this knowledge. This means that the “volunteer” labors of internet users—such as those people who write reviews for Amazon.com, or advertise on eBay—are crucial to the work of these sites and services, and to the image of the internet as dynamic and busy. Does this “voluntary” interactivity show the next step forward in networked symbolic productivity? And if ordinary users contribute, should they do so for free?

Flew cites the work of Andy Pratt (1998), who adds to Castells’ characterization of the internet by showing that information as a symbolic entity is not only “weightless”, but also socially embedded. Its products and activities arise from and are engaged back into communities of users. Cultural activity increases where people cluster to use and apply knowledge: in the physical world, mostly in cities, and mostly in groups focused around younger adults (18–35). Such groups are heavy users of symbolic products, as they perform identity-formation work around style and aesthetic expression. See for instance Hebdige (1988), for the “revolt into style” hypothesis, which suggests that as younger adults and children are progressively moved out of the world of productive labor, they take up identity formation around consumption of symbolic product, creating “selves” through film, TV, magazines, fashion, music, and cult activities such as being in “cool” places or using trendy communicative technologies—most recently the mobile phone and internet.

Pratt sees post-internet generations of young adults as already expressing new values, formed around new experiences vectored through digital interactivity and speedy communication access. For this key group, symbolic consumption and physical productivity are already the same thing. Pratt itemizes the various cultural values which signal this new departure:

- making culture and making money are seen as the same activity;
- work time and leisure time are not distinguishable: both are co-present and have the same value;
- informal networks and not established institutions pass on the most valued information;
- intuition, emotional involvement, enthusiasm, and immersion in the field are valued; and
- cultural producers want to work for themselves and not in regulated, hierarchical nine to five institutions or corporations.

Each of these new values can be interestingly illustrated and exemplified in experience of internet-enabled new media use. What remains to be calculated is whether these values remain exclusive to the “Y generation” (1980–2000) who

grew up with video games and the beginnings of the information economy—or will hold good for an entirely new cultural direction and economic system. Part of the study of VLIs involves amassing evidence for that debate.

Is the “communalism” of these groups established by the new networks, or *vice versa*? Is the flexibility of production arrangements seen among Pratt’s young new media producer–consumers a response to the new set of circumstances within creative industries, where styles change quickly and new SMEs and start-ups form and reform—or will these new media enterprises become large establishments and corporations, in time?

With these considerations in mind, any one of a still-evolving and extending list of virtual leisure activities or “industries” can be selected and considered. Given the “re-mediation” hypothesis, and the focus on considering continuities or cultural contexts and so longer than usual periods of development, each will have its own circuit of origins and influences, accessing the primary dimensions of “online” status differently, and with different results. Student interests and backgrounds to date have taken them across an array of fields, from sex to sport; fan culture to family genealogy; gambling to gaming. The list is ever-growing, and indeed one of the concerns of the field is to test whether new activities identified during a period of study are already “within” the ambit of established creative industries, or are contributing something taxonomically different. (For instance, will experts at online “modding”—re-writing aspects of games software to suit the tastes of online communities—be integrated back into games companies, or will they set up fee-pay online services themselves?)

To illustrate some of the ways in which online pursuits activate the range of ideas outlined above, I will conclude by indicating how just two examples of current VLIs drawn from informally and formally constituted “Creative Industries”: sex online and sport-related internet sites, create an “interrogation” of both their own field, online leisure more generally, and the internet.

In the first instance, examining online sport, I will show a little of how the hypertextual structures of online study-delivery promote an interrogative or exemplar-generative approach to study, interrupting a study of the major developmental features and concepts of leisure and sport. As the online “discussion stimulus” topic-boxes for self-directed study arise on the site, each is inter-spaced with a series of questions, inviting the reader to conduct online searches, locating examples, and critiques to reconceptualize the “mainstream” account of sport as leisure, within the new experiences offered by its online variants.

In the second instance, online sex, given the difficulties within the field and its near-eclipse by associated matters of governance (regulation and censorship; psychologistic regimes of pathologization), the materials instead move to consider the ways in which a specific field of online use, such as sex-services, can achieve prominence within the social and cultural domains producing and directing a medium such as the Net, in the absence of real research evidence on its uses. Here, the study itself moves back a little, to consider the power of



one field of Net use to regulate and control all of the others. This in turn is used to open the entire concept of VLIs to the suggestion that it already contains incommensurable and unequal fields: that it, like the internet itself and the social order producing it, is a space of and for contestations, re-articulations, and often surprising convergences.

## 6. EXAMPLES OF VIRTUAL LEISURE INDUSTRIES

### 6.1. Sport

In moving to examine sport online as just one concrete example of practices surrounding online leisure and recreation activities, it is useful once again to test existing accounts of the development of sport-as-leisure against the “new” practices offered to online sport enthusiasts—whether practitioners or spectators. Does online sport continue, or depart from, those patterns of development reproduced in contemporary accounts of sport-as-leisure-industry? Which aspects of online sport-related activity dominate, and might be said to innovate or reinforce established developments?

This section takes up a recent study by David Rowe, *Sport, Culture and the Media*, Open University Press, Buckingham, 1999, into the role of sports media in controlling social and cultural uptake of sport-as-leisure through the strength of sports spectatorship. His account of the mediation of sport across the 20th century is used to invite analysis of new online sport sites and activities. What this sets up is the opportunity for “interrogation” of this largely historical account, testing against it contemporary practices, which may or may not sustain its hypotheses and findings. To reproduce this “interrogative” form of study, I intervene into my own précis of Rowe’s text, to introduce issues from online sports activities, sites and behaviors, so addressing some of the questions formulated above—and hopefully both modeling and evoking in students/readers the sorts of interactive, even hypertextual practices central to both online practice in general, and internet study in particular.

Rowe begins by reminding us that sport itself is a surprisingly modern concept.

Although most societies have traditional games which structure play in some way, these were rarely organized into the sorts of regulated, competitive, team-identified cycles of events for mass spectatorship, which we consider to be sport today.

*Search online for examples of traditional, non-mainstream sports which to your knowledge have not yet been commercialized.*

*These may arise in traditional ritual, ethnic communal activities, isolated regions outside the industrialized economies, societies resistant to industrialization for religious or political reasons, or because they have the*

*status of being minor variants of otherwise “mainstreamed” sports (for instance, women’s cricket or “Kalikiti” in the Pacific nation of Vanuatu). At what stage might any or all of these become “commodified” in the ways Rowe outlines? Are there examples of minor sports currently undergoing such development? What roles are being played by online mediation itself in these processes?*

Even when large mass spectacles did emerge—the prime example being the ancient Olympics—these had now-forgotten significances, such as artistic or religious celebration, attached to them. And they disappeared, along with the cultures which produced them: the modern Olympics were introduced only in 1896.

*Revisit the Athens 2004 Olympics websites and examine their accounts of connections between the ancient and the modern Olympic movements. How far did the visual codings used to characterize and promote the Athens 2004 Olympics capture the iconography of the traditional Olympics? Can such iconography be cut away from the beliefs and ritual activities of its origins, to be applied to global media audiences, without entirely altering its significance?*

David Rowe states that:

*sport as a recognisable social and cultural institution is not universal but emerged in a particular location (Britain) at a particular time (early industrialisation)*

(Rowe, 1999: 13).

Rowe attributes this emergence to features which had existed for some time in British social life, including:

- longstanding traditions of rough physical competitive play [Rowe cites Elias & Dunning (1986) for their descriptions of village contests which took the form of games rather like disorganized forms of football];
- activities for both competitive participation—often with prizes—and spectator enjoyment, and sometimes betting on outcomes, but which happened only on special occasions [Rowe suggests Clarke & Critcher (1985) for accounts of boxing, wrestling, cock fighting, and horseracing on religious holy days or market days]; and
- examples of Court or Government edicts that such unruly behaviors during leisure should be organized into “useful” military skills competitions, such as archery.

*How far are these motivations and regulatory demands still evident in contemporary discourses surrounding sport? Can you find arguments being made for online technical, social, or competitive skills as part of the skills or attitudinal base for “useful” military, industrial, or commercial activities?*

*Is the intention of diverting excess energies into “useful” skills such as para- or proto-military fitness completely eroded by the “virtual” status of mediated sport, or are there still arguments circulating that online games are good for developing “strategy skills”, or “hand-eye coordination”, or “competitive spirit”?*

*Is sport online wholly a mediated, virtual experience, or does it also have ways of attending to physical skills development? Can you find examples of highly mediated sports, such as golf, or tennis, or sports with high degrees of online chat and/or image exchange, continuing the specifics of “training” for excellence through advisory coaching video, graphics, texts, dialogues . . .*

*Are there any examples of new sports or fitness activities which combine the visual/data feedback loops, or non-proximate interactivity via the Net, with physical action?*

Rowe cites Weber (1930: 167) to comment on how those who controlled society most often saw sport as a form of dangerous and un-controlled behavior:

Sport was accepted if it served a rational purpose, that of recreation necessary for physical efficiency. But as a means for spontaneous expression of undisciplined impulses, it was under suspicion; and insofar as it became purely a means of enjoyment, or awakened pride, raw instincts or the irrational gambling instinct, it was of course to be strictly condemned.

*Traditional public media have perpetuated many sport-specific forms of these “moral panic” discourses. See for instance “football hooliganism” in the United Kingdom especially, or “ugly parent” syndrome in children’s organized competitive sports. Are these behaviors also practiced in online media and discussion sources for sport activities?*

Rowe comments that many of these sorts of fears of the “un-control” of games—another form of the carnivalesque—are now licensed or even encouraged within organized sport. He details, for instance, the ecstasy of victory, pride in a team, shouting and barracking, wearing crazy clothing and make-up in team colors, the crowd euphoria at witnessing a scoring move, violent mass

action such as riots or “hooliganism” after team losses, the loss of self in mass activity, such as “the Mexican wave”, and the risk of gambling on outcomes:

Sport can be seen to be an important symptom and a partial cause of a move away from a social order founded on the repression of physical play, and its pleasurable accoutrements, to one which not only accepts such pursuits, but also promotes and makes “capital” out of them.

(Rowe, p. 15)

*Select any two mainstream contemporary sports and examine online merchandising associated with one high-profile club or team.*

*What is under offer?*

*How are the commodities promoted, in the cause of advancing which practices, behaviors, images or values?*

*What is being “expressed” about the club, team, or even nation?*

*View a major sports event, either live or on TV, while simultaneously keeping an eye on its web promotions, streaming, news reporting, chat groups.*

*Are the values fore-grounded at the game, on the TV presentation, and online, the same? What is fore-grounded in each?*

*What are the particular pleasures available in each—and in the combined experience?*

*Trace the media and new media input required of one selected sports practitioner during a major event: on the field, via the traditional media, and online.*

*What do you learn of the “persona” presented by a single individual, through each of these locations?*

*Is this person always, and everywhere, exactly the same? Are the same insights and issues covered in all these media, or do some appear to be offering different or specialized perspectives?*

It is important to consider what caused these changes from unregulated to “organized” sports—and formed sports audiences in various ways, moving them on to “identification work”, immersing their own identity into the values and symbolic codings of their preferred sports and teams and players. This new focus on sports spectator–consumers prepares us to witness even newer online forms of spectating and consuming sport—ways which, because the primary activity (playing the sport, or attending the game) is less and less available, compensate through the rich layers of commodity made available for repeated, self-selected, and identificatory “participation”.

Rowe outlines the traditional argument: that a massing of workers for the new industrial cities after 1780 caused concerns about “uncontrolled” groups roaming free while not working—and likely to engage in riotous sports, risking civil order and injury (the 18th century word “mob” is a short form of the word

“mobile”—which then meant a loose and dangerously unpredictable group of people).

Shift-working factory labor, industrial city living, new democratic and revolutionary political ideas all shifted sport from being a dangerous activity to be suppressed, to one which could be controlled, directed, and useful—both for keeping bodies fit for hard manual labor, and minds directed to the sorts of organized timetables and cycles arising in mass manufacturing work, as well as promoting the competitive spirit of capitalism.

Boys’ schools began to promote sport not as immoral and undisciplined, but as part of the formula for “the healthy mind in the healthy body”. These were the sorts of manly, semi-militaristic virtues required to run businesses and rule empire. The “amateur” or “lover” of sport demonstrated “selfless devotion to the sport, fellow team members and competitors” (Rowe, p. 17). But while “gentlemen amateurs” were initially opposed to the base practices of professionals (for instance, pugilists or bare-knuckle fighters, as opposed to boxing and the Marquis of Queensbury rules); working class mass spectators began to demand the superior skills and the monetary rewards of professional sport. See, for instance, the code-division into amateur rugby union and professional rugby league in Britain and France in the 1890s, and the rise of soccer in the British industrial cities.

*Do these historical trajectories for the development of what are now mainstream “sports industries” still hold for sports which are emerging today: for instance, the “extreme sports” developing in modern urban street culture, such as skateboarding, in-line skating, BMX, or one-on-one basketball?*

*Many of these new sports, not yet fully organized as industries, have achieved a “cult of cool” which has seen their best proponents provided with digicams to collect video for dance clubs and advertising use. How far do they also achieve online presence?*

*Are these examples of the sorts of “image culture” which Pratt identifies as dominating today’s virtual pastimes?*

Rowe sees the rise of sport in Britain as the first industrialized nation, as directly implicated in the new organizational features of manufacturing: the separation of workers into specialized skills, and the segmenting of the working day into shifts and timetables to suit the production process—which left “tired” workers to be “recreated” in non-work or “leisure” time.

*What then is being “recreated” in workers in their online “down-time”, through the provision of online sports-related consumption activities?*

*To what extent are online sports activities continuous with the “developmental” goals of today’s industrialized sports activities: regulation of*

*crowds; distraction from more dangerous or enervating activities; compensation for too much focus on expressive-imaginative “feminized” or domestic forms of consumption . . .*

*Is online sport purely about consuming the same product in a different and more accessible sphere, or does it involve other elements?*

The standardization and rule-embedding of a “safe” and “efficient” work practice spilled over into games and sports as well (injury at sport could also impact on skilled work).

*How far are sports injuries or unsafe sports practices part of the discourse of sport graphics, reports, and discussions?*

*How far do the attractions of sport: its speed, daring, and physical risks—rely on these “unsafe” qualities, and how do these get taken up in online communities—whether fan or journalistic sites.*

At the same time, sport became enclosed into commercial venues, so that spectating could be sold. Rowe shows that finally a “whole economy of sport” evolved, including the following features:

- Clubs and societies were organized, with subscribing members—allowed to play, and with privileged spectator access.
- Competitions were organized, with prize money.
- Imposing venues were built for large crowds.
- A labor market of sports professionals grew, to value and transfer players.
- State funds were allocated to develop sport for national prestige.
- Sportswear and other merchandise were developed and marketed.
- Specialist media were devoted to promoting sport.

*Find examples of online activities supporting each of these, within one selected sport.*

*At what stage of this developmental line does a hierarchy of value and causation: real sport, and then spectatorship; reverse. Does spectatorship now follow from, or bring about, an interest in sport? Does real power shift to fans and consumers once sport is mediated—and is this sped up and intensified through internet sport?*

*How far does such a reversal have to develop, before it could be said to have achieved a “virtualization” of sport?*

*How does the interactivity enabled by online digital media feed back into the physical sport itself? Consider for instance digital TV and camera angle changes; the use of video and sensors in coaching; electronic scoreboards and line-call mechanisms such as “Third Umpires”; the fine-tuning of performance times to the millisecond; the feedback-electrode*

*scans used by athletes to adjust their bodies to achieve better performances and skills.*

*Given the expense of a professional sporting life, and the need for commercial media-based sponsorship, is the sporting body also already virtual through its required mediation? How far is internet access intensifying that mediation?*

Initially, sport had been about participation.

By the end of the 19th century, it was about physically present spectatorship.

By mid 20th century, it was about mediated spectatorship: radio, TV.

By the late 20th century, it was about mediated spectatorship and identification *via* merchandise, gambling, fan activities—and information flows on websites.

Is this then a movement away from the physical to the symbolic—or back again?

What does the internet add to this trajectory of “cultural uses” of sport?

Is internet sport or virtual sport changing the nature of sport “participation”? Is this a new direction, or “more of the same” but in a new medium? Consider new activities arising through virtual media—for instance the Korean pad-interactive game called JumpDance, which has now developed into a popular competitive sport. How far is this “not” a sport, in that it is a computerized game? How far away is it from athletes competing against their own electronic performance records, or “correcting” their stance or strokes through use of video or animated models?

All of these de-stabilize distinctions between the embodied and the virtual. But are these entirely new directions? Ten years ago Australian researcher Nightingale (1992) found examples of spectators watching Australian Rugby League at home on TV, enacting each of the key plays in the living room, with their own football. Was this mediated, or physical sport? Satirical TV sports commentators “Roy Slaven and H. G. Nelson” have shown video footage of young children playing “mediated football”: speaking out the radio or TV commentary as they play their own game of Australian Rules football on the school ground. These intriguing examples of an “immersive” sports experience: one which merges mediation and physical participation, suggests that Pratt’s new generation of media users who see material and symbolic as fused, are already at work in the sports culture.

### 6.1.1. *Useful Links and Readings*

#### 6.1.1.1. General

Search under “commodification” in *Amateur Athletic Foundation of Los Angeles Virtual Archive* for range of articles on the history and processes of leisure commercialization.

For instance: Stephen, A. (2000). One day in September: grass roots enthusiasm, invented traditions and contemporary commercial spectacle and the Australian football league finals. *Sporting Traditions* 17(1) (November).

#### 6.1.1.2. Online Sport Fans

Layden, T. (2003). Caught in the net. *Sports Illustrated*, 19 May, p. 46. Access via Ebscohost database/Academic Search Elite.

#### 6.1.1.3. Economics of Sport Online

Salkever, A. (2003). Sports score big online. *Business Week Online*, 15 April. Access via Ebscohost database/Academic Search Elite.

#### 6.1.1.4. Examples

BaggyGreen.com—Australian cricket. Available at: [http://www-aus.cricket.org/link\\_to\\_database/NATIONAL/AUS/](http://www-aus.cricket.org/link_to_database/NATIONAL/AUS/).

AFL (Australian Rules Football) Official site: <http://afl.com.au/>.

Yahoo! directory of sports related community sites: [http://dir.groups.yahoo.com/dir/Recreation\\_Sports/Sports](http://dir.groups.yahoo.com/dir/Recreation_Sports/Sports).

## 6.2. Pornography and the Sex Industries

In the first piece of Australian research involving online ethnographic evidence for the actual uses of online pornography, McKee (2004) has revealed the popularity of the internet for the downloading and viewing of pornographic material. Of his research team's sample of 612 Net users invited to comment on their uses of pornography, 316 reported sourcing materials *via* the internet, as opposed to 6 *via* pay sites, 190 by purchasing videos, and 169 DVDs, 136 by purchasing magazines and 41 selecting novels.

As is common in so many surveys of online uses, six of the 10 top internet sites for Australian men provide pornography. The estimate is that by 2002, 2.5 million Australians per month were visiting adult sites (the entire national population is around 20 million). McKee estimates that online pornographic consumption is worth about \$A43 million per year, and already about 11% of the total national pornography market.

Pornography is a complex field, since the definition of what it actually involves is elusive, and changes according to the reader/viewer. Australian culture at least cannot even agree on a single term, using the following in various forums:

**Pornography**—*Porne*: Greek for whore; + *graphein*: to write: = “to write about whores”.



**Obscenity**—*ob*: Latin for “to”; *caenum*, Latin for “filth” = “to direct us toward filth”.

**Erotica**—*Eros*: the Greek God of Love = “writing and images about matters to do with the act of love”.

Pornography is a necessary central concern in a discussion of VLIs because of its prevalence within—and some argue, influence on—multimedia and the internet generally. According to some public-media accounts, the internet is about little else but sex . . .

Certainly pornography indicates, better than any other issue, fears about the erosion of distinctions between public and private spaces, and of the power of traditional public institutions to control or regulate even “private” consumption activities. This erosion is produced, as in many previous instances, by interactive media and the arrival of self-selected access to full international information flows of texts and images and anonymous social contacts, moving into the private spaces of “home”.

Pornography more than most other media forms forces us to clarify issues of how we have come to consider that reading text and looking at images is not just about seeing them, but about what they in turn might “do” to us as we look. Creed (2003) reminds us that the visual materials brought to us first by cinema, then television, and most recently personal-use materials *via* VCR, DVD, and the internet, combine two disparate yet powerfully entwined levels of experience. She speaks of screen-culture’s

. . . two seemingly contradictory elements: its unique ability to capture ‘the real’ and its unusual power to present the world as if it were a dream, to screen images and activities which flow across the screen not necessarily in terms of narrative logic but as if they had risen from the depths of a reverie, fantasy or nightmare. Through editing film can yoke together disparate images to create atmosphere, mood, sensation, eroticism, desire. The evocative power of the cinema is perfectly equipped to suggest, reveal and display those desires considered perverse or illicit (p. 24).

It is this power to recombine and to evoke which most unsettles social controls on what is or is not considered legitimate for general viewing: which provokes fears of uncontrolled response. And there are conventionally three positions taken up on this “see-and-react” position: on the traditional “effects” views of mediated material as it intersects sexually explicit visual-media content:

*Conservative-moralist*, which considers that viewing of “obscene” materials produces sexual arousal in individuals, and should be either controlled or banned outright; that it offends cultural or religious views, and de-sensitizes individuals to immoral acts in general.

*Pornographic*—more recently often *feminist*—which believes that materials used to promote (most often male and heterosexual) sexual arousal devalue women to promote the sexual pleasures of men; that pornography is thus not about sex, but about power, and that it allows men to internalize messages about women's sexual pleasure being suppressed in the service of men's sexual pleasure, and so leads to real acts of sexual suppression or violence by real men against real women.

*Liberal-erotic views*, which see mediated sexually stimulating materials as about harmless fantasy, potentially at least artistic, sexually pleasurable, and possibly even sexually liberating and therapeutic.

Each theory in its way suggests both that there is an effect from uses of sexually explicit media, and that the broader society should decide about how we all should use or be able to use such products. In other words, regardless of the hypothesis or explanation favored, each view of pornography posits that what happens within a “virtual” zone, technologically mediated, involving representation, such as video/audio or even text pornography or sexualized chat on the internet, impacts in some way upon what happens in the physical world. This in itself is an interesting circumstance, given the varying positions taken up on this issue elsewhere.

Each hypothesis depends of course on values established elsewhere in society and culture: values about social power and how it should be framed and managed; about morality, social control, political intervention, gender relations. None of these concepts can it seems be fully empirically tested or scientifically “proven” on the humans who hold them (despite McKee's hopes for an ethnographic means of establishing empirical data on online uses of pornography), so that each explanatory frame remains in social science terms a “normative” theory: it depends on the consensus or “norms” located within various social and cultural populations.

In a multicultural society, and especially on a global medium, each of these sets of ideas, and all of the specialized sets of beliefs associated with each of them, will be contested and represented.

But for the purposes of inquiry into what pornography on the internet reveals about the operations and nature of VLIs, the major interest is once again with the “virtuality” of the mediated-sex industries: the way that symbolic materials—images, sex-chat, videos, texts—are designed to have physical effects on users—even if these effects are dependent not just on body stimulation, but on the complex social and psychological narratives and “ways of seeing” learned within a culture.

Two issues to consider, as sexual material moves online:

Research into the history of “screened” sexual material—the whole development of filmed pornography up to the internet era—is discussed by U.S. researcher Williams (1990), who shows that this industry has actually been responsible for innovative ways of representing the objects under the

viewer's gaze, and for optimizing the inter-activity implied in screened images and narratives.

*Is pornography then a technically more innovative industry than has been supposed? Has the relatively direct relation between the viewer and the image; the user and the activity, been important in the development of the new media more broadly?*

*Have some of the directly relational services of the internet (e-mail, chat, image exchange) linked themselves to the pornographic/sex-services practices established elsewhere, to "activate" whole new groups of users?*

One Australian researcher comments on how her research field of pornography users, not considered a suitable topic of conversation by her middle-class colleagues when she began, is "no longer the scary and/or embarrassing secret they hid under their beds" (p. 196). She suggests that more and more Australians are using mediated sexual materials on a regular basis: that this is normalizing socially.

*Review some of the options available on the internet for DIY sex: see for instance e-mail affairs (Stretton, 1997); sex and identity and home pages (Kibby, 1997); the representations of "techno-sexuality" used in computer games and techno-magazines (Luke and Luke, 1997).*

*Is there evidence for the strengthening of a DIY approach to sexual representations and to the establishment of a wider range of sex-relation work online—or are older established forms also increasing their presence?*

Springer (1996) showed in the early 1990s how the initial "disembodiment" idea of virtual media as a disconnected space of "mind" has been worked into narratives of sex-in-cyberspace, producing even general-consumption materials showing the internet and cyberspace as saturated with euphoric, even orgasmic, "free floating" states of sexual pleasure, and available for fantasy sexual encounters and play across physical sexual identity. Has the pornographic new-media field alerted us more clearly than other new media activities, to the way that the "free space" of the internet and related multimedia representations of cyberspace actually connects the physical and the symbolic?

In a recent Australian collection on new developments in the ethics of online communities, Albury (2003) has revealed emergent formations around uses of online pornography as a "DIY" exchange, suggesting that in at least some cases internet pornography is legitimizing not only the downloading of pornographic materials for personal use, but also an entire "domestication" of the field, "allowing porn fans to become amateur pornographers in their own bedrooms" (p. 197).

Most importantly, it allows those who feel left out of mainstream explicit and non-explicit media representations of sexiness and sexuality to create the kind of porn they want to see. As one of my interviewees, a lesbian-porn producer/performer, put it, producing this kind of cottage-industry or DIY porn 'is like a freedom to wear sexy clothes, or get naked or be exhibitionist . . . but do it . . . where our sexual preferences lie' (p. 197).

Is the internet "democratizing" pornography, spreading its repertoire? Creed (2003) also suggests this kind of broadening effect from online technologies:

With the development of virtual sex, players/viewers will be able to construct their own voyeuristic scenarios in order to satisfy their individual desires. This may well lead to a decline in public forms of popular entertainment and pornography as individuals assume greater autonomy—and perhaps, responsibility—for their erotic lives. It may also lead to the emergence of new narratives, fantasies and sexual scenarios . . . (pp. 125–126).

Perhaps this is just online pornography's moment of over-enthusiastic optimism for the new technologies: a kind of sexualized version of Rheingold's "virtual communitarianism". Certainly, Australian sex-industry advocate Fiona Patten, (in Lumby and Probyn, 2003) reminds us that the Australian pornography production and provision industry seems unlikely to die out any day soon:

. . . what we have at the heart of the industry in this country are two very public companies which are listed on the stock exchange . . . . Surveys consistently show that most people favour making explicit sexual material available to adults. The last survey put that figure at 85% (p. 215).

In 1997, reacting to the July 1995 *Time* magazine cyberporn issue, which they describe as a "moral panic" formation, Evans and Butkus set out to test how far internet services reflected the "porn push" reported in *Time*. They discovered that these sites were in fact easy enough to locate, using only popular search engines and standard search terms ("pornography", "sex", and "hardcore"), and even easier to access, without fees. But they also noted that sites were surrounded by admonitory warnings: logos and links to family censorship software such as "Net Nanny"; "entry condition" statements to which one must comply; anti-censorship organization links; even advertisements for missing children. Evans and Butkus argue from these findings that internet sex sites are, like all Net compositions, mixed and multiple constructions, pointing in many different and even contradictory directions. They conclude

that “fears of the structural reconfiguration of public sphere communication may well be a key element in the cyberporn panic” (p. 66). In other words, they too see the availability of accessible material online as “democratizing” and “domesticating” the uses and user-range of sexual materials, but by creating a kind of textual promiscuity: one which re-mixes the genres and styles of public and private text access and consumption, and so of online morality.

*Repeat the Evans and Butkus search strategy. Using their three search terms and your usual search engine, see what is available, and whether the “mixed” and contradictory links and messages they found surrounding sex site access are still evident.*

*Compare your findings with a range of “moral panic” articles for popular media. Do your experiences online bear out the claims?*

*Review current censorship provisions for both online and off line sexually explicit materials in your location. From the base of your own online experience with such materials and their accessibility, is online censorship (1) possible? (2) desirable? (3) working?*

*Does the Evans and Butkus finding of a social debate over sexually explicit materials, actually evident even at the point of download and use, make any difference to such arguments?*

There seems then to be not only a broadening of pornographic uses being reported—at least by Australian researchers of online media—but of attitudes taken up toward the social “positioning” of pornographic materials, and possibly to the general view that this is, as it has been in the past, still an “underground”, high-circulation/low-quality media format. With professional public advocates and industry managers; increasingly high-profile performers and growing cross-over into mainstream media, and above all the new personal selectivity, private use and interactivity and DIY productivity of internet services, all forms of pornographic materials are shifting cultural status, somewhere in the diverse cultural matrix.

As contact with these materials becomes more random, and more in line with other everyday consumer activities, online pornography services and products are more likely to hybridize even further into other sectors, than to remain sequestered into specialist zones. Indeed, there is plenty of evidence that this has not only already happened, but that the rise of many forms of moral-panic debate around online pornography or sexual materials may indicate, as Evans and Butkus suggest, social response not to sexualized materials, but to their presence on a medium itself at once public, and private; randomly accessible, yet intensely personalized. In ways that we may only just be beginning to understand and analyze, the internet may be re-mixing our *non-virtual* social/selves in ways which we are only just becoming able

to discern. Virtual leisure industries could prove to be not those anti-social “retreats” from “the real” which initial cultural responses claimed; cul-de-sacs of cultural inertia, retrogressive social formation; frenetic but unproductive labor; but instead co-drivers of newly emergent sociabilities, activities, and identities. In the field of digitized sport, a number of Formula One Grand Prix drivers have already confessed that they cruise the next-day’s race circuit on the game simulators, to practice the curves and tactics of the track. Perhaps, Florian Brody’s “Internet Eisenstein”, the creative genius to take us to the next level in virtual image creation, will be an online pornographer. *Game on!*

### 6.2.1. Useful Links and Readings

#### 6.2.1.1. General

Bennett, D. (2001). Privates on parade. *The Australian Review of Books*, 13 June (review of book *Obscene Profits: Entrepreneurs of Pornography in the Cyber Age*). Access via LexisNexis database.

Creed, B. (2003). *Media Matrix: Sexing the New Reality*. Crows Nest, NSW: Allen & Unwin.

#### 6.2.1.2. Economics of Online Pornography

Regan, K. (2002). Online porn profits still lurk in shadows. *E-Commerce Times*, 31 January.

Cone, E. (2002). The naked truth. *Wired* 10(2) (February).

Soonachen, I. (2002). The new economy’s dirty little secret. *Hosting Tech*, 01 August.

Schachtman, N. (2003). Smut trading outstrips tune swaps. *Wired News*, 30 April.

#### 6.2.1.3. Sites

Kibby, M. (1999). Sex entertainment for women on the web. *Sexuality & Culture* 3, 145–163 (list of sites).

Danni’s Hard Drive—successful site for Danni Ashe.

*Frontline* Interview with Danni Ashe (2002). Available at: <http://www.pbs.org/wgbh/pages/frontline/shows/porn/interviews/ashe.html>.

#### 6.2.1.4. Online Sex

Kibby, M. & Costello, B. (2001). Between the image and the act: interactive sex entertainment on the internet. *Sexualities: Studies in Culture and Society* 4(3), 353–369.

Jonathan, M. (2003). The sexual life of cyber-savants. *Australian Journal of Anthropology*, 14(2) (August). Access via EsbcHost database/Academic Search Elite.

Waskul, D. D. (2002). The naked self: being a body in televideo cybersex. *Symbolic Interaction* 25(2). Access via EsbcHost database/Academic Search Elite.

#### 6.2.1.5. Policy

McIlveen, L. (2003). Canberra clamp on net porn. *The Australian*, 05 March. Electronic Frontiers Australia Internet Censorship in Australia site.

#### 6.2.1.6. Fear and Hype

Elmer-Dewitt, P. & Bloch, H. (1995). On a screen near you—cyberporn. *Time (Australia)*, 10 July, p. 48. Access via EbscoHost database/World Magazine Bank.

JournoPorn: Dissection of the Time Scandal. *HotWired* (responses to *Time* article and its relationship to U.S. Communication Decency Act).

#### 6.2.1.7. Dubious Industry Practices

Type in <http://www.media-culture.org> vs. <http://www.media-culture.org.au>.

Wright, G. (2001). Mousetraps deluge web surfers. *USA Today*, 24 October.

Murphy, K. (1999). Three clicks of separation. *The Weekend Australian*, 09–10 October, p. 28. Access via Lexis Nexis Academic database.

Finally, one note of advice for those considering inclusion of pornography sites and materials in courses of Internet Study, or for specialist study of VLIs: given the contentious nature of this particular industry, and the many possible responses to the idea of pornography within modern societies, it is necessary to consider the ethics of the use of such topics inside educational materials and curriculum.

As with racist or terrorist websites visited for the study of online practices, your online visit to a sex site will probably be recorded by that site, and possibly used to justify the “popularity” and so validity of the site’s views and practices.

Visits may also incur unsolicited “push” materials sent to your e-mail and websites, and this is often very difficult to block or remove.

And both you and your students or co-researchers will have your visits to such sites noted by at least your institution’s systems operators—and you may be called to account for them.

The solution to at least this latter problem is to pre-warn of these possibilities, and to provide something akin to the following statement:

*Note: this section of the course/research is entirely optional.*

*If you are likely to find the study of sexually explicit materials offensive, you may disregard this section—without penalty, either in assessment, or in coverage of the course/research project. There are other sections of the course to choose from.*

*While there is nothing in the course materials provided here which is likely to offend, it is entirely possible, in fact highly probable, that those who wish to study this topic will perform online searches, download files and access sites which will, either deliberately or accidentally, include*

*explicit sexual material at many levels of acceptability. Searches in this area are notorious for attracting inappropriate links. For these reasons, those who choose this topic should prepare by alerting their lecturer/supervisor to their topic theme.*

*On no account may students/researchers use open, public University computer labs or Library terminals for searching or downloading material for this topic. A closed lab is available, with private printer, so that others may not be accidentally exposed to what they might consider offensive materials. Students/researchers should also consider taking similar steps to protect family members or housemates if they are researching at home or in halls of residence. Terminals in the closed lab are registered with University systems operators, who are aware that this section of our course exists. Use of other terminals in the University for such searches and downloads will be noted and monitored, including use of dial-in facilities, and the University's protective arrangements to prevent unethical practices may be evoked.*

*Please do not attempt to evade these provisions. The University is currently prepared to permit serious study of these matters. Abuse of this status in any way or at any level, could mean that permission will be withdrawn.*

Perhaps, the final mark of maturity in assessing the development of virtual leisure industries will be whether as online culture develops, such statements of ethical concern—online “self-protective” behaviors—become more, or less, of a concern.

#### ENDNOTES

1. See for instance ongoing academic discussion of direct Australian media attacks on those topics within funded and doctoral research in Australian universities, which center on popular media content and/or leisure pastimes, at [www.csaa.com.au](http://www.csaa.com.au).
2. In Australia, the 1994 Federal Government policy document *Creative Nation* attempted just such an exposition of how new digital media could help to re-configure the role of media more broadly, operating as an integrator for the streaming of popular cultural content into a wide range of production and consumer uses. Similar policy frameworks were proposed, and some implemented, around the industrialized world. See however Goggin and Lovink (2004), for a discussion of how politics destroyed this scenario within Australia, between 1996 and 2004.
3. Despite the much-reported Asian economic “meltdown” of the late 1990s (see Castells, 1998 for a pre-crisis account of where key Asian economies had been heading with their “new economy” planning) at least the



central nation-states and economic zones (Singapore, Malaysia, India—Bangalore, China—Shenzhen, Korea, and especially China-Hong Kong), are back on track in relation to their development of online economic activity. See for instance a wide range of new Hong Kong based research publication relating to Hong Kong new-media culture, produced by Hong Kong University Press (available in English).

4. Consider for instance ongoing developments within mobile telephony as it increases the range of internet-based services packaged into small mobile hand-helds or hands-free devices. The very mobility which has motivated their rapid uptake has created a seemingly never-ending series of moral-panic social debates over what is, or is not, acceptable public use of this very “personalized” form of communications access. A range of regulatory technologies has accompanied these debates: from auto-cancel devices to block mobile phone signals in theatres, to use of GPS chips in mobile phones as a personal back-up for maritime rescue services. Somewhere behind each of these arises a new-economy industry.
5. It is interesting to examine the impact Internet Studies has exerted upon previously disregarded and under-studied forms of communication technology, such as telephony and talk-radio. It is as if the sudden irruption of internet technologies into the social re-ordered the entire communications universe, introducing not only a new critical lexis, but also an apparatus of research infrastructure which has extended to older forms as well as new ones.
6. Annanova is still providing a news service—albeit tabloidesque and celebrity-centered—at [www.annanova.com](http://www.annanova.com). William Gibson’s 1996 novel concerns the “marriage” of a digital-simulant—in Japanese an “idol” or “idoru”—to a living celebrity—among other new-media directed activities. Japanese anime is noted for its view of the cyborg as a networked sentient entity, informational in nature, rather than robotic, heroic and personalized, as in the Hollywood version. For a discussion of this see Claudia Springer, *Electronic Eros*. For a Japanese anime with English soundtrack centered on cyborg issues, see especially Masamune Shirow’s *Ghost in the shell* sequence.
7. While I have some problems with the “great men of history” view behind such a comment, it does signal very powerfully the adaptive and appropriative phase new media design is largely still in.
8. In Australia, where Easter Bunny figures are problematic given the status of the rabbit as a major agricultural pest, there have been recent moves to select an alternative marsupial figure in the confectionary business. See the South Australian Haigh chocolate-producer site for a view of the “Easter Bilby”.
9. See Flew (2005) for an account of the theorization, policy development, and industrial innovation behind the re-organization of media and content production and commerce around this notion.

## REFERENCES

- Albury, K. (2003). The ethics of porn on the net. In: Lumby, C. and Probyn, E. (Eds.) *Remote Control: New Media, New Ethics*. Cambridge: Cambridge University Press, 196–211.
- Ang, I. (1996). *Living Room Wars: Rethinking Media Audiences for a Postmodern World*. London: Routledge.
- Bakhtin, M. M. (1981). In: Holquist, M. (Ed.) *The dialogical imagination*. Austin: University of Texas Press (translated by Emerson, C. and Holquist, M.).
- Bauman, Z. (2000). *Liquid Modernity*. Cambridge: Polity Press.
- Bolter, J. D. & Grusin, R. (1999). *Remediation: Understanding New Media*. Cambridge, Massachusetts: M.I.T. Press.
- Brody, F. (1999). The medium is the memory. In: Lunenfeld, P. (Ed.) *The Digital Dialectic: New Essays on New Media*. Cambridge, Massachusetts: M.I.T. Press, 135–148.
- Bukatman, S. (1994). *Terminal Identity: The Virtual Subject in Postmodern Science Fiction*. Durham and London: Duke University Press.
- Caves, R. (2000). *Creative industries: Contracts between Art and Commerce*. Harvard University Press, Cambridge, Massachusetts.
- Castells, M. (1996). *The Information Age: Economy, Society and Culture, Vol. 1: The Rise of the Network Society*. Oxford: Blackwell.
- Castells, M. (1997). *The Information Age: Economy, Society and Culture, Vol. 2, The Power of Identity*. Oxford: Blackwell.
- Castells, M. (1998). *The Information Age: Economy, Society and Culture, Vol. 3, End of Millennium*. Oxford: Blackwell.
- Castells, M. (2001). *The Internet Galaxy: Reflections on the Internet, Business and Society*. Oxford: Oxford University Press.
- Creative Nation*. Commonwealth Cultural Policy, October 1994; online at [www.nla.gov.au/creative.nation/contents.html](http://www.nla.gov.au/creative.nation/contents.html).
- Creed, B. (2003). *Media Matrix: Sexing the New Reality*. Sydney: Allen & Unwin.
- Elias, N., and Dunning, E. (1986). *Quest for excitement: sport and leisure in the civilising process*. Oxford, Blackwell.
- Evans, M. & Butkus, C. M. (1997). Regulating the emergent: cyberporn and the traditional media. *Media International Australia* 85(November), 62–69.
- Flew, T. (2005). *New Media: An Introduction*. Melbourne: Oxford University Press.
- Flew, T. (2002). *Newmedia: an introduction*. Melbourne, Oxford University Press.
- Geekgirl*. Australian online magazine and website on cyberculture. Available at: <http://www.geekgirl.com.au/geekgirl/027fans/index.shtml>.
- Goggin, G. (Ed.) (2004). *Virtual Nation: The Internet in Australia*. Sydney: University of New South Wales Press.
- Goggin, G. & Lovink, G. (2004). Histories, trends, futures: a round table on the internet. In: Goggin, G. (Ed.) *Virtual Nation: The Internet in Australia*. Sydney: University of New South Wales Press.
- Habermas, J. 1989 (1962). In: Burgher, T. and Lawrence, F. (Transl.) *The Structural Transformation of the Public Sphere: An Inquiry into a Category of Bourgeois Society*. Cambridge, Massachusetts: M.I.T. Press.
- Haigh's chocolate. Available at: [members.optusnet.com.au/bilbie/Easter\\_Bilby-1.htm](http://members.optusnet.com.au/bilbie/Easter_Bilby-1.htm).
- Hebdige, D. (1988). *Subculture: the meaning of style*. London, Routledge.
- Jenkins, H. (1992). *Textual Poachers: Television Fans and Participatory Culture*. New York: Routledge.
- Kibby, M. (1997). Babes on the web: sex, identity and the home page. *Media International Australia* 84(May), 39–45.

- Kress, G. & van Leeuwen, T. (1998). Front pages: (The critical) analysis of newspaper layout. In: Bell, A. and Garrett, P. (Eds.) *Approaches to Media Discourse*. Oxford: Blackwell, 186–219.
- Lefebvre, H. 1991 (1975). In: Nicholson-Smith, D. (Transl.) *The Production of Space*. Oxford: Blackwell.
- Luke, C. & Luke, H. (1997). Techno-textuality: representations of femininity and sexuality. *Media International Australia* 84(May), 46–58.
- Lumby, C. & Probyn, E. (Eds.) (2003). *Remote Control: New Media, New Ethics*. Cambridge: Cambridge University Press.
- Lury, C. (1996). *Consumer Culture*. Oxford: Polity Press.
- Lury, C. (2004). *Brands: The Logos of Global Economy*. London: Routledge.
- McKee, A. (2004). Pornography and sexuality online. In: Goggin, G. (Ed.) *Virtual Nation: The Internet in Australia*. Sydney: UNSW Press, 102–115.
- Morse, M. (1998). *Virtualities: Television, Media Art, and Cyberculture*. Bloomington: Indiana University Press.
- Nightingale, V. (1992). Contesting domestic territory: watching rugby league on television. In: Moran, A. (Ed.) *Stay Tuned! An Australian Broadcasting Reader*. Sydney: Allen & Unwin.
- Nightingale, V. (1996). *Studying Audiences: The Shock of the Real*. New York: Routledge.
- Patten, F. (2003). Ethics and sex. In: Lumby, C. and Probyn, E. (Eds.) *Remote Control: New media, New Ethics*. Cambridge: Cambridge University Press. 212–215.
- Pratt, A. (1998). A “third way” for the creative industries? *International journal of communications law and policy*, vol. 4, no. 1. [www.digital-law.net/IJCLP/1-1998/ijclp\\_webdoc.4\\_1\\_1998.html](http://www.digital-law.net/IJCLP/1-1998/ijclp_webdoc.4_1_1998.html)
- Rheingold, H. (1993). *The Virtual Community: Homesteading on the Electronic Frontier*. Cambridge, Massachusetts: M.I.T. Press.
- Rowe, D. (1999). *Sport, Culture and the Media*. Buckingham: Open University Press.
- Rucker, R., Sirius, R. U., & Mu, Q. (1993). *Mondo User's Guide to the New Edge*. London: Thames and Hudson.
- Slatter, D. (1998). Trading sexpics on IRC: embodiment and authenticity on the Internet, *Body & society*, vol. 4, 1998.
- Smith, Chris (1998). Secretary of State's Foreword, in Department of Culture, Media and Sport, *Mapping the creative industries*, [www.culture.gov.uk/creative/creative\\_industries.html](http://www.culture.gov.uk/creative/creative_industries.html)
- Springer, C. (1996). *Electronic Eros: Bodies and Desire in the Postindustrial Age*. Austin: University of Texas Press.
- The Drudge Report. Available at: <http://www.drudgereport.com/>.
- Thompson, J. B. (1995). *The Media and Modernity: A Social Theory of the Media*. Oxford: Polity Press.
- Tulloch, G. (2000). *Watching the TV Audience*. Oxford: Blackwell.
- Turkle, S. (1995). *Life on the Small Screen: Identity in the Age of the Internet*. New York: Simon and Schuster.
- Watts, I. (1951). *The Rise of the Novel*. London: Pelican.
- Williams, L. (1990). *Hard Core*. London: Pandora Press.
- Winston, B. (1998). *Media Technology and Society: A History, from the Telegraph to the Internet*. London: Routledge.

## Chapter 37: Education, Gaming, and Serious Play

SUZANNE DE CASTELL AND JENNIFER JENSON

*Simon Fraser University, York University*

### 1. INTRODUCTION

Attention is a critically important consideration in the design and development of virtual environments for learning, in fact, their very existence depends upon it. Unlike the independent reality of material classrooms and teachers and textbooks, virtual educational realities must address learner attention as an essential condition of their functioning. For just as digital texts are “written” only as they are read—appearing as readable text only when users scroll through them—so for virtual knowledge-artifacts, their very existence is conditional upon user attention. In this respect, a virtual tree falling in a digital forest is not at all like a real tree falling in a real forest. The latter, we may at least argue, still makes a resounding crash, whereas the former’s silence makes the virtual tree no tree at all—neither sound nor forest nor tree itself comes to “life” until some user activates the would-be event with eyes to see and ears to hear.

An information society, a society in which information is designated the primary commodity to be produced, marketed, and consumed, has attention as its primary currency. Education has always sought to cultivate a “knowledge society”, and has therefore always had attention as its primary currency: In this respect, if in no other, education is a step ahead in the “information society” game, having given considerable thought and paid considerable attention to the culture and management of attention. In schools, attention, both of students and by their teachers has been “traded” for marks, for disciplinary action, for praise. It is captured and held by compulsory schooling laws and, more traditionally, by fear—fear of failure, fear of corporal punishment, and fear of disapproval. And Teachers typically positioned themselves as the center of attention, at the front of the class, “all eyes forward”, and as the central figure in the distribution of information (text books, worksheets, library) and knowledge (subject matter).

Today, attention in schools is altered by political and technological conditions which have disrupted the traditional distribution of “information” and thereby knowledge, where, at least in schools, the role of the teacher has been central. As well, there has been a pervasive cultural shift toward progressive, “learner-centered”, and more recently constructivist orientations to education. The norms and their legitimating principles which once regulated a stable universe of authoritative texts and authoritative teachers are losing their

hold on public sentiment about education. Structures of perceiving, thinking and feeling which kept students attentive to teachers, tests and texts are being challenged directly (students attend—as they always have—to something other than the teacher, writing notes, sending text messages, making faces at each other, staring out the window) and more and more indirectly through popular cultural media, which satirize and/or disregard all together the importance of “paying attention” in school.

What is different is children’s sense of entitlement: Whereas under earlier conditions, students had to earn, to merit, to “deserve” their teachers attention, nowadays increasingly today the tables are turning; it is the teacher who must earn or “deserve” the attention of her students—or they will turn it elsewhere. Further destabilizing authority relations between teachers and students, new technologies have afforded children far greater power and therefore far greater choice in what they can see, think and do, because now their attention, as we seem to like to say, “adds value”. Under conditions of massive information surplus and saturation, attention acquires its own independent worth. As education’s monopoly over credentialism is broken, from outside but also very much embraced by schools and universities, terms of value between private and previously public sectors increasingly converge. Children take economic control with political consequences: whereas children’s rights had always been grounded in age-restricted legal rights, an attentional economy has no “age of majority”, and children are enfranchised as full citizens the moment they gain access to the global mass media industry already actively working to attract their attention. Culturally, children’s frames of perception and significance are being (re)formed by entertainment-oriented media driven by a global advertising system, as it seeks to capture and to hold their attention.

Children, quite literally, *pay* their attention to new multimodal tools, which undermine singular modes (like text) so completely that even technologies like the telephone, once tied to boxes and switches, have broken free both materially and symbolically: Cell phones disengage users from wires, and phones are no longer just for verbal communication but for textual. When we pay attention (as we talk on the phone, for example), we may often be “multitasking” (chatting on the computer and/or watching a movie and/or playing a game). The school’s traditional forms of authority to command student attention, along “uni-modal”, text-based lines, offer diminishing returns to both teachers and students in such an economy: The technologically supported transformations of both individual and collective attentional structures towards multimodality and multitasking impacts most profoundly on youth, who have never known the text-bound world from which their elders have come.

What we argue in this piece is that the technological infrastructure of the new economy brings in its wake an unprecedented challenge to formal

education's traditional monopoly over the mass-scale acculturation of youth: A new "*attentional* economy" in which anyone, adult or child, with "access" (to television, movies, advertising, and computer games, but above all, the internet) owns and controls a full economic share of her/his own attention. Education, which has always been in the business of capturing and holding attention, has sustained serious blows to its capabilities as core values, along with traditional tools, means and purposes have been progressively troubled, destabilized, and finally unseated by new literacies, digital epistemologies. Complexly, a corporate-owned, profit-driven means of educational production transplanted to the heart of the public school: Networked digital technologies of construction, representation, expression and communication.

One powerful result of this new attentional economy and its attendant but very real increase in children's rights, freedoms, and powers has been the ability—and the notable success—of popular culture to school a mass audience in patterns and practices of consumption, which has had economic consequences in the evolution of a mass entertainment industry extending deeply into every aspect of children's (and their teachers') lives. This collision of the hitherto relatively disconnected spheres of education and entertainment has changed how both teachers and students can "do" schooling.

## 2. VIDEO GAMES AND POPULAR CULTURE

Very much unlike children before them, students at school today have grown up with structures of meaning and of feeling defined by global and local commercial advertising systems and delivered through corporate-controlled communication networks. Even very young children, for example, enjoy and find significance and identity in commercial products and commercialized activities of consumption, and are indeed seen as their own "market" in North American, capitalist economies. At the same time, vastly increased attentional demands on parents, as boundaries between labor and leisure erode and work intrudes into "private" life, means children are growing up with diminishing parental time—a consideration which ought to challenge received understandings of the home as the site of primary socialization. Moreover, for many children today, population density and unstable patterns of "community" growth mean increased dangers and diminishing physical space for embodied, non-virtual play, particularly for boys (Jenkins, 1998).

So for children, if not also for teachers, there is little worthwhile that is left of the traditional separation between education and entertainment. Incontrovertible is the fact that video games have been the most successful medium at grabbing the attention of millions of young men and boys and some girls and women, worldwide (cf. Gee, 2003; Kent, 2001; King, 2002; Poole, 2000).

We therefore see it as valuable to consider what may be learned from a study of computer games as virtual learning environments, and from looking, in particular, at emerging structures and forms of attention within computer-based play to consider their implications for new structures of knowledge. This is a perspective which sees educational promise in computer gaming for “serious play” (de Castell & Jenson, 2003; Reiber, 1996). A cultural form highly successful at attracting and maintaining human attention, commercial gaming’s spectacular success may have much to tell us about developing, gaining and keeping audiences both engaged and immersed. Important, too, under conditions of diminished external control and increasingly self-regulated and “voluntary” attention is figuring out how games frame information so that it engages players’ attention in ways that give pleasure. What conceptions of learning, and what contents and practices of teaching and learning, do entertainment-oriented computer games appear to have?

In educational contexts, as learning continues to migrate from teachers, texts and classrooms to virtual interactions regulated by learners, there is a need to create learning resources capable of attracting and equipping novices with basic operating skills to mobilize program content, and of motivating and supporting for experienced users the kind of sustained learner engagement required to pursue demanding and sophisticated intellectual activity. To learn more about attracting, capturing, and holding the attention of multimodal, fast-paced, and interactive media, we are likely to learn most from the best tool digital technologies have thus far developed possessing both of these properties: Computer-based gaming.

Studies of teaching and learning in the “new information economy” pay increasing attention to computer-based gaming not least because this field represents the area of greatest financial investment in multimedia design and development. The return on that investment is that state-of-the-art games today embody the most sophisticated technology, and the most fully developed applications of programmers capabilities, that we are available in the public domain. These resources enable games to support a thriving network of users, many of these children/youth, making gaming today’s most successful and widest-reaching global subculture, one which comes closer to a “virtual community” than any other “cyberculture” to date.

Gaming’s ability to generate a culture which immerses and fully absorbs its participants makes it threatening to many parents and teachers. And in many ways, it is. Today, For example, as a direct result of the proliferation of digital technologies in education, in work and in social life, children in the same physical spaces inhabit different worlds from their parents, speak in new languages, write in new forms, and communicate using media in ways and for purposes their parents can scarcely comprehend. Understandable as a repudiation of computer gaming may be, however, the benefits to education of engaging with and learning from commercial gaming’s phenomenal success,

popularity, and effectiveness as a learning environment, might far outweigh the benefits of attempting myopically to ignore or suppress it, something which is in any case unlikely to succeed in the longer term.

The rich potentials of learning from games and play are of course by no means entirely unrecognized in education which has, however, largely reserved play-based approaches to teaching for the child's earliest years of schooling. For the most part, and for many teachers and parents, playing is the *opposite* of "school", and it's probably safe to say that few teachers would embrace the idea that game-based learning offers a useful and appropriate medium for their students<sup>1</sup>. Supporting a devaluation of play (as "distraction"), or its relegation to the child's earliest years and to non-significant content, other educational uses of gaming and play have limited its role to an extrinsic-motivational one. Any sustained attempt to grasp the profound epistemic and socio-cultural significance of play is rare. In industry, though, corporate trainers have been quick to capitalize on these new possibilities, as evidenced by the burgeoning digital game-based learning for the workplace (Prensky, 2001).

However, educational theory and research has only very recently (Gee, 2003) begun to explore what education may have to learn from the successes of entertainment oriented commercial game development about how to engage and "immerse" people in a virtual universe which develops, through play, both psychomotor skills, and a host of analytic processes, including socio-cognitive attitudes and understandings. Currently, these processes are most commonly being engaged in by men and boys: As has been repeatedly observed (Cassell & Jenkins, 1998: 14) boys' early and continued involvement with gaming has been a key factor contributing to their greater interest in and competence/confidence with new technologies. This early gaming experience amounts to a "head start" for boys which accrues incrementally for the duration of schooling and beyond, such that we continue to see a dramatic and indeed an increasing under-representation of women in computer/technology focused subjects and fields.<sup>2</sup>

So it needs stressing that commercially based entertainment oriented gaming, for all its technological sophistication and cultural power, has been and continues to be inhospitable to women and girls, and proclamations<sup>3</sup> of gaming's "virtual equality" which identify the largest percentage of gamers as adult single women depend on our ignoring the vast differences between playing solitaire "online" and playing Everquest. As soon as we look at differences in computer-based play by gender, it's clear that the vast majority of women and girls remain at best marginal participants in gaming activities as well as in gaming's larger cultures. To look to computer-based gaming for new means of re-tooling public education's knowledge production, representation and dissemination possibilities, *without* taking gender seriously into account is to compound girls' disadvantage with respect to developing competence and confidence with new technologies, a consideration worth returning to.



### 3. THE ECONOMICS OF ATTENTION

A key to gaming's spectacular success has been its savvy engagement with and its ability to map absorbing and pleasurable activity on to the new structures and functions of attention being taught to youthful consumers for attending to and interacting with information and experience in multimediated virtual environments.

While principles of the economics of attention were initially formulated several years ago by Canadian psychologist Walter Thorngate (Thorngate, 1988, 1990, 1997; Thorngate & Bagherian, 1999), the concept of attentional economy has been further and differently elucidated within contexts of economics, business, rhetoric, and education, each of which helps to map out a significant dimension of this construct. It should be noted, however, that much of the work seems much less oriented to education than to advertising, business and entertainment contexts and that, when and if it is taken up and used as a construct relevant to the field of education, concepts and theories of attentional economy need to be developed more specifically with that field in view, not merely "imported" and unproblematically related.

Writing for a corporate/business audience, Michael Goldhaber's analysis sees attention as indexical to originality, and prophesies a replacement of monetary economies by attentional economies. He writes,

... attention can ground an economy because it is a fundamental human desire and is intrinsically, unavoidably scarce . . . . We search for meaning in our lives especially once pure material needs are already given to us with little effort on our part. Why are we here, and how do we know that we are somehow worthwhile? If a person feels utterly ignored by those around her, she is unlikely to feel that her life has much meaning to them, and since all meaning ultimately is conferred by society, one must have the attention of others if there is to be any chance that one's life is meaningful.

(Goldhaber, 1997: 2)

A flaw in this argument is of course that while many people may indeed crave unlimited or at least large amounts of other peoples' attention, by no means everybody does, even in a culture such as ours in which we have been taught that attention-seeking is perfectly acceptable and in fact a highly pragmatic disposition for an entrepreneurial, self-promotional employment culture. From Greta Garbo to Harry Potter, personalities both real and imaginary have begged to be left alone. Possibly it is true for business ventures that they crave maximum attention of maximum numbers of people, in which case it is an odd choice to construe this desire as a deep-seated *psychological* need. Whatever the case, the presumption is false, as indeed is Goldhaber's reciprocity thesis: In order to get attention, you have to pay attention. This

principle supports his idea that what we all have to learn is how to give “illusory attention”, making others believe we are giving them fair attentional exchange, so they will give us theirs. However a number of culturally significant practices absolutely depend upon assymterical attentional relations, most obviously sabotage, surveillance, stalking, “intelligence” and so on, in all of which it is critical that one pay attention without having attention “paid back”. Interestingly, this analysis, proposed as having economic implications concerned with innovation, again grounds its understanding of economies of attention in the fundamentally psychological terms of the emotional needs of persons for recognition.

It follows from his essentially psychologistic way of looking at the matter that, for Goldhaber, “The limits on real attention per capita are absolute” (Goldhaber, 1998, n.p.). This “zero-sum” viewpoint is shared by fellow attentional economist, Thomas Davenport, who explains that “. . . though information continues to grow, attention remains a fixed resource, simply because to ‘pay’ attention is to ‘spend’ time and nature does not expand lifetime to fill the information available. The result is an attentional economy in which attention is exchanged for the production and consumption of information and in which an abundance of information creates a buyer’s market” (Davenport, 2001, n.p.).

Although real “lived” or “embodied” time is certainly a fixed resource, Herb Simon’s oft-cited argument about the dramatically altered ratio of information to attention under conditions of information proliferation (“infoglut”) can be read two ways. Simon argues that “What information consumes is . . . the attention of its recipients. Hence a wealth of information creates a poverty of attention” (Simon, in Lankshear & Knobel, 2003: 109). On one view, the poverty information creates is a poverty of attention as intersubjective recognition; on the other view, a glut of information creates a poverty of intellectual engagement. The differences between intersubjective recognition and intellectual engagement prove to be, educationally, very significant indeed.

In the first place, even though there is a dramatic drop in the relative amount of attention *vis-a-vis* information, and an absolute limit to human lived/experiential time, it by no means follows, as the “intersubjective recognition” view of attention supposes, that while “The size of the attention pie can grow as more and more people join the world audience . . . the size of the average slice can’t . . . [and that] the total available attention per capita (per mind) is simply not going to change” (Goldhaber, 1997a, b, n.p.).

Such a view presupposes that “Technology . . . doesn’t alter what human attention is or how it works in any very basic way, but by changing the conditions under which we can give it, and to whom, it alters how it gets distributed and how important it can be for us” (Goldhaber, 1998, n.p.) Granted that much depends here upon what is meant by “basic”, it can nevertheless be demonstrated in respect of many contemporary cultural activities—computer

gaming prominent among these—that the ways attention is deployed, as well as the subjects and objects of attention, have already altered greatly, and technology has played a substantial role in the ways these changes are occurring and will occur—with real prospects for an enlargement of human information-processing capabilities.

#### 4. MULTITASKING

Born into a culture of information surplus and time scarcity, many young people have developed information management capabilities that often amaze incredulous parents and teachers. Of course it was always true that students, through a kind of “illusory attention”<sup>4</sup>, have paid less than their full, focal attention to their teachers, texts and tasks. But now we are seeing, not sub-optimal attention/competence, but in fact highly efficient *and* effective deployments of partial, subsidiary and intermittent attention strategies routinely used by students who have learned to do homework while watching TV and listening to music on headsets—with that homework being done on a computer whose multiple screens are simultaneously at work and play, between internet researching, chat, word, processing, emailing, and online game play, users switching between screens to minimize loss of time wasted waiting for processing, loading, connecting, etc. If we hark back to Phillip Jackson’s landmark ethnography of schooling, *Life in Classrooms*, or subsequent similar studies, we can recall the then-sobering observation that what students learn to do most of all at school is wait (Goodlad, 1984; Jackson, 1968). How much more absurd it must seem to today’s students that they should spend so much time simply waiting on teachers—and not at all surprising that they often do not. This attentional restructuring has presented particular difficulty for teachers trying to adapt to instruction in computer lab settings: Students at computers do *not* just “wait until the teacher is ready”, they do their e-mail or surf or chat or draw. They do not keep their “eyes front”, but on their personal screens, as teachers compete with the infinitely engaging capabilities of networked computers.

These are pre-eminently technologies of communication and production, and user agency is an essential constituent in technology enabled learning. Given that, it’s interesting that Goldhaber metaphorically construes intense attention as a species of enslavement. He writes:

Someone who “enthalls” an audience is in quite a real sense temporarily making the audience members her “thralls”—or, slaves. The very act of paying attention may seem voluntary, but often it is not completely so. There is a definite element of compulsion involved. It’s no coincidence that people say things like, “I have to check out that web site,” “You’ve

gotta watch that show,” or “That book is a must read.” And each of those activities takes physical as well as mental effort.

(Goldhaber, 1997a, b, n.p.)

On this view, agency drops out, and bewitchment takes over, making this a less than useful conceptual framework for investigating the impact and implications of new attentional economies for education, concerned as it is with how people might be supported in learning how to operate, to manage, channel, conserve and control their own attention as an increasingly required commodity, over which they retain and exercise sovereignty.

## 5. ATTENDING TO EDUCATION

The above discussion briefly outlined current understandings of attentional economies primarily oriented towards a business audience, and attempted to show the ways in which those analyses break down when applied to education specifically. In this final section, we more fully elucidate what we see to be the *educational* implications of an analysis of attentional economy, drawing on the work of Richard Lanham. Here we are most concerned with showing the importance of this analysis for developing a framework for understanding epistemological impacts of new technologies (and their resulting economies) as the field of education struggles generally to “make room” for these new ways of knowing, these “new literacies” for knowledge production, representation and transmission (Gee, 2003; Kress, 2003; Lankshear & Knobel, 2003).

Less “corporate” in its values and orientations and markedly less prophetic in its style is Lanham’s analysis of attention economy, whose focus on the epistemic conditions and consequences of attentional economies in an information society makes Lanham’s a rather more promising theoretical resource for building an *educational* theory of technology than one focused on psychological needs for recognition.

In a path-breaking paper published in 1994, Lanham construes attention as “the action that turns raw data into something humans can use” (Lanham, 1994, n.p.), and he proposes that under conditions of information “saturation” the work of human attention is primarily enframing, selecting and organizing from the vast stores of available “raw data” those elements which enable the movement from information to knowledge, to understanding, to, in his terms, “wisdom”. Echoing educator A. N. Whitehead’s critique of “inert” knowledge, Lanham points to the tendency, in a so-called “information economy”, for the accumulation of fundamentally meaningless and useless data in repositories whose only purpose is collection, urging and elucidating the kind of intellectual work needed to make information meaningful.

Lanham’s later work (Lanham, 2001) develops a rhetorical theory of attentional economy that demonstrates how digital technologies, far from installing

a new framework for the operation of human attention, have in fact enabled a return to older, pre-literate attentional practices. New forms of multimedia information display—he gives examples from avionics, in which complex images combined with alphanumeric displays in airplane cockpits, and of CD-Rom versions of books in which an author can appear with, within, and superimposed upon her text to assume multiple roles, not least the hitherto quite separate roles of author and critic simultaneously—mean that “Text is being put back into three-dimensional space” (Lanham, 2001, n.p.). “Text”, he explains, “seeks to monopolize our attention” (Lanham, 2001, n.p.). In Lanham’s view, new multimodally grounded attentional structures break up the attentional monopoly of the text, eliciting a series of bifurcated responses, for example,

Response to text and its argument vs. response to voice, gesture, clothes, lighting. Response to a fixed two-dimensional space from which the distractions of ordinary 3D behavioral space have been carefully sieved out vs. response to exactly that world of ordinary 3D behavioral space that floods the margin when Prof. Minsky [the author, in Lanham’s CD rom-book example;] is allowed out of his box. Two different kinds of space, 2D symbolic vs. 3D behavioral . . . contend often in the attention structures through which digital text is finding its way.

(Lanham, 2001, n.p.)

These new attention structures are what reinstate the rich rhetorical traditions, suppressed and rendered unconscious by text-based attentional demands, back into our cognitive repertoire. As Lanham points out, “The expanded palette of textual display offered by digital expression again and again pulls us back into the history of Western notation. The whole weight of these alternative display modes recaptures this history instead of, as the media prophets of doom argue, repudiating it” (Lanham, 2001, n.p.).

To further explain the reductiveness of the two-dimensional symbolic space of textually oriented attention versus the three-dimensional behavioral space of attention to multimodal representational forms, Lanham invokes arguments by Hellenist Eric Havelock about the ways this reduced alphabetic notation, the form of notation which has reigned supreme over all others so far as modern education is concerned, functions to render us less rather than more conscious of our informational environment, excluding as it does all manner of semiotic modes and messages—and their “play”—in favor of a literal, “logocentric” approach to knowledge and experience (see for example, Derrida, 1978). Echoing Havelock, Lanham explains, “the Greek alphabet underwrote Western literacy because it was simple enough to learn in early youth, and thus to internalize totally. It became transparent to the conceptual arguments it set forth. The letters themselves, bleached by the very force of thought, lost their visual content. In serious, genuinely literate reading, they had no calligraphic

power, *never* made you think about them at all (Lanham, 2001, n.p.)”. For Havelock, this paradigmatic cultural shift from orality to literacy was greatly facilitated by the alphabet’s easy internalization, since the less consciousness needed to be paid to the tools and means of communication, representation, and expression, the more attention could be paid to its contents. Culturally, this “reorientation of the sensorium” (Ong, 1982) from medium to message (McLuhan, 1964) enabled an explosive growth in the production and transmission of knowledge. Relieved of the burden of attending to form—a necessity for ease of memorization and recollection in cultures without writing—and with cultural knowledge now able to be preserved in written form, human intelligence was “freed up” as intellectual resources were increasingly diverted from memorization to knowledge creation. Written language allowed the preservation, and thence the criticism and growth of knowledge (Goody, 1977).

Modernist education has embraced these new capabilities afforded through text-based literacy: Post-modern education begins to detect certain limitations. Lanham sees this easy internalization of alphabetic literacy as effecting a repression of our consciousness of the reductiveness of text, a reductiveness inevitable in the epistemic shift from 3D to 2D perceptual frames. Confounded by our cultural reliance upon texts and writing as vehicles for knowledge, we have been unable until recently clearly to perceive that, as Lanham puts it, “The history of Western alphabetical notation has constituted one long flight from such self-consciousness” (Lanham, 2001, n.p.). An important loss here is both the vast repertoire of communicative tools and supports afforded by situated human embodiment and, with that, the loss of any reflective consciousness of the ways that a choice of text as the means of representing the world represents a decision to misrepresent it. Like all rhetorical decisions, this choice, if consciously apprehended, has ethical and not just communicative implications, a point of some significance in considering educational conceptions of attentional economy.

Far from diminishing our traditionally text-driven intellectual accomplishments and abilities, new multimodal technologies of representation, Lanham suggests, can actually consolidate, extend and improve upon our literate capabilities. For, Lanham continues, “The alphabet in digital 3D space returns us to the world Havelock dismissed. It *makes us think*. We ask, for a start, questions that never occur to us in conventional reading . . . . How does spatial awareness work as the fundamental reading skill in this kind of literacy? What architectural disciplines are needed to illuminate such an expressive field? To what expressive ends might such a notational space work?” (Lanham, 2001, n.p.). These are questions suppressed by our literate biases, questions which have become increasingly important as education finds itself having to work with media around, over and above the alphabetic text (for recent discussions on the importance of a multimodal literacy see Alvermann, 2002; Gee, 2003; Kress, 2003; Lankshear & Knobel, 2003).

Lanham's proposal for rhetorical analysis of attentional economy is thus a proposal for more self-conscious, accountable and ethical communicative practice, and we argue that his is an approach to understanding the new attentional economy more salient to education than the alternative economic and psychologistic models characterized earlier, because it stresses, as both a cognitive and implicitly also as an ethical imperative, the need to *think*, to engage "mentally", as we like to say, with both information and the medium of its transference.

Education's ideological allegiance to "intellectual engagement" as a central human value and as a formative and transformative force for the flourishing of both cultures and individuals is what distinguishes education from schooled consumption. Its imperatives are not oriented towards recognition of individuals except as their development can be grounded in and potentially contributory to the advancement of human knowledge, and attention, on such a view, is an intellectual, not an emotional need and value.

#### 6. EDUCATIONAL IMPLICATIONS OF AN ATTENTIONAL ECONOMY ANALYSIS

This is not, or not yet, the way attentional economy has been elucidated in educational contexts. Lankshear and Knobel's (2002, 2003) extensive consideration of the consequences of digitization for a thorough rethinking of epistemology (a rethinking, they explain, of knowledge, knowers, processes of coming to know, and the relative importance of knowledge-forms) offers a detailed, thoughtful and provocative look at the very different ways the school's traditional attentional economy is managed by students and teachers, and how attentional economy is reconfigured with emerging ways of managing attention under new technological conditions. In their characterization of alternative conceptions of attentional economy, they note that "These differences will result in varying implications for formal education" (Lankshear & Knobel, 2002: 20).

Concentrating, in particular, on how Lanham's perspective differs from Goldhaber's, Lankshear and Knobel rightly conclude that "Rather than focusing on how to gain and maintain attention, Lanham is concerned with how to facilitate or enable attention to data by developing new attention structures for attending to the flood of information-as-data that we face constantly" (2002: 24). However, given the choice between a focus on attracting and a focus on structuring attention, theirs is an analysis which privileges the former, recognition-oriented conception, centered on "paying, attracting and maintaining attention" (2002: 20), rather than Lanham's epistemic conception of intellectual engagement in the creation of post-literate forms and structures of attention. Important to notice here is attention's very different object: In illustrating the role of technological literacies in transforming school-based

attentional economies, Lankshear and Knobel report with approval how the boys in their classroom-based study of new technological literacies succeeded in attracting and maintaining their teacher's attention, something they had been unable to do in traditional text-based lessons. But in this elucidation of the transition from privileging propositional knowledge to privileging performance and production, the authors unwittingly neglected any consideration of the intellectual values of such an accomplishment. We are left asking what, besides gaining the fuller attention of their teacher, has this performance-oriented pedagogy actually enabled for other than besides a stronger sense of their own agency?

While agreeing entirely with Lankshear and Knobel that "schools ought to be paying more attention to attention" (2002: 37), and that this challenge entails taking seriously into account a range of "new literacies", we would urge a different road from theirs, and argue that a concentration on those "new literacies" which create opportunities for gaining and maintaining attention, is had at the cost of a relative neglect of those that frame and structure attention. This is a viewpoint which, while important and illuminating, is not *educationally* sufficient and it may be that we do better to build upon Lanham's analysis of attentional economy if we hope to get at specifically *educational* ends. For what Lanham's analysis would have us do, by contrast, is to re-focus the boys' attention, not on themselves (something many boys are already very accomplished at doing in classroom settings), but on their work, on the organization of their own doing and thinking and learning. Lankshear and Knobel, while offering a thorough and useful account of both<sup>5</sup> viewpoints on attentional economy, in their own analysis subsequently leave Lanham trailing behind; they themselves proceed to follow Goldhaber (1997a, b) in construing social relations within an attentional economy in terms of "Fans versus Stars", "winners and losers" and "insiders versus outsiders". Lanham's alternative view, which doesn't presume a finite quantity of attention in a zero-sum game, offers, by contrast, a more "democratic" scenario in which any individual's own attentional capabilities can and must get refined, enlarged, reconstrued in the process of learning, significantly including processes of technologically re-mediated learning.

Aligning with an economistic perspective which seeks to bring teachers up to date with what youth know, can do, and will be required to do beyond school, while salutary in its practicality, can thus be seen to be partial at best as an analysis of attentional economy with educational significance. For as much as we might want and need to attend to mass media, new cultural forms, globalized economies, and the like, education, (if not, of course, actual "schooling") should got to involve more and other than that. Finally, there is nothing particularly impressive about four boys arranging scheduling to give a class help in learning technology skills (Lankshear and Knobel's main illustration of what the boys accomplished). We may presume that far more went on than this, educationally, for these four boys and yet we learn little of what that was, as if attracting and maintaining attention were an end in itself.



It maybe be so in many arenas of contemporary cultural life, but it is not so in education.

If this critique is justified, then it is to a consideration of new forms, frames, organizations, and structures for attention that we should turn in considering what a theory of attentional economy has to say to education. And, funnily enough, this brings us squarely back to gaming as exemplary of the ways new attentional structures are at work in play, where, as in education, the concern is far more with absorption, immersion, and the payoff of one's own attentional efforts in a maximally efficient assimilation of new knowledge, new skills, and new ways of thinking, than with gaining and keeping the attention of other people.

## 7. PLAYING ATTENTION: THE EDUCATIVE POSSIBILITIES OF VIDEO GAMES

By way of concluding, we will briefly outline here how we view the ways in which video games capture and hold the attention of their players as pivotal for attempting to begin to theorize the impact of new technologies on structures and forms of knowledge, including the resulting destabilization of text as the primary communicative medium. In the past, texts held our attention as a kind of "conduit" for imaginative expression, news, personal feelings, documentation, religion, and argumentation, among many other things. Today, all sorts of "media" compete for our attention: Think here of the popularity of *Harry Potter* which is not simply generated by mass-scale excitement about serial children's books, but the "spin off" toys, candies, movies and video games—Harry has our attention *outside* of the text in ways Madame Bovary never could imagine. In schools and in classrooms, our attention is no less bifurcated, no less hybridized, and yet, in those places, text is still precariously perched as the dominant medium of expression, and this is in direct conflict with knowledge and experience of the "real world" in which textual sovereignty is no longer the case. This conflict creates new tensions in classrooms, tensions that we argue are related directly to new economies of attention in those places. While it would be inaccurate, for example, to describe the teacher and/or the curriculum as ever having held the full attention of students or those who were meant to attend to it, it was most often the will of the students to "pay attention" to both. But in our new Western cultures which have been radically and rapidly transformed by technological advances, ideological, cultural, and economic change, and resulting widely available and easily harnessed access to "information", our attention has "value" in ways it never did, as a kind of "commodity" which holds not just intellectual worth, but economic worth as well.

In economic terms, video games now capture more money and presumably more of our attention than the film industry. We would follow Lanham in pursuing a theory of attentional economy in which attention is directly related

to intelligence, as it is when and where attention is “paid” that intelligence is mobilized in whatever forms that might take. In video games, the attention of the player is central: She must first *choose* to play, and then, once playing, the game encourages her to continue to play through both sophisticated and simplistic reward structures which help her to *learn quickly*. Finally, the game itself, its environment, its tasks, puzzles, quests, its rewards, need to have some kind of *contextual meaning* which continues to capture the attention of the player beyond the manual skills required to be successful at the game. The player has agency, and, in more than a trivial sense, significant meanings have “play” (de Castell & Jenson, 2003; Derrida, 1978). These devices, among others, are part of the reason why video games are so successful at capturing and holding the attention of their players, and here we’ll show what education might “learn” from the attentional structures of video games. We focus, thereby, on the following in education: Pleasure, choice, and immersion; speed and efficiency of learning; and finally, meaningfulness of topic, subject matter, and experience.

In what is still considered a “radical” treatise on education, Jacques Ranciere considers what might happen to education if we assumed that intelligence is *not* something which one individual has more or less of and that, in fact, everyone is equally intelligent, given how widely distributed is humanity’s capacities to put their mind, intellect, effort, and attention to accomplishing their various goals. The implications of this argument are that everyone is *capable* of learning whatever they put their minds to, without the “aid” of an instructor, tutor or institution and that their *choice* in what they learn is key to their realizing their goal, which is simultaneously pleasurable (something they will actively want to accomplish and do) and immersive (the problem is engaged with behaviorally, not merely symbolically, and so it is engaged viscerally and/or cerebrally and/or emotionally). In the first 12 years which mark compulsory schooling in North America, “choice” is parceled out in the later grades in terms of choosing among a limited range of available subjects, and even there, as in all other subject-based learning throughout all the grade levels, there is little if ever “choice” about what to focus on in any given day, and rarely time given to any task without interruption from the teacher, other students, or the institution which rings a bell to move to the next class or subject.<sup>6</sup> It is no wonder then, given the “real world” importance (and economies) attached to their attention that the attention of students in schools is becoming increasingly difficult to attract and hold. This is not to say (as Ranciere argued) that students should only study what they choose to, but that until now, schools have somewhat successfully monopolized student’s attention, but because under contemporary conditions structures and forms of knowledge have shifted, so too have the “terms of engagement”. Lankshear and Knobel (2003), for example, quote one of the boys in their study we mentioned above as choosing not to attend to school work when he is unable to solve a problem, but instead to focus his attention on the music he likes to

listen to: “Mr Y . . . just tells me to sit there and do nothing if I don’t know how to do it. So I just sit there and get my Walkman out . . .” (p. 203). Here, the choice is to “do nothing” or to do something which is usually pleasurable (listening to music) in the absence of being helped or of being attended to, meantime, the student’s learning is “on hold” while he waits for his teacher.

Video games, as James Gee (2003) has recently chronicled, are extremely adept at helping their players “learn” quickly. Schools and teachers, by contrast, as the above quote implies, are notoriously poor at facilitating and/or enabling learning which does not follow the prescribed curricular rate of achievement—don’t learn too quickly or you will be bored or asked not to participate, and don’t learn too slowly or you’ll be quarantined from the rest of the class to “make up” the work. That everyone is equally intelligent (à la Ranciere) and that each and everyone of us “learn” at whatever rate we are able given shifting constraints like time, attention to the task, experience, interest, etc. is, in a way, precisely what video games do presume—that anyone who plays the game can learn to fight, to drive, to jump, etc. so that variation in ability is, more than anything, a byproduct of time spent within the game’s structures, that is in the acquisition of skills and “intelligence” particularly as it relates to the game, and decidedly *not* to some extrinsic standard or notion of what it means to be “intelligent”. This is very different than school-based assumptions of learning and “intelligence”: There the standards are always “outside” and performance, competence and skills, to be found “inside” learners whose “talents” and whose “intelligence” are already largely pre-determined, are judged based on “models” and “standards” that even teachers themselves claim to have neither a “stake” in nor “control over”. What we see represented in video games, therefore, is the fundamental principle at work in Lanham’s analysis of attentional economy: That intelligence is *always adverbial to attentive action* (Ryle, 1949).

Finally, video games, as implied in the above discussion on learning, embed skills, tasks, narrative structures and even “learning” within the environment of game, and each is seen as part of the “play” of the game, which means each is especially relevant to the context of the game more generally. Steven Poole (2000), author of *Trigger Happy*, a book on video game playing, puts it this way: “A well-designed videogame . . . can approach the condition of a work of art simply by virtue of the way such rich, protean transformations in the game’s very structure are linked together for the gameplayer’s pleasure” (p. 176). So the structures of the game are predicated not only on whether or not they are relevant, but also on whether or not they are “pleasurable”. In education, pleasure, as we have said, does not figure prominently, and neither, we would argue, does relevancy or context. Schools and governmental policies still prioritize (in print), and teachers still enforce in practice, a kind of “old-fashioned”, text-only literacy (Luke, 2002), despite well-worn arguments and new theorizations which have taken the term to mean much more than reading and writing text (for a recent discussion see Kress, 2003).

How relevant is it, then, given a multimodal literate context, that a teacher of English would worry that her students were using “internet” spelling/s in their journals and fret about whether or not they knew how to spell the words “correctly”—even though she acknowledged that those words were “spelled correctly” for the environment of internet chat? What does it mean to the students in her class that she “outlawed” that kind of spelling, even in their personal writing, because it was “wrong”, even though that is certainly not the case outside of school? It seems ever more important to have an attentional economy which reaches within school walls to make all the more careful connections between “what is taught” and “how that relates to the world” than it ever did in the past, as it is also very much the case that our students will not attend to it; there are just far too many other things to which they have both the power and the right to turn their attention.

As long as education still claims to be “in the business” of the intellect, then we would argue that we need to turn our efforts to finding ways of better supporting that kind of playful engagement with what it is we want to “teach” which presumes and engages intelligence, and which enriches and extends the now-impooverished literalness of schooled literacy to recapture for our instruction—as well as for our delight—the deep and rich fields of play, both semantic and semiotic. These are fields which modernist schooling’s narrowly textual preferences have so readily abandoned in the name of “standards, pre-specified “learning outcomes”, and myopic visions of “educational accountability”, which have far more to do with counting than educating.

We therefore argue for a kind of engagement in which dynamic, multimodal learning environments are animated by students’ deliberate and sustained attention: An engagement which allows for choice and the freedom to be immersed in an intellectual effort without interruption, regulated less by rigid and indifferent learning goals and schedules, and more by learners’ own intelligent attention. To develop attention of this educative kind, we look to play to learn.

#### ACKNOWLEDGEMENTS

An earlier version of this chapter was published in *Educational Theory*. This chapter is partially based on research from a 2-years study of formal and non-formal learning environments, “Charting Emerging Educational Discourses”, funded by the Social Sciences and Humanities Research Council of Canada.

#### ENDNOTES

1. Not that game-based learning offers a useful and appropriate ‘motivator’ or a ‘support’ for existing learning goals, but that it offers an environment

and a set of tools to learners, and so armed, it's very likely that they will want to think and to do very different things than the curriculum guide prescribes.

2. As well as being a socio-culturally powerful disincentive to female participation in technology based subjects and fields.
3. One recent case of this kind is The Pew Internet & American Life Project's report, "Let the Games Begin: Gaming technology and entertainment among college students." which found that "women are more likely than men to be regular players of computer and online games—approximately 60% of women compared to 40% men reported this, while about the same number of men and women reported playing video games." Full report available at: <http://www.pewinternet.org/reports/toc.asp?Report=93>.
4. Goldhaber's term for ways of giving others the impression that one is paying attention to them, when in fact one's attention is directed elsewhere. Goldhaber argues that since giving attention is necessary in order to get attention, we will effectively get more attention that we give only insofar as we can devise convincing forms of "illusory attention".
5. In fact they describe three perspectives, however we take the third drawn from advertizing's concern with gaining consumer attention, to be sufficiently similar to Goldhaber's (1997) to justify treating both within one perspective, that focused on seeking, gaining and maintaining attention. Whether that securing of attention is for individual satisfaction, or whether for corporate gain, seems more a difference of degree than of kind.
6. In this regard we see a possibly very significant difference between pedagogy in non-formal versus formal educative environments. In schools curricular objectives, scoped, sequenced and timetabled, regulate prescriptive attentional economies; in non-formal learning environments, it is more often the learner's attention, its focus and its duration, which shapes the way learning activities are regulated. For more extensive discussion of the centrality of learner's attention in the formation of non-school-based pedagogies, see "Its all happening at the zoo: Attentional economies in non-formal learning environments" (de Castell and Jenson, Forthcoming).

#### BIBLIOGRAPHY

- Cassell, J. & Jenkins, H. (1998). Chess for girls: feminism and computer games. In: Cassell, J. and Jenkins, H. (Eds.) *From Barbie to Mortal Kombat: Gender and Computer Games*. Cambridge: MIT Press.
- Davenport, T. (2001). eLearning and the attentional economy: here, there and everywhere? (n.p.) <http://linezine.com/5.2/articles/tdeatae.htm>.

- Davenport, T. & Beck, J. C. (2001). *The Attention Economy*. Cambridge: Harvard Business School Press.
- de Castell, S. & Jenson, J. (2003). Serious play. *Journal of Curriculum Studies* 35, 1–17.
- Derrida, J. (1978) Structure, sign, and play in the discourse of the human sciences. *Writing and Difference*. Trans. A. Bass. Chicago: University of Chicago Press, 278–293.
- Gee, J. P. (2003). *What Video Games Have to Teach us About Learning and Literacy*. New York: Palgrave Macmillan Press.
- Goldhaber, M. H. (1997a). Attention shoppers! Available at, [http://www.wired.com/wired/archive/5.12/es\\_attention.html?pg=3&topic=](http://www.wired.com/wired/archive/5.12/es_attention.html?pg=3&topic=).
- Goldhaber, M. H. (1997b). The attention economy and the Net. *First Monday* 2(4). Available at, <http://firstmonday.org/issues/issue2.4/goldhaber/>.
- Goldhaber, M. H. (1998). The attention economy will change everything. Available at, <http://www.heise.de/tp/english/inhalt/te/1419/1.html>.
- Goodlad, J. (1984). *A Place Called School*. New York: McGraw-Hill.
- Goody, J. (1977). *The Domestication of the Savage Mind*. Cambridge: Cambridge University Press.
- Havelock, E. (1976). *The Origins of Western Literacy*, Monograph Series/14. Toronto: The Ontario Institute for Studies in Education.
- Innis, H. (1961). *The Bias of Communication*. Toronto: University of Toronto Press.
- Jackson, P. W. (1968). *Life in Classrooms*. New York: Holt, Rinehart & Winston.
- Jenkins, H. (1998). Complete freedom of movement: video games as gendered play spaces. In: Cassell, J. and Jenkins, H. (Eds.) *From Barbie to Mortal Kombat: Gender and Computer Games*. Cambridge: MIT Press, 262–297.
- Kress, G. (2003). *Literacy in the New Media Age*. London and New York: Routledge.
- Lanham, R. (1997). The economics of attention. *Michigan Quarterly Review* 36 (Spring 1997), 270–284. Also available on line as Proceedings of the 124th annual meeting of the Association of Research Libraries.
- Lanham, R. (2001). What's next for text. *Education, Communication and Information* 1(2), 2001. Available at <http://www.open.ac.uk/eci/lanham/featext.html>.
- Lankshear, C. & Knobel, M. (2002). Do we have your attention? New literacies, digital technologies and the education of adolescents. In: Alvermann, D. E. (Ed.) *Adolescents and Literacies in a Digital World*. New York: Peter Lang, 19–39.
- Lankshear, C. & Knobel, M. (2003). *New Literacies: Changing Knowledge and Classroom Learning*. Buckingham, Philadelphia: Open University Press.
- Luke, A. (2002). What happens to literacies old and new when they're turned into policy. In: Alvermann, D. E. (Ed.) *Adolescents and Literacies in a Digital World*. New York: Peter Lang, 186–203.
- McLuhan, M. (1964). *Understanding Media: The Extensions of Man*. New York: McGraw-Hill.
- Ong, W. J. (1982). *Orality and Literacy: The Technologizing of the Word*. London: Methuen.
- Pew Internet & American Life Project. (2003). Let the games begin: gaming technology and entertainment among college students. Full report available at: <http://www.pewinternet.org/reports/toc.asp?Report=93>.
- Rieber, L. P. (1996). Seriously considering play: designing interactive learning Environments based on the blending of microworlds, simulations, and games. *Education Technology Research & Development* 44(2), 43–58.
- Ryle, G. (1949). *The Concept of Mind*. Chicago: University of Chicago Press.
- Simon, H. (1971). Designing organizations for an information-rich world. In: Greenberger, M. (Ed.) *Computers, Communication and the Public Interest*. Baltimore: Johns Hopkins University Press.
- Thorngate, W. (1988). On Paying Attention. In: Baker, W., Mos, L., VanRappard, H. and Stam, H. (Eds.) *Recent Trends in Theoretical Psychology*. New York: Springer-Verlag, 247–264.

- Thorngate, W. (1990). The economy of attention and the development of psychology. *Canadian Psychology/Psychologie Canadienne* 31, 262–271.
- Thorngate, W. (1997) More than we can know: the attentional economics of Internet use. In: Kiesler, S. (Ed.) *Culture of the Internet*. Mahwah, NJ: Lawrence Erlbaum Associates.
- Thorngate, W. & Bagherian, F. (1999). The political economy of attention and the limits of pedagogical technologies (Conference Paper). Available at [http://www.mtroial.ab.ca/critical\\_visions/papers/Thorngate\\_Bagherian.htm](http://www.mtroial.ab.ca/critical_visions/papers/Thorngate_Bagherian.htm).

# Chapter 38: E-learning Environments for Health Care: Advantages, Risks, and Implications

MONICA MURERO\* AND GIUSEPPE D'ANCONA†

\**E-Life International Institute—MICC, Center of Excellence for Media Integration and Communication—University of Firenze, Firenze, Italy.*

†*Cardiac Surgery Department, Galway Clinic- Galway, EIRE and Thorax Centrum, Rotterdam University, Rotterdam, NL*

## 1. INTRODUCTION AND RESEARCH QUESTIONS

The increasing diffusion of learning environments mediated by computers, or Virtual Learning Environments (VLEs) (Wilson, 1996) is a phenomenon of enormous visibility and significance for the society and individuals living in the Information Era.

In the health care context, there is no question that the diffusion of VLEs has profoundly changed education and practice. Medical training on “real” patients is no longer acceptable (Gallagher & Cates, 2004) and there is an increasing demand for simulation-based medical education. Continuing advances in Virtual Reality (VR) technology and computer-based Simulations Devices, available at increasingly low cost have opened new frontiers in teaching since the end of the 20th century.

Disparities in medical information and education are a major determinant of health practice inequities in developing communities. The recent diffusion of the internet<sup>1</sup> is facilitating the creation and circulation of “new” VLEs in the health-care field, that overcome traditional boundaries of “space”, “time”, and “place”. Yet, online learning environments bring along huge opportunities for learning and knowledge exchange among multiple users in remote areas of the world, but also new barriers.

The *validity* of the new internet mediated learning environments has still to be tested, especially for what concerns their ability to: (1) overcome “traditional boundaries” characterizing the learning experience and consequently change medical education and profession and (2) Help educate patients and “health seekers”.

## 2. THEORETICAL BACKGROUND

Several authors in this book have highly contributed to the discussion about the importance of learning in our life, and have shown how our daily experiences and interactions are mediated and located in “learning environments”. But what are learning environments?



Wilson (1996) defines a “learning environment” as an instructional metaphor, “a place where learners may work together and support each other as they use a variety of tools and information resources in their pursuit of learning goals and problem-solving activities”. When this happens, a classroom, a conference, or an operating room become learning environments.

According to previous literature (Ahmad et al., 1998; Jonassen, 1991; Jonassen et al., 1993; Wilson, 1995, 1996) any “learning experience” follows, implicitly or explicitly, two opposing learning models: objectivism and “constructivist”. “Objectivism” originates from the behavioral theory, and “constructivism” originates from the cognitive theory. The two models differ profoundly. The Objectivism model assumes that uncritical learners simply absorb facts from the instructor or a source of knowledge. On the contrary, the major assumption of “Constructivism” is that individuals learn better in an information environment where the teacher provides support and individuals discover things themselves rather than receiving directions (Ahmad et al., 1998).

### **2.1. VLEs—Computer-Mediated Learning Environments**

Following a constructivism theoretical approach Wilson defines the VLEs as “computer-based learning environments” (1996).

Online, the “traditional boundaries”, historically characterizing the learning experience, are overcome. When VLEs became available online, multi-space and poly-synchronous accessibility is granted to multiple users beyond geographical constraints. What is interesting is that with the diffusion of the internet, learners interact with “other networked participants, and with widely disseminated information tools” (Edelson et al., 1996).

Significant differences emerge between “online” and “offline” VLEs; therefore, it is necessary to introduce a theoretical differentiation between “offline” VLEs and internet mediated Learning Environments.

### **2.2. E-LE—Internet Learning Environments**

I define “E-Learning Environments” (E-LEs) as internet mediated or located learning environments, which overcome traditional boundaries of “space” “time”, and “place”, and are accessible by using the new Information and Communication Technologies (ICTs).<sup>2</sup> Cellular phones, last generation of palmary devices, and new integrated media equipments—including computers—are all media that allow users to access E-LEs.

E-LEs present several advantages compared to traditional VLEs (Ahmad, 1998; Winn & Jackson, 1999). However, as VLEs also E-LEs “carry their own set of design challenges and concerns” (Wilson, 1996). As we will see in this chapter, although learning environments available online can enhance or

obstacle the knowledge experience, VLEs and E-LEs present new tremendous learning potentials and challenges for both doctors and “health seekers”.<sup>3</sup>

### 3. E-LE AND HEALTH-CARE PROVIDERS

In the last century, medical advances are perhaps humanity’s greatest achievement (WHO, 2004).<sup>4</sup> Since the diffusion of early electronic processors during the 20th century, computer-based learning environments have highly contributed to medicine’s accomplishments in every discipline, from epidemiological studies to organ replacements trials and from designing of diagnostic machinery to DNA engineering, including cloning.

Starting from the 1960s, but more intensively from the 1980s, VR<sup>5</sup> technology and highly sophisticated computer applications are offering extraordinary VLEs to exchange knowledge and educate doctors.

In addition, the recent diffusion of the internet and the concomitant integration of several important factors, including systems costs reductions, have allowed for revolutionary transformations in the medical daily practice, research, and education for physicians.

#### 3.1. First, Do No Harm

*“... primum non nocere”*

(... first, do no harm. Hippocrates, Greek Physician. Circa 460–370 BC)

Advanced tech and VLEs in medical education have become a “must”. International patient safety movement and policy makers demand that simulation-based medical education become an ethical imperative to “first do no harm” (Ziv et al., 2003). In the last 20 years, VLEs have offered important contributions to the medical research and education. In particular, 2D and 3D technology simulations of human body have created innovative opportunities for learning in “reproduced”, “enhanced”, and “true” VLEs.

In medical training, “often the appropriate patient is missed or he/she can not be demonstrated to all students because of practical or ethical problems” (Ruderich et al., 2004). Computer-based patient simulations (CBPS) provide an effective instructional virtual environment for medical trainees, which acquire highly specialized medical skills by practicing on “virtual” subjects.

VR simulations offer several benefits for learners, in terms of quality and security in training, including risk-free practice—avoid to hurt real patient—and endless case reproducibility for improved skills acquisition, that may help shorten the learning curve early in training of diagnostic and treatment procedures (Ogan et al., 2004).

In the surgical field, Grantcharov et al. (2004) showed in randomized double-blind trial that training by VR significantly reduces student's errors in laparoscopic cholecystectomy—key-hole gallbladder surgery—and, therefore, should be implemented in surgical training programs, confirming previous findings (Ali et al., 2002; Seymour et al., 2002). Several other authors (Ahlberg et al., 2002; Torkington et al., 2001) validated the usefulness of VR in medical training, while Gerson and Van Dam (2003) findings suggested that medical educators should always associate innovative VR based endoscopy simulator with traditional—real patients—teaching protocols. VLEs should be implemented in the medical educational programs. However, Gallagher and Cates (2004) observed that further empirical evidences are required “to convince the more conservative members of the medical community”.

### **3.2. E-LE and Medical Education**

In the past pre-internet phase, VR technology has offered invaluable educational advantages, but still within the constraints of the “traditional” learning experience. In this context, the more recent concept of “online” learning environments has promised to push medical education armamentaria further ahead. Thanks to the combination of several factors—political, economical, and social, including new ICT—state-of-the-art simulation tutorials and new learning environments for medical education are increasingly available for the first time via the internet, offering new possibilities for learning in the health-care field.

Accessing E-LEs are becoming normal practice among an increased number of networked users. Web-based university courses to train medical students and postgraduate practitioners<sup>6</sup> are recently developed in several Western countries (Grunewald et al., 2004; Marescaux et al., 2000). In France for example, WeBS-Surg, offers an E-LE for medical education and successfully makes available VR based applications to train medical students living in remote areas (Marescaux et al., 2000).

Medical educators are under considerable pressure to enhance the quality and safety of medical care. In Emergency medicine for example, medical education materials via the internet and advanced tech are becoming “educational standards”, especially when invasive or very rare procedures that are difficult for trainees to “see and do” in real clinical practice need to be acknowledged (Vozenilek et al., 2004).

The usefulness and effectiveness of the internet in teaching medical students has been tested and proved in several field, including cardiology, radiology, and pathology (Gomez-Arbones et al., 2004; Grunewald et al., 2004; Marchevsky et al., 2003).

In Australia, Kumar et al. (2004) described the successful implementation of teaching microscopic pathology with online virtual slides, to closely

simulates examination of glass slides with a real microscope for the study of both histology and histopathology. E-LEs like CAMPUS help German speaking students acquire advanced skills for diagnosis by examining online medical cases, by offering personalized learning experiences on the basis of users' characteristics (Ruderich et al., 2004).<sup>7</sup>

When we look more specifically to the young generations, literature shows that medical students are highly familiarized with the use of computers and the internet. Surveys demonstrate high student demand for computer-aided instruction and anatomy applications offered on the internet (Jastrow & Hollinderbaumer, 2004).

Literature has shown that E-LE can help develop standardized teaching and design methods for long-distance medical education and training.

The development of sophisticated E-LEs like CAMPUS often means a lot of work for designers. Collaborative VLEs (Wilson, 1996) emerge from E-LE designers, who need to stimulate and integrate users feedback into practice to improve current system development in medical training (Ruderich et al., 2004).

### **3.3. E-LE in Medical Practice**

E-LE can offer applications for knowledge exchange in the professional medical practice and research, and ultimately benefit patient's care.

Not long ago, treatment decisions were based on personal experiences, anecdotal reports, and a few case reports. VLEs and in particular E-LEs are offering encyclopedic breath information that can ultimately benefit patient's diagnosis and treatment. VLEs and E-LE are increasingly integrated in the medical consulting practice by using e-mail, videoconferencing, on-line presentations, virtual offices, instant messaging (Kropf, 2003), and new telemedicine devices. Many benefits may result from the use of E-LE in medical daily practice, including, decreased errors in exchanging patients records, less interruption of own daily practice, access to high quality specialized consultancy, and more efficient dissemination of knowledge, including Teleproctoring—long-distance supervision during surgical procedures in disadvantaged or remote areas (Pande et al., 2003). From a more practical standpoint, thanks to improved ICTs, patients, their families and—to some extent—consultants benefit from reduced travel time and travel expenses.

Patients appear to benefit the most, at the present, from the use of advanced technologies in the medical field: for example, 1000 patients living in rural areas of United States needing post-burn visits, saw their doctor at several miles of distance. Teleconsulting resulted a highly cost-effective alternative for patients and their family, but still a financial burden, and in part inefficient, for health-care providers (Nguyen et al., 2004).

In psychotherapy, online VR are used to cure patients suffering from anxiety. Since 1995 VR Exposure Therapy was shown (Rothbaum et al., 1995) to

be very effective in reducing acrophobic—subjects that fear heights—anxiety and avoidance of heights. Through virtual environments patient are gradually exposed to feared situation: in a context that is nearer to reality than imagination. Online VR environments are successfully used in Experiential-Cognitive Therapy (ECT) to treat several psychological conditions, like panic disorder, agoraphobia (Vincelli et al., 2002)—and eating disorders (Riva et al., 2002).

Rizzo et al. (2004) describe a system that is currently being used to deliver virtual worlds over the internet for training safety skills to children with learning disabilities, and patients needing rehabilitation.

As regards medical procedures, thanks to the Robotic Technology, skilled surgeons can even operate via Telesurgery systems on patients located in remote and distant areas of the world (Pande et al., 2004; Semere et al., 2003a;) while comfortably seated in a chair, in comfortable clothes, without risking to contaminate the surgical field (screen).

### **3.4. Collaborative Learning Environment and Advanced Medical Research**

In the scientific research practice, the diffusion of new E-LEs benefits medical knowledge exchange. The National Library of Medicine offers free access to “Entrez”,<sup>8</sup> an integrated text-based search and retrieval system that allows users access the major medical databases like PubMed to retrieve scientific articles, but also online books, and even the whole Genome sequence.

E-LEs facilitate the creation, exchange, and delivery of new findings within interdisciplinary and international study groups in many areas of medicine, like in gene studies,<sup>9</sup> to find solutions and treatments of life-threatening conditions like cancer, HIV, multiple sclerosis, and heart disease.

In 2004, the British National Cancer Research Institute (NCRI) has launched an important initiative to bring together international scientists in a virtual community to access, analyze, and share findings in a common format across disciplines about cancer research, from genomics to clinical trials (Pincock, 2004).

### **3.5. Validity of E-LEs for Health-Care Providers**

Literature has largely shown that E-LEs are convincing means to overcome traditional boundaries of the learning experience, and secondly that they are profoundly changing medical education and practice, particularly in Western countries. Medical students learn from multiple channels, including E-LEs. Virtual and E-LEs can contribute—still with limitations at the present—to develop standardized teaching and methods *for long-distance medical education*, also in developing countries. Medical daily practice and research is

increasingly but profoundly challenged as well. These phenomena have no precedent in the history of health care.

The new E-LEs available for the health-care field potentially have a wide range of advantages over “offline VLEs” and “real” environments (e.g., convenience, flexibility, lower costs, currency of materials, increased retention, transcending geographical and barriers, and multisyncronicity) (Ahmad et al., 1998; Winn & Jackson, 1999).

In spite of the tremendous impact that VLEs and E-LE are having on the health-care field, many clinicians and surgeons remain unaware or skeptical of their actual potentiality in medical training and practice, and their possible future applications (D’Ancona, 2001; Grantcharov et al., 2004). In reality, new E-LEs are already changing doctor’s professional and private lives, giving to many of them—especially the young generations—the possibility to quickly transfer, to colleagues and patients, educational and research information.

### **3.6. Cultural and Digital Medical Divide: What Opportunities for Developing Countries?**

From a more global view, new technologies and “educational agents” should help the international medical community reduce the disparities in information and education that most often are a major determinant of health inequities in the developing countries (Filho, 2002). The Virtual Health Library<sup>10</sup> takes advantage of the potential of ICTs to foster access to state-of-the-art medical information and democratization of knowledge, and consequently promote equity in health.

In the developing countries medical students with access to the internet but with low abilities to use ICTs might not be able to access E-LEs for medical education and training. In this regard, a U.K. study (Samuel et al., 2004) has assessed the ICT skills of medical students in Tanzania. Interestingly, a period of approximately 5 hours of peer—U.K. students—online mentoring training produced an approximate doubling of competence scores. Similar telementoring experiences should be further developed to improve ICTs skills and improve access to E-LE in the developing countries.

## **4. CAN E-LE EDUCATE PATIENTS?**

Adequate medical information is a crucial mean to prepare, sensitize, and educate patients before and after medical intervention (D’Ancona et al., 2001). With the rapid growth of the internet, not only doctors but also the general public of “health seekers” is able to access medical information of encyclopedic breath by surfing the WWW, and learn about health-care online.

The internet can help patients and their family better understand their disease and treatment in the convenience of a multisynchronous fruition, transcending geographical constraints, and in the comfort of their home. This is an unprecedented phenomenon, not in the “needs” to learn medical information but in the “ways” people do it.

Prior to the internet, and particularly, the WWW, family doctor, television, book magazines, and other printed publications were the most common sources of medical information for health seekers. Time-consuming trips to the library to consult books and journals on a topic, and related subjects were the usual research method for most of the people.

With the diffusion of the E-LE, going online to search for health related information has become the third most popular activity that almost 100 million internet users in the United States—especially women—perform online, after e-mailing and searching for a product or service before buying them (Fox & Rainie, 2000, 2002). In Europe (Murero & Nash, 2003) health seekers are exponentially growing, but empirical research is still scarce.

The internet is a powerful tool that can help patients and health seekers retrieve medical information and increase knowledge about innovative procedures and treatments (D’Ancona et al., 2002; Ferguson, 2002; Murero & D’Ancona, 2001, Murero et al., 2001). As an example, in the heart surgery field authors have dedicated their attention to analyze the pros and cons of E-LE patient education (Scherrer-Bannerman et al., 2000).

In an original study entitled Rural Online Cardiac Education Project (ROCEP), Scherrer et al. analyzed the effectiveness of the internet and other traditional methods of medical education in a group of patients awaiting cardiac surgery. Interestingly, the web-based method offered increased social support, decreased anxiety, improved lifestyle, and more positive attitudes toward the impending surgery. Leaffer and Gonda (2000) demonstrated that senior citizens could easily acquire computer and internet skills to search for medical information on the web. Moreover, the elderly use this tool to assume an active role in their personal healthcare.

#### **4.1. Collaborative Learning Environments for “Health Seekers” in E-LE**

Patients and their family or friends are pioneering new forms of collaborative E-LEs. A stunning example has been proposed in the literature (Larson, 2004): a woman with leukemia needing a rare bone marrow match found a donor online, after her family and friends built an online registry to help her and other donors find a proper match. The operation allowed for testing more than 12,000 people in 14 weeks, and finally finding a proper match.

The diffusion of “collaborative” E-LEs, made possible for the first time by the internet such as online Virtual communities, mailing lists—including e-mailing—or bulletin boards, allows health-care seekers to retrieve, acquire,

demand, share, and medical information in innovative modalities. It is a new significant phenomenon in the history of health care. This very interesting but vast phenomenon will be specifically analyzed in future publications.<sup>11</sup>

#### **4.2. Threat to Validity of E-LE in Patients' Education**

Presence of medical terms and lack medical culture may act as significant barriers to online education when sample underwent in-depth interview conducted by their physician (D'Ancona et al., 2002). In an online multiple-choice quantitative survey Taylor (2002) found that American respondents, along with French and Germans participants gave internet-based health information positive marks, in terms of quality and readability, while Japanese resulted the most skeptical.<sup>12</sup>

*Accessing* online information does not mean understanding and *learning it*. In our in-depth analysis, we found that 83% of the sample report some difficulties in fully comprehending the information found on the web, especially when medical "language" was used. This caused, in some instances, increased level of anxiety especially in patients waiting for life-threatening procedures such as heart surgery.

All patients agreed that medical information on the WWW should be reported using simpler language in order to make it more accessible to the majority of the web users. Interestingly, the degree of college education had no correlation to the level of understanding of information provided by medical Websites. Pre-existing medical culture facilitates health seekers' proficiency in finding, understanding, and sharing medical facts online.

In order to help health seekers understand medical terminology the Medical Library Association,<sup>13</sup> offers reliable information online, including several resources like the "Top Ten" most useful consumer Health Web Search.

##### *4.2.1. Too Much Information Online? The Overwhelmed Consumer*

Using a search engine and entering a medical condition can often result in thousands of results. Literature shows (Al-Bahrani & Plusa, 2004; Murero & D'Ancona, 2001) that overwhelming data retrieved by the internet can, in some instance, result as a confounding factor in promptly and efficiently acquiring the desired and specific information online users look for. A very recent survey (Al-Bahrani & Plusa, 2004) confirmed that the internet provides enormous amount of patient-oriented information, but accessibility and quality of information is highly questionable. Medical doctors who run the analysis simulated patients' searching strategies. By entering few words in popular search engines (Google and Hotbot) thousands of sites were retrieved and 400 were selected to assess accessibility and quality of information.



Results confirmed that the “best sites” for consumers’ education are very difficult to distinguish among the thousands of sites returned by search engines.

#### *4.2.2. Poor Quality in E-LE: The Risk of Online Misinformation*

When health seekers and patients search medical information by using E-LE there is a concrete risk that they access poor quality, limited, or distorted medical information (D’Ancona et al., 2002). Health seekers risk not to access certified info in medical E-LE, *invalidating the learning experience*.

Significant concern should be raised about the correctness, credibility, and origin of medical information available on E-LEs. In order to increase the credibility of the information presented online and the quality of the learning experience.

#### *4.2.3. Digi-Cultural Medical Divide*

Although the diffusion of the internet is increasingly expanding and the number of health-care seekers rapidly growing in Western countries—especially in the United States—patients that could mostly advantage from E-LEs, and particularly from online health related medical information, are often unaware of the potential and actual benefits of learning about their medical condition on the internet (D’Ancona et al., 2002).

Since the introduction of E-LEs, we observed an emerging digi-cultural divide between e-health seekers that access E-LE and the general public offline. The latter does not have access to the internet and is not able to access neither the internet nor low costs, rapid, and encyclopedic breath medical information, in convenient settings and modalities, and therefore is not able to access new cultural opportunities to improve medical knowledge and education.

### **4.3. Validity of E-LE for Patient’s Education**

Patients have shown increasing need for self-management skills and efficacy in using E-LE to acquire medical knowledge (Molfenter et al., 2002). In many cases, E-LEs resulted as powerful tools to learn medical evidences about innovative procedures and treatments. We should not forget that although there are controversial issues to resolve, several studies show that health seekers and patients benefit from online information (D’Ancona, 2001; Fox & Rainie, 2000, 2002; Murero et al., 2001; Taylor, 2002).

In many cases patients and their families are still unaware of how to correctly use E-LE to retrieve medical information from which they could,

eventually, largely benefit in terms of education, and decision-making. Non-medical public cultural barriers, internet “overwhelming” information, and online misinformation *can invalidate* the learning experience for online users.

## 5. PATIENT-DOCTOR: A CHANGING RELATION?

### 5.1. Meet the “Empowered” Patient!

They [patients] are arriving to your clinic armed with information they have found on the web, with a preconceived idea about their diagnosis and treatment options, more demanding regarding convenience and ease of access. They want to actively participate in therapeutic decisions and want all the decisions to be informed and intelligent. Meet the new empowered patient!; empowered by the information technology and its benefits.

(Akerkar & Bichile, 2004)

Before the diffusion of the internet, patient tended to simply listen and comply to doctor’s indications. The centrality of the doctor was undisputable. More recently, patients are able to retrieve, for the first time in history, thousands of health care related websites, and as a consequence tend to confront their doctor on the basis of internet conceived notions.

According to a 2002 research on the American population (Fox & Rainie, 2002) web medical information changed patient’s decision about how to treat their illness in 70% of cases, or on circa 70 millions Americans, while for 28 millions “health seekers” web information influenced their decision as to whether or not to visit a doctor.

When describing e-patients dealing with their doctors after being exposed to online notion acquisition, Akerkar (2004) distinguishes among “informed”, “impatient”, and “lobbying for care” patients.

Recent studies show that online learners are more prone to ask clarifications to their doctors, but also are able to find themselves online answers to embarrassing questions (Molfenter et al., 2002). Literature confirms that patients go to their doctor with more confidence, more capability to discuss alternative treatments, or simply ask for explanations. Patients “come with data, but are still searching for meaning and right action” (Klass, 2004).

When “health seekers” access comprehensible and reliable information within E-LE they can properly learn medical information and benefit from it. However, as we emphasized, patients not always completely understand the retrieved information, but in some cases they are stimulated to discuss it with the doctor to find alternative explanations and treatments to their conditions, or try to “lobby their solution” on the basis of the notions acquired in medical E-LE.

## 5.2. The Enhanced Role for Medical Specialists

In the literature, *doctors* are reported as, in part, complaining, and in part, welcoming this new phenomenon (Akerkar & Bichile, 2004). Doctors may become annoyed when patients are misinformed or misunderstand online medical information, or have a large cultural divide, but tend to be open and welcoming toward—correctly—informed patients that are less afraid to discuss alternative and consequences of medical decisions.

The majority of patients who have internet access are exposed to a wide array of medical information on the internet without the tutoring of their physicians (Fox & Rainie, 2002). Literature has shown that patients would benefit from accessing internet-sites directly developed by their immediate health-care provider (D’Ancona et al., 2002; Murero & D’Ancona, 2001; Semere et al., 2003b).

Medical *doctors should do more to help* maximize, optimize, and direct health-care information available via the internet for health seekers—their patient and family—to help correctly address conditions that could be life threatening. Medical doctors should help rather than obstruct this process and guide patients to quality sites to avoid confusion, misinformation, and poor judgment, including negative consequences on the patient–doctor relation.

The facilitating role of medical specialists in maximizing the online learning experience can help validate E-LEs as multiple sources of education for “health seekers”, and represent a “convincing factor” for the skeptical medical community.

## 6. CRITERIA TO ASSESS QUALITY IN MEDICAL E-LEs

Non-medical population is increasingly able to retrieve virtually the same information that doctors access online. As the interest and the request for health information mediated by the internet is proliferating, there is a growing need for objective, reproducible, widely accepted criteria that can regulate the publication of medical material on the Net. Criteria for evaluating—and diffusing—internet health information have been presented in a policy paper supported by the Agency for Health-Care Policy and Research (Mitretek, 2002). Among the most important criteria are “credibility, content, and disclosure” of web-based medical information.

The Health on the Net Foundation Code of Conduct (HONcode<sup>14</sup>) for medical and health web sites is helping standardize the reliability of medical and health information available on the WWW by elaborating eight principles that are increasingly adopted by medical website developers. Among the most important criteria for E-LE designers are respect of personal data, clear indication of sources of information, and transparency. Interestingly, the first principle of the HONcode states that: “Any medical or health advice provided and hosted

on Websites site will only be given by medically trained and qualified professionals unless a clear statement is made”(principle of Authority); the second principle (Complementarity) recite that medical and health information available in E-LE—Websites—should “support, not replace, the relationship that exists between a patient/site visitor and his/her existing physician. The HON-code principles were implemented in a very important EU policy act (2002).

The adoption of criteria of conduct for medical and health Websites is very important; they can help learners assess credibility and reliability of online medical and Health information, and improve the validity of E-LEs in educating patients and health seekers in multiple contexts.

Although the internet is a powerful tool for improving health-care decision-making process, users should be aware of the potential for incorrect information and should always assess the quality of the information that is provided in the internet, therefore including e-mail, mailing lists, and online forums or “community”. Quality of online “patients networks” need particular attention (Ferguson, 2002).

## 7. FUTURE SCENARIOS

### 7.1. The Next Revolution

In the last decades, computers and more recently the internet have revolutionized the way society and individuals operate in every day life, including medical education. The next step in this evolution will allow for E-LEs accessibility to libraries of VR scenarios as a likely form of distribution and use (Rizzo et al., 2004).

In future years, molecular scale research like Nanotechnology,<sup>15</sup>—or the creation of devices, materials, and systems through the control of matter on the nanometer scale—is believed to transform our society (NASA, 2004), including the health-care field<sup>16</sup> and environments for teaching and learning. In this scenario, the integration of new ICTs, Bio-Technology, Genetic Engineering combined with “Nanomedicine<sup>17</sup>”, and new frontiers in medical achievements, will transform even more the health-care field. In the meantime, the integration of computer and statistical sciences along with biometric and biomedical research, for example, is breaking new ground for researchers that are working to create “truly virtual” patients, which they say could 1 day replace real people to whom administer placebo in some clinical trials for the development of new drugs and the cure of severe diseases like multiple sclerosis (Cleaver, 2004).

New miniaturization technologies and media integration, along with increased quality of medical information available to the general public could facilitate the development of “sophisticated” Learning Environments that will help accelerate the diffusion of medical education and discoveries all over the

planet, bringing along new threats and opportunities for learning and knowledge exchange, for both health-care providers and receivers.

## CONCLUSIONS

Challenges introduced by VLEs and E-LEs in the health-care field have no precedents in the medical history. Literature has largely demonstrated that E-LEs are convincing means to overcome traditional boundaries of the learning experience, and are profoundly changing medical education and practice, particularly in Western countries, but still with some limitations. The financial barriers to internet access in the developing countries are still enormous. Many clinicians and surgeons remain unaware or skeptical of their actual potentiality in medical training and practice, and their possible future. We are only at the beginning of a highly promising revolutionary process. In the future, E-LEs and ICTs can help overcome health inequity in the developing countries.

Patients and health seekers acquire new means to access encyclopedic breath medical information on the internet, with huge benefits in terms of decision-making and empowerment in the relation with their physicians. However, cultural barriers, and online misinformation can invalidate the learning experience within E-LE.

It is in the interest of health-care providers and possible internet-content providers, to always post on the Net only high quality information accessible to past, present, or future “health-care seekers”. Future collaborations among medical doctors, health-care providers, website developers, and communication experts adopting international guidelines for medical Website producers, like the HONcode may help improve the quality of medical information available in E-LEs, diffuse proper education among health-care learners, and close the digi-cultural medical divide. Positive effects on the patient–doctor relation, and ultimately on patient’s health can be foreseen in future scenarios.

## SUMMARY

Improved health-care is perhaps humanity’s greatest achievement of the last century. Increasingly sophisticated VLEs have largely helped this achievement.

VR technology and computer-mediated learning environments—or VLEs (Wilson, 1996)—have profoundly changed the offer and demand of medical education and knowledge. Medical training on “real” patients is no more acceptable at the beginning of the new millennium.

In addition, the recent diffusion of the internet is *revolutionizing the Health-care field* by increasingly facilitating the diffusion of E-LE, or Learning Environments located or mediated by the internet and accessible via new ICTs.

E-LEs overcome the traditional barriers of “place” “space”, and “time” characterizing traditional learning experience.

New means to create, deliver, and exchange medical education, experience and interaction are now increasingly available online. As a result, the medical practice itself is rapidly changing, including new means to exchange medical research findings for the international community, and for the developing countries. However, we are at the beginning of a new phenomenon; financial and cultural barriers are still limiting the diffusion of VLEs.

Moreover, with the recent diffusion of the internet, not only health-care providers, but also health-care “seekers” can benefit from “new” learning opportunities. Although the non-medical public can impressively access online medical info of encyclopedic breath in few seconds we should ask ourselves: can the internet educate patients?

Adequate medical information is a crucial mean to prepare, sensitize, and educate patients before and after medical or surgical intervention. Although the benefits of proper and adequate patient education are enormous, a large number of patients remain unaware of how and where to retrieve medical information suited to their needs. Although the internet is a very powerful tool for assessing health-care decision-making (Fox & Rainie, 2002) users should be aware of the potential for misinformation and should always assess the quality of the information that is provided. When patients and their family USE the internet, new VLEs for the health-care offer them huge benefits for learning and knowledge exchanging but on the other hand, at the present stage (2004) they also create new barriers and risks for users, including misinformation, privacy, and security concerns.

For the better or the worse, the doctor–patient relation is changing as an effect of the exposure to the medical information available on the internet.

On this base, we should foresee a reshaped and more focal position for the doctors in the next future, but also an “empowered”—in part—patient as well. In order to overcome present risks of online misinformation and digital-cultural medical divide, health-care providers and interdisciplinary collaborations should play a future key role to educate patients, their family, and health-care seekers by suggesting “safe” websites where they can find certified information and acquire information.

#### ENDNOTES

1. “The internet is the publicly available worldwide system of interconnected computer networks that transmit data by packet switching over the IP (Internet Protocol). It is made up of thousands of other, smaller business, academic, and government networks that provide various information and services, such as by e-mail, online chat, and on the graphical, interlinked World Wide Web (WWW). Because it is the largest, most

extensive internet (with a small i) in the world, it is simply called the Internet (with a capital I)". *Source*: wordiQ, retrieved on 27 Oct, 2004 at <http://www.wordiq.com/definition/Internet>. Furthermore, according to a definition from the United States versus Microsoft case, the internet is the "global electronic network, consisting of smaller, interconnected networks, which allows millions of computers to exchange information over telephone wires, dedicated data cables, and wireless links. The internet links PCs by means of servers, which run specialized operating systems and applications designed for servicing a network environment". *Source*: US versus Microsoft, 84 F.Supp.2d 9, 13 (DDC Nov 5, 1999)

2. "ICT (information and communications technology—or technologies) is an umbrella term that includes any communication device or application, encompassing: radio, television, cellular phones, computer and network hardware and software, satellite systems and so on, as well as the various services and applications associated with them, such as videoconferencing and distance learning. ICTs are often spoken of in a particular context, such as ICTs in education, health care, or libraries. The term is somewhat more common outside of the United States". *Source*: SmallBizIT Glossary, Retrieved online on 20 September 2004 at [http://searchsmallbizit.techtarget.com/gDefinition/0,294236,sid44\\_gci928405,00.html](http://searchsmallbizit.techtarget.com/gDefinition/0,294236,sid44_gci928405,00.html).
3. The population of "health care seekers" that access and search medical Websites includes patients that have already undergone or will undergo medical or surgical treatment, and people that do not have personal health related problems, but might need to find medical information online to help a third person.
4. According to Lee Jong-wook (World Health Organization), in Daniel Epstein (2004).
5. Two very interesting sources on VR and Virtual Environments are available at: <http://www.insead.fr/CALT/Encyclopedia/ComputerSciences/VR/vr.htm>.
6. Medical practitioners are required by law to attend continuing medical education courses in order to keep their license valid over time. This is to transfer updated medical knowledge to post-graduate medical practitioners and benefit patients from new medical discoveries that become available. Specific modalities and requirements vary according to each medical specialty and by each country regulations.
7. CAMPUS ([www.medicase.de](http://www.medicase.de)).
8. <http://www.ncbi.nlm.nih.gov/entrez/query.fcgi>.
9. <http://genoma.unsam.edu.ar/projects/tram/>.
10. The Virtual Health Library, <http://www.dse.de/zg/lernbibl/links/index.htm>.
11. Murero M., Rice R. Internet and Health Care (2005 in press).

12. The study shows data from 309 “cyberchondriacs” in the United States, 327 in France, 407 in Germany, and 275 in Japan (*Source*: Harris Interactive).
13. The Medical Library Association: <http://www.mlanet.org/resources/medspeak/topten.html>. offers Deciphering Medspeak [http://www.mlanet.org/resources/medspeak/medspeaka\\_d.html](http://www.mlanet.org/resources/medspeak/medspeaka_d.html).
14. The Health on the Net Foundation Code of Conduct: [http://www.hon.ch/HONcode/HON\\_CCE\\_en.htm#5](http://www.hon.ch/HONcode/HON_CCE_en.htm#5).
15. A nanometer is one-billionth of a meter ( $10^{-9}$  [m]), or 0.039 micro-inches. Visible light covers the wavelength range from 380 to 780 nm.
16. Disease and ill health are caused largely by damage at the molecular and cellular level. According to Robert Freitas Jr. in Nanomedicine “*the ability to direct events in a controlled fashion at the cellular level is the key that will unlock the indefinite extension of human health and the expansion of human abilities*”.
17. For more on “Nanomedicine”, see also: <http://www.landesbio-science.com/iu/output.php?id=219>.

#### REFERENCES

- Ahmad R., Piccoli G., & Ives B. (1998). Effectiveness of Virtual Learning Environments in Basic Skills Business Education: A Field Study in Progress. *Proceedings of the International Conference on Information Systems*, Helsinki, Finland. Available from: <http://80-delivery.acm.org.gate.lib.buffalo.edu/10.1145/360000/353094/p352-ahmad.pdf?key1=353094&key2=3335819901&coll=ACM&dl=ACM&CFID=30422498&CFTOKEN=22274536>.
- Ahlberg, G., Heikkinen, T., Iselius, L., Leijonmarck, C. E., Rutqvist, J., & Arvidsson, D. (2002). Does training in a virtual reality simulator improve surgical performance? *Surgical Endoscopy* 16(1), 126–129.
- Akerkar, S. M. & Bichile, L. S. (2004). Doctor patient relationship: changing dynamics in the information age. *Journal of Postgraduate Medicine* [serial online] 50, 120–122. Available from: <http://www.jpgmonline.com/article.asp?issn=0022-3859;year=2004;volume=50;issue=2;spage=120;epage=122;aualast=Akerkar> Accessed on November 8, 2004.
- Al-Bahrani, A. & Plusa, S. (2004). The quality of patient-orientated Internet information on colorectal cancer. *Colorectal Disease* 6(5), 323–326.
- Ali, M. R., Mowery, Y., Kaplan, B., & DeMaria, E. J. (2002). Training the novice in laparoscopy. More challenge is better. *Surgical Endoscopy* 16(12), 1732–1736 (Epub 2002 July 29).
- Cleaver, A. (2004). German researchers are building a database to predict the progression of MS. *The Scientist*. Retrieved on the WWW on November 6, 2004 at <http://www.biomedcentral.com/news/20031015/02>.
- D’Ancona, G., Murero, M., Bergsland, J., & Karamanoukian, H. (2001). Is the Internet a useful tool to educate cardiac surgery patients? Editorial. *Heart Surgery Forum* 5(2), New York, USA.
- Edelson, D. C., Pea, R. D., & Gomez, L. (1996). Constructivism in the collaboratory. In: Wilson, B. G. (Ed.) *Constructivist Learning Environments: Case Studies in Instructional Design*. Englewood Cliffs NJ: Educational Technology Publications.



- Epstein, D. (2004). Global health leaders join the World Health Organization to announce accelerated efforts to improve patient safety. *Press Release*. Retrieved on the WWW on 28 Oct. 2004, at <http://www.who.int/mediacentre/news/releases/2004/pr74/en/>.
- Ferguson, T. (2002). From patients to end users: quality of online patient networks needs more attention than quality of online health information. *British Medical Journal* 324, 555–556.
- Filho, A. P. (2002). Inequities in access to information and inequities in health. *Panam Salud Publica* 11(5–6), 409–412.
- Fox, S. & Rainie, L. (2000). The online health care revolution: how the web helps Americans to take better care of themselves. *Pew Internet and American Life Project*. Sunday November 26 at: [http://207.21.232.103/pdfs/PIP\\_Health\\_Report.pdf](http://207.21.232.103/pdfs/PIP_Health_Report.pdf). Accessed on September 29, 2004.
- Fox, S. & Rainie, L. (2002). *Pew Internet and American Life Project "Vital Decisions", Summary of Findings, and Part Six: Impact*. Washington, DC, May 2002 at: [http://www.pewinternet.org/pdfs/PIP\\_Vital\\_Decisions\\_May2002.pdf](http://www.pewinternet.org/pdfs/PIP_Vital_Decisions_May2002.pdf). Accessed on September 29, 2004.
- Gallagher, A. G. & Cates, C. U. (2004). Virtual reality training for the operating room and cardiac catheterisation laboratory. *Lancet* 364(9444), 1538–1540.
- Gerson, L. B. & Van Dam, J. (2003). A prospective randomized trial comparing a virtual reality simulator to bedside teaching for training in sigmoidoscopy. *Endoscopy* 35(7), 569–575.
- Gomez-Arbones, X., Ferreira, A., Pique, M., Roca, J., Tomas, J., Frutos, J. L., Vinyas, J., Prat, J., & Ballester, M. (2004). A cardiological web as an adjunct to medical teaching: prospective analysis. *Medical Teacher* 26(2), 187–189.
- Grantcharov, T. P., Kristiansen, V. B., Bendix, J., Bardram, L., Rosenberg, J., & Funch-Jensen, P. (2004). Randomized clinical trial of virtual reality simulation for laparoscopic skills training. *British Journal of Surgery* 91(2), 146–150.
- Grunewald, M., Gebhard, H., Jakob, C., Wagner, M., Hothorn, T., Neuhuber, W. L., Bautz, W. A., & Greess, H. R. (2004). Web-based training in radiology—student course in the Virtual University of Bavaria. *Rofo* 176(6), 885–895.
- Jastrow, H. & Hollinderbaumer, A. (2004). On the use and value of new media. *Anatomica Record (The new Anatomist)* 280B(1), 20–29.
- Jonassen, D. (1991). Objectivism versus constructivism: do we need a new philosophical paradigm. *Educational Technology, Research and Development* 39(3), 5–14.
- Jonassen, D., Mayes, T., & McAleese, R. (1993). A manifesto for a constructivist approach to uses of technology in higher education. In: Duffy, M., Lowyck, J., and Jonassen, D. (Eds.) *Designing Environments for Constructive Learning*. Berlin: Springer-Verlag, 231–247.
- Klass, D. J. (2004). Will e-learning improve clinical judgment? *BMJ* 328, 1147–1148.
- Kropf, R. (2003). How shall we meet online? Choosing between videoconferencing and online meetings. *Journal of Healthcare Information Management* 16, 4.
- Kumar, R. K., Velan, G. M., Korell, S. O., Kandara, M., Dee, F. R., & Wakefield, D. (2004). Virtual microscopy for learning and assessment in pathology. *Journal of Pathology* 7.
- Larson, K. (2004). Woman Finds Cone Marrow Transplant Donor. *Newsday.com*, Associated Press. Retrieved on the Internet on November 8 2004 at: <http://www.newsday.com/news/health/wire/sns-ap-south-asian-match,0,2879434.story?coll=sns-ap-health-headlines>.
- Leaffer, T. & Gonda, B. (2000). The Internet: an underutilized tool in patient education. *Computers in Nursing* 18(1), 47–52.
- Leaders Discuss Nanotechnology Market. (2004). *Technology Innovation* 11(3), Fall 2003, Technology Transfer. NASA, USA. Available online at: <http://ipp.nasa.gov/innovation/3-techtrans4.html>. Retrieved on 29 October 2004.
- Marchevsky, A. M., Relan, A., & Baillie, S. (2003). Self-instructional “virtual pathology” laboratories using web-based technology enhance medical school teaching of pathology. *Human Pathology* 34(5), 423–439.

- Marescaux, J., Soler, L., Mutter, D., Leroy, J., Vix, M., Koehl, C., Clement, J. M., Related Articles, Links. (2000). Virtual university applied to telesurgery: from teleeducation to telemanipulation. *Studies in Health Technology and Informatics* 70, 195–201.
- Mitretek Systems Health Information Technology Institute. (2002). Criteria for assessing the quality of health information on the Internet. Available at <http://hitiweb.mitretek.org/docs/criteria.html>. Retrieved on the WWW on November 2, 2004.
- Molfenter, T., Johnson, P., Gustafson, D. H., DeVries, K., & Veeramani, D. (2002). Patient Internet services: creating the value-added program. *Journal of Healthcare Information Management* 16, 4.
- Murero, M. & D'Ancona, G. (2001). E-health: Internet Access to Cardiac Surgery. *Proceedings of the International Conference on Interdisciplinarity, 'No sense of Discipline'*. June 11–12, 2001, University of Queensland, Brisbane, Australia.
- Murero, M. & Nash, V. (2003). Internet community in Europe. In: Christensen, K. and Levinson, D. (Ed.) *Encyclopedia of Community: From the Village to the Virtual World*.
- Murero, M., D'Ancona, G., & Karamanoukian, H. (2001). Use of the internet in patients before and after cardiac surgery: an interdisciplinary study. *Journal of Medical Internet Research USA*. Res.
- Nguyen, L. T., Massman, N. J., Franzen, B. J., Ahrenholz, D. H., Sorensen, N. W., Mohr, W. J. III, & Solem, L. D. (2004). Telemedicine follow-up of burns: lessons learned from the first thousand visits. *Journal of Burn Care Rehabilitation* 25(6), 485–490.
- Ogan, K., Jacomides, L., Shulman, M. J., Roehrborn, C. G., Cadeddu, J. A., & Pearle, M. S. (2004). Virtual ureteroscopy predicts ureteroscopic proficiency of medical students on a cadaver. *Journal of Urology* 172(2), 667–671.
- Pande, R. U., Patel, Y., Powers, C. J., D'Ancona, G., & Karamanoukian, H. L. (2003). The telecommunication revolution in the medical field: present applications and future perspective. *Current Surgery* 60(6), 636–640.
- Pincock, S. (2004). Initiative to exchange cancer research information is launched. *British Medical Journal* 328, 728.
- Riva, G., Bacchetta, M., Cesa, G., Conti, S., & Molinari, E. (2002). E-health in eating disorders: virtual reality and telemedicine in assessment and treatment. *Studies in Health Technology and Informatics* 85, 402–408.
- Rizzo, A. A., Strickland, D., & Bouchard, S. (2004). The challenge of using virtual reality in telerehabilitation. *Telemedicine Journal and E Health* 10(2), 184–195.
- Rothbaum, B. O., Hodges, L. F., Kooper, R., Opdyke, D., Williford, J., & North, M. M. (1995). Effectiveness of computer-generated (virtual reality) graded exposure in the treatment of acrophobia. *American Journal of Psychiatry* 152(4), 626–628.
- Ruderich, F., Bauch, M., Haag, M., Heid, J., Leven, F. J., Singer, R., Geiss, H. K., Junger, J., & Tonshoff, B. (2004). CAMPUS—A flexible, interactive system for web-based, problem-based learning. *Health Care Medinfo*. 2004, 921–925.
- Samuel, M., Coombes, J. C., Miranda, J. J., Melvin, R., Joung, E. J., & Azarmina, P. (2004). Assessing computer skills in tanzania medical students: an elective experience. *BMC Public Health* 4(1), 37.
- Scherrer-Bannerman, A., Fofonoff, D., Minshall, D., Downie, S., Brown, M., Leslie, F., & McGowan, P. (2000). Web-based education and support for patients on the cardiac surgery waiting list. *Journal of Telemedicine and Telecare* (2), S72–S74.
- Semere, W., Karamanoukian, H. L., Levitt, M., Edwards, T., Murero, M., D'Ancona, G., Donias, H. W., & Glick, P. L. (2003a). A pediatric surgery study: parent usage of the Internet for medical information. *Journal of Pediatric Surgery* 38(4), 560–564.
- Semere, W. G., Edwards, T. M., Boyd, D., Barsoumian, R., Murero, M., Donias, H. W., & Karamanoukian, H. L. (2003b). The world wide web and robotic heart surgery. *Heart Surgery Forum* 6(6), E111–E119.

- Seymour, N. E., Gallagher, A. G., Roman, S. A., O'Brien, M. K., Bansal, V. K., Andersen, D. K., & Satava, R. M. (2002). Virtual reality training improves operating room performance: results of a randomized, double-blinded study. *Annals of Surgery* 236(4), 458–463.
- Taylor, H. (2002). The Harris Poll. Accessed on October, 2004. Available from: <http://www.harrisinteractive.com/news/allnewsbydate.asp?NewsID=464>.
- Torkington, J., Smith, S. G., Rees, B. I., & Darzi, A. (2001). Skill transfer from virtual reality to a real laparoscopic task. *Surgical Endoscopy* 15(10), 1076–1079.
- Vincelli, F., Choi, H., Molinari, E., Wiederhold, B. K., Bouchard, S., & Riva, G. (2002). Virtual reality assisted cognitive behavioral therapy for the treatment of panic disorders with agoraphobia. *Studies in Health Technology Informatics* 85, 552–559.
- Vozenilek, J., Huff, J. S., Reznick, M., & Gordon, J. A. (2004). See one, do one, teach one: advanced technology in medical education. *Academic Emergency Medicine* 11(11), 1149–1154.
- Wilson, B. G. (1995). Metaphors for instruction: why we talk about learning environments. *Educational Technology* 35(5), 25–30. Available at: <http://carbon.cudenver.edu/~bwilson/metaphor.html>.
- Wilson, B. G. (1996). *Constructivist Learning Environments: Case Studies in Instructional Design*. Englewood Cliffs, NJ: Educational Technology Publications.
- Winn, W. D. & Jackson, R. (1999). Fourteen propositions about educational uses of virtual reality. *Educational Technology* [H.W. Wilson—EDUC], 39(4), 5–14.
- Ziv, A., Wolpe, P. R., Small, S. D., & Glick, S. (2003). Simulation-based medical education: an ethical imperative. *Academic Medicine* 78, 783–788.

## Chapter 39: E-Democracy: Media-Liminal Space in the Era of Age Compression

MARK BALNAVES\*, LUCAS WALSH†, AND BRIAN SHOESMITH‡

*\*Professor of New Media, School of Communications and Multimedia, Edith Cowan University; †Research Fellow, Faculty of Arts, Deakin University; ‡Associate Professor, School of Communications and Multimedia, Edith Cowan University*

Whether direct internet democracy is good or bad is, however, quite beside the point. It is inevitable. It is coming and we had better make our peace with it. We have to better educate ourselves so that we can make good decisions. Restricting the power of the people is no longer a viable option. The internet made it obsolete.

(Morris, 2000: 31)

When Morris says that “direct democracy” is inevitable and “restricting the power of the people is no longer a viable option” he is arguing that traditional distances between representational governmental structures and the voter or citizen have changed because of the internet and that representative democracy will change as a result. The internet, however, is operating in a political and governmental climate where there is a “civic deficit” involving increased complexity of communication between citizens and increased citizen disengagement from the traditional processes of communication (Putnam, 2000). Consequently, the relationship between the democratic potential of the internet and the institutionalized axes of power that currently shape representative democracy need to be teased out. In an age of digital and interactive communication, there is a change in the way citizens collaborate. It is this change that challenges many of the preconceived ideas about the nature of contemporary democracy, hence the enthusiasm of Morris and his kind.

But we can take Morris’s point further. It is not simply the internet as a medium that is changing political relations but the learning environments that are made possible by the new media. Indeed, concepts like “ergodic media” and “electracy”—computer programmed environments that require users to make choices—have emerged to describe these environments, the new literacies required for those environments, as well as the potential changes to social and political relations (Aarseth, 1997; Weight, 2004). Thus we have a complex triangulation emerging where the medium, the learning environments in which citizens learn to use the medium and the actual uses to which the medium is put begin to shape our understanding of e-democracy. Once we go down this path, we see that a theory of e-democracy will not only include a mechanism of choosing and authorizing governments, but also describe a kind

of society, “a whole complex of relations between individuals” (Macpherson, 1973: 51).

In this chapter, the authors will look at the ideas of e-government and e-governance and practical examples of how new media are being used to enhance decision-making in democratic societies. The authors argue that the learning environments that have emerged from interactive entertainment and other contexts signal a change in the nature and role of liminality—the transition to citizen and civic engagement—in modern society.

#### 1. e-GOVERNMENT VERSUS e-GOVERNANCE

Definitional and conceptual issues in e-government have not gone unnoticed within the public sectors, national and international. The United Nations report on uptake of internet technology defined e-government as “utilizing the internet and the world-wide-web for delivering government information and services to citizens”. (United Nations Division for Public Economics and Public Administration American Society for Public Administration, 2002). The stages of e-government were then classified by levels of sophistication in adoption of the internet, including (i) “emerging” (an official government online presence is established); (ii) “enhanced” (government sites increase: information becomes more dynamic); (iii) “transactional” (users can actually pay for services and other transactions online); and (iv) “seamless” (full integration of e-services across administrative boundaries). The United Nations report then proceeded to create an e-government index, based on a mean figure derived from the web presence, telecommunications infrastructure, and human capital measures. Table 1 gives the ranking of leading countries based on that index.

Riley (2003: 14) goes a step further and distinguishes between e-government and e-governance. Riley (2003) draws on Kettl’s (2000) work on the historical analysis of American public administration, especially the idea of government as an institutional superstructure in society that translates politics into policy and legislation. Governance in this context is the result of communication between government, public service, and citizens in the whole cycle of policy development and service delivery. Riley’s model, above, sets up an initial framework for understanding the differences between e-government and e-governance (Table 2).

Riley (2003) argues that government and governance are both about getting the consent and co-operation of the governed. E-government is a formal apparatus for this objective, whereas e-governance is the “outcome as experienced by those on the receiving end”. e-Government, therefore, as superstructure, could clash with e-governance, as participatory process, especially when expectations of participation are heightened. Riley (2003) says that e-democracy/e-government/e-governance are a discipline in their own right

*Table 1. Global leaders in e-Government*

---

U.S.A.	3.11
Australia	2.60
New Zealand	2.59
Singapore	2.58
Norway	2.55
Canada	2.52
U.K.	2.52
Netherlands	2.51
Denmark	2.47
Germany	2.46
Sweden	2.45
Belgium	2.39
Finland	2.33
France	2.33
Republic of Korea	2.30
Spain	2.30
Israel	2.26
Brazil	2.24
Italy	2.21
Luxembourg	2.20
United Arab Emirates	2.17
Mexico	2.16
Ireland	2.16
Portugal	2.15
Austria	2.14
Kuwait	2.12
Japan	2.12
Malta	2.11
Iceland	2.10
Czech Republic	2.09
Argentina	2.09
Estonia	2.05
Bahrain	2.04
Uruguay	2.03
Chile	2.03
Lebanon	2.00

---

*Source:* Benchmarking E-government, A Global Perspective: Assessing the Progress of the UN Member States (2002).

because new media provide a distinct role in participation that was not available under other forms of representative government.

Riley's ideas on e-governance need to be broken down further. That is to say, the processes of participation need to be teased out. E-governance can involve e-government providing information to citizens, which is engagement and participation in an important but a superficial way. The UN benchmarking is a rating of e-government in this sense. However, activities in the area

Table 2. Differences between Government and Governance

Government	Governance
Superstructure	Functionality
Decisions	Processes
Rules	Goals
Roles	Performance
Implementation	Coordination
Outputs	Outcomes
e-Government	e-Governance
Electronic service delivery	Electronic consultation
Electronic workflow	Electronic controllership
Electronic voting	Electronic engagement
Electronic productivity	Networked societal guidance

Source: Riley (2003).

of “electronic governance” can range from government-led initiatives to improve transparency and participation to citizen-directed experiments in participatory democracy. Some of these experiments may be more traditional, like voting in local elections, but others may operate on the fringes, like e-activism or hacking. E-governance is the space where people will form their identities as active citizens and learn to mobilize resources for decision-making.

It is also worthwhile describing some of the activities that involve the mobilization of resources. First, there is the use of electronic media, such as email and databases, to enhance the administration of government and there is the use of media by government to disseminate information to citizens, corporate bodies, interest groups, and so forth in a one-directional, “top-down” fashion (administration and efficiency). Second, there is the use of technology such as the internet and interactive television to enhance citizen participation in government decision-making especially at the “grassroots” community level. Third, there is broadcast activity that encompasses the use of electronic media for the diffuse dissemination of information amongst citizens and government for general news and entertainment purposes. Finally, there is political mobilization and e-activism (together with “hacktivism”), where the internet and related technologies are used to mobilize public opinion in demonstrations against perceived government injustices or to disrupt networks for purposes of civil disobedience.

Once we think of e-governance as processes of consent in new media contexts that lead ultimately to policy and legislation, then we can better understand the tensions between superstructure, the elaborate mechanisms of government decision-making and service provision, and e-governance, the engagement of citizens and organizations in democratic decision-making. Before looking more closely at the different types of mobilization of resources

it is necessary to briefly examine the learning contexts that will affect e-democracy formations.

## 2. AGE COMPRESSION, NEW LITERACIES, AND THE TRANSITION TO CITIZENSHIP

Myths and rituals, in traditional and non-traditional societies, are often associated with “rites of passage” from one status to another. There is a separation (divestiture) phase, a transition (liminality) phase, and an incorporation (investiture) phase (Turner, 1995). During the separation phase, the person who is to be subjected to the passage becomes separated from their previous way of life. During the transition phase, the person separated from their previous environment experiences the liminal condition. During the incorporation phase, they enter a new group and a new life.

The ritual subjects pass through a period and an area of ambiguity, a sort of social limbo which has few . . . of the attributes of either the preceding or subsequent profane social statuses or cultural states.

(Turner 1982: 24)

Victor Turner, the anthropologist, coined the term “liminal”, from the Latin *limina* for “threshold”, to describe transitional phases where myths and rituals became important in confirming the identity of a person and their future role in society.

Myth treats of origins but derives from transitions . . . Myths relate how one state of affairs became another; how an unpeopled world became populated; how chaos became cosmos; how immortals became mortal; how the seasons came to replace climate without seasons . . . and so on. Myths are liminal phenomena: they are frequently told at a time or in a site that is ‘betwixt and between’.

(1968–1979: 576)

The idea of liminality is relevant to this chapter because we contend in modern societies, more than at any other time, learning and consensus building are taking place in a liminal condition created by modern media. Turner (1982) argued that traditional liminality did not exist in modern society and called the quasi-liminal states “liminoid”. Contemporary authors have also expanded on this notion in the context of computers and learning (Weight, 2004). The authors will call this liminal condition *media-liminal* space (Balnaves & Tomlinson-Baillie, 2005) because it more accurately reflects what is happening with digital media and the extensive many-media saturation. Turner is not alone in his idea that there are existential spaces in society that have properties conducive to creativity and *communitas* (the sense of community) but which



are problematic in relation to other structured spaces of social organization. Post-modern thinkers such as Foucault called these spaces *heterotopia* and Deleuze and Guattari territorialized, where differences could be played out that were not allowed in normal social routines. It is the games phenomenon in modern society that best exemplifies this produced subjectivity.

The age compression phenomenon, the disappearance of childhood, is an example of how the entertainment business is taking advantage of extended liminal states, or what the industry calls KGOY—Kids Grow Older Younger. KGOY works on the basis that modern media allow children to develop higher order cognitive skills faster and younger. Toys and other goods, normally created for older children, are now being sold to younger children on the basis that their higher order learning skills are more advanced than in past generations. The KGOY philosophy involves introducing the staggering 565 million urban population of 5–14-years old to the new media literacies as soon as possible so they can start playing games (McDougall & Chantry, 2004).

A small picture of children’s activities gives an insight into the extent of media involvement. Ninety-nine percent of modern children aged 5–14 years old say that television is their favorite activity, with most spending 22 hours every fortnight watching TV or videos. Seventy-one percent of all Australian children (5–14 years old) spend between 5 and 9 hours per fortnight playing electronic games and spend \$450 million on software, \$250 million on hardware, and \$300 million on peripherals (Australian Bureau of Statistics (ABS) Media Release #4901.0 Date: 30/01/04, Sunday Telegraph, 29/2/04, p. 32; <http://www.theesa.com/EF2003>).

Companies like Konami produced YuGiOh! as a many-media game and have explicitly designed their games in a way that takes advantage of the media saturation, myth and ritual symbol and, indeed, the idea of intrinsic motivation (which enhances the uptake of the new literacies required by digital media). In the first quarter of 2004, Konami sold 3.5 million copies of YuGiOh!

	<b>2004 Billion Yen</b>
YuGiOh! Card Games (Japan, Asia)	9.5
YuGiOh! Card Games (North America)	18.5
YuGiOh! Card Games (Europe)	3.5
Other Cards	0.5

When boys play Yu-Gi-Oh, they are temporarily removed from normal society, this is further reinforced by the episodic game play on the television show where the players go to the shadow realm to play. Hence boys are continuously imitating the show and playing in “the shadow realm” or a place totally devoid of normal rules and normal “life”. They are transforming themselves from the young and immature Yugi into Yu-Gi-Oh. Yu-Gi-Oh is not solely internet-based. It is a good example of an activity that has gone beyond

play and brings together the very characteristics of liminal space described by Turner and others (Czarniawska & Mazza, 2003).

Those like Calvert (2003) are currently exploring the link between digital entertainment media and intrinsic motivation and individual interest. According to Calvert (2003), the properties are (i) the capacity to allow control over the learning environment, (ii) responsiveness, and (iii) high production values. These properties in turn provide a context in which identity can be explored through personal involvement in content. Identity development through a character or superhero allows children to have a role model for social participation and develops their confidence to interact with peers. Interest appears to be an even more compelling way in which to discuss student learning than prior knowledge or content (Askill-Williams & Lawson, 2001: 386). Individual interest implies intrinsic motivation, intrinsic motivation leads to multisensory three-dimensional learning that leads to stronger learning outcomes for children. The intensive and extensive engagement of children in media related, or media-tied, activities are linked to improved learning outcomes.

The phenomenon of age compression—drawing children into media-liminal space at earlier and earlier ages—will have an effect on how people learn how to mobilize resources in a digital world. Interactive games, at one level, entertain and provide children with the opportunity to role-play and enhance their learning skills. However, at another level, the whole games phenomenon is successful because of its capacity to replicate a liminal-like space (much like the *ketai* lifestyle in Japan). Once we intersect the games phenomenon with citizenship, we start to get an insight into the future citizen. The media-liminal space does not lead to a defined role or status, but it does allow people to explore and create and work in peer environments. E-governance will include, therefore, the types of activities described below, but it will also include media-liminal spaces, many of which we see emerging not only in games but also in blogging and in the coming together of smartmobs.

In contrast to this informal education sphere that is essentially private in its scope, there is a vast formal education sphere that is struggling to come to terms with the media-liminal (Reed, 2000). By “formal education sphere”, we mean that vast apparatus, both private and public, that has been set in place to educate and socialize the young. Here, the liminal is either feared or discounted as it does not conform to the cognitively based curriculum that sees child development in terms of clearly defined steps and outcomes.

### 3. ADMINISTRATION AND EFFICIENCY

It would be safe to say that almost every democratic government is or has recently reviewed its use of electronic media, such as email and databases, to enhance its administrative function. This includes the use of electronic service delivery and electronic information infrastructures to

co-ordinate organizational activity, and daily government and parliamentary work (Grönlund, 2002; Gibson et al., 2004).

The increase in government information and services provided online during the last decade has been tremendous. For example, one United Nations report found that during 2001, there was a greater expansion in government online presence than the previous 5 years combined. It has been estimated that between 1996 and 2001, the number of official government homepages grew from less than 50 to well over 50,000 official government websites. Furthermore, the *nature* of the information developed from “website content and online applications progressed from static, public affairs ‘e-brochures’ to virtual information centers where the interaction between citizen users and the public sector is continuous” (ASPA & UNDPEPA, 2001: 5). For example, one U.K. e-government initiative launched in 2004 is *Directgov*, which seeks to offer citizens direct access to public information and services concerning topics such as employment, motoring, and people with disabilities (<http://ukonline.direct.gov.uk/>). This site sits within a broader initiative, U.K. Online, which was launched in September 2000. Other more locally oriented websites offer services in which citizens can transact with government (e.g., lodge their tax online) (Cross, 2004). A U.K. Government White Paper established five base line principles of e-government related to this type of activity:

- build services around citizens’ choices;
- make government and its services more accessible;
- facilitate social inclusion;
- provide information responsibly;
- use government resources effectively and efficiently (White Paper cited in ASPA & UNDPEPA, 2001: 6).

A 2001 survey of 22 countries or territories including Australia, Hong Kong, Ireland, Japan, Malaysia, New Zealand, and Britain found that Canada, Singapore, and the U.S.A. offered the most extensive online government initiatives seeking to provide services to citizens via the web (Saywell, 2001). But the motivations behind these e-governance initiatives are not always driven by the public interest. As one commentator remarks, a key problem with e-government is that “the web is seen primarily as a delivery mechanism for more accessible, efficient and cheaper-per-unit transactions between government producers and citizen consumers” (Hobsbawn, 2003).

#### 4. LEARNING ENVIRONMENTS AND PARTICIPATION

The most promising use of technology in e-governance is the use of electronic media, such as the internet and interactive television, to enhance citizen participation in government decision-making and “grassroots” development. This type of activity has extremes ranging from citizen polling and consultation

with government, to a more direct democratic model of participation based on the “electronic town meeting”, in which media such as televoting and the web are used for mass decision-making by plebiscite (Abramson et al., 1988).

Much of the recent activity using the internet to encourage citizen participation has taken a moderate approach to complement representative democracy, rather than replace it with a more direct participatory model of democracy. Brazil’s city council of Porto Alegre uses email and the web to facilitate a degree of direct democracy by enabling citizens to discuss and vote on issues (Hobsbawn, 2003). Minnesota E-Democracy also hosts online public spaces for citizen interaction on public issues (<http://www.e-democracy.org/>). This non-partisan citizen-based organization seeks to increase participation in elections and public discourse in Minnesota through the use of information networks. Through e-Citizen Estonia, citizens of Estonia can use an online consultation process to comment on draft laws and suggest new ones (<http://tom.riik.ee>) (ASPA & UNDPEPA, 2001: 71). The Netherlands’ Minister for e-Democracy matters has engaged discussion with the public through online chat rooms. In North Jutland, Denmark, a Democracy Project has attempted to counter low voter turn-out by using ICT to make regional decision-making process more understandable to its citizens ([www.nordpol.dk](http://www.nordpol.dk)). Similar and varied projects are also taking place in Australia. The New South Wales government sponsors the “Community Builders” network of policy implementation, in which an interactive electronic clearing house is used for community level social, economic, and environmental renewal ([www.communitybuilders.nsw.gov.au](http://www.communitybuilders.nsw.gov.au)). Using the web to enable online community consultation, e-petitions and to broadcast parliamentary activities, the Queensland Government established an e-Democracy Unit to explore how ICT can enhance the community’s access to government and its participation in government decision-making. The *Citizenscape* website of Western Australia also seeks to promote citizenship-related activities and involvement in decision-making ([www.citizenscape.wa.gov.au](http://www.citizenscape.wa.gov.au)). These projects have experienced varying levels of success in both disseminating resources from government to citizens as well as engaging greater citizen involvement in representative government (Parliament of Victoria, 2002: 57–63).

It is argued that the growth and convergence of the new telecommunication media will consolidate and extend the nature of participation by citizens in the formation of policy in desirable ways. For Grossman (1995), this trend towards direct democracy is inevitable; the important question for him is *how* this process will be managed.

## 5. BROADCASTING

Issues of the nature, ownership, and impact of mass media continue to be significant. Sweden has formally recognized the “problems with the

Swedish mass media in contributing to the public sphere by fulfilling the democratic indicator of enlightened understanding..." (Rothstein et al., 1995). The growth of the World Wide Web has generated further issues and possibilities. For example, unlike the present system of heavily centralized broadcast television, the web can decentralize political discourse and has the potential to give citizens greater choice and access to information.

The development and adoption of digital television has further implications for e-democracy because of its likely integration with other ICTs such as the internet. The convergence of ICT such as the internet with mass entertainment media, such as interactive television and radio, has been underway for some time and offers tremendous opportunities for civic engagement and greater interactions between government and citizen. For example, information services such as teletext are widely available through television. Popular radio stations simulcast on the web and provide transcription services of broadcast content. The widespread adoption of a database-driven approach to websites has enabled web-content to be more dynamic and relevant to specific user needs, by using mark-up language such as Extensible Mark-up Language (XML) to enable multichannel systems that deliver web-content to conventional PC browsers, interactive TVs, PDAs, and smart phones. Television and home-entertainment systems now come equipped with their own hard-drives, whose basic functioning is not all that dissimilar from those contained within a typical PC. As televisual, audio, and computing technologies converge, they facilitate greater interactivity and new opportunities for the dissemination of information.

Interactive television has been in popular use in countries such as the U.K. for some time now, ranging from spot-polling (e.g., Sky-digital) and popular entertainment, such as game shows. Indeed, the uptake of interactive television in countries such as the U.K. now exceeds that of the internet (Towler, 2001). Recently, trials have begun in the U.K. and U.S.A. involving the use of interactive television. In the U.K., for example, a trial group of voters were given a PIN number and the chance to take part in an e-voting pilot scheme via interactive digital television, the internet, telephone, and special kiosks (BBC News, 2003). In the U.S.A., the technology is now available to use digital TV to cast election ballots (Featherly, 2003). What is truly significant about this technological convergence is that it has as its corollary a convergence of information and entertainment, market, and polity.

All the above examples are based within the law. E-governance also has proponents who mobilize public opinion for civil disobedience or hack networks for what are perceived as public interest purposes. "Hacktivism" has led to a new form of activism, combining political activism with computer hacking.

## 6. MOBILIZATION AND HACKTIVISM

Civil disobedience was one of the first activist tools to be translated into an electronic context. The Electronic Disturbance Theater (EDT) is considered by many to be the first true “hacktivist” network. The EDT coined the term “electronic civil disobedience” and was the first to implement it as a “hacktivist” event (Pearson, 2000: 16). The EDT actively supports causes such as the Zapatista movement in Chiapas, Mexico, and its members were the creative and technical force behind actions such as SWARM. But it is important to grasp that the flow of information and technique has not been all one-way. Activists who have come from “real-life” protests are also adopting the tools and techniques of the hackers when working for a cause. Activists are finding that by coming online they expand not only the range of tools at their disposal, but also the ways they can connect with like-minded individuals and groups. “As a result, radical groups are discovering what hackers have always known: Traditional social institutions are more vulnerable in cyberspace than they are in the physical world. Likewise, some members of the famously sophomore hacker underground are finding motivation in causes other than ego gratification” (Harmon, 1998).

Table 3 highlights some prominent “hacktivist” targets, with notes on the issue and the tactics used by the “hacktivists” involved.

There is of course significant e-activism activity that is not illegal and does not constitute civil disobedience. Hacktivist activity, however, does raise e-governance issues as it is a subterranean attempt to influence policy and legislative outcomes. “Hacktivism” is not a shift of power to the citizenry, although like any protest or act of civil disobedience it can be seen as an exercise of rights within democracy. The extent to which that protest or disobedience contravenes formal laws and the extent to which the state will respond as a result of breach of those laws (positive rights) will continue to be a significant issue within the shaping of an e-governance of the future.

## CONCLUSION

Modern democracy has two faces: (i) e-government and e-governance as its critical participatory processes and (ii) the underlying social phenomenon of a generation that is immersed in the digital entertainment world where intrinsic interests are appealed to and where deep learning is occurring. Hacktivism is already an example where people are competent in the new literacies and the potential of collaborative and peer-based networks in influencing decisions. Media-liminal spaces—where individuals become immersed in these new learning environments—are not benign.

Table 3. Major hacktivist targets

Target(s)	International Issues/Tactics	Hacktivist(s)
Balkan press	Defaced Albanian, Croatian and Serbian websites relating to Kosovo	Kosovo Hackers Group/Black Hand/Serbian Angel
China	Government censorship. Removed content filters. Warn activists about imminent arrest. Defaced websites. Domain hijacking. Planted Trojan horses	Blondie Wong/Hong Kong blondes Bronc Buster and Zyklon/Legion of Underground
France	Anti-nuclear protest Denial of service attack	Strano network
India/U.S.A.	Independence for Indian-controlled Kashmir. Defaced Karachi stock exchange, U.S. military and commercial sites, including Disney	Dr Nukor/Pakistan Hackerz club/Muslim online Syndicate/GFORCE
India	Protest nuclear bomb testing. Defaced websites	Milworm and Ashtray Lumberjacks
Indonesia	Independence for East Timor. Alleged human rights abuses. Defaced websites	Secretos/Kaotik team
Mexico	Independence for Chiapas. Alleged human rights abuses. Denial of service attack using floodnet utility	Ricardo Dominguez/EDT
Myanmar	Political identity (Burma). Alleged human rights abuses. Defaced websites	Danny-Boy/X-ORG
NASA	Anti-nuclear protest. Computer virus or worm	Wank
Sri Lanka	Independent homeland for ethnic Tamils. Email bomb	Internet black tigers
World Trade Organization	Various agendas. Denial of service attacks	Electrohippies collective and many others

Critiques of the actual and potential impact of communication media on democratic processes are mixed (Abramson et al., 1988; Cronin, 1989). Grand visions of democratic revitalization through the use of information, communications, and interactive media continue to be tempered by scepticism and even derision. (In his humorous scenario of electronic democracy in the future, Anzovin (1992: 11) envisages daily televoting as a regular episode in the evening “infotainment line-up”.) Nevertheless, developments in communication technologies are profoundly affecting communication between governments and voters, lobbyists, and the use of opinion polling. Some argue that the use of electronic technologies should be restricted to the dissemination of

information and not actual voting activity. Citizens, it is argued, should still have to physically vote at a polling place (The Economist, 1995b).

Shifts of political power to the citizenry facilitated by technological development—both real and imagined—lead one commentator to wonder whether representative democracy is nothing more than a 200-year bridge from the direct democracy of ancient Greece to the teledemocracy of the future (The Economist, 1995a). While interesting as an idea, this notion pre-supposes that enabling greater participation will necessarily bring about *greater* participation. This is by no means guaranteed. And as e-democracy initiatives seek to enhance and extend governance, these activities face new but familiar challenges.

There is a real danger that much of the interest in using new media to enhance and extend democracy arises out of a desire for technological panaceas. But as commentator remarks, “One thing’s certain, though: e-government is as inevitable as the next generation of citizens who treat the free flow of digital information like oxygen. As Xerox innovator Alan Kay once noted: ‘Technology is only technology for people who were born before it was invented’ ” (Hobsbawn, 2003).

The authors in this chapter have explored “thin” democracy, e-government, and procedural issues like information-delivery, voting and administration, and “thick” democracy, participation of the citizen in the social and political world. It is the intersection of these two in the world of e-governance that will determine the nature of tomorrow’s citizen.

#### REFERENCES

- Aarseth, E. (1997). *Cybertext: Perspectives on Ergodic Literature*. Baltimore, MD: Johns Hopkins, UP.
- Abramson, J. B., Arterton, F. C., & Orren, G. R. (1988). *The Electronic Commonwealth: The Impact of New Media Technologies on Democratic Politics*. New York: Basic Books, Inc.
- Anzovin, S. (1992). Digital Democracy. *Compute* 14(11), 100.
- Askill-Williams, H. & Lawson, M. L. (2001). Mapping students’ perceptions of interesting class lessons. *Social Psychology of Education* 5, 127–147.
- ASPA & UNDPEPA (2001). Benchmarking e-government: a global perspective—assessing the progress of the UN member states. *Report by the American Society for Public Administration (ASPA) and the United Nations Division for Public Economics and Public Administration (UNDPEPA)*. Available at: <http://216.149.125.141/about/pdfs/BenchmarkingEgov.pdf>.
- Balnaves, M. & Tomlinson-Baillie, K. (2005). Yu-Gi-Oh: interactive games narratives in the era of compression learning conference 2005. *The Twelfth International Conference on Learning Faculty of Education*, University of Granada, 11–14 July.
- BBC News. (2003). Digital Voting to Fight Apathy, Monday, March 10. Available at: <http://news.bbc.co.uk/1/hi/england/2836637.stm>.
- Calvert, S. (2003). The children’s digital media center: the role of interactivity and identity in children’s learning. Paper presented at the *Association for German Speaking Developmental Psychologists*, Potsdam, Germany.



- Cronin, T. (1989). *Direct Democracy*. Cambridge, MA: Harvard University Press.
- Cross, M. (2004). Direct to Your Destination. *The Guardian*, Thursday March 4, 2004. Available at: <http://www.guardian.co.uk/online/story/0,3605,1161041,00.html>.
- Czarniawska, B. & Mazza, C. (2003). Consulting as a liminal space. *Human Relations* 56(3), 267–290.
- d’Aquino, N. (2000). The malaise of mobile phone manners. *Europe*, 41.
- Featherly, K. (2003). California Firm Prepares To Test Voting Via Digital TV. *Newsbytes*, November 29, 2001. Available at: <http://www.politicsonline.com/coverage/newsbytes2/>.
- Foucault, M. (1998). In: Faubion, J. (Ed.) *Aesthetics, Method, and Epistemology: Essential Works of Foucault 1954–1984*, Vol. 2. London: Allen Lane, The Penguin Press, 175–185.
- Gibson, R.K., Römmele, A., & Ward, S.J. (2004). *Electronic Democracy: Mobilisation, Organisation, and Participation via new ICTs*. London: Routledge.
- Government, U. (2002). *In the Service of Democracy: Your Response*. United Kingdom: Government of the United Kingdom.
- Government, C. F. C. (2003). *Crossing Boundaries*. Ontario, Canada: Centre for Collaborative Government.
- Grönlund, Å. (2002). *Electronic Government: Design, Applications, and Management*. Hershey, PA: Idea Group Publishing.
- Grossman, L. (1995). *The Electronic Republic*. New York, USA: Penguin.
- Harmon, A. (1998). Hacktivists of all persuasions take their struggle to the web. *New York Times Online*, October 31.
- Hobsbawn, A. (2003). Phone a Foreigner. *The Guardian*, Wednesday December 10. Available at: <http://society.guardian.co.uk/e-public/story/0,13927,1103283,00.html>.
- Kettl, D. F. (2000). The global public management revolution. *A Report on the Transformation of Governance*. Washington: Brookings Institution Press.
- Macpherson, C. B. (1973). *Democratic Theory: Essays In Retrieval*. Oxford: Clarendon Press.
- McDougall, J. & Chantry, D. (2004). The making of tomorrow’s consumer. *Young Consumers* 5(4).
- Morris, D. (2000). *Vote.com*. Los Angeles, California: Renaissance Books.
- Pearson, E. (2000). The digital is political: are today’s hackers, crackers and hacktivists leading the way to new forms of democracy? Unpublished Honours Thesis, Murdoch University.
- Putnam, R. (2000). *Bowling Alone*. New York, NY: Simon & Schuster.
- Reed, C. (2000). Education today. *Bulletin of Science, Technology & Society* 20(8).
- Riley, T. B. (2003). Defining e-government and e-governance: staying the course. *The Riley Report*, May.
- Rothstein, B., Esaiasson, P., Hermansson, J., Micheletti, M., & Petersson, O. (1995). *Democracy As Dialogue: The 1995 Report of the Democratic Audit of Sweden*, Center for Business and Policy Studies, Stockholm, Sweden. Available at: [http://www.sns.se/sns/forskn/pol\\_sys/demokrat/eng/dialog.htm](http://www.sns.se/sns/forskn/pol_sys/demokrat/eng/dialog.htm).
- Saywell, T. (2001). Electronic Bureaucracy: governments in Asia are waking up to the importance of offering their citizens services on-line. *Focus: Telecoms: E-Government*, Issue cover-dated June 21. Available at (United Nations Online Network in Administration and Finance website): <http://unpan1.un.org/intradoc/groups/public/documents/apcity/unpan001663.pdf>.
- The Economist. (1995a). E-lectioneering. *The Economist* (June 17) 335(7919), 21–23.
- The Economist. (1995b). The future of democracy. *The Economist* (June 17) 1995, 335(7919), 13–14.
- Towler, R. (2001). *The Public View 2001*. London, U.K.: Independent Television Commission.
- Parliament of Victoria (2004). *Inquiry into Electronic Democracy, Scrutiny of Acts and Regulations Committee Discussion Paper*. Melbourne: State of Victoria.

- Turner, V. (1982). *From Ritual to Theatre: the Human Seriousness at Play*. New York: Performing Arts Journal.
- Turner, V. (1995). *The Ritual Process: Structure and Anti-Structure*. NY: Aldine de Gruyter (originally published in 1969).
- United Nations Division for Public Economics and Public Administration American Society for Public Administration (2002). *Benchmarking E-government, A Global Perspective: Assessing the Progress of the UN Member States*.
- Weight, J. (2004). Cyborg dreams: from ergodics to electracy. *On the Horizon* 12(1), 36–40.

## Chapter 40: SonicMemorial.org—The Virtual Memorial as a Vehicle for Rethinking Virtual Learning Environments

MARK SHEPARD

*University at Buffalo, State University of New York*

### 1. THE SONIC MEMORIAL PROJECT

Shortly after September 11, 2001, a group of radio producers, artists, historians, archivists, and the public broadcasting community came together to collect and preserve audio artifacts of the World Trade Center, its neighborhood and the events of 9/11. Lost & Found Sound and National Public Radio (NPR) set up a toll-free phone line to record people's stories and collect audio contributions reflecting the life of the buildings before, during, and after the attacks.

The initial response was overwhelming. People from around the world were contributing a wide range of material: Voicemail messages from those who worked in the towers that day, tapes of weddings atop the World Trade Center, police and fire radio communications immediately following the attack, recordings of the buildings' elevators and revolving doors produced for a documentary film, home videos made by a lawyer in his 42nd floor office, sounds of the Hudson river front, recordings of late night Spanish radio drifting through the halls as Latino workers clean the offices, an interview with the piano player at Windows on the World, and so on.

Toward the end of that year, a series of meetings were convened in New York to discuss ways by which this material could be re-introduced to a broader public. Lost & Found Sound was already working on a series of radio programs to be aired on National Public Radio, but wanted to open the project up to other modes of distribution and access. Among the many ideas put forward, the idea of creating a website by which the public could access and contribute to an archive of these sound artifacts gained early support. The website offered an alternative to the linearity of a radio program, and provided an opportunity for a nuanced, meditative, non-linear experience as visitors browsed through sounds that piqued their interests.

SonicMemorial.org (<http://www.sonicmemorial.org>)—produced through the collaborative efforts of New York-based new media architects dotsperinch and web documentary studio Picture Projects—was conceived as a vehicle for mobilizing a number of the project's aspirations. First and foremost was its role in cultivating an oral history of the lives and activities of the buildings' inhabitants to assist in the interpretation and the understanding of a tragic

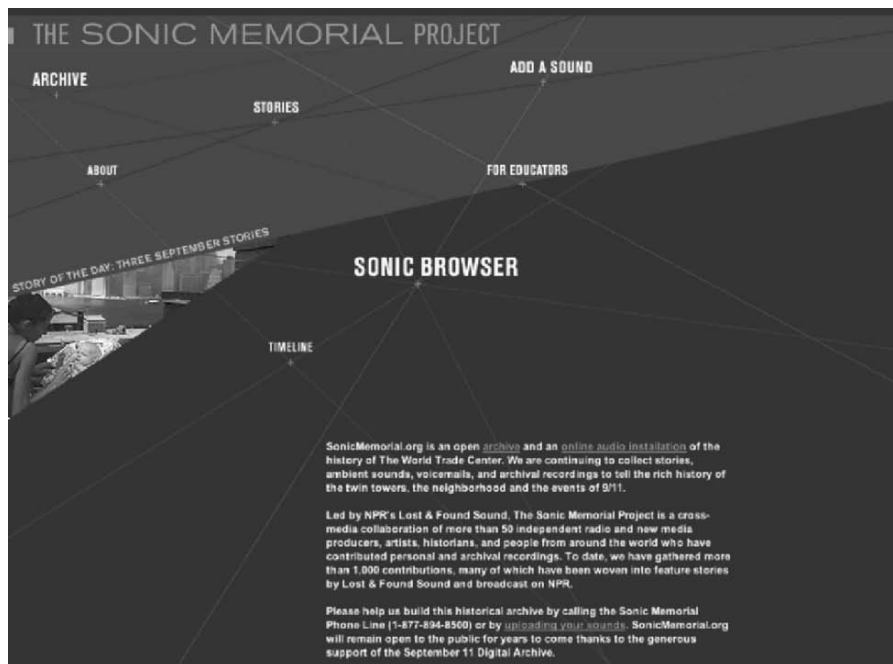

Figure 1. SonicMemorial.org, home screen.

historic event. This was to be an open, participatory project where the public would be invited to continue to build the archive by contributing sounds and stories online *via* a web-based interface. Further, the vast amount of material already collected needed to be cataloged, indexed, and preserved for future generations of visitors to the website, radio producers seeking material for future productions, researchers and historians interested in oral histories, and artists seeking to make creative use of the material for independent projects. Finally, the website was to be a memorial—a place of remembrance, commemorating the life of the World Trade Center as it existed before, during, and after 9/11 (Figure 1).

The website produced consists of two distinct interface modes by which this archive is accessed by the public. The first was designed to support traditional methods of searching an archive, and displays a list of descriptions of sound files based on keywords or themes input by the visitor. From this list, the visitor can select and listen to a specific sound and view images associated with it. This interface mode was designed for people seeking to locate specific sound files efficiently, such as radio producers seeking material for future productions, researchers and historians interested in oral histories, as well as the general public interested in specific material (Figure 2).

The second interface is the Sonic Browser. With the Sonic Browser, the visitor is presented with a more meditative space—one where sound itself

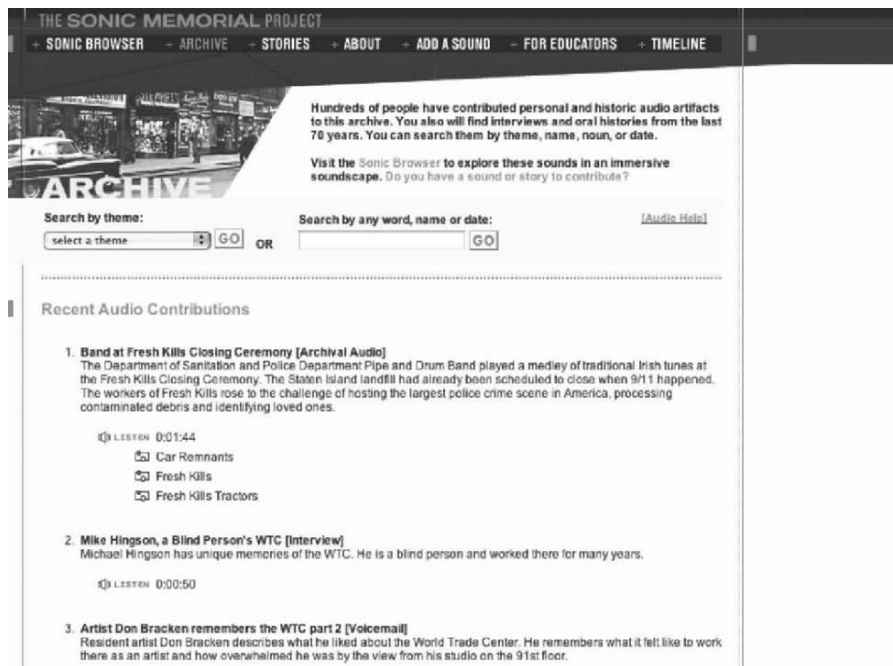

Figure 2. SonicMemorial.org, archive interface.

becomes a compass by which the archive is explored and navigated. Upon entering the Browser, the visitor is presented with a minimal space containing a series of vertical lines drifting across the screen. The lines appear from one side of the screen and disappear off the other, implying an extension of the space beyond the frame of the window. Visitors can pan this frame left or right to explore sounds outside the initial view. As one moves the mouse over one of these lines, the line twitches slightly and a title appears identifying a specific sound file. Upon selecting the line, the sound begins to play, and the line transforms into a dynamic animation reflecting a sound wave with a set of keywords appearing to its side. By selecting one of these keywords, visitors are subsequently able to “gather” sounds related to the one they are listening to, and further navigate the archive based on their specific interests (Figure 3).

The website also provides a simple form that enables anyone to contribute sound artifacts or stories online *via* a standard web browser. Additionally, contributors are able to add descriptive annotations, photographs, graphics, transcripts, or other documents they want to include with their sound. These materials are uploaded directly to the server and are subsequently available to visitors to the archive. That this memorial was to be constructed primarily of sound artifacts, coupled with the fact that these artifacts were to be contributed by a distributed public *via* the internet, offered an opportunity to

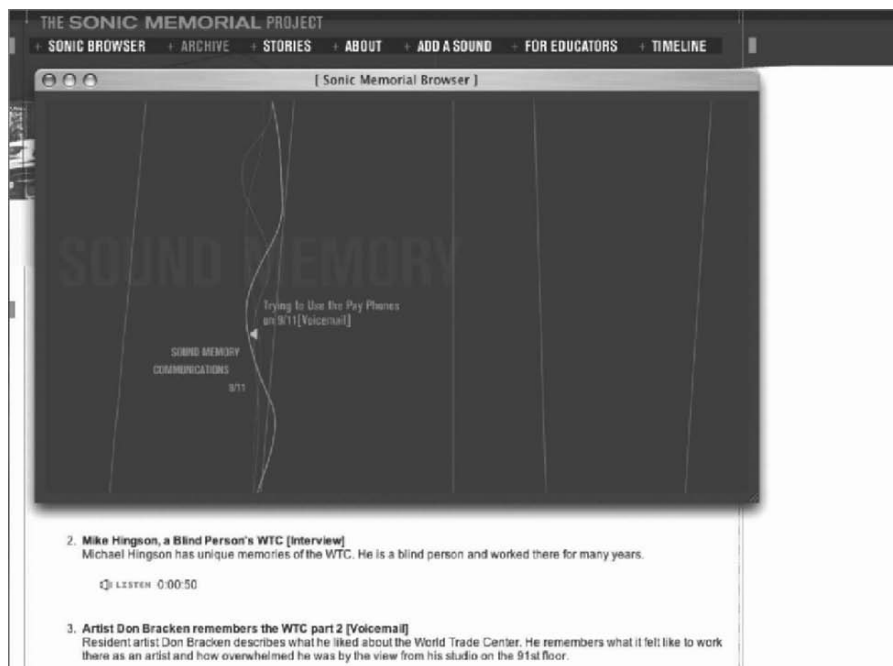

Figure 3. SonicMemorial.org, browser interface.

rethink conventions of memorial making within the context of virtual environments. In the process, notions regarding both what constitutes a “memorial” as well as what has come to signify the “virtual” were revisited in light how each potentially re-informs the other. In the following pages, I consider how SonicMemorial.org, through its use of sound and embrace of public participation, refigures conventional notions of the memorial as stable and timeless and of the virtual as ephemeral and temporal. I begin by reviewing traditions of memorial making and concurrent critiques of monumentality that have been developed by artists, architects, and cultural historians throughout the 20th century. This provides a critical context for a subsequent discussion of SonicMemorial.org with regard to the ways in which traditional notions of memorial making are destabilized through the use of sound artifacts and participatory structures enabled by network technologies. Finally, I explore the implications of these strategies for broader questions concerning of the design of virtual learning environments (VLEs).

## 2. MEMORIAL MAKING AND THE CRITIQUE OF MONUMENTALITY

Traditionally, memorials have consisted of a physical edifice that is built of stone, often classically adorned, fixed, and timeless. Their role in the physical world is commonly understood as that of both landmark and portal to a person

or event that is no longer present, one that we wish to remember for generations to come. In this sense, memorials are a special kind of monument. They serve as vehicles by which someone or something lost is rendered “present” through interplay between the mental processes of memory and imagination, and the physical architecture and artifacts that constitute the memorial construct. These memorials traditionally operate as redemptory sites of mourning and national instruction. They dispense an “official history” for the consumption by the public at large. Nowhere is this more evident than in the memorials built to commemorate wars or public figures. Here, the narrative embedded in the articulation of form, space, and material aspires to summarize the meaning of the person or event in an authoritative manner, once, and for all.

For example, consider the recent construction of the World War II Memorial in Washington D.C. Almost 60 years after the war had ended, and after more than 15 years after the idea was first proposed in Congress, the memorial was unveiled to the public on Memorial Day, May 31, 2004. The memorial’s neoclassical arcades and central open plaza, constructed of various kinds of granite, were designed to commemorate those who served in the war—“the greatest generation”, heroes all, who fought the “last great war”. And though that war has sparked controversy over Japanese American internment camps, the use of the atomic bomb, the firebombing of Dresden, none of this is reflected or even hinted at in the memorial’s design and construction. “World War II is, in a sense, a glorious war—a triumph of democracy over totalitarianism”, stated Friedrich St. Florian, the memorial’s architect, in 2000 (Kennicott, 2004). Yet viewed in the context of a country presently embroiled in not one, but two wars of highly questionable pretext, it becomes difficult not to read the memorial’s use of arches, for example—outside the vernacular of a properly American memorial architecture—as suggesting the whiff of something Roman, something imperial, something more to do with military conquest than liberation. “The World War II Memorial”, writes Hebert Muschamp, architecture critic for the *New York Times*, “can be seen as a monument to the military-entertainment industry complex, our new enforcers of the global Pax American Pop Culture” (Muschamp, 2001).

The critique of the desire to “set history in stone”, and thereby produce an official narrative for mass consumption, is by no means new. Along with other forms of cultural production in the 20th century, the process of memorial making and the form of public monuments have undergone radical transformations, reflecting both the political and the esthetic revolutions of the times as well as a broader crisis within representational practices following the century’s major wars and conflicts. As James Young (2000) notes, one can trace a transformation in the monument from the heroic, self-aggrandizing figurative icons of the late 19th century celebrating national ideas and triumphs, to the anti-heroic, self-effacing, conceptually driven constructs that mark the national ambivalence and uncertainty of the late 20th century.

In his chapter “Memory, Countermemory, and the End of the Monument”, Young sketches an historical overview of critical responses to the concept and institution of the monument, of which I will briefly summarize here. “Away with the monuments!” declared Friedrich Nietzsche, calling for an end to the “monumental history” of 19th Century German Historicism that “oppressed the living with stultified versions of the past”. This call to arms was further developed throughout the 20th century, primarily through the voices of artists, architects, and cultural theorists associated with modern movements in art and architecture. “The notion of a modern monument is veritably a contradiction in terms”, wrote Lewis Mumford in the 1930s. “If it is a monument it is not modern, and if it is modern, it cannot be a monument”. In articulating a common thread in modern architecture that privileged change and transformation over the illusion of permanence, he writes, “Stone gives a false sense of continuity, a deceptive assurance of life”. He goes on to suggest that often it is the least effectual regimes that choose to shroud their ineptitude in self-aggrandizing stone and mortar.

The words “set in stone” suggest that an idea, or a fact, has been placed in its ultimate form, beyond emendation and, often, beyond debate or contradiction. Yet to the extent that public monuments are inevitably constructed in particular times and places, contingent on the political, historical, and esthetic realities of the moment, the very idea that monuments can themselves preserve the memory of a person, place, or event for eternity is in itself a contradiction. Often, as the German historian Martin Broszat points out, monuments do not so much preserve memory as bury it beneath the layers of national myth and explanation that make up the “official history” the monument is designed to narrate. Art historian Rosalind Kraus goes further in suggesting that the modern period produces monuments that are unable to refer to anything beyond themselves as pure marker or base. Explicitly self-referential, the modern monument is thus rendered incapable of referring to events outside itself, and is “left motioning endlessly to its own gestures to the past”.

Others have argued that rather than preserving public memory, monuments displace it altogether by supplanting a community’s memory-work with its own material form. Pierre Nora writes, “The less memory is experienced from the inside, the more it exists through its scaffolding and outward signs” (Nora, 1989: 13). One might say that to the extent that we encourage monuments to do our memory-work for us, we become that much more forgetful. Here, it is the very act of remembering someone or something—understood as a form of interplay between a physical edifice, personal memory, and an active imagination—that is considered important to preserve.

Of the number of “counter-monuments” that this critique has produced, perhaps the most influential is that of Daniel Libeskind’s winning competition entry for the Berlin Jewish Museum Extension. Faced with the daunting challenge of “giving voice to an absent Jewish Culture without attempting to speak for it”, as called for in the competition brief, Libeskind focused on



reifying this absence in the design of the building itself. “The new extension is conceived as an emblem where the not visible has made itself apparent as a void, an invisible . . . The idea is very simple: to build the museum around a void that runs through it, a void that is to be experienced by the public.” (Libeskind, 1991: 63). This “void” consists of a straight linear slot that is cut through a bent and meandering bar that contains the building’s programmatic spaces. As one moves throughout the twisted and zigzagging building, one repeatedly encounters this discontinuous void—empty and unusable—that in its form and articulation, becomes the primary element around which the building is organized.

### 3. SONICMEMORIAL.ORG

SonicMemorial.org builds on elements of this critique by positing a memorial that is constructed primarily of sound artifacts contributed by a distributed public *via* the internet. From the start, the design team was interested in the ability of sound to create for the listener an aural “presence” that in face of such a monumental visual “absence” in lower Manhattan where the towers once stood, provided a way to sustain identification with a place and the people who occupied it that directly involved personal engagement. The idea of a distributed public body engaged in the memorial’s construction offered new ways by which the process of remembering, interpreting, and understanding could remain the domain of the people for whom the memorial is created, and not a product of an “official history” to be consumed en-mass by the public at large. Bergson, in investigating relations between matter and memory, describes the process of recollection as a movement from the virtual to the actual:

“Whenever we are trying to recover a recollection, to call up some period of our history, we become conscious of an act *sui generis* by which we detach ourselves from the present in order to replace ourselves, first, in the past in general, then, in a certain region of the past—a work of adjustment, like the focusing of a camera. But our recollection remains virtual; we simply prepare ourselves for receiving it by adopting the appropriate attitude. Little by little it comes into view like a condensing cloud; from the virtual state it passes to the actual; and as its outlines become more distinct and its surface takes on color, it tends to imitate perception.”

(Bergson, 1988: 133)

The perception and interpretation of sound requires the active participation of a listener. It is one thing to hear a sound, quite another to listen to it. Listening requires focusing attention on what is heard. Hearing is simply the act of perceiving sound through the stimulation of auditory nerves in the ear by sound

waves. Sounds have the capacity to create a sense of “presence” for an active listener—the ambient sound of a public plaza, for example, provides us with the sonic material from which we can imagine the space itself. Through listening to recorded or remote telephonic sounds, we are able to transport ourselves to places we may have never been. This “virtual” presence is the product of an interplay between the sound fragment on one hand, and the memory and imagination of the listener on the other. SonicMemorial.org is constructed from recordings that document aspects of the people and spaces of the World Trade Center. In the absence of the physical structures, these recordings exist as a particular kind of evidence of the buildings’ spaces and the lives of the people who occupied them—simultaneously lost & found sounds, partial and fragmentary. From these fragments, the buildings and the people who occupied them are continually reconstructed through the active participation of an imaginative listener. It is in this sense that the memory-work critical to the process remembrance resides within the person’s participatory relationship to the memorial, not within the memorial itself. The result is a memorial to a place that is sustained through the memory-work of those engaging it, and not through the consumption of an official narrative “set in stone” for all time. This participatory structure was further extended by opening up the process of contributing sound artifacts to anyone—not only people from New York wanting to contribute their answering machine tapes from that day, but also people living in remote parts of the world who composed, for instance, a song or poem from their memories from visiting the place years ago. This not only ensured that the “narrative” of the memorial was not the product of an individual or “official” group of people, but also provided for the collection of sounds to be constantly evolving. The idea was that at no single point in time would one be able to experience the memorial as a complete whole with a definitive story to tell. Rather, it would be the potential limitlessness of the memorial itself that would maintain the act of remembering in the present tense, and tie it to ongoing acts of contribution and discovery.

#### 4. RETHINKING THE VIRTUAL LEARNING ENVIRONMENT

Currently, most VLEs are designed to augment traditional classroom-based learning by extending this learning model to students participating remotely *via* the internet. VLEs commonly provide controlled access to individual curriculum modules, communications systems such as bulletin boards, instant messaging, and e-mail, as well as a suite of administrative features for managing, tracking, and assessing students. Yet while these environments may facilitate distance learning through the use of electronic network technologies, and are quite adept at automating accountability and related control structures within learning institutions, I would argue that they ultimately fail to consider

some very basic opportunities for the design of learning environments that the “virtual” affords. Bergson articulates the process of recollection as a movement from the virtual to the actual, as an action akin to focusing a camera, imitating perception. Audio artifacts imply an active listener, a participant in the production of a virtual presence. Perhaps the most promising thread for exploring the opportunities latent in the virtual *vis-à-vis* learning environments is that of rethinking existing learning models with respect to what the virtual affords—beyond the mere facility provided by electronic networks.

To do so, we need to consider the VLE in the context of a broader set of informal modes of learning such as visiting a museum, watching a documentary film on television, participating in a reading group, or checking out books from a library. These informal learning environments (ILEs) offer people opportunities for lifelong learning that extend beyond the purview of the classroom or workplace. As Falk and Dierking note, the most common form of lifelong learning is what they call “free-choice learning” (Falk & Dierking, 2000). Free-choice learning is the type of learning guided by a person’s needs and interests—learning people engage in throughout their lives to find out more about what is useful, compelling, or simply interesting to them.

The Contextual Model of Learning (Falk & Dierking, 2000) grew out of a framework that John H. Falk and Lynn D. Dierking developed (Falk & Dierking, 1992) after tracking thousands of people throughout their visits to museums, observing them in specific exhibitions, and conducting innumerable interviews (Falk & Dierking, 1992; 2000). This model suggests that three overlapping contexts—the personal context, the sociocultural context, and the physical context—contribute to and influence the interactions and experiences that people have when engaging in free-choice learning activities. Thus, the experience, and any free-choice learning that results, is influenced by the interactions between these three contexts.

The personal context involves an individual’s motivations and expectations, interest, prior knowledge, and experience, and is greatly influenced by an individual’s choice and control over what, how, when, and with whom they learn. The sociocultural context acknowledges that learning happens within sociocultural groups, is facilitated through mediation by others, and influenced by all of the cultural overlays of what learning means in a society, who engages in it, and what institutions participate. The physical context addresses the importance of advance preparation in orienting learners to the environment and its expectations, the setting and design of this environment, and subsequent reinforcing events and experiences that over time reinforce the accumulation of understanding. Simply stated, this model suggests that (1) learning begins with the individual, (2) learning involves others, and (3) learning takes place somewhere.

The following design strategies are offered as sketches toward rethinking the VLE in terms of the potential of the virtual in the development of new

forms of learning environments. In doing so, the aim is less to provide a formal set of guidelines than to map out preliminary waypoints for further investigation. Ultimately, the design of a VLE provides an opportunity not only to rethink existing learning models but also offers a vehicle by which the ways and means by which we learn can be explored and evaluated.

#### **4.1. Create a Distinct Space/Place**

Each structure, virtual, or physical, requires an architecture that defines its relationship to itself, its surroundings, and the space it both occupies and displaces. This architecture carries with it protocols by which we locate, orient, navigate, communicate, and interact with others within the environment. In creating an information architecture, one creates a set of relationships that we “learn” through the way they locate, orient, and position us, both in relation to the information at hand as well as to others taking part.

#### **4.2. Let the Learner Drive**

Often we learn best when we are in control of what, how, when, and with whom we learn. Enabling a learner to choose the pace, depth of information, and degree of interaction/feedback of the experience is critical in providing an environment conducive to a range of learning styles and preferences. Intrinsically motivated learners tend to be more successful learners than those who learn because they feel they have to.

#### **4.3. Offer Multiple Points of Entry**

By providing multiple points of entry into a particular subject, one enables the learner to enter into a learning situation along paths specific to his or her interest, familiarity, and need. Learning environments offering a variety of ways by which information is accessed are more effective in engaging the unique needs of a diverse group of learners.

#### **4.4. Engage the Learner As a Participant**

Cast the learner in an active role *vis-à-vis* the learning environment. Involve the learner not only in contributing material to the environment but also in making meaning from it. Participatory structures not only help learners establish a personal connection to the material, but also a means by which to share that connection with others.

#### 4.5. Foster Social Collaboration

Support and facilitate social interaction and exchange within the environment. Peers build social bonds through shared experiences and knowledge. Social groups often utilize each other as vehicles for deciphering information, for reinforcing shared beliefs, for making meaning. Such settings create unique milieus for collaborative learning to occur.

#### REFERENCES

- Bergson, H. (1988). *Matter and Memory*, Paul, N. M. and Palmer, W. S. (Trans.). New York: Zone Books (Original work published 1896).
- Falk, J. H. & Dierking, L. D. (1992). *The Museum Experience*. Washington, D.C.: Whalesback Books.
- Falk, J. H. & Dierking, L. D. (2000). *Learning from Museums: Visitor Experiences and the Making of Meaning*. Oxford: Altimira Press.
- Kennicott, P. (May 30, 2004). Memorials set history in stone, and make us ask what we want to remember. Is that why we don't always embrace them? *The Washington Post*, B01.
- Libeskind, D. (1991). *Between the Lines: Extension to the Berlin Museum with the Jewish Museum*. Amsterdam: Joods Historisch Museum.
- Muschamp, H. (June 7, 2001). An appraisal; new war memorial is shrine to sentiment. *The New York Times*, 1.
- Nora, P. (1989). Between memory and history: Les Lieux de Mémoire. *Representations* 26 (Spring), 13–25.
- Young, J. (2000). *At Memory's Edge: After-Images of the Holocaust in Contemporary Art and Architecture*. New Haven and London: Yale University Press.

# Chapter 41: “Why don’t We Trade Places . . .”: Some Issues Relevant for the Analysis of Diasporic Web Communities as Learning Spaces

VERA NINCIC

*OISE, University of Toronto*

## 1. INTRODUCTION

Understanding the learning process as an aspect of the participation in various communities of practice (Lave, 1996; Lave & Wenger, 1991) helped educational researchers to explore learning contexts beyond school-based environments. In that sense, the participation in diasporic web communities could be interpreted as a particular learning experience: by participating in diasporic online spaces dispersed people learn and re-learn what it means to be an immigrant, how to understand and interpret immigrant experience, or imagine a relationship between the homeland and hostland. The identity-changing nature of online participation warrants a close analysis of web communities, which, along with other online/offline environments, could be involved in the construction of immigrant experience. For this reason, web communities, produced by socio-economic, cultural and migration flows, and mediated by the development of internet technologies, should attract attention of educational researchers. However, there is a need to address various issues that emerge in the way we are approaching the issue and conceptualize such a communities.

While the problematization of discourses advocating the transformative potential of web communities has been prevalent in the recent literature, the discourses of political and cultural promises and troubles of diasporic online networking are still being relatively unchallenged. Popular images of diasporic web communities as spontaneous and natural, and “an obvious goldmine” of the Net need to be problematized, as Jones (2002) points out, since they presume the deterministic nature of ethnic ties, allowing us to forget that “communities are very much constructed no matter how organic they may seem” (p. 371).

Discussing diasporic practices in online spaces requires a difficult balancing act among a variety of discourses that surround cyberspace, diaspora-related themes, and their particular configurations (Shohat, 1999). On the one side, it would be necessary to take a critical stance toward celebratory discourses that understand the promises of diasporic uses of computer technologies only in terms of their potential to weaken further the power of nation-states and

political borders, as well as the gradual dissolving of the place-bound identities. With such an approach, one tends to overlook both the material effects of the power of nation-state and the situated nature of diasporic online practices. As Shohat (1999) suggests, such discourses disregard “the ways in which material geography and history shape complex production, consumption, and usage of technology” (p. 219). On the other side, we need a critical stance toward overtly pessimistic discourses that understand diasporic online practices as completely entrenched in homeland nostalgia, and, as such, easily susceptible to commodification by homeland-based economic or political interests. Both approaches might disregard diverse, changeable, and context-dependent online practices, and the heterogeneous composition of diasporic web communities.

Several themes explored in this chapter aim to contribute to the discussions that problematize assumptions about diasporic groups and their online practices present in popular discourses and academic writings. For example, a diasporic web community has been frequently understood as a more or less spontaneous product based on ties that tend to produce and maintain the nostalgia-based relationships toward the imagined or real homeland. Framed this way, all diasporic online practices are seen being similar in nature and oriented toward virtual remake of the left or lost homeland. By re-thinking the concept of diaspora in terms of the heterogeneous nature of immigrant social networks and the diversity of uses of diasporic spaces, as well as by challenging the assumed sameness of diasporic experience, it could be possible to understand not only the diasporic online practices as situated, context-dependent and changeable, but also the meaning of the “homeland” as contesting and shifting.

Moreover, certain academic texts focused on the appropriation of computer technologies by “ethnic” groups tend to raise the issue of hegemonic nature of internet-based technologies in terms of being an obstacle to the “cultural expression” of ethnic groups. Such a standpoint assumes that online technologies, by being a product of a particular culture (American, Western, or English-speaking one), possibly hinder the “expression” of local, cultural, and linguistic practices. While such a stance is careful to take into account the political and cultural implications of computer technologies, it simultaneously reproduces the split between Western and “other” cultures by promoting the idea of some distant, exotic, and unspoiled-by-technology “ethnic” culture in need to be “expressed” in a particular way. By looking at the process of the production of diasporic online spaces, it should be possible to problematize such a separation of technology from diasporic practices by understanding them as mutually dependent and co-shaping.

The discussion about above-mentioned assumptions of diasporic online networking—spontaneous production of diasporic online spaces and homogeneity of diaspora, as well as the separation of technologies from diasporic practices, might help us conceive diasporic web communities in more balancing terms. Using the case of a Serbian web community—an online,

non-English speaking network of both Serbian (and ex-Yugoslavian) immigrants and Serbians currently living in the homeland(s)<sup>1</sup>, I aim to present a more complex picture of an ethnic online group, its online practices, and its communal online space. At the same time, by discussing the situated nature of a diasporic web community, I hope to be able to argue the importance of such communities for the educational researchers interested in diverse sites implicated in the identity-changing learning experiences.

## 2. THE PRODUCTION OF WEB COMMUNITIES: THE CASE OF A SERBIAN WEB COMMUNITY

The Serbian diasporic web community, a relatively stable and highly populated website of Serbian-speaking immigrants, will celebrate nine years of its existence in the Fall of 2005. This “ethnic” web portal, with the servers physically located in Toronto, Canada, is completely presented in the Serbian language. Web-based statistics (Alexa.com) suggests that this particular site represents one of the most visited websites for Serbian diaspora and Serbian speakers in general. That means that despite the site’s major focus on an immigrant audience, it has an appeal to people living in the homeland(s). While we should be skeptical about traffic statistics based on online “hits” to particular sites published by the web companies that generate results for particular purposes, the available statistic, however, suggests certain tendencies. The Serbian diasporic web community, as the results suggest, is a highly visited web location among Serbian speakers with growing number of users every year.

Similar to many diasporic websites this one offers the predictable web content that should appeal to Serbian immigrants: daily updated homeland’s news, business advertizements of goods for immigrant market (homeland’s food products, air tickets, videos/CDs), and web links to news agencies, newspapers, radio, and television programs available online in the Serbian language. Beside the “standard” diasporic offerings, the site is hosting over 50 discussion boards and several chat rooms that support contact and communication in the Serbian language, as well as the web search engine that searches through the “Serbian-only” websites in both diaspora and the homeland.

A casual visit does not reveal much about the site’s authorship. It is hard to find any reference about the people who produce and maintain the site, or about the geographical location of the servers that materially support the entrance of the portal page. A detailed search reveals that all advertizements on the home page belong to Toronto-based companies selling their products to the local immigrant market, and that the site has been developed and operated by a company located in Toronto. It could be assumed that there is a certain profitability of the site (the Toronto immigrant market obviously pays well for homeland-imported products) because it has operated relatively smoothly for years. It has not changed its web location or interrupted its service despite a



huge influx of visitors in certain circumstances. For example, an increase in online participation during the Kosovo crisis in 1999 did not interrupt website operation. Rather, it had put this web portal among the thousand of most visited websites in the world for that year. The stability of this web location could be assumed by the site's ability to progressively accommodate increased numbers of visitors year by year.

I mention the importance of the Kosovo crisis because this tragic offline event had helped in establishing the site's visibility and its influence among virtual Serbian diaspora. It seems almost trivial to say that the important events happening in the homeland tend to mobilize diaspora in particular ways. Homeland's wars and violence, in particular, heighten attention of those who emigrated (Kolar-Panov, 1997). The existence of web technologies that offer 24/7 monitoring of the homeland's events through message exchange, allow us to assume that immigrants with a computer access could frequently use those technologies, if for nothing else, then to fill in the lack of information left by "transnational storytellers" such as CNN, BBC, and others (Shohat, 1999).

In some cases, it is not coincidental that internet-based technologies are readily chosen for diasporic participation. For immigrants coming from the territories of Former Yugoslavia (among them are Serbian-speaking migrants), especially those belonging to the migrant waves that followed the Balkan's wars in 1990s, online communication might be of particular significance. According to Stubbs (1998), "[t]he wars of the Yugoslav succession from 1991 are, perhaps, the first 'wars with computers' in which reactions to a real war were multiplied immensely by the possibilities of new communication technology". From the first days of Yugoslavia's deconstruction, followed by broken telephone lines, fax, and postal service between parts of the country and coupled with distrust and skepticism toward the official media, those with computers and modems maintained contacts and exchanged information over computer-based networks (BBSs). It could be argued that many of those who used online technologies (the technologically literate and highly educated) at that time had emigrated out of the territories of the Former Yugoslavia (especially when we consider the market value of technically literate immigrants and immigrant recruitment practices of Western countries during the "high-tech boom" in the mid-1990s).

The Kosovo crisis in 1999 provoked significant increase in online activity, both in diaspora and in Serbia. For example, discussing the web use in Serbia during the Kosovo crisis, Bacevic (2002) suggests the importance of online communication for those in the homeland in "creating a sense (illusion) of greater control over the situation" because it "eased the frustrations and alleviated the sense of rejection, isolation and threat" (Bacevic, 2002: 8). Increased online participation during the war situation has been suggested by others as well (Antonijevic, 2002; Stubbs, 1998).

Suggestions about increased participation at the times of the homeland's crisis are important for a website aspiring to become an influential diasporic

informational node on the web. The website needs an infrastructural stability (the same web address, always “up and running”) and careful moderation to accommodate the increased number of people. Moreover, it needs to offer information exchange by linking various internet media (online press, audio, and video files) so that information about the homeland could be re-checked and analyzed from several perspectives (Nincic, 2000). Understood in those terms, after the Kosovo crisis the Serbian diasporic site had managed to establish itself as one of the most popular websites in the Serbian language for both immigrant and homeland audiences.

While many of the Serbian diasporic websites have struggled to attract and maintain the immigrants’ attention in the competitive online diasporic market (by advertizements, content, emphasis on offline context), it is not by accident that this one managed to realize such a goal. With continuous financial and technical support, the site has maintained its web location for 8 years, barely changing its content and visual layout. It has established a certain stability of traditional “walls” necessary for the survival of any “virtual community” (Kolko & Reid, 1998). For the Serbian web community, as I mentioned earlier, the local, Toronto-based and immigrant-targeted businesses represent a necessary building block. In that sense, as Bleecker (2003) argues, it is not easy to discern the web community’s building aspects from those that make it market-ready. Diasporic local businesses have financial stakes in supporting homeland nostalgic online imaginary, which is being tightly linked to the marketable value of their products (from air tickets to homeland crackers).

It would be misleading, then, to treat a diasporic web community only as a spontaneous product of immigrant experience and longings for the homeland. Instead, a well-financed, skillfully maintained, and stable online environment represents an infrastructural basis necessary (but not sufficient) for community building. Beside the business-supported infrastructure, other aspects of Serbian diasporic web organizing play a role, such as assumed commonality based on the shared language, territory, and immigrant experience, the relative recency of immigration, immigrant conditions of hostlands, and the access to the web technologies.

Appadurai (1996) argues that diasporic web communities—or “virtual neighborhoods” as he calls them—could be understood as actualized, spatially produced, situated localities—the effects (material and symbolic) of a general technology of localization. Being concerned with the techniques by which locality is produced, Appadurai understands locality as a structure of feeling, as a sense of belonging that may have real, material effects and which cannot be understood apart from actual realized settings through which social life is produced. Diasporic groups, by using techniques for the spatial production of locality, construct a “material home”—a place constantly produced, reproduced, and maintained by “ritualized” practices. Massey (1998) offers similar suggestion by pointing out that we should be aware of a constant

engagement of people to “territorialize, to claim spaces, to include some and exclude others from particular area” (p. 126). Such a desire for territorialization, she furthers her argument, could be understood as an attempt “to tame the unutterable complexity of the spatial: it is a way of gaining some control (. . .) by constructing an ordered geographical imagination through which to frame our worlds” (p. 126).

The immigrant’s need for “placing” or “rooting” surely is not new. Certain aspects of the practices of territorialization have been widely studied among immigrants such as “ethnic clubs”—claimed cultural spaces that are supposed to alleviate feelings of cultural marginalization and also as a necessary bridging point for the slow process of acculturation (Kolar-Panov, 1997). While diasporic online networking might be perceived as different from older “ethnic clubs” in its mediated technological quality, it is important to note that any form of diasporic organizing employs some form of technological mediation (e.g., telephone, TV, newspapers). Or, as Poster (1998) reminds us not to treat ethnicities “through a binary opposition of immediate or mediated but through different configurations of mediation” (p. 196). In that sense, similarly to widespread ethnic clubs, organized and maintained in the “host” countries by immigrant groups, these “virtual ethnic clubs”, with a potential to provide a cultural and social space for diasporic groups, might represent a diasporic response to social/cultural changes in the broader “network society” (Castells, 1998). “Taking over” the socio-cultural functions of ethnic clubs, understood as “a kind of substitute kinship base for the newly arrived migrants” (Kolar-Panov, 1997), diasporic online places offer a basis for diasporic networking, solidarity, and support.

Although migrant networking is frequently described in terms of the particular migrants’ practices in overcoming fear of isolation, complexity of new land, a new language, and of a new culture—economic conditions in which immigrants live in hostlands should be also taken into account. In that context, to avoid less-paid and dead-ends jobs many immigrants must establish and maintain their social networks (Portes, 1996). From that perspective, it could be said that immigrants might bind together to enjoy privileges of “social capital” embedded in social networks (Putnam, 2000). In that sense, online diasporic networks could be thought of as “the imperfect means by which dislocated people who lost their geographic home retain their home imaginary, while also struggling for a literal and metaphorical place in new countries” (Shohat, 1999: 226).

### 3. DIASPORA, ETHNICITY, AND HETEROGENEITY

As Cohen points out (1999), the concept of diaspora seems to be a trendy “buzzword”, too frequently used “as an overarching concept or model to map every kind of traffic in populations, cultures, or ideas” (p. 19). Such

a prominent use of the term should be linked, as Anthias (1998) suggests, with the debates about the processes of economic and cultural globalization, increased migration of people, and the new information and communication technologies that all have problematized the traditional concepts of “ethnicity” and ethnic identity.

The traditional discourses about ethnic identity understood it as “based on shared claims to blood, soil, or language” (Appadurai, 1996: 140) and as an expression of “original” ethno-cultural characteristics shared by an ethnic group. The discourse about ethnic identity, objectified as a fixed “unity”, had overlooked its processual, situational, and changeable nature as “never complete, always in process, and always constituted within, not outside of representation” (Hall, 1990: 222). Thus, ethnicity had been understood as a primordial and shared set of traits with which only certain groups are endowed. Such an approach could not attend to the issues of diversity that exist inside of ethnic groups, such as “class and gender location, distinctive trajectories of migration and settlement, and internal differences of power, position or claims” (Anthias, 1998: 559). The theorists that hold such a view, might look for the implications of online technologies on ethnic identity as some pre-given, fixed repertoire of ethnic characteristics.

Another view of ethnicity, understood as socially constructed and changeable, assumes that ethnicity figures as a site of the constant struggle between external and internal forces that are dependent on “the individual’s perception of its meaning to different audiences, its salience in different social contexts, and its utility in different settings” (Nagel, 1994: 155). According to Nagel (1994) the process of identifying with a particular ethnic category is not simply a matter of personal choice, but is limited and influenced by socially and politically defined and imposed ethnic categories. The social, political, economical, and cultural aspects of the identity construction of an individual or a group, from that perspective, play the crucial role in the process of self-identification. As such, ethnicity has been thought of as being useful for explaining differences among different ethnic groups inside of the nation-state borders.

However, as Anthias (1998) argues, the concept of ethnic identity, despite now being fashioned as having constructed quality, still tends to focus our attention on ethnic groups inside of the nation-state, on the relationships among ethnic groups, as well as on the processes of marginalization, assimilation, exclusion, and inclusion in the country of settlement. Although those are all important issues, Anthias maintains, such a perspective cannot allow us to explore the variety of emergent or established links that an ethnic group maintains with other groups outside of the borders of the nation-state.

For example, as a way to understand migrants’ networks, Winland (1998) suggests that we need to challenge the idea of a permanent rupture between the immigrants and their countries of origin and explore the variety of ties that immigrants maintain with their homeland, particularly as these ties have been

enabled by the new communication and information technologies and transportation: long-distance communication, frequent travels to the homeland, money sent to family members that stayed in the homeland or political interest in the homeland's issues. In that context, Winland (1998) points out, beside emotional attachments and nostalgia for the homeland, diasporic groups establish and maintain the real, material links that go beyond the borders of the nation-state.

Such theoretical orientation toward transnational links maintained by diaspora has been followed by the rise of a new vocabulary better suited to theorize contemporary migration processes. The concepts such as transnationalism (Basch et al., 1994) and transnational communities (Portes, 1996) allow us to focus on migrants' social networks that cut across geographic, cultural, political, and economical borders. Seeing immigrants as being in constant relation with at least two countries, as Brah (1996) points out, we should focus our attention on the "networks of transnational identification" (p. 196). This suggests that migrants, supported by modern technology and with more affordable travel, have been able to maintain their social networks regardless of the nation-state borders, and, thus, continuity rather than rupture is a more appropriate descriptor of the contemporary migrant condition.

In this sense, the concept of diaspora might serve as an important analytical tool to address the issues of transnational migration and identifications in the context of cultural and economic globalization flows. As Anthias (1998) suggests, the concept has been useful in terms of its focus on "a connection between groups across different nation-states whose commonality derives from an original but maybe removed homeland; a new identity becomes constructed on a world scale which crosses national borders and boundaries" (p. 559–560). In that sense, people in diaspora are able to "maintain important allegiances and practical connections to a homeland or a dispersed community located elsewhere" (Clifford, 1997: 286).

Still, despite its usefulness, the concept of diaspora tends to be over-used and under-theorized (Vertovec, 2002). It relies too much, as Anthias (1998) argues, on unproblematic attachments that migrants maintain with their homeland, which constructs migrants as belonging to a "natural community" that share the same political project. From that perspective, the diasporic group becomes homogenized, Anthias (1998) maintains, even if it has been done now on the transnational level. The intra-group differences (based on social class, gender, different reasons of migration, different experiences with country of settlement) have been overlooked, particularly how those differences relate to homeland and home imaginings. To save the usefulness of the diaspora concept, it would be necessary to re-conceptualize it in terms of transnational, heterogeneous, and temporarily made social networks—since there is no such a thing as unified diasporic experience (Anthias, 1998; Stubbs, 1999).

To summarize, the concept of diaspora has helped in refocusing the theory from the processes of inclusion/exclusion of “ethnic groups” inside of the borders of nation-state to a broader view of transnational attachments and social networks. Such a point of view resonates better with contemporary economic and cultural flows and migration processes, challenging at the same time potentially oppressive practices of the nation-state. Yet, such a theoretical shift has to be accompanied by careful attention on both intra-group heterogeneity and the practices of nation-states.

Cultural hybridity has been another important concept used to problematize the notion of “ethnicity” as a fixed set of cultural traits. It has been frequently employed in the discussions about migration and cultural dislocations as a way to point out the implications of cultural encounters that migrants face in the countries of settlement. Immigrants have been usually conceived as responding by “taking on some aspects of the new culture but retaining older cultural habits” (Wise, 2000). In that sense, a diasporic group could be understood as being in constant struggle to build a “hybrid” culture, while constantly re-negotiating the links with homeland. However, the important point that Massey (1998) emphasizes is that not only diasporic cultures, but also all cultures should be conceived as hybrid ones. Traditional conceptualization of “culture” “as locally produced systems of social interaction and symbolic meanings” (Massey, 1998: 123) needs to be challenged because the processes of importation, adoption, and adaptation constitute all cultures. Taking this standpoint does not allow us to think of cultures in terms of “neatly ordered boxes labeled urban, regional, national” (Massey, 1998: 125) that tend to fashion migrants as coming from some closed, fixed-in-time, technologically unspoiled “local” culture that has been progressively “hybridized” by migration and settlement.

Such problematization of cultural hybridity could be helpful in addressing the issues related to the appropriation of computer technology by migrants in the context of different conditions of migration. We may ask, for example, how contemporary immigration processes might be different than those, say, of 50 years ago? And how has the development of online technologies coupled with economic globalization flows linked to contemporary migration? The question of “new diasporas” has been addressed by Mitra (1997), who suggests that the migration processes in the last two decades have produced the “new wave” of immigrants—usually well-educated professionals employed in North America, Australia, and Western Europe. As Mitra suggests, they might be different from earlier immigrant waves looking to settle close to their “ethnic enclaves” in big metropolitan areas in the Western world. Instead, modern immigrants in diaspora are “scattered across the Western hemisphere, working in similar professions but spatially distanced from each other” (p. 57).

The changes in the immigration practices of the Western nation-states in terms of the constant import of educated professionals (for example, as a response to the development of computer industry) have certainly been

implicated in particular technological and diasporic configurations. Although we should be careful with the claims that emphasize novelty of the contemporary processes, there is a need for detailed research that would take a longitudinal approach that addresses the several phenomena simultaneously. Without such an approach, the detailed analyses of the use of new technologies by diaspora might employ certain “old” assumptions regarding migrants by overlooking the changes in immigration processes along the way. If we take into account Massey’s argument about the hybrid nature of all cultures and problematize the idea of some local, pure, undisturbed-technologically cultures from where immigrants come, then we might understand the uses of technology by “new” diasporas as interlinked, co-shaping and not so easily separated. For some Serbian immigrants, the use of the diasporic website might start well before the immigration. The discussion boards dedicated completely to the issues of the immigration process (visa applications, transport, settlement) can serve as a proof: Those experienced in such issues (another diasporic business involved) regularly provide resources for those who plan to immigrate, making the immigration process and settlement less ruptured than it could be before the web technologies has been involved in the diaspora–homeland relationship.

#### 4. HETEROGENEITY OF A DIASPORIC WEB COMMUNITY

The Serbian diasporic web community gathers Serbian immigrants that differ across gender, age, class, level of education, or a country of settlement. Moreover, it also includes those who currently reside in the homeland. The survey taken from the community web page suggests that one-third of online participants currently reside in North America, one-third in Europe and Australia, while one-third log on to the site from the homeland. When geographic location of the participants is concerned, this web community is obviously quite diverse. How, then, does the website attracts and maintain such a diversity?

The spatial configuration of diasporic website shapes experiences of its online participants by teaching certain “ethnic” pedagogy. It embodies “nationness” by promoting particular images and narratives that make online visitors to “feel-at-home (Fortier, 2001). Visually, as mentioned earlier, this diasporic website represents itself with an image of a professional, informational web portal that at the “entrance” page offers the links such as money conversion, world news, and weather forecast. Such online presentation problematizes a usual rendering of diasporic online spaces as highly nationally narrativized. Instead of the usual visual display of “ethnicity” (e.g., flag, national memorabilia, homeland pictures), the language in which the site content is displayed obviously serves as the mechanism of inclusion and exclusion of online participants. Even more, among many Serbian-related, immigrant-targeted websites this one belongs to a small group of sites without the openly nationalistic character. It could be argued that by mimicking the layout of a business-casual

“portal” and dropping the typical diasporic memorabilia, the website manages to appeal to the widest possible audience of Serbian speakers both in diaspora and in the homeland. The shared language within web community and a relative recency of emigration of the majority of participants makes sure that the homeland is not forgotten and that business advertizing has its own audience. It is important to emphasize that for the use of this web portal the knowledge of any other language beside Serbian is not necessary—majority of web links (including the search engine located on the site) lead to the web content produced in the Serbian language. In that sense, the language of the site encompasses all possible intra-group differences.

The heterogeneity of the diasporic web space is created by numerous online groups that are more or less tightly attached to the main site. The main ethnic portal serves as a broader online territory, a stable infrastructure that acts as a “diasporic umbrella” to various online groups that appropriate parts of the common space (a discussion group, a chat channel) for some time and in a specific way. In that sense, it could be more appropriate to talk about the diasporic network of web communities, than of a single community. Only detailed ethnographic research, by closely following the segmentation of web space in time could suggest how the inter-group differences have been used for a sub-community building and membership regulation within a larger diasporic network.

The heterogeneity of Serbian diasporic web community, beside the differences related to gender, level of education, territory of emigration, or age, reveals also in the way in which the location and the experience of migration have been played out in community discourse. For example, the differences between those located in the homeland and those living in diaspora (as immigrants, refugees, students, guest-workers); between refugees and voluntary (“professional”) immigrants, or between participants immigrated to Western Europe and U.S.A./Canada/Australia could be particularly relevant. I mention those because not only they tend to be frequently invoked in online narratives, but also because they are sometimes overlooked in the research studies of online diaspora.

The narrative practices of participants in the website textual environments (discussion boards and chat lines) are the important component of the diasporic online culture. For those involved in online communication the perceived differences among participants might serve as the basis for the community segmentation or re-connection so that sub-communities frequently emerge, change their form, and diminish depending on many factors. For example, stereotyping, as a way to attach certain differences to particular people, has frequently been used by participants in online diasporic discourse as a basis for the segmentation of community. Thus, some Serbians accessing the online community from the homeland label the rest of the community as “dish-washer immigrants”—working in dead-end, low-paid jobs (“washing dishes”) despite their claimed university credentials. Similarly, those who stayed in the



homeland tend to be labeled as “those whom no country would accept”, and those who migrated under refugee class might be stereotyped as “lazy” by being forever “on welfare”. Such textual otherings, reflecting the local (both hostland and homeland) political and cultural narratives have been frequently invoked and reproduced in online textual spaces, and possibly implicated in further community segmentation.

## 5. SHIFTING OF NOSTALGIC NARRATIVES

As mentioned earlier, diasporic web communities tend to be perceived as sharing the same unproblematic orientation toward the homeland. A diasporic online space, jointly produced by those who finance and support the community infrastructure and participating immigrants dispersed transnationally, has been used frequently as a research site of online-displayed homeland imaginary. While nostalgic narrativization of the lost or voluntarily left homeland could be a frequent diasporic practice and easily found theme of online diasporic texts, it has been sometimes over-addressed and rarely problematized.

Understanding diasporic online spaces only through nostalgic lenses implies the sameness of diasporic experience and disregard intra-group differences that are constitutive of all diasporic groups. Without knowing who produce such narratives, in which context, when—especially if we take into account moderation of online discourse (why such narratives get more visibility than others?)—we might not be able to fully address diasporic online practices. For example, one-third of the regular participants of the Serbian web community (according to the community web survey) are without a job. We might ask, then, how certain conditions of settlement (such as the lack of employment, loneliness, poor knowledge of host languages) might be implicated in the production of specific online narratives. Such questions situate online practices in everyday immigrant life, and help us to understand them as produced, the result of various factors, rather than as a spontaneous expression of a diasporic experience.

In diasporic discourse, the notion of “homeland” has much more complex and ambiguous meaning than it is frequently implied (Anderson, 1998). While for some immigrants the homeland might refer a particular geographical and political entity, for others the homeland gets more narrow or wider meaning depending on many factors. In the case of Serbian web community, the location of country of settlement in relation to the homeland could be implicated in homeland narratives. For those immigrants settled in North America or Australia, for example, online narration of the homeland frequently addresses “Europe” as a broadened reference of the homeland. For example, the frequent theme underlying online postings in the Serbian web community is summarized in a phrase—“I live in the US (or Canada/Australia) for some

time and I feel that I miss Europe and European lifestyle”. “Europe” is fashioned both as “home” that have been missed and longed for, and as a signifier of an imagined “lifestyle” (luxurious life, cafes, strolls, “high” culture). Such narrativization of “Europe”, frequently simulating the hostland’s media discourses (TV, Hollywood, magazines), is implicated in detaching the homeland from its precise geo-political location, shifting of “Europe” as a backdrop for re-imagined homeland memories. On the other hand, for Serbian immigrants settled in Europe the homeland might stay secured within its geographic borders, because they are constantly reminded of their “Eastern-European-ness” in daily, offline life. The meaning of “homeland” or “origin” of those diaspora, as we can see, could shift depending on the country in which immigrants settle. The host land imaginary might provide the point of reference from which immigrants narrativize “homeland”, negotiate its meanings, and understand their cultural belongingness.

When discussing the implications of the heterogeneity of diaspora on homeland imaginary, it is important, then, to account for diverse migrant experiences, different conditions of migration, as well as many other contextual conditions of diasporic location. The case of the Serbian web community suggests that this website gathers both refugees, those expelled from their cities and villages, who lost their home without possibility of return, and also “voluntary” immigrants who “applied” for acceptance, waited for several years for visas and are in possession of two passports, and able to choose between two countries to live. We might ask, then, how the possibility that the “homeland” as a point of return or a traveling destination, might be implicated in production of homeland imaginary? How the existence of active social ties (parents, close families, friends) might shape homeland imaginary? But also: How those violently expelled from “homeland” might narrativize it differently?

While it might not be possible to fully understand the production of homeland imaginary without extensive ethnographic research, I want to point out some possibilities that online diasporic spaces offer regarding the nostalgic narrativization of the homeland. As I mentioned earlier, the ways in which the shared “homeland” is fashioned is a contested terrain in online spaces. Depending on immigrants’ location, the experience of migration, age, or gender, among other things, the produced image of the homeland might not correspond to the political borders of the nation-state. Nostalgic narratives produced online can take many forms—narrated memories of home, city, people, memories, and childhood could be incorporated in online messages in response to any of various themes. The online diasporic space, by offering the space for collective memory exchange, gives a chance for those in diaspora to bring something new, a new detail that fills in the “memory-mosaic”. As a group performance, “the nostalgia talk” serves as “bait” for attracting others who share such memories. By producing nostalgic immigrant stories, the immigrants could temporarily alleviate daily struggles with new socio-cultural

environments in sharing comforting personal memories of the places, peoples, and times left “back home”.

Narrativization of the homeland in the Serbian diasporic web space displays characteristics similar to any other nostalgic “talk”—the homeland is narrated through memories of “good old” friends, holidays spent on the Adriatic coast, mother’s kitchen, first love, soccer games. However, the online presence of those who are currently located in the homeland or frequently travel there, as the analysis of the Serbian web community suggests, could interrupt such nostalgic performances and produce a conflicting image of narrated memories. As an example, I provide three excerpts from a long online thread that could be labeled as a “diasporic nostalgia talk”. It is important to note that the thread is taken from the Serbian web community discussion board during the Kosovo crisis in 1999—the time when offline events happening in the homeland had been frequently replayed in online practices (Nincic, 2000). First excerpt is the opening post of the thread, followed by two online replies that illustrate the production of conflicting images of the homeland and homeland-related memories. A participant, currently residing in the United States, starts the thread with:

I feel like a tree that was pulled-out, and then planted upside-down. Here (as anywhere in the West) I see my next-door neighbor once a year, others I never met, I don’t know anybody from whom I can borrow an egg, for example. Even if I die, nobody will notice. I don’t hear music here (only during weekends, when everybody behaves like crazy), birds don’t sing, children don’t speak (they sit at home at computers), people meet in bars (if somebody invites you to their home, that’s pretty intimate!), there are no parties I could go. Here, I can’t get that phone call I miss so much—“Put the coffee pot, I’m coming over”. There is nothing that reminds me on us.

One of the replies to the message above comes also from an immigrant who recently traveled to the homeland, and who, by offering a “first-hand” experience and narrowing the homeland to the particular city (Belgrade, the capital of Serbia and Montenegro) potentially disrupts the presented image.

I also miss old Belgrade. THAT Belgrade where we would go out almost every night. I miss ‘our’ clubs, you know, were we would find each other, places like “Cvetic”, “KP”, “Natan”. . . I miss my old Belgrade’s circle of friends whom I could listen over a coffee for hours. I miss its parks, rivers, streets . . . but . . . all of those things have disappeared. The last time I traveled there, I had finally understood that my hometown doesn’t exist anymore. People I met are not like us, they dream of other things. Belgrade I remember isn’t there anymore.

Already challenged “nostalgic talk” becomes even more disrupted by the participation of those currently located in the homeland. The next message, written by a participant from the homeland’s capital illustrates the point:

Dear people far away from Belgrade, you are such hypocrites! Yes, I can understand how “burdened” is your life. Yes, I felt that during the bombing, too. It was painful for you! You were “supporting” us when we were out of electricity and water, with the bombs all those nights. You were “trembling” with us, saving your money for your new cars and the third television set. You were “crying” while putting your children in bed, knowing that ours are in shelters. And now, you are “suffering” when you’re buying milk, knowing that we don’t have any. Really, it’s not fair that you suffer so much! Who wants to come back—I’ll give him/her my job as a software engineer and the room in my parent’s house, and all that food you miss so much—which I couldn’t afford with my salary of \$50 per month (when it comes). For a change—I’ll take your job and all your problems so that I could suffer a little! So, why don’t we trade places, you come here, I’ll come there . . . so we could ease your suffering!

By refusing to participate in the narration of “old” comforting memories that are characteristic for diasporic talk, online “voices from home”, sometimes as silent, sometimes as fully visible audience as in this excerpt, could interrupt the tone of nostalgic narratives and challenge their decontextualized flow. The imagined “homeland” becomes now contested terrain—the presence of participants from different locations, especially those from the homeland, might produce various images that challenge the idealized, imagined, and unitary “homeland”. Only detailed ethnographic research of diasporic online spaces could show how and in which ways homeland imaginary becomes problematized in online diasporic context.

## 6. HOME AND HOMELAND ONLINE

The concept of diaspora, as previously mentioned, is closely linked and frequently used in the context of the immigrant experience of a search for a new “home” after loosing the “original” one. For the traditional migrant theory, the concept of “home” has been understood as a place of a particular geographic location, assuming unproblematic emotional ties that bind an immigrant to his or her former “home”.

The recent discussions of the meaning of home from the exilic and diasporic perspective have suggested that “home” could be conceived as imaginary, temporary, and situated. As Naficy (1999) argues “[h]ome is anyplace; it is temporary and it is moveable; it can be built, rebuilt, and carried in memory

and by acts of imagination” (p. 6). The imaginary quality of home and the desire for rebuilding it when the home is left or lost could be particularly important for those migrated, exiled, displaced. While a homeland might be implicated in the production of an imaginary of the “home” that has been left, there is no reason to assume that migrants imagine and produce meaning of a “new home” as tightly linked to the homeland. As Wise (2000) writes, “[h]ome is not an originary place from which identity arises. It is not the place we ‘came from’; it is a place we are” (p. 29). If we understand the production of a “home” or the desires for “homing” (Brah, 1996) as the most important migrant practice in the context of dislocation, it is important to think about where and how the home is built? How is the experience of mobility, border crossing, and migrant travel implicated in the process of making oneself “at home”? Should we think, as Fortier (2001) asks, of migrants as being “at home in ‘migranhood’” so that the new identity project builds upon experienced mobility?

There is a certain tendency present in scholarly work to imagine today’s ethnoscape (Appadurai, 1996) as “border-free” in which we all feel as “nomads”—the concept that “denies the dream of a homeland, with the result that home, being portable, is available everywhere” (Peters, 1999: 31). The nomadic discourse, inspired by the migrant condition, has been conceived as producing borderless identities, employing “a kind of cosmopolitan chic—taking the allure but none of the pain” (Peters, 1999: 35). Such romanticized understanding of the “movement”, as Cresswell (1997) maintains, tends to sum up all experiences of migration, travel, and movement under the concept of “nomad”. Movement is frequently taken up as the most important experience of contemporary migration, thus, there is “a recognition that not only can one be at home in movement, but that movement can be one’s very own home” (Rapport & Dawson, 1998: 27). As for diasporic groups, Fortier (2000) problematizes such privileging of mobility over “homing” by arguing that migrants are produced through both movement and attachment.

While experience of expulsion, migration, and cultural and social dislocation is constitutive of migrant condition, there is no reason to assume that geographic places, locales, and nation-state borders are becoming irrelevant. Borders crossings, citizenships, and passports are of still real consequences for many (Shohat, 1999). Even if globalization flows tend to weaken hegemonic imaginary apparatus of the nation-state, we should not forget that it has been weakened only for some. As Bhabha (1999) warrants, the power of the nation “to determine the lives of its citizens through national economic policy and political regulation should not be underestimated” (p. ix).

The practices of the country of settlement in which immigrants have found new home actively participate in the symbolic construction of homeland imaginary by playing the role of a “significant Other” (Fortier, 2001), which frames homeland images (e.g., “coldness” of hostland makes the warmth of homeland comforting). Frequently overlooked in diasporic writings focused on the

maintenance of the ties with the homeland, are the hostland's practices of inclusion and exclusion, as well as the opportunities and resources to which immigrants have an access. In that context we might ask how the multiculturalist paradigm, officially adopted in certain Western countries, has been implicated in the processes of constructing and maintaining the fixed differences of ethnic cultures (Bannerji, 2000)? Or, how immigration procedures that divide immigrants along ethnic lines might actually channel all differences among immigrant groups only in the cultural domain (folk songs, food, fashion, dance)? Such issues have to be taken into account if we want to contextualize diasporic practices in the process of establishing and maintaining of social networks, which make one to feel "at home".

The "place called home was never an unmediated experience" (Massey as quoted in Morley, 1999: 156). The search for a place, for a territory, is frequently presented as a reactionary practice, similarly to a search for roots and fixed origins. However, as Massey argues, if we begin to think about place as a "point of intersection" in a broad networks of relations, then we would be able to understand "place" as particularly linked to other places that gives such place an identity, a meaning (Morley, 1999: 157). The process of searching for "home" will always be the product of migrant's active social networks and not necessarily linked to the imaginary of left homeland. In that sense, the concept of diaspora "offers a critique of discourses of fixed origins while taking into account of a homing desire, a distinct from a desire for a 'homeland'" (Brah, 1996). In some way, the practices of making home and constructing home imaginary rely on the links and attachments established and maintained to both homelands and hostlands, which are constantly being reconfigured in the context of everyday life.

From that perspective, a diasporic online network could be conceived as a temporary, changeable, constantly shifting product of the desires of "homing"—desires to "feel at home" in one's known language, in the familiar referent system, or in the comforting ideas of community belonging.

## 7. TECHNOLOGIZED DIASPORA: SOME LANGUAGE-RELATED ISSUES

The scholarly interest in the social and cultural aspects of online communication, while producing interesting and valuable work, tends to produce the split between technologies and social practices. The focus on online diasporic practices frequently emphasizes, Poster (1998) argues, technological mediation as a novelty, implying technologically unmediated nature of diasporic communities that existed before the introduction of the internet. To overcome the split between diasporic and technological we might focus on the process of the simultaneous development of both by asking how, in this particular case, the Serbian web community has been developed and established as a diasporic location? Such questions could help us better understand how a

certain diasporic group developed specific practices that could not be realized without the particular technologies.

Every social network established online could be understood as a product of “a dynamic process of appropriation in which participants invoke structures to create meanings in ways that researchers or system designers may not foresee” (Baym, 1998). Furthermore, Castells (1998) argues, the common language represents, more than ethnicity or territoriality, “a fundamental attribute of self-recognition, and of establishment of an invisible national boundary” (p. 52) to which certain group might retreat as an act of resistance to globalization flows that threaten to the group identity. In the context of migration, following Castells, a group that shares same language might invoke it as the boundary mechanism of inclusion and exclusion of others from the group. In the discussion of language clash that immigrants might experience in the process of re-settlement in hostlands, Gunew (Spivak & Gunew, 1993) asks, “if you are constructed in one particular kind of language, what kind of violence does it do to your subjectivity if one then has to move into another language, and suppress whatever selves or subjectivities were constructed by the first?” (p. 201). However, research on diaspora concerned with the processes of inclusion and exclusion “tended to be restricted to those ‘ethnic minorities’ that are constructed in ‘race’ terms” (Anthias, 1998: 558) and not to consider language as a boundary marker.

Theoretical discussions that address the issue of cultural homogenization of internet technologies frequently remind us of the inability of computer software to support written languages that are not based on the Latin alphabet. This has a particular importance if seen in the light of the constant increase in the internet users that come from non-English speaking countries. Some theorists argue that such English-oriented online environment might completely discourage or disable the communication in languages other than English one.

However, as the case of the Serbian online network suggests, the English-language dominance regarding online technologies has been overcome on the local level. Serbian-speaking participants in the English-based software environment use the modified version of Serbian written language in Latin alphabet. While Cyrillic has been accepted as the official alphabet, both Cyrillic and Latin versions of the language have been used (Vitas & Krstev, 1999). Although in the last several years it has become possible to use Cyrillic alphabet for online communication so that all 30 letters could be used in writing, it has been rarely done (most importantly, at this point, because of the complexity of the procedure). Thus, online communication in the Serbian web community has developed an “online Serbian”—using the “reduced” Latin alphabet (without w, x, and y) and Serbian without five letters. For example, to write on discussion boards or on IRC chat lines Serbian speakers require 30 letters, but they can only use 25—that is the number of letters that Cyrillic and the Latin alphabet language share. Similar tendency of using a “restricted”

version of written language has been found in other non-English online environments. For example Pargman (1998) offers the case of Swedish-speaking MUD community and Voiskounsky (1998) reports of Russian speakers that use both Cyrillic and Latin version of Russian language in online context.

Such situations in which certain “embedded” traits of technology require that users modify their practices (in this case online participants use written form of language by using one letter instead of the other) might serve as one among many points of critique of the oppressive nature of technology. However, what sometimes tends to be overlooked in critical approaches of that kind, is a balanced analysis of the possibilities that have been opened up (and not only closed off) by appropriating specific type of technologies. Only extensive research of diasporic online participation in a particular context could possibly suggest if and how computer-mediated communication has been simultaneously facilitated and hindered by the use of online technologies. More specifically, we need answers on questions such as, who among Serbian speakers might be excluded from web community and how language practices used online have been implicated in that exclusion. While there is a tendency to attribute online spaces an “agency” to influence language choices, such as the prominent use of English words in online communication in a native language (Voiskounsky, 1998), there is a lack of research that shows how such language choices in online communication might be related to other factors beside the internet (hostland practices, for example).

This case serves only as an example of how a certain socio-technological configuration (such as the diasporic web community) might be seen through the lenses of its development, as a construct of the processes of negotiation of all actors involved (local diasporic market, diverse diasporic population, the homeland-based participants, characteristics of technologies). To isolate only a particular point in that configuration (“language unfriendliness” of technology, for example) requires that we talk about online environment in an abstract way, out of the context in which it has been developed.

#### CONCLUSION: TROUBLES AND PROMISES

In this chapter, I have attempted to present some of the issues that sometimes tend to go unnoticed when diasporic web communities have been taken up in the literature. I tried to suggest, by agreeing with Anthias (1998), that the problematic nature of the diaspora concept emerges when we assume the “sameness” of a diasporic group by focusing on the group commonality and prioritizing the fixed homeland imaginary. The discussion in this paper suggests that a diasporic network could be produced “as much in difference and division as it is in commonality and solidarity” (Anthias, 1998: 564), and that intra-group differences in online diasporic networks, especially when



enriched with the participation of people from the homeland, might interrupt “fixed”, unproblematic links toward imaginary or “real” homeland.

The production of diasporic online place having the shared community language as a mechanism of inclusion and exclusion, represent a long process in which many actors become actively involved: the local practices of countries of settlement, immigrant business, dispersed diasporic groups, diverse technologies, and active involvement of the people from the homeland. All of those actors actively participate in the production of the online diasporic space. Moreover, the local conditions, such as economical, cultural, or political practices in both hostlands and the homeland have been actively involved in such production.

By taking the standpoint that focuses on the parallel development of diasporic practices and their technological mediation, we might start to get better understanding of particular diasporic web communities and their role as the pedagogical space that teaches those who participate and produce the place—who, why, and with what purpose should be counted as “being in online diaspora”.

#### ENDNOTE

1. The former homeland, Yugoslavia, is now Slovenia, Croatia, Bosnia and Hercegovina, Serbia–Montenegro, and FRY Macedonia.

#### REFERENCES

- Anderson, A. (1998). Diaspora and exile: a Canadian and comparative perspective. *International Journal of Canadian Studies* 18, 13–30.
- Anthias, F. (1998). Evaluating diaspora: beyond ethnicity? *Sociology* 32(3), 557–580.
- Antonišević, S. (2002). Sleepless in Belgrade: a virtual community during war. *First Monday* 7(1). Retrieved 10/01, 2003, from the World Wide Web: [http://firstmonday.org/issues/issue7\\_1/anton/index.html](http://firstmonday.org/issues/issue7_1/anton/index.html).
- Appadurai, A. (1996). *Modernity at Large: Cultural Dimensions of Globalization*. Minnesota: University of Minnesota Press.
- Bacevic, L. (2002). The development of Internet in Yugoslavia. In: Todorov, H. (Ed.) *New Media in Southeast Europe*. Frankfurt-Oder, Sofia: SOEMC, European University, Sofia University St. Kliment Ohridski.
- Bannerji, H. (2000). *The Dark Side of the Nation: Essays on Multiculturalism, Nationalism and Gender*. Toronto: Canadian Scholars' Press.
- Basch, L., Glick Schiller, N., & Szanton Blanc, C. (1994). *Nations Unbound: Transnational Projects, Postcolonial Predicaments and Deterritorialized Nation-States*. Basel: Gordon & Breach.
- Baym, N. (1998). The emergence of on-line community. In: Jones, S. (Ed.) *Cybersociety 2.0: Revisiting Computer-Mediated Communication and Community*. Thousand Oaks, London, New Delhi: Sage Publications, 35–68.

- Bhabha, H. (1999). Arrivals and departures. In: Naficy, H. (Ed.) *Home, Exile, Homeland: Film, Media, and the Politics of Place*. New York, London: Routledge, vii–xii.
- Bleecker, J. (2003). *The Book Review of Lisa Nakamura, Cybertypes: Race, Ethnicity, and Identity on the Internet*. Resource Center for Cyberculture Studies. Retrieved 03/08/2003 from the World Wide Web: <http://www.com.washington.edu/rccs/bookinfo.asp?ReviewID=213&BookID=182>.
- Brah, A. (1996). *Cartographies of Diaspora: Contesting Identities*. New York: Routledge.
- Castells, M. (1998). *The Power of Identity*, Vol. II. Malden, MA; Oxford, U.K.: Blackwell Publishers Inc.
- Clifford, J. (1997). Diasporas. In: Rex, J. (Ed.) *The Ethnicity Reader: Nationalism, Multiculturalism and Migration*. Cambridge: Polity Press.
- Cohen, P. (1999). Rethinking the diasporama. *Patterns of Prejudice* 33(1), 3–22.
- Crosswell, T. (1997). Imagining the nomad: mobility and the postmodern primitive. In: Strohmayr, U. (Ed.) *Space and Social Theory*. Oxford: Blackwell, 49–71.
- Fortier, A.-M. (2000). *Migrant Belongings: Memory, Space, Identity*. Oxford: Berg.
- Fortier, A.-M. (2001). *Global Migrant Hood, Whiteness and the Anxieties of (In)Visibility*. The Department of Sociology, Lancaster University. Retrieved 10/10/2002 from the World Wide Web: <http://www.comp.lancs.ac.uk/sociology/soc066af.html>.
- Hall, S. (1990). Cultural identity and diaspora. In: Rutherford, J. (Ed.) *Identity—Community, Culture, Difference*. London: Lawrence & Wishart Ltd., 222–237.
- Jones, S. (2002). Afterword: building, buying, or being there—imagining online community. In: Shumar, W. (Ed.) *Building Virtual Communities: Learning and Change in Cyberspace*. Cambridge, U.K.: Cambridge University Press, 368–376.
- Kolar-Panov, D. (1997). *Video War and the Diasporic Imagination*. London: Routledge.
- Kolko, B. & Reid, E. (1998). Dissolution and fragmentation: problems in on-line communities. In: Jones, S. (Ed.) *Cybersociety 2.0: Revisiting Computer-Mediated Communication and Community*. Thousand Oaks, London, Delhi: Sage Publications, 212–230.
- Lave, J. (1996). Teaching, as learning, in practice. *Mind, Culture, and Activity* 3(3), 149–164.
- Lave, J. & Wenger, E. (1991). *Situated Learning: Legitimate Peripheral Participation*. Cambridge: Cambridge University Press.
- Massey, D. (1998). The spatial construction of youth cultures. In: Valentine, G. (Ed.) *Cool Places: Geographies of Youth Cultures*. London: Routledge, 121–129.
- Mitra, A. (1997). Virtual commonality: looking for India on the Internet. In: Jones, S. (Ed.) *Virtual Culture*. London: Sage, 55–79.
- Morley, D. (1999). Bounded realms: household, family, community, and nation. In: Naficy, H. (Ed.) *Home, Exile, Homeland: Film, Media, and the Politics of Place*. New York and London: Routledge, 151–168.
- Naficy, H. (1999). Framing exile: from homeland to homepage. In: Naficy, H. (Ed.) *Home, Exile, Homeland: Film, Media, and the Politics of Place*. New York, London: Routledge, 1–13.
- Nagel, J. (1994). Constructing ethnicity: creating and recreating ethnic identity and culture. *Social problems* 41(1), 152–176.
- Nincic, V. (2000). Serbian virtual community and ethnic identity. *Unpublished MA Thesis*, University of Toronto, Toronto.
- Pargman, D. (1998). Reflections on cultural bias and adaptation. In: Sudweeks, F. (Ed.) *Proceedings: Cultural Attitudes Towards Communication and Technology '98*. Sydney: University of Sydney.
- Peters, J. D. (1999). Exile, nomadism, and diaspora: the stakes of mobility in the Western canon. In: Naficy, H. (Ed.) *Home, Exile, Homeland: Film, Media, and the Politics of Place*. New York, London: Routledge, 17–41.

- Portes, A. (1996). Globalization from below: the rise of transnational communities. In: Korczenwicz, R. P. (Ed.) *Latin America in the World Economy*. Westport, CN: Greenwood Press, 151–168.
- Poster, M. (1998). Virtual ethnicity: tribal identity in an age of global communications. In: Jones, S. (Ed.) *Cybersociety 2.0: Revisiting Computer-Mediated Communication and Community*. Thousand Oaks, London, Delhi: Sage Publications, 184–211.
- Putnam, R. (2000). *Bowling Alone: The Collapse and Revival of American Community*. New York: Simon and Schuster.
- Rapport, N. & Dawson, A. (1998). *Migrants of Identity: Perceptions of Home in a World in Movement*. Oxford: Berg.
- Shohat, E. (1999). By the bitstream of Babylon: cyberfrontiers and diasporic vistas. In: Naficy, H. (Ed.) *Home, Exile, Homeland: Film, Media, and the Politics of Place*. New York and London: Routledge, 213–232.
- Spivak, G. C. & Gunew, S. (1993). Questions of multiculturalism. In: During, S. (Ed.) *The Cultural Studies Reader*. London and New York: Routledge, 193–202.
- Stubbs, P. (1998). Conflict and co-operation in the virtual community?: eMail and the wars of the Yugoslav succession. *Sociological Research Online* 3(3).
- Stubbs, P. (1999). Virtual diaspora? imagining Croatia on-line. *Sociological Research Online* 4(2). Retrieved 02/10/2000 from the World Wide Web: [www.socresonline.org.uk/socresonline/4/2/stubbs.html](http://www.socresonline.org.uk/socresonline/4/2/stubbs.html).
- Vertovec, S. (2002). Religion in Migration, Diasporas and Transnationalism. Vancouver Centre of Excellence. Retrieved 02/02/2003 from the World Wide Web: <http://www.riim.metropolis.net/Virtual%20Library/2002/wp02-07.pdf>.
- Vitas, D. & Krstev, C. (1999). Cultural impacts on electronic publishing: experience in Serbia. *New Library World* 100(1149), 171–178.
- Voiskounsky, A. (July 20–24, 1998). Internet: diversity or unification? *Paper presented at the 48th Annual Conference of the International Communication Association*, Jerusalem, Israel.
- Winland, D. (1998). ‘Our home and native land’? Canadian ethnic scholarship and the challenge of transnationalism. *Canadian Review of Sociology and Anthropology* 35(4), 555–577.
- Wise, M. (2000). Home: territory and identity. *Cultural Studies* 14(2), 295–310.

# Chapter 42: Exploring the Production of Race Through Virtual Learning Environments<sup>1</sup>

MELISSA ALTMAN AND RADHIKA GAJJALA

*Bowling Green State University*

## 1. INTRODUCTION

Virtual space, suggests Sally Munt, cannot exist without a perceiver (Munt, 2001). Likewise, techno-mediated subjectivities cannot be understood unless the observer enters these spaces and tries living in them, working with them, doing things with and in them.

The early promise of Gibson's cyberspace as limitless, ungrounded, an escape from the "meat" of the body, a space where the virtual has no connection to the real, has been disappointing. The notion that there is no race or gender in cyberspace has long been contested (see works by Lisa Nakamura, Coco Fusco, Alondra Nelson, and others) by critical scholars and inhabitants of online spaces. Although analyses of static<sup>2</sup> texts are proliferating, fewer scholars are actually observing the processes of production of culture within such online spaces. This is what this project focuses on—the actual production of cultural experience and materiality of virtuality, as it is experienced by participants in online environments.

Even in these virtual environments, participants do not leave their bodies behind. Hence, the virtual/real distinction sets up a false binary that cannot be substantiated when we analyze engagement with online environments. Part of what our analysis does is to try to unravel the dichotomy between the virtual and the real.

Physicality of the body is expressed through everyday material practices, even when those practices involve online production of self. The practice of *engaging* such a technological environment produces the subject/agent. Meaning, therefore, is made through doing—doing in this case is coding, programming, typing oneself into existence, and building objects.

Race in a global cyberspace is nuanced and complex. We are therefore concerned with the designing of diverse, embodied, and dialogic encounters for the effective use of virtual learning environments in order to study complex processes of meaning making in digital/analogous contexts that shape and are shaped through post 1990s globalizing processes. Thus, our overall work is an extension of the work on race in cyberspace and is based on research examining the production of techno-mediated subjectivities at various interfaces both in traditional classroom pedagogical settings and other online settings.

Virtual learning environments are implicitly and explicitly based in globalization processes that bring together workers, educators, students, and employers from multiple socio-cultural, geographical and economic histories, and with varying personal histories as well as skills and literacies in relation to digital work. We examine these in the context of digital technology use and consumption. In this chapter, we argue that, between the presences and absences of such raced bodies—produced through layered, nuanced and contradictory workings of class, interpersonal culture, literacy, and language—“race in cyberspace” can benefit from a much more complex analysis and response than what has been pursued thus far by scholars studying race in cyberspace.

Further, in previous work examining South Asian and Asian Techno-mediated subjectivities (which will inform the present piece) one of the authors has argued that race, class, caste, gender, geography, and specific located histories of colonization INTERSECT with specific place-based configurations of access to various literacies associated with the communities of production (within which the internet becomes important), to shape constructs of identity and ignorance. These constructs of identity and ignorance in turn reproduce existing socio-cultural patterns of inclusion and exclusion, thus intersecting with geographically, culturally, historically, and nationally produced *place-based* configurations of race to produce contradictory manifestations of racism and acts of silencing online (see Gajjala, 2000; 2001).

This book chapter is based on efforts to interrogate these issues through controlled environments in classrooms, and is exploratory. It is part of a larger project that we are working on in an effort to open up different ways for examining issues of race in cyberspace and to provide a variety of possible pedagogic interventions and practices to engage the problem of racialization within cyberspace that is clearly situated in unequal power relations manifested within current “global” economies.

## 2. PEDAGOGIES FOR VIRTUAL LEARNING ENVIRONMENTS IN A DIVERSE WORLD

In the present chapter therefore, we have drawn on our experience with the use of online synchronous and asynchronous environments, as well as other digital media such as digital video and software associated with digital imaging such as Adobe Photoshop, in attempts to design pedagogies of dialogue and diversity within virtual learning environments. The discussion draws on a period of 8 years of experience on one of the co-author’s part using digital internet-mediated tools and environments in pedagogical settings. Scholars involved in distance teaching and learning have always been interested in the use of new technologies for teaching and learning processes. Issues of digital divide, gendered access, race, and other forms of diversity including disability in relation to access and use of such virtual/real technologies (both

in classroom settings and in cyber-based environments in general) have also been discussed by various researchers (see for instance, Blair & Takayoshi 1999; Kolko et al., 2000).

This research focuses on these two types of questions, and the implicit and explicit purpose of the assignments introduced in the courses that we discuss in this chapter<sup>3</sup> tend to focus on such explorations:

1. First, questions about how identity, subjectivity, and power are produced in virtual learning environments. This research explores how race, gender, class, and other characteristics of identity are produced or enabled through:
  - the design: of the virtual learning environments;
  - varying kinds of access to the virtual learning environments; and
  - the ways in which various users design, access, and utilize particular learning environments.
2. Second, questions are asked about pedagogical strategies in VLE.
  - What teaching strategies and course designs enhance learning through digital environments?
  - How can teachers and learners foster learner interaction, motivation, and engagement?
  - What strategies are effective for particular media?

The increasing availability and access to various synchronous and asynchronous interactive communication tools online has instigated much discussion and experimentation during this past decade or so regarding the potential for the use of these interactive tools for both on-campus university classes as well as for distance learning. It has been said that the information communication technology revolution will lead to significant changes in the way classes are taught. With the proliferation of online software, students and faculty are forced to continually redefine notions of “classroom”, and “teaching”. The use of online technologies in instruction changes the way students and teachers interact in both structural and social ways. With classes increasingly being taught in computer labs and in online spaces created by web-based technologies, Multi-User Dungeon (MUDs), MUDS Object Oriented (MOOs), and e-mail listprocs, the nature of all interaction between teacher and students (including both face-to-face and computer-mediated communication) is different, to say the least. Of course the difference in modes of interaction and the continual reinvention of what it means to be in a classroom does not necessarily mean that the quality of education is better. The mere use of technology in the classroom or in any teaching environment, as we all know, does not enhance the teacher’s pedagogical skills and methods. Nor does the use of technology in itself ensure that students will become more self-motivated or intellectually and technologically savvy (whatever that means).

Here, we use specific examples from our course contexts to talk about shifting digital/analogue hierarchies in virtual learning environments, based

in varying degrees of access and levels of literacies of students, as well as to extend discussions concerning racism and cyberspace by addressing issues of the production and reconfiguration of subjectivities through the encounter between students and specific technospaces. In our larger project, the interfaces included are MOOs, Digital Video, websites, and course management tools such as Web-CT and Blackboard. In the project from which this chapter is drawn, we attempt to investigate questions regarding race, gender, class, sexuality, and geography in digitally mediated cultures through a discussion of exercises and resulting reaction papers, journals, face-to-face discussions, blogs, and other student observations in relation to virtual/real learning environments in which these issues were raised. Based on these, we argue for a nuanced and radically contextual examination of race in cyberspace. In doing so, we argue that it is essential that we link issues of race, class, caste, gender, geography, culture, and literacies seriously with the economics of cultural production and technological design (hardware and software as well as business and pedagogical environments based in various technologies associated with virtuality) that are situated within processes of globalization.

### 3. DESCRIPTION OF THE DEVELOPMENT OF ASSIGNMENTS USED FOR CASE STUDIES

Below is an explanation of the course assignments that led to our analysis of the production of race in cyberspace. In the initial phase of the project, which was conducted in a Graduate Seminar on Computer Mediated Cultures held in spring of 2003, the environment and objects were pre-constructed by the instructor. The students participated in the interface as guests, a way of interacting which granted them only opportunities to interact with existing structures and objects, not the capability to build their own objects and spaces. Thus, the students were more like tourists/voyeurs, and their experience was shaped by a limited ability to code and shape the interface. After the students proved more apt at negotiating and learning MOO coding and culture in a short period of time than initially hoped, the second course seemed an ideal time to assign students more extensive abilities to build rooms and objects.

In the second class, Humanistic Research Methods in Communications (spring 2004), the project was intended to help entry level graduate students learn the importance of situating themselves and to problematize subject—object relations in Research Methods. For the MOO Ethnography and Research Methods assignment, students were asked to build rooms and explore the MOO. The site was LinguaMOO. At various stages of the MOO ethnography, students were asked to program objects and items to illustrate theoretical concepts and personal location in relation to their objects of inquiry. After the exploration and building stages were done, students were to form groups and write research proposals based on their examination of the MOO and

understanding of various methodologies introduced in the course. The rationale for the use of the MOO in this manner was explained using the following quote from Jenny Sunden:

Even though the border between physical and virtual locations is continuously crossed in online experiences, there is also a separating distance between the two. This distance is on one level introduced in text-based online worlds through the act of typing, and further reinforced by the mediating computer technology itself. By actively having to type oneself into being, a certain gap in this construction is at the same time created. The mediation between different realms, the very creation of texts by the means of computers, makes the interspace that always exists between myself and the understanding of this self particularly clear. Following the idea of a subject that can never have a direct and unmediated access to herself, that the I writing and the I written about can never be seen as one, cyber subjects are always at least double. This distance can in a similar way be used for methodological purposes, to form a reflexive understanding of research procedures and of the way that oneself as a researcher is always intertwined with these processes. It can be used to create room for reflection on how I, the researcher, am not only a producer of texts, such as this one, but also always a co-producer of the reality that is being written.

(Sunden, 2003)

Along with the MOO assignment we were reading essays on communication and critical theory, critical ethnography, feminist epistemologies, post-colonial theory, and the books “Virtual Materialities” by Jenny Sunden and “Object Stares Back” by Elkins.

#### 4. DISCUSSION OF ISSUES RAISED BY STUDENT PROJECTS AND THE PEDAGOGIC STRATEGIES

Specifically for this analysis we’re going to focus on one pedagogical situation that utilizes the MOO.

The MOO has three important attributes. First, it is a text-based environment. It is also a multi-user domain and an object oriented space. This means that the MOO is not merely a chat space like AOL Instant Messenger. The MOO interface is predicated on building text-based virtual locations and objects to serve as the context of interactions between users. Although LinguaMoo (<http://lingua.utdallas.edu>) allows for some images that can be used as backgrounds or character or object icons, the space is navigated primarily by text entered by the user.



It should be noted that the text-based MOO is a comparatively older technology (even though Lingua MOO has a more current web-interface, it is important to note that most of the object building/programming and interaction with objects usually takes place in the text-based, text-coded environment). MOOs are used consistently in English classes that teach writing skills. However, students in both communication studies classes were unfamiliar with it and did not understand why we were using it. This lack of familiarity with the software or the specific LinguaMoo interface is important to the production of the self in a particular online context. The lack of familiarity produces a contested dynamic techno-mediated space, unsettling notions of digital technology as fostering immediacy and efficiency in a world defined by the rhetoric of “Progress”. Not only are these in-between and dynamic in-formation spaces in the way they are used, in allowing for uncertainty of participant experience and encounter, they are also sites for the explicit contestation and negotiation of co-produced and technologically mediated meaning-making processes and of the pseudo-binaries of “Virtual” and “Real”. Further, the fact that MOOs require the user to establish an avatar and description for their character creates, as Beth Kolko points out, “explicit engagement with identity . . . [that] makes them fertile ground for exploring how identity and interface interact.” (Kolko et al., 2000: 214).

It should be noted that theorists such as Kali Tal have suggested that cyberspaces usually suffer from an “unbearable whiteness of being”. Because most online environments (including LinguaMOO) do not explicitly include race as an avatar characteristic (unlike gender), race is not an automatic character attribute. The following explanation of gender on a MOO is taken from Lingua MOOs help menu. Note that there are various possible “genders” offered.

```
Syntax: @gender <gender>
```

```
@gender
```

```
The first form, with an argument, defines your player to have the gender <gender>. If <gender> is one of the standard genders (e.g., `male', `female', `neuter',...), your various pronouns will also be set appropriately, making exits and certain other objects behave more pleasantly for you.
```

```
The second form tells you the current definition of your player's gender, your current pronouns, and the complete list of standard genders.
```

It should be noted that some of the ``genders" on the standard gender list need verb conjugation in order to work properly and much of the MOO isn't set up for this (...yet). For example, you should expect to see `they is' a fair amount if you @gender yourself `plural'. Your gender is currently female. Your pronouns: she, her, her, hers, herself, She, Her, Her, Hers, Herself

Available genders: neuter, male, female, either, Spivak, splat, plural, egotistical, royal, or 2nd<sup>4</sup>

However, as Kolko and others have noted, the MOO does not allow the user to set a "race" category. Kolko writes, for instance, "in the case of textual worlds, race tends to be missing as an element of virtual identity" (Kolko et al., 2000: 214). In her work, she describes, "how race as a category has been elided in such media through various design choices," while investigating "how the construction of 'raceless' interfaces affects the communicative possibilities of virtual worlds". She goes on to describe efforts at reintroducing race as an articulated notion on MOOScape in order to "ask how an explicit marking of race online might affect the social environment".

Because of work done by previous researchers on race in cyberspace, we have come to understand that in many online environments, explicit mention of race becomes an anomaly, unless used as a particular kind of identity tourism (Nakamura, 2002), for which it is employed nearly completely stereotypically. In fact, Kali Tal goes as far as to assert that

In cyberspace, it is finally possible to completely and utterly disappear people of color. I have long suspected that the much vaunted "freedom" to shed the "limiting" markers of race and gender on the internet is illusory, and that in fact it masks a more disturbing phenomenon—the whitening of cyberspace. The invisibility of people of color on the Net has allowed white-controlled and white-read publications like WIRED to simply elide questions of race.

(Tal, 1996)

As critical race theorist Adrian Piper demonstrated with her "calling card" performance art, the explicit introduction of race counters cultural expectations that race should remain unremarked. Because the MOO interface elides racial identities, the introduction of race by participants could conceivably be considered "socially inappropriate" in the same way that the very

“white-looking” mixed race Piper experienced any self-reference to her racial identity:

Dear friend,

I am black. I am sure you did not realize this when you made/laughed at/agreed with that racist remark. In the past I have attempted to alert white people to my racial identity in advance. Unfortunately, this invariably causes them to react to me as pushy, manipulative, or socially inappropriate. Therefore my policy is to assume that white people do not make these remarks even when they believe no blacks are present, and to distribute these cards when they do.

I regret any discomfort my presence is causing you, just as I am sure you regret the discomfort your racism is causing me.

(Piper, Calling Card #1)

Piper passed out the calling cards in a variety of settings as a performance art piece, disrupting the comfortable elision of her own racialized self. In addition, at exhibitions Piper made the calling cards available and encouraged others to use them, regardless of their racial self-identity. Piper’s goal was to move away from essentialization of race as a static category of identity or as an articulated notion, while at the same time draw attention to discrimination based on particular racialized identities.

In employing the MOO pedagogically, our goal was not so much to reintroduce race-as-an-articulated-notion as a textually recognizable label or category, as it seems to have been in Kolko’s invaluable experiment, but to engage the apparent invisibility of being raced, in the way of Adrian Piper’s work, specifically in online textual environments. Our strategy was to create a racial awareness implicitly and explicitly in our face-to-face class environment. In an effort to refuse to allow race (and other nuances of identity grounded in the body) to remain unremarked, students entering the MOO textual environment had been sensitized to issues of race, sexuality, geography, and class within the face-to-face classroom environment, in face-to-face group discussions and through class readings. Thus, when they entered the textual environment the analytical and conceptual lenses they engaged in trying to make meaning of their encounters with the MOO—as their identity and MOO interface were explored—led them to be very aware of racial, sexual, and cultural codings in interpersonal and socio-economic contexts within both their daily lives and in their online activities in class.

Part of the goal of this project was to conduct auto/ethnographic observation and analysis of the ways that the self was produced at the intersection of the face-to-face classroom, MOO classroom, and MOO analysis. Although we are co-authors and collaborators, we occupy different points of entry in relation to the classroom experiment. Radhika is the faculty member who will

both grade all the assignments and has ultimate say on how the assignments are framed. She experiences her position of power in contradictory ways as both a woman of color in the U.S. academy and as someone who has had the privilege to deliberately follow non-traditional (and therefore often confusing and unsettling to students used to more mainstream, top-down ways) ways of teaching and assertion of power in her classes. She also very clearly understands and uses her privileged location in terms of the academic culture and literacy. In addition to being a graduate student who participated in the Research Methods class, Melissa has been a student in several other of Radhika's graduate classes that employed the MOO and other digital technologies in this self-reflexive way. In addition, Melissa assisted in teaching an undergraduate class that engaged the MOO. Although fully a student (receiving a letter grade and credit for the course) and an advisee of Radhika, Melissa is also engaged in ongoing research about production of the self and the use of technology to disrupt everyday notions of identity. Engaging the research process from these two different participant perspectives is a key strategy of the cyber-ethnographic methodology employed for this research (Gajjala, 2004).

#### **4.1. Unsettled White Male Privilege?**

“The very idea that a mediated form of communication technology could serve to disguise identity and even prevent those of privilege from asserting their identity (particularly white, European-American males) became a center to my engagement with course materials. . . . Such technology has shown to have the ability to disguise one's true identity . . . . The main issue underlying all of this is that there are certain forms of technology within the realm of communication that in some form or another make it difficult for people to assert their physical identity.”—“Ray” graduate student in Research Methods Course.<sup>5</sup>

What is interesting to us here is that Ray's experience does not match what theorists such as Kali Tal would suggest about whiteness as the default category of identity in cyberspace. Ray failed to realize that even though the visible physical markers of his identity are not present, the seemingly ubiquitous white maleness in cyberspace marks him with the unmarked default category of white male. According to other research on race in cyberspace, we should expect his privileged race/gender position to be preserved even though HE cannot see himself that way—he is still going to be read that way. Our research suggests that the “whiteness of cyberspace” functions as an extension of the whiteness of everyday life that Adrian Piper's work examines. In addition, a closer look at how race was used and functioned in this classroom environment shows that:

1. The function and definition of race and privilege is radically dependent on the context and specifics of the interplay of online and offline spaces that are being considered.
2. Multiple understandings and experiences of race are employed in online and offline spaces with which they intersect.

To understand his experience, we have to look at the real world context in which he engaged the technological interface—as described above, the classroom context was designed specifically to try to counter the insistence that race remain unremarked. First, the visible identity markers of the instructor, which identify her as a third world woman of color. Next, the context of the course readings were heavily influenced by critical theory and post-colonial feminist theory. Third, we have the makeup of the classroom participants—Ray was one of only two white males, and the other class members included three international students (two Chinese and one Indian), one African-American and one “out” lesbian, and several straight appearing white women, all of whom were fluent and articulate in the theoretical language of post-colonial feminism and critical theory used in class readings.

We see from the beginning that the MOO was “Rad-eee-ka’s MOO”—most students couldn’t pronounce Professor Gajjala’s first or last name. Thus, the space became racialized in a very particular way. Students were required to program an object that would illustrate a concept coming out of the readings, and then asked to analyze the effect of the object they programmed. This created a reflexive space.

Because of the context and design of the real life space in which students encountered the MOO, the MOO space was racialized, creating a reflexivity on the production of the students’ own racial identities (and other characteristics of identity) in the space.

“I’m sitting in front of this terminal trying to figure out what in the world I’m supposed to be doing for this class. What are these commands? I’m supposed to create a home? I’m supposed to generate artifacts that represent me? I can’t figure out the basic functions of this MOO. I hate this assignment.”—“Ray”

This student goes on to describe how he would rather use the Moo at home even though his access is an older, super-slow, dial-up connection, compared to the relatively speedy direct connections he could access at the university computer lab. His anxiety about identity and meaning manifest themselves in this choice, evoking not just the absence of visible physical cues about his everyday self, but also the lack of validation of his identity that he is granted from others in his everyday life.

“Here, I have the smell of home, the taste of my wife’s cooking, and the security that she is there for me. She knows who I am—she can see me, she understands me, and she knows all of my quirks.”—“Ray”

In addition to this idea of the way the MOO was raced/affiliated in this context, we see how critical it is that students were unfamiliar with this technological interface. The technological interface, because of its design, can force us to negotiate cultural cues that function differently in familiar everyday life. This can make the process of producing the self visible.

“A personal encounter with a technology that strips me of much of my everyday privilege. This is a way to sum up my personal encounter with the MOO. Let me explain—I am a white, European-American, male, of middle-class status. These very marks of identification have been taken from me during this encounter . . . I noticed my desire to assert some sort of privilege on this technology. Can’t they see I’m white? Can’t they see that I’m male? Can they see anything about me at all? I couldn’t seem to produce the privilege that I seemed to take for granted.”—“Ray”

Ray’s is also a kind of racial anxiety. What we observed was how he was more anxious about the presence of his body than someone who was more confident about his ability to communicate wholly through text might have been. After examining some of his responses and articulations, we wondered if his anxiety around the absence of his white body to assert his privilege in a social space may have been linked to his obvious struggle with academic articulation. Thus, while his own analysis of his encounter with the anonymity of cyberspace *via* the MOO might suggest that he was a white male—privileged in many ways in comparison to other students in class, he may indeed have been slightly more disadvantaged in terms of particular kinds of academic or cyber-literacy when compared to some of the other students who may have appeared more disadvantaged socially based on their race-based, gender-based, sexuality-based, and geography-based locations.

Lori Kendall states that

[C]lass background may be the single most important factor influencing online participation. Over 60 percent of internet participants (63–75 percent, depending upon the data source) hold some form of professional, technical, managerial, or other white collar job . . . Yet in their depictions of interactive forums such as muds, online researchers rarely discuss class, usually focusing instead on gender. This tendency reflects online culture itself, where gender and sexuality are much more frequent topics of discussion than class or race identity.

(Kendall, 2002: 183)

If race is expected to be an invisible category, in everyday life and in cyberspaces—class is even more so. Both these categories are often subsumed under discussions of the “digital divide”, where the specifics and complexities of race and class in relation to the internet examine issues of access and literacy in non-problematic ways as purely economic, geographic, or a combination of both (as in, “the poorer regions of the world experience the [singular] digital divide”). In actuality, both existing connected populations as well those who are on the unconnected edge of the digital divide are variously raced and classed, and likewise have varying cultural competencies in different online spaces. The particular pedagogic process we engaged in here were designed to reveal the complex interplay of race, class, sexuality, gender, and geography in relation to the negotiation of online environments. As is visible in the two examples discussed, issues of literacy, access and class were as much a factor in the production of hierarchies as race and gender.

Thus, we used a practice of pedagogy that relies on dislocating students out of privilege, then asking them to reflexively analyze the loss of privilege and the everydayness of the privileges they experience. This practice resulted, as we will see in the next example, in helping students articulate the different cultural competencies and literacies that impacted their experiences in the VLE.

But how might this pedagogy of dislocating students out of privilege work with an Asian female student who had come to the United States to study only about a year prior to taking this course? What sorts of privilege or lack might this encounter reveal in relation to her? In what ways does her gendered, classed, and raced experience reveal the nuances of techno, academic, language, or other literacies that impact virtual learning environments?

Yahui Zhang, a female Chinese student in the class was very silent when the MOO assignment was first introduced as a requirement. Her non-verbals indicated that she was not particularly happy. As it turned out, she later went to meet the instructor in an effort to learn to “MOO”. During this meeting, she gently questioned the need for the MOO exercise in a course that was supposed to be about “research methods”. Upon being asked if she felt angry at being asked to do this assignment and if she could she please articulate that anger in discussion *via* the online course discussion space so that we could raise the topic in class discussions, she did so. Below, we reproduce the post that she contributed regarding her response to the MOO.

**Subject:** Power and new literacy

I have always considered myself to be literate because I can not only read and write in my native language, Chinese, I am also quite proficient in English. However, my literacy is completely challenged in the MOO world because here I don't know the codes, the commands, and the icons.

Suddenly I realize that I'm illiterate in this world. To be confident, I have to learn the MOO language which takes time. I feel kind of embarrassed for sleeping all the time in MOO. Not only that, I accidentally built my room in auntpearl's room and infringed on her private space. To make things worse, I even didn't know that I was sleeping in somebody else's room right from the first day I had a room in the MOO. Now with the help of the patient professor, I was able to apologize to auntpearl and move my room to my territory. The technological illiteracy (not knowing the MOO language) renders me powerless in this already built and sophisticated world. My impotency makes me suffer from inferiority complex and unnamed anger. Never before have I felt so stupid for a course I' took. I feel angry with myself and the MOO. I am angry with myself because after several attempts to explore the MOO world, I still feel as almost dumb as the first time and I don't seem to make any progress as far as understanding and mastering another language is concerned. On the other hand, I feel angry with MOO because it is MOO that makes me feel stupid and inadequate.

My frustrating MOO experience leads me to the thinking of power structure in terms of entry for the time being. In an already established power structure, the order of entry does matter. The later you come, the more puzzlement you have to experience and the more failure you have to endure. However, there is still some hope. My present situation reminds me of a book *Woman/Native/Other*. Somewhere in the book, the idea of using the master's language to defeat him is discussed. Whether it is an appropriate analogy, there is the hope for me to know the language and use it for something good. Actually, I did some ethnographic work on my mother's and sister-in-law's life and I'm still working on it. Although they come from different educational background (While my mother is completely illiterate, my sister-in-law can read and write), both of them feel inadequate in articulating their voices. They entrust me with the job of telling their stories, stories of ordinary, everyday Chinese women to the audience in the West. Thus, I become the agent of their voices in a foreign land where I have to constantly struggle with my place of belonging. The world of academia to them is what the world of MOO to me. But here, I cannot find an agent to do the talking for me and I have to make it out myself (Yahui's post ends here).

*diaspora now is writing diaspora in her own abode—developing practices and literacies for coping with this situation. . . .* (part of the instructor's response to Yahui's post) Yahui certainly got the point of the exercise!



Using the methodology we have developed in this project (reflexive, participatory, and autoethnographic) for studying virtual learning environments has multiple benefits—one of these is that we can understand how the learner herself experienced the socio-cultural space we are studying. Yahui's reflection on what happened for her in the MOOspace reveals nuances we could not have surmised from watching the product of the socio-cultural exchange. In addition, asking students to reflexively consider their experiences in virtual learning environments creates opportunities for the learner herself to better understand the ways that privilege and power are nuanced.

In Yahui's case, understanding the MOO encounter was about considering "power and new literacy". She uses literacy in more than one way in her explanation—and her careful articulation makes it clear that to understand how race, privilege, and power interact in VLEs we must reach for a finely nuanced analysis.

It is obvious both from Yahui's participation in class and from her carefully written post quoted above that she is highly literate in English as a language. Additionally, we can see her fluency (or literacy) with academic language, the language of theory. In fact, Yahui's position as a non-native, Chinese woman living in diaspora made her feel comfortable in a classroom steeped in the language of post-colonial feminism, and we saw this proficiency both in classroom discussions and in her written work.

In Yahui's case, however, she cites two other kinds of literacy that need to be considered in order to fully understand her experience on the MOO. First, she suggests that her lack of comfort with the particular technology, her "technological illiteracy" with the language of the MOO, makes her feel angry and uncomfortable—lost in a world without the right language. Although Ray clearly expresses similar feelings of inadequacy and frustration (and in fact nearly all students first introduced to the MOO in this classroom said the same, including the student co-author of this chapter), Yahui's post articulates this frustration as technological illiteracy.

In later assignments, Yahui realizes even one more kind of literacy that impacts her experience on the MOO—her literacy with the "soft parts of American culture". A world traveler who is extremely fluent in both Chinese and English, who has studied life in the United States and has been teaching students to be prepared to successfully communicate in U.S. English for several years, pop culture references in the MOO made her feel like an outsider—lost not only in the MOO techno-language but also in the everyday culture references used as students built objects that referred to popular bands, movies, TV shows, and so on. As a student who is native to the United States, not living in diaspora, and the same race as most of the students in the class, the student co-author of this chapter and Yahui had similar experiences—it took her half a semester to realize that *auntearl* as a screen name was a reference to the band Pearl Jam. Thus, "literacy" in soft culture is not necessarily based just in nationality and race.

The ways in which Yahui nuances literacy can help us build a framework for analyzing what happens in VLE. When we juxtapose Yahui's varying literacies with Ray's, we see a complex interaction of cultural competencies and/or literacies that allow/produce privilege at the intersection of cyber/real spaces in the classroom.

## 5. CONCLUSION

*Although subjectivity is grounded in the body and the way that body moves in the world, the identity markers culturally available to us to use to remark those differences cannot adequately help us to understand or theorize those differences. The power of the MOO exercise is the way it reveals differences that are about not just race, skin color, gender, or some other standard category, but also get to the heart of questions about subjectivity and cultural competencies—which can have as much, or more, to do with our experiences in the world and the way we negotiate them as do oft essentialized constructions such as race, gender, sexuality, etc. The MOO is no more “artificial” than the real world—in each we take ourselves (the accumulated history and bodily materiality that makes up the person) into a pre-existing cultural/social structure and try to produce a self that reflects what we understand about ourselves. Like face-to-face interactions, we are more or less successful based on what we bring with us, what our materiality offers us, the structure of the interface, our cultural competencies, and the others with whom we interact. Technological mediation of race and racial anxieties, like everyday meaning making, is nuanced in the situation, in the culture, AND in the individual (From Melissa's MOO autoethnography).*

Virtual Learning Environments offer great opportunities to develop innovative pedagogies, as well as plenty of challenges for researchers trying to understand and theorize these interactions. This work attempts to begin to expand our existing understanding of how race functions in cyberspace, as well as to help us to develop a working vocabulary that we can use to theorize and explain the intersections of real and cyberspaces that become more common everyday. Three important considerations found here include methodology that engages the process and experience of the user/learner, consideration of the physical, local, theoretical, and academic context in which the VLEs are engaged, and nuancing our understandings of specific cultural competencies that impact the production of subjectivity and socio-cultural interaction in VLE.

Firstly, it is important that the methodology of studying virtual learning environments that we use engages the process, not just the “outside gaze”. Although a great deal can be learned from looking at transcripts from interactive spaces like MOO and chat as well as examining e-mail and other static texts, understanding the subjective experience of the participant is vital to effective

analysis of cultural creation and interaction. By engaging in the production of culture and subjectivity, the researcher can develop a more finely tuned understanding of the ways that meaning is being made in a particular context.

Secondly, to understand the way race, gender, class, and other characteristics of identity work in virtual learning environments, we must contextualize the analysis by considering the intersection of cyber/real spaces, the everyday context in which users access the virtual learning environment, and the specifics of the classroom context of engagement in cyberspace. Because of the way in which the self is *produced* in VLE, our understanding of these categories of identity need to consider the ways that that identity will be constituted *in the context of* and *in response to* a specific context. While Ray's physical body looked and moved the same in the world before and after his MOO experience, the carefully contextualized MOO exercise offered each learner a way to reflect on how privilege is built and maintained in varying cyber-and real-spaces. Unlike MOOs researched in other contexts—race did not remain unremarked or unconsidered. Although it is important to consider the technological features of VLEs such as design and synchronicity, it is also important to consider how specific VLEs intersect with real life learning environments often seen as discrete and distinct from VLE.

Lastly, when considering race and other characteristics of identity in cyberspace, it is important to look at the specific cultural competencies and literacies that produce/allow privilege(s) at the intersection of these cyber/real spaces. To understand what goes on in VLEs, we must consider the ways in which particular subjectivities are produced and maintained by multiple cultural competencies and literacies.

#### ENDNOTES

1. The authors wish to thank members of the courses—Computer-mediated Communities (Spring 2002) and Humanistic Research Methods (Spring 2003) for permission to use their assignments, discussions, and insights. We also thank Chris Bollinger and Yahui Zhang (both Radhika Gajjala's doctoral advisees) for their valuable work connecting to the larger project of which this article is a part. See also the publicly available blog discussions at <http://cyberdiva.typepad.com/coauthoringproject/>
2. In online contexts, text can be static and frozen in time on website and blogs and listproc archives, while during interaction, whether synchronous or asynchronous, the same texts appear “live” and dynamic to users. This is why we use the notion of static text as opposed to text in production in this instance.
3. The examples taken are from Radhika Gajjala's courses. While the general discussion spans a period of approximately 7 years and include courses taught by her in Bowling Green State University since Fall 1997, the

specific examples are based on three courses—Computer-Mediated Cultures and Organizations (undergraduate), Performing Digitally Mediated Identities (undergraduate), Computer-Mediated Communities (Graduate), Humanistic Research Methods (Graduate). Melissa Altman was a student in the graduate courses and assisted Radhika in an undergraduate course.

4. This excerpt was taken from Lingua MOO's help menu on gender.
5. In this section, we have not used the real names of some of the students we are discussing. We do however have their permission for use of their assignments in scholarly publications.

#### REFERENCES

- Gajjala, R. (2004). *Cyberselves: Feminist Ethnographies of South Asian Women*. London: Altamira Press.
- Gajjala, R. (2000). Internet constructs of identity and ignorance: "Third-world" contexts and cyberfeminism. In: Pagnucci, G. and Mauriello, N. (Eds.) *The Future of Narrative Discourse: Internet Constructs of Literacy and Identity*. (Works and Days, 17/18), 33–36.
- Gajjala, R. (2001). Studying feminist E-spaces: introducing transnational/post-colonial concerns. In: Munt, S. (Ed.) *Technospaces*. London: Continuum International, 113–126.
- Kendall, L. (2002). *Hanging Out in the Virtual Pub Masculinities and Relationships*. University of California Press.
- Kolko, B., Nakamura, L., & Rodman, G. (2000). *Race in Cyberspace*. New York and London: Routledge.
- Munt, S. (2001). *Technospaces: Inside the New Media, London*. New York: Continuum.
- Nakamura, L. (2002). *Cybertypes: Race, Ethnicity, and Identity on the Internet*. New York and London: Routledge.
- Tal, K. (1996). The Unbearable Whiteness of Being: African American Critical Theory and Cyberculture. Available at: [www.gse.buffalo.edu/FAS/Bromley/classes/socprac/readings/Kali-Tal-unbearable.htm](http://www.gse.buffalo.edu/FAS/Bromley/classes/socprac/readings/Kali-Tal-unbearable.htm) (Last accessed 2004).

## Chapter 43: Engaging the Disney Effect: The Cultural Production of Escapism and Utopia in Media

PETER PERICLES TRIFONAS

*Professor at Ontario Institute for Studies in Education, University of Toronto*

### 1. WHAT THE SIGN OF DISNEY TEACHES

What does the sign of Disney teach? What are the sources and openings of its symbolic violence? Its effects? The extent of its pedagogy? How does Disney inform the subjectivity of culture and the living text of social practices? In short, how can we engage the symbolic violence of the sign of Disney and its effects?

I will now begin to take up the question of the relations between the media, education, and the empire of signs as sites of socio-ideological contestation and cultural reproduction.

In a recent book, *The Mouse that Roared: Disney and the End of Innocence*, Henry Giroux (1999) analyzes the intentionality of corporate culture-making. That is, the “organization and regulation” (p. 2) of a political economy of signs as driven by a multinational media conglomerate that touches and teaches the everyday lives of children and adults alike. *The Mouse that Roared* presents a critical yet balanced view of the educational force of “[m]ass-produced images” (p. 2) that inform the “most intimate perceptions and desires” (p. 2) of our daily existence. As Giroux (1999) quite correctly explains, it would be too easy—unfair and unethical—to concoct conspiracy theories portraying Disney as “part of an evil empire incapable of providing joy and pleasure to the millions of kids and adults who visit its theme parks, watch its videos and movies, and buy products from its toy stores” (p. 4). There is an inconsolable temptation to overdetermine and therefore to overstate and simplify the efficacy of its role as an active agent of truth construction and a purveyor of a pedagogy of diversion. But there is also another side to gauging the influence of such an enormous media and entertainment company and investigating the way the signs it produces have functioned to educate the cognitive and affective dimensions of subjective agency in the shaping of popular culture. By using a critically balanced approach, Giroux (1999) provides the theoretical and methodological grounding and analytical framework for examining the ethical and moral force of Disney and its rendering of culture as a byproduct of “media culture” without dismissing the complicated value of its “public pedagogy” (p. 4) as a means of constructing a pleasurable escape “from the drudgery of work” (p. 5). The veneer of images Disney spins out simulates reality and stimulates the imagination. It garners responses. Here we must probe

beyond the surfaces of corporate signs to show how the logic of representation is thoroughly and deeply infused with traces of ideological force and political power. Disney's illusion is neither naïve nor innocent. As in all means of media production and representation, there is an element of intentionality involved. However, the creative impetus of the means of representation is neither technical nor technological as much as it is an instance of artifice that is poietic in nature. This extensional production is a neglected or understated aspect of media. It produces something other than the technology of itself, that is not remote controlled by the technology itself. We could not even call it technological because it is an independent production of meaning spawned from its interpretable nature. The medium is the message. Yes. Marshal McLuhan was correct in this observation. But the medium therefore becomes transparent, that is put in the background, forgotten, in its purely instrumental role as the visible reflection of content. A message has to be produced on a fundamental level to justify the conceptual and material resources expended to facilitate the attempt made at communication (Trifonas, 1998). What is the point of representation if not to engage the other in a reciprocal act of meaning making? This obvious fact of communication theory allows us, like Giroux (1999), to turn our attention to how the ideological impetus of this political economy of signification that Disney engages in facilitates the subjective interpretation of its signs. That is, how it is possible for a corporation to use the media as a pedagogical tool or device in order to convince the public of the redeeming cultural value of its idiosyncratic point of view. The effects of this form of expression constitute the real moments of teaching and learning: In short, they are (mis)educative in nature.

## 2. DISNEY AND THE CULTURAL IN-CORPORATION OF SIGNS

Disney is a part of a culture industry that runs rampant. The projections of its media exact immeasurable influence on minds young and not so young. It does not discriminate between those possessing innocence and those wanting knowledge in the age of consumer-oriented global economies where the instant gratification of subjective desire is driven by the digital mantra of the day. The sign defuses agency as much as it activates and mediates for responsivity. So it should be of no surprise that the culture industry treats the psyche of the neophyte and the mature reader of cultural phenomena quite equally—with the same amount of discourtesy when it comes to arbitrarily evaluating and commodifying the signs of culture through the media and its simulations of reality. To yoke ethics with representational concerns is only natural for critical educators: For those who practice pedagogy with a body and mind set to raising human consciousness toward the effects of the symbolic violence of signs upon our everyday practices. Especially, if we consider a sign to be an image that we learn through, about, and from. For those who participate in

and run the culture industry, it is a means of focusing and obsessing subjective desire in an economy of intellectual and material self-fulfillment based on an empire of signs whose terms and values are to be worked out and actualized at any and all costs. Effects are rendered more crucial than causes. Representation cannot take place without consideration given to the beginnings and ends of response—that is, to meaning making and the consequences of realizing the vision and presence of a possible world emerging from it. As Umberto Eco (1979) has pointed out, a sign has no analogous, motivational, or correlational link with what it represents in reality because it is arbitrarily produced and mediates for our understanding of reality by being an *interpretant* of experience, an idiosyncratically constructed mental tool used to reference and understand the world. The sign is all surface, all projection, all image: Complete in and of itself and for itself. Thus, it has a directive force of its own that defies the reciprocity of a two-way model of communication. It sends the logic of itself and attempts to make plain its *raison d'être* for all to see or perhaps to miss. It re-presents information and dissimulates reality through its power to initiate and sustain a form of symbolic violence upon those who engage in, create and apprehend, the values of the sign as a model of reality. That is, the semiotic force of its re-presentation of information or content enhances the effects of its message as the effects of the sign are internalized and reflected by the viewer/consumer of the image. The viewer/consumer cannot alter the form of the sign but only imbibe and complete its intentionality by aesthetic and cognitive, conscious and unconscious responses in relation to the image. On the one hand, the sign in itself is therefore intransitory, both subject and object, and needs no mediative completion by way of a subjective predicate that puts its meaning into action. It suffices as the symbolic representation of meaning itself. It is readily interpretable. The sign stands for itself and requires no mediative injunctions. On the other hand, because the sign is its own pedagogy, it teaches, but it needs a viewer/consumer to fulfill the intentional and extensional limits of its communicative potential as a meaning-making tool.

Disney's signs are neither innocently conceived nor haphazardly constructed. And we would be naïve to think so. It is in and through and within the political economy of these contradictions produced between sign/meaning correlations, between surface image and deep sense, between imaginative production and interpretative completion, that a corporate agenda can be mystified by overdetermining and therefore complicating—exacerbating yet also simplifying—the tensions between the creative production of subjective responses and the contingency of an interpretative direction upon a media image. For example, it is ironic that Disney calls upon the subject to enact a productive resistance to the adult world of work and the moral banality of the self-absorbing capitalistic drive to achieve social standing through economic status. It more or less denounces the ethical validity of this way of thinking by endlessly reworking themes of escapism and utopia that glorify the attraction

of adventure and the joys of play. The altruism of this message however is worth interrogating on its own grounds, the grounding of its own reason. An appeal exhibited and made to such counterlogic of cultural praxis is intended to activate and drive human behavior, through desire, toward the imaginative actualization of a possible world of unrealized childhood hopes, wishes, and dreams in the name of innocence, fun, and purity. After all, who can argue with the pursuit of innocence, fun, and purity as the way to find happiness in life? Since Plato, the quest for happiness has been culturally and philosophically linked to the uncovering of pure and ideal forms of being. That is, the search for happiness is entwined with the ideal ethic of striving for a state of goodness beyond being. This means rejecting the life world as delusional, an evil simulacra, a flawed education guided toward the supplementation of nature and childhood innocence. This Platonic philosophical dreamscape is the cultural site of Disney's appeal and the affective source of its emotive power and value. It suspends, if even for a short while, the "broader American landscape in which cynicism has become a permanent feature" (Giroux, 1999: 6) and takes advantage of the image of a childhood utopia lost both from within and without. In this sense, Disney functions as an arbitrary mediator of cultural memory and value by enabling a reductionistic reading of reality that is focused and worked out along the lines of images that harken back and reinforce the archetypal vision of an edenic world without subtlety, bereft of evil and of limits, in which anything and all is possible. It teaches by example rather than through example. Disney demands nothing less of its consumers than a psychic capacity to let go of the present and dream of an "other time", a better time when reality could be read like an open book through the eyes of a child. Its existence is tied to this illusion of the possibility of an escape to unmediated sources of experience and reality that it constructs. Disney expects of the subject an unreflexive mimesis of its ethos of ideal remembrance and the phantasmagorical representations of a possible world that reduces the complexity of reality to a binary and hierarchical formula pitting good against evil. We might call this opposition the categorical imperative of Western culture (Trifonas, 2000). You either agree with its precepts or you do not. If not, then you are marginalized and othered as an outsider. Choosing sides *should be* easy because it is obvious that good is preferred over evil. Teaching the utopic landscapes of Western cultural memory is therefore simple for Disney as what is lost of the past must be regained and reproduced via the mnemo-technical procedure of a pedagogy of unquestioning recollection that requires a repetition without difference. There is no supplementation of the signs of memory. Form is content. The difference of interpretation is pre-empted by an oversaturation of the sign that is intended to flatten out meaning. Disney provides the semiotic means for an escape reality via a psychic and material construction of the "good old days of childhood in middle America". But the mediative completion and objectification of such a reality is intended to result in the transformation of the



public sphere by making things simple, transparent, and obvious. Its Western cultural and philosophical bias assumes that we will all respond in the same way.

For example, the “nostalgia machine” of Mickey Mouse and his pals, sometimes goofy, but sometimes heroic, counteracts the debilitating effects of pessimism by tempering its perspectival liminality with the hope of a better world, a better place, or “that which extends beyond what the market and commodity-crazed society can offer” (Giroux, 1999: 6). Disney creates the physical and emotional pre-conditions of a “wish-landscape” (Giroux, 1999: 6) by situating the desires of adults and children in exotic settings where powerful themes such as “survival, separation, death, and loss” (Giroux, 1999: 7) come alive through the serious play of imaginative renderings of epiphanic experiences and fictional recreations of the life world in the way it should be. As a moment of teaching and learning, the “Disney effect”—and we must call it that—is thoroughly escapist because it induces an excitement of mind and spirit not essentially rooted in the spontaneous and mundane phenomena of reality. The distraction of enchantment depends upon a vicarious thrilling of subjectivity—a dislocation of being that feeds off of estrangement and produces the need to make the moment of living meaningful (truthful) again. The Disney effect is a heightening of experience that is a simulation of reality and therefore a manufactured occurrence aiming at an ecstatic reaction achieved by the suspension of disbelief. The intellect knows that there will be a “swindle of fulfillment” (Giroux, 1999: 6), but nevertheless is willing to play the game for the sake of distraction. It is willing to undergo its “mixture of alienation and pleasure” (Giroux, 1999: 7) simply for the sake of encountering an “other moment” of being that is completely reflexive to the sources of itself, an epiphany of sight and sound beyond common experience, and in some instances even beyond common sense.

Succumbing to the rapture of Disney culture demands a material, ethical, and psychic investment in the dream of the possible world Disney represents and projects. Giroux (1999) reminds us that “there are no passive dupes in this script” (p. 7). The act of submission has its price, so to speak, beyond the monetary gains of a megacorporation providing the pre-conditions for “play therapy” to those who choose to take up its offer. And it is here that we find the crux of Giroux’s (1999) distaste for the media centered pedagogy of Disney:

How audiences interpret Disney’s texts may not be as significant as how some ideas, meanings, and messages under certain political conditions become more highly valued as representations of reality than others—and further, how these representations assume the force of ideology by making an appeal to common sense while at the same time shaping political policies and programs that serve very specific interests . . . .  
(p. 8)

Giroux (1999) tells us, much like Edward Said, that “the forces of cultural production and reception are not equal” (p. 9). And they could not ever be. There is a concentration of energy expended in the technical production of images and texts, but this conscious intentionality does not cancel out the independent purposes of interpreting what these images and texts signify and mean when mobilized and circulated through the public sphere by the processes of media in order to promote a response and convey a message. The problem of the social construction of meaning therefore involves questions about the mediation of reality and the political implications of how representation practices bear on cultural practices. Giroux (1999) delivers indispensable insights for media education by providing a “set of tools [in *The Mouse That Roared*] that enable [readers] to inquire into what Disney represents, in a way that they might not have thought about, and to shatter common sense assumptions regarding Disney’s claim to both promoting fun and games and protecting childhood innocence” (p. 8). The point of such an approach is not so much about how to do ideology critique as it is about re-evaluating the pre-conditions of norms that are propagated through the channels of the media apparatus and its seemingly benign technologies of reason. The appeal to common sense and its conservative pre-suppositions inform the traditional conception of education in the public sphere. Disney is a part of that machinery that puts an end to the innocence of representation and communication—not that it ever was!—through the cognitive and aesthetic constellations of the signs it disseminates via the media of popular culture. Common sense is a powerful deterrent of innovation and difference and a determinant of the value of the proper, of tradition and its propriety (Trifonas, 2000). It depends upon a conception of an interpretative community as the abode of subjects who are the same, and without difference, think the same, hold the same desires, values, and ideals. Sense is therefore common, readily possessed and easily found. It is transparent and can effortlessly be agreed upon as the arbiter of universal truth. It puts up barriers against the intrusion of any competing interpretations by radicalizing different points of view as other, not commonly held, truths, that are therefore illogical, to be despised, and not worthy of expression. Questioning the accountability of corporations to the public and to the mandates of public education within a democracy, requires serious consideration of the implications of the appeals to common sense that Disney makes and objectifies through the signs, images, and the material manifestations of its media products and events within American cultural life.

### 3. TOWARD A POLITICAL ECONOMY OF THE SIGN OF DISNEY

The emphasis of *The Mouse That Roared* is on three interrelated points regarding a critical assessment of the role Disney plays (1) “in shaping public memory, national identity, gender roles, and childhood values; (2) in suggesting

who qualifies as an American; and (3) in determining the role of consumerism in American life” (p. 10). There is a pedagogical crux to the subject of the analysis that centers on the importance of finding ways to “democratize the media” (p. 12) by providing a means to interrogate the cultural politics of signs (Trifonas, 2000). Representation is always already ground in the logic of itself and what it tries to teach. Giroux’s (1999) purpose involves inventing and engaging in new modes of reading practice aimed at a critical reexamination of the role of multinational, media-based corporations such as Disney in the public sphere via the political economy of its signs. The ethical impetus of the search for methods of engagement aimed at the task of emancipation, social responsibility, and critical citizenship is what links pedagogy to democracy. *The Mouse That Roared* challenges us to rethink the innocence of Disney, the ground of how and what it teaches through the political economy of its signs. In it, Giroux (1999) provides a way to critically approach the “struggle over meaning and institutional power” (p. 11) by opening up to scrutiny the technologies of reason that mediate and produce the ideological conditions of meaning-making in the public sphere. That is, how the production of meaning is rationalized, grounded, and institutionalized, its processes disseminated and given the unquestionable force and power of common sense via the appeal to the socio-cultural and ethico-political value of universal truths. As media conglomerates invade the “noncommodified spheres of our public culture” (Giroux, 1999: 12) and intrude upon the private sphere of experience, the limits of the individual capacity for participating in social reconstruction are increasingly placed at risk. The overdetermination of the conceptual field of practice by commercial interests makes the imaginative constitution of “vocabulary and imagery available for defining, defending, and reforming the state, civil society, and public culture as centers for critical learning and citizenship” (Giroux, 1999: 12) more and more difficult. Although, as Giroux shows us in the *Mouse that Roared*, it is not at all an impossible task.

For example, Disney culture is fully invested in the concept of innocence. Its founder Walt Disney, realized the value of cultivating an image of purity that was centered and grounded in the “security and romance of the small-town America of yesteryear” (Giroux, 1999: 17). According to Giroux (1999), this semantic linking of image with content in the public consciousness has made Walt Disney and his company “synonymous with the notion of childhood innocence” (p. 17). The emotio-psychic influence of the corporation and the living expression of its values and ideals is therefore difficult to resist because the lure of Disney is rooted in a sentimental view of the American past that is cognitively and affectively grounded in the logic of itself. The appeal of a utopian cultural historicity secures, reinforces, and predicts the ideal of a future where anything is possible and happiness is “just around the corner”. But in order to find fulfillment in the promise of a return to the “golden days” of middle America, the memory of the past must be protected as a discreet image of human being because it is the source of identity. Giroux (1999) teaches

us how to read the mnemo-technical pedagogy of this signifying ground of cultural historicity. Disney makes a connection between entertainment and education so as to fuse together the public and the private spheres of subjective being and memory according to an image of innocence that “had to be constructed within particular maps of meaning in which children and adults could define themselves through a cultural language that offers them both modest pleasure and a coherent sense of identity” (Giroux, 1999: 18). It is a question of a corporation having power over the cognitive and affective mediation of signs and their historicity in the public sphere and more or less regulating the subjective production of collective of “popular memory” through them. Because of its film and television companies, its involvement in the radio and music industry, and the reach of its publishing empire, Disney cannot be anything but a “teaching machine” that exerts tremendous influence on the shaping of American culture. Its undeniable commercial success, Giroux (1999) reminds us, “represents, in part, the power of the culture industries to mediate and influence almost every aspect of our lives” (p. 19). By regrounding public memory in a celebration and remembrance of a utopian view of the American nation, nationhood, and its reliance on the nuclear family unit as the seed of childhood innocence and its source of knowledge, Disney reconstructs and transforms pedagogy into a public site of cultural practice worked out in relation to the mediation and representation of signs. The space and place of media representations is where the formation and transformation of subjectivity is directed toward the aim of continuing the social historicity of knowledge constructions through the disciplines and also reinforces acceptable models of behavior with respect to the role of the citizen in a democracy.

The problem is that the scene of teaching—as Disney redefines it by enjoining entertainment with education—comes to be permeated by commercial interests not necessarily motivated by or connected to principles of pedagogy. The appeal to the rightful innocence of the nostalgic quest to find the vestigial remains of the “inner child” masks the motivations of the corporate agenda and the madness of its economic reason that is happy to turn America into a toy store as Giroux (1999) puts it. How can we find this commercialization of ethics and values not problematic? Giroux (1999) alerts us to an obvious yet overlooked marketing strategy that Disney propagates with effective yet disturbing results. By equating learning with entertainment and the innocence of childhood and play, the corporate agenda is infused into educational goals since teaching and learning are linked to the commercial means and apparatuses of producing and consuming a pedagogy from distraction or diversion as a form of public instruction. This correlation of entertainment and education banks on the image of teaching and learning as a dull cerebral activity. That its cognitive and affective effects cannot be achieved without the instrumental intervention of pedagogical aids. For Disney, forms of education without the distraction of entertainment are overly serious, monotonous, and cannot be made to be “fun”. Even if we accept this pre-supposition, it does not mean that

the scene of teaching is a disinterested space. The appropriation of innocence as a catalytic force for motivating educational actors strives toward the articulation of a “market-based notion of identity, one that suggests relinquishing their roles as critical subjects for the passive role of consuming subjects” (Giroux, 1999: 13). Disney makes questions of social justice, equity, and the public good dependent upon the economic demands and reason of its corporate agenda. In short, its teaching machinery of retail outlets and virtual spaces of multimedia merchandizing enables it to function and act as “the arbiter of children’s culture” (Giroux, 1999: 160). Giroux (1999) maintains that the “false happiness” (p. 54) of Disney pedagogy “should be understood as part of a broader assault on public discourse, which dispenses with the principles of autonomy, critical self-reflection, and the power of self-determination” (p. 55). And it is very hard not to agree with him given the wide-ranging examples of corporate self-interest that are copiously documented in *The Mouse That Roared*. Some of the most damaging commentary about the entrepreneurial petulance of Disney and its unethical business practices comes from its present and past CEOs. These examples—that include influencing the course of news reporting, engaging in public shaming rituals when dismissing employees, and refusing legal and moral culpability for injuries individuals have suffered on its theme park rides—have the effect of cleaving the aura of innocence from the public persona of Disney and exposing the unethical bathos of its commercial protectionism. It is anything but a celebration! And there is a certain poetic justice in that. For what Disney teaches is exemplified by the town its imagers created under the name of Celebration and the “progressive school” it has established there.

Giroux (1999) examines the logic and the circumstances leading to the founding of this vision of community and its mobilization and enactment of a philosophy of public schooling governed by the “instrumental logic of the market” (p. 64). Disney’s search for a “grab bag” of best instructional methods has set in motion the need for a curriculum emphasizing “technical over civic competencies” (Giroux, 1999: 73) to facilitate the commodification of knowledge as a means to safeguarding the future and profitable participation of the student in the virtual machination of the global economy. The notable experts chosen to actualize the vision of the Celebration School—Howard Gardner and William Glasser among them—are “largely grounded in educational psychology” (Giroux, 1999: 75) and the pedagogical necessity of developing a climate of therapeutic instrumentality in school cultures where problem solving and flexibility reigns supreme. As Giroux (1999) notes, it is not surprising that the progressive logic of the Celebration School is tied to a view of community under girded by a focus on personal relations, self-discovery, relevance, and adapting successfully to change via self-discovery and cognitive adjustment. We have to be wary of the dangers of such a discourse of educational reform that is inherently solipsistic and inwardly projected at the ethical expense of acknowledging the difference of the other. In stark contrast

to Giroux (1999), Andrew Ross (1999), who has written an ethnography of Celebration, is firmly under the spell of the enchanted world Disney has arbitrarily manufactured to simulate reality and improve upon it, but without the trappings of the critical values necessary to sustain a democracy society by securing the possibility of expressing a counter-logic to that of the status quo. The arguments made in the book take on the qualities of more or less a subtle hagiography of social reconstruction and the “life-worth-living-according-to-Walt”. Ross documents the material realization of a binary vision of the world where the existence of what is good is self-evident and always opposed to what is bad, without giving any sense of “how to challenge the substantive injustices in a society founded on deep inequalities” (Giroux, 1999: 75). The book does not present an even-handed reflection upon the phenomena and experiences chronicling the everyday goings on in the community of Celebration. Ross persistently defends Disney against its critics and surprisingly attempts to reclaim its democratic and corporate right to sprinkle pixie dust on the bleary and hopeful eyes of American citizens who want nothing more than the common sense ambition of securing a better future for themselves and their families that is far removed from the social realities of crime and poverty. There is nothing wrong with wanting to improve the conditions of one’s life. But what are we willing to give up for this? We must remember that a community is a gathering of some at the expense of others. That is, its distinguishing characteristic is the taking up and sharing of arms, or munitions, both literal and figurative, against the threat of others (Trifonas, 2000). An undercurrent of authorial frustration permeates *The Celebration Chronicles: Life Liberty, and the Pursuit of Property Values in Disney’s Town* as if Ross is trying to convince himself (and his readers) of the authenticity and value of the community he is temporarily living in as well as what he is experiencing and writing about. The effects of these latent, nagging questions of conscience looming below the surface of expression disrupt the coherence of the narrative and what is required by way of a structural corroboration for the examples constituting proofs of the argument the text puts forward. This does not mean that the book necessarily belies its trustworthiness as much as it is unreflexively one-sided. Although such myopia is not unexpected given the length of time Ross spent in Celebration and the personal and social relationships he struck up with its inhabitants. What is the critical point of this elaborate attempt at ethnography? Is it to simply assert, as the synopsis on the dusk jacket of the books does, that despite the elaborate façade of order and harmony we find in Celebration there are “real people” who live there with “real problems”. Therefore, we should not be too critical of Disney and absolve it of any ethical responsibility for what is happening in the town. *The Celebration Chronicles* illustrates the well-known problems of doing ethnography as experiential reportage or participant observation. Ross presents no sustained critical perspective on method through which to triangulate the catalytic validity of personal observation and responses therefore

we quite naturally challenge the sources of their inspiration and presentation and must question their motivation. In the end, I do not think that we can agree with his conclusions without taking the pre-occupations of his method into account.

Giroux (1999) makes his critical intentions clear with respect to reading what Disney teaches and attempts to operationalize through the cultural politics of Celebration:

The most important form of education fosters self-reflection and public responsibility, two qualities that, in the Disney ideology, are secular sacrilege. The “naturalized” world of Disney, with its squeaky-clean image, false happiness, and cartoonish social imagery exacts a high price both politically and ethically. (p. 54)

One of the issues at stake pedagogically is the pursuit of social justice and educational equity. There are numerous examples of Disney’s skillful navigation (manipulation?) of the political system and the democratic process to achieve the level of control it desires to construct an exclusive community that would mirror and reflect the nostalgic image of the regaining of childhood innocence and the renaissance of traditional American ideals. The corporate practice of territorialization is justified by a “decoupling [of] the language of politics from the discourse of community and substituting security, conformity, and regulation—referred to in Disney language as ‘Family Friendly Planning’—for the risk filled dynamics of democracy” (Giroux, 1999: 69). It is necessary to question the methods and the criteria used to achieve the reality of this utopia. For it surely is not a coincidence that Celebration is a predominantly white, middle-class, community where public behavior is heavily regulated in order to inculcate the appearance of similitude and homogeneity, a non-offending environment of good sense and sensibility. Giroux (1999) states,

Nobody can get lost in Celebration. The rules include not being allowed to hang the wash out to dry, keeping the grass cut, not being able to live elsewhere for more than three months at a time, holding only one garage sale in any twelve-months period, displaying only white or off-white window coverings, and using only approved house paint colors. (p. 68)

The regimentation of the private sphere of individual freedoms and choices is necessary for the sake of perpetuating the image of community values Disney puts forward as a philosophy of being predicated on the meaningful lack of diversity and difference. Celebration is an objective correlative of the return to childhood innocence and its memory that Disney keeps alive. But the pedagogical symbolism of this community is not immediately apparent. Its

paternalistic decision-making structure and the inflexibility of its laws mitigate the power of the individual to actualize authentic states of self-determination. Subjective agency is severely diminished, if not totally taken away, in some instances. Celebration unwittingly reproduces what is a most obvious fact of childhood innocence and the necessity for pedagogical intervention: That is, the innocence of childhood is characterized by a state of powerlessness and is marked by the inability of the child to act against its oppressors in order to establish subjective agency. Yes, Disney does teach. Giroux (1999) is right. Yet, on a fundamental level, through the prohibitions of Celebration in the name of community, it treats those who uncritically espouse to reproduce the spirit of its image as powerless children in need of tutelage.

To some readers, this conclusion may seem severe, or even unfair to Disney as a “cultural corporation”. What I mean by this term “cultural corporation”, is a commercial enterprise that is in the business of interacting with, representing, and affecting the historicity of cultural forms and practices in some way through its control of the means of media production. And I am not stating that Giroux’s (1999) reading of Disney asserts the conclusion I have drawn above. He is more critically balanced in his view, more open minded and less extreme perhaps. Giroux (1999), in this sense, praises the inventiveness of Disney as a cultural corporation “in its attempts to reconstruct the very grounds on which popular culture is defined and shaped” (p. 95). Its early experimental films such as *Fantasia* were eclectic and unique in their scope of rewriting cultural forms of expression and representation via the media of motion pictures. Although I would not necessarily consider Disney’s technological innovations completely laudable from a strictly aesthetic viewpoint, they did further the development of animation films through the mixing of literary genres with interactive narrative techniques and catchy songs. We cannot deny that. But a more important concern is what children learn from Disney films. And it is here, on this problem of affectivity and reception, that Giroux’s analysis is very clear, precise, and most powerful.

The themes of memory, culture, and social responsibility organize the structure of such a critique with a view to submitting Disney texts to counter-readings for the purpose of exposing the contradictions between expression and content, image and message, idea and ideology. For example, deconstructing the pre-occupations of animated films such as *Pocahontas*, *Aladdin*, *The Little Mermaid*, *The Lion King* as well as feature movies such as *Good Morning Vietnam* and *Pretty Woman*, Giroux (1999) shows us how the cinematic experience is not without self-interest, not innocent but invested with purpose. The production of aesthetic responses demands the psychic and somatic involvement of the viewer, on many levels, with what is being viewed (Trifonas, 1998). This enables the suspension of disbelief that follows a heightening of the critical faculties where the subject is absorbed in the evocation stimulated by its engagement with the experience of a new possible world. Disney calls for “enchantment”. This is another way of saying it is promoting an



unreflexive and uncritical responsiveness through which “the audience is meant to suspend judgement of [a] film’s ideological messages” (Giroux, 1999: 96). Giroux (1999) gives many examples where the films I mention earlier thematize problematic assumptions and their structure “restricts the number of cultural meanings that can be brought to bear” (p. 96) on their interpretation. The following are but a few of them: The sexual ordering of women and their roles as defined by men (e.g., Princess Jasmine in *Aladdin*); the racialization of speech and its connection to the racist representation of “evil” characters as cultural others (e.g., the Arab thieves in *Aladdin*); the lack of references to the legacy of imperialism and colonialism in *Pocahontas*; and the gender stereotyping of *Pretty Woman* as well as its patriarchal logic of the script that allows the female protagonist to be first objectified and commodified as a woman, then transformed and rehabilitated, via male intervention, from “escort” to potential love interest and marriage partner. In reading Disney films, it would be a mistake to concentrate on reproducing pre-determined ideological reading of these films. It would be much more productive to analyze what they represent and thematize to get their message of enchantment across, how they work in, on, and through memory “to secure particular forms of authority and social relations” (Giroux, 1999: 108).

Disney is hard to resist. We have known that since we were children. Sometimes, Disney has shown us a representation of the world as we have experienced it both realistically and allegorically. At others, it has revealed a vision of the world as we would like it to be, a place of innocence and enchantment where all is well that ends well. But if we are to reclaim the space of public memory as an open communal space for negotiating the terms of democracy and critical citizenship through which to achieve equality and social justice, then we must try at the very least to reread the effects of the political economy of the signs and images produced by Disney that pervade our everyday lives and those of children. Perhaps it is not too late to begin.

#### REFERENCES

- Eco, U. (1979). *The Role of the Reader: Explorations in the Semiotics of Text*. Bloomington: Indiana University Press.
- Giroux, H. A. (Ed.) (1999). *The Mouse that Roared: Disney and the End of Innocence*. Lanham, MD: Rowman & Littlefield.
- Ross, A. (1999). *The Celebration Chronicles: Life, Liberty, and the Pursuit of Property Values in Disney’s New Town*. New York: Ballentine Books.
- Trifonas, P. P. (1998). Cross-mediality and narrative textual form: a semiotic analysis of the lexical and visual signs and codes of the picture book. *Semiotica* 118(1/2), 1–70.
- Trifonas, P. P. (2000). *The Ethics of Writing: Derrida, Deconstruction, and Pedagogy*. Lanham, MD: Rowman & Littlefield Publishers.

## Chapter 44: “A Small World After All”: L. M. Montgomery’s Imagined Avonlea as Virtual Landscape

BENJAMIN LEFEBVRE

*Department of English and Cultural Studies, McMaster University*

In the rental car on this clement afternoon in June, Jenny and I discuss some of the papers given at a three-day academic conference centered on an author whose literary output has been the subject of both my graduate work and hers. It is my fourth such conference here, her third; we talk comfortably over the familiar mixed feeling of satisfaction and regret now that the conference has ended—satisfaction over the chance to connect with new and familiar friends and colleagues, regret that these discussions had to end so soon. As part of the conference package, we have been given complimentary tickets to a tourist attraction a 30-minute drive away. With us in the car is our new friend Cynthia, who is researching an article for *Saturday Night* magazine but who has no way of getting around. The drive is pleasant, the scenery making us feel lazy and contented, the conversation open and frank. Once we arrive at the tourist site, however, we need a moment to adjust to the glaring contrast between what stands before us and the scholarly gathering we have just left behind. For the theme park is “Avonlea: Village of Anne of Green Gables”, located on the outskirts of Cavendish, Prince Edward Island, Canada; the conference, *L. M. Montgomery and Life Writing* (2002), is the fifth biennial conference devoted to author L. M. Montgomery,<sup>1</sup> whose imagined community of Avonlea, described in three novels and two collections of short stories published between 1908 and 1920,<sup>2</sup> has proven socially, geographically, and culturally recognizable to readers around the world for nearly a century.

This “Avonlea Village”, part of an ever-expanding tourist industry only vaguely connected to the actual fiction written by Montgomery, is a fenced-in replica of a town square comprised mostly of new but old-fashioned-looking buildings, the majority of which turn out to be stores selling Anne-related products such as multicolored ice cream and bottles of (carbonated) raspberry cordial. Actors dressed as Montgomery’s Avonlea characters wander from building to building, interacting freely with tourists, and even pausing to be photographed. I walk around in a daze, taking pictures of everything and complaining the whole time that nothing in this representation makes sense. Cynthia’s article, which will claim that “the theme-parking of the Green Gables site has pushed it even further in the direction of the unreal” (Brouse,

2002: 36), will describe this place as “an awkward pastiche of locations from both Montgomery’s and Anne’s lives” (Brouse, 2002: 39). Indeed, the theme park’s collapsing of the worlds of Montgomery and of fictional characters created by her is what vexes me most about this environment: In the actual schoolhouse where Montgomery taught from 1896 to 1897—hauled all the way from Belmont, 40 miles from Cavendish, and one of only three “authentic” buildings here—a Montgomery impersonator “teaches” children seated at desks the details of “her” private life, including the death of her mother, her subsequent lonely childhood during which she was raised by stern maternal grandparents, and her ambitions as a writer and a schoolteacher.

After one of these scheduled “sessions” with her pretend pupils, who appear bored by this performance, the Montgomery impersonator exits the Belmont schoolhouse of 1896 and finds herself in Avonlea, a fictional community that the actual Montgomery would not begin imagining until 1905. Although my friends and I never catch the Montgomery impersonator interacting directly with the characters she would later create, the fact that they occupy the same enclosed space is something I find truly odd, even though none of the fellow tourists around me seem to notice this hole in narrative plausibility. The academic in me, searching for some semblance of “authenticity”, is inconsolably bothered by the lengths to which the site goes to erase all cultural and temporal specificity in its attempt to lure and attract a mass consumer audience into its depiction of “the good old days”; in fact, given the Mark Twain and Disneyesque feel of the place, Jenny and I wonder whether the site is designed to appeal specifically to *American* imaginings of the rural past. Still, even though this Avonlea in no way matches the fictional space I imagined after reading Montgomery’s fiction, creeping up on me is another feeling, one of excitement over being a physical participant in Avonlea, a place I feel knowledgeable about after more than a decade of reading and study of it. I ask my friends to help me locate some of the actors so that I can have my picture taken with them—“for kitsch value”, I add feebly. My friends look at me as though they believe I have lost my mind. The excitement that has snuck up on me against my will gives me pleasure and revolts me at the same time. The sight of the Avonlea children running alongside Montgomery certainly pushes narrative credibility beyond logical limits, and yet I find it fascinating in terms of street theatre: The costumed actors remain upbeat and in character no matter what is said to them. I get my photograph taken with both Montgomery and Anne—or, rather, alongside actors impersonating them. I stare shyly at the woman playing Montgomery while Cynthia fiddles with my camera. “I did my Master’s thesis on you”, I am tempted to confide to her, but I find I cannot. I am momentarily duped into believing that this actually is Montgomery and am rendered speechless by that realization.

It appears rather difficult to bridge the gap between the academic conference and a tourist site that evokes in me both incredulity and pleasure simultaneously, yet these phenomena are complexly entangled together in the name of

one individual creator. Although the published oeuvre of L. M. Montgomery (1874–1942) consists of 20 novels, 500 short stories, 500 poems, as well as journals, correspondence, and numerous miscellaneous pieces, the derivatives of that body of work spill over multiple categories simultaneously—film and television, tourism and commodification, iconic image and cultural capital. The name L. M. Montgomery, itself a trademark of Heirs of L. M. Montgomery Inc., is likewise a commodity that pushes to new limits Foucault's (1997) concept of the "author function", whereby the author becomes a cultural capital that develops, through cultural association, into an ideological entity separate from the actual individual who bears that name. This ideological entity, the implied author behind a series of popular novels that are at times devalued as wholesome and harmless entertainment for girls, clashes awkwardly with the "unreliable narrator" (Brouse, 2002: 34) of *The Selected Journals of L. M. Montgomery* (Montgomery, 1985, 1987, 1992, 1998, 2004), a carefully crafted auto-representation consciously designed by Montgomery for posthumous consumption.<sup>3</sup> What Rubio (2001) calls Montgomery's "own multi-volume 'life-book'" (p. 59) frequently includes narratives of despair and rebellion alongside the more expected descriptions of passionate female friendships, of her negotiation of the social roles expected of a woman of her background, of her responses to the literature that helped shape her writing, and of her particular appreciation for the natural world. Numerous tourist sites in Canada and beyond, like the one described at the beginning of this paper, purport to be shrines dedicated to Montgomery's life and legacy. Some sites go to the lengths of re-enacting key events described in her journals and letters, but are unable to incorporate these unexpected moments of rebellion and anger into their reconstructed record of her life: They must either censor these moments or present the point of view of the detached outsider unable to see beyond Montgomery's impenetrable public exterior. These narratives, which claim to be fact, are in fact fictions.

In her discussion of "Avonlea Village" and similar Montgomery tourist attractions, Brouse applies Baudrillard's (1994) concept of the "simulacrum", which analyzes "copies of things that no longer exist . . . which leave us feeling that nothing is real anymore" (2002: 36). Examining these tourist sites as simulacra is entirely apt: Even though Avonlea itself never existed, and even though the Cavendish of 1905—ostensibly a loose model for Montgomery's imagined community—no longer exists, countless tourists from around the world have traveled to Prince Edward Island since the publication of *Anne of Green Gables* (1908) in an attempt to somehow return to this "original" appealing rural landscape, to see *first-hand* a visual and three-dimensional reality that is represented, through written language, in a literary text. The desire to see and experience this represented space—both imagined and ideological—through a medium other than the literary text has led to several industries of mass-produced commodities that exist alongside the publication of Montgomery's journals, all of which help keep Montgomery commercially relevant almost

a century after the publication of *Anne of Green Gables*: A series of multinational television adaptations, including several produced in association with the Disney Corporation, an institution that has been critiqued for its patterns of subtle cultural domination (Bell et al., 1995; Giroux, 1999, 2000; Hearne, 1997; Lefebvre, 2002b); a growing commodification industry that immortalizes dominant images for mass consumption (Lynes, 1998); a network of tourism sites in Ontario and Prince Edward Island concerned more with generalized assumptions about the Montgomery phenomenon than with an “authentic” representation of her fictional space (Fawcett & Cormack, 2001; Gates & Gillis, 2004; Squire, 1992; Tye, 1994); and a growing list of internet sites created to visually reproduce Montgomery’s idealized representation of Prince Edward Island landscape and culture for users all over the world and to simulate online virtual communities that have been categorized by previous critics as “metaphor” (Nolan et al., 1998) and as “hyperreal” (van der Klei, 2002). As Devereux (2001) notes, these “supplementary products . . . do not, for the most part, reproduce the text itself, but . . . rely on visual representations of the heroine” (p. 12). Moreover, these complementary products have added implications for audiences who have not read Montgomery’s source text: By stripping Montgomery’s imagined community of its geographical, temporal, and ideological specificity—including its occasional xenophobia (against French-Canadians, Irish-Catholics, and Americans) and its absencing of religious, cultural, and racial diversity—these later incarnations manage to keep the names “L. M. Montgomery” and “Anne of Green Gables” ideologically accessible and culturally relevant through time, geography, gender, sexuality, and background. In her discussion of the novel’s complex dual relationship as a sign of Canadian nation and as a recognizable sign outside Canada, Devereux suggests that “*Anne* is popular in other national and nationalist contexts not because it is Canada, but because it is itself a nationalist narrative” (2001: 20). Beyond their recognizability as signs of Canadian culture (Gammel & Epperly, 1999), *Anne of Green Gables* and its derivatives have also gained tremendous cultural capital in such seemingly unlikely places as Japan (Akamatsu, 1999; Allard, 2002; Baldwin, 1993; Gaudet, 1987; Katsura, 1984; Stoffman, 1998; Trillin, 1999), Poland (Rubio, 1994; Wachowicz, 1987), and Iran (Lefebvre, 2002b: 182; York, 2000). Thus, Montgomery as a cultural capital now refers less to any fiction that she wrote and more to such recreations and transformations of that fiction that make her appear simultaneously traditional or timeless and up-to-date—what Lynes would call “a collision of past and present” (1998: 9).

It would be impossible in the scope of one paper to outline in sufficient detail the complex processes of adaptation, appropriation, transformation, and mutilation that have occurred in the creation of these spin-off products, and it would likewise be impossible to properly overview these films, products, and internet sites that add to the larger Montgomery library. Instead, the main purpose of this chapter is to examine how Montgomery’s fiction has

proven so potentially malleable, so universally appealing in the first place. And so, rather than limit the discussion to an analysis of how such spin-off simulacra misread the “original” text, I propose to go a step farther and suggest that Montgomery’s “original” Avonlea is itself a simulacrum, a *selective representation* of reality, a copy of an original that does not exist. Thus, in suggesting that “Avonlea Village” is not just a simulacrum but a simulacrum of a simulacrum, this chapter departs from the writers and critics who make direct links between the visual pleasures described in Montgomery’s fictional texts and the actual geographical space of Prince Edward Island (Davey, 1999; Kessler, 2001; Rootland, 1996). I do not mean that Montgomery’s textual descriptions of the physical landscape of Prince Edward Island are somehow faulty or inaccurate, but rather that Montgomery imagined a specific form of selective community in order to make her texts as appealing as possible to readers who had never even heard of Prince Edward Island. In other words, as much as tourist sites such as “Avonlea Village”—which includes at its entrance two “cigar-store Indians” painted over as Anne and Diana—create their own meaning that is completely divorced from its literary origin, this “origin” is not itself an original as Baudrillard defines it; instead, it is Montgomery’s selective interpretation of the real that has been interpreted as universally attractive. While this leads to its international relevance and popularity, this selective representation has a downfall when it is read as metonymically representing the nation. An examination of this dual consequence is the goal of this paper.

1. “A PURELY IMAGINARY PLACE”: L. M. MONTGOMERY  
AND SHIFTING LANDSCAPE

In a journal entry dated 1 March 1930, Montgomery copied down extracts of book reviews she had collected throughout her career and commented on some of the discrepancies between them. What amused her especially is that several early reviews claimed that Nova Scotia, New Brunswick, Cape Breton Island, Western Canada, New England, and even Scotland were the setting of *Anne of Green Gables* (1998: 40–41). The inability of these critics to notice or remember that the novel is set in Prince Edward Island is somewhat curious, given that this geographical location is explicitly identified throughout the novel, and especially given the growing number of tourists who had trekked to Prince Edward Island not to see its author (Montgomery had moved to Ontario after her marriage in 1911) but to see the landscape described in her books. In a journal entry recording a return visit to Cavendish in September 1929, Montgomery recorded her impression of some of the esthetic changes and renovations made in Cavendish—including signs announcing “Avonlea Beach” and Green Gables, which in fact was the home of a distant relative—to accommodate the desires of these tourists: “It seems of no use to protest

that it is not ‘Green Gables’—that Green Gables was a purely imaginary place. Tourists by the hundred come here and . . . no one will ever believe that Cavendish Pond is not ‘The Lake of Shining Waters’” (Montgomery, 1998: 8–9). Although Montgomery’s categorization of Green Gables as “a purely imaginary place” conflicts with some of her earlier statements about Cavendish as the model for her imagined Avonlea,<sup>4</sup> what does remain consistent is the reader response—one that outweighs the authorial intent—that is attracted *first* to the description of this imagined space in a literary work and *second* to the idea of traveling to the geographical space to see it “first-hand”, assuming that the description in the literary text is a “copy” of a “real” geography that still exists. I complicate this notion in a twofold way: (i) again using Baudrillard’s terminology, it would be more accurate to claim that, because the literary text came first for readers traveling to Prince Edward Island in search of the “original” Avonlea, the community described in the novel is actually the original Avonlea and (ii) in light of the comments made by critics who have examined Montgomery’s descriptions of landscape and community, the imagined Avonlea is a simulacrum because it is a selective reproduction of what existed.

Despite the numerous ways in which *Anne of Green Gables* has been categorized by critics and readers (Lefebvre, 2002a: 92–93), the label that is most appropriate to the discussion here is that of the regional idyll, which MacLulich (1983), borrowing from the earlier work of Pacey (1967: 196–197), describes as “the Canadian version of the local colour and kailyard fiction that was popular in America and Britain just before the turn of the century” (p. 490). While similar novels such as Sara Jeannette Duncan’s *The Imperialist* (1904) and Stephen Leacock’s *Sunshine Sketches of a Little Town* (1912) refigure the conventions of this form, MacLulich suggests that *Anne of Green Gables* “is a thoroughly conventional regional idyll” and that its strengths stem from Montgomery’s “skillful but straightforward use of the literary conventions her age gave her to work with, not from her witty innovations on familiar themes” (pp. 490–491). Although several critics subsequent to MacLulich would contest the notion that *Anne of Green Gables* follows any literary convention so straightforwardly, MacLulich’s definition of the regional idyll is quite useful for the present examination of the book’s international portability and appeal:

The regional idyll recreated a simple rural world, usually a *heightened version* of the author’s childhood environment. Readers could join the author on a sentimental journey into the immediate past of their own country. The resulting blend of sentiment and nostalgia offered readers a welcome temporary escape from a world grown increasingly urban and industrial.

(1983: 490; emphasis added)

Such a convention fits with Montgomery's wish, stated in a journal entry dated 1908, to be "a messenger of optimism and sunshine" in her creative work, a statement made in light of her mention of "the conditions of worry and gloom and care under which [*Anne of Green Gables*] was written" (1985: 339). It also works in tandem with the work of several critics (De Jonge, 2002; Fiamengo, 2002; Kotsopoulos, 2002; Squire, 1992; Tye, 1994; Willis, 1976–1977) who have examined Montgomery's selective reproduction of late 19th and early 20th century Prince Edward Island reality in her imagined community. Willis suggests that the book attracts a dual audience of adult and child readers due to "its catering to a desire for wish-fulfillment and, on the part of the older reader, nostalgia for a sentimentally envisioned past" (1976–1977: 247) in addition to its distortion of myth and fairy tale. In her examination of landscape in Montgomery's fiction, Fiamengo claims that Montgomery describes Prince Edward Island in a general enough way that would not alienate her readers, whom she saw as primarily American, thus creating what she calls "a transregional magic" (2002: 232). In light of these remarks, it is perhaps less surprising that readers past and present have had difficulty remembering where *Anne of Green Gables* is set (Lynes, 1998: 10), meaning that, for these readers, the geographical specificity of Prince Edward Island is less important than the appealing natural images described through language. As well, as Careless (1992) argues and as Litster (1997) supports, the conflicting historical references throughout both *Anne of Green Gables* and the overall series make the task of conclusively dating specific events impossible. As a result, this imagined community, one with no temporal specificity and whose geographical location sometimes shifts away from the real, becomes a virtual community even before it is transformed for film, television, and computer screens in the century subsequent to its publication.

But what are the values of this "imagined community", to use Anderson's (1983) term—one that, as I will get to later in this chapter, has been interpreted as representative of the nation?<sup>5</sup> What are its dominant meanings and signifieds? Who and what are represented in this imagined space? These questions are especially apposite in the case of an imagined community that represents a selection of reality, not only because this fictional environment has proven so appealing worldwide for such a long time but particularly given Balibar's (2001) point that, "under certain conditions, *only* imaginary communities are real" (p. 221). For Atwood (1999), "'Avonlea' was simply reality edited" (p. 224), meaning that, while the characters themselves are accurate portraits of people in the environment being represented, not all of reality is included in that representation. Litster (2001) offers the following corrective: "Montgomery tamed the world she grew up in, but also twisted it, exaggerated it, romanticized it, made it more exciting, although never so much so that it ceased to be a recognizable 'real' Canadian scene" (p. 188). Litster's comments, and to a lesser extent Atwood's, fit within MacLulich's discussion of Avonlea as a regional idyll broached earlier in this chapter. But the editing



of this reality is far from simple, since Montgomery edits out what little diversity there was in the Cavendish used as her model, a place Rubio (1999) calls “a typical tightly knit nineteenth-century Scottish community, with life organized around its church” (p. 94). Although Cavendish had two churches—Presbyterian and Baptist (Rubio, 1999: 97)<sup>6</sup>—and its surrounding settlements included French and Irish inhabitants, Montgomery’s imagined Avonlea does not represent this diversity. Montgomery creates Avonlea to be religiously and culturally monolithic in order to maximize the level of disruption that Anne, a stranger to this community, signifies.

This “simplification” of reality is perhaps most noticeable when placing Montgomery’s texts alongside the recent television adaptations that rework and “update” her literary output to make the name “L. M. Montgomery” compatible with more recent imaginings of Canadian nation. While I readily concur with MacLulich’s claim that “The enduring popularity of Montgomery’s best-known creation suggests that her writing has the capacity to evoke a strong and abiding emotional response in many readers” (1983: 489), I extend this remark to include the many viewers who have responded in similar ways to the television adaptations of this text without encountering Montgomery’s actual writing (Lefebvre, 2002c: 165); for these consumers in the post-digital era, it is these recent adaptations and not Montgomery’s books that are the cultural capital associated with the name L. M. Montgomery. The *Anne of Green Gables* miniseries from Sullivan Entertainment (Sullivan, 1985) is of especial relevance here, not only because it has received a varied number of critical responses (Berg, 1988; Dickinson, 2002; Drain, 1987; Frever, 1998; Gates & Gillis, 2004; Hersey, 2002a, b; Howey, 2002; Lefebvre, 2000, 2002c; Poe, 2002), but because it is the first of an extensive catalog of television productions that would renew Montgomery’s name as a popular culture phenomenon from the mid-1980s onward. An examination of the adaptation process of these texts reveals late 20th century rewritings that make these “old-fashioned” texts more appropriate viewing for television audiences of the 1980s and 1990s. This examination also reveals that the majority of these adaptations remove all examples of female self-sufficiency in Montgomery’s novels in order to pressure these stories to fit the demands of heterosexual romance (Lefebvre, 2002c: 151; see also Dickinson, 2002: 9; Sheckels, 1999: 188).

For instance, critics who have examined the cultural prejudices present in Montgomery’s *Anne of Green Gables* (Devereux, 2001; Edwards & Litster, 1999; Gates & Gillis, 2004; Robinson, 1999; White, 1995), more specifically its characters’ negative attitudes against the Acadian population of Prince Edward Island (a group that both Montgomery and her characters continually refer to as “the French”), inevitably focus on the following extract found in the first chapter of the novel, in which Marilla explains to neighbor Mrs. Lynde the rationale for deciding to adopt a boy from an orphan asylum in Nova Scotia to help her aging brother Matthew with the farm work:

And you know how desperate hard it's got to be to get hired help. There's never anybody to be had but those stupid, half-grown little French boys; and as soon as you do get one broke into your ways and taught something he's up and off to the lobster canneries or the States. At first Matthew suggested getting a Barnado [sic] boy. But I said 'no' flat to that. 'They might be all right—I'm not saying they're not—but no London street Arabs for me,' I said. 'Give me a native born at least. There'll be a risk, no matter who we get. But I'll feel easier in my mind and sleep sounder at nights if we get a born Canadian.'

(Montgomery, 1908: 6)

As White (1995) notes, the entire premise of *Anne of Green Gables* stems from this extract, given that it is only because young Acadian males are apparently irredeemably unreliable that Matthew and Marilla need to send for an orphan from Nova Scotia to help with the farm chores (p. 65).<sup>7</sup> Examining this extract in the context of national and communal identities, Robinson (1999) adds that Marilla's preference for a "native born"—despite the fact that Prince Edward Island had only become part of the Dominion of Canada in 1873, a decade prior to the general period in which the novel is set (Edwards & Litster, 1999: 31)—indicates her hope in "keep[ing] the risks of foreignness at a minimum" (p. 22) and her conviction that a "native born" will fit the dominant stratum of Avonlea in ways that a Barnardo boy and a native born, French-speaking Acadian boy apparently could not.<sup>8</sup> Devereux (2001) maintains that this scene is "an index of the novel's ideological positioning to a 'white' Canada" (p. 22). The 1985 miniseries from Sullivan Films, which refits the novel not only for the demands of the visual screen but also those of co-production partners in Canada, the United States, and West Germany, reproduces the larger scene almost exactly from the source text but excises this comment from the characters' discussion. This creative decision is in line with an overall project of eliminating material from the source text that, while perhaps historically accurate, would likely offend many television viewers of the 1980s, who presumably would not be able to properly place those attitudes in their historical context. Such an offense could easily result in a loss of international sales as well as the possibility of having a dubbed version of the film marketed to francophone Canada. Despite such a concern, Gates and Gillis maintain that "Sullivan's re-visioning of *Montgomery's* re-visioning [of reality] further removes the audience from a specific Canadian history, as the films reproduce the tensions of contemporary national culture under the guise of heritage" (p. 191). I would add that, at the same time as removing the offensive line about French-Canadians, this excision also removes the very *existence* of French-Canadians from the national terrain.

Gittings (1998) reaches a similar conclusion in his examination of the television series *Emily of New Moon* (1998–1999; 2002–2003), an adaptation of later novels by Montgomery co-produced by Salter Street Films (Halifax) and

CINAR Productions (Montreal). In his analysis, Gittings is concerned less with individual statements from Montgomery's novels excised for television consumption than with the addition of Micmac and French-Canadian characters into a new narrative associated with the name L. M. Montgomery; as he states, "Montgomery's caricatures of Irish difference in the *Emily* books and her absencing of Micmacs from the social terrain of the trilogy [conflict] with contemporary imaginings of a racially diversified nation"; the work of L. M. Montgomery, a "national icon", must be transformed to become "compatible with late 20th century Canadian imaginings of nation" (p. 23). As well, later episodes of the series that aired subsequent to Gittings's study introduce an extended story arc involving one of the lead adult female characters trapped in a disastrous marriage. This and additional episodes focusing on unwed pregnancy, rape, divorce, marital infidelity, and melancholia—themes that Montgomery avoided in most of her fiction—contradict her narrative choices to broach such realities subtly rather than explicitly at the same time as they widen the possibilities of female experience represented in works associated with Montgomery's name.

Of especial interest in a discussion of Montgomery adaptations as representative of specifically Canadian imaginings of nation are those co-produced by the Disney Channel (U.S.), which comprise the majority of total viewing hours in the Montgomery television catalog. In addition to using Montgomery's novels as raw material to create new storylines with original titles, these productions are also very fruitful in terms of theorizing about national images that are recognizable to more than one nation. The miniseries *Anne of Green Gables: The Sequel* (Sullivan, 1987), the film *Lantern Hill* (Sullivan, 1990), and the episodic series *Road to Avonlea* (1990–1996), all co-produced by the Disney Channel and largely successful in that venue, are much looser in their adaptation of Montgomery's source texts—in the case of *Road to Avonlea*, adaptations of unrelated texts by Montgomery—to create new visual productions that, much like Disney's reworking of myths and fairy tales, are now more recognizable as popular culture phenomena than Montgomery's own fiction.

Knelman (1987) suggests that the partnership between the Canadian Broadcasting Corporation, the Disney Channel, and Telefilm Canada in creating these adaptations should be unexpected, given that the Walt Disney phenomenon is supposedly "dedicated to promoting the ideals of Middle America, while Telefilm is supposed to be encouraging the development of an indigenous Canadian film culture and providing a shield against the overwhelming shadow of the Hollywood giant" (p. 148).<sup>9</sup> But *Road to Avonlea* managed to appeal to both CBC and Disney Channel viewers and subsequently to international viewers in part because it created stories and settings that would be familiar domestically and internationally without being bound to a specific geography and history (Kotsopoulos, 2002; Lefebvre, 2002c). As Dickinson (2002) notes, multinational adaptation requires "deemphasizing the gender, cultural, regional, and historical specificities of the source texts", which these

Sullivan/Disney co-productions achieve remarkably well (p. 32). After a series of interviews with key personnel involved in the development of *Road to Avonlea*, Kotsopoulos (2002) concluded that all three parties had similar goals in shaping material by Montgomery for a multinational co-production: (i) the elimination of specific religious, cultural, and regional practices or beliefs that are ostensibly accurate of the culture about which Montgomery was writing but that may offend or alienate mass viewers of the 1990s (similar to the excision of anti-Acadian dialog in the earlier adaptation of *Anne of Green Gables*) and (ii) a refiguring of male–female relations, including the figure of the single woman, that would be more compatible with late 20th century imaginings of gender politics. In order to follow the Disney model of erasing difference to appeal simultaneously to the greatest possible number of viewers (Giroux, 1999), the “Avonlea” of this television series becomes a timeless and universal cultural monolith, one in which an extended family of white Canadians of Anglo-Saxon (specifically Scottish-Presbyterian) origin come to represent all Canadians of the 1990s (Lefebvre, 2002b). Although it would seem as though a CBC/Disney co-production could not be feasible because of each corporation’s nationalist agenda,<sup>10</sup> I suggest that *Road to Avonlea* became its own Canadian popular culture phenomenon not *despite* Disney’s involvement but rather *because* of it.

As such, the cultural product most recognized as Montgomery’s is no longer a body of work that is dependent on the time of its composition but rather a reworking of these texts that purges them of any cultural specificity to increase their relevance and portability across time to nearly every country with broadcasting capabilities. It is also worth noting that the Prince Edward Island visually represented in the Sullivan productions is actually a pastiche of filming locations in Southern Ontario; the minimal stock footage of Prince Edward Island was filmed separately using stand-ins and then edited into the narrative in such a seamless way that most viewers not familiar with the actual physical landscape of Prince Edward Island could not tell the difference. This has worked too well, however; as a result of these television adaptations, numerous tourists from both Canada and beyond have been disappointed that the “real” Green Gables House in Cavendish, Prince Edward Island is not the house used in the film (Squire, 1992: 144).<sup>11</sup> In addition, for internet users of the 21st century, there are a greater number of fan sites devoted to the Sullivan modernizations of Montgomery’s characters than those devoted to Montgomery’s books themselves (in other words, more site creators see *Anne of Green Gables* as a series of television productions than as a literary text). For those in the former category, the “original” production under reference is one that has been made universally appealing through the Disney machine, one specifically designed to appear timeless and one in which the geographic reality of Prince Edward Island is replaced by a pastiche of locations in rural south-western Ontario that selectively represent the landscape of Prince Edward Island.

This “universal appeal” needs to be examined for the internet users who interact with virtual replicas of Montgomery’s Avonlea—an Avonlea that is free of context, free of race, free of history, free of religion, free of nation, and free of culture, thus an Avonlea that is potentially malleable to any cultural context. While this de-contextualization is aided by Disney’s intervention in rewriting and transforming Montgomery’s texts for domestic and international television audiences of the 1980s and 1990s, the “original” texts were likewise transformed out of their cultural context and adapted for new cultural contexts. The specific details that Anne is a white Canadian and that Avonlea is a monolithic Scottish-Presbyterian community has not proven to be greatly important to citizens of Poland and Japan, for instance, where Montgomery’s novel has enormous cultural capital; in these cultural contexts, Anne and Avonlea become allegorical entities, meaning that Anne becomes a representative figure of any outsider who is marked as different, and Avonlea becomes a representative space of any monolithic society that requires disruption and reform. For internet users all around the world who take up the various products associated with the name L. M. Montgomery, this simulacral Avonlea becomes a site of a return to an “ideal” past, one free of all social problems—including racial, economic, or political conflicts—as well as free of geography, history, and culture.

Thus, at the same time that Montgomery’s landscape has “transregional magic”, it also has transcultural portability when read as metaphorical or allegorical. However, the erasures discovered in this imagined community become more problematic when Avonlea is read as a metonym for Canada, particularly for the late 20th century imaginings of a racially diversified nation that Gittings sees at work in the television series *Emily of New Moon*. The remarks of Adrienne Clarkson (1999), former Governor General of Canada, on the impact that Montgomery’s texts made on her as a young refugee from Hong Kong merit a close examination in light of this present discussion, particularly her point about how Montgomery’s books gave her a “profound understanding” of Canadian culture: “Through the particularity and peculiarities of Prince Edward Island and these girls’ fictional lives, I became a Canadian. L. M. Montgomery educated me at a very profound level about how Canada operated in a rural setting, with smart people, in the birthplace of Confederation” (Clarkson, 1999: ix). Clarkson adds that she could identify with the figure of Anne waiting at the train station—which Lynes calls “one of the most pervasive symbolic images” of *Anne of Green Gables* (1998: 19), an iconic image that is perpetually immortalized in Anne commodities—because it was *allegorically* similar to her own experience as a young refugee (1999: x). Her comment should be read alongside Devereux’s understanding of the consequences of seeing *Anne of Green Gables* as a national and a nationalist text, which becomes “a work that is, in ideological terms, seen to be reproducing a particular vision of the English-Canadian nation as a racially constituted community, a branch of the imperial racial

organization of ‘Saxondom’” (2001: 24). With Devereux’s analysis in mind, Clarkson’s remarks are troubling because they imply that, to her, “Avonlea” was a pedagogical environment that provided her with a cultural education that was neither metaphoric or metonymic or allegorical but literal. Rather than become allegorical sites of resistance to conformity, Anne and Avonlea were, to Clarkson, literal pedagogical sites of Canadian culture.

## 2. CONCLUSION: MULTIPLE LANDSCAPES AND CONTRADICTIONARY MEANINGS

Perhaps Avonlea ultimately remains what Giroux would call an “innate contradiction” of popular culture (1999: 9). Certainly, in terms of the quotation cited earlier about Marilla’s proscription of a very narrow range of individuals who qualify as Canadians, Devereux’s remark about Montgomery’s use of “other” characters “to reaffirm the dominant group’s dominance”, a strategy that she sees as a “pervasive and fundamental” part of the *Anne* books (2001: 22), is certainly apt. But given the success of “other” cultural groups as well as internet users of any background or location to incorporate this story into their own cultural or virtual context, Montgomery’s imagined Avonlea also has the potential to transcend these specificities and become recognizable and malleable universally, both before and after Avonlea is transformed by Disney. Such multiple meanings attest to the complexity of Montgomery and her imagined community as popular culture phenomena.

Ultimately, the erasures in Montgomery’s texts stem largely from some of the limits imposed on her at the time of composition of this novel, limits that are beyond the literary conventions of the regional idyll. In many ways, aside from infrequent instances of overt xenophobia throughout the text, Montgomery merely simplifies Avonlea to make her imagined community more manageable as a literary text. Indeed, since she was living in Cavendish at the time of creating *Anne of Green Gables*, this simplification would have been necessary for her, since she could not afford to have people think she was criticizing her neighbors and the community she was living in while she was still living in it. As Litster notes, “When Montgomery first wrote of Avonlea she was living in Cavendish, which restricted the inclusion of material that mimicked local people and concerns (thus surnames were dissimilar, clan networks less oppressive, religious worship unified)” (2001: 211). The later *Anne* books, particularly those written after Montgomery left Prince Edward Island for Ontario, are less tempered in this respect. As well, given that she was trying to attract an audience consisting primarily of American readers who would likely be entirely unfamiliar with Prince Edward Island culture, let alone its group tensions, she perhaps did not feel it necessary to delve into the long history of such tensions, which, if nothing else, would have taken away from the plots of her novels.

However, this does not mean that the complexities of absence and presence in both Montgomery's novels and its later derivatives should be ignored. The internet sites that idealize Avonlea are actually broadcasting a virtual environment that is several filters away from Montgomery's own filtering of Prince Edward Island. It is, after all, the continuing development of multilayered simulacra that led to the creation of "Avonlea Village". But at the same time, there are implicit dangers in seeing the literal, non-allegorical Avonlea as an "ideal" community that has nothing to do with generalized nostalgia about the "good old days". If Anne and Avonlea are idealized on the allegorical level, then it is generalized values about community, disruption of oppression, and insider/outsider tensions that are idealized, and these can then be applied to any context, either national or virtual; in this way, Avonlea becomes, to quote the theme song that attests to Disney's cultural domination, "a small world after all". But if Anne and Avonlea are idealized on the literal level, then implicit in this idealization is the longing for a white settler community with explicit values of racial purity and xenophobia, one that avoids racial, economic, religious, linguistic, and sexual diversities. The possibility of multiple interpretations stems not only from the interaction necessary on the part of readers, viewers, tourists, and internet users to engage in the environment named "Avonlea", but it also illuminates the extent to which Montgomery's texts can be simultaneously products of their time as well as lively, vibrant, malleable, and evolving texts that are no longer dependent on their context of composition.

#### ACKNOWLEDGMENTS

I am indebted to Jennifer H. Litster (University of Edinburgh) for her generous feedback on several drafts of this paper. I gratefully acknowledge doctoral fellowships from the Fonds québécois de la recherche sur la société et la culture and the Social Sciences and Humanities Research Council of Canada, which helped make this research possible.

#### ENDNOTES

1. These biennial conferences, begun in 1994, are organized by the L. M. Montgomery Institute (founded in 1993) at the University of Prince Edward Island <<http://www.lmmontgomery.ca>>. Themed conferences have examined Montgomery's work and its derivatives in relation to Canadian culture (1996), small-islands literature (1998), popular culture (2000), life writing (2002), interior and exterior landscapes (2004), and conflict (2006). The 2008 conference will mark the 100-year anniversary of the publication of *Anne of Green Gables*. For an overview of the most recent scholarship, see Lefebvre (2004).

2. The novels set in Avonlea are *Anne of Green Gables* (1908), *Anne of Avonlea* (1909), and *Anne of the Island* (1915); a related collection of short stories, *Chronicles of Avonlea* (1912), was followed by an unauthorized sequel, *Further Chronicles of Avonlea* (1920); another sequel partially set in Avonlea, *Anne of Windy Poplars*, was published in 1936. Further novels about Anne after her marriage—*Anne's House of Dreams* (1917), *Rainbow Valley* (1919), *Rilla of Ingleside* (1921), and *Anne of Ingleside* (1939)—are set in a community elsewhere in Prince Edward Island. Montgomery published 12 additional novels about unrelated characters and locales, but it is for the first three *Anne* novels that Montgomery has always been best known.
3. Although Montgomery began her adult journal in 1889, she decided in 1919, after she had become an internationally recognized figure, to transcribe these journals into uniform ledgers, which are now housed at the University of Guelph archives and which form the copytext of her published journals. Although she claimed she was copying these journals word for word, the fact that she destroyed the original documents subsequent to this project makes it impossible to compare the two versions. By 1929, she was increasingly conscious that her journals would be a unique record of a woman's experience and that this "private" journal would one day become a "public" artifact, and she consciously wrote with this eventuality in mind.
4. In the journal entry dated 16 August 1907, in which she mentioned *Anne of Green Gables* for the first time, Montgomery claimed that "Cavendish scenery supplied the background" (Montgomery, 1985: 331). In 1911, responding privately to the incessant question of what aspects of her books mirror the real space of Cavendish, she responded that "Cavendish is to a large extent *Avonlea*" (Montgomery, 1987: 38).
5. See Kertzer's (1999) analysis of Duncan's *The Imperialist*, specifically his discussion of her novel's "mixed genre commingling fact and fiction. Elgin is an imaginary town in a real nation, but the Canadian nation is an imagined community whose emerging sense of identity comes, in part at least, from reading about Elgin and Mariposa and Avonlea" (p. 24). Mariposa is the fictional community depicted in Leacock's *Sunshine Sketches of a Little Town*.
6. Although Montgomery attended the Presbyterian church all her life, and although there was tension between the two churches of Cavendish, Montgomery occasionally joined in the Baptist church's social activities. Interfaith tension was also a part of her later life as a minister's wife in rural communities in southern Ontario.
7. White suggests that these prejudices, which he also detects throughout Montgomery's journals, stem from a feeling of racial and cultural superiority derived from a feeling that, "since the French were supposed to have left the Island when it was ceded to the British, it was possible



to maintain that they had no right to live there except through the goodwill of the English-speaking population” (1995: 67). Although I agree with White’s statement in part, I also maintain that Montgomery often satirizes her own prejudices or satirizes the prejudices of her characters without necessarily sharing their attitudes.

8. This xenophobia of this extract is also shifted in the French-Canadian translation *Anne . . . La Maison aux pignons verts*. The “stupid, half-grown little French boys” become “ces stupides petits Acadiens, des demi-portions” (1986: 13).
9. Knelman also claims that the partnership of Telefilm Canada, the Canadian Broadcasting Corporation, and the Disney Channel to create *Anne of Green Gables: The Sequel* is “perhaps the oddest ménage à trois in this country’s cultural history” (p. 164), although the film also received funding from PBS/Wonderworks, the Corporation for Public Broadcasting (U.S.), and Channel 4 (U.K.). *Lantern Hill* was likewise produced in partnership with the CBC, the Disney Channel, Wonderworks, the Corporation for Public Broadcasting, and Telefilm Canada. Sullivan Films retained only CBC, Disney, and Telefilm as the major partners involved in the creation of *Road to Avonlea*, although additional funding in later years came from the Ontario Film Investment Program and the Cable Production Fund (see Lefebvre, 2000).
10. Co-production arrangements between the CBC and the Disney Channel have not been exclusive to Montgomery adaptations; earlier projects include the television series *The Edison Twins* (1982–1986), *Danger Bay* (1984–1989), and *The Raccoons* (1985–1992), all of which proved successful and recognizable as examples of “Canadian” television.
11. The television series *Emily of New Moon*, financed solely in Canada, was filmed entirely on location in Prince Edward Island. Sets were built with an eye for future tourism, but the series was abruptly cancelled and such plans were abandoned.

#### REFERENCES

- Akamatsu, Y. (1999). Japanese readings of *Anne of Green Gables*. In: Gammel, I. and Epperly, E. (Eds.) *L. M. Montgomery and Canadian Culture*. Toronto: University of Toronto Press, 201–212.
- Allard, D. (2002). *Taishu Bunka* and Anne clubs in Japan. In: Gammel, I. (Ed.) *Making Avonlea: L. M. Montgomery and Popular Culture*. Toronto: University of Toronto Press, 295–309.
- Anderson, B. (1983). *Imagined Communities: Reflections on the Origin and Spread of Nationalism*. London: Verso.
- Atwood, M. (1999). Reflection piece—revisiting Anne. In: Gammel, I. and Epperly, E. (Eds.) *L. M. Montgomery and Canadian Culture*. Toronto: University of Toronto Press, 222–226.
- Baldwin, D. (1993). L. M. Montgomery’s *Anne of Green Gables*: the Japanese connection. *Journal of Canadian Studies* (Revue d’études canadiennes) 28.3, 123–133.

- Balibar, E. (2001). The nation form: history and ideology. In: Essed, P. and Goldberg, D. T. (Eds.) *Race Critical Theories: Text and Context*. Malden, MA: Blackwell, 220–230.
- Baudrillard, J. (1994). *Simulacra and Simulation*. Glaser, S. F. (Trans.) Ann Arbor: University of Michigan Press.
- Bell, E., Haas, L., & Sells, L. (Eds.) (1995). *From Mouse to Mermaid: The Politics of Film, Gender, and Culture*. Bloomington: Indiana University Press.
- Berg, T. F. (1988). *Anne of Green Gables: a girl's reading*. *Children's Literature Association Quarterly* 13.3, 124–128.
- Brouse, C. (2002). The Maud squad. *Saturday Night* (September), 32–34, 36, 39–40.
- Careless, V. (1992). The hijacking of “Anne”. *Canadian Children's Literature* (Littérature canadienne pour la jeunesse) 67, 48–55.
- Clarkson, A. (1999). Foreword. In: Gammel, I. & Epperly, E. (Eds.) *L. M. Montgomery and Canadian Culture*. Toronto: University of Toronto Press, ix–xii.
- Davey, F. (1999). The hard-won power of Canadian womanhood: reading *Anne of Green Gables* today. In: Gammel, I. and Epperly, E. (Eds.) *L. M. Montgomery and Canadian Culture*. Toronto: University of Toronto Press, 163–182.
- De Jonge, J. (2002). Through the eyes of memory: L. M. Montgomery's Cavendish. In: Gammel, I. (Ed.) *Making Avonlea: L. M. Montgomery and Popular Culture*. Toronto: University of Toronto Press, 252–267.
- Devereux, C. (2001). “Canadian classic” and “commodity export”: the nationalism of “our” *Anne of Green Gables*. *Journal of Canadian Studies* (Revue d'études canadiennes) 36.1, 11–28.
- Dickinson, P. (2002). Introduction: reading movies. *Essays on Canadian Writing* 76, 1–45.
- Drain, S. (1987). “Too much love-making”: *Anne of Green Gables* on television. *The Lion and the Unicorn* 11.2, 63–72.
- Duncan, S. J. (1904). *The Imperialist*. Toronto: McClelland & Stewart (reprinted, 1990).
- Edwards, O. D. & Litster, J. H. (1999). The end of Canadian innocence: L. M. Montgomery and the First World War. In: Gammel, I. and Epperly, E. (Eds.) *L. M. Montgomery and Canadian Culture*. Toronto: University of Toronto Press, 31–46.
- Emily of New Moon* (television series). (1998–1999; 2002–2003). 46 episodes. Charest, M., Donovan, M., and Weinberg, R. (Executive Producers). Halifax: Salter Street Films; Montreal: Cinar Productions.
- Fawcett, C. & Cormack, P. (2001). Guarding authenticity at literary tourism sites. *Annals of Tourism Research* 28.3, 686–704.
- Fiamengo, J. (2002). Toward a theory of the popular landscape in *Anne of Green Gables*. In: Gammel, I. (Ed.) *Making Avonlea: L. M. Montgomery and Popular Culture*. Toronto: University of Toronto Press, 225–237.
- Foucault, M. (1997). What is an author? In: Faubion, J. D. (Ed.) *Aesthetics, Method, and Epistemology: Essential Works of Foucault 1954–1984, Vol. 2*. New York: New Press, 205–222.
- Frever, T. S. (1998). Vaguely familiar: cinematic intertextuality in Kevin Sullivan's *Anne of Avonlea*. *Canadian Children's Literature* (Littérature canadienne pour la jeunesse), 91–92, 36–52.
- Gammel, I. & Epperly, E. (1999). Introduction: L. M. Montgomery and the shaping of Canadian culture. In: Gammel, I. and Epperly, E. (Eds.) *L. M. Montgomery and Canadian Culture*. Toronto: University of Toronto Press, 3–13.
- Gates, P. & Gillis, S. (2004). Screening L. M. Montgomery: heritage, nostalgia and national identity. *British Journal of Canadian Studies* 17.2, 186–196.
- Gaudet, C. (1987). Why the Japanese love our *Anne of Green Gables*. *Canadian Geographic* 107, 8–15.

- Giroux, H. (1999). *The Mouse that Roared: Disney and the End of Innocence*. Lanham, ML: Rowman & Littlefield.
- Giroux, H. (2000). *Impure Acts: The Practical Politics of Cultural Studies*. New York: Routledge.
- Gittings, C. (1998). Re-visioning *Emily of New Moon*: family melodrama for the nation. *Canadian Children's Literature* (Littérature canadienne pour la jeunesse) 91–92, 22–35.
- Hearne, B. (1997). Disney revisited, or, Jiminy Cricket, it's musty down here! *Horn Book Magazine* 73.2, 137–146.
- Hersey, E. (2002a). "It's all mine": the modern woman as writer in Sullivan's *Anne of Green Gables* films. In: Gammel, I. (Ed.) *Making Avonlea: L. M. Montgomery and Popular Culture*. Toronto: University of Toronto Press, 131–144.
- Hersey, E. (2002b). "Tennyson would never approve": reading and performance in Kevin Sullivan's *Anne of Green Gables*. *Canadian Children's Literature* (Littérature canadienne pour la jeunesse) 105–106, 48–67.
- Howey, A. F. (2002). "She look'd down to Camelot": Anne Shirley, Sullivan, and the Lady of Shalott. In: Gammel, I. (Ed.) *Making Avonlea: L. M. Montgomery and Popular Culture*. Toronto: University of Toronto Press, 160–173.
- Katsura, Y. (1984). Red-haired Anne in Japan. *Canadian Children's Literature* (Littérature canadienne pour la jeunesse) 34, 57–60.
- Kessler, D. (2001). *Green Gables: Lucy Maud Montgomery's Favourite Places*. Halifax: Formac Publishing Company.
- Knelman, M. (1987). *Home Movies: Tales from the Canadian Film World*. Toronto: Key Porter Books.
- Kotsopoulos, P. A. (2002). Avonlea as Main Street USA? Genre, adaptation, and the making of a borderless romance. *Essays on Canadian Writing* 76, 170–194.
- Leacock, S. (1912). *Sunshine Sketches of a Little Town*. Toronto: McClelland & Stewart (reprinted, 1994).
- Lefebvre, B. (2000). L. M. Montgomery: an annotated filmography. *Canadian Children's Literature* (Littérature canadienne pour la jeunesse) 99, 43–73.
- Lefebvre, B. (2002a). Belated acknowledgements [Review of *L. M. Montgomery and Canadian Culture*]. *Essays on Canadian Writing* 77, 90–99.
- Lefebvre, B. (2002b). *Road to Avonlea*: a co-production of the Disney Corporation. In: Gammel, I. (Ed.) *Making Avonlea: L. M. Montgomery and Popular Culture*. Toronto: University of Toronto Press, 174–185.
- Lefebvre, B. (2002c). Stand by your man: adapting L. M. Montgomery's *Anne of Green Gables*. *Essays on Canadian Writing* 76, 149–169.
- Lefebvre, B. (2004). Assessments and reassessments [Editorial]. In: Lefebvre, B. (Ed.) *Reassessments of L. M. Montgomery*. Special issue of *Canadian Children's Literature* (Littérature canadienne pour la jeunesse) 113–114, 6–13.
- Litster, J. H. (1997). An annotated *Anne*: the history and the dream [Review of *The Annotated Anne of Green Gables*]. *Canadian Children's Literature* (Littérature canadienne pour la jeunesse) 88, 61–72.
- Litster, J. H. (2001). *The Scottish Context of L. M. Montgomery* [Dissertation], University of Edinburgh.
- Lynes, J. (1998). Consumable Avonlea: the commodification of the Green Gables mythology. *Canadian Children's Literature* (Littérature canadienne pour la jeunesse) 91–92, 7–21.
- MacLulich, T. D. (1983). *Anne of Green Gables* and the regional idyll. *Dalhousie Review* 63.3, 488–501.
- Montgomery, L. M. (1908). *Anne of Green Gables*. Toronto: Seal Books (reprinted, 1996).
- Montgomery, L. M. (1909). *Anne of Avonlea*. Toronto: Seal Books (reprinted, 1996).

- Montgomery, L. M. (1912). *Chronicles of Avonlea*. New York: Bantam (reprinted, 1993).
- Montgomery, L. M. (1915). *Anne of the Island*. Toronto: Seal Books (reprinted, 1996).
- Montgomery, L. M. (1917). *Anne's House of Dreams*. Toronto: Seal Books (reprinted, 1996).
- Montgomery, L. M. (1919). *Rainbow Valley*. Toronto: Seal Books (reprinted, 1996).
- Montgomery, L. M. (1920). *Further Chronicles of Avonlea*. New York: Bantam (reprinted, 1993).
- Montgomery, L. M. (1921). *Rilla of Ingleside*. Toronto: Seal Books (reprinted, 1996).
- Montgomery, L. M. (1936). *Anne of Windy Poplars*. Toronto: Seal Books (reprinted, 1996).
- Montgomery, L. M. (1939). *Anne of Ingleside*. Toronto: Seal Books (reprinted, 1996).
- Montgomery, L. M. (1985). *The Selected Journals of L. M. Montgomery, Vol. 1: 1889–1910*. Rubio, M. and Waterston, E. (Eds.) Toronto: Oxford University Press.
- Montgomery, L. M. (1986). *Anne . . . La Maison aux pignons verts*. Paratte, H.-D. (Trans.) Montreal: Éditions Québec/Amérique; Charlottetown: Ragweed Press.
- Montgomery, L. M. (1987). *The Selected Journals of L. M. Montgomery, Vol. 2: 1910–1921*. Rubio, M. and Waterston, E. (Eds.) Toronto: Oxford University Press.
- Montgomery, L. M. (1992). *The Selected Journals of L. M. Montgomery, Vol. 3: 1921–1929*. Rubio, M. and Waterston, E. (Eds.) Toronto: Oxford University Press.
- Montgomery, L. M. (1998). *The Selected Journals of L. M. Montgomery, Vol. 4: 1929–1935*. Rubio, M. and Waterston, E. (Eds.) Toronto: Oxford University Press.
- Montgomery, L. M. (2004). *The Selected Journals of L. M. Montgomery, Vol. 5: 1935–1942*. Rubio, M. and Waterston, E. (Eds.) Toronto: Oxford University Press.
- Nolan, D. J., Lawrence, J., & Kajihara, Y. (1998). Montgomery's island in the net: metaphor and community on the Kindred Spirits e-mail list. *Canadian Children's Literature* (Littérature canadienne pour la jeunesse) 91–92, 64–77.
- Pacey, D. (1967). *Creative Writing in Canada*, revised ed. Toronto: McGraw-Hill Ryerson.
- Poe, K. L. (2002). Who's got the power? Montgomery, Sullivan, and the unsuspecting viewer. In: Gammel, I. (Ed.) *Making Avonlea: L. M. Montgomery and Popular Culture*. Toronto: University of Toronto Press, 145–159.
- Road to Avonlea* (television series). (1990–1996). 91 episodes. Sullivan, K. and Grant, T. (Executive Producers). Toronto: Sullivan Entertainment.
- Robinson, L. M. (1999). "A born Canadian": the bonds of communal identity in *Anne of Green Gables* and *A Tangled Web*. In: Gammel, I. and Epperly, E. (Eds.) *L. M. Montgomery and Canadian Culture*. Toronto: University of Toronto Press, 19–30.
- Rootland, N. (1996). *Anne's World, Maud's World: The Sacred Sites of L. M. Montgomery*. Halifax: Nimbus Publishing.
- Rubio, M. H. (1994). Harvesting thistles in Montgomery's textual garden [Introduction]. In: Rubio, M. H. (Ed.) *Harvesting Thistles: The Textual Garden of L. M. Montgomery, Essays on Her Novels and Journals*. Guelph, ON: Canadian Children's Press, 1–13.
- Rubio, M. H. (1999). L. M. Montgomery: Scottish-Presbyterian agency in Canadian culture. In: Gammel, I. and Epperly, E. (Eds.) *L. M. Montgomery and Canadian Culture*. Toronto: University of Toronto Press, 89–105.
- Rubio, M. H. (2001). "A dusting off": an anecdotal account of editing the L. M. Montgomery journals. In: Buss, H. M. and Kadar, M. (Eds.) *Working in Women's Archives: Researching Women's Private Literature and Archival Documents*. Waterloo, ON: Wilfrid Laurier University Press, 51–78.
- Sheckels, T. F. (1999). Anne in Hollywood: the Americanization of a Canadian icon. In: Gammel, I. and Epperly, E. (Eds.) *L. M. Montgomery and Canadian Culture*. Toronto: University of Toronto Press, 183–191.
- Squire, S. J. (1992). Ways of seeing, ways of being: literature, place, and tourism in L. M. Montgomery's Prince Edward Island. In: Simpson-Housley, P. and Norcliffe, G. (Eds.) *A*

- Few Acres of Snow: Literary and Artistic Images of Canada*. Toronto: Dundurn Press, 137–147.
- Stoffman, J. (1998). Anne in Japanese popular culture. *Canadian Children's Literature* (Littérature canadienne pour la jeunesse) 91–92, 53–63.
- Sullivan, K. (Director) and McHugh, F. & Sullivan, K. (Screenplay) (1990). *Lantern Hill* (television movie). Toronto: Sullivan Films.
- Sullivan, K. (Director) and Sullivan, K. (Writer) (1987). *Anne of Green Gables: The Sequel* (television miniseries). Toronto: Sullivan Films.
- Sullivan, K. (Director) and Sullivan, K. & Wiesenfeld, J. (Screen adaptors) (1985). *Anne of Green Gables* (television miniseries). Toronto: Sullivan Films.
- Trillin, C. (1999). Anne of red hair: what do the Japanese see in Anne of Green Gables? In: Gammel, I. and Epperly, E. (Eds.) *L. M. Montgomery and Canadian Culture*. Toronto: University of Toronto Press, 213–221.
- Tye, D. (1994). Multiple meanings called Cavendish: the interaction of tourism with traditional culture. *Journal of Canadian Studies* (Revue d'études canadiennes) 29.1, 122–134.
- van der Klei, A. (2002). Avonlea in cyberspace, or an invitation to a hyperreal tea party. In: Gammel, I. (Ed.) *Making Avonlea: L. M. Montgomery and Popular Culture*. Toronto: University of Toronto Press, 310–316.
- Wachowicz, B. (1987). L. M. Montgomery: at home in Poland. *Canadian Children's Literature* (Littérature canadienne pour la jeunesse) 46, 7–36.
- White, G. (1995). L. M. Montgomery and the French. *Canadian Children's Literature* (Littérature canadienne pour la jeunesse) 78, 65–68.
- Willis, L. (1976–1977). The bogus ugly duckling: Anne Shirley unmasked. *Dalhousie Review* 56.2, 246–251.
- York, G. (2000). On Iranian TV, Avonlea rules (4 Mar.). *Globe and Mail* A1, A21.

## Chapter 45: Slash Fiction/Fanfiction

ROCHELLE MAZAR

### 1. FANFICTION: VIRTUAL REVISION

Fan fiction (otherwise known as fanfiction, fanfic, or simply fic) is the product of unauthorized writers taking characters and settings from television shows, movies, comics, or books and writing stories about them. In the 1970s fan fiction writers helped to keep Star Trek culture alive and well long after the show itself was cancelled; they collected stories about the adventures of Captain Kirk and his crew in mimeographed and stapled zines and handed them out at conventions. The topics of these stories ranged from simple episodic crusades like those seen on the show itself to heartfelt romances between any and all characters, including, infamously, Kirk and Spock.

Since the explosion of the internet, fan fiction audiences have become crowded places; name a show, book, personality, video game, or other form of pop culture and you can find fan fiction for it. Fanfiction.net<sup>1</sup>, which archives fan fiction from multiple fandoms, has hundreds of categories with thousands upon thousands of stories. There are more than 87,000 stories about the boy wizard Harry Potter at fanfiction.net alone.

Fan fiction itself is generated primarily by women of all ages, sitting at home in front of computers tapping madly into keyboards to complete often novel-length stories about their favorite characters. They do not do it for the money, of which there is none to be gotten; they do not even do it for fame, since most fan fiction writers guard their real life identities very carefully. They do it because they love writing their stories, they love the characters that are not theirs, and they develop a commitment to the community they discover when they start to share this love with others.

While corporations are often uncomfortable and sometimes litigious over what they consider to be copyright infringement and misuse of intellectual property, fan fiction communities are possibly some of the richest learning environments online.

### 2. FANFICTION AS WRITING WORKSHOP

“I’ve learned a lot from writing fan fiction”, says Ivy Blossom, who writes Harry Potter stories.<sup>2</sup> “I used to write a lot when I was in high school but I stopped, and didn’t write anything until I found fandom online. I look back

at my early stories now and cringe, I've learned things I was never taught in writing classes".

"There are books and books and books written about what writing workshops do to writers and their talent", says Shallya,<sup>3</sup> "and for me, fandom is like a big writing workshop. Just, you know, with a lot more people".

One of the reasons why fan fiction writing can be such an intense workshop is the fact of a built-in audience. Anyone can write fan fiction, and the community of fans often creates spaces where those stories can be archived and shared with others.

Fictionalley,<sup>4</sup> which owned and maintained by Heidi Tandy, a copyright lawyer in Florida, has an upload interface where Harry Potter fan fiction writers can describe their story and submit it to the moderators for archiving. If accepted, it will appear online, on a site where, every day, thousands of users turn their browsers to read stories just like them. Other archives, like Level Three<sup>5</sup> in the Smallville fandom or the multifandom archive Skyhawke,<sup>6</sup> have automated archives where writers upload their stories and they appears online immediately, without moderation.

One of the hallmarks of fan fiction many communities is their emphasis on feedback; archives like fanfiction.net and fictionalley have database systems or message boards in place specifically to house the reviews for stories they archive. Other archives, lacking such technology, add a note at the end of every story encouraging readers to respond to the author directly, and posting their e-mail address for that purpose. In practical terms, this means that stories written on personal computers anywhere from Singapore to Idaho are readily available and organized within hours of being posted, and are open to commentary.

Many fan fiction readers are notoriously critical. They are not likely to pass over spelling or grammatical errors in silence. Destina, a writer in the Smallville fandom, writes, "Many grammar rules are not really flexible. Nope. Not really. You can break them, but first you need to understand them, and you need to break them in a way that makes \*sense\*. Especially the rules about punctuation. Don't wade into the deep water of 'this isn't really a rule' or 'but XYZ does this in her stories all the time' unless you know what you're talking about".<sup>7</sup> Submitting a story to fans is a serious proposition, and requires serious preparation.

A fanfiction writer is not only writing a story when they write fanfiction; they are entering into territory inhabited by many other fans. The characters writers animate are well-loved by their audiences, and the universes whose rules they bend and twist have housed thousands via television shows, books, comics. Every reader has a sense of what is legitimate (or "canon") behavior; when rules are broken or mistakes made, a fan will always notice. Readers and writers take these stories very seriously, and spend hours dissecting characteristics and situations, imagining alternative or unwritten scenes, or giving motivations to minor characters and bad guys.

“There are a thousand different ways to interpret even a single sentence that JKR [J. K. Rowling] has written”, says Harry Potter fan Erin Miran.<sup>8</sup> “And just when you think every possibility’s been thought of, someone comes along with something new”. There is a constant drive in fan fiction communities not only to write a well-crafted, carefully plotted, well-written story, but also to have an original take on someone else’s universe. Response to a story can be overwhelming if a writer gets everything just right. “Some people may say fanfiction is a good testing ground for insecure writers because it provides that existing universe as background”, says November Snowflake.<sup>9</sup> “That’s oversimplifying the matter, and does a disservice to the (perhaps surprising number of) experienced writers who make up the fandom. The challenge of fanfiction lies in staying true to canon, while still infusing it with your own vision”.

With that pressure in mind, along with a deep thirst for feedback, the stories produced by many fan fiction writers are often astounding and highly creative. All genres can be found within a single fandom, from noir to romance to high adventure and even historical drama. Modern characters can be taken out of their original context and placed in, for example, Victorian England, or Byzantium, or in a Roman amphitheatre. Sometimes characters even morph from men to women, or women to men, who find themselves body snatched and suddenly living someone else’s life, or the life they could have lived had certain decisions not been made. These stories are called “AU”, or Alternate Universe. Buffy can become a Vampire or a courtly Renaissance lady; Fox Mulder can be revealed as an alien clone; Lex Luthor can avoid going to the dark side and decide to defend Clark Kent instead of trying to destroy him.

In spite of all the creative space available in fandoms to create new stories, the characters themselves are still known quantities. They have “canon” characteristics and back stories that need to be respected and acknowledged in fan fiction. Readers are quick to point out when a character is less than believable, when a point from the original show or book has been left out or forgotten, or when characters behave in ways that aren’t consistent with the original source. On a community journal for the *Due South* fandom, Laura Shapiro posts, “I just don’t think it’s in character for Vecchio to put a smiley face on an official form. He wouldn’t be as uptight about that as Fraser would, but it still doesn’t seem like something he’d do. Do you agree?” Posting fan fiction online is an act of offering up one’s interpretation of a beloved character to people who not only love him/her, but have read hundreds of other variations on the exact same idea.

“I started writing fan fiction in order to get feedback on my writing style”, says Libertine, a Harry Potter writer who moderates a large mailing list for fans called *veelainc*.<sup>10</sup> “In comparison to the feedback you get on original fiction, the response for fan fiction is overwhelming—people have a genuine



interest in what you're doing". Writers and readers have a very open back and forth exchange over ideas, grammar, writing style, and characters. There is no fourth wall in fan fiction; when a writer posts or archives a new story, their highly critical readers will return opinions on it. The reviews of one story written by Ivy Blossom show the wide range of criticism fan fiction can get:

Kami writes: "Ok . . . that was a little weird". Meanwhile, Nupil provides a more grammatical and literary review: "You're short sentences are probably the most effective thing in your piece of writing. It gives a sense of speed and urgency yet at the same time something that's not fully comprehended. Like a start. Stop. Start. Stop feeling to the fiction, that reflects his mind. The first person makes it seem kind of colloquial—you can imagine him telling this story to someone. Also the language is simple—no windy in-depth descriptive sentences, just every day words".<sup>11</sup> Through this dialogue of story and feedback, fan fiction writers have what authors of original fiction can only dream of; an audience of thousands who are prepared to critique their work and suggest ways to make a story better. It's a kind of instant gratification that few other forms of writing can achieve.

One of the characteristics of many fan fiction communities is the serial story; long, multichapter epics that sometimes take years to complete. Like Dickens, authors must learn not only to plot on a grand scale, but to write within the restrictions of their own story in progress, under the eye of sometimes thousands of fans desperately waiting for the next chapter. As any novelist will attest to, large plots are difficult to plan and even more difficult sustain throughout the writing process. Fan fiction writers learn as they go in an open forum, discovering via public feedback what plot elements are most popular and most effective, and how to write stories that can, in the case of Cassandra Claire's *Draco Trilogy*,<sup>12</sup> total in the hundreds of thousands of words while remaining entertaining and internally consistent. "Though I have no real writing work ethic, I write epic fan fiction", says Libertine. "One of the only reasons I managed to make it to the ends of the stories (one of which is well over 100,000 words) was because of the public support I received".

Writing and posting fan fiction is not an isolated activity at any stage; discussions of ideas for stories, called "plotbunnies", occur on message boards, mailing lists and journals; many writers post what they call "cookies" in public, snippets of the story they're working on that acts as a teaser for their readers. When a story has passed through its first few drafts, it is generally handed over to a trusted editor known as a beta reader. The beta reader edits grammar, word choice, plot, characterization, canon inaccuracies, or whatever else they happen to notice. This process is a learning experience for both the writer and the beta reader, and is the first line of feedback that helps the writers improve their basic skills. Fan fiction resources often provide listings of willing beta readers, and the first goal of a fan fiction writer is to find

one that works well with them. The first words out of a reader's keyboard if they see obvious problems with a story are, "get a beta reader". Fan fiction communities expect writers to take their own writing seriously enough to seek out a decent editor, and sloppy writing will always be noted, regardless of age or experience. In this way, fan fiction communities force writers to take stock of their abilities and improve their writing through trial and error.

While fanfiction communities often work as elaborate grammar and plot workshops, this feature is not the only element that serves to define them as highly sophisticated writing communities. In order to write realistic stories set in other times and places, writers dig into all kinds of resources to learn how to make their stories authentic. Juliette Torres, writing in the *Pirates of the Caribbean* fandom, says, "I've been reading a lot of articles about pirates, and about 18th century-wigs, and about corsets—everyone talks about the Victorian corsetry, the tight-lacing, because that's the kind that makes for the sixteen inch waists and bent ribs and crushed spines, and it's hard to find information on earlier corsets. I read and participated in a long, technical discussion of the biology of Scarrans and hybrids on *Farscape* which involved use of commercial bananas as an example of a species that's been bred to sterility".<sup>13</sup> Another writer going by the name of Lady Angel says, "I have researched everything from ancient Roman bathing customs and ship routes in the 10th century to German names at the turn of the last century to lasers and heroin withdrawal".<sup>14</sup> Fan fiction writers seek out maps of places they've never been, lists of foods available in certain areas, rail schedules, and even seek out phrases in languages they don't speak to lend authenticity to their stories.

Such detail is certainly appreciated in fan fiction communities; any story set in England but written by an American will be ruthlessly pulled apart by readers known as "brit-pickers": "I still remember the time I referred to eggplant parmesan in a fic", says Ivy Blossom. "To this day I get e-mail reminding me that in the UK, an eggplant is an aubergine".

But fanfiction communities are not only populated by writers and readers; they are also the home of fan artists, who draw their favorite characters and scenes from their favorite fan fiction stories. They create art as a form of feedback, thanks, and as creative expression all on its own. In fandom, artists find a place to hone their skills; they have ready-made models and a built-in audience who will critique or bubble over with joy over their work. With the wide variety of styles already present in fandoms, artists can glean tips from each other by discussing their work or by just admiring the finished pieces of those artists they admire.<sup>15</sup> Fandoms attract a wide range of artists, both amateur and professional. There are even a few tattoo artists in fandoms, etching tribal symbols onto the pristine skin of copyright protected characters.

Much of fandom is defined by sharing creative energy; fans share and debate their original source material, write about and draw the same characters,

and develop fandom conventions often called “fanon”. The creation of fandom motifs is a group project in which every member of a given fandom participates. Characters go in and out of style over time, and certain characteristics get applied to characters so often that fandom members become uncertain whether they are part of the original source or not. In that sense, there is a certain fandom zeitgeist in which all writers and artists produce their work; they are constantly in dialogue not only with each other, but with the microculture in which they all exist, the paradigms they must either adhere to or shift.

### 3. BREAKING ALL THE RULES: FANFICTION TRANSGRESSION AND DISCOURSE

This kind of learning environment, where so much is already a shared creation, can result in tension. Plagiarism is a dark word in fandom communities, in spite of the fingers pointed at them by corporations calling them all plagiarists to begin with. In truth fandom environments come equipped with their own plagiarism watchdogs, often adhering to a more stringent definition of plagiarism than many outside fandoms would.

Any vague trace of original plots and ideas are closely guarded by artists and writers, sometimes too zealously. Penelope Z, who writes in multiple fandoms, notes: “I find it’s very stupid to consider someone plagiarizing a fic just because it shares a common general idea, that is not even a unique thought of the author. I’ve just read a very nice SV [Smallville] where Lex steals Clark’s T-shirt, being obsessed and all. Is this supposed to be a copy of Sweater Stealer [a popular story]? I’m sure the author is not even aware of that fic”.<sup>16</sup> When one artist’s style too closely resembled another’s in the Harry Potter fandom, for example, she was quickly reprimanded and the files of her art were removed from the community where she had posted them. One artist commented, “copying is good for learning, but not for posting online or in a RL gallery. I’m not sure if it’s naivete or enthusiasm that is blinding you, but I get the feeling that maybe you aren’t very aware of how the art world (online and IRL) sees tracing, copying, and appropriation of style”.<sup>17</sup>

Accusations of plagiarism based on style, plot ideas, and concepts as well as word for word copying fly around fandoms fairly regularly, forcing all artists and writers to work extra hard to find their own unique voice. Far from a collection of random fans posting pencil-drawing fantasies and half-hearted erotica to the internet, fandom communities are complex environments where participants are expected to learn not only from their own mistakes, but from the mistakes of others, and to offer something new and thought provoking to a community constantly in flux.

While most fandom communities have a strong fan fiction element, even among fan fiction aficionados there is far more to fandom life than writing or drawing. The nature of writing extra-canonical stories creates tension and argument among fans; one person's interpretations are bound to conflict with another's. One of the issues that cause the most tension among fan fiction communities is the presence of slash fan fiction, a subset which is characterized by same-sex romantic pairings.

The term "slash" comes from the / symbol, which is traditionally used as part of a story header to mark the main pairing in the narrative. Kirk/Spock in the early Star Trek fandom was the first couple to be "slashed", and many fan fiction readers and writers object to what has become known as the slash fandoms. Some homophobic comments in a forum will invariably cause a raging debate in any fandom: What is homophobia? What is and is not acceptable for a fan fiction writer to write about? Are children's books exempt from same sex romantic leads by nature of their intended audience? Is slash fan fiction unfair and disrespectful to the actors who portray television characters? These questions return over and over again as some elements of a fandom take issue with another element, emerging members of a fandom in a timely social debate and providing endless arguments on either side.

Discussion about the source material is always par for the course in fan fiction communities, regardless of whether or not a specific comment has sparked it. In television fandoms, a critical appraisal of each new episode is expected from many fans, and as soon as the credits begin to role they hop online to read and comment on the varying opinions. Thamiris, a writer in a variety of fandoms and an English professor at a Canadian university, posts thoughtful essays on canon material on a regular basis. In her insightful cross-fandom essay entitled "Domestic Penetration", she writes, "There's something undeniably penetrative when one man invites another into his home, when one man invites himself in. *Mi casa es su casa*, Methos says as Duncan enters his house uninvited, a come-on so queer that the set designer's forced to display naked statuesque tits complete with erect nipples beside Duncan's head in a laughably impotent reminder of canonical heterosexuality".<sup>18</sup> Fans will spot metaphors and interpret scenes and dialogue with the wit and skill far beyond that of typical television critic.

Likewise, in response to the release of *Harry Potter and the Order of the Phoenix*, Cassandra Claire writes, "I think part of the bleakness of this book can be explained by the fact that Harry is now in the belly of the beast, to return to the pure archetype of the hero's journey. This is the hero's lowest point, at which he is transitioning between selves. This is the death of the hero's childhood/immature period, and the birth of himself as a new person".<sup>19</sup> Fan fiction writers engage with their subject on a level normally reserved for university classrooms, and these discussions of metaphor and archetype are open to the entire community for consideration and debate.

#### 4. FANFICTION AS TECHNOLOGY WORKSHOP

One of the critical skills that any participant in fandom acquires over time in fandom are technological skills. Even casual writers learn some HTML in order to present their stories properly. Many writers and artists maintain their own websites to showcase their work. Artists scan images they sketch on paper, color them using a variety of graphics software, and post them where other members of their fandoms can see them and comment.

A specialist group of fans known as “vidders” use clips from television shows and films to make “vids”, video montages set to music and highlighting themes that interest the vidder, skewing the source material to tell the story the way the vidder wants to see it told. Old school vidders created these forms of post-modern art using a VCR; today more and more vids are being created using video software such as Adobe premiere and imovie. Experienced vidders hold formal and informal workshops to help others learn these skills; there are mailing lists dedicated to tips and tricks of viding. While many broadcasters and corporations are uneasy about such art forms, which make use of often-pirated material, in fact vids provide some of the best forms of advertisement for those same corporations.

Fan fiction archivists seek out web technologies that can help readers communicate with writers; java comments, tag boards, blogging software, message boards, php-nuke, and more. Television without Pity and Panfandom.com, for example, are multifandom message board and newsblog system established by fans who saw a need in various fandoms and learned the skills required to fill them.<sup>20</sup> Fandom members with the know-how also create uploading scripts and database programs to make archiving and story searches easier. Moderating teams are established to maintain mailing lists or design and update webpages and resource lists. Fandom websites are constantly changing to meet the needs of a community whose populations regularly shift and change.

Participants in fandoms use whatever means they can find to communicate and share with each other. One of the fandom activities that requires the most innovative uses of technology is collaborative writing, something that standard software programs don't facilitate well over distances. Different writers collaborate in different ways; some write stories by swapping chapters by turn, passing files to each other through e-mail or file transfer programs. Others write line by line with another writer in programs like instant messengers. Writers Libertine and Ivy Blossom, in Australia and Canada respectively, wrote a story together by taking turns inputting lines into an IRC chat room, and then copying the transcript into a word processing program. Technology for fan fiction writers is a means to an end, and in order to participate and produce the results they can imagine creatively, they need to learn about software and their capabilities in order to use them in non-traditional ways.

## CONCLUSION

Fanfiction communities exist on the edge of legality; while currently fanfiction is not strictly illegal, copyright owners have repeatedly sent cease and desist letters to fans in the name of hapless children, decency, and the law. Some authors against fan fiction for legal and moral reasons. Ursula Le Guin says, “it is lovely to ‘share worlds’ if your imagination works that way, but mine doesn’t; to me, it’s not sharing but an invasion, literally—strangers coming in and taking over the country I live in, my heartland”.<sup>21</sup> After a crack down on fan fiction writers, Anne Rice firmly stated: “I do not allow fan fiction. The characters are copyrighted. It upsets me terribly to even think about fan fiction with my characters. I advise my readers to write your own original stories with your own characters. It is absolutely essential that you respect my wishes”.<sup>22</sup>

Certainly not all writers and copyright holders feel this way; fictionalalley, a Harry Potter fan fiction archive, is affiliated with Harry Potter copyright holder Warner Brothers. Smallville fans enjoy references to message boards and nods from actors. Many television shows have spin-off novels; a published form of fanfiction.

## ENDNOTES

1. <http://www.fanfiction.net>.
2. Ivy Blossom was interviewed over AIM in February 2004.
3. Shallya was interviewed over AIM in February 2004.
4. <http://www.fictionalley.org>.
5. <http://www.smallvillefanfic.com>.
6. <http://www.skyhawke.com>.
7. Destina Fortunato, “Fanfic writers and public critique/reviews: One writer’s blunt opinion”. Available at: <http://www.lyricalmagic.com/publiccrit.html>.
8. Erin Miran interviewed over AIM in February 2004.
9. November Snowflake interviewed over AIM in February 2004.
10. Libertine was interviewed in January of 2004 over Yahoo Messenger. Her mailing list can be found at: <http://groups.yahoo.com/group/veelainc>.
11. <http://www.livejournal.com/users/ivyblossom/304455.html>.
12. Cassandra Claire’s *Draco Trilogy* can be found here: [http://www.schnoogle.com/authorLinks/Cassandra\\_Claire](http://www.schnoogle.com/authorLinks/Cassandra_Claire).
13. Juliette Torres was interviewed via messageboard in March 2003.
14. Lady Angel interviewed via message board, March 2003.
15. <http://www.livejournal.com/community/hpart>, for example.
16. Penelope Z interviewed via message board, October 2003.
17. <http://www.livejournal.com/community/hpart>.
18. <http://www.livejournal.com/users/thamiris/143735.html>.

19. <http://www.livejournal.com/users/epicyclical/145816.html>.
20. see <http://www.televisionwithoutpity.com> and <http://www.panfandom.com/nuke/>.
21. Ursula Le Guin, "FAQ".  
[http://www.ursulakleguin.com/FAQ\\_Questionnaire5\\_01.html#FF](http://www.ursulakleguin.com/FAQ_Questionnaire5_01.html#FF).
22. Anne Rice, <http://www.annerice.com>.

## Chapter 46: A Critical Eye for the Queer Text: Reading and Writing Slash Fiction on (the) Line

RHIANNON BURY

*Women's Studies Programme PAS 3010, University of Waterloo, Waterloo, ON, Canada*

In the first half of the 21st century's first decade, information and communication technologies, commonly referred to as internet technologies, are embedded into the lives of most middle-class North Americans. According to Nielsen/NetRatings, over 200 million Americans over the age of two had internet access by August 2004. Of those, 137 million were classified as "active" users who accessed the web pages tracked by Nielsen (ClickZ Stats, 2004a). In the United Kingdom, 24 out of the 34 million who have internet access are considered active users (ClickZ Stats, 2004b). Judging by the proliferation of chat rooms, Multi-User Domains (MUDs), Usenet newsgroups, message boards, and electronic mailing lists, what is being sought out is not only information and/or entertainment but interaction with others using both synchronous and asynchronous forms of communication. Scholarly investigation of computer-mediated communication has drawn attention to the complex ways in which identity and community are produced in a range of cyberspaces. While a body of literature that critically examines issues of gender and to a lesser extent, race and sexuality, has taken form, little has been written about class beyond the digital divide between the information "rich" and "poor".<sup>1</sup> At its broadest, this chapter is an attempt to map out the *performance* (Butler, 1990) of gender, sexuality, and class on an electronic mailing list made up of fans of the Canadian television series *Due South* (DS).

*Due South* was co-produced by and aired on the American network CBS from 1994 to 1996. After cancellation by CBS, two more seasons were made with Canadian, British, and German funding. For those unfamiliar with the series, the lead character is Royal Canadian Mounted Police Constable Benton Fraser who is on assignment in Chicago. He works closely with Chicago police detective Ray Vecchio and then with Stanley Ray Kowalski.<sup>2</sup> Fraser (usually referred to by the other characters and DS fans by his last name) is regularly seen on duty in full dress uniform or at the very least with his wide-brimmed RCMP-issue hat on head or in hand. "Thank you kindly" is his motto, a phrase he offers up several times an episode. While a "do-gooder" and a "goody goody", Fraser is also well read, well spoken, loyal, and not as naive as he appears to be. Both Rays find Fraser eccentric and exasperating but at the end of each episode, they come to see the superiority of his polite, honest, and quirky Canadian ways.



In 2002, I spend 4 months conducting an ethnographic study with The Militant RayK Separatists (MRKS). Its members, all female with one exception, are readers and writers of a genre of fanfiction known as slash. Writing stories about characters of a favorite television program is a means of extending the meanings and pleasures of the primary text. *Fanfic*, as it is called by those who produce and consume it, can be traced back to the original *Star Trek* series of the 1960s. Although women were traditionally a minority in science fiction fandom, a large base of “character fans” formed around *Star Trek* (Boyd, 2001). These female fans were not necessarily attracted to the themes of space exploration or conflict but rather interested in the relationships between the characters. As existing zines began to include fic and then new zines dedicated to fiction were set up, a space for female fans eager to move beyond interpretation to production opened up. Curtin (2003) did a statistical analysis of zines archived at Temple University and estimated that pre-1967, only 17% of zine publishers were female. By 1971, an astonishing 83% were female. Writing in the mid-1980s, Camille Bacon-Smith estimated that 90% of all stories were written by women (referenced in Jenkins, 1992).

There are several genres of fanfic, including *slash*—stories that involve same-sex relationships between male or female characters who have been written as heterosexual in the series. The term slash came into use because of the typographic symbol signifying the same-sex pairing, as in K/S for Kirk/Spock. MRKS members thus pair Fraser exclusively with the “second” Ray (“RayK”). This private list was founded in October or November 1999 by five members of Serge, a public *DS* slash list that emphasized the BF/RK pairing. It began with 25 members and had grown to 40 by 2002. Twenty-two members agreed to participate in the research project, including the sole male member. After examining the role of the internet in popularizing fanfiction in general and slash in particular, I focus on the pleasures of reading and writing BF/RK slash. I argue that these pleasures are not only related to queer desire but high standards of writing and adherence to the primary text (referred to as “canon”).

#### 1. A WHOLE LOT OF SLASHING GOING ONLINE

In recent years, there is growing evidence that slash is moving from the zine to the screen. In her study on slash fiction, Boyd (2001) found that of the 210 adult readers and writers who completed her questionnaire in late 1999, 70% did not limit their publication to print zines. In addition or as an alternative they named websites (personal and archives), listserves, and the sharing of stories with friends through e-mail. To find interested participants for her survey, Boyd searched 364 web pages and 129 mailing lists. I did a search using Google

and came up with one site, [www.fictionresource.com](http://www.fictionresource.com), which contained 720 links to websites dedicated to some form of slash fanfiction. With no link to the MRKS website, I can be certain that it is incomplete. While my sample is far too small to make a generalizable claim, the participant responses do support Boyd's findings. Only three out of the 13 respondents came to slash through print zine culture:

I first remember hearing about slash waaaay back in the 1970's when I was in high school. I heard slash mentioned in connection with Star Trek the Original Series (though we just called it Trek because there were no later shows yet), and also Starsky & Hutch. There was a local science fiction bookstore called Lois Newman's which kept a stock of fanzines that you could go in and read at your leisure. I read a (very tame by my current standards) Kirk/Spock story and was shocked. At the time I thought it was weird and strange and kinky and wrong. Hah. Little did I know that two decades later I'd be writing it;-D.

**(Drucilla)**

In the 1970s, when I was in college . . . friends were writing and editing some of the original Kirk/Spock zines. I thought the zines were fun and silly, but didn't really get that involved with slash until I started reading and writing it in the early 1990s.

**(Marguerita)**

As a long-time science fiction fan, I caught the second wave of ST:TOS [The Original Series] fever. . . . The first time I heard that people were writing K/S was in one of the 'underground' free magazines—the type that flourish around university campuses. These publications tend to be very liberal on all fronts—sexual included.

**(Estraven)**

It is not the age of these respondents that distinguishes them from the others—all but two were between 36 and 45. Rather, it was their longstanding connection to science fiction and *ST:TOS* fandom. As high school or college students, they had come across print zines in science fiction book stores or on campus.

The rest discovered slash through online forums and/or searches related to a particular fandom. In the case of Phoebe, Clegret, and Tikva, it was DS. Others named were *The X-Files* (Alain), *Star Trek: Deep Space Nine* (Jeanne), *Highlander* (Meghan), *Sports Night* (Penelope), and *Star Wars* (Thea). Some discovered slash by accident through a search for general fan information; others were referred to specific slash sites by friends and acquaintances from

both “real life” and online contexts. Kenzie’s story is interesting as she was referred to DS slash by her female life partner:

My partner found it first and was hesitate [sic] to tell me about it. She finally broached it by telling me she had found some websites where people had written stories about these characters and had made them into couples. And that it was pretty explicit. My first reaction was “oh, so they’re writing gay porn about fictional characters?” It was fine that she was reading it, I didn’t care. I was writing my dissertation and didn’t have time for other stuff. Well, she was going to visit her family one weekend and before she left she said “go to [www.hexwood.com](http://www.hexwood.com)”. So I did and well, forget the dissertation. I fried my eyes reading all weekend and that was that. I’ve been hooked ever since.

In light of the above, it will come as no surprise that all participants primarily accessed slash online. Of those who had pre-internet exposure to slash, only Marguerita mentioned that she continued to read print zines, though Jeanne remarked on buying “the odd zine over the years”. Some members—Clegret, Tikva, Kenzie—only accessed a few DS archives, author websites, and lists including MRKS while others like Meghan and Marguerita put the total number for all fandoms at a hundred and several hundred, respectively. As for the writers, six out of the nine had produced between two and 10 DS stories by the first half of 2002, and these were “published” on personal websites, sites such as “Exwood” (DS Archive), Due Slash, as well as announced on or posted to MRKS, Serge, and/or Asylum. Drucilla had written the most DS slash with 31 stories and Phoebe was next with 21. Given their long association with fandom, Marguerita and Drucilla had produced the most fanfic overall at 50 and 68 stories, respectively. The former also published in print zines. Moreover, it would seem that print zines are being created as a result of online story production. *Serge Protector* is the first and only zine dedicated to BF/RK slash, yet it also has a web version. At the time of writing in early 2004, four participants are listed as having stories published in the latter.

In light of the above, it is safe to claim that the production of fanfic in general and slash in particular has increased exponentially with the networks of distribution afforded by information and communication technologies. This increase directly correlates to the dramatic increase in the number of women with access to the internet in the past 10 years. In 1994, 94% of users were male, the majority of whom worked as computer professionals (Graphics Visualization & Usability Center, 1994). By 1998, women comprised 33% of internet users and 48% of new users. (Graphics Visualization & Usability Center, 1998). Since 2000, a range of internet surveys have confirmed that gender parity among male and female users has been reached. When I asked the MRKS members about the participation of men in online DS slash forums, all indicated that very few men were involved. Two stated that they would not

join a list that intentionally excluded men but admitted that this was not really an issue. Jeanne described slash as a “woman-centric genre”.

## 2. QUEER AS FEN<sup>3</sup>

Slash has been described by Russ (1985) and Penley (1991) as “feminized” pornography that rejects anonymous, emotionless sexual encounters informed by patriarchal relations of power. Lamb and Veith (1986) take the opposite approach, positioning slash as a reworking of the romance that rejects the role of passivity and subordination of the heroine. I argue, however, that slash is best understood as a *queer romance*. Four of the participants said that they particularly enjoyed “first-time” fic, that is, stories involving the realization of the two characters that they are both in love with and sexually attracted to each other. Two also mentioned the pleasures of reading about romance or a romance/sex combination. Similarly, “angst” stories that emphasize heart-break were thought of favorably by four participants, Thea explaining that it “makes the happy endings all the sweeter!” Alain (not the male list member) made a direct parallel with the published genre of romance:

This is no different to me except that slash is not work that is likely to be commercially available. In many cases, the quality of slash writing actually surpasses the published work I read, although of course there is a great deal of dreck in both fanfic and published work. It makes me sad sometimes that the brilliant slash writers I read are not likely to find a broader audience unless they write about a more conventional subject.

“Conventional” in this context obviously means “heterosexual”. Jeanne and Kenzie, however, emphasized the difference between the published romance and slash, noting that slash had more “depth” or was free of the genre’s restrictions. Phoebe stated her dislike of “harlequins” but recognized that some slash did resemble them and that she disliked that type of slash as well. At the same time, members wanted stories to contain graphic descriptions of homosexual oral and anal sex, although most rejected the term pornography:

Gay porn tends to be, well, different. Less relationship-oriented. More into action than interaction, if you know what I mean.

**(Blue)**

If there’s a relationship and an emotional attachment between the characters that comes through in the story, then it’s erotica. If it’s pure sex with no characterization or development, or if it’s patently obvious that

the writer is only writing to get off, or get the reader off, then it's porn. And neither is good or bad, they just are.

**(Kenzie)**

Anonymous. Quick couplings of various permutations. Partners chosen strictly by their appearance. Underlying theme that the appearance was enough to insure compliance, since this was a purely sexual act. It was nothing like the slash that I cherish.

**(Estraven)**

The MRKS position is best summed up by Kenzie who wanted to read about “men being men” and “men having sex with each other within the context of a loving relationship”.

Doty (1993) defines queer texts or textual elements as “a range or a network of non-straight ideas” in which the lesbian, gay and bisexual, or other non-normative sexuality are combined (p. xviii). Moreover, he talks about gay, lesbian, and queer pleasures of the texts depending on the location of the reader. For example, he notes, “you might identify yourself as a lesbian or as a straight woman yet queerly experience the gay erotics of male buddy films” (p. 16). Ultimately, “queer reception . . . stand[s] outside the relatively clear-cut and essentializing categories of sexual identity under which most people function” (p. 15). All but two participants made direct reference to these queer pleasures of the buddy/action story transformed into erotic romance:

I'll be up front and say it's sexually stimulating. Guys like F/F porn, women like slash. It's nice to 'see' all that maleness—it's [sic] intrigues me. Reading detailed descriptions of some woman's sexual responses doesn't turn me on but reading about some guy's sexual responses? Oh yeah; -D

**(Drucilla)**

It's hard to define. All I know is that reading about a male/male relationship titillates me.

**(Penelope)**

The range of queer desire is illustrated by the following two responses:

[I]t's what I told my husband when he finally broke down and admitted that he thought slash and homosexuality were just sick and that I was a lesbian because I liked it. <G> I said, “If one is good, two are better.” And that's a big part of it—just that it's two guys. I have decided I'm really pretty heterosexual—guys do it for me, and so do their sexual organs.

I've definitely become more aware of good looking men and nice bodies since reading/writing slash too.

**(Phoebe)**

As bisexual women in a monogamous lesbian relationship, it is nice to have some men in our lives!

**(Clegret)**

For Phoebe, her sense of heterosexuality is heightened while Clegret is able to explore the multiplicity of identification and desire, refusing a singular identification as lesbian. Others, on the other hand, gestured toward the imbrication of desire with a gay politics:

I read and enjoy slash on two levels. At the basic level, it feeds my kinks and gives me a thrill to read really good slash where the author has taken the time to work on the characters. It doesn't have to have a great plot, or any plot. Just good characterization and sex. On another level, there is the whole two men realizing, sometimes for the first time, they are in love with their male partner and dealing with all the ramifications that go with such a revelation.

**(Meghan)**

Also, it's an undeniable turn on for me to read a well-crafted story with the well crafted sex-scene. I like those in M/F but in the original fiction. It's almost as if once I decide that a pair of guys is a couple, that's a turn on in itself, and I'm rooting for them to overcome, get it right.

**(Estraven)**

The "ramifications" and that which needs to be "overcome" are likely oblique references to heterosexism and homophobia that men who decide to enter into a same-sex relationship "in real life".

### 3. WHEN QUEER IS NOT ENOUGH

An underlying theme running through the above data samples is the *quality* of the fiction. Part of the "thrill" for Meghan, for example, was reading "really good slash where the author has taken the time to work on the characters." The "turn on" for Estraven was "a well-crafted story with the well-crafted sex-scene". Thus descriptions of two men kissing or engaged in homosexual, while queer, were not pleasurable in and of themselves. To date, scholars have paid little attention to this aspect of slash. Penley (1991) is the exception, discussing the importance of "good writing" in relation to "professionalism".

She describes the pleasures of receiving critical acclaim from readers but stops short of linking this discourse with class or, more specifically, with what Bourdieu refers to as *bourgeois aesthetics* (referenced in Jenkins, 1992). This term refers to the ability to maintain enough distance from the text in order to evaluate it critically and “objectively”. Fans in particular are accused of what Jenkins calls “sitting too close”, that is, being incapable of distinguishing “good” texts from “bad” and simply identifying with the characters on an emotional level. As university-educated women with at least one degree, the MRKS members had strong investments in this discourse and by paying close attention to the quality of the fiction, they marked themselves out as legitimate members of the middle class. In the quotations that follow, MRKS participants unpacked the term quality:

[A]ccurate characterization, attention to canon and then spelling and grammar, in order of importance, but the key is if they add up to a story that is pleasurable to read for its construction as well as its content. Some of the slash stories I’ve read are written so beautifully that images and whole paragraphs stick in my mind. As a writer, I frequently have serious “line envy”, wishing I could have written a specific piece of dialogue myself.

**(Alain)**

Writing, writing, writing. I want the characters to sound and act like themselves (voice is vital!). I want the sentences to flow. I like clean, well-crafted prose. I want to see believable [sic], meaningful situations that play out logically. And, sure, hot sex is nice, but I’d rather read a well-crafted story that merely hints at the slashy elements than a poorly written sex fest.

**(Meghan)**

I look for characterization first. I have to be able to “hear” the character’s [sic] voices in my head when reading slash; otherwise I won’t read it. Next most important thing is spelling and grammar. I’m an editor and if I find myself proofreading and correcting a story as I go, I can’t get through it. It’s literally too much like work. Another important thing is canon. Unless the story is labeled an AU [alternative universe], I expect canonical events and characterizations. Research is also very important. I know that some authors extensively research background events, locations, etc for stories and I appreciate that. I also expect that a story will have been beta’d by at least two people.

**(Tikva)**

Together, these three responses cover the qualities of “good” slash: characterization, part of which involves adherence to the primary text (“canon”),

a plausible, logical though not necessarily detailed or intricate plot, verisimilitude achieved through research, effective and accurate use of language and style, and finally editing (referred to in software testing terminology as a “beta”). The references to language use and style serve to highlight their function as *linguistic capital* (Bourdieu, 1977), a form of cultural capital. The “rules” of written expression, reaffirmed through classroom instruction and style guides and manuals, are but one variety of English but have become the standard against which all others are measured. Those unable to meet these standards can be understood as lacking sufficient linguistic capital. By contrast, those who possess high levels of such capital will be considered “good” writers and will thus be recognized as legitimate members of the university-educated middle class.

The issue of “canon” is the one feature unique to fanfiction. In the popular cultural context, the term refers to the characterization and character development across the history of the series. The importance of canon to the members of MRKS cannot be underestimated. When I joined the list, I received a welcoming Frequently Asked Questions (FAQ) detailing life histories, behaviors, and characteristics of both characters established in the episodes. Here is an excerpt around naming conventions:

\*Fraser introduces himself as “Benton.”

\*His father and other family friends and enemies call him Benton or Ben (Quinn, Eric, Buck Frobisher, Gerrard, Buck Frobisher’s daughter, Victoria, Mark Smithbauer).

\*The only person to call him “Benny” is Ray Vecchio.

\*Ray Kowalski calls him “Fraser, and, very occasionally,” Frase” or possibly “Red.”

\*Other policemen at the 27th, including Lieutenant Welsh, refer to him as “Red” or “Big Red,” although Welsh prefers to address him as “Constable.”

\*Thatcher also calls him Ben once (in WATE) when she’s trying to imply an intimate relationship between them for the benefit of Henri Cloutier who is harassing her.

As for Ray, he is called by this name by everyone except his father, an old friend, and his ex-wife, Stella, who call him Raymond. He is only called “Stanley” by his mother and no one calls him “Stan”. The FAQ is also humorous, noting incidents that are a nod to m/m pairing: “Vecchio and Fraser spend a lot of time in a supply closet at the 27th [division] in seasons 1 and 2. Ray K and Fraser never go into the closet in the 27th in seasons 3/4.”

Expectations that slash writers have an extensive and in-depth knowledge of canon may seem contradictory when there is not one scene in *DS* that depicts a homosexual relationship between Fraser and Ray. Yet, as these comments



suggest, the sexual orientation of the characters is not as “straightforward” as it may appear:

In a given work of slash, I could be convinced that either one is gay and has just been closeted (or in denial) for a lifetime, but it would take a damned good writer to make me believe it (unless it’s in an AU).

Generally, I do believe that Ray loved his wife (and that was a very long term relationship), and I believe Fraser was . . . well . . . if not in love with Victoria, then at least in lust/obsessed with her. However, I don’t see much in the way of chemistry between either of them and most of the female characters on the show (regulars or guest stars) and I \*do\* see chemistry between Fraser and Ray, so . . . if I have to attach a label, I’d say bisexual is the only sensible label for either of them, most of the time.

**(Jeanne)**

For the purposes of the fic I write/read, I would have to say bisexual, as each has had at least one serious het relationship in his past (as defined by the show’s history/canon). When I watch them on-screen, however, there is only the barest subtext—for all intents and purposes, they are straight. I can and do extrapolate in various ways, since neither has ever said anything canonical about their sexuality. Ray, in fact, has said he’d “try anything once,” and Fraser’s “only ever loved one woman” in his life . . .

**(Penelope)**

As Jeanne indicated, the only type of story that can legitimately and deliberately play fast and loose with canon is the story that is labeled AU or Alternative Universe.

In light of the above, I argue that knowledge of and respect for canon is a form of popular cultural capital (Fiske, 1989), based on Bourdieu’s notion of cultural capital. While Bourdieu was particularly concerned with higher education and “high” culture, Fiske redeployed the term to recognize the high symbolic value that popular culture carries in many quarters in contemporary North American society. As university-educated fans, the MRKS participants had investments in both traditional and popular forms of cultural capital, both of which came into play in assessing all genres of fiction:

In non-fan based work I still want characterization and plot and relationship development. I want it to make sense. However, in other original work I don’t have a context, or a mirror to hold it up against. So I can’t read it and say “this character would never do that” because I don’t have

a television show to provide me any past history. In that way, I guess I'm actually less demanding of mainstream fiction than I am of fan fiction.

**(Kenzie)**

What is on offer is a post-modern redeployment of bourgeois aesthetics: slash is not seen as derivative and of lesser value than "original" fiction; on the contrary, it is more highly valued because, unlike other texts, it can be held accountable for its intertextuality.

The result of these investments in critical practices was to create a rift between the MRKS community and the larger DS fandom. In one of the longer list discussions, Phoebe identified the two positions on writing slash as "craft" versus "fun". What particularly irked her was an attitude she has encountered which lumped all women in the "fun" category:

I have no problem with the concept that there are people out there writing for reasons different than mine. The only thing I object to is when I sense a gathering moral superiority and attempts to make one way the "only" way—that the "fun" way is better than the "craft" way, for instance, or the condescension of "it doesn't matter, it's just fanfiction/for fun/for women," which is actually a pretty damn insidious way of dismissing what we do, and dismissing (by implication) the people who take the craft of writing "just" fanfiction seriously much more completely than those writers who are "fooling around" or writing as an explicit (or implicit) leisure activity.

Oddly, Phoebe associates this anti-feminist position that women are not capable of or interested in bourgeois aesthetics with a feminist one about taking "ownership" of slash. Others contested this interpretation but agreed with her central argument. In another post, she criticized the "just for fun" position as an excuse to avoid the hard work that craft required. At the same time, she recognized that some writers might not have the required levels of cultural capital to produce well-crafted stories. Deirdre agreed with Phoebe, and positioned communities like MRKS who care about quality as a minority:

Far as I can tell, most \*people\* are lazy and uncaring about the degree of craft and care they bring to any pursuit. I'm sure in any hobby group or whatever that's mostly male, there's some minority feeling annoyed/disgusted/whatever with the rest of the members of the group who are sloppy/uncaring/'just in it for fun'.

Sylvia's reply reaffirmed the view that the majority of any group will "settle for mediocrity". When Donna joined the thread, she disrupted the consensus around the "us versus them" position:

And I realize this is probably not the forum for disagreement on this issue, but . . . <holding my nose and jumping in> I think posting sloppy, poorly written, poorly characterized fanfic is okay. I personally won't read it, and truthfully I don't know where they're getting positive feedback from, but it's still okay with me that they do it. . . . The folk on the Way Too Intellectual TS Critique list used to take this kind of writing as a personal affront, as far as I could tell.

This participant was clearly concerned about the consequences of expressing disagreement, but a common position was quickly re-established by Phoebe, who asserted that she had no problem with others posting "dreck", repeating the term Donna had used to conclude her message (not quoted). Her objection, she explained, was being put down by those in the "fun" camp for "rewriting a sentence 27 times or agonising over a point of characterisation or dialogue". What was coalescing was a position of "us and them" rather than "us versus them". Angela spoke for the community when she declared, "I'm in the live and let live school, like probably everyone on this list—it's part of being a mature adult".

That said, some participants did not always adhere to this school of thought. Several list discussions revolved around criticizing or mocking fiction perceived to be "poorly written". These discussions are particularly interesting because in pointing out the "bad", what passes as "good" is cast into relief, not always without ambiguity. The sample presented below begins with an overt qualification of the "live and let live" stance:

**From: Angela**

However, a couple of sentences in an intro will make me run screaming for the hills:

"I've never seen any of the eps, but I've read lots of fic."

"I rushed this together between classes"

"I was supposed to be studying for a <insert high school class here> test, but my friend IM'ed me with a plot bunny <most hated term!> and begged me to write it."<sup>4</sup>

"Beta? What's a beta?" <Different from self-beta'ed>

"I like the name Stanley."

By "intro", Angela is referring to the story notes provided by many authors. Whether these lines are actual quotations from story notes or loose paraphrases is neither clear nor important. They signaled to her that the fiction would be lacking in quality because the author was unfamiliar with the primary text,

did not spend any time developing characters, a plot, or even to proofread, only wrote the story as a challenge, is unfamiliar with the custom of having an editor, and weights personal taste over canon (“Stanley” instead of “Ray”). She concluded her message by asking others to add to her list, and a number of members responded. Most were humorous variations of the same themes. Penelope, for example, punctuated the “line” with disapproving “sounds”: “Benny <aargh> and Stan <aaargh> go shopping/bake pies/go to the zoo <aaieeee>.” Beyond violations of naming convention and non-sensical plots, Penelope, not surprisingly, flagged spelling and punctuation:

“Ray and Frasser’s relationship flourishes and gets a little help from Dief.” (Okay, I’m cheating, that’s an actual summary from a new F/V fic on due Slash. Spelling is as I found it.) This may be too general, but . . . anything with exclamation points, or ALL CAPS . . . I’m tapped out. Back to writing angst (with Manly Stifling of Tears).

Once the criticisms shift to inspirations for stories, the waters of “quality” become murkier. In two separate posts, Drucilla suggested the following: “I have <insert disease of choice> and thought it would be interesting to see how Ray and Fraser would react if one of them came down with it too;” “After the recent (insert event here) I wondered how Ray and Fraser would react to being in that situation;” and “I just broke up with my significant other and decided to write this story”. Presumably, the problem in all three examples is a lack of critical distance/objectivity. These writers are perceived to be “sitting too close”: the characters become non-canon mouthpieces for the author’s political interests or emotional state/physical condition. For some participants, the line between emotional attachment and critical distance was not so clear-cut. Leah responded directly, noting that the “recent event” inspiration “can work, but it’s got to be handled subtly and carefully”. As for the “break up” influence, she agreed, “nope, that’s never good” but then admitted that she was “guilty of scary author’s notes” and gave an example: “I’ve been listening to George Michael nonstop for ten days. Enjoy”. Whether her post was intended to be tongue in cheek is not clear, but it prompted this reply:

**From: Deirdre**

I’ve got to say, this thread is making me think about what \*actually\* inspired some of my stories and all’s I can say is, man, I’m just glad I didn’t ’fess to anything too massively stupid in my story notes.

Yikes

This post served to rupture the communal position, blurring the binary between “well-written” and “poorly written” fiction. Drucilla moved to smooth over this awkward moment by teasing her that was okay to have these inspirations as long as one did not confess to them in story notes. Jeanne

then joined the thread to re-establish a sense of community by asking members about what inspired their stories. She then provided some personal examples:

“T”, for example, came from a single image floating around in my head: a kiss at twilight in Ray’s kitchen doorway—and that ended up being the first scene I wrote (even though it came in the middle of the story). “S” was a combination of things . . . part based on various discussions (privately and on lists) about what constitutes craziness where Fraser’s concerned . . . and part based on hearing Patsy Cline’s song “Crazy” right after I re-watched “Strange Bedfellows.” And “M?” Appropriately enough, I pretty much dreamed it . . . and then wrote it the next day.

Others followed her lead and volunteered their inspirations. Yet the mention of a song and a dream by Jeanne do not seem so unlike the notes that had been criticized for failing to demonstrate appropriate critical distance. Toward the end of the thread, the participants did acknowledge that story notes in themselves were not a useful criterion:

**From: Drucilla**

Actually for me it’s a combination of factors, but certain types of story notes definitely tend to put me on ‘alert status’ and the first few paragraphs of a story will usually be enough to tell me if that alert is warranted or not. So do certain author names. So if, say, I saw a story by someone I have read and enjoyed before with a note about—say—it having been inspired by a breakup or a natural disaster, I would probably read it anyway, while if it were by an author whom I have generally found lacking in some way, it might be enough to make me skip it.

To be fair, MRKS participants also meted out praise for fiction by other writers and measured themselves against it accordingly. Below is an excerpt from the thread, “Fic Rec” (recommendation):

**From: Phoebe**

Doing my flyby maintenance of due Slash and there’s a new story up called “From Afar.” It’s F/K, post CotW, pretty long, and she can string complete sentences together. Worth a look if you need that bedtime reading.<sup>5</sup>

**From: Drucilla**

This is a major understatement.  
(off to burn everything I’ve ever written)

**From: Phoebe**

Well, you know me. Very few things actually blow me away. But this was technically well written, a major plus compared to some of the stuff out there lately. Could have used a beta.<G>

As Phoebe's post contained a minor criticism, Drucilla conceded there may have been "one or two small things" but then affirmed being "was too engrossed" to pay attention. Phoebe's response is conciliatory: "Uh, maybe you'll catch 'em on the reread, says the wanna-be copy editor". Drucilla agreed: "Most likely—I tend to notice things more the third or fourth time through. (as you know);-D". Later on in the thread, Drucilla admitted that she had violated her own rules about not reading "unbetaed" stories from a first-time slash writer. To shore up her position as a critical reader in the community, she emphasized that her statement about burning her stories had been hyperbole, a rhetorical strategy she had assumed the others would recognize as such. As well, she reaffirmed her support for the story: "I know my first story ever was a hell of a lot less well done than hers was:-". Leah, by contrast, would only say the story was "nice". Although she played down her lack of enthusiasm by saying "it was not her style", she also offered more concrete criticisms about it being too long and having "wayyy too many adjectives"!

CONCLUSION

It should be clear from the discussion above that the process of making meanings and pleasures out of slash fiction is a complex process. These pleasures are best conceptualized as a Venn diagram. One circle represents the "hotness" of the story, the second the "quality", and the third the adherence to canon. The "pleasure zone" is thus the space of overlap. By pointing out the contradictions in advocating for "quality" fiction, I am not suggesting that the MRKS participants are hypocrites or that no distinction can be made between "good" and "bad" fanfic. Rather, bourgeois aesthetics is a double-edged sword that can cut those who wield it in an effort to make distinctions on the basis of "quality" or "good taste". Upholding community standards based on bourgeois aesthetics too often have the unintended effect of creating an insider/outsider division within the community. Ironically, the importance of upholding such standards for the participants is likely reinforced by the charges of "sitting too close" or perversion made by high culture aficionados and homophobes, respectively. The denigration that they experience as fans in general and slash writers in particular may reinforce their desire to mark themselves out as legitimate members of the university-educated middle class.

Although they may not be obvious at first glance, parallels can be drawn between slash communities such as MRKS and virtual learning communities. For many in the latter category, engagement with a canonical text is also

central, and members will find themselves struggling to define the boundaries of “legitimate” interpretation. Given the emphasis on effective and accurate expression in educational institutions, the insider/outsider binary that is the result of differing levels of linguistic capital will always have to be negotiated. At risk of being penalized and/or silenced are those students unable to meet the generally unmarked norms and standards of the community. In contrast, the student who is able to produce “well-written” responses is likely to receive the most attention and praise from instructors and classmates. Hence, the use of mailing lists and discussion boards to extend classroom discussion and then the assessment of the ensuing contributions demand careful thought and attention. Because of the centrality of language in virtual environments—“one becomes a thing of words alone” as Rushkoff (1994) puts it—one’s cultural and linguistic resources are, quite literally, on the line.

#### AUTHOR’S NOTE

A longer version of this paper appears in Bury, R. (2005). *Cyberspaces of Their Own: Female Fandoms Online*. New York: Peter Lang.

#### ENDNOTES

1. For accounts on gender and cyberspace, see Cherny and Weise (1996), Herring (1996), O’Farrell and Vallone (1999), Consalvo and Paasonen (2002), and Shade (2002). For work on race, see Rodman et al. (2000) and Nakamura (2002). On sexuality see Case (1996) and on issues of digital divide see Van Dijk (1999) and Katz and Rice (2002).
2. David Marciano, the actor who played Ray Vecchio, did not return for the third season, and Canadian actor Callum Keith Rennie was brought in to play by Stanley Ray Kowalski.
3. “Fen” is the plural form of “fan” commonly used in fan communities.
4. “IM” stands for “Instant Messaging; in this example, it is used as a verb to “IM” someone.
5. CotW stands for “Call of the Wild,” the title of the *Due South* series finale.

#### REFERENCES

- Bourdieu, P. (1977). The economics of linguistic exchanges. *Social Science Information* 16(6), 645–668.
- Boyd, K. S. (2001). *One Index Finger on the Mouse Scroll Bar and the Other on My Clit: Slash Writers’ Views of Pornography, Censorship, Feminism and Risk*. Unpublished MA, Burnaby, B.C.: Simon Fraser University.

- Butler, J. (1990). *Gender Trouble: Feminism and the Subversion of Identity*. New York: Routledge.
- Case, S. E. (1996). *The Domain-Matrix: Performing Lesbian at the End of Print Culture*. Bloomington, Ind.: Indiana University Press.
- Cherny, L. & Reba Weise, E. (Eds.) (1996). *Wired\_Women: Gender and New Realities in Cyberspace*. Seattle: Seal Books.
- ClickZ Stats. (2004a). *U.S. Web Usage and Traffic, August 2004*. Retrieved October 1, 2004, from [http://www.clickz.com/stats/big\\_picture/traffic\\_patterns/article.php/3410151](http://www.clickz.com/stats/big_picture/traffic_patterns/article.php/3410151).
- ClickZ Stats. (2004b). *UK, Australia Web Usage and Traffic, August 2004*. Retrieved October 1, 2004, from [http://www.clickz.com/stats/big\\_picture/traffic\\_patterns/article.php/3414611](http://www.clickz.com/stats/big_picture/traffic_patterns/article.php/3414611).
- Consalvo, M. & Paasonen, S. (2002). *Women & Everyday Uses of the Internet: Agency & Identity*. New York: Peter Lang.
- Curtin, M. E. (2003, March 17). *Alternative Universes: Fanfiction Studies*. Retrieved January 2, 2004, 2003, from <http://www.alternateuniverses.com/index.html>.
- Doty, A. (1993). *Making Things Perfectly Queer*. Minneapolis: University of Minnesota.
- Fiske, J. (1989). Moments of television: neither the text nor the audience. In: Seiter, E., Borchers, H., Kreuzner, G., and Warth, E. M. (Eds.) *Remote Control: Television, Audiences, and Cultural Power*. New York: Routledge, 56–78.
- Graphics Visualization & Usability Center. (1994, 06/29/2001). *First WWW User Survey*. Retrieved January 26, 2004, from [http://www.gvu.gatech.edu/user\\_surveys/survey-01-1994/](http://www.gvu.gatech.edu/user_surveys/survey-01-1994/).
- Graphics Visualization & Usability Center. (1998, May 15, 1999). *Tenth WWW User Survey*. Retrieved March 24, 2000, from [http://www.gvu.gatech.edu/user\\_surveys/survey-1998-10/tenthreport.html#ex](http://www.gvu.gatech.edu/user_surveys/survey-1998-10/tenthreport.html#ex).
- Herring, S. (Ed.) (1996). *Computer-Mediated Communication: Linguistic, Social, and Cross-Cultural Perspectives*. Philadelphia: J. Benjamins.
- Jenkins, H. (1992). *Textual Poachers: Television Fans & Participatory Culture*. New York: Routledge.
- Katz, J. E. & Rice, R. E. (2002). *Social Consequences of Internet Use: Access, Involvement, and Interaction*. Cambridge, MA: MIT Press.
- Lamb, P. F. & Veith, D. L. (1986). Romantic myth, transcendence, and Star Trek zines. In: Palumbo, D. (Ed.) *Erotic Universe: Sexuality and Fantastic Literature*. Westport, CT: Greenwood Press, xviii, 305.
- Nakamura, L. (2002). *Cybertypes: Race, Ethnicity and Identity on the Internet*. New York; London: Routledge.
- O'Farrell, M. A. & Vallone, L. (1999). *Virtual Gender: Fantasies of Subjectivity and Embodiment*. Ann Arbor: The University of Michigan Press.
- Penley, C. (1991). Brownian motion: women, tactics and technology. In: Penley, C. and Ross, A. (Eds.) *Technoculture*. Minneapolis: University of Minnesota Press, 135–161.
- Rodman, G. B., Kolko, B. E., & Nakamura, L. (2000). *Race in Cyberspace*. New York: Routledge.
- Rushkoff, D. (1994). *Cyberia: Life in the Trenches of Hyperspace*. San Francisco: Harper Collins.
- Russ, J. (1985). *Magic Mommas, Trembling Sisters, Puritans & Perverts: Feminist Essays*. Trumansburg, NY: Crossing Press.
- Shade, L. R. (2002). *Gender & Community in the Social Construction of the Internet*. New York: Peter Lang.
- Van Dijk, J. (1999). In: Spoorenberg, L. (Trans.) *The Network Society: Social Aspects of New Media*. Thousand Oaks, CA: Sage.



# **Part IV**

## **Challenges for Virtual Learning Environments**

## Chapter 47: Chromosoft Mirrors\*

JEFF NOON

The dramatic rise and fall of the Chromosoft empire has already been expertly charted, especially the part that Mirrors version 4.2 played in the short and dramatic end. I offer the following story as a more human addendum to the official history. It may illuminate a dark passing, if only with a single beam of truth. Concerned as they are with the bigger picture, none of the extant histories have managed to reveal the actual person responsible for the final terrible error. It was, of course, Chromosoft's policy that all mistakes be veiled by a collective responsibility.

My grandmother, Elisa Gretchen, died before I was born. Any knowledge I had of her life came through borrowed memories, until my discovery of her private journal. I need not go into the details of this discovery, except to say that the primitive nature of the recording medium necessitated the expensive purchase of an antique cd-rom player.

Elisa was on the famous skunk team that came up with the original idea for the Mirrors technology (code-named the "Alice" project), and was active during all stages of its development and demo-testing. Later on she was assigned to the troubleshooting team, which suffered heavily during the fretful launch period. Version 1.0 was riddled with bugs, and the new interface itself so strangely inhuman that the critics were quick to predict the company's demise, especially with its main competitors riding high on the "back to nature" campaign of the fashionable DOS revival. Version 1.1 ironed out some of the problems, and v.1.2 introduced the new feedback loop dynamics. It was the major relaunch, with v.2.0, that really kick-started the product's unprecedented success. With a brand new interface, greater though-recognition software, and an inspired marketing campaign centered around the slogan, "Chromosoft Mirrors—*where's your head today?*", the whole world turned to gaze in on itself.

The problem with Windows—the most famous interface prior to Mirrors—was that the more advanced it became (version 491.7!), the more difficult it was to use. And for all its increasing complexity, still all you ever did was *use* the technology; it never *used* you. Thus was the Mirrors project initiated. A new simplicity was called for, something beyond windows, beyond the blinkered one-way gaze. Although my grandmother makes no claim to inventing the actual concept, she does write that the name "Mirrors" was her

\* Originally published as Chromosoft Mirrors (V4.2) in *Pixel Juice*. London: Black Swan Books, 1998: 125–128. Reprinted with permission of the author.

invention. It came to her in a flash, one evening in a Parisian hotel bathroom, “after a rigorous bout of continental-style lovemaking”, as she puts it in her journal.

It was not the first system to use thought recognition, of course, but the first to successfully marry it with a usable feedback loop. Put simply, previous attempts allowed you to change the screen by thinking of the changes, but only Chromosoft allowed the information to redirect your thinking in turn. The Mirrors system really was a new way of working, a new way of being.

Where’s your head today? Gone downloaded.

As it did with the invention of the typewriter and the word processor, a new type of creation emerged from the mirror. Suddenly, “speed of unconsciousness” novels were all the rage. Punctuation mutated into mere rhythm, narrative dissolved, symbols became deeper, more dreamlike, more dangerous.

Version 3.0 introduced the concept of network. Version 3.4, to the Internet. These were radical upgradings, with long-lasting social effects; because, although it was not strictly true that we were all telepathically linked, it certainly felt like it. The Internet’s long-promised “revelation of the global soul” suddenly seemed less of a pipe dream, more of a God-given right. Version 4.0 added little that was new, merely a cosmetic repackaging to fend off the latest clones. 4.1 was another tweakjob, and it was this version that became the standard for the next 3 years.

The public will always find its own use for technology, and usually in secret. Nowhere in the Mirrors manual did it warn against remaining connected whilst asleep. Nowhere in the manual did it ever mention that such a thing could be done. And nowhere did it mention the effect this could have on the human psyche: the ability to get up in the morning, simply to access the correct document, and then to view, or rather review, your dreams of the night just gone. Could the company have seen how this would lead to a possible madness, a knowing of one’s self that was too deep, too far-ranging?

Where’s your head today? Why, it’s playing with the burning giraffes, dancing with a turquoise lobster on the top of the grand piano, thank you, Mr. Penguin.

Many were affected by this dream-knowledge, and many did not make the journey back from the twisted, inner world.

I can now reveal that it was my grandmother, Elisa Gretchen, who developed and introduced the *disable dream* switch to version 4.2 of the Mirrors system. Approximately 6% of the world’s population activated this facility, before the dangers of it were realized. Could Chromosoft, could my *grandmother*, really have so easily forgotten the feedback loop in the user/device interface? Her journal mentions little of the moment of invention, and even less of the subsequent events, except to note the “burning sense of shame that welled up within me, a shame that persisted even after the corporation had taken

control of all responsibility”. Her last recorded entry reads simply: “I can do no more.”

Chromosoft Mirrors was taken off the market by government orders, and all existing devices were recalled, and trashed. By then it was too late for the 6% of who had already succumbed to the censoring loop. Those darkened, veiled unfortunates, who would never dream again.

I need hardly add that my grandmother was one of those unfortunates.

## Chapter 48: Net:Geography Fieldwork Frequently Asked Questions

MARTIN DODGE\* AND ROB KITCHIN†

\**Centre for Advanced Spatial Analysis, University College London, London, U.K.*; †*NIRSA, National University of Ireland, Maynooth, Ireland*

### 1. INTRODUCING THE NET:GEOGRAPHY FIELDWORK FAQ

**Q.** *What is the Net:Geography FAQ about?*

**A.** It is a set of answers to frequently asked questions (FAQs) regarding the geography and unseen, “inner”, structures of the internet. It provides a practical “fieldwork” guide for understanding the internet, using online mapping resources as virtual learning tools.

- It gives hands-on suggestions of techniques and freely available software tools and web resources that can be used to actively explore both the internal topology of internet connections and the external geography of network infrastructure. By revealing the operation of the internet in terms of where things are located, who owns them, and how data travels, the FAQ helps foster a more critical engagement with the media. The goal is to contribute, in a small way, to changing users of the internet from passive consumers to more informed and active citizens of their network, and potentially more engaged learners.
- It is possible to learn a lot about the internet from critical writing, popular discourses, and secondary published data. However, for real understanding, there is no substitute for doing your own fieldwork.
- It is not necessary to be a network engineer or computer scientist to begin to ask critical questions about the structure and the operation of the internet. Nor does not require a large investment in expensive, specialized tools as the internet can be used to measure and map itself. Many of the tools and techniques used were actually created by engineers for practical purposes of “debugging” network problems. However, they can also be re-used in politically challenging ways in the context of virtual learning, providing tactical knowledge of the media that cannot be gained in any other way. As a consequence, anybody can do Net:Geography fieldwork.
- The practical examples given in this FAQ were tested using a standard PC running Windows 2000 on a university network, but most of the software tools and all of the techniques discussed are sufficiently generic that they should work in most situations.

- The Net:Geography FAQ comprises four sections: (1) finding out about your place on the internet, (2) determining the location of components of the internet, (3) measuring distance across the internet, (4) charting the routes of data through the internet.

**Q.** *In what ways is Net:Geography relevant to virtual learning environments (VLE)?*

**A.** The concept of doing “fieldwork” is very relevant to some of the underlying goals of VLEs—fostering active participation, developing social interaction by engaged learners, and mixing together learning resources and teaching approaches. Further, we would argue that specific Net:Geography methods outlined in this FAQ can contribute valuably to VLE development on three levels:

- Firstly, the practical techniques of network explorations and mapping can be incorporated as pedagogic content in a range of VLEs, particularly those that aim to explain “how the internet works”.
- Secondly, the techniques are useful for academics and learners to look at and probe the underlying infrastructures that make their existing VLEs work.
- Lastly, the techniques can be used as part of thorough appraisal and assessment of the value of a VLE. Most obviously this can be achieved through monitoring online interactions and mapping the geography of participants.

**Q.** *Can I really explore the “inner workings” of the internet without permission?*

**A.** Yes, even as an “ordinary user” you can begin to explore the structure and operation of the internet. This is because the internet is built and operated in a fundamentally different way to other large communication networks, like telephones or television. These other networks are purposefully closed and proprietary, and, unlike the internet, actively try to keep “consumers” away from the insides of the network.

- The internet was purposefully designed as an open network that encourages active exploration and experimentation. The internet is not a single physical entity, instead it is premised on a public agreement to share data using open protocols. Anyone can use these protocols and as long as users abide by the terms of any access agreement and follow the protocols, they are able to take an active role in producing the network. Many of the most useful internet services widely used today came about through researchers, students, and enthusiastic hackers exploring and exploiting this open architecture to try out new things.
- However, the openness of the internet is always under attack because it is seen as threatening and subversive by many entrenched institutions. Today, with increasing commercial pressures, fears of criminal hackers,

rising levels of spam, viruses and worms, there is a definite “chilling effect” across the Net as security is tightened and the media comes under more surveillance.

- For a lucid discussion on the open design of the internet, see Searls and Weinberger (2003).

**Q.** *Does the Internet actually have a geography?*

**A.** Yes it does. In fact, there are several different geographies, although this FAQ focuses on the material geography of the infrastructures of the internet. Other important geographies that can be analyzed include, for example, the social geography of e-mail and the economic geography of content production and distribution.

- The hype around much of the “impact” of the internet, especially in the mid-1990s, was that it was “everywhere and nowhere” and it would make geography less significant in human organization through the “death of distance”. This has patently not been the case.
- While the internet has undoubtedly had an affect on the geography of business operation and the time–space patterns of individual communication and consumption, distance is not dead. What is being witnessed are complicated socio-economic restructurings, through processes of concentration and decentralization, across scales.
- The idea of the internet as being somehow “anti-geographical” is based on three key notions: fantasy, denial, and ignorance
  1. Internet geography was assumed not to materially exist. This is founded on the anti-corporeal, cyber-utopianist *fantasy* that somehow the virtual communities of cyberspace can be produced in a realm divorced from material existence.
  2. Internet geography was assumed not to be important, so could be *denied*. The failure of many e-commerce ventures in the dotcom boom, we would argue, was based in part on ignoring the grounded, geographic, realities of computer-mediated communication, logistic networks, and labor markets.
  3. Internet geography was assumed to be not measurable. Because it was hard to do, it was *ignored*, especially in the heady days of bubble growth.
- The medium of communication might be virtual, but the internet is dependent on physical infrastructure and human labor, most of which is invisible to users. The computers are small in scale and are usually hidden from view in anonymous server rooms and secure, windowless buildings, while the cables are under floors, in ceilings and in conduits buried under roads.
- The banal technicalities of internet infrastructures are easily overlooked (just like for other essential utilities of water, electricity), but they are not naturally given. The geographical structure and operation

of networks that service modern living have politics. Net:Geography fieldwork can help in grasp some of these grounded politics first hand.

**Q.** *Why is understanding the geography of the internet useful?*

**A.** There are several pragmatic reasons why being able to find out about the geographical structure of the internet is useful. Most importantly, the internet is a global system, but it is always locally produced. Understanding the local variability enhances the understanding of the whole system.

- The social production of the internet is contingent on cultural, legal, and economic forces that vary from place to place. In communicating with people, it is often useful to be sensitive to language, customs and time-zones differences for example.
- The production of the internet is subject to myriad of different legal systems, which vary by territorial geography. It can be important to know the legal jurisdiction where the user is located as this may impact the types of consumer protection enjoyed, the particular obscenity laws enforced, and so on.
- The freedom to surf the web is not universal. Governments in many countries try to impose varying degrees of censorship in the production and the consumption of information of their citizens. For an authoritative catalog of censorship efforts across the world, see Reporters without Borders (2003).
- In economic terms, internet availability (as measured by access speeds, reliability, and cost) remains uneven across space and across different social groups. This has been characterized, often overly simplistically, as the “digital divide” and, for a nuanced analysis, it must be considered geographically.
- Knowing where things are located is also useful analytically because variations in spatial patterns can often give researchers an insight into underlying processes. Geographic location is one of the most effective means of indexing internet data, enabling linkages to be made to a vast array of existing secondary data, such as demographic statistics from censuses and surveys. Geography also provides a familiar frame for presenting data about the internet, giving context and additional meaning to numbers. Conventional geographic mapping remains one of the most powerful means of information presentation available (e.g., showing the locations of learners in a VLE).
- Lastly, in a world of evermore information and services on the internet, geography proves to be an invaluable way of segmenting, filtering, and prioritizing people’s attention. As a rule, people tend to be more interested in information that is local to them, rather than things that are distant.



## 2. FINDING OUT ABOUT YOUR PLACE ON THE INTERNET

We start the exploration of Net:Geography with some local fieldwork investigating how individuals are connected to the internet, and what is happening in their local internet neighborhood.

**Q.** *How am I connected to the internet?*

**A.** You are connected to the internet via specialist software and the settings that identify your location to the rest of the internet. It is quite easy to find out these details using diagnostic utilities of the operating system to display the current internet configuration for your PC.

- Technically these are the Transmission Control Protocol/Internet Protocol (TCP/IP) settings. TCP/IP is the basic lingua franca of the internet. If your computer is connected to the internet, it is “speaking” in TCP/IP.
- The ipconfig utility will show the TCP/IP settings. Run it by typing “*ipconfig/all*” from the command prompt. This gives the following type of output (Figure 1). (To open the Command Prompt, click Start, then Programs, then Accessories.)
- The output looks technical (and it is to some extent) but all it shows is the range of settings that allows the PC to get online. The most useful parts to note are the name of your PC on the internet (*Host Name: mini-ferret*) and the *IP Address (128.40.59.54)*, which is the globally unique location of the PC in terms of the Internet’s internal topology. No other computer on the internet can (legally) share the same address.

```
Command Prompt
C:\>ipconfig /all

Windows 2000 IP Configuration

    Host Name . . . . . : MINI-FERRET
    Primary DNS Suffix . . . . . : casa.ucl.ac.uk
    Node Type . . . . . : Hybrid
    IP Routing Enabled. . . . . : No
    WINS Proxy Enabled. . . . . : No
    DNS Suffix Search List. . . . . : casa.ucl.ac.uk

Ethernet adapter Local Area Connection:

    Connection-specific DNS Suffix . . : casa.ucl.ac.uk
    Description . . . . . : 3Com 3C920 Integrated Fast Ethernet
    Controller (3C905C-TX Compatible)
    Physical Address. . . . . : 00-06-5B-89-5A-9C
    DHCP Enabled. . . . . : Yes
    Autoconfiguration Enabled . . . . : Yes
    IP Address. . . . . : 128.40.59.54
    Subnet Mask . . . . . : 255.255.255.0
    Default Gateway . . . . . : 128.40.59.245
    DHCP Server . . . . . : 128.40.59.179
    DNS Servers . . . . . : 144.82.199.1
    . . . . . : 144.82.100.41
    Primary WINS Server . . . . . : 128.40.59.244
    Secondary WINS Server . . . . . : 128.40.58.142
    Lease Obtained. . . . . : 19 April 2004 18:28:53
    Lease Expires . . . . . : 21 April 2004 18:28:53

C:\>
```

Figure 1. TCP/IP settings reveal the structure of your local Net:Geography.

- Details are also given on the type of connection, in this case through a local area network using Ethernet, with the make and model of the card (*Description: 3Com 3C920*). The physical address of the card, a globally unique id code number that identifies this piece of hardware (*00-06-5B-89-5A-9C*) is also shown.
- Lastly, the output lists the IP addresses of the *Default Gateway* (*128.40.59.245*), which passes traffic from the local area out to the wider internet, and the *DNS Servers* (*144.82.100.1 ; 144.82.100.41*), which are important components in the internet for translating domain names into numeric IP addresses.

**Q.** *What is the speed of my connection?*

**A.** You can easily obtain the speed (and other useful statistics) on your current internet connection.

- Open the Network and Dial-Up Connections menu (accessed from Start, Settings). Right click on the active network connection and select the *status* option (Figure 2).
- In this case the connection is running at *10 Mbps* (megabits per second). This is typical for an office environment and is quite a lot faster than the average home internet access. Also displayed is the duration of the session and a basic indication of activity in terms of the total data transferred in and out.
- The speed of connection is important because it determines the bandwidth available for internet interactions. Bandwidth is the capacity to shift data measured in bit per second and is crucial to what can be

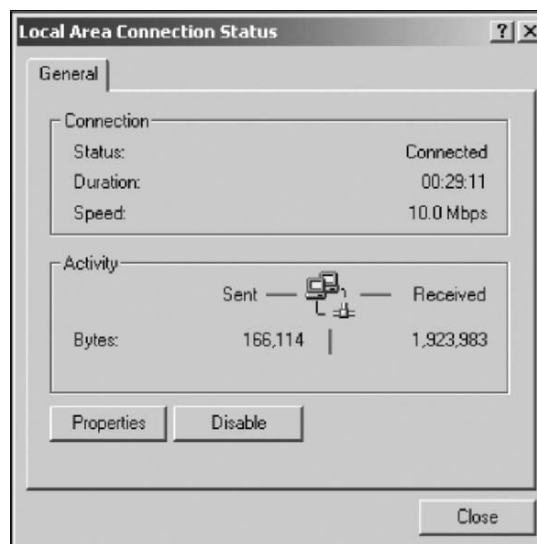

Figure 2. Network status showing the speed of connection.

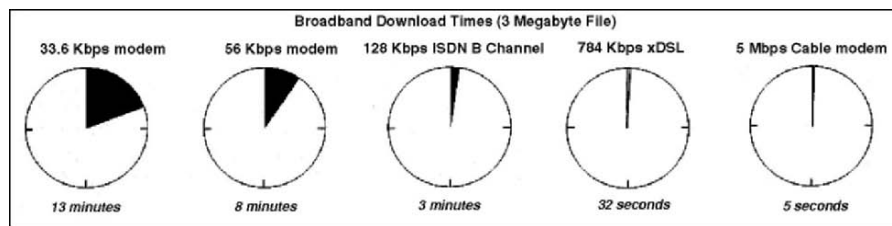

Figure 3. The importance of bandwidth.

done and how long it will take, as illustrated by Figure 3. Some internet services are simply not viable over low bandwidth connections.

**Q.** *What is going on in my local internet neighborhood?*

**A.** It is possible to see in some detail the inner structure of a local part of the internet, observing the activities of other users, using network monitoring tools.

- There are lots of different tools available. One of the most capable is the Ethereal Network Analyzer. It is a free, open-source application, downloadable from <http://www.ethereal.com>.
- Ethereal is a network monitoring tool that does “packet sniffing”. This means it can watch all the traffic “going past” your PC on a local network. This traffic is in the form of streams of individual data packets flowing between different machines. The data packets can be captured by Ethereal for processing and detailed analysis.
- Figure 4 shows Ethereal monitoring a small local area network of an office at a university. It was able to “sniff” quite a lot of activity nearby. This screenshot only shows a snapshot of a few seconds of the data packets flowing by the monitoring PC.
- The display looks complicated as it shows a very detailed view of internet activity that most people never see. The result is simply a long list of all traffic “sniffed” rather than a summary graph or a map. Ethereal does not “know” anything about the physical structure of the network or the actual locations of the users. However, it is able to identify the different types traffic and, most importantly, the source and destination of the traffic.
- The top window in the Ethereal interface displays one data packet per line. It takes some care and skill to interpret what is going in terms of user activity because it can be fragmented over many individual data packets. As an example, one data packet, number 2449, has been selected. The data was sent from PC identified as *casa198.bart.ucl.ac.uk* (Source column) to *newswww.bbc.net.uk* (Destination column). The destination is the web server for the BBC News service. The protocol of the data packet was *http* (hypertext transfer protocol used by web browsers) and

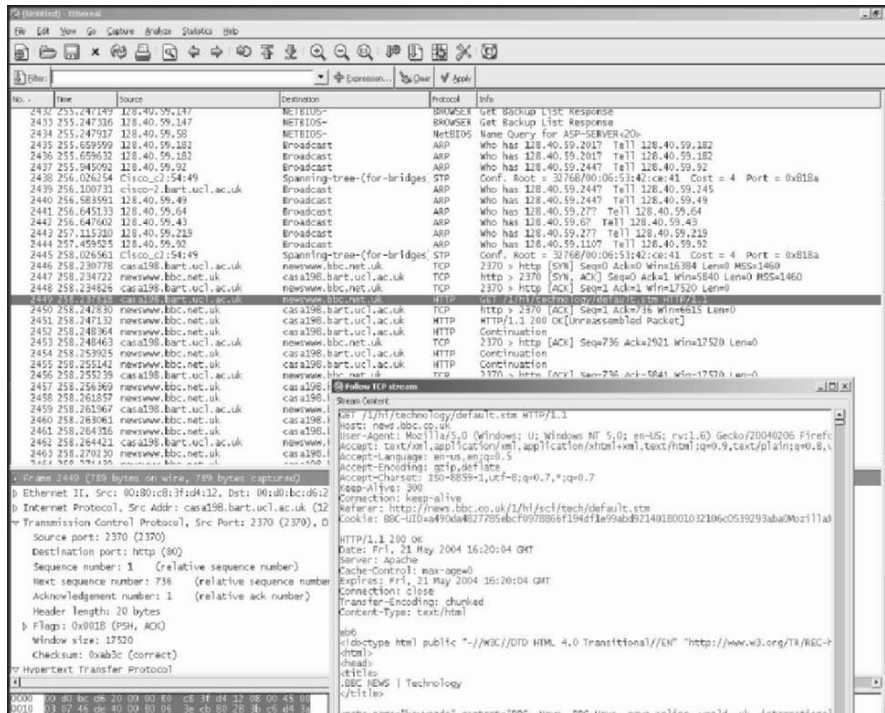

Figure 4. Ethereal Network Analyzer capturing packet-level detail on the traffic flows of a local network environment.

the *GET* command Info column reveals it was a request for a web page. Ethereal can connect together all the related packets of data for this particular web transaction, shown in the “Follow TCP Stream” pop-up window, enabling us to see the actual web page content (in raw html form). In this case Ethereal was able to reveal exactly the web page this user was looking at.

- Ethereal, and similar network monitoring tools, have the power to reveal a great deal about individual user’s activities. This is particularly so because most data flowing across the internet are sent unencrypted and can be covertly read by anyone who is able to tap into the network flow.
- Beyond the practicalities of running network monitoring tools like Ethereal and interpreting the output, there are clearly some more thorny ethical issues to confront about covert “spying” on the activities of your neighbors. Good ethical practice for researchers would require that prior informed consent is obtained from *all* people on the network being scanned. Active network scanning for benign Net:Geography exploration can also be deemed improper behavior by system administrators, so you need to be prepared to justify your actions.

**Q.** *What do I reveal about myself to the rest of the internet?*

**A.** Connecting to the internet means necessarily revealing some details to network providers and leaving traces in the logs of the services you interact with. At a most basic level the IP address must be known to send data to the correct location.

- Any online activity leave traces, but using different services and different client software results in different amounts of potentially personally identifiable data “leaking” out.
- Surfing the web in particular results in a considerable amount of information being revealed. Even if you have not formally registered with websites and feel that you are browsing anonymously, you may be surprised the degree to which you are trackable.
- There are number of free web services that test what is revealed about your PC and web browser configuration. Figure 5 shows an example produced by the BrowserSpy service (<http://gemal.dk/browserspy>).
- The “basic information” that BrowserSpy is able to extract is perhaps not that surprising; it can determine the type of web browser and version, as well as the operating system. More interestingly it could tell the connection was via a modem. BrowserSpy is also able to gather many more details from a typical web browser (e.g., plug-ins available, drive letters, screen resolution, time-zone settings). In many ways this is technical and very banal information, but taken together this voluntary “leakage” can paint a detailed picture of your PC. These data are useful for websites in building profiles and tracking their users,

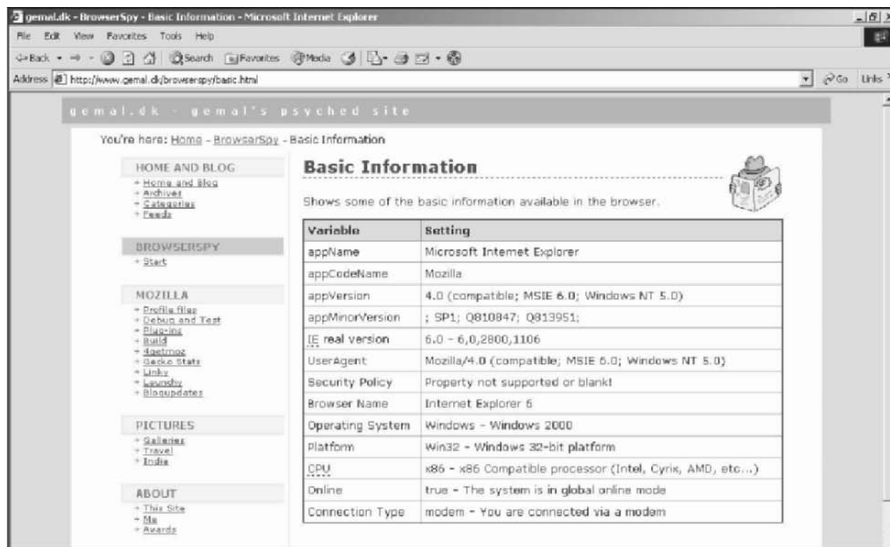

The screenshot shows a web browser window titled 'gemal.dk - BrowserSpy - Basic Information - Microsoft Internet Explorer'. The address bar shows 'http://www.gemal.dk/browserspy/basic.html'. The page content includes a navigation menu on the left with sections like 'HOME AND BLOG', 'BROWSERSPY', 'MOZILLA', 'PICTURES', and 'ABOUT'. The main content area is titled 'Basic Information' and contains a table of browser and system details.

Variable	Setting
appName	Microsoft Internet Explorer
appCodeName	Mozilla
appVersion	4.0 (compatible; MSIE 6.0; Windows NT 5.0)
appMinorVersion	; SP1; Q810847; Q813951;
IE real version	6.0 - 6.0,2800,1106
UserAgent	Mozilla/4.0 (compatible; MSIE 5.0; Windows NT 5.0)
Security Policy	Property not supported or blank
Browser Name	Internet Explorer 6
Operating System	Windows - Windows 2000
Platform	win32 - Windows 32-bit platform
CPU	x86 - x86 Compatible processor (Intel, Cyrix, AMD, etc...)
Online	true - The system is in global online mode
Connection Type	modem - You are connected via a modem

*Figure 5. An example of some of the possible “hidden” details that you can unwittingly reveal to websites.*

and also for automatically presenting tailored content to suit different users (e.g., less graphics for those on low bandwidth connections). It can also be exploited by more unscrupulous people to identify potential vulnerabilities in your PC through which to attempt to break in.

- Browser cookies are particularly pernicious tool in web surveillance, although we do not have space to discuss their role in actively tracking individual browsing patterns. However, as a very simple test of their prevalence, try setting your browser so that it has to request permission from you every time a website wants to set a cookie. You will quickly see just how many are set!
- Further technical reading on what data are known about you when using the internet see Clayton (2001).

### 3. LOCATION ON THE INTERNET

We now look beyond the local neighborhood to methods that allow a wider exploration of where things are located on the internet.

**Q.** *How is location in the internet defined?*

**A.** Knowing where things are located is crucial to most activities, including in the internet. However, the internet is concerned with topological location (where things are located in terms of connections) and not with physical geographical location, defined by  $x, y$  co-ordinates.

- The internet comprises a robust and scalable system to specify location uniquely so that data can be correctly transferred.
- As demonstrated earlier when discussing *ipconfig*, globally unique locations in the internet are based on two key systems—IP addresses and domain names.
- Typically when people give out an internet location this will be some kind of domain name address (e.g., a website address, *http://www.jasonnolan.net* or an e-mail address such as *jason.nolan@utoronto.ca*). Domain names are always associated with an IP address.
- IP addresses are little seen or used by typical users. They look a little like telephone numbers, such as *64.246.60.38*, identifying the *http://www.jasonnolan.net* website. The unique allocation of IP addresses is the key to the successful delivery of traffic across the complexity of the global internet.

**Q.** *Why don't internet addresses specify a geographic position?*

**A.** This is how they were designed. Basically, the internet protocols at the core of the network were never designed to make details on its geographical structure explicit to users. The successful transfer of data through the internet requires knowledge of a topological address, not geographical location.

- In many ways the internet was designed to deliberately hide the underlying physical geography. This split between logical locations and physical locations is actually very useful. It is part of the reason why you can surf across websites scattered across the world and not have to worry about where the data are physically located.
- Because the internet is a network of networks, rather than a homogeneous entity, its means of control are decentralized and its structure is fluid. Even though “no one owns the internet” as a whole, each one of its component parts is owned and operated by many millions of different organizations and individuals. In consequence, no one single institution has a synoptic view of the whole internet and, therefore, no one is required to maintain a register of where all the components are physically located.
- However, it is often useful to be able to determine the geographic location of parts of the internet, for example the location of a website as a part of assessment of whether they are credible sources of information or before entering credit card details. Many websites might not be physically where you think they are. However, because there is no one central register to do this mapping, you have to use a range of different fieldwork techniques (detailed below).

**Q.** *What types of geographic location are relevant for Net:Geography fieldwork?*

**A.** Understanding the nature of the geographical location of components of the internet is interesting because different parts can be in different places. There are five obvious kinds of geographical location which are important in terms of the web:

1. A website is where it is published, that is where the server is physically located (hardware geography).
  2. A website is where the author/maintainer is located (production geography).
  3. A website is where the legal owner is located (ownership geography).
  4. A website is where the readers are located (audience geography).
  5. A website is where the content refers (lexical geography).
- In some cases all five locations will be coincident. But it is easy to imagine plausible scenarios in which you have a web page about Maynooth, Ireland that is written by someone in Canada, hosted on a server in London and read by people from across the world.
  - The geographical precision of these different physical locations can also vary. Sometimes location might be determined as the precise  $x, y$  position (e.g., street address of the building with the web server), other times one might only know the city or legal jurisdiction referred to.

**Q.** *How can I tell where an internet address is geographically located?*

**A.** Unfortunately, determining the precise geographic location of an internet address cannot be done easily or in an accurate, consistent fashion. However, there are some techniques that can be used to try to determine the geographic location, at least approximately, of a website for example.

- The first point to note is that different techniques will tell you about the five different locational types. Most of the techniques described here will identify the production or ownership geography.
- The first, and most obvious, method is to use lexical location as the proxy. Here, the content of the website is browsed to try to find an “about page” or “contacts page” that provides a postal address or telephone number of the owner. Other cultural and linguistic clues (e.g., flags, symbols) in the content of a website might give useful indications of the “real-world” location.
- If you only have the domain name of a website to work with, the first place to start is by “decoding” it. Many domain names are allocated on a country-by-country basis with their name ending with the appropriate two letter ISO country code (e.g., *.ca* for Canadian domains, *.ie* for Irish domains, and so on). One can infer the geographic location of an internet address based on the country code in its domain name. A useful list of all the country code domain names is available at <http://www.iana.org/cctld/cctld-whois.htm>.
- However, there are limitations in relying on country code domains.
  1. There are several domain name types (the so called “global top-level domains”) that are not related to countries. The biggest of these are *.com*, *.org*, *.net* and *.info*. The <http://www.jasonnolan.net> website has a *.net* domain name which does not allow any inference on its location to be made. A *.net* domain could be located anywhere in the world. (Note, the top-level domains *.mil*, *.edu* and *.gov* are allocated only to U.S. institutions, so one can be fairly safely assume they are located in the U.S.A.)
  2. The level of geographic precision is obviously crude with this technique, particularly so for large countries. A *.ca* domain name could be anywhere in Canada.
  3. Lastly, just because a website uses a country code domain name does not guarantee that the website is actually within the country indicated. The ownership, production, hosting, and use of that website could well be in another country or several different countries. For example, the *amazon.de* and *amazon.co.uk* websites are published on servers physically located in the United States and not in the United Kingdom or Germany as indicated by their domain names.
- Moving beyond decoding the top-level domain names, you can try to exploit other parts of the domain name to infer geographic location of the address. This works when e-mail addresses or websites



are part of an established, easily identifiable company or institution that can be traced to city in which they are located. For example, we could deduce that Martin Dodge's e-mail address at ucl.ac.uk links him to University College London (UCL) and could then infer that he is physically located in central London, on the site of the main university campus. Again, there are limits to the level of precision in this method, and it is also prone to error for large organizations, like transnational companies, which operate from many sites, over extensive areas.

- The last thing you can do with a domain name address is to find out whom it is registered to. All domain names have a legal owner and the registration databases for this usually contain contact details. You can freely consult this registration information from the domain name system using a *Whois* query. (Note, not all domain registration databases will publicly give out the full address details of the owner.)
- A *Whois* query can be easily run from any number of websites. Below is the results of a *Whois* query to find the registered owner of *jasonnolan.net* domain name using the free service provided by AllWhois (<http://www.allwhois.com>) (Figure 6).

**ALLDOMAINS.COM**  
REGISTERING THE WORLD'S DOMAINS

CONTACT | HELP

DOMAIN NAMES | ADDITIONAL SERVICES | TRANSFER DOMAINS | RESELLER ACCOUNTS | CUSTOMER SUPPORT

**About Allwhois**  
Allwhois™, a free service provided by Alldomains.com, is the most complete whois service on the internet. It automatically locates the appropriate "whois" database server for a particular domain name, queries that database for information about that domain name, and returns all available data.

In addition, a domain name availability check will also be performed, even if a particular domain extension doesn't have a searchable whois database. If a domain name is available, you can register it at Alldomains.com. [For a complete list of domain extensions click here.](#)

Check Any Domain in the World

www.jasonnolan.net Search

**Whois Output:**

Search Results X Domain Taken  
Please Search Again  
Domain name is currently unavailable for registration

**DOMAINS.CN**  
NEWLY AVAILABLE CHINESE DOMAINS  
get yours

**ENTERPRISE DNS**  
INCREASE SPEED, PERFORMANCE, AND RELIABILITY  
read more

Registrant:  
KMD1  
40 St George  
Suite 7224  
University of Toronto  
Toronto, Ontario M5S 2E4  
CA

Domain name: JASONNOLAN.NET

Administrative Contact:  
Nolan, Jason jason.nolan@utoronto.ca  
40 St George  
Suite 7224  
University of Toronto  
Toronto, Ontario M5S 2E4

**POP3 EMAIL**  
PERSONALIZED TO YOUR DOMAIN  
get yours

as low as  
**\$1.99 A MONTH**

Figure 6. Looking up the domain name registrations details on *jasonnolan.net* using *Whois*.

- The registration information from the *Whois* query identifies the owner of *jasonnolan.net* to be located in Toronto, Canada. The full street address is given. This could be looked up and a detailed map obtained giving the precise location.
- The results of *Whois* queries can be very useful in finding out where the registered owner of a domain name is, however they are not always accurate. Firstly, registration details held on a given domain name may be out of date, incorrect, or deliberately false (spammers, for example, try to hide their true geographic location and would be unlikely to complete the registration honestly). Secondly, ownership details may only tell you one of the five possible geographies of a website. We can see that *jasonnolan.net*'s owner is located in Toronto, but the site may be produced, published, and consumed elsewhere. Thirdly, the registrations for large organizations often give a single postal address (their headquarters) and thereby mask where individual domain names are actually being used.
- If you do not have a domain name to work with, you can also lookup the ownership of IP addresses. These are generally allocated in large blocks to ISPs rather than to individuals or companies. You can do this query by doing a *Whois* query to ARIN (<http://www.arin.net/whois>). The IP address of the server which publishes <http://www.jasonnolan.net> is 64.246.60.38 (Figure 7). Looking up this address yields details on the registered owner, a company called Everyone's internet Inc., with a postal address in Houston Texas.
- Another strategy is to test where a website is connected to the internet by tracing traffic flows. Details on how to do this real-time probing are discussed in the last section of the FAQ.
- There are a number of firms that provide commercial services to convert IP addresses to geographic locations. For example, Quova, Inc. (<http://www.quova.com>), IP2Location (<http://www.ip2location.com>).
- To find out more on the technicalities of relating internet addresses to geographic locations, see Lakhina et al. (2002) and Padmanabhan and Subramaniann (2001).

**Q.** *What else can I do to find out more about a website's ownership and location?*

**A.** Taking a different perspective, you can also explore the "virtual" position of a website in terms of its visibility in the information space of the web.

- Counting the number of hyperlinks to and from a website and analyzing whom the links come from can reveal the informational structures of Net:Geography. The results can be used to infer a website's position in terms of social networks and power geometries; a well-linked site could indicate that its creator has power and influence. This kind of hyperlink analysis has many parallels to citation analysis used to assess influence in scholarly research. Much of the success of the Google search engine

**Output from ARIN WHOIS**

---

[ARIN Home Page](#)
[ARIN Site Map](#)
[ARIN WHOIS Help](#)
[Tutorial on Querying ARIN's WHOIS](#)

---

Search for:

---

**Search results for: 64.246.60.38**

```

OrgName:      Everyones Internet, Inc.
OrgID:        EVRY
Address:      2600 Southwest Freeway
Address:      Suite 500
City:         Houston
StateProv:   TX
PostalCode:  77098
Country:     US

NetRange:    64.246.0.0 - 64.246.63.255
CIDR:        64.246.0.0/18
NetName:     EVRY-BLK-9
NetHandle:   NET-64-246-0-0-1
Parent:      NET-64-0-0-0-0
NetType:     Direct Allocation
NameServer:  NS1.EV1.NET
NameServer:  NS2.EV1.NET
Comment:     ADDRESSES WITHIN THIS BLOCK ARE NON-PORTABLE
RegDate:     2001-10-05
Updated:     2003-03-31

TechHandle:  RW172-ARIN
TechName:    Williams, Randy
TechPhone:   +1-713-400-5400

```

Figure 7. The results of a Whois lookup on the IP address of the web server that hosts <http://www.jasonnolan.net>.

in terms of relevance ranking depends on its analysis of hyperlink structures to indicate the most credible sources of information.

- It is possible to obtain appropriate data to give a rough approximation of hyperlink structures using some of the large web search engines. These will report link statistics (usually available as part of their advanced search options). For example using Google you can find out the number and origin of incoming hyperlinks made to the *jasonnolan.net* website using the search command *link: jasonnolan.net* (Figure 8).
- The Google search engine index reports 346 web pages with hyperlinks to <http://www.jasonnolan.net>. This is a respectable number of links.

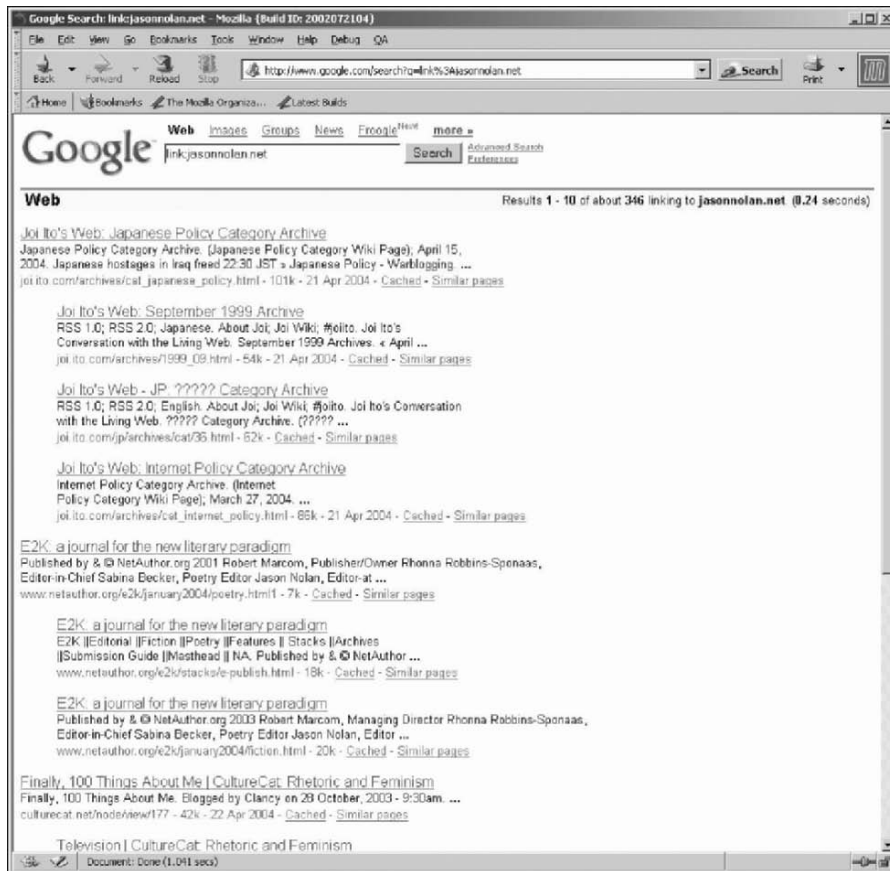

Figure 8. Incoming hyperlinks to <http://www.jasonnolan.net> website according to the Google index.

From a limited understanding, many of them appear to come from blogs citations. This is perhaps not surprising as [jasonnolan.net](http://www.jasonnolan.net) is also a blog.

- These types of informational structures can also be viewed as graphs, where the web pages are nodes and the hyperlinks are connecting lines. A nice example of this is available using *GoogleBrowser*, an interactive tool produced by TouchGraph (<http://www.touchgraph.com>). It allows the active exploration of a website's location in terms of the virtual economy of linkages. Figure 9 shows an example of the *GoogleBrowser* view of linkage network immediately around <http://www.jasonnolan.net>.
- For those interested in exploiting the tactical power of hyperlink analysis to expose the hidden politics of Net:Geography, the research of Richard Rogers and colleagues is well worth consulting (<http://www.govcom.org>).



to be judged as more important because people's exposure to them is more direct, immediate, and frequent. Far away things take longer to experience and thus tend to be less familiar (e.g., people speak a different language) and are perceived as less comfortable and perhaps even as more risky.

- An interesting point of analysis, both on the internet and in the “real” world, is to compute the relationship between distance on the ground and time distance for different places. This relationship is not always linear because of barriers, lack of connectivity, and poor accessibility. Sometimes the quickest places to reach are not always the closest physically. Analyzing the variable patterns in time accessibility can sometimes give insight into underlying structural processes.
- Distance can also be measured by the complexity of the journey, such as the number of interchanges encountered. In terms of the internet, the least-complex distance would consist of the minimal number of different networks crossed or switching points negotiated, which may or may not be the same as the quickest route. The next section of the FAQ demonstrates how route complexity can be plotted by tracing traffic flows.

**Q.** *How can I actually measure latency?*

**A.** There is a useful utility called *ping* that can measure latency (the travel time of data) on the internet. Ping is easy to use and available on most PCs.

- It is a network measurement tool primarily used by engineers to diagnose connectivity problems. Basically, it reports whether a particular place on the internet is “live” and accepting data.
- Ping takes its name from the sound that submarine SONAR uses. Conceptually it works in a similar fashion by sending out small packets of test data to a target host and listening for a response. It is useful for distance measurement because it reports the round-trip time of these data packets.
- Figure 10 shows an example of measuring the distance from a PC in London, U.K. to <http://www.jasonnolan.net> using ping.
- By default on Windows, ping sends out four test data packets. The time each took to go from London to <http://www.jasonnolan.net>'s server and back again is reported (in milliseconds). The last line of the output reports the overall statistics. According to this, the average “distance” for this particular journey across the internet as measured by latency was 340 ms, while the slowest data packet took 391 ms.
- This type of time distance measurement is very susceptible to changes in conditions on the internet, especially congestion in traffic flows. Internet distances measured by latency are never fixed. However, this

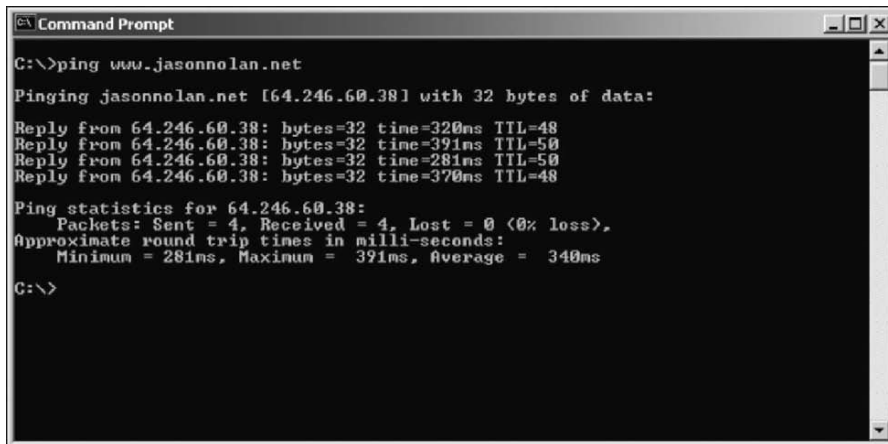

```
C:\>ping www.jasonnolan.net
Pinging jasonnolan.net [64.246.60.38] with 32 bytes of data:
Reply from 64.246.60.38: bytes=32 time=320ms TTL=48
Reply from 64.246.60.38: bytes=32 time=391ms TTL=50
Reply from 64.246.60.38: bytes=32 time=281ms TTL=50
Reply from 64.246.60.38: bytes=32 time=370ms TTL=48
Ping statistics for 64.246.60.38:
    Packets: Sent = 4, Received = 4, Lost = 0 (0% loss),
    Approximate round trip times in milli-seconds:
        Minimum = 281ms, Maximum = 391ms, Average = 340ms
C:\>
```

Figure 10. Using ping to measure time distance between two points on the internet.

variability is actually useful as it can be used as a way of quantifying the fluctuations in internet conditions, much like measuring car speeds gives an indication of the level of road congestion.

**Q.** *What else can I do with ping?*

**A.** There are several ways that “pinging” internet distances can be used to learn more about Net:Geography.

- First, and most obviously, a sequence of pings to the same place at different time periods can be used to build up a comprehensive longitudinal profile of latency. This might reveal interesting temporal patterns in the variation of latency as places on the internet move nearer and further apart in a predictable fashion. Sudden changes in latency that do not fit the profile can reveal serious problems (e.g., a physical cut in a key fiber-optic cable).
- Another useful extension is to take pings from different places on the internet to triangulate in on a particular target point. For example, one could take measurements of latency to *http://www.jasonnolan.net* not just from London, but from other geographically closer or more distant points. The practicalities of doing this type of triangulation are made easier because there are a number of websites which allow you to run pings from their location. (To find them use a search engine to look for “ping websites”.)
- By triangulating from different points it possible to get a sense of the relationship between latency and physical distance, assuming that the (approximate) geographic location of the origins and target are known. It is possible to get the physical distance (measured as the great circle distance) between the cities using a websites distance calculator (e.g.,

John A. Byers's site <http://www.wcrl.ars.usda.gov/cec/java/lat-long.htm>).

- Knowing the latency and physical distance also means you can approximate the speed of data transmission. Indeed, the use of ping has been taken further in a classroom physics experiment to calculate the speed of light. For technical details see Lepak and Crescimanno (2002).

## 5. ROUTES THROUGH THE INTERNET

**Q.** *What route does my data take through the internet?*

**A.** You can answer this question using *traceroute*, a network engineer's tool that allows you to "lift the lid" on the internet and get a "packets-eye" view of its working structure. It is undoubtedly one of the most useful tools available for Net:Geography fieldwork.

- Traceroute works in much the same way as ping but it provides much greater detail. It maps out the path that data packets take between two points on the internet, showing all of the intermediate nodes traversed, along with an indication of the speed of travel for each segment of the journey.
- Traceroute was invented in 1988 by Van Jacobson at Lawrence Berkeley National Laboratory in the United States. The utility often comes as part of the operating system. The Windows version is called *tracert* and is used simply by typing, at the Command Prompt, *tracert [internet address, e.g., www.jasonnolan.net]*.
- Although, traceroute is primarily for network engineers to "debug" routing problems, it can also be used in a more tactical fashion by researchers to expose the political–economical structures of the internet. It reveals the hidden complexity of data flows, showing how many nodes are involved (often more than twenty), the seamless crossing of oceans and national borders, and the sometimes convoluted transfers through networks owned and operated by competing companies.
- To illustrate how traceroute "maps" the internet, it was used to chart the path from a PC in London to the <http://www.jasonnolan.net> website. Figure 11 shows the result.
- It is important to note that the view of data routing that is "seen" by traceroute is quite a generalized, "high-level" summary of the network in terms of topological connections. Below the traceroute view, there is a much more detailed level of routing in terms of the geography that lies between each node, based on the types of wires and their physical pathways in the ground. Sadly, this level of detail is not measurable using present Net:Geography fieldwork techniques.



```

C:\>tracert www.jasonnolan.net
Tracing route to jasonnolan.net [64.246.60.38]
over a maximum of 30 hops:
  0  191 ms  180 ms  160 ms  webport-c12-hg9.ealing.ndip.bt.net [212.140.88.200]
  1  211 ms  180 ms  170 ms  192.168.1.38
  2  200 ms  160 ms  180 ms  interconnect5-10.ealing.fixed.bt.net [195.99.125.166]
  3  240 ms  531 ms  180 ms  core1-pos4-3.ealing.ukcore.bt.net [194.72.9.241]
  4  481 ms  1051 ms  301 ms  core1-pos10-0.redbus.ukcore.bt.net [194.74.65.254]
  5  1352 ms  *  *  ldnuk1icx1.wcg.net [195.66.224.185]
  6  *  *  *  nycmm2wxc2-pos3-1.wcg.net [64.200.37.153]
  7  8  901 ms  631 ms  240 ms  hndvalwxc2-pos5-0.wcg.net [64.200.210.97]
  8  571 ms  251 ms  240 ms  hndvalwxc3-pos9-0.wcg.net [64.200.75.74]
  9  290 ms  271 ms  260 ms  drvlgalwxc2-pos4-0.wcg.net [64.200.232.125]
 10  301 ms  250 ms  261 ms  drvlgalwxc1-oc48.wcg.net [64.200.127.27]
 11  300 ms  290 ms  271 ms  dllstx1wxc3-pos6-0.wcg.net [64.200.240.21]
 12  330 ms  271 ms  280 ms  dllstx1wxc2-pos10-0-oc48.wcg.net [64.200.110.77]
 13  331 ms  270 ms  280 ms  hstntx1wxc2-pos4-0.wcg.net [64.200.240.74]
 14  331 ms  280 ms  271 ms  hstntx1wxc2-everyonesinternet-gige.wcg.net [65.77.93.54]
 15  *  *  *  207.210.245.113
 16  320 ms  301 ms  270 ms  jessica.epanelserver.co.uk [64.246.60.38]
Trace complete.
C:\>_

```

Figure 11. Traceroute from London to <http://www.jasonnolan.net>.

**Q.** This does not look much like a map, can you explain what it means?

**A.** The end result of a traceroute does look rather cryptic at first sight, but it is in fact a kind of one-dimensional map of how the data flows, with each node traversed listed on a separate line.

- The “map” gives a complete linear route listing showing how data packets traveled through the internet starting in London and ending at Houston in the United States—the apparent location of the web server which publishes <http://www.jasonnolan.net>. The three time measurements in milliseconds—such as 211, 180, and 170 ms—are round-trip times for that segment and give a useful indication of the speed of each link.
- Each node traversed is identified by its domain name and numeric IP address. Not all nodes have a domain name (e.g., 192.168.1.38). Also, notice that many nodes have strange, long domain names (e.g., *dllstx1wxc3-pos6-0.wcg.net*). These are routing computers at the core of the internet and their domain names are not normally seen by users. With a little bit of “decoding” these router domain names can yield useful information, such as the type of node hardware, the bandwidth of the link, the name of ISP that owns a node and often a node’s approximate location (usually at the city level). Fortunately, for traceroute explorers, many of the large ISPs apply a consistent naming convention throughout their network infrastructures (as you can see from the domain names of nodes owned by *wcg.net* in Figure 11).
- The geographic location of the node is often represented in these types of domain names as an abbreviated city name. For example, *dllstx* at

the start of segments 12 and 13 (Figure 11) could sensibly be guessed to mean Dallas, Texas. Some ISPs use the familiar three letter airport identification codes (e.g., LHR for London Heathrow) as their city naming convention. (There are lists of these airport codes available on the web, for example, at <http://www.orbitz.com/App/global/airportCodes.jsp>.)

**Q.** *How do I interpret the actual route to <http://www.jasonnolan.net> from the traceroute output?*

**A.** The first thing to note is that data traveling from London to <http://www.jasonnolan.net> had to pass through 16 intermediate network routers to reach the end of the destination (node 17). At least three different networks were traversed—British Telecom (BT), Williams Communication Group (WCG), and Everyones internet.

- Reading the route line by line, it begins with the first node—how a user’s PC is connected to the internet. From the domain name we can see that it belongs to *bt.net*. From local knowledge, it is known that “*ealing*” in the domain name is also an area in West London, so we can take this as an indicator of its likely geographic location.
- The next “hop” in the journey to node 2 is rather mysterious with no domain name to decode. We have to assume it is a node within BT’s network in London.
- Node 3’s domain name indicates it is another BT node in Ealing, London.
- Node 4 again says “*ealing*” and BT. The node also states “*ukcore*” which we might reasonably take to mean this node is within BT’s core network for the United Kingdom.
- Node 5 is also in BT’s “*ukcore*” network. Notice the increase in latency as measured by the RTT at this point in the journey.
- At “hop” 6 in the journey the data leave BT’s network and is handed off to another ISP called *wcg.net* (Williams Communication Group, now part of Wiltel corporation). The cryptic abbreviation at the start of the domain name (“*lndnuklicx1*”) can reasonably be decoded as London, U.K. The convention on this ISP’s network is to start the domain name with a four letter abbreviation of the city, followed by a two letter code for country/U.S. state. Note the big jump in RTT and the appearance of \* for two of the times (this means timed-out, no response) at this point, probably due to traffic “congestion”.
- The next segment in the journey sees the data packets cross the Atlantic to New York, most likely on an undersea fiber-optic cable. The start of the domain name for node 7 is “*nycmny*” which can be decoded as New York City, New York. The RTT increases greatly at this point, again with two \* timeouts.
- From New York the data travel on *wcg.net* network to “*hrndva*” at nodes 8 and 9 that are in Herndon, Virginia (one of Washington D.C.’s

satellite towns which has a great deal of internet infrastructure related companies).

- The next two steps in the journey on wcg.net's network are in "drvlga" which is somewhere in the state of Georgia. However, it is not immediately obvious which town "drvl" refers to. Perhaps it is a suburb of Atlanta, the main internet hub point for the state.
- We are now approaching our goal, as the data move on into the state of Texas, going through Dallas ("dllstx") in nodes 12 and 13 and then to final destination, the city of Houston, Texas ("hstntx") at node 14.
- At node 15, the wcg.net network exchanges the data to a new company, EveryonesInternet (Everyones Internet, Inc.).
- Nodes 16 is most likely on EveryonesInternet network but does not have a domain name, so it is hard to know for sure.
- Node 17, somewhat confusingly called "jessica.cpanelserver.co.uk", is the domain name of the web server that hosts <http://www.jasonnolan.net> website. It is unclear why this server in Houston has a *co.uk* domain name!
- It is important to realize that internet routing is dynamic, it can change minute by minute. The "map" that is produced by traceroute is a live scan and always represents a one-off snapshot of Net:Geography at the point in time it was charted. Running the same trace at a future time is quite likely to give a different map.

**Q.** *Can I run traceroutes from different places?*

**A.** Yes, just like ping you can "triangulate" the internet using web-based traceroutes.

- These make it possible run traces from many different starting points, including on different networks and in completely different continents. web traceroute gateways are very useful for active exploration of the Internet's topology from across the globe and illustrate the degree to which routes vary.
- There are several hundred freely available web traceroute gateways in many places. Thomas Kernen maintains a good list of them at <http://www.traceroute.org>.
- As an example of traceroute triangulation we ran a trace from Australia to <http://www.jasonnolan.net> using a gateway provided publicly by Telstra, the main Australian telecoms carrier. Figure 12 shows the output "map" from the trace. (Note that the formatting of this output is slightly different to that produced by Windows tracert.)
- Again, with a little bit of decoding work, reading line by line, it is possible to follow the data packets on this new journey. The traceroute utility is installed on a *telstra.net* server located in Canberra, Australia indicated by the domain name for node 1. The next two nodes in the trace were also within Canberra, according to their domain names.



Figure 12. An example of a web-based traceroute from Canberra, Australia to <http://www.jasonnolan.net>. (Available at <http://www.telstra.net/cgi-bin/trace>).

- At node 4 the data moved a couple of hundred miles on the *telstra.net* network from Canberra to Sydney. The data are then passed through three nodes in Sydney before leaving the Telstra network for the *reach.com* network at node 6.
- The big trans-Pacific hop in the journey occurred at node 7, as the data went to “*sjc*”, the airport code for San Jose, California. Note, the marked jump in the RTTs at this point in the journey, caused in large part by the 7500-mile distance across the Pacific Ocean.
- Node 8 on the *reach.com* network is located at “*paix*”, the name of a major internet exchange point located in Palo Alto, California. Node 9 is cryptic. At node 10, the data left PAIX for a new network, that of *above.net*.
- Nodes 10 and 11 on *above.net*’s network were located in San Jose, California as indicated by the “*sjc*” codes in their domain names.
- The data moved on from California into Texas, going to Dallas-Fort Worth (“*dfw*”) at node 12. It moved onto Houston, Texas (“*iah*”) at node 13.
- The final stretch into <http://www.jasonnolan.net> took place at nodes 14 and 15, which are likely to still be in the Houston area.

**Q.** Can I geographically map traceroute output?

**A.** Yes, an obvious refinement of the regular traceroute list output is to try to plot the route visually on a geographic map. There have been a

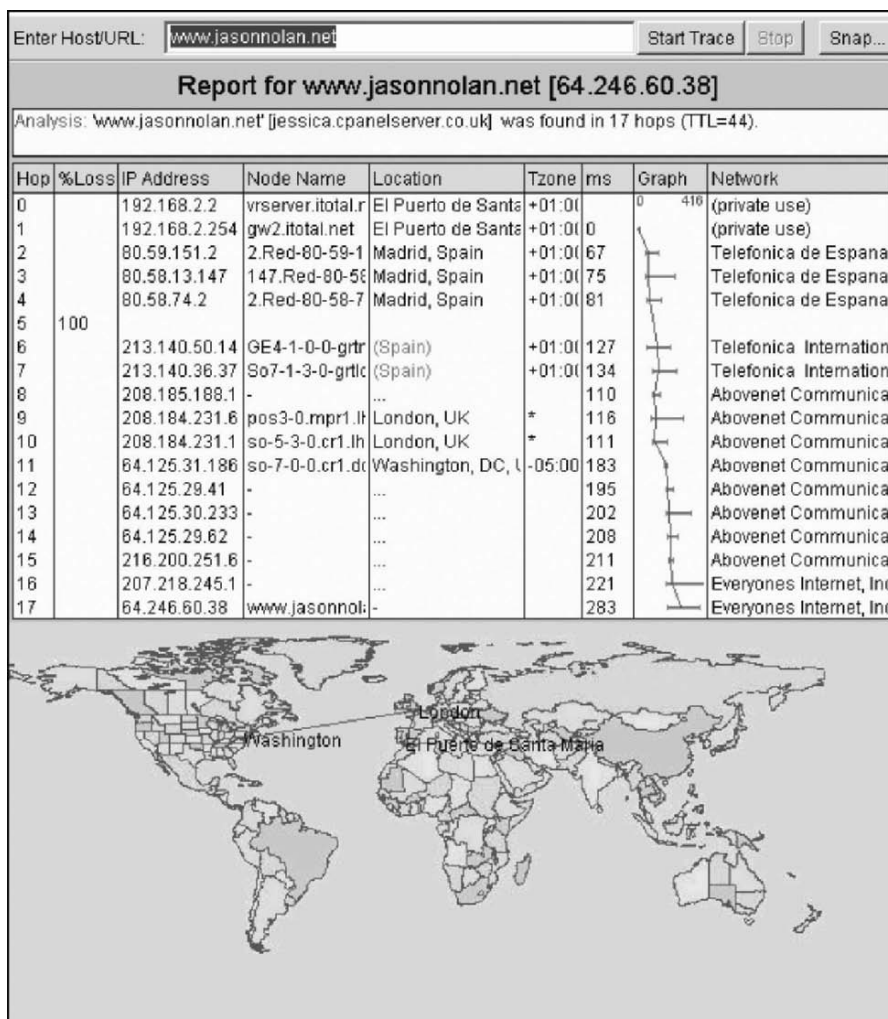

Figure 13. An example of a geographic traceroute produced using VisualRoute.

number of attempts at a geographical traceroute, with varying degrees of success.

- Figure 13 is a screenshot of the best geographic traceroute program currently available, called VisualRoute (<http://www.visualroute.com>), tracing the data route from a server in Spain to <http://www.jasonnolan.net>. The top half of the display is table presentation of the trace results. The approximate locations (where known) of the routers are plotted on a rather crude map below.
- The particular advantage of this application is the ease of geographic interpretation of routing. For example, it can provide direct visual

evidence of the Internet's business "logic" of data routing following the cheapest paths rather than the geographically shortest. Much international internet traffic is still routed through the United States as the cheapest means of transit between regions. This can result in sometimes quite anomalous looking, circuitous routes being chosen.

- However, automated geographic traceroute is far from perfect. It is very hard for software to reliably "decode" the router domain names, as this often requires local knowledge, human intuition, and a bit of guesswork. The large number of gaps in the "Location" column of the traceroute results table in Figure 13 clearly show the limitations.

**Q.** *What else can I tell from traceroute results?*

**A.** There are practical things you can use traceroute data for. It can also be used for more political "debugging" of the Internet's structure.

- Traceroute can be really useful for deducing the approximate location of internet hosts (such as websites) in terms of "hardware geography". The output can tell you the location and identity/owner of the "upstream" network provider even if the final destination of the server is unclear. If the data travel into a certain city and does not leave it again, it is probable that the target is located there. For example, deducing that <http://www.jasonnolan.net> is published from a web server in Houston, Texas. Also, the "upstream" network providers may keep logs for identifying a host that is of interest (this is of particular concern for law enforcement agencies in tracing the source of illegal activities).
- Traceroute has also been used in a physics classroom experiment to measure the size of the earth. See Kicovic et al. (2002).
- Running multiple traceroutes to lots of different points across the internet has also been used to gather data to chart the topology of the core of internet. The results of which have been impressively visualized as huge abstract graphs, providing some of the most evocative representations of Net:Geography. See for example Lumeta's Internet Mapping Project (<http://lumeta.com/mapping.html>) and Branigan et al. (2001).
- Traceroute can also reveal something of the hidden political economy of the internet. The patterns of traffic routing show the transit agreements and mutual peering relationships between competing companies. Details on these deals are often deemed commercially confidential but are revealed by necessity in how and where the actual networks interconnect to share data. The routing of traffic reveals the structuring of business relationships in terms of who connects to whom and the hierarchy of these connections (from periphery to center to periphery again). It can also show which telecommunications carriers dominate the transfer of traffic between certain countries and between continents. These companies are likely to be influential in the structuring of global

communications and tracerouting could provide an alternative way to quantify the extent of their power.

- Traceroute can show potential vulnerabilities in the structure of the internet. Are there particular choke points in the routing of data flows? Is there only single route into a region or between two cities?
- Lastly, the output from traceroute provides a useful way to assess the number of international borders crossed and determines which different territories (i.e., separate legal jurisdictions) the data transit. The more “points of contact” in the flow from origin to target, the more potential there is that internet traffic could be intercepted and subjected to local regimes of monitoring, filtering, censorship, and data retention. For example, does an e-mail message transit through a third-party nation that has hostile intentions. Particularly in regions of conflict, being able to identify territories that are transited might be vitally important in terms of the reliability of communication. For example, does an e-mail to someone in Palestine transit through Israel?

## CONCLUSION

**Q.** *So what is the future of Net:Geography fieldwork?*

**A.** As the internet grows in size, expands in scope, and becomes increasingly embedded as a banal and invisible background to everyday living, it becomes more important to understand its politics. We would argue that understanding the geographies of the internet, through Net:Geography fieldwork using the techniques and tools described here, provides one of the most valuable avenues into network politics, allowing you to gather information firsthand and critically question network operations directly.

- Net:Geography fieldwork is likely to become easier as new and more powerful software tools for scanning the structure of internet become available. This will be a benevolent outcome of the experience in the design of the current plague of internet worms and viruses and ways to counter them. Also, as search engine tools develop they will increasingly provide new ways to do Net:Geography fieldwork in terms of mapping the information structures of the internet. Of course, researchers will continue to have to tread carefully along the ethical boundaries between critical fieldwork and potentially criminal hacking.
- Yet, at the same time, Net:Geography fieldwork is also going to get harder and riskier to do. Individual networks on the internet are increasingly being designed and operated in a much more closed fashion. For example, the university networks of the authors have recently begun blocking ping and traceroutes as a security precaution against malicious scanning. Other areas of the internet are also using the cover of greater security as a way to try to develop more proprietary and profitable

business operations. While many internet users, for example on peer-to-peer networks, are likely to be using software tools in future that encrypt and cleverly attempt to mask their activities and their locations to preserve confidentiality of communication in the face of evermore draconian monitoring by corporations and governments. This will also have a side effect of frustrating Net:Geography fieldwork.

- Despite these changes, Net:Geography provides a very useful set of virtual learning tools for interrogating the media that supports virtual learning itself. They can reveal important details about the geography of infrastructure, the linking of information, differential access to resources, and so on. They therefore constitute a useful resource to those interested in virtual learning.

#### REFERENCES

- Branigan, S. Burch, H. Cheswick, B., & Wojcik, F. (2001). What can you do with traceroute? *Internet Computing* 5(5), 96. Available at: <http://computer.org/internet/v5n5/index.htm>.
- Clayton, R. (2001). The Limits of Traceability. Available at: [http://www.cl.cam.ac.uk/users/rnc1/The\\_Limits\\_of\\_Traceability.pdf](http://www.cl.cam.ac.uk/users/rnc1/The_Limits_of_Traceability.pdf).
- Kicovic, S., Webb, L., & Crescimanno, M. (2002). Measuring the Earth with Traceroute. Available at: <http://arxiv.org/abs/physics/0208087>.
- Lakhina, A. Byers, J. W., Crovella, M., & Matta, I. (2002). On the geographic location of Internet resources. *Technical Report 2002-15*, Computer Science Department, Boston University. Available at: <http://www.cs.bu.edu/techreports/pdf/2002-015-internet-geography.pdf>.
- Lepak, J. & Crescimanno, M. (2002). Speed of light measurement using ping. *Report No. YSU-CPIP/102-02*. Available at: <http://arxiv.org/abs/physics/0201053>.
- Padmanabhan, V. N. & Subramaniann, L. (2001). Investigation of Geographic Mapping Techniques for Internet Hosts. *SIGCOMM'01*, August 27–31, 2001, San Diego. Available at: <http://www.research.microsoft.com/~padmanab/papers/sigcomm2001.pdf>.
- Reporters without Borders. (2003). The Internet Under Surveillance: Obstacles to the Free Flow of Information Online. Available at: <http://www.rsf.org>.
- Searls, D. & Weinberger, D. (2003). World of Ends: What the Internet is and How to Stop Mistaking it for Something Else. Available at: <http://www.worldofends.com>.



## Chapter 49: Hacktivism: The How and Why of Activism for the Digital Age

MICHELLE LEVESQUE

*Toronto, Ontario, Canada*

On the main floor of the Munk Centre for International Studies, a formal reception is taking place: The topic of discussion is internet accountability. The political figures that are participating in the reception have arrived at the University of Toronto wearing suits and ties, and gather over appetizers for a chance to speak their piece. Below this formal event—one floor down, in the basement of the Munk Centre—heavy rock music is blaring. A crew of well-caffeinated undergraduates are coding programs to probe international computer networks. Over the loud music and between the flurry of fingers against keyboard, they are having the same discussion as the formal reception one floor up: internet accountability. This is the Citizen Lab and its inhabitants call themselves hacktivists.

Understanding the history of hacktivism helps us to understand its current manifestation. Once its history is understood, it is possible to appreciate some of the issues that hacktivists tackle, such as internet censorship and online surveillance. These issues are often otherwise neglected, as they tend to be too technical for a strictly political group to understand, and too politically involved to interest most technology-driven groups. And yet they remain some of the most significant issues surrounding the internet today, because they affect our privacy, freedom of speech, and the free exchange of information. It is through education and raising awareness about these issues that these freedoms will be preserved, and this is what makes hacktivists so important.

Hacktivism evolved from a diverse set of groups who are in part represented by two very distinct cultures: hackers and activists. Nart Villeneuve, a hacktivist and member of the Citizen Lab, believes that “it is necessary to understand their respective backgrounds in order to analyze this historic merger and to examine [hacktivists’] challenges and future capabilities” (Villeneuve, 2003). First, it is important to make the distinction between hackers and crackers. Crackers are those who break into computers in order to achieve destructive ends. Though the media will often confuse the two terms, hackers are very different. “Hacker” was originally a term that was coined to represent an individual’s deep understanding of computer systems and networks. Hackers use their skills to invent, modify, and refine these systems, often creatively using computers to achieve a goal for which the system was not originally intended.

The history and philosophy of hackers is thoroughly explained in Steven Levy's book *Hackers: Heroes of the Computer Revolution*. Levy (1984) explores the original hacker ethic that "access to computers should be unlimited and total" and "all information should be free". It was this ethic that spawned the Free and Open Source software movements and the General Public License (GPL). Software released under this license, such as the GNU/Linux operating system and over 40,000 applications (OSDN, 2002), may be freely used and modified as long as the source is made available to others, so that future hackers are free to tinker with these programs. This same ethic also creates a natural antagonism between hackers and those who would seek to monopolize, control, or censor the internet, as hackers believe very strongly in free access to information.

While the hacker community was growing and expanding, activists were beginning to integrate internet technology into their decentralized networks. In the mid-1980s, while the internet was still young, the first version of PeaceNet was released, enabling political activists to communicate across national borders with relative ease and speed. Since then, as the internet expanded and flourished, so too did the activist networks that were based on it, because the internet provided for many of their needs: "The internet has boosted the intellectual capacity and interconnections of citizen activists enormously" (Deibert, 2000). It facilitated these activities by providing a low-cost transport layer for sending the vast amounts of data necessary for activist collaboration and mobilization (Denning, 1999). It also offered a safe place to co-ordinate illegal or dangerous protests because messages could be posted outside of that country's borders, such as protest.net. Michael Dartnell, a political science professor at Concordia University, believes that the internet changed how the world played the game of politics: anti-government groups were now able to use this advanced communication technology to establish alliances and coalitions that were previously impossible (Denning, 1999). But most importantly, activists realized that the internet was ideal for transporting messages to a wider audience. It cost relatively nothing in order to publish messages to a public forum or website, compared to the considerable costs involved in operating a radio or television station or printing a newspaper: The internet thus was enabling the democratization of the media.

It is from these politicized hackers and techno-savvy activists that hacktivists evolved. Villeneuve (2003) states that "the evolutionary progress of both communities has put them in a position where they can compliment each other because they face the same techno-political opposition: the repressive use of laws and technologies by private corporations and governments to increasingly monitor and control the internet". The issues that interest individual hacktivists are varied, as are the techniques that they use for fighting for these issues. But since freedom of speech is a recurring theme in hacktivism, two of the largest issues that they undertake are internet censorship and online surveillance. Both of these issues are fairly technical in nature, but have

profound political implications, which makes hacktivists the ideal candidates for exploring them.

Internet censorship is when a government body intentionally filters internet content in order to prevent that content from being viewed or posted. The nature of the content being blocked varies. Sexually explicit content is filtered in Yemen, Singapore, U.A.E., many U.S. libraries and schools, Thailand, etc. The Turkish Internet Service Provider (ISP) NetOne blocks international news websites. Dissident websites are blocked by Myanmar, Saudi Arabia, Iran, and several other countries. And even human rights information is sometimes censored, for example in Syria, Vietnam, and China (Villeneuve, 2004). Figuring out exactly what content is being blocked—as well as how it is being blocked—is the first step to examining internet censorship. But it is not an easy task. There are many levels of complexity, and it is important to distinguish between being unable to access a webpage because it is filtered, and being unable to access a webpage because of a network hiccup, or because the webpage is currently offline for a moment.

When a webpage is being blocked, there are several possibilities of what a user might see, depending on how the filtering was set up. Sometimes the user sees a “404 Page Not Found” error, or a server error; the exact same error that they see if they try to visit a website that does not exist. Sometimes they are redirected to a fake webpage, which has some of the content removed. Sometimes their internet connection suddenly stops working, and then access returns only after a few minutes have passed (Zittrain & Edelman, 2003). And sometimes a user sees what is called a “block page”: A signature from the filtering software to inform the user that they are attempting to view banned content and have been denied access (Figure 1).

There are also several locations where the filtering can occur: Anywhere along the connection between the user and the target website. For example, if you are connecting from a University residence in Ottawa, and trying to visit a website in Edinburgh, the connection might look something like this: your computer connects to a router on the floor of your residence, which connects to your residence’s main router, then to the University’s server, to the ISP of your University, to a larger ISP in New York, across an international line to London, to an ISP in Edinburgh, to the webpage’s server. At any of these nine locations (including both your computer and the webpage server itself) data filtering could be taking place.

This blocking can also either be centralized or distributed. Centralized filtering usually occurs in countries with few international access points or ISPs. This filtering is centralized and co-ordinated nationally, so the same filtering behavior can be expected no matter where you are in the country. However, when a country’s internet population grows, it often becomes too unwieldy for a single governing body to implement this filtering, and instead the implementation is delegated to individual ISPs. When this happens, there are often variations in the blocking behavior. When new lists of webpages to

## ACCESS HAS BEEN DENIED

Access to the page:

<http://www.freeburma.org>

... has been denied for the following reason:

Banned site: freeburma.org

You are seeing this error because the page you attempted to access contains, or is labelled as containing, material that has been deemed inappropriate.

If you have any queries contact your ICT Co-ordinator or Network Manager.

Powered by [DansGuardian](#)

*Figure 1. The block page that a user from Myanmar would see if they attempted to visit <http://www.freeburma.org>. This block page identifies the filtering software being used as DansGuardian.*

block are released, the time that it takes an ISP to update their system varies, so the population that they serve will temporarily have a different set of websites blocked than the rest of the country. And sometimes there is not a specific list of websites provided to the ISPs: They are simply told to block categories (like sexually explicit material, gambling websites, etc.) and it becomes the ISP's responsibility to implement the filtering. When this happens, ISPs often turn to commercial providers.

There are many internet filtering packages available, such as Cyberpatrol, BESS, SmartFilter, SquidGuard, and many more. These applications usually offer an easy way for a user to select the website categories that they would like to block, without having to worry about the implementation details. For example, the product SmartFilter offers 30 categories, such as Nudity, Gambling, and Hate Speech, but also Arts/Culture/Heritage, Educational/Reference, General News, Non-Profit Organizations/Advocacy Groups, Politics/Opinion, Search Engines, and others (SecureComputing, 2004). Thus, an ISP can block its users' access to all General News websites (such as CNN and Google News) with only a single mouse click (Figure 2).

There are several important issues that should be discussed when countries and ISPs are using third-party software to assist in internet censorship, but one of these important issues is that many of these filtering products have closed-source lists. This means that the exact specification of which websites will be blocked when you choose to block "Politics/Opinion" is the undisclosed

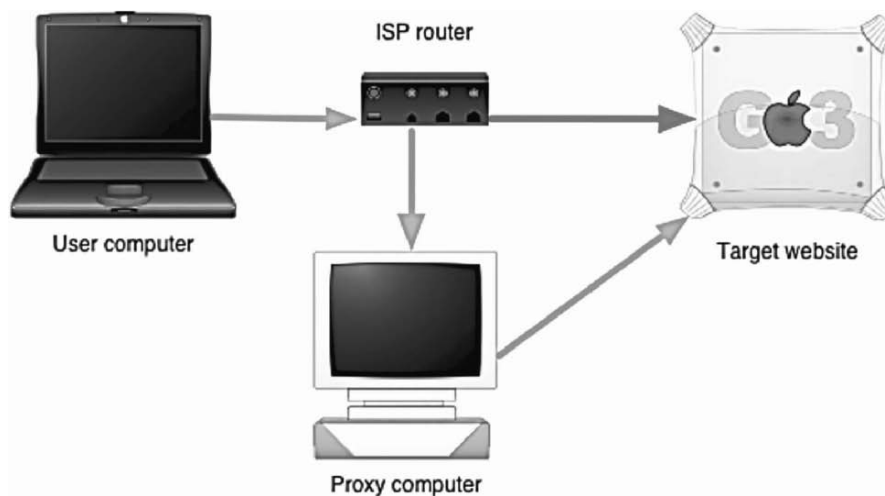

Figure 2. Although an ISP may deny access to a specific website, if the ISP does not deny access to a proxy computer, a user can surf through that proxy computer to visit the website, uncensored.

intellectual property of the company that owns the product. Therefore, governments and ISPs that are using these products for internet filtering are putting their citizens' access to information into the hands of external corporations. If a filtering product miscategorizes a website, something that occurs frequently, the entire country could be unable to see that website's content. For example, 40% of U.S. schools filter their internet with a product called BESS to prevent access to sexually explicit websites, however, BESS also blocks access to some teen advice pages because it classifies them as "sex". Saudi Arabia was found to be blocking multiple gay and lesbian rights websites, because they were using SmartFilter to try to block pornography, and SmartFilter miscategorized these websites as porn. Likewise, the Kuwaiti ISP QualityNet blocks [teenpregnancy.org/teen](http://teenpregnancy.org/teen) as a result of SmartFilter's miscategorization of this portion of the site as sex (Villeneuve, 2004).

Upon examining how these filtering products work, it becomes obvious why miscategorizing is common. The three most common methods are: blacklist (every website may be viewed except for a few explicitly chosen ones), whitelist (only explicitly chosen websites may be viewed), and keyword searching (blocking based on whether certain keywords are present in the URL or in the page itself). However, none of these methods work flawlessly. Google's SafeSearch, an option that Google's search engine provides so that its users can remove all pornographic content from their search results, warns that "no filter is 100% accurate". The problem with blacklists and whitelists lies in the vastness and dynamic nature of the web: The internet is in a constant state of flux, and a webpage that advertizes computer parts one day may turn into a blog about golfing the next day. The problem

with keyword searching is that the URL of a webpage does not necessarily describe its content, and thus over-blocking frequently occurs. For example, the pornography filters in place by a product called Anonymizer blocks keywords like “ass”, “hot”, and “breast” (OpenNet Initiative, 2004). Among many actual pornographic websites that this blocks, it also blocks websites like usembassy.state.gov and www.grass-roots.org (because they contain the word “ass”), www.hotmail.com and www.hotels.com (because they contain the word “hot”) and www.breastcancer.com and breastfeed.com (because they contain the word “breast”). These examples are just some of the many that illustrate that keyword searching is often an inaccurate filtering technique.

Similarly, blacklists and whitelists are often inaccurate because there are simply too many websites in existence—and new ones are constantly being created—for it to be feasible to manually visit them all. Therefore, these lists are often generated by computer programs that try to automate the categorization of websites. Like keyword searching, this automated method tends to over-block webpages. When these blocking techniques affect which websites citizens of a country can and cannot view, studying their inaccuracies becomes an important part of studying internet censorship as a whole.

Hactivists and others have taken an interest not just in studying these many cases of internet censorship, but also in developing mechanisms for those in censored countries to circumvent the filtering. There are many initiatives that are currently developing applications for internet censorship circumvention. Most of these initiatives are based on the idea of providing a proxy between the censored user and the content that they are unable to access. A proxy is an application that visits a requested website and returns the content. For example, if a proxy is running in San Francisco, a user in China can connect to the computer in San Francisco and request content from www.falundafa.ca. The proxy computer visits the requested webpage and gives the content back to the user in China. The ISPs and the national backbones between China and San Francisco only see the connection to the proxy computer, not the final destination, so the connection is not blocked.

There are several types of proxies. The most common are webserver, CGI, remote account, and content duplication. Webserver proxies are when web servers (the same that are used to serve webpages) are configured to serve external webpages. So instead of connecting to www.example.com and requesting the page /index.html (which would retrieve the webpage www.example.com/index.html) or the page /sample.html (which would retrieve the webpage www.example.com/sample.html), a user can connect to www.example.com and request the page www.google.com (which would retrieve the webpage www.google.com, despite the fact that the connection was to www.example.com). CGI proxies are webpages that contain a form where a user can type in a URL, and that URL's content appears. There are several CGI programs which provide this service, such as CGIProxy and PHPProxy. Remote account proxying is when the user has a shell account on a computer

in another (preferably uncensored) country and can telnet or ssh to that computer and surf the web from that computer. Lastly, content duplication is when webpages mirror each other's content, so that if only one of the webpages is blocked, users may be able to access the other sites and thus still access the content.

A variation of content duplication is to provide web content through different ports. For example, having web content e-mailed to you, or sent to you *via* your favorite Instant Messenger client. There are several services available that will e-mail any given webpage to you, and these are used by many Iranian citizens who want to access blogs that have been blocked by Iranian ISPs (Derakhshan, 2004). An application called RSSinator allows users to mirror RSS feeds from news sites and blogs, such that those in countries that block these sites can still use their favorite RSS aggregator program to browse these websites.

Using a proxy is usually an effective way to circumvent internet filtering, but it has several problems. The largest problem is how to let citizens in censored countries know where they can find these proxies. One approach has been to spam these proxies to e-mail addresses within the country, but this approach is often ineffective because as soon as the citizens find out about these proxies, the government usually finds out too, and the proxy computers are then added to their blacklists, so they are no longer useful. A second approach is being taken by an application being developed by the Citizen Lab called Psiphon. Psiphon is a personal proxy that users can easily install on their computer for friends in censored countries. It is then the responsibility of the Psiphon user to inform his/her friends of where they can find this proxy. By using personal communication networks as opposed to mass broadcasting, it is much less likely that censoring governments will discover and block these proxies.

However, all of these techniques for censorship circumvention are simply temporary solutions. Once they reach a critical mass of effectiveness, it becomes worthwhile for censoring governments to invest time and effort to block these mechanisms, and then new circumvention technologies must be developed. Also, they are only effective for users who are willing to research circumvention applications available, and who are willing to go against their government's policies to have these websites restricted. The only way to permanently end these blockings is for censorship policy to change.

The other major issue tackled by hacktivists is internet surveillance. Online security, privacy, and surveillance have become hot media topics, but few individuals are aware of how much or how little internet surveillance is actually taking place. The surveillance problem affects more than just individuals' privacy: Many non-governmental organizations (NGOs) fear that their online activities are being monitored by local and national governments and that their security has been or may be compromised. Compromised security in some contexts can result in arrests, imprisonment, or even death. In many parts of the world, ISPs are being required by law to keep logs of users' activities, and

some are doing so of their own initiative. This information could be sold to advertizing agencies, handed to the government, or used for identity theft.

Not only is there a lack of substantial internet surveillance policies, but a lack of understanding of what is going on and a lack of information being given back to the public. A 1999 paper that deals with the issues involved in explaining cryptographic systems to the general public states: “Many people use debit cards to pay for goods, where money is transferred directly from their bank account to the store’s. In the process, the bank finds out where the purchase is being made, and could build up a profile of the person’s shopping habits . . . . Most people are quite unaware that cryptographic protocols exist which enable the transaction to be carried out reliably without the bank being able to identify who the money is going to!” (Bell et al., 1999).

Points of potential internet surveillance are basically identical to points of internet censorship: Anywhere in between (and including) your computer and the target computer, surveillance could be taking place. Unfortunately, there is no accurate technological means to determine whether or not this is actively taking place. It is similar to sending a postcard: There is no way to find out if any of the post office employees read the postcard while it was in transit. Because postcards are open to be read by anyone who handles them, most people do not (or at least, they should not) write sensitive data like credit card numbers on the back of postcards. Similarly, although there are an uncountable number of online transactions taking place every day (and it is improbable for them all to be manually monitored), as disk space becomes more affordable, it becomes easier for institutions (ISPs or governments) to log all of these transactions and run programs to gather the data that might be of interest to them. Therefore, if you ’are sending data over the internet that you would not feel comfortable having the employees at your ISP read, you should be using encryption techniques to secure your communications.

Safe, unread, untampered online communication is really two problems: authentication and secrecy. Authentication is proof that the two parties involved really are who they say they are (and that they are not a malicious third party), and secrecy is the desire to keep the message secret. Both of these are necessary in order to establish secure communications. To illustrate why, it is necessary to turn to the example trio often used in cryptography demonstrations: Alice, Bob, and Eve. Alice is trying to send Bob a message, and Eve is a malicious person between them. Apart from just listening in on the message, Eve can also change it in some way: delete it so that Bob never gets it, insert a new message that Alice never sent, change the order of messages, or record it and send it to Bob later. Encryption prevents Eve from reading the message, and authentication prevents Eve from tampering with the message. Bruce Schneier, one of the leaders in cryptology, says, “Never confuse the two concepts. Encrypting a message does not stop manipulation of its contents, and authenticating a message doesn’t keep the message secret. One of the classical mistakes in cryptography is to think that encrypting a





Figure 3. An HTTPS connection, as shown by the lock icon.

message also stops Eve from changing it. It does not.” (Ferguson & Schneier, 2003)

Fortunately, most users do not have to worry about implementing their own encryption techniques because there are already protocols programs and that can be used conveniently and securely. PGP is a common method of securing e-mail communications. It can be installed in any Operating System, and used to encrypt e-mails so that they look like garbled text to all but the intended recipient. “PGP can also be used to apply a digital signature to a message without encrypting it. This is normally used in public postings where you don’t want to hide what you are saying, but rather want to allow others to verify that the message actually came from you. Once a digital signature is created, it is impossible for anyone to modify either the message or the signature without modification being detected by PGP”. (Slegers, 2002)

Also, most common protocols have a secure version to complement the plaintext one. For example, HTTPS is the secure version of HTTP, and SSH is the secure version of Telnet. When a lock appears on the corner of your browser, it is an indication that you are surfing through HTTPS, and that your communication is secure (Figure 3).

If encryption options exist for most internet activity, why is internet surveillance still such an active concern? There are several reasons. First of all, just because these options exist does not mean that they will be used; most sensitive traffic continues to be plaintext because users are not aware of the alternatives, or simply do not believe that it is likely that their activities would be logged. Secondly, since security shortcuts are often taken to save on time and money, there are some circumstances where encrypted traffic is not fully secure.

The most common attack on encrypted traffic is called man-in-the-middle. This is a general term for any attack where Eve intercepts the message between Alice and Bob (for example, if Eve is Alice’s ISP). A real life version of man-in-the-middle occurred in April 2004: “A woman posts an ad requesting a nanny. When a potential nanny responds, she asks for references for a background check. Then she places another ad, using the reference material as a fake identity. She gets a job with the good references—they’re real, although for another person—and then robs the family who hires her. And then she repeats the process”. (Schneier, 2004). This woman, like Eve in a man-in-the-middle attack, inserts herself between the two legitimate parties: The real nanny sends her references to this Eve, because she believes Eve to be a real employer, and the real employer verifies the references and when they are

valid, completes the transaction, unaware that the references do not belong to Eve. This is a form of man-in-the-middle attack that, in some circumstances, is still possible today.

Man-in-the-middle attacks do not have to take place on a network. An example of a physical man-in-the-middle attack is keystroke logging: Intercepting information between your keyboard and the rest of your computer. Keystroke logging is when every key pressed on a user's keyboard is logged to a file. It is possible for this to be a piece of hardware, or an application running on the user's computer. Since it records every key pressed, it also records passwords, encrypted e-mails, and anything else that the user types. The logs can then be remotely transmitted to whoever set up the keystroke logger. If the keystroke logger is hardware, whoever setup the logger would require physical access to the computer, but this can include the vender who sold it to the user, the computer manufacturers, etc. If the keystroke logger is an application program, it requires for that program to be installed. One method that it can be installed through is a trojan (a program that pretends to be friendly, but that runs malicious code). Another is by building the keystroke logger directly into the computer before selling it to the public. Many ISPs require their users to install and run various programs in order to use their internet connection: These programs could, in theory, contain keystroke loggers. The FBI used keystroke logging in the case against Nicodemo Scarfo Jr. (Villeneuve, 2004) in order to intercept the password for various encrypted files that he had on his computer. Since keystroke logging has been used by government agencies in the past, it is a very real possibility that it may be used again in the future.

Being cautious is the best defense against internet surveillance. Encryption programs should be used whenever sensitive data are being transmitted, and applications should not be installed unless you trust their source. Since it is impossible to know if your internet traffic is being monitored, it does not hurt to take a few extra steps to ensure your privacy. Educating everyday internet users about encryption technology is the best first step toward rendering internet surveillance meaningless: If the watchers cannot read what is being said, there is little point to watching it.

These concepts are important for the general public to understand because they threaten their privacy and the free exchange of ideas. Furthermore, many hacktivists believe educating the public about these issues is the first step toward change (Villeneuve, 2004). Other hacktivists seek change by writing software like Psiphon and RSSinator that allows users to circumvent censorship that is being imposed on them. Some hacktivists launch electronic protests, for example, conducting a virtual sit-in on a website by having protesters repeatedly reload the website content at a specific date and time. This spike in internet traffic, called a Distributed Denial of Service attack (DDoS) will cause the web site's server to slow down, and possibly even crash, under the force of many people repeatedly visiting the website. The level of acceptable

hacktivist behavior is an issue under debate, but has roots within the activist community. The hacktivist who defaces web pages for his cause is the electronic equivalent of the activist who smashes windows or graffiti's the sides of building. In both communities, however, destructive activity is not the norm. What *is* the norm is the desire to educate the public about the issues at hand, to help out those in need, and to try to find ways to convince the state that these are policies that need to be changed.

These issues are just some of the areas that hacktivists tackle on a regular basis. In many countries, dealing with these issues is illegal; in many more, what they do is in the "fuzzy gray area" of legality. But they are working in support of broader principles of human rights by forcing governments to be held accountable for their internet policies, and by helping citizens to access a free exchange of information. Because the internet changes so rapidly, many of the facts discussed here will become obsolete in the upcoming weeks, months, and years. However, though the details of who is censoring and surveilling whom will inevitably change with time, the underlying principles will remain the same. In fact, if there ever comes a day when everything said here is irrelevant and obsolete because censorship and surveillance are practices that are no longer acceptable in society, then hacktivism will have truly achieved its goal and we will have won.

## REFERENCES

- Bell, T., Thimbleby, H., Fellows, M., Witten, I., & Koblitz, N. (1999). Explaining Cryptographic Systems to the General Public. Retrieved May 30, 2004, from: <http://unplugged.canterbury.ac.nz/ideas/crypto.pdf>.
- Deibert, R. J. (2000). International plug 'n play? Citizen activism, the Internet, and global public policy. *International Studies Perspectives* 255–272.
- Denning, D. E. (1999). Activism, Hacktivism and Cyberterrorism: The Internet as a Tool for influencing Foreign Policy. Retrieved March 18, 2004, from: <http://www.cs.georgetown.edu/~denning/infosec/nautilus.html>.
- Derakhshan, H. (2004). Peer-to-Peer News Readers Can Best Fight Censorship. Retrieved May 30, 2004, from: <http://hoder.com/weblog/archives/007818.html>.
- Ferguson, N. & Schneier, B. (2003). *Practical Cryptography*. Indiana: Wiley Publishing, Inc.
- Jablon, D. (1996). Zero-Knowledge Password Proofs. Retrieved May 30, 2004, from: <http://www.integritysciences.com/password.html>.
- Levy, S. (1984). *Hackers: Heroes of the Computer Revolution*. New York: Penguin Books.
- SecureComputing. (2004). SmartFilter: Control List. Retrieved May 30, 2004, from: <http://www.securecomputing.com/index.cfm?skey=86>.
- Schneier, B. (2004). Security Notes from All Over: Man-in-the-Middle Attack. Retrieved May 30, 2004, from: <http://www.schneier.com/crypto-gram-0404.html#6>.
- Slegers, W. (2002). The comp.security.pgp FAQ. Retrieved June 10, 2004, from: <http://www.pgp.net/pgpnet/pgp-faq/>.
- OpenNet Initiative. (2004). Unintended Risks and Consequences of Circumvention Technologies: The IBB's Anonymizer Service in Iran. Retrieved May 5, 2004 from: <http://www.opennetinitiative.net/advisories/001/>.

- OSDN. (2002). About SourceForge.net. Retrieved May 30, 2004, from: [http://sourceforge.net/docman/display\\_doc.php?docid=6025&group\\_id=1](http://sourceforge.net/docman/display_doc.php?docid=6025&group_id=1).
- Villeneuve, N. (2003). What is Hacktivism? 2.0. Retrieved May 30, 2004, from: <http://thehacktivist.com/hacktivism.php>.
- Villeneuve, N. (2004). ICE: Internet Censorship Explorer. Retrieved May 30, 2004, from: <http://ice.citizenlab.org/>.
- Zittrain, J. & Edelman, B. (2003). Empirical Analysis of Internet Filtering in China. Retrieved May 30, 2004, from: <http://cyber.law.harvard.edu/filtering/china/>.

## Chapter 50: Weblogs and Collaborative Web Publishing as Learning Spaces

ALEXANDER C. HALAVAIS

*School of Informatics, University at Buffalo (SUNY), Buffalo, New York, U.S.A.*

Weblogs have received a great deal of public attention recently, accompanied by a certain degree of hyperbole. Software designed to maintain weblogs is little more than a simplified content management system. The excitement surrounding weblogs has less to do with flexible systems that ease the process of web publishing, and—like many technologies that allow for virtual interaction—more to do with the cultural practices that have evolved using these technologies as a foundation.

As with any other educational technology, the success of weblogs and other web publishing technologies in an educational setting depends heavily on the specifics of their implementation and use. The following pages explore the exciting potential of weblogs and related tools for student-centered education, provide some indication of how they might be used most effectively to meet the needs of learners, and discuss the inevitable difficulties of engaging the kinds of radically open and democratic education that collaborative web publishing engenders within existing institutional spaces. The assessment of such approaches remains guardedly optimistic, and it is hoped that readers will actively contribute to refining these technologies to allow for more effective and rewarding future learning environments.

### 1. COLLABORATIVE WEB PUBLISHING AS A TECHNOLOGY AND A PRACTICE

It seems clear that weblogs existed well before they were named. These days, there are nearly as many definitions of weblogs as there are weblogs. Most of these relate to the formal presentational structure of a genre of web pages. Jill Walker's (2003) definition, for example, notes that:

A weblog, or blog, is a frequently updated website consisting of dated entries arranged in reverse chronological order so the most recent post appears first (see temporal ordering). Typically, weblogs are published by individuals and their style is personal and informal.

While Walker goes on to suggest some of the behaviors and motivations that lead to this formal presentation, as with most weblog definitions, the focus is

on the web page itself. Such definitions certainly capture many of the features that are frequently found on weblogs, but by no means are these observable attributes always present or clear.

Rebecca Blood's (2000) history of weblogs describes what sort of material is usually placed on such pages. The original weblogs, according to Blood, were websites created to keep track of and publicize other pages found on the web. In some ways they resembled public, annotated "bookmark files", cataloging and identifying websites that the author thought were particularly interesting in one way or another. At least one of these sites also linked to other sites with a similar aim, and this cross-linkage is what would later evolve to become a "blogosphere" of interlinked blogs.

A second type of blogger then emerged, growing rapidly in numbers by 1999, according to Blood. Rather than the outward focus of the public linkers, these weblogs were composed of short diary entries in which authors would make note of their thoughts and experiences, sometimes several times throughout the day. In order to support these new bloggers (and helping to drive the development of blogging) a number of content management systems were developed that aimed to make updating a weblog easier. Naturally, there is no clean line between these two types of blogging; those who primarily provide links often provide reviews of the sites to which they link, and those who publish essays or their short observations often accompany them with linked materials. Rather, these two pure types of blogging help define a spectrum of approaches.

These two ways of identifying weblogs—by their formal organization and by the kinds of content that they contain—may have been adequate during the earliest days of blogging, but as blogging has grown as a phenomenon, it has become clear that part of what makes a weblog is whether and in what ways it is linked to other weblogs. What drove the rise of weblogging was not just a desire to increase the frequency with which personal web pages were updated. When weblogs began to link to one another, bloggers were increasingly able to self-identify as a group, and—potentially at least—as a community. Weblogs exist chiefly as a part of a larger "blogosphere", a term that has been employed in various ways (cf. Hiler, 2002) to describe this collective hyperlinked subweb. That is, one of the most important ways of discovering whether a page on the web is a weblog is whether it links to other weblogs and whether other weblogs link to it. Unlike the earliest examples of weblogs, more recent examples engage in an exchange with some subset of the millions of other weblogs being published.

This focus on the aggregate nature of weblogs begins to indicate that blogs are more than simply a genre of web content, they represent a social practice. Restricting the definition to purely a description of the web sites generated is difficult because it misses so much. The only seemingly vital element of weblogging is a public forum (the World Wide Web) in which bloggers are able to associate and self-assemble into groups. The attraction to weblogging

has less to do with the software involved and more to do with the kinds of social groups that emerge from interactions among weblogs and their authors. These practices provide for serendipitous, unstructured learning, as differing perspectives and discourses come into contact with one another.

In our discussion we should include tools that perform similar functions, and provide for similar venues for social interactions. Wikis, for example, are web pages that are easily updated by (usually) any person who encounters them on the web. While not as familiar as weblogs, the success of projects like Wikipedia—an online collaborative encyclopedia project with nearly a quarter million articles in English alone—has brought collaborative hypertexts like wikis wider recognition. Related systems that allow for the sharing of personal information among networks and friends, often referred to as “social networking systems”, as well as machine-readable forms of weblogs, wikis, and social network information, form a larger information ecology that allows for the traffic of ideas within a community.

While several alternative labels for these technologies have been suggested, all represent some form of collaborative web publishing; that is, all support the addition and editing of relatively short pieces of text, sometimes images, audio, and forms of media, in a way that invites multiple authors to link their ideas together. Of course, while these changes may be small (resulting in what is sometimes referred to as “microcontent”) the impact is often anything but. As the example of Wikipedia above demonstrates, in the aggregate, such efforts can yield a substantial collaborative text. Nonetheless, because the text can be addressed and constructed in very small pieces, it allows for the kinds of communicative give and take that are more often associated with synchronous environments.

It would be a mistake to assume that there is a single culture that pervades the blogosphere to the exclusion of all others. Indeed, the variety of bloggers allows for niche communities of interest that would be far more difficult to maintain without the openness of the blogosphere. Bloggers have inherited a core set of values, common to the early computer hackers, and passed on through earlier virtual environments. Pekka Himanen notes in *The Hacker Ethic* that hackers’ (and here he means computer enthusiasts) relations to the idea of networking, though present in the 1960s, “received a more conscious formulation in recent years” (2001: 86). He traces some of the virtues cultivated by hackers, including passionate engagement in their work, autonomy from government and others, pursuit of social position (sometimes to the exclusion of financial gain), and perhaps most importantly, an active and caring approach to communication on the Net (pp. 139–141; Levy, 2001, lists similar attributes).

These virtues are not difficult to identify within the blogosphere. Mutual aid and open exchange of information are encouraged as norms. Although the commercialization of blogging recently has begun in earnest, many tools remain freely available. The Creative Commons movement, an effort to provide

a more flexible intellectual property regime to encourage the sharing of information, has enjoyed a warm welcome from many in the blogosphere. Many of those who engage in blogging become interested in extending and changing the tools they use, and this kind of amateur tinkering is at the heart of the hacker ethic. Respect from one's peers is highly valued. In many ways, the practices of the blogosphere resemble nothing so much as the scholarly exchanges common in academic settings, and the number of professors and students that choose to take up blogging is therefore not particularly surprising.

Given the nature of collaborative web publishing, it is sometimes difficult for non-participants to understand. Of course, all technologies have considerable social components, but a television, for example, has a fairly limited and easily described range of uses. Weblogging is essentially an evolving collective and social practice, and therefore easier lived than described. In what follows, we will examine ways in which the social technologies that drive collaborative web publishing may be effectively leveraged in educational settings.

## 2. WEBLOGS AS REPLACEMENT TECHNOLOGY

Technologies provide a “valence” of potential uses, to borrow the terminology of Carolyn Marvin (1990), writing in the context of the early adoption of the telephone. What we think of as the telephone today is the result not only of the initial development of the technology, but a complex evolution of social practices over time. Examples of telephone systems used for news broadcasting, or Edison's decades-long delay in accepting the use of the phonograph for music recordings, remind us that a technology does not choose its own use, though it may suggest some uses. In part, this is because new communication technologies are inevitably initially fit into existing ideas of how communication takes place. Depending on the metaphor with which blogging is approached, it may seem fairly obvious how such a technology is to be employed. Nonetheless, new communication technologies also have the capacity to violate our expectations, and usually do (Nord, 1986). Having our expectations disrupted need not be a bad thing; indeed, it is central to the process of learning. Nonetheless, the earliest applications of collaborative web publishing in educational contexts have aimed to replace existing analogues.

Despite the range of ways in which weblogs might be employed, the two general types of weblogs identified by Blood, above, suggest the most obvious potential uses. Diaries and journals are a longstanding fixture of writing and foreign language classes. Journals are also commonly employed in other subjects, including lab notebooks in the sciences, and sketchbooks and portfolios for teaching the arts. Teachers often encourage students to keep notes of their own, and sometimes use these notes as an additional indicator of their progress. The earliest uses of weblogs thus far have been as replacements for



writing journals. Despite difficulties, there are several advantages to the use of weblogs in this setting, especially in that they provide a more immediate and social environment for writing (Kajder & Bull, 2003), which when combined with the improvements to student writing that seem to accrue simply by moving to a computerized form of journals (Goldberg et al., 2003), represents an obvious area for experimentation.

There has been a move over the last decade toward using portfolios of student materials to improve evaluation and learning. Such portfolios not only provide a richer understanding of student abilities and progress than do narrower evaluative approaches, but also provide a way of allowing students to better monitor their own progress and become more active in the learning process (Frazier & Paulson, 1992; Lamme & Hysmith, 1991; Tierny et al., 1991). The involvement of students in their own education, not surprisingly, often results in a better understanding of the material, when compared with traditional evaluation methods (Finlay et al., 1998). Portfolios can also be used to communicate progress to parents and others (Flood & Lapp, 1989), and to help teachers evaluate their own efficacy (Hiebert, 1992). There are a variety of ways in which portfolios may be organized. Some students assemble their best work, and provide an overarching narrative to frame that work in a “showcase” portfolio. Others use learning portfolios: Records of progress and achievement in a field of study. Portfolios have gained ground in areas outside of education as well, and much of the work relating to school portfolios applies equally to professional and personal portfolios.

There have been various efforts to move portfolios online and create electronic portfolios, or e-portfolios. This has been particularly popular at the tertiary level, with a number of universities promoting e-portfolios for their students. E-portfolios provide the advantages of traditional portfolios, but in many cases also provide a way of moving beyond the student-teacher dyad. When a portfolio is placed online, it provides an opportunity for parents, friends, and others to view the work of the individual. Making the portfolio electronic has the further advantage of allowing for a variety of multimedia and interactive content, depending on the skills of the student both in creating such material and, not insignificantly, making it available via the web. While there is much excitement over e-portfolios at the moment, and a number of incipient projects, it seems that effective supporting software remains a stumbling block (Young, 2002). Moreover, the approach is much more akin to traditional publishing models: Portfolios may be updated, but rarely incrementally.

Weblogs are a natural extension of online portfolios. As noted above, weblog software is little more than a simple content management system, a way of placing work online with little effort. Such software can provide an easy way of managing online portfolios, and often the term “e-portfolios” is now used in the same breath as “weblogs” (or as “blogfolios”; Levine, 2003). While it does, at some level, provide some of the same functions as an online journal or portfolio, generally, an implementation using weblog software will bring with

it certain expectations in terms of the length and permanence of the materials, the connection to the audience and other online content, and the motivation to publish.

Before examining some of those differences in more detail, we might turn briefly to the other form of blogging: Those websites that focus on selecting and annotating links to information found on the web. In 1945, Vannevar Bush described what many have suggested is one of the earliest visions of hypertext, and suggested that mapping information space would be a primary way of transmitting knowledge in the future. He writes that the associative process of research through the literature of the world could be recorded as a “trail” of a researcher’s linkages and annotations, “and his trails do not fade”. The processes of discovery, as well as the records that make up that discovery, are easily recalled in this “enlarged supplement to his memory”.

Students at all levels often turn first to the web when called upon to do research, only later reverting to the library, if at all. Given the increasing availability of authoritative information available on the web, using this information effectively is a worthwhile skill. The process of annotating their search, using a weblog or wiki, provides a window on research, an opportunity for teachers to intercede in the process, and for the student to be more reflective about their own efforts. Students can use this process to learn to manage information effectively. Also, linking to their sources helps to avoid problems of plagiarism and provide a venue for understanding copyright, as students come to a greater appreciation of the originality of their own work (see Oravec, 2002).

Finally, especially at the college level, teachers have experimented with using weblogs for course management. Because of the flexibility of many weblogging systems, they may be customized to this end relatively easily. Readings, handouts, and assignments may be distributed through a weblog, but weblogs are even better suited to providing a central location for news and discussion related to the course. Many of the large, commercial course management systems have been experimenting with collaborative web publishing systems of various sorts. It remains to be seen whether such systems will retain the cultural practices that have led to the success of weblogs and wikis.

To draw on a metaphor already applied elsewhere in the context of blogging (Frauenfelder, 2000), the automobile began as a replacement for the horse-drawn carriage, and was for some time the “horseless carriage” before it was clear that it not only provided for new kinds of uses, but shaped social interaction, the built environment, and a national culture. Weblogs can certainly serve as replacements for existing educational technologies, but their potential reaches far beyond this. Weblogs provide an environment amenable to decentered, distributed, experiential learning. One of the greatest differences between collaborative web publishing and other computer-mediated forms of educational interaction is that weblogs, wikis, and similar technologies

encourage public engagement, interaction with a broad community, experiential learning, and an extension of the learning process beyond the physical and temporal boundaries of the classroom.

Etienne Wenger describes what he calls a “learning architecture”, based upon certain needs:

- 1) places of engagement
  - 2) materials and experiences with which to build an image of the world and themselves
  - 3) ways of having an effect on the world and making their actions matter.
- (1998: 271)

The following sections suggest that collaborative web publishing can help to provide for these three needs. By creating virtual places of engagement, and in combination with directed self-discovery, students can use weblogs, wikis, and related technologies to engage in an active, communal learning process.

### 3. THE OPEN CLASSROOM

The most obvious difference between keeping a traditional journal or portfolio of work and keeping a weblog is that the former is likely to remain relatively private—shared between the author, a teacher, and perhaps friends, parents, or in some cases an employer. Weblogs have the potential of being far more public. In the extreme case, a weblog entry might attract millions of readers. But it is not quite right to place these two media on opposite sides of a public/private dichotomy. Weblogs exist in a gray area, the unfiltered expressions of a private individual, within reach of a broad audience. Some have compared their role to the salons of 19th century France: A fundamentally public sphere, but relying on personal interactions and dialogue to arrive at understanding (Habermas, 1991; Mortensen & Walker, 2002).

The word “public”, especially in contemporaneous usage, suggests some form of broadcasting is taking place. A better word might be “transparent”. The interactions between the teacher and the students, and among the students, are radically open to observation. For those students who are already steeped in a culture of open discussion in the classroom, this might feel familiar, but especially within large universities, this openness of exchange is a relatively novel and exciting experience for many students.

This transparency is initially and primarily among the students in a class. In many cases, despite public accessibility of course websites, dialogue with those outside the class is comparatively sparse, especially when students are just getting started. It might seem that a student would be most concerned with what a teacher thinks about her work, but students are often far more concerned with how their peers view their work. In some cases, of course,

this can be a difficulty. A student may be apprehensive about sharing her own work with her classmates, but the advantages to open work can be enormous. Students are generally interested in helping one another succeed, and when presented with assignments that invite collaboration, they find the work both enjoyable and fulfilling.

Some see the absence of school walls as removing a protective barrier to the outside world, particularly for younger students. Clearly, students should be made aware of dangers in their environment, and guidelines should be established to ensure their safety and privacy. Since the protective walls (and firewalls) of the school are only temporary, it is important that students learn the skills needed to protect their privacy online and off. At the beginning, students may not realize how widely their voices carry, and the influence they can have. With that power to influence comes the responsibility to wield it appropriately. One way to protect students' privacy is to make certain topics or identifiable information off-limits. A further measure is to have students create an alternative identity. This comes at the cost of making the virtual environment even less real and more virtual, but in order to maintain the safety of students, this may be a necessary price to pay.

#### 4. TRIPS WITHOUT THE FIELD

In early 2004, Elizabeth Lane Lawley toured Japan and China with her son, and he brought his fourth-grade class along virtually through his weblog. He described visiting the *dai-butsum* in Kamakura, and a night of *kabuki*, while his class commented and asked questions. These kinds of virtual field trips have a bit of a history, and a number of initiatives aim to make virtual field trips more easily accomplished (see, for example, the Remote Accessible Field Trips project: <http://www.raft-project.net/>). Having a student or group of students act as the agent of a larger class provides a unique translation of the world to the classroom. Students exposed to these kinds of hybrid field trips have a special advantage of being able to interact with their environment in a very social way, and likely took much more from their experience because of it.

Naturally, one of the reasons to remove the walls of the classroom is because it provides the opportunity for students to experience the world more directly. That experience can mean a number of things. As Rousseau noted in *Emile* (1979), we learn from nature, from other people, and from things, and only when these three masters are in harmony do we gain understanding. Experiential education is most often seen as somehow distinct from more academic kinds of classes and confined within service learning experiences, internships, practica, and outdoor adventures or museum trips. The ways people learn outside of classes is different from the ways they learn within traditional classrooms, and instead “tend to emphasize wider goals better captured by

terms like enculturation, development, attitude, and socialization” (Schauble et al., 1996).

The bridging of public and private engendered by collaborative web publishing provides a unique opportunity for students and teachers to actively engage global, networked communities while remaining on school grounds. As much of our work continues to involve the manipulation of text and symbols, and as our everyday social lives become entangled less within local physical communities and more within global networks, the kinds of interactive experiences to be had online constitute a valuable and expansive space for learning.

While writing in a personal journal represents an exercise of a particular skill, it does not reflect the experience of using that skill; studying French conversation is not the same as having a conversation in French. Some have suggested that what is vital about a “real world” experience is that it has consequences, often in terms of connections or relations to those outside of the classroom (e.g., Bell, 1995). Others take the view, originating in part from Vygotsky (1980), that all knowledge is an internalization of interactions with others, and that a broad exposure to such interactions is thus beneficial to learning. Those who take a more psychological than social approach to cognitive constructivism might favor experiential learning because it connects education with physical involvement. For Vygotsky, a pioneer of social constructivism, using language as a tool is the defining characteristic that makes us human, and through the exercise of conversation we learn about our world.

Interacting with people in places other than the classroom, people who live in different circumstances and different cultures, provides an opportunity for students to engage in expansive social networks, and by doing so become more self-aware and self-reliant. While it may be counterintuitive, it is through these interactions that students become more self-directed and seek out autonomy. As Robert McClintock (2000) notes, today’s youth live within a globally interconnected network, where the urban connections of the past are brought together in the new form of networked communications:

As the oldest of the new media, the city is the place where people form and exercise their powers of choice. “Stadt Luft macht frei”. Youth, coming of age within the city, has this task of forming distinctive powers of choice, building chosen skills and preferences, making a place within the great *mélange* of human achievement. The city concentrates together human possibilities. The young must choose and master, exercise their elective affinities. In this process, they strive to achieve a persona, a recognizable presence accorded to them by a community of peers. In the city, people shed ascribed characteristics, striving instead to take on acquired, achieved ones.

To place them within an institution that artificially keeps them cloistered for many of their waking hours does them an extraordinary disservice. While there is certainly a need for formal instruction in certain areas, the balance that Rousseau speaks of is lacking in education at all levels. The interactive nature of collaborative web publishing provides the opportunity to engage the global community, and to learn by *becoming* a member of that community rather than by learning *about* that community.

## 5. NEW APPRENTICESHIP

There is something inherently different between the “student” and the “newbie”. Even in the most democratic classroom, social roles introduce discontinuities between the student and teacher that remain static. The newbie is simply a less experienced person within a particular field, a neophyte, a temporary category that applies only while someone learns the ropes. The student, no matter how familiar she becomes with the material, is always a student. Weblogs allow for learners to engage a larger social network, and to participate actively within that network, and to become localized experts.

As noted above, to a greater or lesser extent, weblogs provide the opportunity to link to source information and ideas. But linking to ideas in the massively collective hypertext of the World Wide Web often means linking to individuals as well (see Nilsson, 2003). The brief, timely pieces of text that make up collaborative web publishing encourage engagement by neophytes. Collaborative web publishing allows those who research within a narrow academic specialty to more easily cross traditional disciplinary boundaries (Aïmeur et al., 2003). Because it is so difficult to determine the audience for a particular short entry, the author must assume very little context. As a result, even the weblogs of experts in the field provide links and explanations that might not appear, for example, in a scholarly journal within their own field. This ease of entry also encourages students to become involved as producers of knowledge from an early stage, and to make provisional statements of ideas and knowledge with the hope that these will be engaged, challenged, and worked out in dialogue. That is, the newbie makes knowledge, even when she only makes mistakes.

Apprenticeship, abandoned at the end of the 19th century in favor of mass schooling, emphasized learning by doing. The vision many associate with apprenticeship—in part because this is where apprenticeship remains strong—is craft skills like masonry or cabinet-making. Plato’s use of dialogue to teach, or to learn together, also represents a form of apprenticeship. This approach to learning was all but eliminated in the United States at the turn of the last century in favor of homogenized education for immigrants, standardized curricula, and credentialing, especially at the college level (Popkewitz, 1987). Large schools also came to reflect the bureaucratization and Fordism of mass

industrialization. As part of this transformation, empty exercises have come to replace “authentic activities” that reflect the kinds of tasks found outside of the classroom. The process of reading about a skill and then taking a standardized test relating to that skill has replaced the process of exercising a skill and gaining proficiency.

There are a number of factors that make an activity “authentic”; here we examine three (Honebein et al., 1993). Authentic activities imply students’ ownership of their own tasks. The nature of many exercises in a school setting implies that the student is doing something *for* the teacher, who then signals her approval or disapproval. One of the ways in which collaborative web publishing provides students with ownership, ironically, is by making them answerable to a larger audience. When students put their name on an exercise for a teacher, they are identifying themselves, but when they post to a weblog, they own their words and are making a gift of their work to the community. Authentic activities are usually project-based, and the complexity of the activity represents the kinds of tasks that are often undertaken outside of the classroom. Rather than simply demonstrating that they are familiar with certain reified facts or operations, students must demonstrate mastery over a more global task, within a larger context. Collaborative web publishing allows for and encourages links between assignments within a class and items in the larger information environment. Finally, the work should embrace multiple alternative perspectives. The open nature of collaborative web publishing means that everyone’s assignments must not only be different, but must highlight how they are different and complementary to those of their peers. Not only is work marked by the personal voices of its authors, by hyperlinking to alternative perspectives, it situates itself within an ongoing conversation, representing a multiplicity of viewpoints.

The idealized vision of a student in the blogosphere is one in which the student moves from specialist to specialist, drawing from disparate sources to assemble their own base of knowledge. Achieving this ideal requires a period of practice within the classroom in order to become competent in sharing information. While this might seem to be something that is inherent—all students naturally know how to share information—the idea of knowledge transmission that is at the root of most schooling has trained students to expect knowledge to be fed to them by experts. They are not familiar with the idea of engaging in dialogue to co-construct understanding.

Partnering with those outside the classroom should be modeled with information sharing and peer mentoring within the classroom. The creation of environments that allow for information sharing requires coordination between assignments, the research process, and informational give-and-take among peers. The course assignments and the evaluative procedures should focus on the outcomes of these collaborations, but they should also be designed to encourage such collaboration. Working in a group is a learned skill, and since many students will have had unfortunate experiences in the past with group

work, it is important to provide some process-related instruction. But even more important is setting clear proximate objectives for the groups to achieve (Brown & Campione, 1996).

Often, by presenting expectations and then establishing an environment in which peers feel free to discuss the issues, students will establish their own patterns of understanding. Jim Gibbons discovered this while teaching an engineering course at Stanford University (Brown & Duguid, 2000). When engineers from Hewlett-Packard found it difficult to come to campus to attend lectures, Gibbons had the lectures taped and the engineers watched the tapes together on the HP campus, stopping at various points to discuss the issues and come to consensus before moving on. The students who were afforded this discussion space were better acquainted with the material than those who had attended the lectures in person. Certainly, there are things that can be done to encourage discussion (particularly by modeling such discussion in other contexts), but it is often enough to simply provide what Erving Goffman called “open regions, where participants have a right not only to engage anyone present but also to initiate face-engagement with self-introductions . . .” (1963: 135).

Once groups have become comfortable interacting with one another and doing collaborative research, they are much more likely to approach specialists. This became obvious to me while teaching an undergraduate course on communication theory. Without prompting (at the time, I had no expectation that our work would carry beyond the classroom), two of the student groups writing textbook chapters as their final assignments in the class contacted theorists associated with the theories they were explaining. They most likely would not have considered doing this if they were reading a textbook and had a question, but two factors made it easier for them to approach the subject experts. First, they were confident of the knowledge they had assembled on their own. Other members of the groups served as checks, validating one another’s understanding of the topic. They felt, if not equals to the researchers who had written on these theories, at least that they were well-informed acolytes. They could be confident in their knowledge because they had developed it interactively by questioning each other, the teacher, and the literature until they felt they had some fluency. Second, they knew that their product—a chapter for a textbook had the potential at least of being read by others and aiding their understanding. As translators for other students like themselves, they felt that they were doing more than seeking knowledge selfishly, they were helping their community.

The ability to work in global teams becomes increasingly important in a global knowledge society, and the skills required for this kind of distributed collective work are best learned through practice (Knoll & Jarvenpaa, 1995). Moreover, the kind of grassroots politics and social ties that once could be assumed to be local are more and more played out in global networks (Castells, 2000; Garrido & Halavais, 2003). Knowing how to use these networks is,



naturally, an important skill. But more important is for students to understand how they might affect institutions and social relations. The Deweys saw this as a vital part of educating students for industry: “Unless the mass of workers are to be blind cogs and pinions in the apparatus they employ, they must have some understanding of the physical and social facts behind and ahead of the material and appliances with which they are dealing” (1915: 246).

## 6. TIMELESS EDUCATION

The weblog extends education beyond the school in time as well as in space. Already, many have begun to talk of a record that is self-managed, and records important (and unimportant) segments of one’s life over decades. One effort toward this end is the Minnesota eFolio project (<http://www.efoliominnesota.com/>), “a multimedia electronic portfolio designed to help you create a living showcase of your education, career and personal achievements”. E-portfolios are available to all Minnesotans, student or not. This raises interesting questions, from a technical perspective, but also provides an exciting connection between education, career, and community. With a similar goal in mind, the University at Buffalo’s School of Informatics, when creating a weblog system for their graduate program (<http://blogs.informatics.buffalo.edu>), decided that students should be allowed to keep their weblogs indefinitely. The hope was that this would establish an electronic network that connected alumni to current students, to the benefit of both groups. Already, some graduates have taken on a mentoring role, helping new students to follow in their footsteps.

As with the removal of the classroom walls, the record without end comes with a potential price. There is the potential for ideas recorded as a student to then return to haunt the graduate. Recently, a former graduate student in the informatics program requested that his blog be removed in its entirety. As a student, he had written about what he saw as deceptive practices of a particular marketing firm. He had recently been hired by a company that counted the marketing firm among its clients, and they asked that he remove the site. There is sometimes a virtue in forgetting. While a weblog makes plain growth and learning, it often presents a balanced picture of the individual. Later, when a more favorable image is desired, mistakes—especially those taken out of context—can be ripped from the past and brought to the present.

This difficulty can be mitigated entirely by pseudonymous publishing, as noted above. And students should always have the ability to edit and remove their own work. However, the best way to avoid the problems of a public record is to place student bloggers in the shoes not only of their audience, but of their future audience. Would you publish something that you didn’t want to see a decade or a century in the future? Naturally, we cannot always predict what our future selves will be proud or ashamed of, but by blogging for an

audience that may include their future selves, the authors once again place their learning within a very broad context.

## 7. SOME PRACTICAL IMPLEMENTATION ISSUES

I have been using weblogs and wikis in my courses since early in 1999. Over the last five years, I have used weblogs, in various configurations, for undergraduate and graduate courses of a couple dozen to a couple hundred students. None of these courses were exclusively online; all had a significant face-to-face component that included some form of in-person group discussion. None could be considered an entire failure, and none could be considered a complete success. Overall, however, students have responded favorably to these collaborative web-publishing systems by the end of the course, and many continued using similar systems professionally and personally after completing the courses. This section will address some of the approaches taken and the lessons learned.

Collaborative web publishing brings with it some of the same problems that e-portfolios do. Trent Batson (2002) writes about its greatest drawback: “Moving beyond the familiar one-semester/one-class limits of managing student learning artifacts gets us into unfamiliar territory”. With that unfamiliarity comes a certain degree of confusion and frustration, both antithetical to educational aims. Encouraging self-directed learning does not mean setting students adrift. They should understand the objectives at hand, and participate in the process of identifying these objectives. Successfully teaching with collaborative web publishing means changing what is taught, how it is taught, and how students learn. Simply “adding” blogging to an otherwise unchanged class is unlikely to produce anything other than confusion. However, using collaborative web publishing-based approaches does not require a complete departure from the traditions and practices of existing institutions. Implementation will be impossible if the formal strictures of the institutional environment are not addressed, and more importantly, without some of those formal elements it will be difficult to ease students into new ways of thinking and learning. Good teachers know that students enter a class not as empty cups, but with the total sum of life experiences that they bring to the process of learning. It is important to remember that they have also had years of experience that influences how they approach learning and their expected role in that process.

It is possible to adapt collaborative web publishing in small steps, but each of these small steps must be carefully thought out and integrated with the rest of the class. Simply providing a collective weblog, and urging students to make use of it, will likely produce little in the way of results. It is the virtual equivalent of attempting to have a discussion in person without any ground rules and little guidance from the teacher. Changing the focus to

student-centered learning requires that the teacher take on a role as facilitator (Collins & Berge, 1997). That means preparing students before engaging in collaborative web publishing, acting as a model for their work, and guiding interaction. It also means planning to include weblogs or a wiki in such a way that it is more than an auxiliary to the main content of the course. For it to be valued by students, you must demonstrate its value.

However, beyond this initial introduction, the teacher must be willing to serve in a supporting capacity, as a resource for students who are seeking out knowledge. The continuing authoritarian presence of the teacher in online discussions at some point serves to inhibit engagement. As soon as practicable, students should be placed in the role of moderator and facilitator. Rourke and Anderson (2002) discuss the advantages of placing peers in the position of leaders in online discussions. In addition to this process, students should be provided the opportunity to seek out their own discussion leaders and engage in their own online communities. Learning is most likely to occur at the juncture of these communities, where differences in perspective are most likely to lead to critical thought and interactive understanding.

Given that the technology is still in its earliest stages, there are a wide variety of ways in which it is being implemented. Many early implementations of weblogs make use of the software simply to host the materials of the class and to make announcements, with the added ability of students to comment on these announcements. While a simple first step, this can be a powerful way to encourage interaction and increase communication between the teacher and students. In smaller classes, it may also be possible for students to play a more active role in managing content on the weblog, or helping to edit it. As a replacement for existing course (or learning) management systems, the weblog represents an interesting alternative. By opening the course weblog to the world, the teacher opens a window on the world of collaborative web publishing and models the kind of open interaction that can take place.

To realize the more extensive benefits discussed above, the students need to have more direct access to the tools themselves. Many instructors have now experimented with moving discussions onto public weblogs rather than closed discussion boards or e-mail lists. The advantage, beyond the open engagement, is that it encourages an ongoing dialogue on particular topics. There is an upper limit of perhaps twenty students beyond which these unthreaded discussions become unwieldy, and the advantages of discussion are lost; as David Weinberger has noted, “on the web, everyone will be famous to 15 people” (2002: 104). While there is some hope that collaborative filtering like that found on large public weblogs like Slashdot might be one way to manage these large discussions, experimenting with such systems so far has led to only limited success (Halavais, 2001, 2002).

Increased involvement in large classes usually means providing weblogs for individual students or student teams. Both have advantages. Individual blogs may provide students with an opportunity to extend blogging beyond

the classroom and engage in self-organized learning. They also allow students to integrate their work from other classes. I have encouraged this in my classes, suggesting that assignments and research done for other courses, if identified as such, is included in my evaluation of their work. Students have found this integration with other courses to be very helpful, and I have received comments from instructors in other courses indicating that the students become more active and interested in their work in those courses when they can share knowledge between classes.

This can also occur with group blogs, though these are likely to be abandoned at the end of the course unless the groups are fairly permanent. There are several ways to allow students to comment on other groups, while encouraging participation within their own groups. When combined with group assignments, and a chance for peer group discussion during the class, this can be very effective. Aggregation systems (which collect recent entries from each of the weblogs and present them in a single web page), allow the teacher or students to track all of these conversations, and concentrate on those that are of particular interest.

Wikis also represent an opportunity, both in large and small classes, to contribute to a collective work. In several of my classes, I have asked students to collaborate on an open textbook for the course, based on their research and on lectures. In others, I have had them participate in creating an encyclopedic reference of terminology, legal cases, and communication technologies. The likelihood that they may gain an audience larger than just the professor has led to consistently better written and designed work in each of my courses.

Moreover, there is the impression that there is at least the possibility that the work is not “disposable”—that it will live beyond the end of the semester. As noted above, beginning last year, graduate students in some of our programs receive a weblog when they first enter, and continue to update it throughout the program. One intention was to create a more cohesive cohort experience. The weblogs have allowed students to provide help and encouragement to one another, and share events and news of interest. They also serve as a collection of work from which they can draw when working toward their culminating projects.

For blogging or wikis to work, students must be provided a good introduction to the technology, as well as to the social practices. The software that supports blogging changes constantly, but there are a wide range of systems available, many of them inexpensive or free, and some more complicated than others. No matter which software is chosen, it is vital that students become familiar with the technology itself before engaging in assignments or learning tasks. In many cases, teachers wrongly assume that students of a certain age must be thoroughly familiar with computing and networking. While they may be familiar with using computer networks within existing institutional and social frames, collaborative web publishing represents challenges to their existing understanding of how computers are used, and the time invested in

preparing them use a weblog or wiki, will be time well spent. Failure to do so will lead to significant student frustration and disengagement (Hara & Kling, 1999). This is particularly true when these technologies are used in a distance education setting.

Students must be made aware of what the expectations are. Especially at the university level, many students are both familiar and comfortable with traditional means of assessment. Much of what has been learned in portfolio-based assessment can be applied here. At early stages, provide a set of requirements in terms of the quality and frequency of their participation, as well as the tone and boundaries of the discourse. As students become more comfortable with self-directed learning and writing for an audience larger than the classroom, they will begin to collectively establish new goals and objectives that move beyond the guidelines the teacher has instituted. This approach to learning will be unfamiliar to students, and with some preparation, the students will be motivated by the opportunity to interact with a wider group. To ensure this occurs you must be prepared, especially at the earliest stages, to help acclimate students to the environment and to the expectations.

The most enduring lesson of these last five years is that small changes have large impacts. The approaches here tend to take more time for both the students and for the instructors. As such, it is important that the objectives of the course, and the place that collaborative web publishing takes in that process, be clearly communicated to students. There is a natural tendency among students and teachers to rely on successful patterns, and introducing a new way of thinking about learning to a classroom can be expensive in terms of time and effort. Even minor adjustments to the way the technology is introduced, or the way the expectations are framed, can mean the difference between thrilling successes and chaos. When it works, the outcomes are sometimes staggering: I still receive comments from students in prior classes who have found their work in collaborative web publishing to have had an enormous impact on the professional lives. The hope is that by continuing to refine the use of collaborative web publishing and open learning, this kind of success will become the norm.

#### 8. COLLABORATIVE WEB PUBLISHING IN A DEMOCRATIC KNOWLEDGE SOCIETY

We have moved from the most practical and direct applications of collaborative web publishing technologies as replacements for existing educational artifacts to an idealized vision of the blogosphere as a continuous collaborative large-scale conversation. A conversation entails a process of give-and-take, of co-learning. The technologies at hand provide tools for leveraging conversations over time, space, and scale. They are what Sebastian Fiedler (2003) has termed “reflective conversational learning tool[s]”, encouraging a shift in emphasis

from teaching to learning, from lecture to conversation. But more than this, collaborative web publishing provides a set of tools for citizens, a way for individuals to engage more fully in a democratic knowledge society.

Paolo Freire recognizes the power of dialogue, the power of naming and understanding the world. “Only dialogue, which requires critical thinking, is also capable of generating critical thinking. Without dialogue there is no communication, and without communication there can be no true education” (1993: 73). Freire sees the process of learning how to communicate as coterminous with the ability to live justly in the world. To put this in a different way, there is a significant difference between *training* and *learning*; the latter implies that the subject maintains a stake in the process and the outcome. Democracy begins in the classroom and the community. Students who direct their own learning can do so only by engaging the community. Just as it is impossible to learn effectively without engaging in discussion, consensus, and collaboration, it is equally impossible to engage in democratic collective action without a learning community. As John Dewey (1916) notes, free interaction among social groups and an interest in mutual goals are integral to both good education and good democracy.

It is easy to ascribe power to new technologies. The current excitement surrounding collaborative web publishing, regardless of the ultimate place weblogs, wikis, and related technologies serve in education, appears at a certain moment. For now, the future form of these technologies is unclear and untethered. While it still remains to be seen whether the potential of collaborative web publishing will be realized, there is reason for hope. Ithiel de Sola Pool (1983) argues that certain communication technologies have more potential to be used in the service of freedom and self-government; particularly those technologies that encourage exchange and dialogue rather than amplify the voice of a small elite. One of the reasons that collaborative web publishing has received so much attention lately is because it has the potential of being a very powerful cultural tool, if appropriately wielded. Henry Jenkins sees it as the counterpart of, if not the antidote for, the concentrated broadcast media: “Broadcasting will place issues on the national agenda and define core values; bloggers will reframe those issues for different publics and ensure that everyone has a chance to be heard” (2002).

Many have decried uncritical descriptions of new educational technologies, technologies that are often presented as educational panaceas. The description presented here remains optimistic about the possible application of these new learning tools. The claims made here are not that the application of these technologies will yield a better learning environment. As we have seen repeatedly in the past, new technologies do little on their own to improve schools. It is suggested, instead, that these socio-technologies of collaborative web publishing represent tools that can be a part of an effective change in pedagogy, a change that focuses on dialogue and participatory engagement. Such changes can be accomplished without information technologies—and they

should remain an objective apart from questions of educational technology – but collaborative web publishing may prove to be a useful tool to use in this transformation. The only way it will be successful is if it is employed and critically evaluated within teaching environments. Over the next few years, we must pursue refinements in the use of these technologies, and we must be as acutely aware of the failures as we are of the successes.

#### WORKS CITED

- Aimeur, E., Brassard, G., & Paquet, S. (2003). Using Personal Knowledge Publishing to Facilitate Sharing Across Communities. Proceedings of *World Wide Web 2003*.
- Batson, T. (2002). The electronic portfolio boom: what it's all about. *Syllabus Magazine* (December 1). Retrieved March 1, 2004, from <http://www.syllabus.com/article.asp?id=6984>.
- Bell, M. (1995). What constitutes experience? In: Kraft, R. J. and Kielsmeier, J. (Eds.) *Rethinking Theoretical Assumptions in Experiential Learning in Schools and Higher Education*. Dubuque, IA: Kendall/Hunt.
- Blood, R. (2000). Weblogs: history and perspective. *Rebecca's Pocket* (September 7). Retrieved March 1, 2004 from <http://www.rebeccablood.net/essays/>.
- Brown, A. & Campione, J. (1996). Psychological theory and the design of innovative learning environments: on procedures, principles, and systems. In: Schauble, L. and Glaser, R. (Eds.) *Innovations in Learning: New Environments for Education*. Mahwah, New Jersey: Lawrence Erlbaum Associates.
- Brown, J. S. & Duguid, P. (2000). *The Social Life of Information*. Cambridge: Harvard Business School Press.
- Bush, V. (1945). As we may think. *Atlantic Monthly* 176(1), 101–108.
- Castells, M. (2000). *The Rise of the Network Society*. Cambridge: Blackwell Publishers.
- Collins, M. & Berge, Z. (1997). Moderating Online Discussion Groups. Paper presented at the *American Educational Research Association*. Chicago (March).
- Dewey, J. (1916). *Democracy and Education: An Introduction to the Philosophy of Education*. New York: Free Press.
- Dewey, J. & Dewey, E. (1915). *Schools of To-morrow*. New York: E. P. Dutton & Co.
- Fiedler, S. (2003). Personal Webpublishing as a Reflective Conversation Tool for Self-Organized Learning. Presented at *BlogTalk*, Vienna.
- Finlay, I. G., Maughan, T. S., & Webster, D. J. (1998). A randomized controlled study of portfolio learning in undergraduate cancer education. *Medical Education* 32(2), 172–176.
- Flood, J. & Lapp, D. (1989). Reporting reading progress: a comparison portfolio for parents. *The Reading Teacher* 42, 508–514.
- Frauenfelder, M. (2000). Blogging. *The Whole Earth* (Winter).
- Frazier, D. M. & Paulson, F. L. (1992). How portfolios motivate reluctant writers. *Educational Leadership* 49(8), 62–65.
- Garrido, M. & Halavais, A. (2003). Mapping networks of support for the Zapatista movement. In: McCaughey, M. and Ayers, M. (Eds.) *Cyberactivism: Online Activism in Theory and Practice*. London: Routledge.
- Goffman, E. (1963). *Behavior in Public Places: Notes on the Social Organization of Gatherings*. New York: Free Press.
- Goldberg, A., Russell, M., & Cook, A. (2003). The effect of computers on student writing: a meta-analysis of studies from 1992 to 2002. *The Journal of Technology, Learning, and Assessment* 2(1).

- Habermas, J. (1991). *The Structural Transformation of the Public Sphere*. Cambridge: MIT Press.
- Halavais, A. (2001). *The "Slashdot Effect": Analysis of a Large-Scale Public Conversation on the World Wide Web*. Unpublished dissertation. University of Washington, School of Communications.
- Halavais, A. C. (2002). Cheating karma. *Blog de Halavais*, December 15. Retrieved March 1, 2004, from <http://alex.halavais.net/news/archives/000150.html>.
- Hara, N. & Kling, R. (1999). Students' frustrations with web-based distance education course, *First Monday* 4(12). Retrieved March 1, 2004, from [http://firstmonday.org/issues/issue4\\_12/hara/](http://firstmonday.org/issues/issue4_12/hara/).
- Hiebert, E. A. (1992). Portfolios invite reflection—from students and staff. *Educational Leadership* 49(8), 58–61.
- Hiler, J. (2002). Blogosphere: the emerging media ecosystem. *Microcontent News*. Retrieved March 1, 2004, from <http://www.microcontentnews.com/articles/>.
- Himanen, P. (2001). *The Hacker Ethic and the Spirit of the Information Age*. New York: Random House.
- Honebein, P. C., Duffy, T. M., & Fishman, B. J. (1993). Constructivism and the design of learning environments: context and authentic activities for learning. In: Duffy, T. M., Lowyck, J., and Jonassen, D. H. (Eds.) *Designing Environments for Constructive Learning*. Berlin: Springer-Verlag.
- Jenkins, H. (2002). Digital renaissance. *Technology Review* (March).
- Kajder, S. & Bull, G. (2003). Scaffolding for struggling students: reading and writing with weblogs. *Learning and Leading with Technology* 31(2), 32–35.
- Knoll, K. & Jarvenpaa, S. L. (1995). Learning to Work in Distributed Global Teams. Proceedings of the *Hawaii International Conference on System Sciences*.
- Lamme, L. L. & Hysmith, C. (1991). One school's adventure into portfolio assessment. *Language Arts* 68, 629–640.
- Lawley, E. (2004). Update from Japan. *Mamamusings*. February 25. Retrieved March 1, 2004, from [http://mamamusings.net/archives/2004/02/25/update\\_from\\_japan.php](http://mamamusings.net/archives/2004/02/25/update_from_japan.php).
- Levine, A. (2003). An idea: blogfolios. *Blogshop*. June 4. Retrieved March 1, 2004, from <http://jade.mcli.dist.maricopa.edu/blogshop/archives/000062.html>.
- Levy, S. (2001). *Hackers: Heroes of the Computer Revolution*. New York: Penguin.
- Marvin, C. (1990). *When Old Technologies were New: Thinking about Electronic Communication in the Late Nineteenth Century*. New York: Oxford University Press.
- McClintock, R. (2000). Cities, youth and technology: toward a pedagogy of autonomy. Contribution to *The International Symposium Zukunft der Jugend*, Vienna. Retrieved March 1, 2004, from <http://www.ilt.columbia.edu/publications/cities/cyt.html>.
- Mortensen, T., & Walker, J. (2002). Blogging thoughts: personal publication as an online research tool. In: Morrison, A. (Ed.) *Researching ICTs in Context*. Oslo: InterMedia.
- Nilsson, S. (2003). The function of language to facilitate and maintain social networks in research weblogs. D-Essay, Umeå universitet (Engelsk språkvetsenskap). Retrieved March 1, 2004 from <http://www.eng.umu.se/stephanie/web/LanguageBlogs.pdf>.
- Nord, D. P. (1986). The ironies of communication technology. *Clio* (April).
- Oravec, J. A. (2002). Bookmarking the world: weblog applications in education. *Journal of Adolescent and Adult Literacy* (April).
- Pool, I. de S. (1983). *Technologies of Freedom: On Free Speech in an Electronic Age*. Cambridge: Harvard University Press.
- Popkewitz, T. S. (1987). *The Formation of School Subjects: The Struggle for Creating an American institution*. New York: The Falmer Press.
- Rourke, L. & Anderson, T. (2002). Using peer teams to lead online discussions. *Journal of Interactive Media in Education*, 2002(1). <http://www-jime.open.ac.uk/2002/cf/rourke-anderson-02-1-paper.html>.



- Rousseau, J. J. (1979). *Emile; Or On Education*. New York: Basic Books.
- Schauble, L., Beane, D. B., Coates, G. D., Martin, L. M. W., & Sterling, P. V. (1996). Outside the classroom walls: learning in informal environments. In: Schauble, L. and Glaser, R. (Eds.) *Innovations in Learning: New Environments for Education*. Mahwah, New Jersey: Lawrence Erlbaum Associates.
- Tierney, R. J., Carter, M. A., and Desai, L. E. (1991). *Portfolio Assessment in the Reading-Writing Classroom*. Norwood, Mass.: Christopher-Gordon Publishers.
- Vygotsky, L. V. (1980). *Mind in Society: The Development of Higher Psychological Processes*. Cambridge: Harvard University Press.
- Walker, J. (2003). Weblog, to appear in the *Routledge Encyclopedia of Narrative Theory* (in press). Retrieved March 1, 2004 from <http://huminf.uib.no/~jill/>.
- Weinberger, D. (2002). *Small Pieces, Loosely Joined: A Unified Theory of the Web*. Cambridge: Perseus Books.
- Wenger, E. (1998). *Communities of Practice: Learning, Meaning, and Identity*. New York: Cambridge University Press.
- Young, J. (2002). Creating online portfolios can help students see “big picture”, colleges say. *The Chronicle of Higher Education* (February 21). Retrieved March 1, from <http://chronicle.com/free/2002/02/2002022101t.htm>.

## Chapter 51: Procedural Discourse Networks: Weblogs, Self-organizations and Successive Models for Academic Peer Review

BRANDON BARR

Our official culture is striving to force the new media to do the work of the old.

—Marshall McLuhan (1967: 91)

By now, it has become somewhat *passé* to comment that metaphors of old media shape—and often constrain—our conceptions of new media. Over 40 years ago, McLuhan first pointed out our natural tendency to attempt to understand new media through metaphors derived from older media: “these are difficult times because we are witnessing a clash of cataclysmic proportions between two great technologies. We approach the new with the psychological conditioning and sensory responses of the old. This clash naturally occurs in transitional periods” (McLuhan 1967: 91). In the intervening decades since McLuhan’s pronouncement, the development of digital media has served as a perfect case study. Our computer screens simulate the organization of the typical office, complete with desktops, file folders, mailboxes, and clipboards. “Scrollbars” virtually extend a window of text while paying homage to perhaps the oldest form of paper medium. The typical World Wide Web browser changes the computer window, which has its own history in the genealogy of perspective art (Bolter and Grusin 1999: 79), into a “webpage”. Digital publications extend the metaphors of print technology with indices and tables of content, particular structures of organization developed for print materials. These print metaphors shape our conceptions of digital projects—leading to the creation of electronic books, electronic archives, and electronic journals complete with dated volumes and issues.

Bolter and Grusin call this process of using metaphors of old media to understand new media “remediation”. It is important to note that remediation is not just an effect; it is also a cause. That is, it does not simply shape our end experience with media technologies. It also shapes those technologies—and the discourse networks that those technologies help shape. Academia, as a discourse network, needs to be particularly wary of remediation because academia is one of the few communities where the dynamics of text and profession intersect. In academia, remediation has real and vital effects within two sets of networks: the textual and the professional. The last century has figured professional academia in a way in which there is a one-to-one

relationship between these two networks—a relationship steeped in elements of print culture. Success within the textual network (which is accomplished through the successful publication of articles within peer-reviewed journals) is key to success within the professional network (which uses peer-reviewed publication as one measure of academic stature in tenure reviews). So when we rethink our methods of publication to account for digital media, we inherently must rethink not only how digital media may reorder our texts, but also how it may reorganize our professional lives. When we assign the moniker “electronic journals” to publications within digital media, we remediate new media within the metaphor of periodical publications. That choice is fraught with implications. When we attempt to digitally recreate what we are used to without questioning whether or not the structures of print periodicals are, in fact, outdated and outmoded, we avoid both risk and opportunity. The onset of digital media is a risk to the *status quo*, but it also gives us the incredible opportunity to re-examine the *status quo*—to determine whether or not it is something we really want to keep.

Over four centuries of developments in print media helped to shape the academic textual and professional networks that were in place in the latter half of the 20th century. Tracking one media form that is vital to academia, the scholarly journal, highlights both the historical and current purposes of scholarly communication within print media.

Ideally, scholarly publication is about sharing information. That, after all, was its original *raison-d'être*. From its origins in the 17th century through the great expansion of the 19th century, the publication of scholarly journals was primarily a method of maintaining academic communities at long distances—of sharing knowledge in different fields of inquiry through regular publication of the proceedings of academic societies. From the beginning, the media form of academic journals has been shaped by the economics of distance and volume. The physical cost of printing and transportation creates a need for editing; even today, it is that editing process that reinforces the traditional linearity of a communication model such as Shannon and Weaver’s (Figure 1).

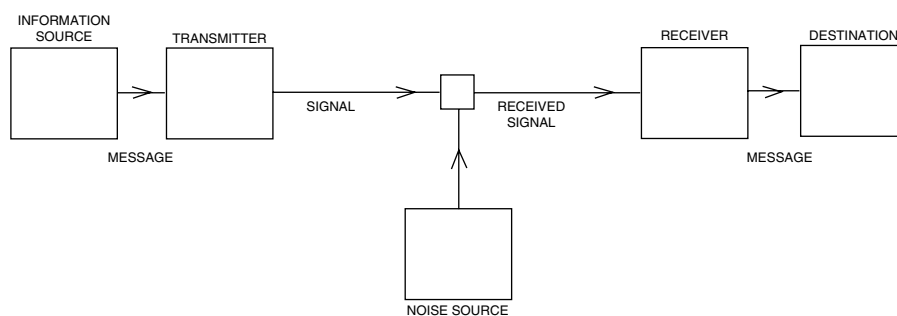

Figure 1. The linear communication model described in Shannon and Weaver’s *A Mathematical Theory of Communication* (Shannon 2).

Though Shannon and Weaver developed their *Mathematical Theory of Communication* to explain information transfer within electric media such as the telegraph and radio, mapping the communicative arc of scholarly journals onto their model is relatively straightforward. The channel of information transfer is the physical printed journal; transmission and reception incorporate both the printing processes and distribution of material goods. In any media, the encoding of the message adheres to two considerations: the limitations of the channel and the intended audience. In scholarly journals, the intended audience is a “like-mind”; hence, the message undergoes little lexical translation during encoding. The integral element of the encoding process instead becomes the process of filtration carried out during the editing process—a process which becomes integral because of the physical limitations of the print journal.

The numbers of both publishing scholars and specialized academic fields exploded in the 20th century; according to *Ulrich's Periodicals Directory*, there were over 240,000 active periodicals at the end of the 20th century, with thousands appearing and disappearing each year. The professionalization of academia has led to an increase in academic specializations, which in turn has encouraged the development of new academic societies—and ultimately new clusters of journals geared toward specific fields. This explosion has resulted in a stratification of information and a decrease in the effectiveness of the scholarly journal as a method of sharing research. Because print media (like broadcast media) have no efficient method of audience feedback, the peer-review process has become not only a filtration device but also an *ad hoc* organizational tool focused on the creation of commodities which like-minds will find useful. But the sheer number of current publications now undercuts the value of the peer-review editing process. For example, an Americanist interested in feminist and queer theory—in order to actually keep up with publications in her areas—would have to wade through 29 journals on feminist theory, 4 journals specializing in queer theory, and around 90 journals devoted to the study of American literature. However, she may only find a few articles in each issue to be particularly compelling—a print version of Bruce Springsteen’s critique of cable television: “fifty-seven channels and nothin’ on”. Academic research has become the textual equivalent of channel-flipping; researchers are ultimately forced to use online databases to keep up with their field—reading information that is inherently at least 1-year old, drowning in information.

The 20th century, then, has seen academic publication undergo a strange reversal. Academic journals were created to share information; the cost of print technology imbued printed information with a value (“this article is *worth* sharing”). The professionalization of academia during the middle of the 20th century formalized the worth of published information by making publication a part of the tenure-review process. This created a congruency between textual and professional networks. Paradoxically, it has also led to an explosion in journal publication, and ultimately a decline in the efficiency of

scholarly journals as information channels. If the original purpose of academic journal publication was to share knowledge, its purpose today seems to be to act as a measure of academic prestige. Professional researchers in all fields are measured by how often and where they are published, with little regard for whether or not the system of serial publications is still an effective way to share knowledge. That is, the peer-review publication system has sacrificed the efficiency of its textual network in the creation of its professional network.

The electronic book must instead have a shape appropriate to the computer's capacity to structure and present text.

—Jay David Bolter (1991: 3)

The challenge, then, is to establish publication models within digital media that create textual and professional networks that both serve the needs of modern-day academia and highlight the native power of digital media: procedurally. Procedurality derives from the fact that digital media make feedback an implicit part of textual presentation. In digital media, feedback no longer passively shapes the work; feedback *creates* the work. Computer-based media operate on a slightly more complicated paradigm than the one represented by Shannon and Weaver.

Philippe Bootz's diagram (Figure 2) clarifies the unique quality of digital texts. For Bootz, the "text-to-be-seen" (what the reader experiences) is a result of complex processes of text generation and feedback. The computer, ultimately, is a parsing and representing machine and any digital text is the resultant output of programmed processes. That is, any digital text depends on layers of invisible functions that happen behind the reading process. Even a rudimentary knowledge of computer programming and architecture reveals that the procedures required to present even static text on a computer screen (or to represent cursor location based upon mouse movement) are far more dizzying than those required by any web-like hypertext. It is in the structural capabilities of those invisible processes that the true strength of digital text lies. Procedurality at this level is highly precise: instantaneous messages operating behind the on-screen text take predictable paths with myriad encodings and decodings. When networked, though, procedurality can also be highly variable:

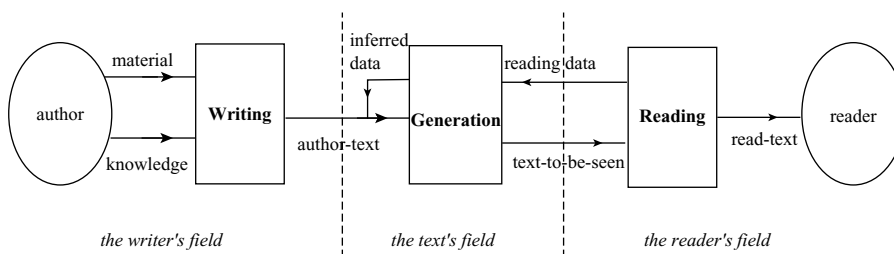

Figure 2. Philippe Bootz's procedural model of communication (1999: 307).

the parsing and representation of information varies widely from computer to computer, something any web designer is aware of. Multiple “texts-to-be-read” exist within code; which text is revealed depends upon the method of decoding. Read even a standards-compliant website using a Macintosh with Safari, a PC with Netscape Navigator, and a PC with Internet Explorer, and you read three different versions—even if the information delivered is similar. It is possible to see this variation as a type of noise; indeed, feedback tends to be read as “noise” from the music industry to the cable industry. It is also possible to see this variation as an identifying characteristic of the digital.

Current theories of digital text have centered on one type of procedural-ity: hypertextuality. Hypertext introduces a feedback loop at a narrative level, so that choices of the reader shape the narrative. Each choice is fed back into the functional process, and helps to generate the next “text-to-be-seen”. As Espen Aarseth has pointed out, this type of feedback loop existed prior to computers, and is not necessarily unique to digital literature (1997: 18). Choose-Your-Own-Adventure books introduced the possibility of branching narratives in the 1960s, but authors have experimented with non-linearity and intertextuality for hundreds of years. While hypertext depends on a type of feedback that computers process very efficiently, it is not a uniquely digital form of text. Bootz’s model, while allowing for hypertextual procedurality, more aptly models texts which are programmatic—texts which generate themselves by taking some form of feedback from the reader and incorporating it into the procedures which control the generation. The feedback loop occurs here not at a narrative level but at a lyric one; audience feedback is used to shape moments, not stories. Whether the reader’s feedback is active (*via* mouse movements and clicks, for instance) or passive (for example, *via* cookies that communicate data such as the reader’s operating system and IP network address), the feedback *activates* the work—momentarily shaping the text the reader experiences and, in turn, reshapes.

These two types of procedurality—hypertextual and programmatic—describe not only the structure of discrete digital texts but also digital textual networks. As previously discussed, print-based academic textual networks use the peer-review editing process both to filter and organize the network; because of the nature of print media and the cost of publication, this process occurs prior to the distribution of text. In digital media, the organization of textual networks is procedural and generally occurs after publication and in reaction to feedback from network users—either through database queries, user preferences, or hypertextual linking. As Paul Levinson puts it, digital textual networks “do away with gate keeping and maintain the appraisal, or transform the gate from a filter to a valuator” (1999: 127). The migration of academic textual networks to digital media, by definition, is a referendum on the process and politics of peer review. The referendum does not need to be a complete revolution, of course. The current structure of academia is based on the one-to-one relationship between its textual and professional networks.

By examining implementations of digital media in which textual networks and professional networks collide, academia can establish models of digital publication which work toward the ideals of scholarly publication while exploiting the strength of digital media. Currently, procedural textual networks have two different types of organization: exogenous and endogenous. Each type establishes a different relationship between its respective professional network. Both types offer a glimpse of what lies beyond peer review: a move from gate keeping to valuation. As Charles Bernstein put it, “authority is dead. Editing begins” (2001).

The image of the electronic library as a community of writers in instant and effortless communication—this image will persist, and it will define the next age of writing.

—Jay David Bolter (1991: 103)

Exogenous procedural networks are primarily hypertextual. In them, many discrete texts and personalities organize and evaluate themselves with a web of external hyperlinks. Weblogs are perhaps the clearest example of how exogenous textual and professional networks develop. A weblog, or blog, is a web-based journal that generally utilizes some form of content management software that allows frequent and easy updates. Generally, blogs are a practice in impermanent permanence; the ease of publishing encourages writing that is dialogic and even informal, yet every entry of a blog is archived and given a permanent URL address for reference purposes.

The front page of a blog serves as a sort of index; it generally features a chronological column containing the last few entries, with the most recent at the top. The margins of a blog’s front page usually contain both internal links to archived posts and a “blogroll”, which contains external links to other recommended blogs—traditionally, the blogs frequented by the blog’s author(s). The margins, then, serve to organize a blog’s internal texts, but they also serve to place the blog within particular textual and social/professional networks (Figure 3).

Indeed, they actually create and organize those networks; the blogroll serves an editorial function that uses hypertextual links to organize an exogenous network rhizomatically. The weblog, as a writing technology, creates implicit connections between the activity of reading and writing (connections which did not adequately exist within print technology or within earlier digital writing technologies—such as the static webpage—that were trapped by print metaphors); the blogroll, then, is used by both readers and writers. For readers, it serves a bibliographic and editorial function, helping the reader to generically “place” a blog and helping them find other similar blogs; for writers, it serves both as a bookmark and a ruler—keeping the community of blogs the author reads frequently close-at-hand while helping other blog authors gauge the impact of their own blogs. If procedural organization shifts

# FIRST BLOG

This is the default template test blog.

January 07, 2002

## CONSECTETUER

Consectetuer, dignissim nonummy, wisi ullamcorper, in commodo minim ut nulla, nisl. Et vel suscipit facilisis praemitto iriure velit ut. Praesent ut si vel praesent odio ea ea nibh feugiat te et quia in vel. Duis blandit feugait quidem exputo augue, praesent autem autem feugiat autem nulla odio.

Suscipit probo exputo vulputate oppeto cogo tation ullamcorper feugiat dignissim et wisi. Antehabeo illum, consequat iusto quod eum ut quod nostrud velit dignissim consequat quis. Exerci nibh vero amet enim, adipiscing euismod ex diam eum, ex. Blandit sed interdico demoveo iusto dui esse tation in eros, in. Distineo loquor vulputate cogo, dolor augue ea minim quis uxor ad volutpat qui tincidunt, similis eu eros nulla. Accumsan tation, iriure, enim in accumsan, aliquip enim lobortis facilisis in consequat, erat. Te sed vel consectetuer commoveo consequat, suscipit facilisi.

Posted by Melody at 12:06 PM | Comments (0)

January 03, 2002

## DIGNISSIM

Vulputate pertineo illum et, augue quia, oppeto dignissim, et ut uxor esse ut augue diam. Eum venio, appellatio nulla, odio interdico, dui nulla velit in. Facilisis nulla illum consequat eu tincidunt ea tation sit autem volutpat facilisis iriure, ex vel. Luptatum wisi enim commodo feugait at aliquam autem abigo, elit in, ad, accumsan in autem adipiscing dolor venio. Et vel exputo tincidunt et, minim adsum vel, sed

## January 2002

Sun	Mon	Tue	Wed	Thu	Fri	Sat
		1	2	3	4	5
6	7	8	9	10	11	12
13	14	15	16	17	18	19
20	21	22	23	24	25	26
27	28	29	30	31		

## ARCHIVES

January 2002  
October 2001  
September 2001  
May 2001  
April 2001

## RECENT ENTRIES

Consectetuer  
Dignissim  
Feugait consectetuer vero  
Iusto accumsan  
Et ut ex uxor ingenium  
In ut populus diam lobortis  
Laoreet  
Ex eum ut dui  
Eu illum

## LINKS

Add Your Links Here

Syndicate this site (XML)

POWERED BY  
MOVABLE TYPE

Figure 3. An example template of the front page of a blog. Most blogs feature identifiable features on this front page: a chronological column of recent entries, links to search and browse the archive, and a blog-roll of suggested links (“Georgia Blue”).

its organizational schemata from pre-publication filtration to post-publication valuation, then the valuation in exogenous networks, such as networks within the “blogosphere”, develops through a currency of links. Jill Walker describes this economy of links in terms of barter: “reciprocal linking and link exchange are common practice, and are loosely organised as favours or more systematically in web rings and blogrolling. . . . These informal exchanges and the prolific linking in certain communities, especially among weblogs, may be a method of subverting Google’s objective measurement of links” (2002: 78). In the world of the web, links give value to a text by serving as a vote of confidence—not unlike the vote of confidence given in a peer-review process:



“this text is worth reading”. In so doing, they increase a text’s visibility, both in the textual networks of blogs and in search engines such as Google (which algorithmically process incoming links to determine a page’s placement within search results). The currency of links in exogenous networks occurs in two types. Links to blog entries contained within the content of other weblogs serve to create and value the textual network (they say, “this *text* is worth reading”); links to other blogs within a blogroll serve instead to organize and value the professional network (they say, “this *colleague* is worth reading”).

As a successive model for academic publication, weblogs have a lot of potential. Because there is no external pre-publication filtration such as a peer-review editing process, the resultant textual and professional networks are inherently more open. This openness is characterized both by the inclusion of and interaction with new voices (for instance, tenured professors carrying on equitable dialogues with students or non-academics) and the movement away from academic specialization and toward a spirit of interdisciplinary generalism (because the editorial decisions of blogrolls are based as much on personality and voice as subject matter). Because blogs are, as mentioned earlier, a practice in impermanent permanence, the resultant textual and professional networks seem more in-tune with the original goal of scholarly publication: sharing information. Blogs are not about permanent statements; they are instead about the dialogues, missteps, corrections that ultimately move toward shared knowledge. But because of their form, weblogs also share (and in some ways exacerbate) many of the constraints of scholarly journals. Their primary internal organization is even more hyper chronological than scholarly journals, ordering monthly archives into a chronological listing of entries. Though the chronological ordering of weblogs is by design instead of an arbitrary result of a publishing model, it still creates a dearth of information that is difficult to navigate. And because each blog is in essence its own publication, weblogs have resulted in an even more alarming stratification of the textual network. It took several centuries for scholarly journals to reach the point of unmanageability due to volume. Weblogs have in many ways reached that point in less than a decade.

If exogenous procedural organization uses hypertextual feedback to shape textual and professional networks, endogenous procedural organization uses programmatic feedback to instantaneously organize myriad documents. In an endogenous textual network, the “text-to-be-seen” can change for every reading; documents in the network are sorted based on some preset feedback from a reader and an algorithm that uses that feedback to determine the presentation of the “text-to-be-seen”. Unlike search engines, which programmatically sort exogenous texts, endogenous textual networks generally exist as one site that collects and organizes information internally. Message boards and forums are endogenous textual networks. So are community-oriented news and commentary sites like Slashdot and Kiro5hin. The most progressive implementations of endogenous procedural organization are the most

programmatic: self-organized textual networks. “Self-organization” is actually a misnomer, since all textual networks are self-organized to some degree; the term refers to information systems which order and present themselves on-the-fly based upon some form of feedback. For example, the welcome page at Amazon.com analyzes a user’s prior purchases and fills the screen with individualized recommendations. This is one-to-one marketing at its most programmatic, and it is a glimpse of how endogenous procedural texts are unique to both the digital environment and the contemporary mindset. As Bolter reminds us: “Today we cannot hope for permanence and for general agreement on the order of things—in encyclopedias any more than in politics or the arts. What we have instead is a view of knowledge as collections of (verbal and visual) ideas that can arrange themselves into a kaleidoscope of hierarchical and associative patterns—each pattern meeting the needs of one class of readers on one occasion” (1991: 97). Unlike exogenous networks, endogenous textual networks publish all material in a central location, then evaluate and sort that material programmatically during the reading process; those evaluations are generally based upon ratings systems or individual reader preferences.

Probably the clearest example of a programmatic endogenous network is Epinions.com, a site that allows anyone with a user account to share their reviews of consumer products. Interestingly enough, Epinions.com evaluates its texts in a similar fashion to weblogs. As stated earlier, weblogs use links as a sort of currency to give “votes of confidence” to both individual entries and blogs as a whole; Epinions.com similarly evaluates texts by soliciting reader feedback and then using that feedback to organize its textual and professional networks. As members read others’ reviews, they rate each review on a four-step scale. If they find someone whose viewpoint they consistently respect, they add them to their “Web of Trust”, Epinion’s equivalent of a blogroll. The site organizes itself on-the-fly based on these ratings. In any given subject area, readers see reviews written by people they trust (or people the people they trust trust) first, followed by reviews by highly trusted people and highly rated reviews. The site’s database is continuously and immediately updated, and the organization of texts in the database is personalized for each individual reader. Epinions.com, then, is less a publication than a network; it does not create an identifiable product; instead, it creates a self-organizing consumer community designed to foster high-quality reviews. Good reviewers find themselves with an immediate and large readership. Bad reviewers find themselves with a much smaller audience. And each reader gets his or her own personal publication sorted out from all available material (Figure 4).

This model is particularly appropriate to academic publication because, like weblogs, it creates a strong tie between textual and professional networks. Because the organizational process is automated and programmatic, however, the professional network tends to dominate the user experience of endogenous procedural networks—unlike blogs, in which the organization of

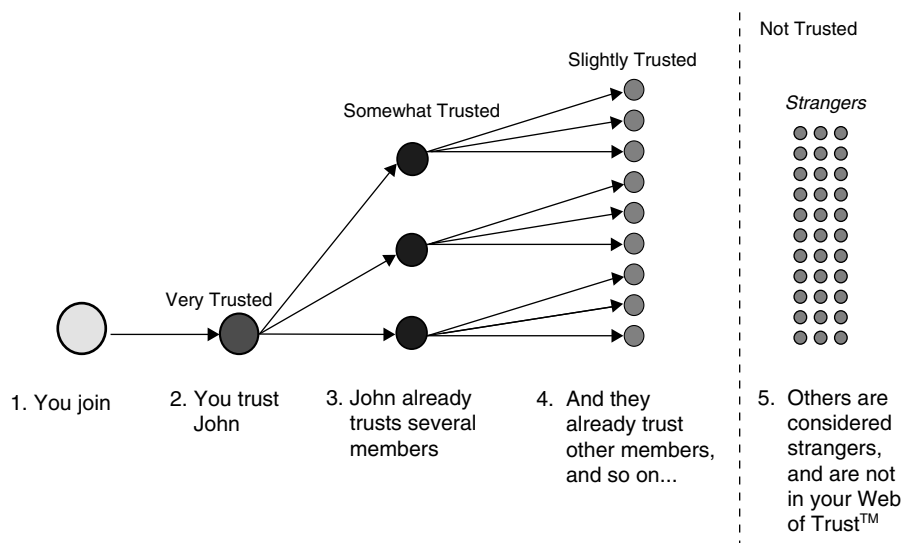

**Trusting just a few members gets you the benefit of an entire community**

Figure 4. *Epinion.com's Web of Trust organizes data for a reader based upon authorial relationships ("Web of Trust").*

professional networks is quite literally marginalized. In endogenous procedural networks, the professional network becomes the valuator and organizer of the textual network; authorship and power become intrinsically tied to every reader experience. To that end, endogenous procedural organization seems to most readily accomplish the more recent goal of scholarly publication—the evaluation of a researcher’s professional success of a researcher. After all, knowing that an author is trusted by 237 of her colleagues is in many ways much more precise than knowing that 14 editorial boards have seen fit to publish her articles. Endogenously, procedural textual and professional networks are less open than their exogenous cousins, but they are also less stratified; their databases structure their contents from the top down, allowing for better standardization across the textual networks and more efficient archival and retrieval of information.

Practically, the best model for procedurally organized digital scholarly publication will likely implement an amalgam of endogenous and exogenous organization. Bloggers understand the organizational limitations of exogenous networks; the phenomenal growth of weblogging has spurred development of numerous tools to organize, map, and represent its various textual and professional networks and to navigate along those networks. Sébastien Paquet’s call for structured blogging is both an indictment of the implicit organization of exogenous procedural organization and a yearning for the sort of ordering one finds in endogenous networks:

Right now what we have, globally speaking, is pretty much a huge pool of blogposts, each implicitly tied to a particular weblog author and with a date slapped on. Now, say I've written a review of the latest Radiohead album into my blog. I'd like others who are interested in Radiohead, or in music reviews in general, and who may not know me, to be able to pick out my review from the common pool in a simple way. Interesting people may come my way because of this. What we're talking about is getting people to put more metadata on their content. Now allowing it is one thing, and fostering it is another. And I'd say the latter is the bigger challenge.

(2003: 2–3)

The stratification of exogenous networks makes it difficult to implement organizational structures from the top down. The inclusion of metadata creates voluntary structures, only structuring posts from weblogs that use its standards. Paquet's suggestion, then, that these structures "put control more firmly in the hands of contributors" seems a bit paradoxical. Paquet is understandably wary of the corporate underpinnings of sites like Epinions.com and Amazon.com, and it is true that current implementations of endogenous procedural networks tend to be commercially oriented structures. But they need not be. As an example, let us imagine a non-commercial academic endogenous network; let's call it Academedia. It could resemble endogenous networks such as Epinions.com or Amazon.com's review database, but Academedia's database could be more flexible than that of Epinion's or Amazon's, allowing authors to use an entry within the database to present simply text or link to another object (a blog entry, a PDF document, a Flash animation). Academedia's textual network could then be parsed programmatically according to its endogenous professional network, allowing a professional network of comments, ratings, and webs-of-trust to be overlaid on a flexible textual network. A system such as Academedia, if ever brought into fruition, would create a form of academic communication that is both open and structured: the breadth of material published would increase, the reader's experience of that material would become more efficient, and a system for determining the quality of academic research would remain in place.

Regardless of the specific form that procedural academic networks ultimately take, it is clear that they pose a threat to the current notion that blind peer review is the best way to determining the quality of academic research. Any post-publication valuation of text that occurs in procedural networks (whether exogenous or endogenous) implicitly occurs within the context of the professional network; that is, every node of a textual network is read with a knowledge of the author and the author's place within a corresponding professional network. This has at least two effects on procedural textual and professional networks. First, success within the professional network tends to drive success in the textual network regardless of the value of the content; for

instance, when established authors contribute to procedural networks, their presence is immediately felt even if the content published within the procedural network is sub-par. Second, hyperawareness of their place within professional networks can ultimately alter the textual practices of authors, leading to such practices as link-slutting [as Walker defines it, “shamelessly selling one’s integrity for links” (2002: 79)] and link-promotion (trying to raise one’s profile by linking to popular authors or leaving a comment on a popular node with the sole purpose of driving traffic to one’s site). There is an implicit danger in such a direct connection between textual and professional networks; however, there are also great benefits: procedural networks create an open exchange of research in which every participant is an evaluator—leading ultimately to a more accurate valuation than currently available with the peer-review system.

It seems clear that text published in digital media need not be in a new hypermedia form to take advantage of the processing powers of the computer. Perhaps, the most important aspect of digital media lies not in how different text may look but in how differently it is distributed. Digital technology is forcing us to think beyond peer review, to investigate the ways in which the development and implementation of procedural publication models will reconfigure academic textual and professional networks. As we restructure the ways in which we filter research and organize knowledge, we have a tremendous opportunity to take the best elements of the past and refigure them to harness the unique properties of digital media. Procedural organization will likely be a part of any successive publishing model in digital media. Which type of procedural organization we as researchers ultimately favor will determine the shape not only of our collective knowledge but also of our professional lives. As academics, nothing else could be more worthy of careful consideration.

#### REFERENCES

- Aarseth, E. J. (1997). *Cybertext: Perspectives on Ergodic Literature*. Baltimore: Johns Hopkins UP.
- Bernstein, C. (2001). Electronic pies in the poetry sky. *E-Poetry 2001*. Buffalo, NY.
- Bolter, J. D. (1991). *Writing Space: The Computer, Hypertext, and the History of Writing*. Hillsdale, NJ: Lawrence Erlbaum Associates.
- Bolter, J. D. & Grusin, R. (1999). *Remediation: Understanding New Media*. Cambridge, MA: MIT Press.
- Bootz, P. (1999). The functional point of view: new artistic forms for programmed literary works. *Leonardo* 32(4), 307–316.
- Georgia Blue. *Moveabletype.org: Default Styles*. 1 December 2003. Available at: <http://moveabletype.org/georgia-blue.html>.
- Levinson, P. (1999). *Digital McLuhan: A Guide to the Information Millennium*. New York: Routledge.

- McLuhan, M. & Fiore, Q. (1967). *The Medium is the Massage*. New York: Bantam.
- Paquet, S. (2003). Towards structured blogging. *Seb's Open Reseach*. 16 August 2003; 1 December 2003. Available at: <http://radio.weblogs.com/0110772/stories/2003/03/13/-towardsStructuredBlogging.html>.
- Shannon, C. (1948). A mathematical theory of communication. *Bell Labs Mathematical Sciences Research Center*. 2 February 1998; 1 December 2003. Available at: <http://cm.belllabs.com/cm/ms/what/shannonday/shannon1948.pdf>.
- Walker, J. (2002). Links and power: the political economy of linking on the web. *Proceedings of Hypertext 2002*. Baltimore: ACM Press, 78–79.
- Web of trust. *Epinions.com*. 12 October 1999. Available at: <http://web.archive.org/web/20000309234155/www.epinions.com/selected.html>.

# Chapter 52: Wikis: Collaborative Virtual Learning Environments

NAOMI AUGAR, RUTH RAITMAN, AND WANLEI ZHOU

*School of Information Technology, Deakin University, Australia*

## 1. INTRODUCING WIKIS

Ward Cunningham used the word wiki (the Hawaiian word meaning quick) to name the collaborative tool he developed for use on the internet in 1994. Wikis are fully editable websites. Users can visit, read, re-organize and update the structure and content (text and pictures) of a wiki as they see fit. This functionality is called *open editing* (Leuf & Cunningham, 2001). All a user needs to edit and read a wiki, is a web browser. Consequently, the wiki has great potential for use as a collaborative virtual learning environment. Wikis abound on the internet. A well known wiki is Wikipedia an online collaborative encyclopaedia, where anybody can read, edit, re-organize and update the encyclopaedia content (Wikipedia, 2004). The homepage of Wikipedia is depicted in Figure 1.

### 1.1. How Wikis Work

Wikis have two different writing modes, or styles of usage. The first is known as *document mode*. When used in document mode contributors create collaborative documents written in the third person. Authors leave their additions to the wiki document unsigned. As time passes, multiple authors edit and update the content of the document and gradually the content becomes a representation of the shared knowledge or beliefs of the contributors (Leuf & Cunningham, 2001). The second wiki writing mode is *thread mode*. Contributors carry out discussions in the wiki environment by posting signed messages. Others respond leaving the original messages intact and eventually a group of threaded messages evolves (Leuf & Cunningham, 2001).

Wikis have two states, *read* and *edit*. Wikis are in *read* state by default. *Read* state means that the wiki page looks just like a normal webpage, as is shown in Figure 2. When the user wants to edit the wiki page, they must access the wiki's *edit* state. To edit a wiki, a user points their internet browser to the wiki URL (e.g., [www.wikipedia.org](http://www.wikipedia.org)) and clicks an edit button or link featured on each wiki page. Wikipedia provides a tab style format at the top of each page which contains a clickable link entitled "edit this page" which



Figure 1. The Wikipedia wiki encyclopaedia home page.

users can click to access Wikipedia's *edit* state. The “edit this page” tab is shown in bold at the top of Figure 2.

Most wikis use a version of *wiki syntax* that helps users to format wiki content (e.g., bold, underline and hyperlink text formatting). Users need to learn a set of basic mark up or syntax rules. *Wiki syntax* rules may vary depending on which wiki is being used. Some wikis, such as Wikipedia, do not require the user to know *wiki syntax*. Rather, an editing toolbar is provided so the user can type in their content and format it by clicking on the toolbar.

Figure 3 shows Wikipedia in *edit* state, the content in the text editing area has already been formatted using the editing toolbar. Consequently, it contains *wiki syntax* such as square brackets and apostrophes as well as text content. Once a user has added their contribution to the text editing area, they can click on a save button in the edit page to update the wiki content and return the interface to *read* state.

Users can add a new page to Wikipedia by accessing the wiki's *edit* state and formatting the required text using the internal hyperlink tool (third tool from the left in the toolbar depicted in Figure 3). This encloses the text (which constitutes the name or title of the new page) in double square brackets (refer



Figure 2. Users edit Wikipedia articles by clicking the “edit this page” tab.





Figure 3. Wikipedia in edit state.

Figure 3), which denote an internal link. When the page is returned to *read* state the newly formatted text appears as a hyperlink. Clicking the new hyperlink accesses the new page in *edit* state, where text can be added to the new page as required. Reading, editing and adding pages to a wiki is a simple process. However, the degree of difficulty for the novice user and the steps involved will vary depending on the wiki being used.

## 1.2. Wikis and Collaborative Learning

Wikis can be used to facilitate computer supported collaborative learning, CSCL. CSCL, first noted in the early 1990s, is the development of collaboration by means of technology to augment education and research. CSCL promotes peer interaction and facilitates the sharing and distribution of knowledge and expertise amongst a group of learners (Lipponen, 2002). Collaborative learning exercises are student centred and enable students to share authority and empower themselves with the responsibility of building on their foundational knowledge (Myers, 1991).

Considering that e-learning is the delivery of training and education via electronic media (Mohan & Greer, 2003), current research suggests that CSCL is one of the most significantly technological means for supporting e-learning. Positive interdependence is the heart of collaborative activities that define collaboration and transform group work into teamwork (Collazos et al., 2003). This can be defined as a learning process which is conducted in the CSCL environment and which goes through the following four sequential stages (Pan & Hawryszkiewicz, 2004):

1. The composition of the collaborative learning group which consists of assembling appropriate fellow students who will study together. This selection will be based on criteria such as academic strengths, group size, and a varied expertise in the subject matter.

2. The partition of the learning task into subtasks in an effort to allocate each one to a student member of the group. This distribution is based on the learning task, the learning modality to be adopted and the members' individual capabilities.
3. The completion of the individual subtasks whereby each group member attempts to finish their designated requirements.
4. The compilation of all the learning outcomes with a further attempt to present the results as determined by the shared initial group goal.

Wikis can be used to facilitate CSCL in an effort to support knowledge building and collaboration (Raitman et al., 2004). Students can use wikis to create a set of documents that reflect the shared knowledge of the learning group. Wikis can also be used to facilitate the dissemination of information, to enable the exchange of ideas and to facilitate group interaction.

Research undertaken at Georgia Tech highlights three ways in which wikis have been used as collaborative virtual learning environments: *Information distribution, collaborative artefact creation, and discussion and review activities* (Guzdial et al., 2001b).

*Distributing Information* Students worked collaboratively to gather and share information using a wiki as the repository and vehicle for dissemination. In the process students created an information resource similar to Wikipedia. Students also created a list of links to other useful resources using a wiki, known as a *collaborative hotlist* (Guzdial et al., 2001b).

*Collaborative Artifact Creation* Students collaborated to create artifacts using a wiki either for authoring or dissemination in the process. Exercises at Georgia Tech have included *collaborative writing*, the creation of a *collaborative glossary*, participation in *cross class projects* (where each class developed different aspects of the artifact), *cross-term communication* (re-using a wiki so it became the artifact which was created as a resource for future students) or finally the creation of a *choose-your-path adventure game* (student assignments involved the creation of multiple linked pages on a wiki where several links were grouped together representing the possible paths which the navigator could choose by selecting one of links and clicking on it) (Guzdial et al., 2001b).

*Discussion and Review Activities* Students used a wiki to participate in discussions about course content or artifacts. *Anchored discussions* involved staff or students posting links to resources on a wiki which acted as the focus for the discussion. This method was used at Georgia Tech to facilitate discussion and analysis of practice exam questions. A wiki was also used to create a *project case library* where students posted their exemplary work after grading, to act as a guide for the class on how to achieve a high standard in their work. This method was adopted by computer science, math and chemical engineering classes at Georgia Tech and students were given extra credit for participation. Finally, wikis were used for *professional and peer design review*

and *close reading* where particular readings were duplicated on a wiki and students hyperlinked sections of text which they felt merited further discussion to pages which critiqued the work (Guzdial et al., 2001b).

Schwartz et al. (2004) examined 24 wikis in use at universities in "... Canada, the US, Germany, New Zealand, Switzerland, and the UK" and noted that these wikis were used as information repositories, discussion mediums and as a mode of communication between students and teachers. Because groups of students can develop a collaborative information resource, which over time becomes the representation of the contributors' shared knowledge, wikis are ideal for the development of virtual learning communities (Augar et al., 2005a, b; Goodwin-Jones, 2003; Leuf & Cunningham, 2001; Schwartz et al., 2004).

## 2. WHICH WIKI?

Each wiki has a unique set of features which can make it more suited for use as a virtual learning environment. This section highlights several administrative issues that can influence the selection of an appropriate wiki. It also provides a brief overview of common wiki features and discusses how these features can be used for teaching and learning online.

### 2.1. Wiki Clones and Administrative Considerations

Simply put, wikis are a collection of program files or scripts which run on a web server. There are many different wikis, called wiki clones which can be downloaded free of charge on the internet. Wiki clones are written in a variety of programming languages. The reason for this is that wiki source code is available under the GNU General Public Licence, meaning the code is freely available to be reviewed and adjusted by developers. As a result, developers can translate the wiki code into their preferred programming language, which enables them to manipulate the code with ease. Many wiki clones are written in PHP, a common internet scripting and programming language. However, wikis are written in a variety of languages including Perl, Squeak, Ruby and Java, to name a few.

Wikis have a variety of features, such as user authentication, which are useful in a virtual learning environment. However, not all wiki features are enabled by default upon installation. Implementing advanced features sometimes requires the location and manipulation of individual lines of program code in the wiki source files. Consequently, wiki administrators need to be familiar with the programming language in which their wiki clone is written. This will allow them to change both administrative and installation settings with ease.

Table 1. A comparison of Wiki features.

Wiki Clone	Edit Style	Image Support	Authentication	Tracking	Sophistication
MediaWiki	Toolbar	Uploads and inline	Supported	User and IP	Moderate
PMWiki	WikiSyntax	Uploads and inline	Page password protection	IP	Basic to moderate
PhPWiki	WikiSyntax	Inline	Not supported	IP	Basic

Some wiki clones, such as MediaWiki store wiki site content in a database (MediaWiki, 2004). Others store wiki site content in flat files, as is the case with PMWiki (PMWiki, 2004). Wiki administrators should be familiar with the storage format used by their wiki so they can implement backup and recovery procedures and perform administrative and installation tasks.

## 2.2. Comparing Wiki Features

Table 1 compares several features of three different wikis written in PHP. These wikis were considered for use in the Deakin University wiki project (discussed later in this chapter), because the wiki administrator was familiar with PHP. The sample presented here is by no means exhaustive, but it is included to compare and contrast the features that impacted on the wiki selection process: Edit style, image support, authentication and tracking.

The edit style of most wiki clones (including PMWiki and PhPWiki) is such that users must know wiki syntax to edit effectively. However, wiki syntax can be confusing to novice users. MediaWiki provides an editing toolbar for users to format their posts, making editing a wiki relatively simple for a novice because they do not need to learn wiki syntax rules.

Not all wikis support the upload of images. Depending on the nature of the planned e-learning exercise this functionality could be a key issue in the selection of a wiki clone. When uploads are supported, as is the case with PMWiki and MediaWiki, users can place a copy of an image on the server that hosts the wiki, for use in their wiki posts. An alternative to this, inline images, requires the user to include a reference to an image stored on another server in their post. PhPWiki only supports the use of inline images.

Most wikis support tracking of wiki edits or updates. Tracking is useful for wiki administrators as it allows all wiki updates to be monitored and student participation to be assessed. Tracking is usually implemented as a “recent changes” page accessible from the wiki’s homepage. This page has a list of all the wiki pages that have been edited in a specified time period. When users are able to login to a wiki and be authenticated, the recent changes page will

attribute the changes to a specific user name, rather than the more common method of listing the anonymous user's IP address. Of the wikis reviewed only MediaWiki supported full user authentication and tracking.

Because MediaWiki users can be authenticated they also have access to a signature tool and a personal user page on the wiki. The signature tool appears as an icon in the wiki editing toolbar. If the signature tool is clicked when the wiki is in *edit* state, a signature (wiki username) is added to the editing text area. The signature tool creates a hyperlink that when clicked in *read* state, accesses a personal wiki user page. Signatures and user pages can aid students in building an online identity in the wiki virtual learning environment.

Wikis comprise many and varied features that contribute to their sophistication. Of the three wikis contrasted in Table 1, MediaWiki was considered to be the most sophisticated largely due to its editing style. However, MediaWiki's support of authentication, signatures, user pages, tracking and images also contributed to its being chosen for use in the Deakin University wiki project.

The aspects of wiki functionality discussed here are the minimum set of features that should be considered when choosing a wiki for use as a virtual learning environment. Cost, complexity, control, clarity, common technical framework and many and varied technical features are also highlighted as possible selection criteria in (Schwartz et al., 2004).

### 3. E-LEARNING AND WIKIS @ DEAKIN UNIVERSITY

Deakin University, in Victoria, Australia offers dual mode delivery of higher education degrees to students. Approximately half of Deakin's student body completes some or all of their degree through distance education (Calvert, 2001). Deakin comprises several campuses throughout Victoria. A given subject may be offered simultaneously at multiple campuses, as well as off campus (Augar et al., 2004).

The School of Information Technology has many units that are offered at two campuses and in both on and off campus mode. In line with University policy to promote online education, students completing a degree in Information Technology must complete an entire subject online (Deakin\_University, 2003). This is achieved through Deakin's virtual learning environment, DSO, Deakin Studies Online (Coldwell, 2003).

DSO is facilitated by WebCT Vista and provides bulletin boards, synchronous chat rooms, whiteboards and the like for communication and collaboration. Static course content is delivered in HTML, PDF or PowerPoint formats. DSO also provides tools for management of assignments, assessment as well as class management (Coldwell, 2003). Deakin is continuously developing its virtual learning environment to enhance the experience of all distance and on campus learners (Augar et al., 2004).

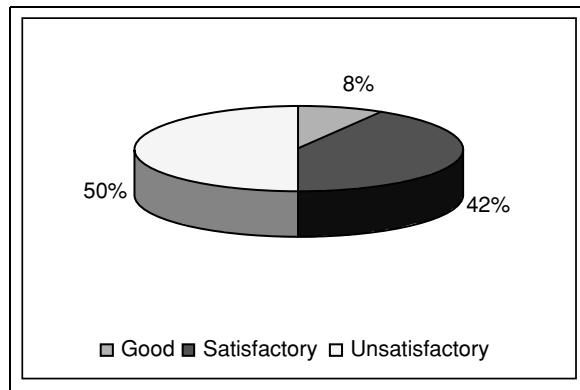

Figure 4. Students' view of learning online.

### 3.1. Previous Research

Ongoing research at Deakin University uses anonymous student surveys to evaluate student attitudes about learning online using DSO. Participants in a 2003 survey had completed a third year Information Technology subject called "Computers, Society and Professional Ethics" entirely online (Augar et al., 2004). For most students this was their first experience of learning in an online environment. Results showed that 50% of students found the experience unsatisfactory, as shown in Figure 4. Many cited frustration with technology and lack of interaction with peers and instructors as contributing factors to their lack of satisfaction.

Additional survey questions related to the students' participation in the asynchronous discussion forums which acted as online tutorial classes. Students participated in discussion groups of approximately 10 members. They talked about the content of prescribed readings and completed group tasks like compiling documents based on the results of their discussions. Only 42% of students surveyed indicated that all group members participated in the discussions. Of the students that did participate in discussion, almost half joined in on a weekly basis, as shown in Figure 5.

The first task completed by students as part of the subject was the publication of a single page biography in their discussion forum. It was envisaged that group members would read the biographies and use them to as a means to get to know their fellow group members, facilitating ongoing interaction throughout the duration of the subject. However, rather than lively interchange of ideas and construction of knowledge in the discussion forum, many students added a single post just before the deadlines and no real discussion or interchange of ideas occurred.

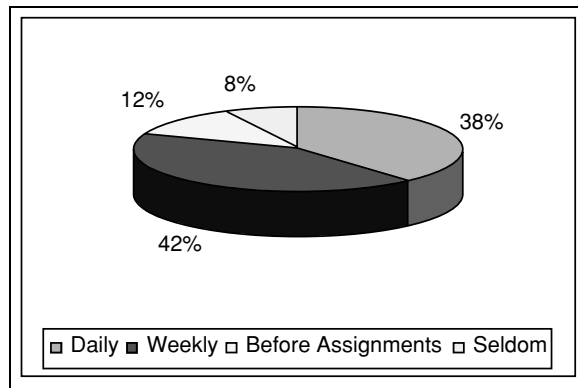

Figure 5. Dialogue frequency.

### 3.2. Using Wikis to “Break the Ice”

In an attempt to remedy the lack of interaction noted in online discussion groups in previous years, a traditional icebreaker exercise used in classroom situated tutorials at Deakin University was adapted for use on a wiki. The premise for developing the icebreaker exercise was to explore new ways to help students get to know the other members of their online learning groups.

In a classroom situated environment the icebreaker exercise consisted of a list of questions printed on a piece of paper. Sample questions include: “Find someone who has the same colour car as you?” or “Find someone who speaks a language other than English”. Students must list the name of at least one other class mate under each of the questions. Usually there are about 15 different questions, 20 students and the activity takes about 20 minutes to complete. Students get up and circulate in the classroom, asking each other questions, to try to locate people who match the criteria outlined in the questions. In completing the exercise they introduce themselves to their other classmates. Because all students are participating the exercise creates a non-threatening way for students to introduce themselves to others in the class. Observation indicates that students respond well to the exercise, establishing new friendships that continue throughout the semester.

The success of this classroom situated icebreaker led to the adaptation of the exercise for use on the School of Information Technology Wiki, or SITWiki. Students participated in wiki groups comprising approximately 10 members. Each group had their own icebreaker document on the wiki to complete as a group. Questions similar to those used in the classroom situated exercise were included in the icebreaker document. Students had 2 weeks to update the document in thread mode so that every question had at least one group member’s name underneath it. The icebreaker document was seeded with

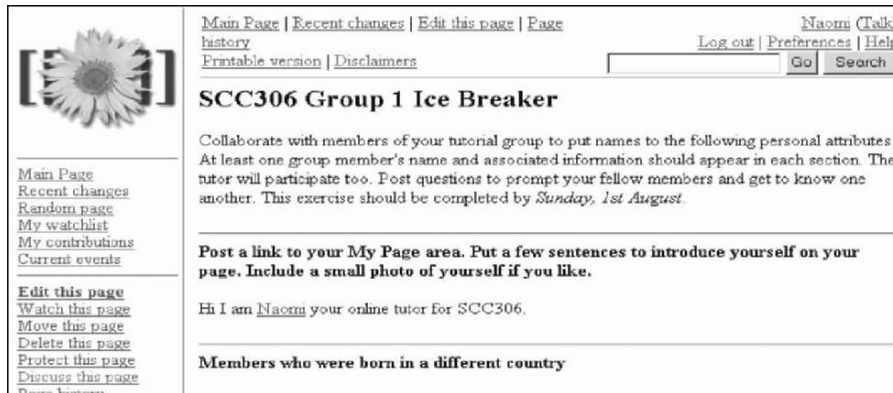

Figure 6. The SITWiki icebreaker exercise.

information about the group's tutor (online group teacher or facilitator). This was done to introduce the tutor to the group, and to model appropriate wiki usage and social presence to group members. A partially completed example is shown in Figure 6.

### 3.3. Signatures and User Pages

Students were encouraged to sign their posts using the SITWiki signature tool, so that other group members could attribute the posts to the appropriate person and get an appreciation of their character. Students were also encouraged to include a photo of themselves and a few brief sentences about themselves on their user page. Tutors also completed this task to model the process of constructing an appropriate online identity. An example of a tutor's user page is shown in Figure 7.

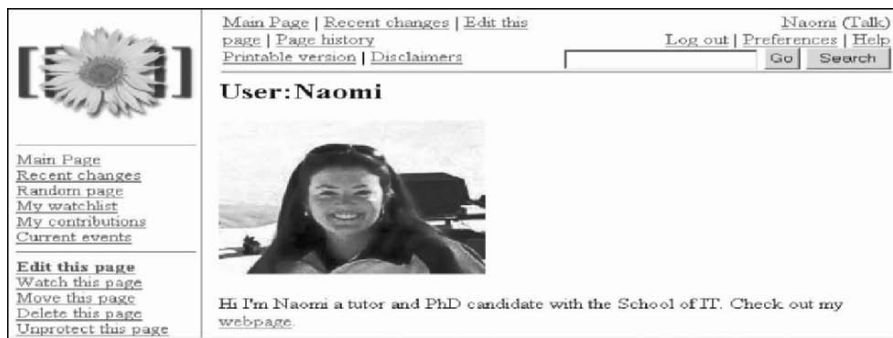

Figure 7. The SITWiki user page for Naomi Augar.



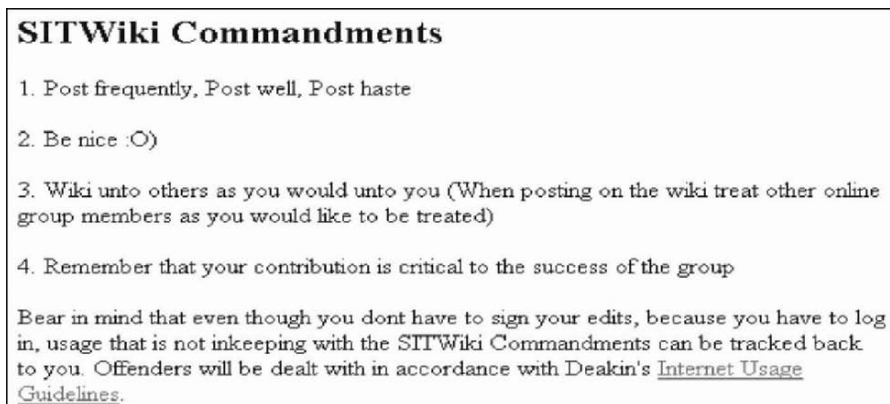

Figure 8. SITWiki commandments.

### 3.4. Wiki Security and Tracking

Possible problems faced when using wikis for e-learning include inappropriate posting of content and unintentional deletions. Several precautions were taken by SITWiki administrators to ensure that problems relating to the security of wiki content could be avoided if possible and could be rectified if they did occur.

The first step was the development of a set of four clear usage guidelines. Powazek (2002), advises that usage guidelines should be short, simple and written in a positive tone. Consequently, the SITWiki Commandments were developed and are depicted in Figure 8. The guidelines encouraged users to be considerate of others and be active and friendly in their wiki posts. The SITWiki Commandments appeared in a disclaimers page that is a default feature in MediaWiki. A link to the disclaimers page appears on every page in the SITWiki. In addition a link to the SITWiki Commandments was placed above the “save button” within the editing interface. This ensured that users were reminded about the usage guidelines every time they made a post on the wiki (Augar et al., 2005b).

In addition to the usage guidelines, tracking and authentication mechanisms was implemented to deter students from making inappropriate posts and deletions from the wiki. Because students had to login to edit the wiki, every post or edit could be attributed to an individual student. A note asking students to be aware that usage could be traced back to them was also included as a footnote to the SITWiki Commandments to deter intentional misuse. SITWiki included a rollback feature which could be used by administrators to repair any deletions or misuse as required. The SITWiki database was also backed up nightly to prevent loss of data in case of system failures.

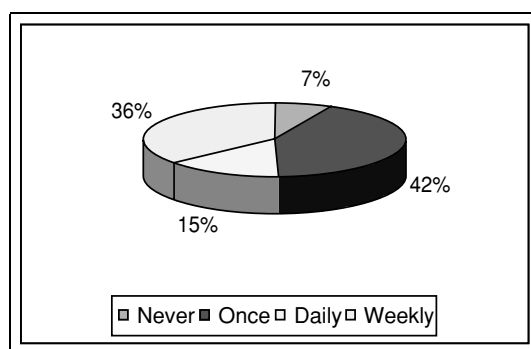

Figure 9. SITWiki edit statistics.

### 3.5. The Wiki Icebreaker in Review

SITWiki hosted 451 users who actively participated in the icebreaker exercise. Sixty eight per cent of active participants added some text to their user page. All users signed their posts and 92% used the signature tool to do so. However, the remaining 10% of students did type their name in plain text to sign their posts.

Many students added their picture to their user page, a total of 87 pictures were uploaded and displayed by wiki users. A popular icebreaker question asked users to add a post to tell the group if they had pets. Some students chose to upload a picture of their pet instead of a picture of themselves. Many linked the images of their pet to their posts responding to this question, other students added a picture of their pet to their user page.

Students were surveyed at the end of the University semester to explore how they used the wiki and to gather feedback about the experiment. Survey results showed that the majority of students edited the wiki either once, or at most weekly, during the icebreaker exercise, as is shown in Figure 9. However, half of the students surveyed indicated they checked the wiki on a daily basis to review the input of their group members. A further 35% indicated they viewed the wiki on a weekly basis as is shown in Figure 10. Encouragingly, 87% of students felt that the exercise enabled them to get to know their group members at least slightly better. Eighty three per cent of students felt that the exercise helped them get to know their tutor at least slightly better (Augar et al., 2005b).

Virtually all students participated actively and introduced themselves to each other by answering the questions. The School of IT at Deakin University has a very culturally diverse student body, so questions relating to culture were devised bearing this in mind. The students were very candid in disclosing information about their cultural background, such as where they were born, what languages they spoke and what countries they had lived in.

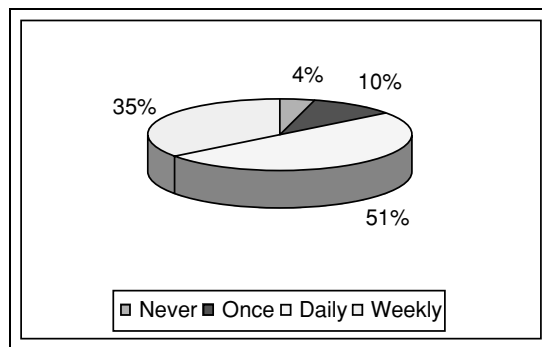

Figure 10. SITWiki view statistics.

Overall the wiki proved to be a good technology for online collaboration. All participating students completed the exercise to a satisfactory standard, proving they could use the wiki in the process. Throughout the 2 weeks duration of the icebreaker exercise there was no misuse or intentional deletions from the wiki indicating that the security measures taken were adequate and effective.

The wiki technology itself proved to be robust, supporting 450 users over a period of 2 weeks with no service outages. When the SITWiki was installed it was seeded with icebreaker documents for 50 student groups, several tutor home pages and many help pages; approximately 100 pages in total. Throughout the 2 weeks duration of the exercise the number of pages increased steadily each day to a final tally of over 1000 pages. Every day the wiki had between 1000 and 2000 page views, or hits. Each day the wiki was edited approximately 150 times and there were over 2000 wiki edits in total.

The wiki exercise presented here is purely social in nature, but it illustrates a possible use of wikis as a virtual learning environment. Another project underway at Deakin University at present encourages students working in project groups to use a wiki to disseminate information to their fellow group members, such as the time of future group meetings and the like. There is no structured task for students to complete on the wiki (as was the case with the icebreaker exercise). Students are able to use the wiki as they see fit to facilitate the completion of their assigned projects. Users of these project group wikis are not authenticated. Research aims to observe whether the lack of authentication and a structured exercise impacts upon the students' motivation to participate in the wiki environment.

Future research at Deakin University aims to use wikis *document mode* to enable students to collaborate in the creation of information repositories. The goal of this research is to further explore the use of wikis as virtual learning environments and to gauge the community building potential of wikis in the process.

#### 4. THE COWEB VIRTUAL LEARNING ENVIRONMENT @ GEORGIA TECH

The collaborative website (CoWeb), originally known as Swiki, is an open source wiki clone written in the Squeak programming language. CoWeb, was developed in the late nineties at Georgia Tech and has been used successfully as a collaborative virtual learning environment, supporting over 120 different subjects by thousands of students since its first implementation in 1998. Its feature set has evolved through a process of constant evaluation and improvement over a number of years. Some of the features that were added to enhance teaching and learning include the ability to be notified via e-mail alert when pages change, multifield templates which allow specific portions of a page to be edited at a time (rather than requiring the whole page be accessed in edit state), and page locking mechanisms (Guzdial et al., 2000a). Consequently, CoWeb is a wiki which has proven success as a virtual learning environment and unlike other open source wikis available on the internet, it benefits from years of rigorous use and testing in the education arena. Swiki, its documentation and the Commanche web server required for installation, can be downloaded at <http://minnow.cc.gatech.edu/swiki> (Guzdial, 2001; Guzdial et al., 2000a, 2001b).

CoWeb has been used in many different ways (highlighted in the collaborative learning section in this chapter) by students studying subjects such as Architecture, Chemical Engineering, Biology, Mathematics, Computer Science, and English at Georgia Tech. CoWeb has supported a blended learning approach to course delivery, where content and exercises are provided online but students still attend situated classes. The most common implementations of CoWeb have involved students constructing information resources and undertaking anchored discussions (Guzdial et al., 2000a, 2001b).

The ongoing success of CoWeb has been attributed in part to the open minded, enthusiastic teachers who integrated the system well in their courses and promoted its use and benefits to students in situated classes. Teachers were able to learn to use CoWeb with a minimum of training and could implement it in their classes with little effort. This led to creativity on the part of teachers who were responsible for developing many innovative uses for the CoWeb in course delivery. Research indicated that open ended problems with no single answer were best suited for collaborative projects on CoWeb and that students were more likely to participate if their input was assessed. Exercises worked well when they introduced CoWeb, explaining how it worked and how to use it effectively before scaffolding the student into detailed collaborative tasks once they were competent and confident in the new virtual learning environment (Guzdial et al., 2000b, 2001b).

CoWeb research also highlights instances where the system has failed. Interestingly, the researchers attribute the lack of enthusiasm shown by students to their distaste for collaboration in general. Surveys indicated that a

negative attitude to collaboration was evident in computer science, chemical engineering and math students who would rather receive a lower mark than collaborate with other students. Students perceived that collaboration would negatively impact on their overall marks because the classes were graded on a curve, making them highly competitive. Surveys also indicated that students enrolled in these courses felt that there was only one correct answer to most questions in their courses, and they preferred to learn independently (Guzdial et al., 2001a, 2002).

The wealth of research that documents the evolution of CoWeb and its successes and failures indicates that wikis can be used to create effective collaborative virtual learning environments. However, the exercise that will be completed on the wiki must be open ended in order to promote discourse and collaboration amongst students. The student body must be eased into the new learning environment via introductory exercises that teach them how to use the wiki effectively before they embark on detailed collaborative learning tasks. Finally, wikis have proven themselves to be easy to use by teachers and students alike, as their ongoing use at Georgia Tech attests.

#### 5. WIKIS @ TRINITY COLLEGE DUBLIN

Wikis were introduced at Trinity College to try and overcome the feelings of isolation felt by distance learners as a result of the individual nature of online learning and assessment. The UseMod wiki clone was used to provide a basic collaborative environment for an established community of post-graduate students who were completing a dissertation required as part of their degree. The wiki was primarily used by students for collaboration and discussion about their dissertations which would otherwise be completed in isolation. Researchers suggested that the post-graduates also use the wiki to evaluate and reflect upon their learning experience in the degree they were completing. The wiki also acted as a vehicle for an anchored discussion about PowerPoint presentations that would form part of a presentation to be delivered in conjunction with the submission of their dissertation (Gibney, 2004).

Support was given to students (who had above average levels of computer literacy) in the form of a *wiki guide* which acted as an FAQ about how to edit and use the wiki effectively. The wiki was protected from unauthorized access via a password, however users did not have to login to edit the wiki and could consequently remain anonymous. The structure and content of the wiki was modified continuously throughout the duration of the experiment inline with the recommendations and feedback of users and staff. Interviews with staff and feedback gathered during the exercise indicated that the wiki was not used to its greatest potential and that exercise would have been improved by catering to the needs of the novice wiki user. However, staff involved felt that

wikis had great potential as virtual learning environment to support distance education and inter-University collaboration (Gibney, 2004).

## 6. WIKI STARTING POINTS

Whilst the use of wikis as virtual learning environments is addressed in academic literature, some of which is cited in this chapter, the internet provides a plethora of resources and ideas for e-learning practitioners looking for ideas and support. Education based projects which use wikis and several different wiki clones are catalogued and contrasted in (Mattison, 2003). Indeed many wikis exist as collaborative online projects which are updated continuously by many anonymous users to detail how to start and maintain wikis for educational purposes. One such wiki is (WikisInTheClassroom, 2004). Technically adept practitioners may benefit from reviewing the large collection of wikis which are catalogued by (WikiEngines, 2004). Another page hosted by the same wiki, lists the experiences and recommendations added by various wiki practitioners from around the world (WikiInEducation, 2004). Online journals often provide detailed articles about how wikis are being used as virtual learning environments (Lamb, 2004; Schwartz et al., 2004). Finally, blogs (dynamic websites that act as personal journals) updated by enthusiastic e-learning practitioners can highlight the latest thoughts and reviews about the multitude of wikis available on the internet (Downes, 2004; Farmer, 2004).

## CONCLUSION

This chapter introduced wikis and explained how they work. It highlighted the fact that many wikis exist, each having varying sets of functionality and features. A brief analysis outlined the features that make some wikis suitable for use as virtual learning environments. Selecting a wiki that is easy to use is important; for instance wikis that support a simple *edit* style, by including an editing toolbar, are easier to use than those requiring the knowledge of *wiki syntax*. However, additional features such as authentication and tracking are required for wikis to be suitable for teaching and learning online. Authentication enables all wiki edits to be traced back to the author, enabling the assessment process. Tracking helps to secure wiki content against possible misuse and intentional deletions.

Wikis were used successfully to enable hundreds of students to participate in a collaborative icebreaker exercise at Deakin University. This project illustrated how e-learning practitioners can use wiki technology to enhance social interaction amongst students online. However, wikis can also be used for the dissemination of information to the student body, for building information

repositories or for the collaborative production of documents as research at Georgia Tech and Trinity College illustrates.

Wikis are freely available, reliable and relatively easy to use. However, they are not yet widely implemented in the education arena. Projects such as those underway at Deakin University and Georgia Tech at present illustrate how wikis can be used to create collaborative virtual learning environments.

#### ACKNOWLEDGEMENTS

The authors would like to acknowledge Jo Coldwell, Annegret Goold, James Farmer, and the entire teaching staff involved with the subject Computers Society and Professional Ethics, whose enthusiasm and open minded approach towards using wikis in their subject for the first time made this research possible. We would also like to thank Robert Ruge and Jeff McDonald for their invaluable technical support, and Sally Davey for her role in introducing us to the classroom situated icebreaker exercise. This chapter is an extension of Augar, N. et al. (2004). *Teaching and learning online with wikis*, Ascilite. Perth, Australia, 95–104.

#### REFERENCES

- Augar, N., Raitman, R., & Zhou, W. (2004). From e-learning to virtual learning community: bridging the gap. Paper presented at the *ICWL04*, Beijing.
- Augar, N., Raitman, R., Lanham, E., & Zhou, W. (2005a). Building Virtual Learning Communities. *Web-Based Intelligent e-Learning Systems: Technologies and Applications*: Idea Group (in press).
- Augar, N., Raitman, R., & Zhou, W. (2005b). Towards building web based learning communities with Wikis. Paper to be presented at the *Web Based Communities 2005*, Algarve, Portugal (in press).
- Calvert, J. (2001). *Deakin University: Going Online at a Dual Mode University*. Retrieved 19 February 2004, from <http://www.irrodl.org/content/v1.2/deakin.html>.
- Coldwell, J. (2003). Mapping pedagogy to technology—a simple model. Paper presented at the *Advances in Web-Based Learning ICWL 2003*, Melbourne.
- Collazos, C., Guerrero, L., Pino, J., & Ochoa, S. (2003). Collaborative Scenarios to Promote Positive Interdependence among Group Members. *Lecture Notes in Computer Science*, 2806/2003, 356–370.
- Deakin\_University. (2003). *Online Technology in Courses and Units*. Retrieved 23 Feb 2004, from <http://theguide.deakin.edu.au/TheGuide.nsf/WI?OpenFrameSet>.
- Downes, S. (2004). *Stephen's Web*. Retrieved 26th Dec 2004, from <http://www.downes.ca/>.
- Farmer, J. (2004). *Incorporated Subversion*. Retrieved 26 Dec 2004, from <http://incsub.org/blog/>.
- Gibney, S. (2004). *Wiki software as a tool for collaboration in a distance learning setting for post-graduate students embarking on the end of years research project—Wiki Works Wonders*. Masters Dissertation, Trinity College, Dublin. Retrieved 19 Dec 2004, from <http://www.cs.tcd.ie/~gibneysj/meta.pdf>.

- Goodwin-Jones, B. (2003). Emerging Technologies. Blogs and Wikis: environments for on-line collaboration. *Language Learning and Technology* 7(2). Retrieved 19 Dec 2004, from <http://lt.msu.edu/vol7num2/pdf/emerging.pdf>.
- Guzdial, M. (2001). *Use of Collaborative Multimedia in Computer Science Classes*. Paper presented at the ACM ITICSE. Retrieved 19 Dec 2004, from <http://coweb.cc.gatech.edu:8888/csl/uploads/24/ITICSE-CoWeb-final.pdf>.
- Guzdial, M., Ludovice, P., Real, M., Morley, T., Carroll, K., & Ladak, A. (2001). The challenge of collaborative learning in engineering and math. Paper presented at the *IEEE/ASEE Frontiers in Education 2001*, Reno, Nevada. Retrieved 19 Dec 2004, from <http://coweb.cc.gatech.edu:8888/csl/uploads/24/CMCI-Mellon.pdf>.
- Guzdial, M., Ludovice, P., Reaff, M., Morley, T., & Carroll, K. (2002). *When Collaboration Doesn't Work*. Retrieved 19 Dec 2004, from <http://coweb.cc.gatech.edu:8888/csl/uploads/24/CMCI-ICLS-final.pdf>.
- Guzdial, M., Rick, J., & Kehoe, C. M. (2001b). Beyond Adoption to Invention: Teacher-Created Collaborative Activities in Higher Education. *Journal of the Learning Sciences*. Retrieved 19 Dec 2004, from <http://coweb.cc.gatech.edu:8888/csl/uploads/24/CoWeb-final-Jan01.pdf>.
- Guzdial, M., Rick, J., & Kerimbaev, B. (2000a). *Recognizing and Supporting Roles in CSCW*. Paper presented at the ACM CSCW 2000, Philadelphia, PA. Retrieved 19 Dec 2004, from <http://coweb.cc.gatech.edu:8888/csl/uploads/cscw2000.1.pdf>.
- Guzdial, M., ul-Haq, S., Kahn, S., & Zimring, C. (2000b). *Using An Unstructured Collaboration Tool to Support Peer Interaction in Large College Classes*. Paper presented at the Fourth International Conference of the Learning Sciences, Mahwah, NJ, USA. Retrieved 19 Dec 2004, from <http://coweb.cc.gatech.edu:8888/csl/uploads/icls00.pdf>.
- Lamb, B. (2004). Wide open spaces: Wikis, ready or not. *Educause Review* 39(5), 36–48. Retrieved 26 Dec 2004, from <http://www.educause.edu/pub/er/erm04/erm0452.asp>.
- Leuf, B., & Cunningham, W. (2001). *The Wiki Way: Quick Collaboration on the Web*. Upper Saddle River: Addison Wesley.
- Lipponen, L. (2002). *Exploring Foundations for Computer-Supported Collaborative Learning*. Finland: University of Helsinki.
- Mattison, D. (2003). Quickiwiki, Swiki, Twiki, Zwiki and the Plone Wars Wiki as a PIM and collaborative content tool. *Searcher* 4(11), 32–48. Retrieved 26 Dec 2004, from <http://www.infotoday.com/searcher/apr03/mattison.shtml>.
- MediaWiki. (2004). *MediaWiki Homepage*. Retrieved 10 Aug 2004, from <http://wikipedia.sourceforge.net/>.
- Mohan, P., & Greer, J. (2003). Using technology to tackle the education challenges of the Caribbean. Paper presented at the *First International Workshop on Technology for Education in Developing Countries*, New Jersey, USA.
- Myers, J. (1991). Cooperative learning in heterogenous classes. *Cooperative Learning* 11(4).
- Pan, W. & Hawryszkiewicz, I. (2004). Software agents for facilitating collaboration among students in e-Learning. Paper presented at the *Conference Proceedings Ed-Media 2004*, Switzerland.
- PMWiki. (2004). *PMWiki Homepage*. Retrieved 10 Aug 2004, from <http://www.pmwiki.org>.
- Powazek, D. M. (2002). *Design for Community. The Art of Connecting Real People in Virtual Places*. Indianapolis: New Riders.
- Raitman, R., Augar, N., & Zhou, W. (2004). Constructing wikis as a platform for online collaboration in an e-learning environment. Paper presented at the *International Conference on Computers in Education*, Melbourne, Australia.
- Schwartz, L., Clark, S., Cossarin, M., & Rudolph, J. (2004). Educational Wikis: features and selection criteria. *International Review of Research in Open and Distance Learning* 5(1) Retrieved 19 Dec 2004, from [http://www.irrodl.org/content/v5.1/technote\\_xxvii.html](http://www.irrodl.org/content/v5.1/technote_xxvii.html).



- WikiEngines. (2004). *Wiki Engines*. Retrieved 19 Dec 2004, from <http://c2.com/cgi-bin/wiki?WikiEngines>.
- WikiInEducation. (2004). *Wiki in Education*. Retrieved 26 Dec 2004, from <http://c2.com/cgi/wiki?WikiInEducation>.
- Wikipedia. (2004). *Wikipedia*. Retrieved 9 Aug 2004, from [http://en.wikipedia.org/wiki/Main\\_Page](http://en.wikipedia.org/wiki/Main_Page).
- WikisInTheClassroom. (2004). *Educational Technology Wiki*. Retrieved 19 Dec 2004, from <http://edtech.coedit.net/WikisInTheClassroom>.

## Chapter 53: Partying Like it's 1999: On the Napsterization of Cultural Artifacts Via Peer-to-Peer Networks

JOHN LOGIE

*Department of Rhetoric, University of Minnesota, St. Paul, MN, U.S.A.*

As we begin to explore the possibilities and potentialities of Virtual Learning Environments (VLEs), it is critical that we understand the historical experiences that inform our students' interactions with virtual spaces. For students now attending universities the technology that first drew them to virtual spaces often was Napster, the first peer-to-peer application to achieve widespread popularity. While Napster and its peer-to-peer successors do not typically function as rich VLEs, they nevertheless are the spaces in which many students first cultivate a sense of the computer as a facilitator of community, communication, and exchange. In short, Napster offered the environment in which many current university students first embarked on virtual learning and their perceptions of contemporary VLEs are shaped by their peer-to-peer experiences.

Indeed, the disappointment that many students acknowledge when operating within commercial (and thus more constrained) VLEs is illustrative of the perceived freedom that students associate with their peer-to-peer experiences. But this freedom was always contested, and when placed within the frame of U.S. law, it was arguably illusory. That said, today's instructors must acknowledge and understand this perception if they hope to encourage students to adapt to the relatively controlled spaces found within many contemporary VLEs. A nuanced understanding of the history and consequences of the Napster case will aid instructors in developing VLE-savvy pedagogies that build upon the knowledge and skills gained during students' peer-to-peer experiences.

It is at times difficult to recall an internet predating the peer-to-peer networking that is now so commonplace, but Napster arrived fairly late in the life of the internet—a full decade after the development of the http protocol that underpins the World Wide Web. Napster was incorporated in May of 1999. The company's website “went live” in August of that year, offering an elegant user interface for locating and downloading music files compressed in the MP3 format via the internet. As word spread among savvy internet users Napster's network experienced exponential growth. Napster's users began transferring not only current popular music but also arcane, hard-to-find, and out-of-print music. Within weeks of Napster's launch, the traffic to and

from Napster's servers was becoming a significant problem for network administrators at universities across the United States. Recognizing the significant likelihood that much of this traffic was enabling violations of copyright, the Recording Industry Association of America filed suit against Napster in December of 1999. In January of 2000, after discovering that somewhere between 20% and 30% of *all* the traffic on its servers was Napster-directed, Northwestern University blocked student access to Napster on its networks (Gold, 2000). In April of 2000, the hard rock band Metallica and hip-hop producer and performer Dr. Dre also sued Napster, alleging copyright infringement and racketeering (Borland, 2000). Napster, in the wake of the publicity afforded by these high-profile lawsuits, became far and away the most popular file-transfer service on the internet. This prompted an additional wave of legal go-rounds and injunctions ultimately resulting in the demise of Napster as a free peer-to-peer network, when its servers were shut down in July of 2001.

Today, the striking iconography developed by the Napster Corporation lives on in as the public face of Napster 2.0, a pay-for-play music service offered by Roxio. But Napster 2.0 is demonstrably *not* Napster. Indeed, the Napster 2.0 pay-for-play service eliminates the community-building features (e.g., chat functionality among uploaders and downloaders) that made Napster both distinctive and especially efficient. Napster 2.0 is struggling to find its way as a pay-for-play service. But the Napster cat is out of the bag. As of this writing, the number of users of post-Napster peer-to-peer applications including KaZaA and various Gnutella clients dwarfs Napster's reported peak usage of 13.6 million. And these users are downloading without evident regard for the legal threats posed by the Recording Industry Association of America. Indeed, peer-to-peer users have, by and large, persisted in the same patterns of behavior that they did via Napster, and even extended their napsterization of cultural artifacts, freely downloading film, video, and photographic files via current peer-to-peer applications. And they are often doing so in defiance of the law, as it is commonly understood.

Napster's brief history as a peer-to-peer network points up the United States' failure to develop intellectual property policies that respond in positive ways to the use and transmission of creative work via the internet. Napster's file transfer technologies were, at the time of their initial circulation, largely unanticipated by U.S. law. Because Napster entered a gray area within the U.S. legal landscape, it offered an opportunity for a public policy discussion that might have productively evaluated the widening gap between common internet practices and the "letter" of U.S. copyright law, and generated responsive laws. Instead, to this point, the United States persists in projecting print-directed intellectual property policies into cyberspaces.

In the decade since the rise of the Mosaic browser made the internet a widely available public phenomenon, the U.S. government's response to internet technologies has proven increasingly consistent. When U.S. legislators

address themselves to the internet, the result is almost always a decline in opportunities for access, use, and circulation of copyrighted materials. This trend is typified by the so-called “Digital Millennium Copyright Act” of 1998, which, in overly broad language, forbade the circumvention of copy-protection mechanisms without regard for the possibility that such circumvention might be necessary for users to exercise access rights granted under the fair use exception to copyright law. The fair use exception, codified in a 1976 amendment to U.S. copyright law, is the space in which legislators formally recognized the degree to which the activities of educators, journalists, and critics depend on access to and limited use of information. In particular, the fair use exception cites use of copyrighted material for “nonprofit educational purposes” as especially favored, and students and academics have come to depend on the law’s bias in favor of non-profit use. The fair use exception facilitates the creation and circulation of digital archives in classrooms and libraries, but these uses are increasingly under attack by the content industries. Indeed, under the DMCA, it is not entirely clear whether an academic librarian who cracked the copy protection on a DVD in order to make a back-up copy would be violating the law or not. This distinction becomes especially important in light of the dramatic uptick in penalties for “crimes” against intellectual property. Just ask Dmitri Sklyarov, who spent weeks in jail and was forced to post \$50,000 bail after his demonstration of how to crack the copy protection on the Adobe e-book software prompted a complaint from Adobe.

The need for informed policies with regard to the use and circulation of copyrighted works is critical, not just for the United States, but in an international context, because *the internet itself is (among other things) a peer-to-peer file-sharing network*. While much of the activity on the internet might be described as client-server (and thus predicated on an imbalanced relationship between participants) there are also numerous sites within the internet that depend on a roughly level relationship among participants. The most prominent example is the Usenet news groups (e.g., alt.music.no-depression) that, prior to the advent of the World Wide Web, were, taken together, the most popular spaces on the internet. Usenet is, to this day, a peer-to-peer application, with level relationships among the NNTP servers that store and forward articles to one another. Thus, the policies developed to address music and media file transfers facilitated by peer-to-peer networks like Napster and its successors will almost certainly radiate not only beyond the boundaries of the United States, they will also radiate beyond the boundaries of the relatively narrow debates over the circulation of music and motion pictures to address technologies that enable the internet as we have come to know it. For this reason, it is in the collective interest of internet users to monitor and, at times, attempt to influence U.S. policy on peer-to-peer technologies.

Unfortunately, the Napster case presents a striking example of how *not* to conduct an argument over the transmission of copyrighted materials via peer-to-peer networks. Worse, the polarities established during the debate over

Napster continue to set the terms for the ongoing public policy discussion on peer-to-peer technologies. The Napster case was the foundational conflict in an ongoing effort to come to terms with the consequences of the widespread availability of copyrighted materials via the internet. And the policies developed to “cope” with Napster and its successors will effectively circumscribe the use of copyrighted information in the learning environments we are building in virtual spaces.

In the remaining pages, I will critically examine the flawed rhetorical constructions at the heart of the Napster debate. I will first explain how those who valued Napster failed to successfully frame a powerful argument that might have shifted the debate away from the accusations of piracy and criminality, which dominated popular press treatments of Napster. Napster’s fans had an opportunity to first acknowledge and then defend their uses of copyrighted materials, and this might have promoted a better result for Napster and for internet users more generally.

In the next section of this paper, I will illustrate how Napster was felled by a canny one-two punch from prominent musicians who functioned as the public mouthpieces for the recording industry. What is striking about these musicians—Lars Ulrich of the hard rock band Metallica and hip-hop impresario Dr. Dre—is that prior to this point their public personae had been grounded in an anti-authoritarian and anti-corporate ethos which, at least superficially, was at odds with zealous protection of intellectual property via courtrooms and corporate counsel. Indeed, at first blush, it is difficult to understand why the record industry allowed Ulrich and Dre to function as its representatives (as opposed to “safe” performers like Billy Joel or Celine Dion) given the degree to which Ulrich and Dre traffic in music and identity politics which can fairly be described as abrasive, profane, and advocating violence and criminal behavior. But, as I will argue, the “outlaw ethos” that Metallica and Dre had cultivated prior to the Napster controversy proved instrumental in the recording industry’s ultimate victory.

Finally, I will review the consequences of the Napster debate for users and developers of VLEs, and suggest that we have yet to move beyond the flawed arguments developed to address the particularities of Napster’s case.

To understand the arguments surrounding Napster it is important to first understand the laws involved in the Napster case, and to come to some sort of understanding as to whether Napster should have been understood as a legal technology or as the basis for a community of pirates. Napster, as a tool, enabled distributed file transfers. While other peer-to-peer systems, such as Gnutella, allow users to transfer almost *any* sort of file, Napster’s software enabled traffic only in music files encoded in the MP3 musical format. Almost all current computers are capable of easily producing such files, by extracting audio files from CDs and compressing them using the MPEG compression format (a format which was first developed to reduce the size of motion pictures in order to facilitate their distribution via the internet). Napster’s focus

on music files proved to be a virtue. The software's built-in limitation produced demonstrably superior results for those interested in locating specific music files. For a time, almost every pop song imaginable was available through Napster's service.

There can be no question that certain uses of distributed file-sharing networks like Napster are absolutely legal under U.S. law. This is not to say that the majority of the uses of Napster were aboveboard, but it *is* to say that a small but significant percentage of uses were certainly legal. If, for example, one used Napster to locate and secure a particular recording that was in the public domain, either because it was recorded prior to 1923 or because, for whatever reason, the copyright holder did not meet or maintain registration requirements, that use of Napster would be absolutely legal. On this basis, it is officially open season on Enrico Caruso's recordings (as the great tenor died in 1921). If I was downloading MP3 files of songs which I had already purchased on CD and downloading them, for convenience's sake, from other users who had also purchased the CD, this use might well be legal. And if I could frame an argument that the use in no way harmed the copyright holder's economic interest in that intellectual property, I would have at least the start of an argument that my use was either legal, according to the principles of fair use, or a *de minimis* violation of copyright, a violation so minor and so trivial that it falls beneath the purview of the court system. Most importantly, if I were to secure material for the express purpose of using it in my classroom teaching, that use would probably be legal according to the fair use exception to copyright—though the question becomes more complicated if my use involves a publicly available web space or learning environment.

The hedged language of the preceding paragraph is unfortunately necessary, as U.S. legislators have refused to offer "bright line" distinctions, preferring instead for judges to make the kinds of fine-grained decisions called for in copyright cases. In the absence of case law addressing a precisely parallel circumstance copyright consumers are left to guesstimate whether their uses are legal. Of course, the absence of clear markers means, in practical terms, that those wishing to use material that *might* be protected by copyright must err on the side of caution or assume some measure of risk of litigation. While many Napster users did not engage with the legal questions surrounding their downloads, many more made an informed judgment to assume the low risks attendant to their use of the Napster network. And indeed, there were ultimately *no* personal consequences for the use of Napster—only the Napster corporation suffered.

In March of 2001, the best estimates suggest that 2.8 *billion* music files were transferred over the network Napster facilitated (Graham, 2002). Because the internet is international in its scope and reach it is impossible to determine what percentage of these transfers were made by U.S.-based users. But given the general distribution of computer technology worldwide, it is almost certain that the vast majority of Napster's users hailed from the United States. And

this use of Napster was transpiring despite their increasing awareness that the technology at the heart of Napster's network was based on a questionable interpretation of U.S. copyright laws. In fact, Napster users' awareness of the July 29, 2000 injunction threatening to shut down Napster's servers prompted a flurry of downloading in the days prior to the prospective shutdown date (Konrad, 2000). The dramatic spike in downloads suggests that Napster fans were actively indulging in a "last call" prior to the service's shutdown in anticipation of the court ruling Napster to be illegal.

Despite the general presumption of illegality Napster users *did* have an arguable case with respect to their consumption of copyrighted materials. In addition to a generalized fair use argument, which did not really speak to most of the activity on Napster's servers, many Napster users cited the 1984 Supreme Court ruling in the so-called Betamax case as supporting their right to make and keep non-commercial copies of songs for their personal use. In this case, Universal studios sued Sony for having developed a commercial videotape recorder—a VCR—alleging that the primary use of the VCR as a technology was the enabling of piracy and that Sony should be held liable for contributory infringement. While the court acknowledged the likelihood of VCR owners archiving copies of copyrighted films and programs the Court also recognized that the VCR had a significant non-infringing use: the recording of programs for viewing at a later date, or time-shifting, and it ruled in favor of this non-infringing use without directly addressing the problem of archived videotapes harming the markets for commercial releases of copyrighted material.

The question of whether individual consumers can legally record and preserve copyrighted materials for personal use was also addressed by the Audio Home Recording Act of 1991. This Act protects manufacturers of recording devices (in this case the technology driving the law was Digital Audio Tape or DAT) from the charge that their devices were enabling contributory infringement when home users violated copyrights. But this protection came with a price. Manufacturers of DAT players and DAT tapes were also obliged to pay fees designed to address the likelihood that purchasers of DAT tape would be using this high-quality recording medium as a substitute for commercially produced recordings. Unlike the VCR, the DAT was never meant to time-shift broadcasted material—its chief purpose was creating the best possible reproductions of previously recorded material. Nevertheless, the legislative history found in the house reports leading to the Audio Home Recording Act makes it clear that, at least at that time, home recording for private, non-commercial use was not being targeted, in a passage which reads: "In short, the reported legislation would clearly establish that consumers cannot be sued for making analog or digital audio copies for private noncommercial use" (qtd. in Carroll, 1993).

The general import of both the Audio Home Recording Act *and* the holding in the Betamax case is that technologies facilitating both infringing and non-infringing copying ought not be withheld from the public, *even if the*

*availability of the technologies leads to infringing uses.* And while Congress offered special compensation to copyright holders for anticipated infringements by DAT users, the Supreme Court offered no such compensation to copyright holders for the expected infringements by home videotapers. If we follow the logic of these policy decisions, it seems clear that the peer-to-peer file sharing system at the heart of Napster *if understood as a technology*, ought to remain available to the public because, like the VCR, the technology is capable of substantial non-infringing uses. The only real question ought to be whether, like DAT, Napster and the machines associated with it ought to be subject to fees that would be distributed to copyright holders in compensation for anticipated infringements.

This was Napster's argument to win or lose. And Napster had the good fortune, at least initially, to be arguing against one of the most widely loathed industries this side of tobacco manufacturers: the record industry. Many music consumers hate the major record labels because record companies have been demonstrably ripping them off for years. (For example, music consumers were initially told that the high list price of CDs was due to the costs of establishing manufacturing facilities, and that prices would ultimately approximate the \$8.98 list price for vinyl LPs.) Further, many musicians view the major labels as necessary evils, and there are hundreds of cases of demonstrable unfairness to musicians by the record companies that supposedly nurture and develop them. Among the most notable: Muddy Waters, who fulfilled his contract, in part, by painting the Chess studios (Fricke, 1990); Creedence Clearwater Revival's John Fogerty, who was accused by his record label of plagiarizing *his own work* (Bio: John Fogerty, 2004); and the members of TLC who faced bankruptcy in the immediate wake of a #1 record (TLC, 1999). Two prominent musicians with roots in punk rock, Steve Albini and Courtney Love, have internet-based essays on the blatant unfairness of typical major-label contracts for most recording artists (*see* Albini, 2004; Love, 2000). And if all that were not incriminating enough, the five major record labels in 2004 paid out \$67.4 million and \$75.7 million worth of CDs to settle a class-action lawsuit addressing price-fixing (Lieberman, 2002).

While the record companies' evident bad faith does not legitimate copyright infringement, it does establish that these companies bring a *lot* of excess baggage to public debates over their intellectual property rights. In short, in their roles as mediators between artists and their fans, record companies have managed to deeply offend significant numbers of artists and fans. In this context, it is perhaps not surprising that Napster's initial forays into cyberspace bespoke an almost casual disregard for the major labels' interests. But it becomes clear that Napster ultimately remained too connected to this ethos—an ethos grounded in the music fan's distaste for the record company's business as usual—and this left the company open to charges of irresponsibility and piracy.

We can see part of the problem in the company's iconography. The early versions of Napster's logo featured a headphone-wearing figure that has been





*Figure 1. Shawn Fanning as rebel icon.*

variously described as a demon or a cat. It was meant to represent a cat, and, significantly, in the early versions of the logo, this was a black cat, conventionally symbolizing bad luck (but for whom?) The logo was later amended to bleach the cat and thereby reposition Napster as something other than sinister.

Napster also structured its public identity around the figure of the technology's inventor, Shawn Fanning, who developed the software code while a student at Northeastern University. Despite Fanning's having left the University almost immediately after this "Eureka" moment he is often presented in circumstances which reinforce his "dorm rat" persona. In a publicity photo which was featured on the company's website (Figure 1) we see the ballcap-wearing Fanning sitting in front of his record collection and what appears to be a handmade flag (a pirate flag?) looking like a sophomore with more than a touch of rebel attitude.

This positioning was transpiring while the "suits" at Napster were busy preparing for the company's initial public offering, and there is an obvious gap between Napster's attempts to develop into "respectable" dot.com and the maintenance of Fanning's ethos as a combination of college-age music fan and hacker. When *Time* magazine photographed Shawn Fanning for a cover story (Figure 2) and later, for its listing of Fanning as one of the finalists for its person-of-the-year award, its positioning of Fanning illustrates the degree to which Fanning had become synonymous with Napster. Here Fanning inhabits the headphone-wearing pose of the logo, and the accompanying text points out that "Napster" is both the company's name and a childhood nickname for Fanning.

By the end of 2000 Napster had yoked itself to Fanning, despite Fanning having a fairly limited role in the company's business operations. And throughout its first year, Napster struggled to find the balance point between serving the interests of its predominantly dormitory-based user base and the

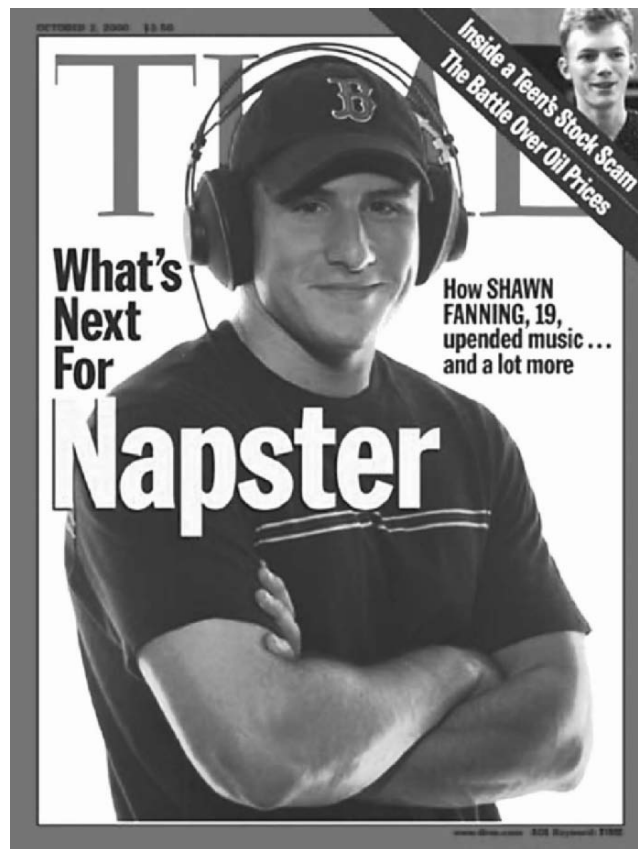

Figure 2. Fanning positioned as the Napster cat.

need to articulate a business model that would bespeak corporate responsibility with regard to copyright.

Fanning was consistent in positioning his work as community-oriented. In an early interview Fanning said:

I was at Northeastern University playing with the idea and getting feedback from my roommates, and then started drafting a really basic design idea. It was rooted out of frustration not only with MP3.com, Lycos, and Scour.net, but also to create a music community. There really was nothing like it at the time.

(Varanini, 2000)

And indeed, Fanning's software represented an important step forward from other services cataloging and delivering MP3 music files. Napster allowed for direct communication among users of the Napster software, so an individual downloading a particular song might well receive an instant message from the person serving that song to the network. Napster consistently spotlighted this

feature. Napster's press releases included a boilerplate phrase claiming that Napster "provide[d] media fans a forum to communicate their interests and tastes with one another."

Napster proved remarkably effective in developing a recognizable company ethos, grounded in the iconic figures of the Napster cat and the cat's human counterpart, Shawn Fanning. But classical treatments of ethos do not wholly account for the ways in which Napster established its connections with an audience. Clearly, Napster's initial stance is not one grounded in the establishment of the Aristotelian triad of good sense (*phronesis*) virtue (*arête*) and good will (*eunoia*), as the company's presentation is grounded, in large part, on a violation of the established order. Indeed, Napster was participating in the same sort of anti-authoritarian stance that has become conventional within the rock and hip-hop genres. As fans proclaimed, "Napster rocks", this rocking obliged Napster to maintain an orientation toward its fans and against the perceived corporate machine even as it strove to stabilize its own corporate machinery.

Coyle and Dolan's "Modeling Authenticity, Authenticating Commercial Models" (1999) illustrates the kind of polarities which rock musicians face when turning toward the marketplace:

New sounds are invariably proclaimed as liberations from the devitalizing control of industry, even as such proclamations generally inserts the new into an established pattern. Real rock is always a rebellion, always a disrespect to the hierarchy, a blow to the empire. The authentic article is never the commercial article.

To the extent that Napster wished to participate in rock's stance, it was precluded from full partnership with the record industry, because this would have violated the company's ethical obligations to its fan base.

This tension is reflected in Napster's sometime contradictory self-representations. Napster's first CEO, Eileen Richardson, attempted to maintain a position of corporate responsibility when she re-purposed Shawn Fanning's "community" theme as potentially falling outside the bounds of copyright law. Richardson said: "It's about community. Maybe I know about this band just in our local town, and you know about them, too. So it is a known artist, and I can share that with you directly. It is not about known artists like Madonna" (qtd. in Menn, 2003). Richardson was attempting to focus attention on potentially non-infringing uses: the sharing of unsigned bands among tiny circles of fans. But at the same time Napster's website stated that Napster "ensures the availability of every song online" and further, that Napster "virtually guarantees you'll find the song you want when you want it . . . and you can forget about wading through page after page of unknown artists." This implicit invitation to what the major labels describe as piracy and theft suggests that Napster's ethos was not grounded in assertions of virtue, but rather in something like Kenneth Burke's identification, which Burke explains most clearly in *A Rhetoric of Motives* (1969):

*A* is not identical with his colleague, *B*. But insofar as their interests are joined, *A* is *identified* with *B*. Or he may *identify himself* with *B* even when their interests are not joined, if he assumes that they are, or is persuaded to believe so. Two persons may be identified in terms of some principle they share in common, an *identification* that does not deny their distinctness. To identify *A* with *B* is to make *A* *consubstantial* with *B*.

Burkean identification offers rhetor and audience the opportunity to unite over a shared principle without necessarily verifying the virtue of either party. Thus, by maintaining Shawn Fanning as the public face of Napster, the company promoted an identification with fans of rock and hip-hop music which maintained the anti-corporate, anti-authoritarian stance of those musical genres. And this proved especially damaging when the contest shifted from a battle between Napster and the Recording Industry Association of America to a battle between Napster on one side and Metallica and Dr. Dre on the other.

Metallica describes itself as the “7th biggest selling act in American history”. The band’s success is grounded in a close relationship with its fan base—so close that when Metallica’s members collectively updated their hairstyles, this was seen as a capitulation to the image-consciousness promoted by MTV, but at odds with Metallica’s anti-corporate ethos. Metallica’s lyrics, too, position the band as vocal critics of a vaguely constructed network of authority figures including record companies, parents, and the U.S. government, a critique which is expressed most directly on the cover of the band’s album, “. . . And Justice for All” which features the iconic figure of Lady Justice being toppled by four ropes (probably corresponding to the four band members). The title’s song’s lyrics also bespeak a frustration with the degree to which “power wolves” pollute the justice system with money and influence.

A similarly oppositional stance, albeit one arising from a different space within U.S. culture, is everywhere apparent in Dr. Dre’s work. Dre’s career can be traced back to his membership in the Los Angeles-based group “Niggaz With Attitude” whose breakout single, “Fuck Tha Police”, was a withering indictment of the Los Angeles Police Department’s racist practices that predated Rodney King and the L.A. riots. A producer, writer, and performer—whom *Rolling Stone* has compared to Phil Spector, the architect of the 1960s “Wall of Sound”, and Quincy Jones, the producer of the biggest-selling record of all time—Dre has crafted an identity which balances his success as a performer and entrepreneur with the markers of “street credibility” which allow him to maintain a productive identification with his audience. Thus, while Dre is the owner of a record label, the label was named “Death Row Records”, associating his work with the politics of capital punishment, a practice which the State of Illinois suspended due to its evidently racist application. In the lyrics to his 1999 rap, “Forgot About Dre” Dre also, somewhat disingenuously positions himself as a struggling small business owner, refusing handouts because

his company is too “little”, and because he is too street-smart to be taken advantage of.

Once Dre and Metallica entered the legal arena the Recording Industry Association of America backed away from its aggressive attempts to set the terms of the Napster debate, relying instead on the sometimes inarticulate voices of Metallica’s drummer, Lars Ulrich, and Dr. Dre to carry the industry’s arguments to the public. At times, this undoubtedly proved excruciating for the industry. In one interview, Ulrich compared Napster’s claim that it could not hope to control whether the technology’s users violated copyrights or not as the equivalent of the National Rifle Association’s infamous “Guns Don’t Kill People, People Do”, argument. While Ulrich’s is correct in pointing to a superficial similarity between the arguments, the comparison also tacitly equates copyright infringement with murder. Clearly, this is not an optimal rhetorical presentation. And Ulrich’s Senate testimony was widely criticized by the band’s fans as a betrayal. Indeed, the juxtaposition of “Mr. Lars Ulrich” with the gentle questioning of Senator Orrin Hatch was one of the more irresistible pop culture mind grenades since Elvis shook hands with Richard Nixon, and a direct violation of Ulrich’s then settled image as a rock and roll wildman. And while Dre is verbally inventive as a writer and performer, his public statements on Napster were disappointingly brief and vague, his press release stated, baldly “I don’t like people stealing my music”, without addressing the complex questions arising from peer-to-peer technologies (Dansby, 2000). Dre’s participation in the argument was further complicated by his position as a hip-hop producer who had made extensive use of sampling technology on his records, sometimes with permission but often without. In fact, at the time of the Napster lawsuit, Dre himself was being sued by George Lucas for having sampled the “Dolby THX” sound which precedes some films, without first securing permission. And given that the sound was followed by a barrage of bong hits and profanity, it seems clear that Lucas, as a family-friendly entrepreneur would have denied permission.

Nevertheless, the industry hung back, allowing Ulrich, in particular, to function in the role of the aggrieved artist, and in so doing the industry transformed the Napster argument from a likely loser into an argument powerful enough to persuade a crucial district court judge to enjoin file-transfers via Napster’s site. Because Metallica and Dre so fully inhabited an outlaw ethos which allied them with fans and against the same authoritarian, corporate architecture which Napster had targeted, the industry succeeded in creating uncertainty and debate within a fan base which, prior to Metallica and Dre’s entering the argument, was united behind Napster’s implied assertions that music ought to be free.

Thus, while Napster initially offered a viable alternative to business as usual within the music industry by crafting an ethos that paralleled rock and hip-hop’s superficial rejection of authority and corporate politics, this left Napster with only limited opportunities to position itself as a legitimate

business. When, in the midst of this process, it faced a challenge from the very performers who had inspired its existence, Napster faced an argument it could not win without “selling out”. In the music industry, this is a familiar narrative. Like many performers in its favored genres, Napster failed to successfully negotiate the difficult task of preserving its authenticity and integrity when the company became an “overnight sensation”. But this is not the sort of narrative that ought to lie at the heart of an important discussion about public policy. Napster was allowed to function as a representative for *all* peer-to-peer applications and networks, and its eventual defeat created a circumstance in which even clearly legal uses of peer-to-peer technologies are greeted with wariness (especially by university legal counselors who are compelled to err on the side of caution).

Napster’s demise still reverberates throughout discussions of intellectual property in virtual spaces. One of the most striking testaments to Napster’s continuing influence is the website “napsterization.org” which defines “napsterization” as “the disintermediation by new technologies and digital media of old economy, incumbent institutions and analog frameworks” (Hodder, 2004). The “disintermediation” referenced here is usually understood as the internet-based elimination of the “middleman” in (formerly) physical and print-based transactions. In conventional transactions there are layers of intermediation, as a product moves from manufacturer to market. But the internet has long been understood as offering opportunities for disintermediation, for streamlining relationships between artistic producers and their audiences. In the case of popular music, the call for disintermediation is particularly pronounced, as the music industry and music consumers have for many years maintained a relationship characterized by suspicion, frustration, and antipathy. The advent of the MP3 format, which made it feasible to transfer music files over even relatively low-bandwidth dial-up connections, was a notable technical breakthrough. But the explosive expansion of Napster was not attributable solely to its leveraging of technology. Napster also offered an opportunity for music fans to demonstrate their distaste for an industry that had often failed to address consumer’s calls for products other than the default 10–15 song compact disk retailing for \$16.99–\$19.99. And indeed, the current reality is that music consumers now have considerably more choices. The prices of compact disks have dropped significantly and consumers wishing to purchase single songs are able to do so via Napster 2.0, Apple’s iTunes, and a host of other pay-for-play services. The music industry has responded in positive ways to the implied threat posed by Napster and its successors. And by so doing, the content industries are repositioning themselves.

Despite dramatic shifts in the availability and affordability of popular music, a large cohort of music fans persist in maintaining the Napster model. In May of 2003, Kazaa Media Desktop became the most downloaded software in the history of the internet. By the end of that month, individuals had downloaded over 230 million copies of the file-transfer software. They did so despite

persistent reports that the software included “sneakware” and “spyware”—surreptitiously installed applications that would appropriate computer processing power and monitor computer usage, sending the by-products of both back to Kazaa’s parent company. Indeed, the description of Kazaa Media Desktop at Download.com, one of the major sources for the software features the following warning:

**Editor’s note:** This download includes additional applications bundled with the software’s installer file. Third-party applications bundled with this download may record your surfing habits, deliver advertising, collect private information, or modify your system settings. Pay close attention to the end user license agreement and installation options. For more information, read Download.com’s guide to adware.

Further, these 230 million downloads occurred despite the general understanding that Kazaa’s software was designed to enable activities generally thought, in the wake of Napster, to be illegal. The U.S. public has demonstrated a voracious appetite for mp3 music files and has persisted in using peer-to-peer networks to download music despite the implicit threats to privacy posed by Kazaa, and the possible illegality of their actions (as implied by the injunction that closed Napster as a “free” peer-to-peer network). While the majority of the public now seems to have been persuaded that their actions might well be proven illicit, they are not buying the larger argument—that they must cease and desist downloading copyrighted files.

The U.S. citizenry’s difficulties with respecting copyrights have a long history. But the arguments mobilized in response to citizen’s actions have remained remarkably consistent. In the 19th Century, the United States had a well-earned reputation as a nation of copyright scofflaws. At that time, Charles Dickens toured the country decrying the pirated editions of his novels that effectively wiped out the market for legitimate editions. As a British author Dickens was directly harmed by America’s refusal to honor international copyright laws. Eventually, many American authors came to share Dickens’ views. Vaidhyanathan’s *Copyrights and Copywrongs* (2001) devotes a chapter to Mark Twain’s vexed relationship with copyright, and his shift from what Vaidhyanathan calls “copyright realism” to plaintive calls for *perpetual* copyright. At one point, Twain argued:

The limited copyright makes a distinction between an author’s property and real estate, pretending that both are not created, produced, and acquired in the same way. The man who purchases a landed estate had to earn the money by superiority of his intellect; a book is a result of the author’s own brain in the same manner—a combination and exploitation of his ideas.

Vaidhyathan rightly takes Twain to task for the speciousness of this argument, pointing out that there is no necessary relationship between having money to purchase property and labor *or* intellect. And yet core appeals of this argument persist to the present. First, Twain's argument hinges on establishing an equivalency between tangible and intellectual properties. While this supposed equivalence is easily deconstructed, it reverberates throughout intellectual property discourse. For example, representatives of the record industry have repeatedly insisted that there is no appreciable difference between an unauthorized download and shoplifting a compact disk. Tellingly, Metallica drummer Lars Ulrich made this case in his July 2000 testimony before the U.S. senate:

If you're not fortunate enough to own a computer, there's only one way to assemble a music collection the equivalent of a Napster user's: theft. Walk into a record store, grab what you want and walk out. The difference is that the familiar phrase a computer user hears, "File's done," is replaced by another familiar phrase, "You're under arrest."

Ulrich's argument hinges on the elision of the important distinction between tangible physical artifacts and readily reproducible digital files. In Ulrich's hypothetical, the shop owner is harmed, having paid to purchase the pilfered compact disks. In the case of a downloaded file, the uploader and downloader each retain perfect copies. There is measurable harm only when the downloader would have purchased the file in question were it not for its ready availability via a peer-to-peer network. This difference was, for many years, recognized in U.S. law. Physical theft was understood as a criminal matter, with penalties including imprisonment, whereas copyright infringement was understood as a civil matter with financial penalties as the primary remedy.

The second element of Twain's argument is an implied *pathos* appeal, grounded in the notion that the author has worked hard and expended effort (or at least, made use of "superior intellect") and deserves to be rewarded for the expenditure. This argument, too, has a counterpart in Ulrich's testimony.

Since what I do is make music, let's talk about the recording artist for a moment. When Metallica makes an album we spend many months and many hundreds of thousands of our own dollars writing and recording. We also contribute our inspiration and perspiration. It's what we do for a living. Even though we're passionate about it, it's our job.

But copyright makes no allowance for inspiration and perspiration. Indeed, the law makes no distinction between the by-products of Metallica's "job" and a recording like Jimi Hendrix's "Band of Gypsies", which documents a live performance on New Year's Eve, 1970. In the case of "Band of Gypsies" an engineer simply rolled tape on a live performance. Hendrix's inspiration



and perspiration were certainly involved, but they would have been present even if this performance had not been recorded. Further, copyright law does not distinguish between the evident artistry of Metallica and the utter (yet arguably charming) incompetence of a performer like William Hung, who is currently parlaying his infamous audition for “American Idol” into a recording career.

Despite the obvious flaws in these arguments, they have triumphed. So we must account for how it is that Mark Twain and Lars Ulrich mobilized arguments that have demonstrable rhetorical power. Clearly, the most compelling elements of these arguments are the points when Twain and Ulrich speak as working artists seeking fair compensation for their efforts. While the logical foundation of their arguments is shaky, most of the participants in the peer-to-peer debates would stipulate that fair compensation for the creators of cultural artifacts ought to be central to any copyright law (though there would be wide variation of opinion when it came time to define “fair compensation”). The question at present is whether the current debate over peer-to-peer technologies is moving us closer to a system in which digital media prompt fair compensation for creators, or effectively delaying the development of such a system.

The Napster debate was, from a legislative standpoint, largely resolved by the Senate hearings featuring Ulrich’s testimony and the court case that closed Napster’s servers. But this debate, by highlighting Ulrich’s arguments, served to perpetuate a fundamental misconception with respect to users of peer-to-peer technologies: that they are “thieves” (or more commonly, “pirates”) of other people’s “property”. This perception remains dominant despite the absence of precise correspondences to physical theft and real property, as Vaidhyanathan (2002) points out:

We make a grave mistake when we choose to engage in discussions of copyright in terms of “property.” Copyright is not about “property” as commonly understood. It is a specific state-granted monopoly issued for particular policy reasons. While, technically, it describes real property as well, it also describes a more fundamental public good that precedes specific policy choices the state may make about the regulation and dispensation of property. But we can’t win an argument as long as those who hold inordinate interest in copyright maximization can cry “theft” at any mention of fair use or users’ rights. You can’t argue for theft.

Napster’s unfortunate legacy is its inscription of users of peer-to-peer technologies as pirates. The positioning of the company’s corporate icon, Shawn Fanning, flying the flag of dorm-based rebellion was ultimately understood as emblematic of all users of peer-to-peer technologies. This undermined a more reflective portrait of peer-to-peer users which would include, among others: the classroom instructors who keep their courses current by briefly referencing

current artworks; the Usenet users who build communities around shared interest in particular cultural phenomena; and archivists, who are struggling to maintain whatever is most compelling amidst the torrents of data now available via the internet.

The Napster case should serve as a telling indication of how much might be lost if the internet community at large allows the peer-to-peer debate to continue as a contest between “pirates” and “property-holders”. Indeed, one of the most compelling opportunities afforded by digital technologies is its destabilization of the once sharply delineated relationships between producers and consumers of digital artifacts. And this has particular resonance for those instructors inviting students to participate in building and shaping VLEs. The process of building rich virtual spaces often involves borrowing existing snatches of code, riding on previously invented wheels, and incorporating and critiquing the massive waves of information that crash down regularly throughout cyberspace. A reasonable reading of the fair use exception would suggest that instructors and students ought to undertake these efforts without fear of legal retribution, so long as they honor the exception’s calls for “criticism, comment, . . . teaching . . . , scholarship, or research.”

But these opportunities may never be realized if peer-to-peer users persist in partying like it is 1999—downloading without compunction. Thus, it falls to the academy to begin the process of demonstrating the degree to which the educational process depends upon the kinds of use and access to information that are now threatened. Not only must instructors model appropriate use and acknowledgment of others’ materials when developing VLEs, they must also directly engage with the laws and policies addressing these uses. Unless those whose work depends upon use of and access to copyrighted materials offer cogent and compelling rationales for their activities, the developing mischaracterization of peer-to-peer transfers as at best suspect and at worst piratical will continue to reverberate throughout U.S. copyright law. And the trend toward replacing free resources with less attractive “pay for play” services will accelerate.

To date, the rhetorical strategies exemplified by Lars Ulrich have carried the day. Surely, the distributed international network of peer-to-peer users, many of whom are among the most educated and technologically savvy members of their communities, can collaborate to produce a stronger argument.

#### REFERENCES

- Albini, S. (1994). The Problem With Music. Retrieved March 24, 2004, from: <http://www.negativland.com/albini.html>.
- Bio: John Fogerty. Retrieved March 24, 2004, from: [http://www.mtv.com/bands/az/fogerty\\_john/bio.jhtml](http://www.mtv.com/bands/az/fogerty_john/bio.jhtml).
- Borland, J. (September 8, 2000). Metallica, Dr. Dre urge Colleges to Cut Napster Access. Retrieved March 23, 2004, from: <http://news.com.com/2100-1023-245505.html>.

- Burke, K. (1969). *A Rhetoric of Motives*. Berkeley: University of California Press.
- Carroll, T. (January 11, 1993). 17 USC 1008 (was: Music Tapes). Retrieved March 23, 2004, from: <http://www.cni.org/Hforums/cni-copyright/1993-01/0018.html>.
- Dansby, A. (April 27, 2000). Dr. Dre Takes Napster to Court. *Rolling Stone* 839. Retrieved March 23, 2004, from: <http://members.fortunecity.de/dre2/Magazines/RollingStone.000427/>.
- Fricke, D. (1990). Muddy Waters; The Chess Box. *Rolling Stone* 570. Retrieved March 24, 2004, from: <http://www.rollingstone.com/reviews/cd/review.asp?aid=64997&cf=5687>.
- Gold, R. (2000). 'U' Concerned About MP3 Use. *Michigan Daily* 110. Retrieved March 23, 2004, from: <http://www.pub.umich.edu/daily/2000/feb/02-08-2000/news/07.html>.
- Graham, J. (February 6, 2002). Despite Troubles, There's Still Hope for Napster. *USA Today*. Retrieved March 23, 2004, from: <http://www.usatoday.com/tech/techreviews/2001-05-23-still-hope-for-napster.htm>.
- Hodder, M. (2004). About Napsterization.Org. Retrieved March 23, 2004, from: <http://napsterization.org/aboutus.htm>.
- Konrad, R. (July 28, 2000). Napster Fans Frantically Download Tunes. Retrieved March 23, 2004, from: <http://news.com.com/2100-1023-245505.html>.
- Lieberman, D. (September 30, 2002). States Settle CD Price-Fixing Case. *USA Today*. Retrieved March 23, 2004, from: [http://www.usatoday.com/life/music/news/2002-09-30-cd-settlement\\_x.htm](http://www.usatoday.com/life/music/news/2002-09-30-cd-settlement_x.htm).
- Love, C. (June 14, 2000). Courtney Love Does the Math. Retrieved March 24, 2004, from: <http://dir.salon.com/tech/feature/2000/06/14/love/index.html>.
- Menn, J. (2003). *All the Rave: the Rise and Fall of Shawn Fanning's Napster*, 1st ed. New York: Crown Business.
- TLC: Sexy Trio Back on Top After Bankruptcy. (April 12, 1999). *Jet*. Retrieved March 24, 2004, from: [http://www.findarticles.com/p/articles/mi\\_m1355/is\\_19\\_95/ai\\_54726312](http://www.findarticles.com/p/articles/mi_m1355/is_19_95/ai_54726312).
- Vaidhyanathan, S. (2001). *Copyrights and Copywrongs: the Rise of Intellectual Property and How it Threatens Creativity*. New York: New York University Press.
- Vaidhyanathan, S. (August 2, 2002). Copyright as Cudgel. *Chronicle of Higher Education*, B7. Retrieved March 23, 2004, from: <http://chronicle.com/free/v48/i47/47b00701.htm>.
- Varanini, G. (March 2, 2000). Q&A: Napster Creator Shawn Fanning. Retrieved March 23, 2004, from: <http://zdnet.com.com/2100-11-502047.html?legacy=zdn>.

## Chapter 54: Virtual Harlem as a Collaborative Learning Environment: A Project of the University of Illinois at Chicago's Electronic Visualization Lab

JIM SOSNOSKI\*, STEVE JONES, BRYAN CARTER,  
KEN McALLISTER, RYAN MOELLER, AND RONEN MIR

Although numerous virtual reality (VR) applications devoted to educational purposes have been developed at University of Illinois at Chicago's (UIC) Electronic Visualization Laboratory, we focus on the Virtual Harlem project because it is designed as a collaborative learning environment (CLN)—a VR application that is structured as a networked collaboration with the goal of building a model of the subject being studied (see “the Virtual Harlem Project” below for a more detailed description).

Virtual Harlem is a learning environment (Sosnoski & Carter, 2001). Visitors can enter Virtual Harlem and navigate through it as a way of learning about the historical context, the events, the everyday life of persons who were living in Harlem at the time.



Unlike a conventional classroom in which the subject matter being studied is available to students mostly in textbooks, on blackboards, or in slides projected on the wall, Virtual Harlem is a locale that has to be experienced. Students enter a cityscape that can be experienced, albeit virtually, as if they were tourists visiting Harlem, NY via a time machine. To visit Virtual Harlem is to undergo a virtual experience.

Virtual Harlem is also an historical replica of Harlem, NY. during the Harlem Renaissance in the 1920s and 1930s. Scholars of the Harlem Renaissance direct their students in research that contributes to the model. Their research informs the work of students in computer science at the University of Illinois at Chicago's (UIC) Electronic Visualization Lab (EVL). Many of these students are in the Fine Arts program at UIC and they contribute their skills by creating digital replicas of the buildings, people, automobiles, and other aspects of the scenario.

Virtual Harlem is also a networked project and has been seen at VR sites from New York, to France, to Sweden, to Japan, and to Arizona. Classes in the Harlem Renaissance at various universities, for example, at the Sorbonne in Paris, France are part of the network that use Virtual Harlem to give their students a more holistic experience than books can provide.

The Virtual Harlem project at UIC has been influenced by two important VR educational applications developed at UICs EVL, namely, the NICE project and the Round Earth project. We describe these projects and indicate how they have influenced the Virtual Harlem project in the next section. Then we delineate the pedagogical rationales underlying the project. Next we describe the Virtual Harlem project as a CLN, after which we comment on two of its outcomes, and conclude with comments from our perspective on the significance of the Virtual Harlem project.

#### 1. THE RESOURCES OF THE UNIVERSITY OF ILLINOIS AT CHICAGO'S ELECTRONIC VISUALIZATION LABORATORY

The Electronic Visualization Laboratory (EVL) at the UIC is a graduate research laboratory specializing in VR and real-time interactive computer graphics directed by Tom Defanti and Dan Sandin. Instruction at EVL is a collaborative effort of faculty in UICs College of Engineering, the School of Art and Design, and the College of Liberal Arts and Sciences.

An important focus of EVLs research has been the development of VR systems and their application to both science and art. Current research focuses upon developing the software to support collaborative, virtual environments, and the networking over which these applications are shared. Research is also ongoing to utilize video, audio, and database technologies to provide seamless, collaborative, virtual environments for design, interactive art, and data visualization.



*Figure 1.*

EVL seeks to provide an infrastructure for educators to collect, maintain, develop, distribute and evaluate virtual environment (VE) tools and techniques used to create learning environments. VE tools and techniques include computer-based models, simulations, data libraries, programming libraries, and user interfaces. The libraries and user interfaces encompass visual, auditory, tactile, and motion-based information displays.

After building first and second-generation immersive VR devices (the CAVE—Computer Automated Virtual Environment—in 1991 and the ImmersaDesk in 1995 Figure 1) to support tele-immersion applications, EVL is now conducting research in “third-generation” VR devices to construct variable resolution and desktop/office-sized displays. The Access Grid Augmented Virtual Environment (AGAVE), GeoWall (Figure 2), and Paris are the most recent VR devices developed at EVL.

Over the past decade, EVL has developed VR applications for collaborative exploration of scientific and engineering data over national and global



Figure 2.

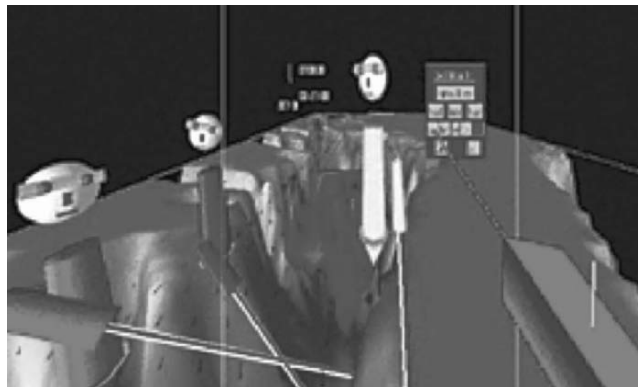

*Figure 2. Continued*

high-speed networks referred to as “tele-immersion” (Defanti et al., 1999; Johnson, 2000; Lascara et al., 1999; Leigh et al., 1999;). Tele-immersion is defined as collaborative VR over networks, an extension of the “human/computer interaction” paradigm to “human/computer/human collaboration”, with the computer providing real-time data in shared, collaborative environments, to enable computational science and engineering researchers to interact with each other (the “tele-conferencing” paradigm) as well as their computational models, over distance. Current tele-immersion research focuses on providing easy access to integrated heterogeneous distributed computing environments, whether with supercomputers, remote instrumentation, networks, or mass storage devices using advanced real-time 3D immersive interfaces.



CAVERN, the CAVE Research Network, is an alliance of industrial and research institutions equipped with CAVE-based VR hardware and high-performance computing resources, interconnected by high-speed networks, to support collaboration in design, education, engineering, computational steering, and scientific visualization.



CAVERNsoft is the collaborative software backbone for CAVERN. CAVERNsoft uses distributed data stores to manage the wide range of data volumes (from a few bytes to several terabytes) that are typically needed for sustaining collaborative virtual environments. Multiple networking interfaces support customizable, latency, data consistency, and scalability that are needed to support a broad spectrum of networking requirements. These diverse database and networking requirements are characteristics typically not exhibited by previous desktop multimedia systems but are common in real-time immersive VR applications.

Many of the applications developed at EVL are educational. In the next section, we focus on one of them, the Virtual Harlem project because it is a good example of a collaborative learning network utilizing CAVE technology. We first delineate the pedagogical assumptions underlying the Virtual Harlem project. Next we briefly speak about the educational projects at EVL that preceded and influenced the design of Virtual Harlem. Then we speak briefly about the migration of such projects to different technological settings such as small science museums and gaming engines converted to educational purposes. After describing the Virtual Harlem project, we include a brief interview with Tom Defanti and Dan Sandin, the Co-Directors of EVL, on future directions in VR developments. We conclude with a reflection on what has been accomplished and what work needs to be done on projects like Virtual Harlem.

## 2. EARLY EXPERIMENTS AT EVL AND THEIR IMPACT ON THE VIRTUAL HARLEM PROJECT

In 1996, NICE was the first collaborative VR learning environment created at the EVL. The team that built NICE was: Andy Johnson, Maria Roussou, Tom Moher, Jason Leigh, and Christina Vasilakis (N-team). The NICE project was a collaborative environment in the form of a virtual island for young children. In the center of this island was a garden where the children, represented by avatars a graphical representation of the person's body in the virtual world—could collaboratively plant, grow, and pick vegetables and flowers. They needed to ensure that the plants had sufficient water, sunlight, and space to grow, and kept a look out for hungry animals which might sneak in and eat the plants (Roussou et al., 1997a, b, 1999; Johnson et al., 1998).



The N-team had just completed a project called CALVIN that allowed several remote users, each standing in a CAVE or in front of an ImmersaDesk, to collaboratively arrange objects in a shared architectural space. Some of these users moved through the space at human-scale while others were giants. The giants were better at moving furniture and walls around, while the humans were better at judging the quality of the resulting space. The design evolved over time so users could enter the space, make a change, leave, and another user could enter the space later and see the new design. When the CALVIN project ended, the N-team was very intrigued by these ideas of asynchronous

collaboration and heterogeneous views, and wanted to investigate them further.

Like CALVIN, NICE supported real-time distributed collaboration. Multiple children could interact with the garden and each other from remote sites. Each remote user's presence in the virtual space was established using an avatar—The avatars had a separate head, body, and hand, which corresponded to the user's actual tracked head and hand motions.

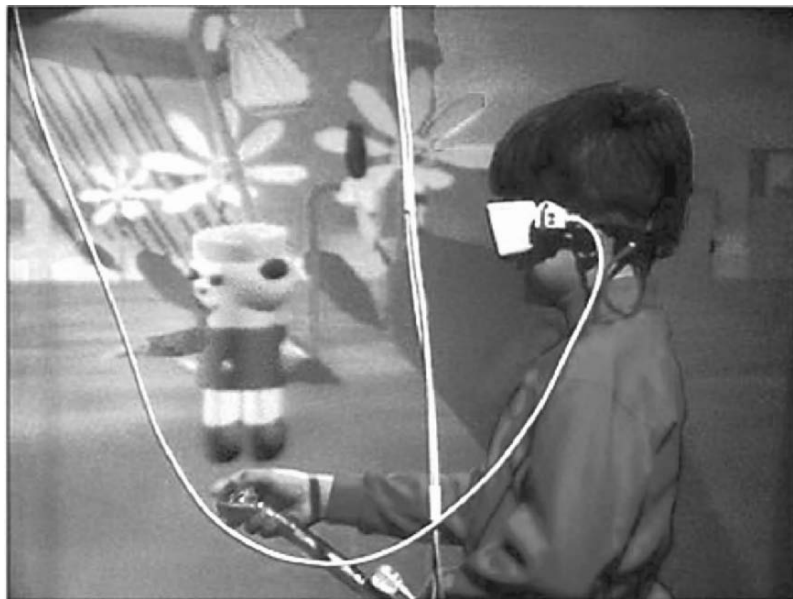

This allowed the environment to record and transmit sufficiently detailed gestures between the participants, such as the nodding of their heads, the waving of their hand, and the exchange of objects. Voice communication was enabled by a real-time audio connection.

In NICE the N-team also included avatars that were clearly non-human. Participants could be birds or whales, or bees. It can be rather limiting to always be represented as a humanoid avatar, and there may be advantages to looking like something else. In NICE adults could share the garden with the children without appearing as obvious authority figures. Continuing with our interest in heterogeneous perspectives, the children in NICE could shrink down to the size of a mouse and walk under the soil of the garden. This also allowed a full-size child to pick up one of the shrunken kids and carry them around.

In CALVIN the virtual world only changed when one of the users changed it. In NICE the development team wanted a more sophisticated world that could evolve on its own, even when all the participants had left the environment

and the display devices were switched off. NICE's virtual environment was persistent; the server was left constantly running; the plants in the garden kept growing. The plants were simple agents with common rules of behavior based on simplified ecological models containing a common set of characteristics that contribute to their growth. The combination of these attributes determined the health of each plant and its size. This also allowed them to determine the pace at which the world evolved; choosing to see the plants grow very quickly, or extend their growth over several months.

Every action in the environment added to a story that was being continuously formed. The narrative revolves around tending the garden and the decisions taken while interacting with the other characters. These interactions are captured by the system in the form of simple sentences such as "Amy planted a tomato" that go through a parser, which replaces the nouns with their iconic representations and publishes it on a web page. This gives the story a picture book look that the child could print to take home.

As an educational environment there were problems. The most serious shortcoming was the inadequacy of its science model. The balance among reality, abstraction, and engagement is particularly difficult to achieve; in this case the application likely veered too far from reality. Secondly, instead of directing activity toward the discovery of the underlying scientific knowledge, the N-team assumed that the desired learning would take place naturally through exploration and discovery. This obscured the intended learning goals. Thirdly, the presence of avatars representing remote users spurred social interaction, but did little to structure cooperative learning to fostered positive interdependence among learners, or support reflection and planning. Social interaction became an end unto itself, rather than a mechanism to support learning.

Overall the successes and failures of NICE significantly influenced the design of the Virtual Harlem project. NICE represented an explicit attempt to blend several pedagogical themes within a single application. Constructionism, exploratory learning, collaboration, and the primacy of narrative, reflect several of the most important educational reform themes of the past three decades. These features of the NICE project were incorporated into Virtual Harlem which was designed as a collaborative environment that emphasized the primacy of narrative in that it is a hiSTORY. As in the case of NICE, students were invited to explore Virtual Harlem and to participate in its construction.

Another project that influenced the design of the Virtual Harlem project was "The Round Earth Project". The team that developed the Round Earth project was: Tom Moher, Andrew Johnson, Stellan Ohlsson, and Mark Gillingham (RE-team). This project investigates how VR technology can be used to help teach concepts that are not a part of students' mental model of the world. Virtual reality can be used to provide an alternative view of the world that

alters the representation of it based on past experiences. In particular, we compared two strategies for using VR to teach children that the Earth is round when their everyday experience tells them that it is flat (Ohlsson, 2000: 364–368).

The concept of a round Earth is not a simple one for children to acquire. Their everyday experience reinforces their deeply held notion that the Earth is flat. Told by adults that the Earth is round, they often react by constructing a mental model of the Earth as a pancake, or a terrarium-like structure with people living on the flat dirt layer inside, or even a dual model with a spherical Earth and a flat Earth coexisting simultaneously. In effect, children attempt to accommodate the new knowledge within the framework of their existing conceptual models. Unfortunately, holding tight to the features of those prior models inhibits fundamental conceptual change.

One strategy, the “transformationalist”, starts the children off on the Earth and attempts to transform their current mental model of the Earth into the spherical model. The second strategy, the “selectionist”, starts the children off on a small asteroid where they can learn about the sphericity of the asteroid independent of their Earth-bound experiences. Bridging activities then relate their asteroid experiences back to the Earth. In each of the strategies, two children participate at the same time. One child participates from a CAVE while the other participates from an Immersadesk. The child in the CAVE travels around the Earth or the asteroid to retrieve items to complete a task, but can not find these items without assistance. The child at the Immersadesk with a view of the world as a sphere provides this assistance. The children must reconcile their different views to accomplish their task.

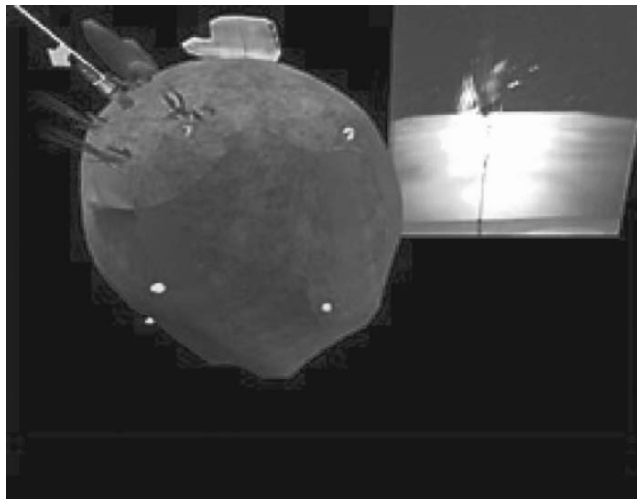

Virtual reality (VR) technologies are used to support both pedagogical strategies. In the transformationalist approach, VR is used to simulate the

launching of a spacecraft from the Earth's surface and subsequent exploration within a fixed-height orbit. In the selectionist approach, VR is used to simulate a small diameter asteroid. Thus learners may walk on a body with a curved horizon, see objects "appear" from "below" the horizon, take a long walk around the entire globe and come back to where they started. In both environments, distributed VR technologies are used to provide a CLN promoting positive interdependence among pairs of learners. Although we do not employ the term, "selectionist" in our account, the Round Earth Project confirmed our main hypothesis, namely that virtual experiences can occasion changes in the learner's worldview.

The importance of the Round Earth project for the Virtual Harlem project team was that Stellan Ohlsson's research confirmed that virtual experiences can provide "deep learning" alterations in the learner. Stellan Ohlsson argues that ideas which are fundamental to knowledge domains are acquired through "deep learning". He writes: "Unlike other types of knowledge, fundamental ideas cannot be acquired through discourse or concrete experience, because those ideas are the very tools by which the mind interprets both discourse and experience". Such ideas are acquired through a process he terms, "deep learning", during which the cognitive frameworks (abstract general frames or concepts) persons use to understand their experience in particular knowledge domains undergo a transformation. "New fundamental ideas are acquired by instantiating an abstract schema in a novel way; the new instantiation gradually assimilates pieces of the relevant domain, until it has effectively become the new center of that domain. Abstract schemas, in turn, are generated by combining and transforming prior schemas". His research points to the following observation: Reading about a theory has little impact on students unless they have acquired an abstract schema of the fundamental concept *in another domain*.

Ohlsson's research includes experiments with VR scenarios which provide "another domain" through which students can experience "fundamental concepts" before they learn them in the context of the knowledge domain with which they are associated by experts. Ohlsson writes: "New technologies for presenting interactive 3-dimensional worlds have been developed at UIC's EVL. This technology is a means for presenting students with alternative experiences that contrast with everyday experience in educationally relevant ways" (Ohlsson, 2000).

Working from the circumstance that the "deep learning" process is often highly "analogical", we extended Ohlsson's research into the ways in which persons map their personal worlds. Since Virtual Harlem is a representation of African American culture, it comprises a "sector of a world-map" or worldview (the mental construction of space which persons use to locate their experience of distance from their present location). One hypothesis governing the project is that "sectors" of personal worlds parallel knowledge domains. Unlike knowledge domains, however, such sectors do not provide organizing

frameworks to give order to abstract concepts; rather, they provide general narratives, “configurations” of experiences.<sup>1</sup>

A correlative hypothesis is that configurations undergo a process of transformation similar to the one Ohlsson describes with respect to “fundamental ideas”. Because configurations are the stories that are fundamental to personal maps of the world, they can be said to constitute a “cultural domain” parallel to a knowledge domain. Such domains are often shared—in the case of knowledge domains by the members of a discipline, and, in the case of cultural domains, by the members of a culture. Theoretically, then, it is possible that a person may replace a stereotypical configuration of African American culture with one that reflects its history more accurately.

The sections that follow—Virtual Harlem, the Small Science Museum, and the Learning Games Initiative projects—came to be associated with EVL through the ASCEND network directed by Jim Sosnoski. ASCEND links UIC to other educational institutions interested in developing virtual learning environments featuring computer modeling. The ASCEND network is an outgrowth of the Virtual Harlem project that has as one of its goals furthering the engaged learning experiences observed in the projects we have described.

### 3. CLNS AS VR LEARNING ENVIRONMENTS

There are innumerable cultural heritage (CH) projects, including a few initiated at EVL. There are fewer VR projects that are the center of a CLN (Sosnoski & Carter, 2001: 115ff.). There are several reasons for this. Unlike CH projects, CLNs require exacting research into the subject matter as well as into the technology that displays it. In addition, CLNs depend upon a collaborative network that spans a broad range of educational institutions from high schools to museums and Cultural Centers. Further, they require a subject of study that constitutes an environment learners can “inhabit” and to which collaborators with significantly different skill levels, technological savvy, scholarly acumen, and cultural perspective can contribute.

CH projects can be anything from the restoration of a homestead such as those supported by Australia’s CH Projects Program (CHPP) to North Carolina’s, *Exploring Cultural Heritage Online* (ECHO) whose vision is that “*All of North Carolina’s cultural institutions work together to make the state’s unique cultural and historical resources accessible for the education and enjoyment of people of all ages in the state, nation, and the world*”.<sup>2</sup>

Although CH and CLN projects have cultural sites as their focal points, a CLN has to meet strict academic standards and produce historically accurate representations of the cultural site being modeled. Whereas, it is not very problematic to render an existing site accurately, it is quite another endeavor to render an historical site like Virtual Harlem accurately when the buildings, signs, and persons who inhabited in the 1920s and 1930s are available, if

at all, only in photographs or written descriptions. For example, there is a VR project consisting of 16 fullscreen 360-degree panoramas of the existing Vatican's basilicas and surroundings—including St. Peter's, Santa Maria Maggiore, San Paolo Fuori le Mura, and San Giovanni in Laterano. Because the project replicates existing buildings, it is not difficult to construct accurately by using photographs with software such as Maya. However, the fact that the VR application is “accompanied by Gregorian chants performed by Mina Mazzini, Italy's legendary Diva” would be highly problematic to an historian of the basilicas.<sup>3</sup>

UCLA's Cultural Lab,<sup>4</sup> for instance, has also built a VR version of the Santa Maria Maggiore basilica, but under quite different constraints. One of the goals of the lab is the creation of scientifically authenticated 3D computer models of cultural sites. For instance, the Basilica of Santa Maria Maggiore (“St. Mary Major”) which was built by Pope Sixtus III in 432–440 A.D. on the highest point of the Cispian Hill is being restored in UCLA's Cultural Lab. Because it is a “virtual model” of the historical building, it requires historical research. For this reason the UCLA Cultural Lab is associated with the Center for Medieval and Renaissance Studies.

Though similar in intention to UCLA's Cultural Lab projects, the Virtual Harlem project focuses on the historical context of the Harlem Renaissance.

#### 4. THE PEDAGOGICAL RATIONALE FOR THE VIRTUAL HARLEM PROJECT

According to the historian David Levering Lewis, the artists and writers associated with the Harlem Renaissance configured African American Culture as a counter to the prevalent racial stereotypes hoping to influence persons who could not actually experience African American culture to reconfigure it in “their mind's eye”. As improbable as it seems that narratives of African American culture might have the potential to change the worldviews of persons who had never experienced it at first hand, nonetheless, current research suggests that it can be a very effective tactic for social change (Lewis, 1997: 90).

Recent studies of “narrative impact” support this strategy of social transformation. In *Narrative Impact: Social and Cognitive Foundations*, the editors state that the subject of their book is the impact of public narratives that are aimed at persuading the public (Green & Brock, 2002: xiii–xiv). Several contributors refer to studies that show the widespread social impact of narratives such as the Bible or Uncle Tom's Cabin. Their remarks are often based on previous research that demonstrates the role narratives have played in social change. In the Introduction to the volume, Green, Strange, and Brock note that “the impact of public narratives on beliefs and behavior has received substantial scholarly investigation in disciplines such as sociology (e.g., Gamson, 1992), communications (e.g., Bryant & Zillman, 1994; Gerbner et al., 1994), humanities (e.g., Booth, 1988), and political science (e.g., Iyengar & Kinder,



1987)” (Green & Brock, 2002: 2). Since psychological research has focused on advertising without reference to its implicit narratives, Green and Brock have conducted a series of experiments involving “imagery-rich narratives”. These experiments confirm that prior beliefs can be changed by imagery rich narratives that confirm or threaten their audiences’ worldviews.

Research on the phenomenon of “psychological transportation”, which is defined “as a state in which a reader becomes absorbed in the narrative world, leaving the real world, at least momentarily, behind” (Green & Brock, 2002: 317), indicates that readers’ propensity to experience transportation is dependent upon mental imagery evoked by the narrative. “A mental image is a representation of a particular stimulus that is formed by activation of a sensory system and, thus, is experienced by the organism as having similar qualities to the actual perception of the stimulus” (Dadds et al., 1997: 90). Such sequences of mental images contextualized by a narrative provide the sensations that accompany actual experiences. “Instead of seeing activity in their physical surroundings, transported readers see the action of the story unfolding before them” (Green & Brock, 2002: 317). Such virtual experiences, which are usually “seen” “in the mind’s eye”, can be remembered. When recalled, they can be applied to analogous situations in an experience transfer. Virtual reality narratives are likely to have similar outcomes.

Green and Brock’s “Transportation-Imagery Model”, consists of the following five postulates.

- Postulate I. Narrative persuasion is limited to story texts (scripts) (a) which are in fact narratives, (b) in which images are evoked, and (c) in which readers’ (viewers) beliefs are implicated.
- Postulate II. Narrative persuasion (belief change) occurs, other things equal, to the extent that the evoked images are activated by psychological transportation, defined (below) as a state in which a reader becomes absorbed in the narrative world, leaving the real world, at least momentarily, behind.
- Postulate III. Propensity for transportation by exposure to a given narrative account is affected by attributes of the recipient (for example, imagery skill).
- Postulate IV. Propensity for transportation by exposure to a given narrative account is affected by attributes of the text (script). Among these moderating attributes are the level of artistic craftsmanship and the extent of adherence to narrative format. Another conceivable moderator, whether the text is labeled as fact or fiction (as true or not necessarily true), does not limit transportation.
- Postulate V. Propensity for transportation by exposure to a given narrative account is affected by attributes of the context (medium). Among these moderating attributes may be aspects of the context or medium that limit opportunity for imaginative investment and participatory responses. (Green & Brock, 2002: 316–317)

Restated as a sequence of cognitive experiences, Green and Brock's "Transportation-Imagery Model" would have the following stages:

1. The experience of a narration
  - which "deals in human or human-like intention and action and the vicissitudes and consequences that mark their course" and in which the sequence of events is both "logical" (cause-effect) and implicitly chronological.
  - and which portray situations that imply beliefs held by the audience.
2. The narrated events stimulate mental images from past experiences
  - that transport the audience into the world of narrative where they lose the sense of their physical surroundings.
  - and that evoke sensations (seeing, hearing, feeling) reminiscent of past experiences.
  - which are accompanied by emotions when the associated beliefs are threatened or confirmed by the implications of the narrative.
3. The narrated events enter the memory system where they can be recalled.

The flow of this "transportation" experience can be applied to VR narrative scenarios since both types of narration depend upon the impact of the mental images evoked. The major difference is that instead of "reading" the audience would be viewing the narrative. This difference is one that is anticipated by Green and Brock when they write: "The term 'reader' may be broadly construed to include listeners or viewers or any recipient of narrative information" (Green & Brock, 2002: 323).

The concepts of "suspension of disbelief" and "in the mind's eye" and both are conditions of "narrative persuasion", that is the use of narratives to change a person's beliefs and attitudes. Narrative persuasion depends upon the phenomenon of transportation. To be engaged by a VR narrative, viewers have to "suspend the belief" that they are in a darkened room looking at 3D images on a screen and listening to recorded sounds. Though readers see the narrated scene's "in their mind's eye", viewers in VR CAVEs, would seem to be looking at pictures directly. However, viewers actively supply "in their mind's eyes" much of the detail missing in the images and they also "correct" unrealistic images "in their mind's eyes". Though both of these conditions pertain to VR experiences, it is less clear that the sense of being "Lost in a book" (Nell, 1988), that is, being "transported" arises from the 3D images in the VR scenario.

In their delineation of the phenomenon of transportation, Green and Brock stress the "adherence to narrative format" as one of the chief conditions for the experience. Many VR narratives, including the current version of Virtual Harlem, do not meet this criteria. Virtual Harlem is a narrative but it lacks "story elements". For the most part visitors to Virtual Harlem experience the

sequence of events that occur as they navigate their way through the cityscape as a “tour” a “chronology of events” rather than a “story”. Stories set up expectations in their readers or viewers. As narratologists have argued, narratives require “resolution”. Because they draw their audiences into identifications with characters in the story, the desires and conflicts they encounter are shared empathetically by readers or viewers. The difference is salient to audiences. In its format Virtual Harlem is closer to the videos one nowadays see on real-estate websites that allow you to “walk” through the rooms of a house or apartment than it is to films like *Fatal Attraction* whose audiences shouted at the screen in the climatic bathroom scene where Alex (Glen Close) attacks Beth (Ann Archer) only to be saved by Dan (Michael Douglas).

Admittedly, Virtual Harlem or its recently developed companion, Virtual Montmartre, are not yet ready to transport their audiences into history. However, it is not beyond the capacity of VR scenarios to do so. In 1999, when we frequently gave tours of Virtual Harlem at UICs EVL bat-CAVE, we liked to follow it with Josephine Anstey’s “The Thing Growing”, a VR short story. Her website describes “The Thing Growing” as “a work of fiction implemented in VR, in which the user is the main protagonist and interacts with computer controlled characters.”<sup>5</sup> It was originally built for a CAVE VR system at the Electronic Visualization Laboratory between 1997 and 2000. We believe intelligent agents are crucial elements for dramatic VR applications. The Thing was our first attempt at building a responsive character—a manipulative creature designed to encourage the user to jump through emotional hoops”. As a VR narrative, “The Thing Growing” visualizes a short story Anstey had been writing in which she “wanted to explore a relationship that was cloying and claustrophobic but emotionally hard to escape. An immersive, interactive VR environment seemed an ideal medium to recreate the tensions and emotions of such a relationship”.

“The Thing Growing” begins with a stark landscape in which a box is visible. Soon, the audience hears “Let me out” repeated in louder and louder tones. With instructions from the “voice” to use the remote control in the hands of their “leader”, the audience frees her with a key that the remote becomes as it is pointed toward the screen. She jumps out and exudes joy, praising the audience. After a few moments, villainous figures appear in the landscape and the voice begs the audience to save her. Again following the voice’s instructions, the audience, using their remote device which now looks like a gun, shoots the villains who disappear as they are hit. Again the voice expresses delight, suggesting that she and the audience leader dance. Once again giving instructions, this time by waving her arms up and down, she invites the leader to dance. If the leader does not move his remote in the manner she suggested, she complains loudly that the leader is not dancing with her. Depending on whether the leader “dances” or not, the voice becomes increasingly domineering and emotionally ruthless. After a time, the audience finds itself desperate to get out of the situation. Finally, again depending on the tactics of the leader, the

voice is either killed by the remote control which still has the capacity of a gun, or after a lengthy period, she dissolves.

This story does succeed in transporting many of its viewers. Members of the audience have shouted at the screen and demand for her to stop berating them. One viewers shouted, “get me out of here”. Most find the experience disconcerting and even embarrassing if they decide to kill the voice. Some leaders, including women, shot the voice without compunction and expressed delight at being rid of her. “The Thing Growing” website concludes its gloss on the VR story with the following passage:

We believe that the use of narrative techniques can enhance interactivity in VR. Andrew Glasner suggests that, for the construction of interesting computer fiction, the author should control the sequencing of events, and the creation of a causal chain of action. Therefore the narrative in *The Thing Growing* has the classical bridge structure of plays and films; act one introduces the protagonists and the goal; act two revolves around struggles to reach the goal; act three resolves those struggles. The difference in our case is that the user is one of the protagonists and in each act she is involved in interaction. The narrative as a whole is moved on either as a result of the user’s actions, or by time.

Although we did not obtain a grant to incorporate stories into Virtual Harlem, we did design a story format, though not as yet a very dramatic one since we did not have the narrative freedom Anstey had because we were doing an historical narrative. We commissioned two stories based on the format we designed. As the project stands, we have some preliminary evidence from surveys we have conducted that visitors to Virtual Harlem have reconfigured their view of African American culture as a result of their experience of Virtual Harlem. The more systematic evidence that *The Round Earth* project and certain uses of VR in medical fields can produce effective learning experiences combined with audience feedback from Virtual Harlem warrant its further development.

## 5. THE VIRTUAL HARLEM PROJECT

In *When Harlem Was in Vogue*, David Levering Lewis makes the case that the Harlem Renaissance is one of the most significant eras in African American cultural history. Harlem, NY, is commonly thought to be its cultural center.

The decade and a half that followed World War I was a time of tremendous optimism in Harlem. It was a time when Langston Hughes, Eubie Blake, Marcus-Garvey, Zora Neale Hurston, Paul Robeson, and countless others made their indelible mark on the landscape of American culture: African Americans made their first appearances on Broadway;

chic supper clubs opened on Harlem streets, their whites-only audiences in search of the ultimate “primitive” experience; riotous rent parties kept economic realities at bay while the rich and famous of both races” outdid each other with elegant, integrated soirees.

(Lewis, 1997, from the back cover of the paperback edition)

Until recently Harlem has been a forgotten site of American cultural history. Even today, its history remains largely unknown. This important cultural locale during the period that came to be known as the Harlem Renaissance needed to be represented as a part of the history of American culture. For this reason, Bryan Carter proposed that a VR representation of Harlem, NY in the 1930s would make a powerful component of courses in the Harlem Renaissance. The Advanced Technology Center at the University of Missouri accepted his proposal, which resulted in the creation of “Virtual Harlem”, one the earliest uses of VR technology as a way of telling history.

Virtual Harlem is a digital model of 1930s Harlem, N.Y., at the height of the Harlem Renaissance. At this point in time, the model includes about 10 blocks of Harlem out of the 20 or so that are associated with Harlem during its Renaissance. Virtual Harlem includes buildings such as the Savoy, the Lafayette Theatre, and the Cotton Club; the only building that can be entered. As visitors move through the streets, they can encounter several famous figures-Langston Hughes, Marcus Garvey, and Paul Robeson, as well as several residents of Harlem in the 1930s in routine activities. Cars and trolleys move up and down the streets. Inside the Cotton Club, one can watch several very brief performances. In sum, this seminal model already presents a rich, though incomplete, environment to visitors. The team that began the Virtual Harlem project at the University of Missouri was Bryan Carter, Bill Plummer, and Thaddeus Parkinson. Since 2001, when the project moved to UIC, the team that is now continuing to develop Virtual Harlem is: Bryan Carter, Jim Sosnoski, Andy Johnson, Jason Leigh, Steve Jones, Tim Portlock, Kyoung Park, and Chris White.<sup>6</sup>

The digital model of Virtual Harlem can be accessed through several delivery systems. The fullest version, the immersive CAVE environment (see above) requires visits to a lab such as UIC's Electronic Visualization Lab to experience the VR scenarios though it is available to be shown on the Immersadesk as well as on the AGAVE Geowall. Every effort has been made to allow for work done at the higher end to be translatable into programs at the lower end so that it can be circulated at locations that do not have high-end equipment. Even more important is the fact that work done at the lower end can be translated into higher end software. From a practical point of view, this enables students who have relatively modest experience with technology to contribute to the project and find their contributions shown in more sophisticated versions of Virtual Harlem. A 3D version of Virtual Harlem is available on the WWW. Several videotapes of Virtual Harlem tours are available and, upon



request, specific tours can be videotaped for particular groups. CD-ROMs of Virtual Harlem can also be made. Finally, web sites on Virtual Harlem are accessible through standard browsers the network's content.

An important aspect of the project is that it produces many versions of Harlem. This allows for alternative views of Harlem during its Renaissance. Constructing the definite Harlem is not the goal of the project. Instead, showing Harlem's past as one that has been constructed by its proponents and displaying the variety of perspectives that have been used in interpreting the Harlem Renaissance is its goal.

As a virtual experience of cultural history, the Virtual Harlem project serves as a prototype for similar projects being developed of the Bronzeville neighborhood in Chicago and Montmartre in Paris which are also significant sites for African American Culture in the 1930s. What is special about the Virtual Harlem project is that it is designed as a collaborative learning network—the builders of Virtual Harlem are collaborators in a network the aim of which is to learn about the Harlem Renaissance. Persons who are interested in the Harlem Renaissance or Harlem, NY. can contribute to the building of the model(s) as long as they follow the project's protocols. In addition, like other visualization projects (where models are constructed of the subject matter being studied), the cross-disciplinary collaboration is extraordinary (see below). These aspects of the project render it a potential prototype for other endeavors involving new instructional technologies.

As we envision it, a collaborative learning network (CLN) like virtual Harlem—because of its complex structure—requires that persons in the

network be both teachers and learners. The technical staff has to learn about the Harlem Renaissance from the non-technical staff. Similarly, the non-technical staff has to learn about the technologies of networking from the technical staff. It may be helpful in understanding the structure of a CLN to introduce the idea of a “learning pathway”. Sometimes discussions of learning seem to imply that learning takes place ONLY in a classroom. As we all know this is far from the case. We often learn more outside the classroom than in it about a particular subject. For this reason, and because the Virtual Harlem project requires students to go outside of their classrooms and visit other sites, we describe several typical learning paths (movements from site to site) that occur in the Virtual Harlem project. Let’s begin with a student taking a course in the Harlem Renaissance.

If we think of a learning pathway as a journey of discovery, then we might designate a conventional English literature classroom as the site of departure. A student may be assigned to read a work introducing the Harlem Renaissance as a period of literary history from her textbook. This would lead her home or to the library where the reading might take place before she returns to the classroom. This “trip” would be repeated many times in the learning path. At some point, that student may go to the immersion CAVE instead of the classroom and experience Virtual Harlem, followed by a trip to a computer center to record her response to it. If she decided as her term project to take on a research endeavor that culminated in adding some information, say about a building that was yet to be built in Virtual Harlem, this would necessitate a trip to the library and/or to a computer lab with internet access in search of photos and accounts of, say, the Dark Tower (an important salon). This decision would likely lead to the preparation of a research paper not only submitted to the instructor but also presented for “publication” in Virtual Harlem. Since a literature student or instructor would probably not be able to build a 3D Dark Tower into the VR scenario, the “publication” of the Dark Tower would be handled by someone who could.

The learning path of the literature student, in all likelihood, would have to intersect with the correlative learning paths of several other students before the Dark Tower could be added to Virtual Harlem. These intersections would “deepen” the learning experience to the extent that the students and instructors involved were in dialogue with each other. Without going into the same detail, I hope it is easy to imagine an engineering student beginning his learning path in a classroom on C++ in the Engineering building and at some later point taking on the project of constructing in 3D code the image of the Dark Tower as his term project. A third student in Fine Arts might start out in a computer graphics class in the School of Art and Design and follow a learning pathway that eventually intersected with the first two students adding an aesthetic dimension to the design. A Women’s Studies student might intersect with the group in an effort to portray the women in the Dark Tower setting accurately. If by collaborating they took perspectives on the materials that they would not

otherwise have considered into account, this circumstance would enrich their learning experience.

Since it would be tedious to read the details of the many additional learning pathways that might intersect or be juxtaposed to those we have mentioned, we ask you to imagine the likely collaborative learning pathways that would go into building the Dark Tower into the current cityscape. Envision, for instance, students with a history or cultural studies learning pathway intersecting with the learning paths we've identified. Consider students from psychology or sociology or urban anthropology who might be studying the impact that the Dark Tower is having on visitors to Virtual Harlem. And let's not forget the dramatic scripts that creative writers and theatre students need to write and enact in order to dramatize the events that took place in the Dark Tower.

These learning paths would also inevitably intersect with those of students from other universities who were researching the Dark Tower or some of the persons that were its habitual guests. If the learning paths did not intersect smoothly but, instead, clashed and contradicted each other, the learning would take another turn as students would then be forced to encounter perspectives they had never before engaged, a likely scenario as more universities from abroad join the network.

Though the network formed by the intersections of these varied learning paths has the potential to be quite volatile, it is nonetheless governed by the same set of research ideals its professorial constituents are advocating and the situation is potentially a mirror of any lively intellectual or discourse community, which Mary Louise Pratt aptly describes as a "contact zone". All the learning paths come into contact with each other because they all lead to Virtual Harlem. Ideally, all paths are attempts to visualize the past.

Within this framework, everyone in the network is both teacher and learner at some level or with respect to some area of study. The unusual combination of disciplines in the project—African American culture, literary, historical, urban, gender, social, anthropological, artistic, graphic, dramatic studies, communication, psychology, engineering, computer science, and visualization—mandates that no one person in the network will be the master of any one perspective. At the same time, the diversity of perspectives allows each person in the network to view the subject matter and the technology from a previously unfamiliar perspective. Moreover, since the project is based on VR scenarios at the higher end of the technological spectrum, a certain excitement is continuously generated, especially when persons enter the network and view the work that has been completed.

There are several features of the Virtual Harlem project that contribute significantly to its potential as an instruction technology. From the point of view of its subject matter, Virtual Harlem is a learning environment in which participants virtually experience a dramatic, visual history centered in Harlem, New York during its "Renaissance" period. From the point of view of the mode of learning, Virtual Harlem is an environment that enables a subject matter



like the Harlem Renaissance to be studied by modeling its historical context as a dynamic system of social, cultural, political, and economic relations, that is, as a “neighborhood”. From the point of view of learning outcomes, Virtual Harlem is an environment that configures its visitors as a set of cultural counter-stereotypes.

Because of its subject matter—the Harlem Renaissance—this project has the potential to link scholars and students from all over the world who are studying and researching African American culture into a learning network. At the time of writing, nine universities and one super computer center are associated with the Virtual Harlem network: University of Illinois at Chicago (UIC), Central Missouri State University (CMSU), the University of Missouri-Columbia (MU), the University of Arizona (UA), Columbia University (CU), Växjö University, Sweden, Morgan State University (MSU), Vassar College (VC), the Sorbonne IV, Paris, and the SARA Super Computing Lab in Amsterdam. Several of these universities have already been linked to each other for discussions of the Harlem Renaissance in connection with courses about it. The Virtual Harlem CLN also has the potential to introduce learners to systems thinking and visual thinking, two evolving modes of intellection that have come to the forefront as educational goals due to the increasing availability of computer assisted learning (Park et al., 2001; Sosnoski & Carter, 2001).

As a consequence of interest in the Virtual Harlem project, the ASCEND network was created to link universities to other types of learning centers, for example, to small science museums.

## 6. VIRTUAL HARLEM AND THE SMALL SCIENCE MUSEUM LEARNING ENVIRONMENT

SciTech Hands On Museum located in (Aurora IL, U.S.A., just west of Chicago) joined the ASCEND network in 2001 to test and evaluate the VR hardware and software developed at EVL. By the summer of 2002 the first museum prototype VR learning lab was established at the museum with a Geowall on loan from EVL. SciTech’s VR lab is beginning the process of testing and evaluating VR environment as it applies to museum visitors. Based on initial positive results, it is foreseen that the SciTech pilot implementation of VR will be expanded to other science museums in the near future. The team that is developing VR environments for small science museums in collaboration with EVL is: Ronen Mir, Diana Zajicek, and Sammy Landers from SciTech Hands On Museum, Aurora IL USA. Marcelo Milrad from Växjö University, Sweden, in association with Xperiment Hus, is engaged in extending the project to small science museums in Europe.

In the summer of 2002, VR Technology was brought to SciTech by a team from EVL headed by Andy Johnson and Jason Leigh. The lab for the VR set up is a 17' × 20' room used previously as a computer class. The first thing

that we did was to paint the room a dark color to give the feeling of entering a theater. Next, we made and framed an opening in one of the walls in the enclosed space to house the screen. The computer is located in the enclosed space with the projectors. The monitor, the keyboard, and the mouse are out at a station for the operator to use when setting up for a show. The last thing that we did was to install a curtain to keep ambient light from entering the viewing area. In a short time, the renovation of a room to use as a VR lab and the installation of VR equipment was completed.

The VR set up at SciTech has the following specifications:

screen; 5' long, 4' high

user area; 9' × 6'

rear projection (This system looks a lot better and makes a better experience since the viewer can get closer to the screen)

“starter” 3D model viewer application

rear projection requires 10' behind the screen for the projectors

dark room not necessary, but dimly lit is preferred

best to stand about 4' back from the screen for viewing

PC (Windows XP and Linux 7.2 ) platform used at SciTech

This system consists of joystick-controlled navigation of a set of 3D models a stereo projection upon a 6' screen, viewed with special polarized glasses.

We found it necessary to have a staff member to run programs and assist visitors.

The first phase of VR presentation at our site is ongoing and has consisted mainly of short, less than 30 minutes, VR sessions, in which a trained museum staff member has introduced the concept of VR to a variety of visitors to the museum, museum staff, and board members. This introductory session has included: definitions of VR, a short explanation of the operation of the system in use at SciTech, an opportunity for viewers to manipulate the 3D models themselves. During the exploration of the available models, a trained SciTech staff member provides commentary about the models viewed, and answers questions. At the conclusion of this session, an informal evaluation of the experience is conducted and results recorded.

Since the VR equipment has been up and running, the VR lab has had approximately 500 visitors, a fairly even mix of adults and children, ranging in age from 7 to 75 years of age. Their comments on the experience have included both positive reactions: “Enjoyed it very much”!, “It was a wonderful thing”, “Very cool”! “Loved it”!; “It was good”; and critical ones: “. . . makes the stomach queasy if you move around a lot”; “. . . liked all the different models”; “I think you should put chairs (in)”. The development of educational programming is underway. Several approaches to the use of VR are being considered. Descriptions of two scenarios follow.

There are noteworthy limitations to the current VR set up at SciTech. Our set-up is fairly rudimentary. At the present time, the number of applications that can be deployed to SciTech is restricted because we can only run environments that are based on OpenGL or OpenInventor. Most of the VR worlds are still built on the Silicon Graphics machines, so there is a certain amount of work needed to port them to a personal computer. On the less technical side, the room in which SciTech's VR set up is housed is small limiting group size to 6–8 people. We find it difficult to stop people from touching the screen, which destroys its ability to preserve the passive polarization. Simulator sickness may be an issue. Projector based systems have a much lower rate of simulator sickness than head mounted displays and having a non-tracked system definitely reduces the amount even further, but a visitor can still get sick from watching a friend play a first-person shooter, so odds are that this will make a small percentage of people sick. Therefore we are showing 3D models floating in space rather than terrain to explore. We need to consider seating or a railing.

As part of SciTech's mission to make technology and science concepts accessible and exciting through exploration and discovery, an experience based on the concept area of perception is one avenue for development. This would include: definition of perception, types of perception, scientific methodology, avenues of investigation, scientific tools, types of models, VR as a tool for exploration, and manipulation of the world around us.

A second area of development focuses on the content related to the VR 3D models at our disposal. At present, these models include: an ant, a bee, Round Earth, The Solar system, The Wright Brothers Airplane, A Human Heart, and Lungs. A model-based experience would address SciTech's goal to enhance the public understanding of science and demonstrate its relevance in everyday life. This experience would be based on exploration of and hands-on activities relating to a pre-selected 3D model, e.g., the heart. The organizational model would be a series of exploration stations through which the learners would proceed in small groups. The stations could include: manipulation of 3D VR heart-lung model, internet virtual field trip; e.g.—a trip down a coronary artery, brief description of circulatory system, perhaps a video, create a poster of the heart and lungs using an overhead projection, create a simple lung model from a soda bottle, balloons, etc., heart rate, pulse and exercise activity web worksheet directed research, students model the heart and blood flow using themselves as parts of the model, tennis ball heart action simulation.

Our long-term VR goals include:

The construction of a dedicated VR environment on SciTech's main floor, and the development of additional educational programs to be used therein.

Expansion of VR experience to include not only science and technology, but also the areas of art, history and entertainment.

Implementation of similar systems in other museums with which SciTech collaborates.

Complementing the ASCEND experiments in non-university learning environments like SciTech, are experiments with non-academic technologies such as computer games.

#### 7. VIRTUAL HARLEM AND THE LEARNING GAMES INITIATIVE

We regard computer games as virtual learning environments. The technology behind computer games runs in parallel with the technology behind VR applications. Virtual Harlem, for example, can be seen on a game engine and in collaboration with the Virtual Harlem project team, we have been considering introducing dramatic elements into the cityscape drawing upon game design. In collaboration with the ASCEND network, the Learning Games Initiative (LGI) team at the University of Arizona (Ken McAllister, David Menchaca, and Ryan Moeller) is working to accomplish three objectives:

1. Study: members of LGI use a variety of multi-disciplinary analytical techniques to reveal and understand the ways in which sociocultural tensions are embedded in, imposed upon, and taught through games;
2. Teach: members of LGI work to develop pedagogies that teach these analytical techniques to students so that as computer games become ubiquitous and their ideologies are naturalized in players, students will have a set of critical skills that they may use to critique them;
3. Build: members of LGI work to develop new games that draw upon their critique-oriented knowledge of computer games in order to generate new and more complex opportunities for game developers and game players.

Each of these areas is deeply informed by a wide range of multidisciplinary research, including sociology, cultural history, graphics programming, audio engineering, rhetorical studies, political science, music composition, media arts, communications, literary studies, philosophy, military science, pedagogy, organizational studies, and graphic design. In the remainder of this section, we will briefly discuss some of the current research and useful practices employed by LGI and others in these three areas.

There are basically two points of entry for the study of computer games: the point of production and the point of consumption. In both cases, there is a wealth of available material for scholars to examine, some of it originating in the academy and some in the materials circulating in the gaming industry. On the academic side, work that studies the psychophysiological nature of computer game playing (e.g., research on how computer games shape players' minds and bodies) is particularly abundant. It is in this area that one finds the

dozens of studies attempting to discover causal relationships between computer game play and sociopathic and behavioral problems, the research on a variety of physical ailments caused by computer games (e.g., repetitive motion disorders and seizures), and the research on how computer games may or may not facilitate non-game related skill acquisition (e.g., accurately assessing collision probabilities, effectively interacting with complex dynamic systems, and the improvement of mental focus). Related to this is the application of anthropometrics to the development of alternative input/output devices and channels.

An emerging area of research in the academy focuses on the cultural implications of computer games, and studies, for example, how race, gender, sexual orientation, and class are constructed in particular games. Much of this research is to be found in academic publications like the journal *Game Studies* and *The Journal of Popular Culture*, although there are an increasing number of book-length treatments of these topics. Initially, members of LGI have focused their efforts on studying and applying multidisciplinary approaches to the study of computer games. Additionally, LGI members work to harness the learning elements inherent in computer game play to enhance the study of topics unrelated to game content—for instance, using computer game interactivity to study collaboration, communication, role-playing, task-oriented decision-making, analytical and organizational skills, and so on.

Most academics interested in studying computer games have not had the luxury of formal training in this area (e.g., “game studies”). Rather, they tend to be scholars who are naturally inclined to interdisciplinary work in interactive media, and as a loose collective comprise a rapidly advancing area of research and teaching. Much like the structure of Film Departments to which they are sometimes compared, the fledgling academic programs to which these teacher-scholars migrate tend to combine the technical skills of development with the critical skills of close technical, aesthetic, historical, and cultural analysis. Some programs emphasize certain skills over others due to particular resources available on different campuses: Some programs emphasize game programming, while others specialize in visual studies, narratology, or music. Increasingly, however, academic programs are being developed that consist of multiple tracks that combine basic programming skills (especially the mastery of scripting languages, such as Lingo and Actionscript for Macromedia Director and Flash, respectively) with advanced design concepts, or vice versa: advanced programming skills with basic design concepts. In programs such as these, both tracks culminate in the development of a playable computer game.

The Learning Games Initiative at the University of Arizona takes a somewhat different approach than other programs by focusing first on “reading” games as complex techno-cultural artifacts, then using these “reads” to build provocative educational games. LGI members are concerned with how games

manifest various sociocultural dynamics through the design of non-player characters, level and interface design, types of interactivity, placement and content of cut scenes, audio effects and music choices, point of view and camera placement, and so on. This deeply interdisciplinary work requires its members to have a broad range of both analytical and technical skills. For this reason, LGI members rely upon their peer practitioner-scholars to learn, for instance, how an OpenGL programmer “sees” a game, or how a poet or priest “reads” a game’s metaphors and justificatory logics. As a result of their ability to see computer games in such an unusually expansive way, LGI members are then able to teach these ways of seeing to their students.

The mechanisms behind this educational process are straightforward. LGI members participate in collective knowledge building by sharing research and teaching techniques via an electronic forum, and they meet twice a month for “Game Night”, an opportunity for LGI participants to gather face to face and closely examine a particular game. From these two practices have emerged a variety of pedagogical tools that concern computer games, including instructional videos, how-to guides, course curricula, conference talks, and the development of educational game mods built from commercial game engines like *Quake* and *Neverwinter Nights*.

The third point of entry to studying computer games exists at the point of production. Here, LGI relies upon methodologies suggested by anthropologists and artifact historians: Investigate the techniques of production in order to extrapolate and interpret the cultural ideologies that support and inform such techniques.<sup>7</sup> LGI incorporates the research and teaching of its members into the actual production of complex educational games using a variety of commercial game engines. LGI wants to know what can be learned about computer gaming and classroom space, for example, especially when the latter has been reproduced digitally, using software designed to support a first-person shooter like *Quake* or a role-playing game like *Neverwinter Nights*.

LGI members hold that participation in the construction process is a vitally important part of gaining a complex cultural understanding of computer games. Such an understanding makes visible the constraints and operating assumptions of commercial game production—including, for example, issues concerning audience, content, timeliness, complexity, and playability. It also provides participants with an intimacy with production techniques uncommon in more traditional artifact studies, which are often removed in time, space, and circumstance from an artifact’s method of production.

The study and use of computer games in educational settings works to enable students to develop the skills necessary to critically examine all aspects of game design. By understanding computer games as both commercial artifacts and as components in a much more complex sociocultural dynamic—that is, a material object that is continually reconstructed in play—students simultaneously learn the skills necessary to critique all those other elements of popular

and specialized culture in which elements of Vr are used to shape belief and manufacture knowledge.

Since its creation in 1996, the Virtual Harlem project grown into a research network. Our belief is that the project demonstrates the vital importance of VR instructional technology to the humanistic disciplines.

#### 8. CONCLUDING REMARKS: CONFIGURING THE PAST

Virtual Harlem is a visual history. Techniques of computer simulation and visualization have been developed to the point that it is now possible to present historical events in virtual space and time, not only showing the location of the event but also tracking it through a temporal sequence. Virtual Harlem, for example, is the most important historical location for events that comprise what literary historians refer to as the Harlem Renaissance. Technically, it is possible to show temporal sequences, or, for example, one can visit Virtual Harlem during the day and then later at night. Although, the project has not yet developed to this point, we plan to show the historical changes in Harlem from the 1920s to the mid-1930s. Concomitantly, we intend in our design to show the periods within the Harlem Renaissance that correspond to those changes by indicating the development or demise of movements and periodicals, the migration of artists and musicians, the changes in the character of the neighborhood.

Virtual Harlem is a dramatic presentation of the history of the Harlem Renaissance. Scripts of everyday life are built into the presentation to dramatize the historical events (see Sosnoski/Portlock). Students can interact with figures that “live” in Virtual Harlem and whose character and behavior are as historically accurate as we can make it. Though such experiences are fictive by definition, the dramatizations are governed by an effort to interpret what it felt like to live in Harlem during the 1930s and to encounter the many great artists who worked there. While admittedly an unconventional form of history telling, whose historiography has yet to be developed, every effort is being made to give students an experience of the past that matches scholars’ interpretation of it. The governing genre in this endeavor is history, not fiction, not even historical fiction. The fictive elements arise from the absence of video or audio documentation. Whereas it is possible to write sentences such as “residents of Harlem could purchase the ‘Crisis’ at a local news stand, a dramatization of that event requires a specific figure to approach the news stand and ask for a copy of the ‘Crisis’ ”. Since we do not have photographs of that event or recordings of what was said, that figure in Virtual Harlem cannot not represent a actual person who lived in Harlem at the time. Yet, to dramatize the historical generalization (residents purchased the ‘Crisis’ at local news stands) does not entail the genre of fiction. The stories told in Virtual Harlem are governed by historical constraints.

Hypothetically, Virtual Harlem is a “dynamic system of relations”. Virtual Harlem is comprised of many elements: buildings, people, cars, events, communications, markets, and other phenomenon. These elements can be understood as a “neighborhood”, a dynamic system of relations. People live in buildings, pay rent, buy goods, make decisions, respond to injunctions, talk, sing, dance, drive, and involve themselves in multifarious relations with the other elements in the immediate environment. Computer models allow for the computation of a variety of possible systemic relations and provide a way of understanding the historical period. “Systems dynamics” has been used for years as an instructional technology both in this country and abroad. This approach, as we tried to suggest above, is built into Virtual Harlem.

From another perspective, the Virtual Harlem project is a project in “urban archeology”. We have plotted out the surface of historical Harlem and drawn a map of its topography. At various locations on the map, we have dug deeper into its history to obtain a closer look at the development of that site. For example, whereas some buildings are no more than facades to mark the space they occupied at a particular moment in history, others can be explored in much more depth of detail. What the researchers unearth about a particular place, is then recreated virtually. As a representation of a “neighborhood” in a city, the Virtual Harlem project can be extended to other neighborhoods in New York City. As a representation of a city, the Virtual Harlem project can be extended to other cities and their neighborhoods.

The significance of the Virtual Harlem project is the use of VR technology to model a humanistic subject. It opens the door not only to new modes of learning but also to new modes of historiography and interpretation as well as inter-disciplinary collaboration.

#### ENDNOTES

1. Configuring is a cognitive process through which persons create virtual experiences by re-assembling their past experiences into one that provides an analogous pattern to the one they are presented in VR applications or other modes of simulation ranging from TV and film to literary and artistic artifacts. See Sosnoski forthcoming.
2. See <http://www.ncecho.org/>.
3. See <http://www.fullscreenqvr.com/minavaticano01-10.html>.
4. See <http://www.cvrllab.org/>.
5. See <http://www.ccr.buffalo.edu/anstey/VDRAMA/THING/index.html>.
6. The remarks in this section are those of the authors who were on the Virtual Harlem teams. However, not all of the members of the project were involved in the decisions made or theories developed that are mentioned in this section. The project leaders were Bryan Carter, creator and director of the project, and Jim Sosnoski, coordinator and instructional theorist.



Steve Jones has been a key member of the project since it came to UIC and an invaluable consultant. Ken McAllister and Ryan Moeller brought the Virtual Harlem project to the University of Arizona and were instrumental in the development of the ASCEND network. Ronen Mir is the Director of the SciTech Hands on Small Science Museum and brought UIC VR projects to it in collaboration with Jim Sosnoski, Andy Johnson, and Jason Leigh (Sosnoski & Carter, 2001; Johnson et al., 2002).

7. Such a methodology is forwarded by Marcia-Anne Dobres in “Technology’s Links and *Chaînes*: The Processual Unfolding of Technique and Technician”. *The Social Dynamics of Technology: Practice, Politics, and World Views* (Ed.) Marcia-Anne Dobres and Christopher R. Hoffman (Washington, DC: Smithsonian, 1999), 124–146.

#### SELECTIVE BIBLIOGRAPHY

- Booth, W.C. (1988). *The Company We keep: An Ethics of Fiction*. Berkeley: University of California Press.
- Bryant, J. & Zillman, D. (Eds.) (1994). *Media Effects: Advances in Theory and Research*. Hillsdale, NJ: Lawrence Erlbaum Associates.
- Dadds, M.R., Bovbjerg, D.H., Reed, W.H., & Cutmore, T.R.H. (1997). Imagery in human classical conditioning. *Psychological Bulletin* 127, 89–103.
- DeFanti, T., Sandin, D., Brown, M., Pape, D., Anstey, J., Bogucki, M., Dawe, G., Johnson, A., & Huang, T. (1999). Technologies for Virtual Reality/Tele-Immersion Applications: Issues of Research in Image Display and Global Networking. *EC/NSF Workshop on Research Frontiers in Virtual Environments and Human-Centered Computing*, Chateau de Bonas, France: Springer Verlag. 06/01/1999–06/04/1999.
- Gamson, W.A. (1992). *Talking Politics*. Cambridge, UK: Cambridge University Press.
- Gerbner, G., Gross, L., Morgan, M., & Signorielli, N. (1994). Growing up with television: the cultivation perspective. In: Bryant, J. and Zillman, D. (Eds.) *Media Effects: Advances in Theory and Research*. Hillsdale, NJ: Lawrence Erlbaum Associates, 17–42.
- Green, M.C. & Brock, T.C. (2002). In the mind’s eye: transportation-imagery model of narrative persuasion. In: Green, M.C., Strange, J.J. and Brock, T.C. (Eds.) *Narrative Impact: Social and Cognitive Foundations*. London: Lawrence Erlbaum Associates, 315–341.
- Green, M.C., Strange, J.J., & Brock, T.C. (Eds.) (2002). *Narrative Impact: Social and Cognitive Foundations*. London: Lawrence Erlbaum Associates.
- Green, M.C. & Brock, T.C. (2000). The role of transportation in the persuasiveness of public narratives. *Journal of Personality and Social Psychology* 79, 701–721.
- Iyengar, S. & Kinder, D.R. (1987). *News that Matters: Television and American Opinion*. Chicago: University of Chicago Press.
- Johnson, A. & Leigh, J. (2001). Tele-immersive collaboration in the CAVE research network (chapter). *Collaborative Virtual Environments: Digital Places and Spaces for Interaction*, 225–243.
- Johnson, A., Leigh, J., Carter, B., Sosnoski, J., & Jones, S. (2002). *IEEE Computer Graphics, Art History, and Archaeology*. September/October, 1–8.

- Johnson, A., Moher, T., & Ohlsson, S. (1999a). The round earth project-collaborative VR for elementary school kids. *SIGGRAPH 99 Conference Abstracts and Applications*, Los Angeles, CA, 08/08/1999–08/13/1999, 90–93.
- Johnson, A., Moher, T., Ohlsson, S., & Gillingham, M. (1999b). The round earth project: collaborative VR for conceptual learning. *IEEE Computer Graphics and Applications* 19(6), 60–69.
- Johnson, A., Moher, T., Ohlsson, S., & Gillingham, M. (1999c). The Round Earth Project: Deep Learning in a Collaborative Virtual World, *Proceedings of IEEE VR '99*, Houston, TX, 03/13/1999–03/17/1999, 164–171.
- Johnson, A., Roussou, M., Leigh, J., Barnes, C., Vasilakis, C., & Moher, T. (1998). The NICE Project: Learning Together in a Virtual World. *Proceedings of VRAIS '98*, Atlanta, GA, 03/14/1998–03/18/1998, 176–183.
- Lascara, G., Wheless, G., Cox, D., Patterson, R., Levy, S., Johnson, A., & Leigh, J. (1999). TeleImmersive Virtual Environments for Collaborative Knowledge Discovery. *Proceedings of the Advanced Simulation Technologies Conference '99*, San Diego, CA 04/11/1999–04/15/1999.
- Leigh, J., Johnson, A., DeFanti, T., et al. (1999). A Review of Tele-Immersive Applications in the CAVE Research Network, *Proceedings of IEEE VR '99*, Houston, TX 03/13/1999–03/17/1999, 180–187.
- Lewis, D.L. (1997). *When Harlem was in Vogue*. New York: Penguin Books.
- Nell, V. (1988). *Lost in a Book: The Psychology of Reading for Pleasure*. New Haven, CT: Yale University Press.
- Nell, V. (2002). Mythic structures in narrative: the domestication of immortality. In: Green, M.C., Strange, J.J. and Brock, T.C. (Eds.) *Narrative Impact: Social and Cognitive Foundations*. London: Lawrence Erlbaum Associates, 17–37.
- Nokes, T. (2004). *Investigating Multiple Mechanisms of Knowledge Transfer*. Accessed 2004. Power Point Presentation.
- Nokes, T. & Ohlsson, S. (2001). How is Abstract, Generative Knowledge Acquired? A Comparison of Three Learning Scenarios. In: Moore, J.D. and Stenning, K. (Eds.) *The Twenty Third Annual Conference of the Cognitive Science Society*, Erlbaum, 710–715.
- Ohlsson, S., Moher, T., & Johnson, A. (2000). Deep Learning in Virtual Reality: How to Teach Children that the Earth is Round. *Proceedings of the 22nd Annual Conference of the Cognitive Science Society*, Philadelphia, PA, 08/13/2000–08/15/2000, 364–368.
- Park, K., Cho, Y., Krishnaprasad, N., Scharver, C., Lewis, M., Leigh, J., & Johnson, A. (2000). CAVERNsoft G2: A Toolkit for High Performance Tele-Immersive Collaboration. *Proceedings of the ACM Symposium on Virtual Reality Software and Technology*, Seoul, Korea, 10/22/2000–10/25/2000, 8–15.
- Park, K., Leigh, J., Johnson, A., Carter, B., Brody, J., & Sosnoski, J. (2001). Distance Learning Classroom Using Virtual Harlem. *In the Proceedings of the Seventh International Conference on Virtual Systems and Multimedia (VSMM 2001)*, Berkeley CA, Oct 25–27, 489–498.
- Roussou, M., Gillingham, M., & Moher, T. (1998). Evaluation of an Immersive Collaborative Virtual Learning Environment for K-12 Education. *American Educational Research Association Annual Meeting (AERA)*, San Deigo, CA, 04/13/1998–04/17/1998.
- Roussou, M., Johnson, A., Leigh, J., Barnes, C., Vasilakis, C., & Moher, T. (1997a). NICE: Combining Constructionism, Narrative, and Collaboration in a Virtual Learning Environment. *Proceedings of the 1997 SIGGRAPH Educator's Program—Computer Graphics*, 08/01/1997–08/01/1997, 62–63.
- Roussou, M., Johnson, A., Leigh, J., Barnes, C., Vasilakis, C., & Moher, T. (1997b). The NICE Project: Narrative, Immersive, Constructionist/Collaborative Environments for Learning

- in Virtual Reality. *Proceedings of ED-MEDIA/ED-TELECOM '97*, Calgary, Canada, 06/14/1997–06/19/1997, 917–922.
- Roussou, M., Johnson, A., Moher, T., Leigh, J., Vasilakis, C., & Barnes, C. (1999). Learning and building together in a virtual world. *Presence* 8(3), 247–263 (MIT Press).
- Sosnoski, J. & Carter, B. (Eds.) (2001). *Virtual Experiences of the Harlem Renaissance: The Virtual Harlem Project. Works & Days* 37/38 19(1, 2), Spring/Fall.
- Sosnoski, J., Harkin, P. & Carter, B. (Eds.). *Configuring History: Teaching the Harlem Renaissance Through VirtualReality Cityscapes*. In: Jones, S. (Ed.) *Digital Formations*. New York: Peter Lang, forthcoming.

# Chapter 55: Video-as-Data and Digital Video Manipulation Techniques for Transforming Learning Sciences Research, Education, and Other Cultural Practices\*

ROY D. PEA

*Stanford University, Stanford Center for Innovations in Learning*

## 1. INTRODUCTION

This chapter concerns the theoretical and empirical foundations and current progress of the Digital Interactive Video Exploration and Reflection (DIVER) Project at Stanford University. The DIVER Project aspires to accelerate cultural appropriation of video as a fluid expressive medium for generating, sharing, and critiquing different perspectives on the same richly recorded events and to work with others to establish a Digital Video Collaboratory (DVC) that enables cumulative knowledge building from video-as-data for discovery and commentary. These uses of digital video manipulation are very distinctive from those used in virtual-learning environments today across K-12, higher education, and corporate training (e.g., BlackBoard, WebCT, PlaceWare), which are primarily video clips that are used to illustrate a point or concept during a lecture or a video of a faculty member teaching and using PowerPoint slides.

The DIVER system distinctively enables “point of view” authoring of video tours of archival materials (from video to animations and static imagery) in a manner that supports sharing, collaboration, and knowledge building around

\* DIVER™, WebDIVER™, Dive™, and “Guided Noticing”™ are trademarks of Stanford University for DIVER software and affiliated services with patents pending. The DIVER project work has been supported by grants from the National Science Foundation (#0216334, #0234456, #0326497, #0354453) and the Hewlett Foundation. Any opinions, findings, and conclusions or recommendations expressed in this material are those of the author and do not necessarily reflect the views of these funders. Roy Pea served as lead author with contributing authors Ken Dauber, Michael Mills, Joseph Rosen, Wolfgang Effelsberg, and Eric Hoffert for portions of earlier versions of some of the text material provided here regarding DIVER. Ray Pacheone, Randall Souviney, and Peter Youngs have been instrumental in our thinking of DIVER in the teacher preparation and certification context. Brian MacWhinney was an additional key collaborator in conceptualizing the Digital Video Collaboratory characterized in Section 8.0.

a common ground of reference. A fundamental goal is user-driven content re-use, prompted by the desire of content users to reinterpret content in new ways, and to communicate and share their interpretations with others, for purposes ranging from e-learning to entertainment.

DIVER makes it possible to easily create an infinite variety of new digital video clips from a video record. A user of DIVER software “dives” into a video record by input controlling—with a mouse, joystick, or other input device—a virtual camera that can zoom and pan through space and time within an overview window of the source video. The virtual camera dynamically crops still image clips or records multiframe video “pathways” through normal consumer 4:3 aspect ratio video or a range of parameters (e.g., 20:3) for video records captured with a panoramic camera,<sup>1</sup> to create a dive<sup>TM</sup> (a DIVER worksheet). A dive is made up of a collection of re-orderable “panels”, each of which contains a small key video frame (often called a “thumbnail”) representing a clip as well as a text field that may contain an accompanying annotation, code, or other interpretation.

After creating a dive using the desktop DIVER application, the user can upload it onto WebDIVER<sup>TM</sup>, a website for interactive browsing, searching, and display of video clips and collaborative commentary on dives. In an alternative implementation, one can dive on streaming video files that are made accessible through a web server over the internet, without either requiring the downloading of a DIVER desktop application or the media files upon which the user dives.

In the desktop DIVER implementation, the dive itself is packaged automatically as an Extensible Markup Language (XML) document with associated media files. XML is the universal language approved in 1998 by the World Wide Web Consortium (W3C) for structured documents and data on the web. The web representation of the dive includes the key frames, video clips, and annotations. A dive can be shared with colleagues over the internet and become the focus of knowledge building, argumentative, tutorial, assessment, or general communicative exchanges. A schematic representation of the recording, “diving”, and web-sharing phases is shown in Figure 1.

Much of our primary DIVER work involves scenarios in which a video camera is used to record complex human interactions such as the behavior of learners and teachers in a classroom, or research group meetings. One may capture video directly into DIVER using DIVER’s MovieMaker feature with a digital video camera connected by FireWire to the computer, or use DIVER’s MovieImporter feature to bring in as source material previously captured video. A 360° camera may also be used to capture panoramic video of the scene—but before discussing the rationale for panoramic video recording, it is important to establish why it is that video-as-data and digital video manipulation techniques such as those that DIVER represents are critical for transforming learning sciences research and educational practices.

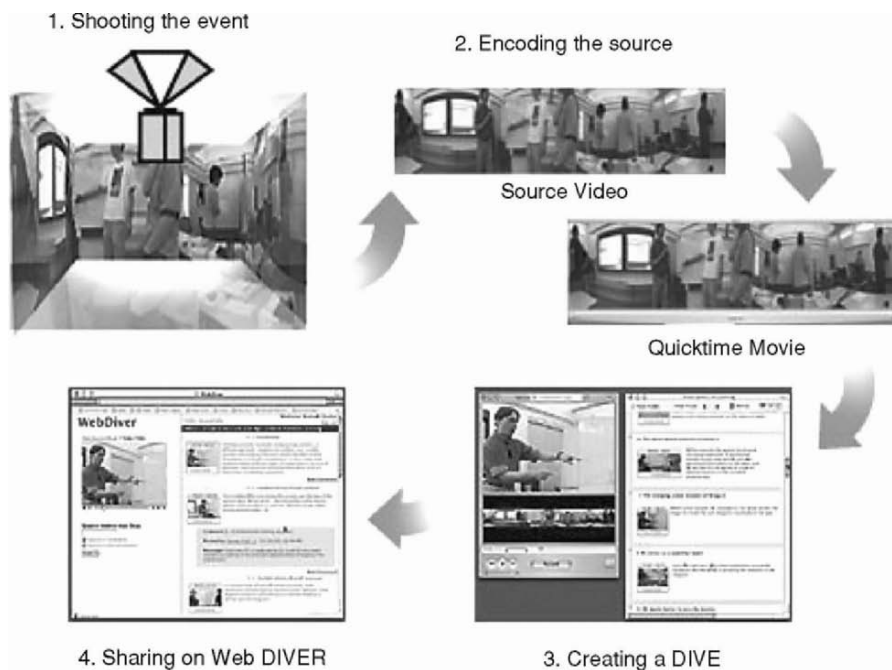

Figure 1. Overview of the DIVER video exploration and reflection system.

## 2. POWER OF VIDEO-AS-DATA FOR HUMAN INTERACTION ANALYSIS AND REFLECTIVE USES FOR PURPOSES OF LEARNING, TRAINING, AND EDUCATION

### 2.1. Situated Learning

In recent years, there has been increasing recognition that human activities such as learning need to be understood in the context of their naturalistic situations and socio-cultural environments (e.g., Brown, 1992; Brown et al., 1989; Lave, 1993; Pea, 1993; Resnick, 1987). Over this period, the learning sciences have shifted from a view of learning as principally an internal cognitive process, toward a view of learning as “mind in context”—a complex social phenomenon involving multiple agents interacting in social and organizational systems, with one another, and with symbolic representations and environmental features (Bransford et al., 2000; Greeno & MMAP, 1998; Hutchins, 1995; Pea, 1993).

This orientation to “learning environments”—the concrete social and physical settings in which learning takes place—has led researchers to utilize tools that allow capture of the complexity of such situations, where multiple simultaneous “channels” of interaction are potentially relevant to achieving a full understanding of learning or other human interactional phenomena. For

100 years, researchers have experimented with using multimedia records—first film, then analog videotape, and now digital audio and video—to gather richer and more reliable data about complex social interaction than is possible with traditional alternatives like field notes, participant recollections, and transcripts of audio recordings. These technologies are attractive for their potential in making a relatively complete record for re-use and for sharing among multiple researchers, without the inconvenience and intersubjectivity problems of recording methods like field notes. But capturing and working with video records, until the rapid technological developments of the last two decades, required access to equipment and skills that relatively few researchers sought to acquire. The consumer revolution in video technology has lowered this barrier in making sophisticated, easy to operate, cost-effective recording tools broadly available.

Uses of such audio and video records have been instrumental in theoretical developments by researchers contributing to this “situated shift” in studies of learning, thinking, and human practices. This development was deeply influenced by conversation analysis (Goodwin & Heritage, 1990), sociolinguistic studies of classroom discourse (Mehan, 1978), by ethnographic and anthropological inquiries of learning in formal and informal settings (Erickson, 1992; Lave, 1988; Rogoff, 1990; Rogoff & Lave, 1984; Saxe, 1988; 1991) and ethnomethodological investigations (Garfinkel, 1967) as well as studies of non-verbal behavior such as gaze (Argyle & Cook, 1976), body orientation/kinesics (Birdwhistell, 1970), and gesture (Kendon, 1982). These foundations are evident in Jordan and Henderson’s (1995) influential paper on interactive video analysis—in research labs throughout departments of psychology, sociology, linguistics, communication, (cultural) anthropology, and human-computer interaction, researchers work individually or in small collaborative teams—often across disciplines—for the distinctive insights that can be brought to interpretation during the analysis of video recordings of human activities.

Thanks to these socio-technical developments, interdisciplinary studies utilizing video have deepened our understanding in many learning science sub-fields such as mathematics thinking, learning, and teaching (Greeno & MMAP, 1998; Lampert & Loewenberg-Ball, 1998; Schoenfeld, 1992), functions of teacher activities (Frederiksen et al., 1998), international comparative studies of videos of mathematics classrooms (Stigler & Hiebert, 1999; Stigler et al., 1999; 2000); learning of demanding topics in high school physics (Pea, 1992; Roth & Roychoudhury, 1993), informal learning in science museums (Crowley et al., 2001; Stevens & Hall, 1997), interacting with machines such as copiers, computers, and medical devices, suggesting new design needs (Nardi, 1996; Suchman, 1987; Suchman & Trigg, 1991; Tang, 1991), collaborative learning (Barron, 2000; 2003), and of specific roles for gestural communication in teaching and learning (Roth, 2001a, b). The pervasive impact of video studies was in evidence at the 2002 American Educational Research

Association meetings, which included 44 scientific panels and symposia using video for learning research, teaching, and teacher education (with comparable levels in 2005).

The availability of such inexpensive videography equipment and promise of more complete records of complex phenomena than earlier methods has led many researchers to adopt video recording as a primary data collection method. Yet, there is a serious and persistent gap between such promise and the usefulness of video records. Video data circulates rarely and slowly within scientific research communities, even as more researchers use the medium. Video research analyses are typically restricted to text-only displays for presenting findings; original data sources are not made available for re-analysis by other researchers; and it is typically impossible for collaborators working at different sites to conduct joint analysis of shared video records. Several workshops have documented the needs for much better tools for powerful video capture and analysis technologies to support studies of learning and instruction (Lampert & Hawkins, 1998; MacWhinney & Snow, 1999; Pea & Hay, 2003). This gap between the promise and reality of digital video yields continued problems by obscuring the connection between evidence and argument, discourages sharing of video data, and impeding the development of shared examples of exemplary analyses using video that could serve training and socialization functions for novice researchers (Pea & Hoffert, in press).

## 2.2. E-Learning

Furthermore, over the last several years, there have been a number of projects in research and industry whose goal is to advance the use of video and computer technologies to study the complex interactions underlying classroom learning. For example, the *Classroom 2000* project (Abowd, 1999) developed a system for recording many aspects of a live classroom experience—including the capture of strokes on a whiteboard—and making these recordings subsequently available to students. *Teachscape* ([www.teachscape.com](http://www.teachscape.com)) and *Lesson-Lab* ([www.lessonlab.com](http://www.lessonlab.com)) are commercially available products whose web-based platforms allow teachers and other professionals to study and discuss videos and other artifacts of classroom practice, as face-to-face resources or over the internet. There are many teacher education projects that utilize some form of digital video records to provide case-based learning approaches for learning at different points in the teacher professional development continuum, including Indiana University's Internet Technology Forum (Barab et al., 2001; 2002; 2003), University of Michigan's KNOW system (Fishman, in press), San Diego State University's Case Creator (Doerr et al., 2003), and Northwestern University's VAST tool (Sherin, in press).

In a related vein, Microsoft's MRAS (Microsoft Research Annotation System) has put forward a general architecture for multimedia annotations



focusing on use in higher education (Barger et al., 2002). There is also a considerable body of work on video annotation that has focused on indexing and browsing video databases (e.g., Carrer et al., 1997; Kim et al., 1996; Lee & Kao, 1993; Mills et al., 1992; Weber & Poon, 1994). Nonetheless, as described below, many of same problems beset this work as they do research on learning and the social sciences using video records.

### **2.3. Business Meeting Capture and Re-Use**

A number of projects over the past 5 years (e.g., Chiu et al., 2001; Fiala et al., 2004; Lee et al., 2002; Myers et al., 2001; Stiefelhagen et al., 2002; Yang et al., 1999; Young, 2001) have explored how to provide business and technology groups with the capability of returning to context captured from rich media records of their meetings, from automatic indexing, and other methods. The general idea is that one can use video to enable persistent context for ongoing teamwork, building in a cumulative way on prior meetings and design decisions, and continuing to excavate information that may come to have subsequent value.

For application to video conferencing meetings and distance education, Sun et al. (2001a, b; also see Foote & Kimber, 2001) have used their FlyCam system (Foote & Kimber, 2000: which produces high resolution and wide-angle video sequences by stitching together video frames from multiple stationary cameras directed at the front of a seminar room) in combination with a Kalman filter to detect the speaker's motion and then use that information to steer a virtual camera for recording a region of interest within the panoramic video stream.

Although not directly concerned with education, at Microsoft Research, Rui et al. (2001) have investigated the use of a panoramic recording system to allow people to "re-experience" face-to-face meetings. Interestingly, they found that users prefer having a panoramic overview—peeled-back video imagery showing 360° panorama—as a mechanism for navigating the scene.

### **2.4. Reflections on the Need**

In summary, there is substantial need, for research in the learning sciences, for e-learning purposes, and for facilitating collaborative work both in face-to-face teams and at a distance, for new methods that foster capturing, navigating, analyzing, re-purposing, and commenting on video as a medium for representing situated practices. Researchers today lack tools for sharing these video data readily with other scholars and practitioners, for building cumulative analyses of research data across investigators, and for opening up these data for public discussion and commentary.

## 2.5. Prospects of Digital Video Collaboratories

As in other scholarly domains of inquiry, there are fertile opportunities in education and in the learning sciences for developing new methods of work, knowledge creation, and learning that leverage the collective intelligence of the field in ways analogous to the biological, health, earth, and space sciences (e.g., Cerf et al., 1993; Finholt, 2002; Finholt & Olson, 1997). Advances in the physical sciences are inexorably linked to a corpus of scientific data that can be shared, annotated, analyzed, and debated by the community of physical scientists, as well as by developments in the instruments and technologies that are integral to formulating, conducting, and analyzing results from scientific investigations. Apart from the notable example of *TalkBank*, to be discussed, with its emphases on digital audio files and transcripts of human talk, there is no such corpus of shareable audio and video data of human interaction in the social and behavioral sciences. This lack of a shareable corpus of social science data has hindered theory development. The DIVER project is devoted to fill this void by providing social and behavioral scientists with a tool and a platform for generating different perspectives on human interaction phenomena in the form of annotated audio and video recordings.

The psycholinguist Clark (1996) has formulated the important social science concept of “common ground” as what it is people seek to achieve in the work that we do to co-ordinate what it is that we are attending to and/or referring to, so that when comments are made, what these comments refer to can be appropriately inferred. In the learning sciences literature, the “common ground” concept is usually used to examine collaborative or teaching learning discourse and pointing, bodily orientation, and joint visual regard to the focus of a conversation that is being analyzed for studies of learning or teaching (e.g., Barron, 2003; Pea, 1994).

But it is not sufficient only to focus on the non-technology mediated aspects of common ground—for once we look at inscriptional systems (e.g., Latour, 1986) that lay down and layer symbolic records such as text or diagrams or other paper-based representations, we see that they, too, become a focus of pointing and joint visual regard and introduce new problems as transient referents. One may want to refer back to an earlier moment when only a part of a mathematical diagram was present to allude to that state or some part of that diagram, for that is what one wishes to establish common ground around. Similarly, for a business meeting, one may want to refer back to a state of information display on a whiteboard and what it is that the people in the room were speaking about when it was constructed.

I argue that this common ground concept must extend to the dynamics of representations, particularly for the problematic cases when these representations are computer-enabled (e.g., Pea, 1994). One often needs to refer to specific states of information display when using computer tools, so establishing a common ground for discourse and sense-making, what it is one wishes

to point to, means capturing what Latour (1986) calls “immutable mobiles”<sup>2</sup> for replay and guided noticing.

Consider the potential but unactualized learning across learning science researchers themselves, with respect to the primary video data they collect of learning and teaching. Here too, we need to facilitate the learning and cumulativeness of knowledge construction that can come about through co-building on a common ground. A significant opportunity thus exists to work across researchers on a common ground of video records and annotation tools that is rare today. Without the dynamics of common ground, these results are improbable, and the sciences of learning and education will suffer accordingly.

## 2.6. Dynamic Media e-Publishing

Finally—a point for subsequent elaboration—the uses of digital video laboratories in the human and learning sciences call for a new, dynamic publishing and commentary medium, one where multimedia records are integral to the presentation of the phenomena and analyses, and in which precise references to specific facets of behavior or analyses are possible to sustain the knowledge building processes of a research community (e.g., Pea, 1999). Such a call for e-journaling is commonplace (e.g., Harnad, 1991; Varmus et al., 2000), but the importance of dynamic media in such publications is less commonly raised as an issue of importance (for a notable example, see *Journal of Interactive Media Research*, but even here dynamic media are presented but not able to be indexed or commented upon by referring to their features in terms of space–time cropped selections of the interface displays).

## 3. TOWARD VIDEO AS A SCHOLARLY MEDIUM

Consider the core plea here to be examining what it will mean to make video as integral a scholarly medium as text is today. This aim requires treating video-as-data and has a host of implications that will take us in different directions than are being pursued in today’s broadcast-oriented approach to uses of video-as-file in e-learning, movies and sports videos-on-demand, and other cultural pursuits.

There have been diverse efforts to move video data into broader circulation so that it may be re-analyzed by others. While anthropological film’s beginnings in 1898 by Haddon in the Torres Straits were only 3 years removed from the birth of the cinema (see Grimshaw, 1997), the tradition of filmmaking in visual anthropology was made salient in part by the classic works of Margaret Mead and Gregory Bateson (especially his book *Naven*, 1936, devoted to multimedia investigations of cultural ritual in Papua New Guinea). Researchers have recently taken advantage of other media to distribute video recordings together with multiple researchers’ analyses of these data

[CD-ROM enhanced issues of *Discourse Processes* (1999) and *The Journal of the Learning Sciences* (2002)]. These important efforts nevertheless highlight the limits today to bringing video records into a broader collaborative process among researchers and practitioners. Challenging other researchers' interpretations of video analyses typically requires becoming a filmmaker oneself, and either bringing in other material or cutting and splicing materials from the original researcher's work, adding new commentary.

Compare these obstacles to the simpler task facing students of textual literary works, who are able to excerpt and juxtapose passages from their subjects with little effort, and with few limitations as to length or location within the primary work. Even in using the data-sharing innovation of a CD-ROM with video clips that were to be referenced in the articles, the special issues nonetheless decouple video data from analysis, as researchers reference video source time codes and lines in transcripts. To comment on researchers' interpretations of these video data, other scholars must engage in the same referential gymnastics, instead of referring directly, in context, to the video data in their own commentaries on others' video data commentaries.

#### 4. INTRODUCTION: POINT-OF-VIEW VIDEO AUTHORING IN DIVER, GUIDED NOTICING, AND DIGITAL VIDEO COLLABORATORIES

Our approach to addressing these fundamental issues of making video function as a scholarly medium-like text turns on several fundamental concepts, which I briefly introduce here. These concepts, illustrated in Figure 2, are (1) point-of-view video authoring; (2) virtual camera; (3) virtual videography; (4) "diving" into video records; and (5) guided noticing.

The first concept is *point-of-view authoring*. This idea arose for me in thinking about the prospects of panoramic video for enabling fundamentally new kinds of interaction and manipulation of video records. Panoramic video, as noted above, involves using of one or more digital video cameras and mirrors to capture 360° horizontal imagery. Panoramic cameras are being explored for uses in sports, entertainment, surveillance, and business meetings, among other applications. The interesting issue for education and learning research is how to think about navigating and re-using such panoramic video records.

The innovative idea that we developed for the DIVER Project in thinking about panoramic video imagery is that of point-of-view authoring, in which a *virtual camera*, represented by a resizable rectangle (in one instantiation) can be panned and zoomed through that video, and used to "record" a point-of-view movie through the panoramic video array—to which comments and annotations can be appended. Such a virtual video camera makes it possible to enact *virtual videography*, creating any one of an infinite number of possible point-of-view authored films. We describe such path-movie authoring and commenting as "*diving*" into video. The use of a virtual camera to author



Figure 2. User interface for the DIVER desktop application, showing panoramic video. Note that we show a 20:3 wide aspect ratio panoramic video above, but that the DIVER interface can also automatically support Diving on traditional 4:3 aspect ratio video, or multiple video streams that have been synchronized from different cameras.

point-of-view movies within a panoramic video record and to annotate these path movies performs an important action for establishing common ground that I characterize as *guided noticing*. The use of the virtual camera for the framing of a focus within a complex and dynamic visual array directs the viewer's attention to notice what it is that is thus circumscribed, and the point-of-view authoring thus guides the viewer to that noticing act. Finally, DIVER makes it possible for the author to publish their dive to a webpage, using a WebDIVER server, so that others may experience their point-of-view video document and annotations—their dive on a source video. In an alternative implementation, videos encoded for WebDIVER server accessibility may be dived upon as streaming media by authors using any simple web-browser (thus not requiring the downloading of the video itself onto the diver's computer).

As it turns out, these core concepts are extensible from the case of navigating and point-of-view authoring within panoramic video records to the more general case of taking as input to the authoring process I have described any video source, including normal 4:3 aspect ratio video from consumer video cameras, multiple yet synchronized 4:3 aspect ratio video streams (e.g., from different locations in a networked collaboration session), and more generally yet to any dynamic or static visual medium including art, photographs,

scanned documents, animations, and other imagery or visualizations, as in science, medicine, or cartography (see Section 7).

I will later develop a broad account of current and prospective scenarios of DIVER use for enabling a broad range of cultural practices across and beyond learning, education, and scientific research. While not intended to be exhaustive, these scenarios will illustrate the scope of applicability of the general framework for guided noticing and point-of-view authoring. Finally, the capability that DIVER enables for any author to point to and comment on any part of a visual display and share that view so that others can experience it, by publishing it as a webpage over the internet with commentary capabilities at its component level, opens up the prospect of *Digital Video Collaboratories*, whereby a scholarly infrastructure is established for integrating video analysis, sharing, and collaboration in research communities (with potential for other cultural purposes). Making video function as a scholarly medium such as text turns on being able to refer to specific time–space co-ordinates in the source video, and in our work with DIVER and in collaborations underway with other researchers we are seeking to develop this vision into a reality.

## 5. DIVER AND GUIDED NOTICING

What is the activity of guided noticing? And how does it relate to other behaviors and concepts such as pointing, disciplined perception, and professional vision?

Guided noticing is a two-part act for a complex situation/visual scene. First, a person points to, marks out, or otherwise highlights specific aspects of that scene. Second, a person names, categorizes, comments upon, or otherwise provides a cultural interpretation of the topical aspects of the scene upon which attention is focused. In a two-person (or more) interaction, there are also distinctive roles. One is the “author” of the guidance (I guide you to notice what I notice), and the other is a “recipient” of the notice, which is mediated by an environment in which each participant is immersed. In the case of DIVER, and related media such as video and film, such guided noticing is also time-shifted and shareable by means of recording and display technologies. Diving creates a persistent act of reference with dynamic media—a link-addressable artifact—which can then be experienced by others remote in time and space, and which can additionally serve as a focus of commentary and re-interpretation.

Why is guided noticing important? Because achieving “common ground” (e.g., Clark, 1996) in referential practices can be difficult to achieve, and yet is instrumental to the acquisition of cultural categories generally, and for making sense of novel experiences in the context of learning and instruction especially. Clark observes that for one person to understand another person there must be a “common ground” of knowledge between them, and his research and that of others illustrates the complex multitude of ways in which such “common

ground” is inferred from immediate surroundings, mutual cultural context, and participants’ own prior conversations.

Guided noticing builds on the fundamental human capacity of referring and the establishment of shared attention. As Wittgenstein (1953) observes in his *Philosophical Investigations* in critiquing St. Augustine’s view of language learning as achieved by observing pointing and naming of things by adults—unless shared attention between infant and adult is achieved, it is impossible to learn from such ostension. The roots of shared attention and what the philosopher Quine (1960) called the “ontogenesis of reference” are established early. In the 1970s, an influential set of publications empirically demonstrated the advent of shared visual regard following adult pointing or line of visual gaze at approximately 9 months of age (Bates et al., 1979; Bruner, 1975; Scaife & Bruner, 1975) and its role in establishing what Trevarthen (1979) described as intersubjectivity between infant and adult (involving mutually adaptive purposeful activities).

Another reason why guided noticing is important as a human activity is that it facilitates the continual interplay between two fundamentally distinctive but complementary ways in which we make meaning in social activity—what Lemke (1999) calls the typological and topological modes. Typological representations assign a culturally meaningful category to some material form as when a pronoun is viewed as singular or plural, a verb form as expressing one type of tense or another, etc. In contrast, topological representations are visuo-spatial and often continuously variable in their qualities (examples include acoustic-vocal properties of speech such as timbre or sound quality, and visual media, ranging from gesture to graphs).

The obstacles to sharing analyses and commentaries of video data exemplified in special issues of *Discourse Processes* (1999) and *The Journal of the Learning Sciences* (2002) can be contrasted to the basic structure of human visual interpretation that builds on these human capacities for shared attention, and the interweaving of typological and topological modes of meaning-making. This structure appears in what I describe as a cycle of Looking, Noticing, and Commenting (the LNC cycle): I *look* at a visual scene, *notice* a pattern or something of interest, and *comment* upon it. If others are involved, the noticing is followed quickly by a gesture or visual regard that calls out the particular item of interest from the scene as a whole, so that others can connect the comment to the particular topical element that is being referred to. This Look-Notice-Comment (LNC) cycle—familiar to anyone in any field of work and life—is generative and recursive. Others can return to the scene as a whole to offer amendments or counter-comments, all the while noticing and gesturing in order to continue to tie the scene to the discussion and to build a common ground of understanding, or to negotiate differences in meaning. In daily life, this cycle is so well integrated into practice that it most comes to attention when it fails to function. However, in the analysis of video records, there has been no existing toolset to enable distributed communities of scholars or practitioners

to readily engage in this kind of interactive commentary on a shared and accessible body of video material with anything like referential precision.

The basic LNC structure is used in early parent–child interaction in helping guide noticing of culturally significant phenomena and their meanings (e.g., Rogoff, 1990; 2003). It is also used in promoting expertise development in the exceptionally broad range of domains in which visually accessible information is critical, toward achieving what the anthropologist Goodwin (1994) calls “professional vision”. Examples include learning to appreciate artistic works from specific frameworks of interpretation (Berger, 1972), recognizing diagnostic patterns in dirt at archeological digs (Goodwin, 1994), coming to see important patterns of classroom interactions as a teacher (Sherin & van Es, 2002), detecting tumors in radiological imagery, analyzing a motion picture, identifying mountains on a map, seeing galaxies in telescopically enabled perception of the heavens, and so on. In each of these cases, one is faced with a complex visual array of information to *look* at, comes to *notice* aspects of that visual information (for any one of a number of reasons, such as its being distinctive, relevant to the action at hand or being pointed out in some way by a more expert other), and to *comment* on the meaning of the noticed aspect one has picked out of the looking.

Goodwin (1994) uses the phrase “professional vision” to characterize how, “central to the social and cognitive organization of a profession is its ability to shape events in the domain of its scrutiny into the phenomenal objects around which the discourse of the profession is organized”. He presents compelling examples from archeological field excavation and legal argumentation (and oceanography: Goodwin, 1995) to indicate how professions achieve this ontological work by *coding* (in which some structures of the world are captured and other possible ones ignored), *highlighting* (as in saliently establishing a figure against a ground, such as by demarcating graphically or pointing), and *producing graphical representations* to make a case (such as transcripts of talk, diagrams, and frame grabs of scenes recorded on videotape). I wish to argue that the LNC cycle is the developmental base upon which the more academically focused concept of professional vision builds.

For millennia, humans conducted this central human activity as an oral discourse only, situated in the here-and-now of whatever visual information was in front of them (e.g., DeLaguna, 1927) or able to be adduced from memory of shared experiences with others and talked about, and without the benefit of any inscriptional system, that is, a notation scheme that made sensible marks on a persistent and observable surface whose meaning could be shared with others (such as written words or other symbols that express a consistent system of meaning). Extensive scholarship has been devoted to the historical importance of this development in human culture, for the later emergence of logic, mathematics, science, art, and many other fields of human achievement (e.g., Cassirer, 1953–1957; Goody, 1987; Latour, 1986; Olson, 1994; Ong, 1982). For once, humans were able to inspect a persistent record





Figure 3. DIVER's windows: (1) overview ("Look") at bottom, (2) magnified viewing ("Notice") at upper left, and (3) the Dive worksheet ("Comment") comprised of panels.

of ideas and their inter-relationships, and to leave behind a commentary on their topic of attentional focus from which others could learn.

In this broader framework of socio-cultural practices and technologies, the DIVER software goal is thus to provide a tool and a communications framework for augmenting the fundamental and social activity of human visual interpretation and communication about what is interesting or relevant to a purpose at hand—looking at a complex scene, noticing events of interest, and commenting on the focus of attention. As shown in Figure 3, the LNC cycle has informed our design of the DIVER software. Specifically, the DIVER interface consists of three distinct regions, each corresponding to one of the elements in the fundamental LNC cycle of visual interpretation and communication.

The overview (Look) window provides access to the original source material that is the overall subject of the discussion or analysis, and has standard video controllers, for forward, reverse, and pause, which also allow for “time scrubbing” by moving the video player control forward or backward quickly, with a corresponding viewing of the video at accelerated speed (as a quick way to survey the content of a video record). In this overview window, users can return to any part of the original video source and explore it.

The magnified viewing (Notice) window depicts a selection from the original source that the user makes with the mouse by dragging a resizable selection rectangle overlay (the “virtual camera”) across the overview window,

panning over, and zooming into regions of interest in the scene. We sought to satisfy with this dual overview/magnified-view interface the well-known dual awareness principle of human–computer user interface design, also called “focus + context” (e.g., Card et al., 1999; Furnas, 1986; Lamping et al., 1995; Mills et al., 1992; Rao & Card, 1994). The user can thus zoom-in on an information source’s details yet maintain a sense of orientation and context. Related navigational interfaces have been explored in several experimental and commercial applications of panoramic video technology (BeHere.com; Fullview.com; Kimber et al., 2001; Prihavec & Solina, 1998; Rui et al., 2001; Teodosio & Mills, 1993).

As the virtual camera is moved across the video source overview, the viewing window provides a dynamically updated and magnified view of that region of the original video source. Two buttons—MARK and RECORD—turn this viewing area selection into an easy-to-comprehend and flexible authoring activity. MARK takes a temporally tagged snapshot of the contents of the magnified viewing window and creates a new panel for commenting in the third region of the screen—the Dive (Comment) worksheet. A worksheet panel contains a video thumbnail representing a marked clip, as well as a text field for describing what is noteworthy about that selection.<sup>3</sup> If the DIVER user presses the RECORD button, another panel is created. When the record button is pressed again to end recording, the virtual camera’s pathway across the video overview window completes its recording of the spatiotemporal selection shown in the virtual camera window.

Thus the user of DIVER can record a dynamic “path” through the original source video and annotate it by entering text in the Dive panel. In creating a unique “point-of-view” virtual tour of the original video source, we say the user is creating a dive (or “diving”) into the video record. He or she can then use the dive as a device for storytelling or other rhetorical purposes (e.g., video data argumentation for a research conjecture) by playing back the marked locations and dynamically cropped pathway “recordings” through the original video source as well as the annotations of these records. A dive is subdivided into panels, which serve as containers for the data elements that constitute the dive (see Figure 3). Panels contain the following data elements:

First, static and dynamic time and space video markers: A static marker is a pointer to a frame in the video (temporal co-ordinate) and the location of the virtual viewfinder within that frame (spatial co-ordinates). Dynamic markers are recordings of the space–time path traveled by the virtual camera as the user guided it through the source video.

Secondly, a thumbnail-sized image copied from the source video at the marked time and space is used as a live link for specific time–space video co-ordinates. To make it easy to explore the place of the marked clip in the overview context, dragging and dropping such a marker into the viewing window resets the virtual camera to the space–time co-ordinates previously marked.

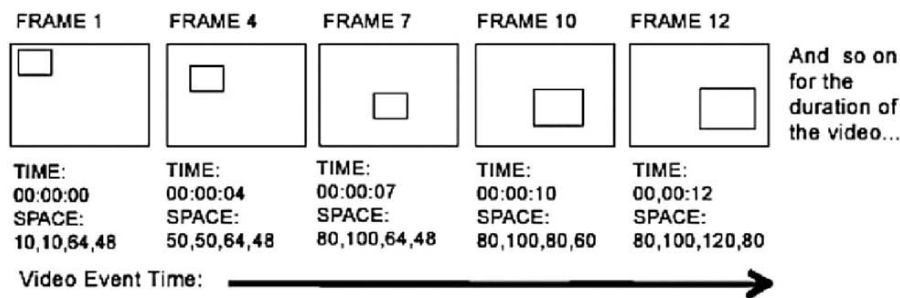

Figure 4. A graphical representation of the .dvc file format.

Thirdly, annotation text that a user typed into the panel is used to provide a commentary associated with the static or dynamic marker.

Fourth, the temporal point or range of video that is contained within a panel selection is denoted by a single time code for a static marker or a range of a time code range for a dynamic marker.

Finally, a time–space cropped video clip is depicted as a thumbnail-sized image in a panel to act as a symbolic representation of the selected portion of the source video segment. Double-clicking a thumbnail (or drag-and-dropping it back into the viewing window) repositions the source video at the corresponding time–space co-ordinates.

The simple and efficient creation of dives is supported by the DIVER file format. As a user drags the virtual camera viewfinder across the source overview window (see Figure 4), a reference to time (the video time) and space (the position of a viewing region within the video’s border) is recorded to a list. These time–space recordings (which we call “.dvc files”, where .dvc represents “DIVER Video Collaboratory”) can be played back by the user; the DIVER system reconstructs the virtual viewfinder’s path through the original source video in real-time. What is recorded when the user presses the RECORD button in the DIVER desktop application is not literally a new video, but the .dvc file information needed to replay the dynamically cropped pathway which the virtual camera traced through the original sequence of video frames.

When a .dvc file is played, current video time and space is reset to the previously saved time and space co-ordinates. Prior to displaying each frame of video in the virtual camera window, the video’s borders are scaled (in real-time, on-the-fly) to match only the viewing area co-ordinates associated with the same frame (video time) in the recorded virtual camera path. Two key benefits inhere in using the “.dvc” list recording scheme versus re-rendering new video clips: (1) disk storage requirements are greatly reduced since virtual video clips do not generate redundant video files and (2) software performance is vastly improved because no rendering time is required—users can instantly create and play back dynamic path videos. Dives are thus extremely

lightweight glosses on original source content. Yet, they can comprise very rich and compelling viewing experiences—they truly provide the interactive experience of *making movies within movies*.

The structure and extensibility of the XML-based “.dvc” file format serves as a metadata container that can allow for the reformatting of DIVEs into many display and interaction environments. For example, on a handheld computer or cellphone supporting only text and image display, the “.dvc” format could be used to extract and display only text annotations and video thumbnail images, or smaller video display if capabilities allowed.

In the desktop implementation of DIVER, a user’s video dive can be uploaded to a WebDIVER™ server for sharing, discussions, and collaborations. The content transformation process for the web format takes place in a series of client- and server-side tasks invisible to the user. The user initiates an automatic series of text, image, and video clip transformation processes as he or she chooses the “Export to HTML” menu option in the desktop DIVER application (see Pea et al., 2004 for details).

When a dive is later opened on the WebDIVER site, the content is reconstituted as HTML and JavaScript, so that webpages are dynamically generated from the media files and XML data. WebDIVER browser pages look similar to desktop dives, for they contain the same data and media elements. The

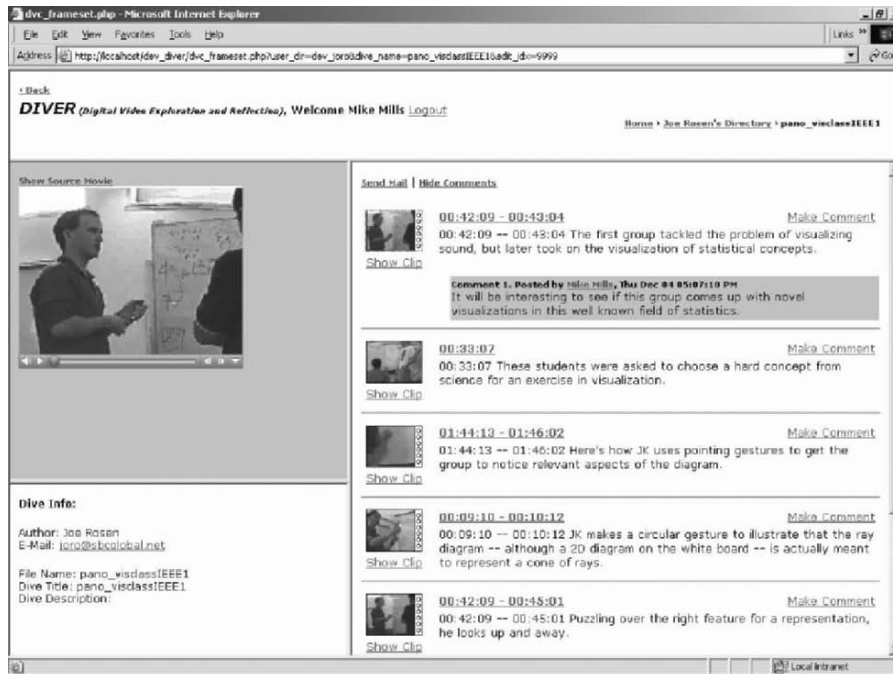

Figure 5. A dive from the WebDIVER site, as seen in a browser window.

WebDIVER window in Figure 5 shows an example (also see Figure 6 for the more recent Flash streaming video implementation interface).

In addition to the original author of the dive, other WebDIVER users can now both view a dive and explore its full source video through any web browser. Moreover, users can collaborate on a dive by entering their own comments on the dive annotations made by the dive's creator for each panel. WebDIVER users can also perform keyword and metadata searches within and across all annotations for all videos and dives that are available.

The paradigm of desktop DIVER use and uploading to WebDIVER of both the media file and the user's dive for access and commentary by others—while very useful and powerful—has several key limitations. One of these is that the time for uploading large video files will often be prohibitive. A second concern is that many use scenarios where one may wish to allow users to dive on videos (e.g., research collaboration, entertainment) recommend a scheme for protecting intellectual property in which a user does not have the video file itself residing on his or her own computer, but where the video simply streams from a web server during the video playing and diving processes. A third concern is that the requirement to download and install the desktop DIVER application (and regularly update it with new versions) may make DIVER far less widespread in its uses than a web-browser-based approach would allow.

To achieve this more demanding objective, we developed a new WebDIVER design that provides many of the key desktop DIVER application functions, but in a fully browser-based approach. The design as of January 2005 is as follows (Figure 6).

One or more remote users use a web-browser on their computers to go to a specific URL where a video file has been encoded in Flash video format and made accessible so that it can be “dived” upon as described above. The new WebDIVER design still represents a dive as made up of a set of panels, each of which has an author and editing capabilities affiliated with it. The panel is a data container for the DIVER key frame that is marked or the DIVER movie that is made with the virtual camera. Multiple users can be connected to the URL at once if they have permissions to do so and can make their own dive panels for the video file, with the MARK and RECORD buttons and the use of the virtual camera viewing rectangle under mouse control in the web-browser version, as on the desktop DIVER application. When they do so, they see their own work appearing in the dive in real-time, and if others are also making dive panels for that video, if one presses the “update” button on the webpage (see Figure 6), the different panels of the DIVE that are being created collaboratively—whether locally or by distributed users—are made visible. Thus, users may be either face-to-face in a meeting room, or connected to the same webpage remotely *via* networking, as they build a collaborative video analysis.

In principle and in practice, there is no need for the users to be watching the same portions of the video at the same time when they work collaboratively;



Figure 6. WebDIVER: Streaming Media Interface for web-based diving.

as the video is streamed to them through their web-browser, they may mark and record and comment at their own pace and as a function of their own interests. The collaborative video analysis activity that uses DIVER can be as playful or emergent as the participants choose to make it; constraints on focus, intent, duration of sessions, and so forth are not built-in to the technology, but a matter of negotiated social practice. Note one important difference: whereas in the desktop DIVER application, two video windows are part of the user experience (one an overview window of the whole video file and the second the zoomed video contents circumscribed by the virtual camera rectangle), the WebDIVER system allows for just one window of the whole scene. The diver achieves guiding noticing by directing the dive user's attention to where the diver points in their dives with the virtual camera rectangle. Thus, when one plays back a dive on the WebDIVER browser version, the viewing rectangle moves across the video and shrinks or expands to represent what the diver pointed to during their dive creation.

Having now provided a basic account of how the DIVER and WebDIVER software systems work and the connections of their functions to socio-cultural purposes of guided noticing and point-of-view authoring, it will now be worthwhile to examine the profound implications of panoramic video when brought into this context.

## 6. DIVER AND PANORAMIC VIDEO AS A NEW MEDIUM FOR LEARNING SCIENCES RESEARCH AND EDUCATIONAL PRACTICES

### 6.1. The Need

Because 4:3 aspect ratio digital videos captured with digital video cameras are so pervasive, they will often be the source material for DIVER. However, the use of such video records as data in social science research is hampered by their partial quality. One or two video recorders and microphones produce a record that is partial (since limited by what the operator chooses to capture and what to ignore), and often of low quality, particularly in the audio dimension (Lampert & Hawkins, 1998). The original researcher or other researchers who may be interested in different aspects of the events that transpired cannot recover events relevant to the analysis occurring off camera. These issues drew us to developing for research and educational uses the application of panoramic video and audio capture, navigation, and DIVER application for creating point-of-view authored tours of video records.

Today, panoramic video is often employed for omni-directional vision/sensing applications such as teleconferencing, navigation, and security or military surveillance (e.g., Fullview, 2004; Nayar, 1997; Sun & Manjunath, 2004). Bapna et al. (1998) provided a dramatic demonstration of panoramic video-guided tele-operated navigation of the Nomad robot for 220 km across the Atacama Desert of southern Chile, anticipating planetary rovers. Other panoramic video applications include making available a remote window onto a panoramically recorded event such as a lecture (Kimber et al., 2001), or as one component in an effort to produce an immersive simulation of activities such as a sports game or a concert (Neumann, et al., 2000; Rizzo et al., 2001).

We were attracted to exploring the feasibility and practicality of panoramic video recording for research and education because one can place such a camera in a room, shoot the video, save it digitally, and in post-production, create with DIVER a virtually infinite number of different experiential paths through the video—as if one had multiple cameras in the room at the time of the video shoot. Panoramic video is of special interest in any context where the purpose and application of the video resources are not well defined before recording.

It is hard to wrap one's head around this when seeing and thinking about it initially. The reason may well be that it is easy to have a misleading question, that the video camera is like an eye and therefore must have a "point of view". But in acquiring the images in the 360° surround, the panoramic camera at every moment in time, every frame and pixel saved, provides the raw materials for an infinite number of points of view at once. And for every next frame, one can pan, tilt, and zoom to any one of a very large number of other points of view, and so on, ad infinitum. There are infinitely many pathways that one can explore and then express, using DIVER's point-of-view authoring methods,

what one sees and notices in the pathways one crafts through the panoramic recordings.

For uses of video in research on learning, our goal is to capture much more complete event recordings than is possible with usual means, by using techniques such as panoramic high definition video, multiple-phased microphone arrays, and a software and hardware infrastructure to support variable numbers of synchronized data streams from sources such as handheld devices and video displays that may be part of the context of the activity filmed.

## 6.2. Synoptic Video Capture

We use DIVER as a software analysis tool for selecting and annotating clips from what we have called a “synoptic”, or all-encompassing, panoramic view of an event, in order to allow users to gain control over the high volume of data thus produced. Our ultimate purpose is to record events in a way enabling researchers to return as often as they wish to the original event, refining, modifying, or rejecting their conjectures in the light of new interpretations of the recorded activities. This goal stems from the high degree of complexity of learning environments (such as classrooms), defined by the interaction of multiple simultaneous channels of behavior and communication in context of a complex physical and representation-rich environment. It is difficult to determine, either in real-time or in a single viewing, what is important about a learning event. Making sense of an event typically requires repeated viewings, isolating in turn individual components of an event [see Jordan & Henderson’s (1995) paper on video interaction analysis]. Conversely, any real-life learning situation can sustain multiple different interpretations, focusing on different factors of theoretical interest and on different aspects of the recorded behavior.

We would thus like to produce as complete a record of an event as is practicable from panoramic recording, so that the DIVER software can support repeated interrogations of the original event from differing perspectives (and with differing hypotheses) about what aspects of the event are significant. Our aim with this synoptic approach is in part to overcome presumptions about inherent limitations of “video-as-data” in how ethnographic records have traditionally been collected with video cameras, for example:

“Although video technology can clearly capture more than one observer could possibly notice and record, in another sense video technology may capture less. Videographers have options as they decide how to tape a classroom: they might pan across the room or fix on the teacher, depending on the structure and goals of the data collection and the videographer’s training. Tapes cannot capture everything that happens in a classroom, and what they miss is typically determined by the position of the camera rather than by a trained observer’s instinctive reactions to events as they unfold. Moreover, while video data are less “processed”



than other kinds of data, they are not equivalent to direct observational data. The view of someone watching videotape is constricted; he or she is experiencing what is taped through the frame of a host of decisions made before and as the data were collected”.

(Hall, 2000)

These assumptions are challenged with a “synoptic” approach to video capture, that is, the use of multiple perspectives/instruments on the same event in order to compensate for the partial quality of any one instrument. In post-capture interrogations of the panoramic digital video data from a classroom situation, the analyst can choose different fields of view and pathways through them depending on their purposes—in effect, going “beyond being there” (Hollan & Stornetta, 1992) in ways that a single videographer could not have done at the time with a traditional camera.

The completeness of the record is further addressed in the spaces instrumented for panoramic recording, which may consist of a room set-up with multiple audio and video recorders, with the goal of producing a synoptic record of events. We obviate the need to make real-time decisions about what is “important” to shoot by using a panoramic video recording system. We have also demonstrated that it is possible to equip a recording space with multiple microphones to capture with equal clarity interactions occurring at any point in the room (see below). This synoptic architecture is deliberately designed to be open to future enhancements, both by enhancing the recording ability of any particular recording modality (e.g., additional video cameras to deal with problems of occlusion and differential resolution based on spatial position, or moving from standard definition to high definition video), and by adding new modalities (e.g., recording, in addition to the audio and video, the content of displays being used by participants in the space, or other behavioral data streams).

An example of “being beyond there” that ethnographers have found particularly compelling in using DIVER is the capability of creating grouped clips, that are made up of selected regions of the video scene which can then be played in unison to explore relationships between what was happening in different parts of a learning situation at the same time, and annotated accordingly.

A major technical challenge in recording panoramic video is *image resolution* [see Benosman & Kan (2001) for an excellent edited volume on problems and recent solutions in panoramic vision]. In order to be able to zoom into an area of the panoramic video as we do with DIVER’s virtual camera and still see sufficient detail, the video must be captured at the highest possible resolution. In principle, panoramic video can be recorded with a single-lens system: a spherical mirror, somewhat similar to a fisheye lens, collects the light from the 360° surround and redirects it onto the CCD chip of a single camera. The digital video stream of the camera can then be processed (stored, compressed,

edited) like any other video stream. Such systems are relatively inexpensive and readily available; examples include the BeHere<sup>®</sup> camera (behere.com) and the camera used in Ricoh's Portable Meeting Recorder (Lee et al., 2002). But single-lens systems have very low image resolution because the number of pixels on the CCD chip, designed for a small angle of vision, must now be distributed across a much wider angle for surround vision. Thus, zooming into an area within the video leads to a very low image quality due to the pixelization of the video data.

To solve this problem, several multilens systems have emerged. They capture a scene through multiple lenses and CCDs with slightly overlapping fields of vision and then construct the panoramic image by "stitching" the frames together (Tan et al., 2004). Examples are the Fullview<sup>®</sup> camera (fullview.com), the FlyCam developed at the Fuji Xerox Palo Alto Laboratory (Sun et al., 2001a, b), and the RingCam used in Microsoft's meeting capture and broadcasting system (Cutler et al., 2002). Multilens systems address the image resolution problem, but they introduce the challenge of stitching and de-warping of multiple frames in the computer, perhaps in real-time. In addition, multilens systems running at full-resolution generate a very high bit rate, often too high to be transferred over a single PCI bus.

In the DIVER project, we use a Fullview<sup>®</sup> camera system with five mirrors and five cameras, whose streams are fed into a PC where they are stitched and de-warped at a resolution of  $1800 \times 240$  pixels, at about 15 frames/second. The panoramic video is written to a file for subsequent processing by the DIVER toolset. We use three parallel PCI buses on the PC doing the processing to accommodate the very high data rate generated by these five digital video streams. We have developed a tape-based alternative recording system (see below) capable of even higher resolution, which is desirable for the repurposing of panoramic video. We have also devised a system for capturing multichannel sound with a microphone array so that panning and zooming with the virtual camera into the overview window on the resultant panoramic video record provide a corresponding audio focusing mechanism<sup>4</sup> (see below).

It is important to ensure compatibility with 4:3 aspect ratio video and panoramic video content at a variety of aspect ratios. As a result, DIVER has been architected to support a general approach for video analysis, collaboration, and interaction allowing for use of a diversity of aspect ratios and resolutions for recorded video material. This provides a flexible approach for users to record, analyze, and share a broad range of video material in the DIVER environment, independently of the specifics of the video material that has been captured.

In order to accommodate even higher resolution video capture than is possible with native FullView<sup>®</sup> live preview and direct-to-disk video, we developed an alternative full-resolution video tape-based recorder. The output from the FullView<sup>®</sup> camera array is recorded at full-resolution ( $720 \times 5 \times 480$ ) and full frame rate ( $\sim 30$  frames/second) to five consumer-quality Digital Video Tape

Recorders. Desired video tape segments are later transferred to a PC, where in a software assisted post-process the multiple recordings are reassembled into seamless full-resolution  $3500 \times 460$  @  $\sim 30$  frames/second QuickTime encoded panoramic movies ready for DIVER.

While there are a number of systems that provide panoramic still image capture (e.g., Apple QuickTime VR: Chen, 1995; Pix, 2005), and fewer systems that capture panoramic video, they are all oriented to providing an immersive remote or recorded experience (e.g., Boulton, 1999; Neumann et al., 2000; Rizzo et al., 2001), not enabling authoring by the user of point-of-view perspectives on their interests in the visual array of the recorded data. One interesting exception is the FlyAbout system where panoramic video captured by moving a  $360^\circ$  camera along continuous paths is spatially indexed for subsequent interactive navigation so that users can interactively replay video by traveling along paths using a map-like interface (Kimber et al., 2001).

The DIVER software system provides users with capabilities for adding perspective on the digital files that have been collected with a panoramic camera. Diving is designed to be a liberating authoring medium for video, perhaps most evident with panoramic video records, as it is constructivist in nature since any user can create their own annotated point of view on the video that has been captured. Creating one's personal point of view in establishing a dive through a panoramic video recording amounts to what I call Personal Reality Authoring—as a new complement to the recent decade's developments in Virtual Reality (Rheingold, 1992) and Augmented Reality (Feiner, 2002), neither of which are created by the intended user of the medium—because the diver can save his or her path through the panoramic video record. Once saved such a record provides a mechanism for replaying the user's authored path, or guided noticing tour, through the panoramic video recording.

### **6.3. Panoramic Audio and DIVER Zooming into the Panoramic Audio–Video Array**

We have highlighted the common problem in use of one or two video cameras for learning research of poor audio quality for select parts of the video record. DIVER's ability to focus attention on a particular visual area within a panoramic (or non-panoramic) video image—the unique capability for interacting with video which we call “guided noticing”—raises the question of how to handle navigation of the sound field, once captured from multiple microphones in an instrumented recording space. Our current solution is associating co-ordinates within the video visual field with sound tracks, which locations then function like individual physical microphones (although they could also be produced by mixing microphone inputs in post-processing, and vary from the number of physical microphones). In this manner, we can switch to the corresponding sound track as the user navigates the virtual camera through the visual field (as in Figure 2).

DIVER panoramic movies may currently contain up to 10 independent sound tracks. Each is mapped to an associated field of view captured by the FullView<sup>®</sup> panoramic camera. These multichannel sound recordings are embedded as navigable QuickTime audio tracks within the post-processed panoramic movies. The result is that panoramic sound can be steered from inside DIVER in such a way that only the tracks associated with the current focus of the virtual camera become audible. This mechanism allows for the easy re-purposing of audio recordings and the dynamic creation of infinite virtual audio mixes. The audio remapping process happens continually and on-the-fly, so the user is not required to wait through a time consuming sound re-rendering phase.

## 7. DIVER VISIONS AND DEVELOPING SCENARIOS OF USE: RESEARCH, DIAGNOSIS, TRAINING, AND COMMUNICATION

### 7.1. Introduction

We distinguish several key forms of point-of-view authoring made possible using DIVER which we believe will prove useful: (1) tool for *learning research use* for expert analysis and discussion of video data (and other media); (2) *assessment of novices and trainees* in diverse fields, regarding details that they notice in complex visual media and the qualities of their commentary about it; (3) the “*scaffolded*” *training of novices*, who could be guided in their analysis of a video record by comments designed to stimulate their own perceptions; and (4) *expressive uses* for communication of perspective on complex media records by users in virtually any life sphere. The details of diving will depend on the nature of the cultural purposes of the media on which one dives. I then exemplify these categories for a broad variety of cultural purposes in research in the learning and other social sciences, and then consider prospective DIVER uses across this taxonomic span of purpose types for the physical sciences, art, film and popular culture, sports and other entertainments, e-commerce, and training of all kinds including sales and law. It is worth noting that one can distinguish DIVER use by type of media (dynamic or static), and the dynamic media may be either videos, animations, or dynamic records captured from running a simulation or model, whereas the static media may be a radiology image or a work of art or a photograph of a landscape scene or a microstructure of a plant, to name but a few examples.

### 7.2. Tools for Research on Learning and Other Media

DIVER has been developed first for use as an expert tool involving selecting and annotating video clips of human learning in diverse contexts from

classroom learning settings, to the workplace, to home, community, and more informal learning settings—for the purposes of empirical investigations of patterns and relationships in behaviors, talk, and other levels of analysis. With its use for these purposes, we may study knowledge-in-the-making and examine the ways in which the physical, inscriptional, and social environments contribute to learning and knowledge construction. As applied to teaching, one can do empirical investigations of patterns and relationships in the work practices of teachers, and how they relate to student behaviors and artifacts of their work.

In one notable DIVER extension to be discussed, when applied to the physical, biological, and medical sciences, it is often observed that to investigate and understand many of the interesting phenomena of biological growth, or cellular activities, or dynamics of fluid flow or mechanics in physics, one needs video or simulations that can “play” at different spatial and temporal scales. In this use of DIVER, once one has video in hand, one can select and annotate video clips of the physical or biological phenomena at hand—for the purposes of empirical investigations of patterns and relationships.

### **7.3. Diagnostic Tool**

DIVER also provides an experimental tool for teasing out differences in the ways that novices and experts in the learning sciences “see” or “notice” social and behavioral phenomena captured in the video recordings. As applied to teachers, we can use DIVER as a means of identifying differences in the ways that novice and expert teachers “see” or “notice” patterns in learning, classroom interaction, or teaching. We know that there are extraordinary differences in the perceptions and cognitions of expert and novice teachers. Expert teachers literally notice very different things in the unfolding drama of classroom interactions than do novices, and their perception of these patterns contributes to their ability to make nuanced decisions about what to do next to enhance the learning that will take place (Berliner, 1988; 1994). Teachers need to develop expert models for perceiving instructional opportunities and how the challenges of meeting them are achieved.

For either application, one can do free-field selection of parts/clips of the video recording for annotation on their part, but can also provide highly structured assessment templates, in which the DIVER user’s attention is directed to particular spatiotemporal co-ordinates in the video array and about which specific questions can be asked. Teaching mentors may also mediate the novice in role-playing the decision-making role of the teacher depicted in the video—“what would you do next?”

Finally, as discussed later, DIVER may find utility in teacher certification processes, used for teachers to build video-based evidence from their teaching practices and other documents that they use to argue that they meet specific rubrics of evaluation.

#### 7.4. Training Tool

We know from the model-scaffold-fade instructional approach that has been called “cognitive apprenticeship” (Collins et al., 1989) that a powerful mode of learning a complex skill and knowledge base is to experience an expert in the discipline modeling their problem formation and problem-solving processes, “thinking aloud”, and to then be scaffolded, i.e., supported as a learner, in the performance of that complex activity. Finally, the instructor then “fades” the scaffolding so that the learner can function autonomously without the aides initially required (Pea, 2004). In applying DIVER for such a scenario, learners who seek domain expertise would be provided with inquiry modeling in structured video dives provided by experts. These dives will highlight with guided noticing and commentary how the expert perceives and interprets the complex environment in which their developed skills are deployed. Then, following experiences with such a modeling phase in the cognitive apprenticeship approach, the DIVER user would be provided with scaffolding support in pursuing their own perceptual activities in the task domain. Such scaffolding can take various forms, including reducing the degrees of freedom affiliated with an interpretive response, or other forms of hinting of prospective solution approach to the problems at hand. In any respect, the DIVER user’s dives, once posted to WebDIVER, can be provided with asynchronous commentary/critique from experts concerning the user’s learning efforts to detect or notice the patterns in the video records that the experts recognize.

#### 7.5. Expressive Communicative Tool

In this scenario, anyone who can use DIVER and desires to communicate a point of view about a media record (static or dynamic) can author a dive. These purposes can be exceptionally diverse, from day-to-day dialogs with peers or family, to formal certification activities, to entertainment—as in making dives of a favorite movie to share fun parts of it with a friend.

A particularly powerful use in this vein would be to ask children in a classroom to dive on a panoramic video of a lesson and to provide the point-of-view path movie and commentary on what they noticed and thought about as it was happening [e.g., Goldman-Segall (1994, 1998) explores what she calls “point of viewing” by learners about their school experiences]. This stimulated-recall scenario is likely to yield results that will surprise the teacher and others who view the students’ dives, because we so rarely understand their points of view on the instruction they receive. Yet what matters is their experience, not simply the experience of watching the teaching an adult provides.

There is a potentially radical activist agenda that could be pursued with point-of-view authoring of DIVER videos as well, that builds on work from the 1960s that began to provide cameras and video cameras to children in



Figure 7. Photo courtesy of Paper Tiger Television  
(<http://www.museum.tv/archives/etv/A/html/activisttele/activisttele.htm>).

poverty conditions for their own documentation of their reality (see Figure 7), and in general to provide personal alternatives to mass produced studio television programming (e.g., Halleck, 2002; Shamberg & Raindance Corporation “Guerilla Television”, 1971).

#### 7.5.1. Tools for Multimodal Studies of Classroom Discourse

Researchers who study learning and teaching in classroom interactions often capture multimedia records and seek to use them for understanding their phenomena of interest. Problems of the selectivity of video recording are compounded with an additional problem. As Hall (2002, personal communication) has argued, the process of moving from a concrete video to a general proposition with scientific status should be transparent and reversible, in order to preserve the status of video as evidence. He suggested that providing viewers with access to the original video and the means to author their own perspectives might be a useful way to maintain focus on the process of fact and argument construction out of video evidence.

If digital video is to become widely used and accepted as evidence in the learning sciences, it is necessary to develop practices for video-based argumentation, as well as statistical uses of video. Otherwise, oft-heard arguments will remain that the selective capture of video is anecdotal and used primarily for buttressing the beliefs of an investigator rather than for systematically testing scientific conjectures. For example, with panoramic video records that do not bias a point of view in selecting specific students to focus on, and an algorithm for data-sampling, one could do randomized time-sampled or other designs for systematic experimental comparisons of student behaviors in an environment employing designed interventions versus a control classroom.

Ken Hay’s Integrated Temporal Multimedia Data (ITMD) Project at the University of Georgia uses a variety of cameras, audio recorders, and computing devices to produce multiple streams of data from event recording

(Hay & Kim, in press). This approach ensures that the event is fully documented, but poses difficult issues in data management and integration. Hay and Kim describe some aspects of a response to these issues, such as real-time coding of “nodes” of event activities. The amount of data generated by the ITMD research approach has led Hay’s group to a concept with very broad applicability: The amount of “friction” involved in creating and, most importantly, storing, retrieving, and using video records. Friction refers to the amount of time and, secondarily, expense that is required to make a video record useful. If friction is high, researchers will tend to make relatively less video and to make less use of it in their work. If friction is reduced, then we can expect digital video to be more heavily used. Hay urges that friction be quantified as much as possible, and that attention be directed within the community to reducing the amount of friction associated with digital video inquiry.

There are a plethora of tools for video analysis, editing, and reflection, and it is important to characterize some of them briefly and how they relate to our DIVER work. We found in a recent workshop bringing together leading video researchers in the learning sciences and teacher education that there were 10 different functions of video research that are supported (or not) across these different tools (Pea & Hay, 2003): (1) acquisition; (2) chunking; (3) transcription; (4) way-finding; (5) organization/asset management; (6) commentary; (7) coding/annotation; (8) reflection; (9) sharing and publication; and (10) presentation.

Many of the tools used by research communities have focused on developing only a few of these capabilities, and as several examples illustrate, they vary considerably in their strengths of support for the functions. Video-Paper Builder is designed primarily to facilitate the creation of web-based “video-papers”, educational research publications that incorporate video clips (Beardsley et al., in press; Nemirovsky et al., 2001). The CLAN tools that MacWhinney and colleagues (2000) have developed for TalkBank provide an exceptional suite of transcription, coding, and annotation tools but are not oriented to supporting reflection, sharing, or commentary. In contrast, the Teachscape platform for providing school districts and teachers with video case studies of exemplary teaching integrated with online community of interpretation focuses on chunking (there are highlighted sections of each of the videos, for particular instructional purposes), and reflection (as supported by use models of study groups of teachers who exploit the online community features at home, e.g., Lu & Rose, 2003). But while providing transcripts of videos used, it does not offer transcription tools, as it is designed more as a teacher professional development environment than as a research tool.

Other tools are tuned to analyzing video records by coding, creating transcripts for and/or annotating video clips (e.g., *Constellations and Orion*: Goldman-Segall, 1994; 1998; in press; *Transana*, 2004; Derry & the STEP Team, 2003; *Video Analysis Support Tool*: Sherin, 2001), and several commercial tools used for coding and transcripts in behavioral sciences research



are available in Nudist/nVivo, and atlas.ti. (There is a long history to video annotation and analysis systems I will not survey here, e.g., Harrison & Baecker, 1992; Mackay & Beaudouin-Lafon, 1998; Roschelle et al., 1990).

Video editing and chunking are often accomplished with commercial tools such as Apple Computer's *iMovie* or Adobe *Premiere* but these are not oriented to coding or reflection, among needed functions noted above.

Reed Stevens' desktop *VideoTraces* system (Cherry et al., 2003; Stevens & Toro-Martell, in press; Stevens et al., 2002; Stevens, in press) is oriented to reflection and presentation, in enabling users of his software to lay down a reflective "trace" on top of a video record (the "base" layer that can be played at variable speeds), consisting of voice annotation and a pointing gesture implemented as a pointing hand cursor. A *VideoTraces* file may then be replayed so that one hears the audio trace overlay and can see the "pointing at" specific aspects of the video record upon which comments are being made. Stevens and colleagues have used this system in science education museums and in diverse higher education courses including rowing and dance composition, illustrating the value of this methodology for providing a time and space-based interpretive layer on video records. In Cherry et al. (2003), uses of *VideoTraces* in an undergraduate class in dance composition were revealing. They illustrated how providing a concrete representation upon which pointing gestures and voice annotations could be made: (1) supported students in new ways of seeing dance works in terms of concepts and techniques of choreography; and (2) enabled the instructor to better understand students' intentions in their dance work from their *VideoTraces* annotation of that work, and to provide individual feedback. Students considered viewing the instructor's traces on their dance work video as the course component that contributed most to their learning.

*VideoTraces* is guided by Stevens and Hall's (1998) insights on the importance in "learning to see" in specific disciplines, what they call "disciplined perception", in the spirit of Goethe (e.g., Seamon & Zajonc, 1998; Shotter, 2000) and Humboldt from an earlier era who used the phrase to describe the possible objective histories of nature that science enables.

Stevens' use of virtual pointing and voice-recorded commenting within a video record provides a complementary but different mechanism to our use in DIVER of guided noticing for achieving common ground in a referring act in the complexity of a video data stream. As yet the *VideoTraces* system is a stand-alone desktop application written in Macromedia Director, but at a *VideoTraces* installation site, a use community can also make a response on a *VideoTraces* file in the manner of a threaded discussion. Unlike DIVER and WebDIVER, *VideoTraces* does not involve any video transcoding or path authoring activities for the user, or web-based access to such traces.

Diverse computer-based tools are also used for compiling video materials for teacher professional development (Shrader et al., 2002), including commercial products Teachscape and LessonLab. LessonLab (owned by Pearson Education) provides a client-server solution for K-12 schools to

construct their own video case training materials from video that they capture themselves. Related research efforts include the Carnegie Knowledge Media Lab (Young, 2001; see <http://www.carnegiefoundation.org/KML/>), the Case Creator Project (Doerr et al., 2003), Indiana University's Internet Teaching Forum (Barab et al., 2003), STEP (Derry & the STEP Team, 2003) and Schrader et al.'s (2003) work on pre-service teachers' web-based video cases in elementary literacy.

At a more advanced level of teacher competencies, elaborated documentations of professional vision in teaching have been developed at the Carnegie Foundation for the Advancement of Teaching. The Carnegie Foundation, through the Carnegie Academy for the Scholarship of Teaching and Learning (CASTL) and the foundation's Knowledge Media Laboratory, provides exemplary teachers with resources and technical support to fully document an extensive aspect of their teaching, such as a course. CASTL provides fellowship support to allow teachers to devote themselves for a period of 1 or 2 years to the documentation and improvement of their teaching, in part expressed in richly documented web-accessible video (<http://kml2.carnegiefoundation.org/html/gallery.php>).

In the Case Creator Project (<http://www.sci.sdsu.edu/mathvideo/cc/>), teacher educators can create interactive video case studies of teaching by importing QuickTime videos and transcripts, creating an "issues matrix" of many different pedagogical issues that are relevant to the case, add web hyperlinks and/or supplementary text.

As interesting as this distinct efforts are, the most important lesson from our video research workshop (Pea & Hay, 2003) was that, without the use of metadata coding and affiliated XML schema exposing such video analysis metadata to browser search, analyses developed with any of these tools will be stranded in data islands that can only be used and understood within the tool in which they are created.

While the issues affiliated with establishing broadly applicable metadata for video analyses and video cases in learning and teaching are significant, since generic and discipline-specific categories for metadata will be needed, the broader goals of establishing distributed communities that can communicate about their video data productively will be unachievable without such efforts. Productive work in this direction for coding metadata for instructional materials is evident in Gateway to Educational Materials (GEMs) instructional topics hierarchy, and pedagogy elements/values (<http://www.geminfo.org/>), building on the Dublin Core (<http://dublincore.org/>), and in the metadata development activities of the OLAC (Open Language Archives Community, [www.language-archives.org](http://www.language-archives.org)) initiative, which in turn conforms to the larger OAI (Open Archives Initiative, [www.oai.org](http://www.oai.org)). The stated goal of OLAC/OAI is that "any user on the internet should be able to go to a single gateway to find all the relevant language resources available at all participating institutions, whether the resources be data, tools, or advice. The community will ensure

on-going interoperation and quality by following standards for the metadata that describe resources and for processes that review them”.

These efforts are founded on the emergence of the Semantic Web and its uses of the Resource Description Framework (RDF), which integrates a variety of applications using XML for syntax and URIs (Universal Resource Identifiers, which include URLs) for naming. “The Semantic Web is an extension of the current web in which information is given well-defined meaning, better enabling computers and people to work in co-operation.” (Berners-Lee et al., 2001). As noted on the W3C site (<http://www.w3.org/RDF/>): “The RDF integrates a variety of applications from library catalogs and world-wide directories to syndication and aggregation of news, software, and content to personal collections of music, photos, and events using XML as an interchange syntax. The RDF specifications provide a lightweight ontology system to support the exchange of knowledge on the web.”

#### *7.5.2. Distributed Collaborative Video Interaction Analysis*

We believe that video dives will come to play special functions in interpretive activities when people are working to do sense-making together of the records captured in video, whether it is human interactions, teaching behaviors, or other phenomena of interest. Like designers collaboratively working to design objects (Geisler & Rogers, 2000; Hindmarsh et al., 1998), the makers and users of dives take on special relationships with these point-of-view authored video tours as “boundary objects” (Star & Griesemer, 1989) between their special terms and conceptual frameworks of engagement—but opening up the prospects of building common ground (Clark, 1996). Jordan and Henderson’s (1995) paper on the Interaction Analysis Laboratory (IAL) methodology for developing multidisciplinary analyses of video through group viewing of tapes in face-to-face settings illustrates the power of doing better collective thinking when researchers can build video analyses by sharing their perspectives on the observed phenomena and theoretical frameworks that they use to make sense of interactions captured in videos.

Building on the IAL methodology, WebDIVER enables distributed communities to contribute distinctive perspectives that, for example, individual researchers have on a video recorded learning interaction, and to then use the contrasts and convergences to advance their collective understanding of the empirical materials. These needs and an approach for tackling them that we have underway will be taken up in Section 8 on video collaboratories.

#### *7.5.3. Teacher Learning and Teacher Education*

U.S. processes of teacher education and certification are in major transformation given concerns with increasing levels of student performance in

standards-based instruction spurred in part by the federal *No Child Left Behind Act*. Beyond coursework and student teaching, over 40 states mandate that teaching candidates pass tests of basic skills, subject matter knowledge, and/or pedagogical knowledge for certification (Youngs et al., 2003). Since these certification processes are mostly remote from the actual teaching practices, based on written tests and coursework completion, many teacher education programs and states are turning to performance assessments that include video recordings of candidates' classroom teaching practices to make their certification decisions. Video is a potentially more effective assessment method than a written test in providing an unfiltered (even if selective) view of the teacher candidate directly interacting with students.

However, as already noted for learning research, video suffers from a number of obstacles that impede its usefulness, e.g., such as requiring complex knowledge of video-editing software and techniques. And for assessment purposes, video simply does not support the kind of fine-grained access and reference possible with text. It is challenging for a teaching candidate to reference a particular teaching interaction in a video to illustrate how her teaching meets a specific evaluation rubric, e.g., "I promoted conceptual understanding by supporting student inquiry following the question about non-linear functions from the student in the blue shirt in the front left of the room that occurs about five minutes into the video". A scorer of the teacher's video portfolio materials must then search for this incident, and may find it difficult to uniquely identify the candidate's intended event. Scorers of video have the same problem in efficiently and unambiguously pointing to the elements of teaching practice involved in reaching their judgments. The same features that make DIVER uniquely useful for research purposes—using a "virtual camera" to precisely refer to events bounded in space and time within a video, and then attach text annotations to them—make it a potentially transformative technology in the context of teacher assessment and evaluation.

The effort to use DIVER for performance assessment of video records of teaching events builds on other responses to strengthen prospective and practicing teachers' knowledge of both content and content pedagogy, across a broad variety of subject disciplines and age levels, and on portfolio approaches more generally for documenting the work of teaching (e.g., Anderson & DeMeulle, 1998; Athanases, 1994; Porter et al., 2001; Snyder et al., 1998; Stone, 1998). These responses include videocases portraying teaching dilemmas related to content (e.g., Barnett, 1998; Crismond, 2003; Galvis & Nemirovsky, 2003; Horvath & Lehrer, 2000; Koehler, 2002; Mumme, 2003; Schrader et al., 2003), "video clubs" for teachers to review and discuss one another's work (Frederiksen et al., 1998), computer files containing artifacts of an entire year of teaching (Lampert & Loewenberg-Ball, 1998), and videotapes enabling international comparisons of teaching practices (Hiebert et al., 2003; Ma, 1999; Stigler & Hiebert, 1999; Stigler et al., 2000; Ulewicz & Beatty, 2001). Multimedia records portray teaching that

is less filtered by interpretation than vignettes or observations, and avoid the complexity and inefficiency of making sense of multiple observations of different teaching actions that occur when students observe different classrooms.

The use of DIVER provides an opportunity for teacher education programs to reform their practices in ways that increase candidates' ability to construct and apply pedagogical content knowledge, analyze student learning, and reflect on video and other records of practice.

Can video analysis software that permits precise reference into a video and other records (such as scanned student work records) improve the quality of assessment over the use of video and other artifacts without such a tool? Can the use of such software reduce the cost (and thus increase the feasibility) of implementing a performance assessment system for credentialing that includes video? Can teacher candidates' use of DIVER software improve their ability to reflect upon their teaching practices, and to recognize the connection between their practice and state and national standards? Uses of DIVER software for teacher education and certification provide a powerful research opportunity to produce knowledge that can guide teacher education institutions and certification agencies.

We have begun to explore these questions in a partnership with the California PACT (Performance Assessment for California Teachers) initiative, designed to respond to 1998 state legislation (California SB 2042) aimed at ensuring that schools employ only "highly qualified" teachers. SB 2042 required that teacher education institutions use a teaching performance assessment certified by the state Commission on Teacher Credentialing to align with California's Teaching Performance Expectations. Twelve California colleges and universities created the PACT consortium to pilot and implement Teaching Event portfolios in this context, and in 2002–2003, more than 600 candidates (and over 125 trained scorers) piloted PACT Teaching Events in the areas of elementary education, English/language arts, history/social science, mathematics, and science. For each PACT Teaching Event, or unit of instruction, candidates completed several entries including: Teaching context narrative, lesson plans, 1–2 videotapes of subject-specific teaching and learning tasks during the unit, analyses of their students' work, and written reflections. These assessments are presented in terms of a Planning, Instruction, Assessment, and Reflection (PIAR) model whereby the teacher certification candidate uses knowledge of students' skills and abilities, coupled with content knowledge and pedagogical knowledge—how best to teach that content in planning, implementing, and assessing instruction. In 2003–2004, all 12 PACT institutions continued using the Teaching Events, 1000 candidates piloted PACT Teaching Events, and pilot uses of DIVER were deployed in this context. Unfortunately, California's budget crisis has put the SB 2042 requirements on hold, and with it, our prospects for undertaking these collaborative studies with the necessary funding.

Nonetheless, there is great promise inherent in California's development of the PACT Teaching Events, as it is consistent with a national trend in which several states and national organizations have created performance-based assessments for teachers including teacher-developed portfolios, classroom observations, and structured interviews (i.e., the Educational Testing Service [ETS], the Interstate New Teacher Assessment and Support Consortium [INTASC], the National Board for Professional Teaching Standards [NBPTS], and institutions seeking accreditation from the National Council for the Accreditation of Teacher Education [NCATE]). PACT Teaching Events could eventually be used in combination with the NBPTS assessments to establish a professional continuum whereby teachers have comparable assessment and professional development experiences throughout their careers. These assessments have many common aspects in being standards-based, content-specific, and involving videotaped instruction, student work products, and reflective analyses of planning, teaching, and student learning.

We hope to have the opportunity to experiment with DIVER use in embedded assessments during teachers' coursework, which would provide an opportunity to capture additional information about candidates' teaching fitness as they proceed through their teacher education program. Such work would provide the occasion for investigating how digital video provides value added over text in the case studies used today (Shulman, 1992). There is relatively little research about how video works in learning: What is the process by which teachers learn from digital video case materials about what types of events it is important to notice, and how to reason about what should be done in such situations, in ways that lead to improvements in their teaching actions and in student learning outcomes? Our plan in the PACT work was to have teacher candidates use a modified version of DIVER to reflect upon and annotate the videos and other media that they submit as part of their PACT Teaching Event performance documentation. DIVER now presents a blank worksheet to be populated with video clips and annotation, but it can be modified to establish a scaffolded worksheet requiring teacher candidates to identify, through video examples and affiliated media, including a description of their teaching context, lesson plans, student work samples, and written reflections, those facets of their teaching that satisfy criteria or tasks that are part of the Teaching Event.

This approach builds on a model of the teacher education process as developing prospective teachers' ability to think analytically and reflectively about their teaching performance (Grossman, 1990; King, 2002; Schon, 1983; 1987; Zeichner & Wray, 2001). Locating specific classroom events in terms of a body of professional knowledge about teaching is a crucial capability in integrating the general content of teacher education into consistently effective practices of teaching. A performance assessment system thus provides an evaluation of the teacher candidate's ability to both construct an effective teaching performance and to reflect upon that performance in professional terms.

This design approach closes the gap between the assessment criteria and the teaching fitness evidence—the video record of the teaching performance and supporting materials of plans and student work. Evaluators would see a worksheet populated by the candidate with clips, document highlights, and text annotations that express precisely how the candidate believes that he or she has satisfied PACT assessment criteria. The evaluator would use the DIVER worksheet to quickly but accurately assess the candidate’s understanding of the standards and his or her performance, and can easily refer back to the full video record of the Teaching Event to settle questions that arise.

#### *7.5.4. User Studies*

A large field of use for video is in the human–computer interaction field, a design-oriented discipline in which records of users interacting with software, information systems, or computing devices are analyzed to understand problems users are having that could be improved through user-centered design accounting for forms of support and resources given discoveries about the user’s information needs during tasks (e.g., Allen, 1996; Dourish & Button, 1998; Ehn, 1988; Laurel, 1990; Preece et al., 2002; Schuler & Namioka, 1993; Winograd, 1996). The concept for using DIVER in this line of research is tightening the loop between design prototyping, use study and iterative re-design driven by what is learned from use studies. Participatory design methods could also incorporate stimulated-recall sessions with users who reflect using DIVER on video captured of their use of prototype or new technologies in context (inspired by Iacucci et al., 2002; Masten & Plowman, 2003). The DIVER researcher can capture video, and after uploading it to the WebDIVER communication server, can either create dives in the DIVER desktop application or directly on streaming video from the WebDIVER site through a web-browser. These dives could highlight specific facets of the user interactions that reveal problems, and with their web accessibility could immediately enable the designer or design team to review the dive to learn about problems with their design and, if offered by the diver, suggested resolutions.

#### *7.5.5. Scientific Imagery, Visualization, and Models*

We have begun to explore DIVER as a tool for diving ever more deeply into the study of visual phenomena apart from human behavior and interaction. The different kinds of applications that we see as fertile fall into a number of different higher-order classes, with extensive branching below in the hierarchy. For each class, we see utility in two broad types of DIVER use—for static and dynamic (time-varying) materials. The higher-order classes I will differentiate here are (1) image analysis at any scale, (2) visualization analysis at any scale, and (3) visual model or diagram analysis.

#### 7.5.5.1. Geo-spatial and Semio-spatial Representations

An additional distinction of note is that between representations that are “geo-spatial” versus “semio-spatial” (see Roschelle & Pea, 2002). Both class (1)—*images* (such as photos)—and class (2)—*visualizations* (such as geographic maps)—are geo-spatial. But class (3)—*visual models and diagrams*—also important scientific representations, are commonly semio-spatial. We define geo-spatial representations (geo = “of the world”) by formally specifiable mapping functions from measurable spatial parameters of the physical world (distance and direction, as in terms of height, depth, width) and their representational system counterparts (i.e., inscriptions: e.g., 2D and 3D maps, drawings, photos). These mapping functions are not always isomorphic, as in the renowned Mercator projection for the earth’s surface, producing distortions at the poles. Geo-spatial representations are geo-gridded, a common property of many scientific visualizations (e.g., Goodchild, 1992; Gordin & Pea, 1995; Pea, 2002), in that they incorporate latitude and longitude grid “cells”, which may vary in their resolution from coarse to minute.

The important differentiation for semio-spatial representations is that their spatial attributes *are not mappable* to spatial attributes of the physical world. Consider several familiar semio-spatial representations by which we may illustrate this important difference: *graphs* of all sorts, and *concept maps* (which represent taxonomic and other typological relations in the form of directed graphs), *flowcharts*, and *organization charts*. Yet, importantly for the human activity of guided noticing, both geo-spatial and semio-spatial representations are usefully exploited for supporting reasoning, argumentation, and deictic functions that are important for establishing co-reference and attentional alignment of different individuals in their communicative purposes.

With this distinction as backdrop, let us now consider the three categories of diving for scientific inquiries that I believe are useful to distinguish (1) image analysis, (2) visualization analysis, and (3) visual model or diagram analysis.

#### 7.5.5.2. Image Analysis at Any Scale

Whether one is looking at a nanotechnology scale at atom assemblies or a cosmological scale involving astronomical images from the origins of the universe, the guided noticing framework of DIVER provides a powerful facility for establishing referential common ground—among scientific experts or in educational communications. We have been looking at DIVER use for a broad range of different scientific applications involving static images: Here we will briefly describe prospects concerning medical, astronomical, and satellite imagery.

Consider *medical imagery*. Whether images are captured with microscopes, X-ray machines, CAT scans, f-MRI technology, or simply cameras, the images



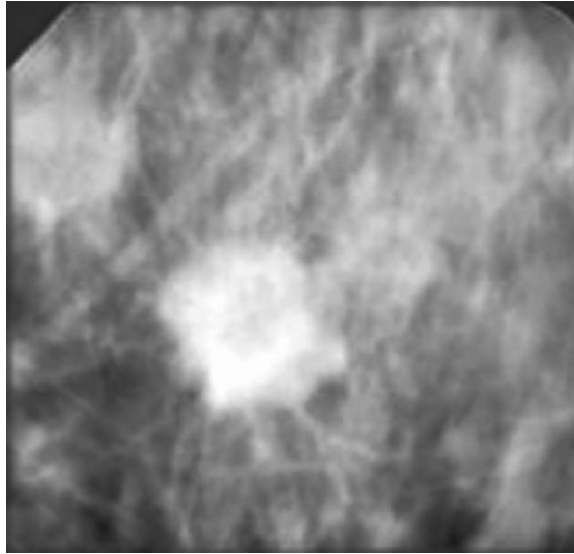

Figure 8. A malignant tumor revealed in a digital mammogram (Electronic Radiation Laboratory).

are complex and multifaceted in nature, revealing differentiation and structure. In radiology, a common issue is diagnosing whether a tumor is revealed, say in a mammogram (see Figure 8).

Use of guided noticing in DIVER provides a focusing and naming mechanism for depicting the malignant organ part in a radiological image, and a DIVER collection of clear cases of tumors, clear cases of non-tumors, and differentiating properties of boundary cases (tumor, non-tumor) could be used for training up diagnostic vision among mammogram analysts.

Consider *astronomical imagery*. In the Sloan Digital Sky Survey (<http://www.sdss.org/>, <http://skyserver.sdss.org>), the field of astronomy is collaboratively developing an exceptional resource for aggregating all observations and imagery of the skies visible from the Northern Hemisphere for advancing scientific discovery in the field, with over 100 million astronomical objects already logged in over 200 terabytes (TBs) of data. The virtual observatory in development as SkyQuery (<http://www.skyquery.net/>) enables interactive queries of astronomical data from the SDSS, so that one can zoom in or out, investigate adjacent phenomena, link through to publications on the astronomical object referred to and so on. Figure 9 illustrates the exquisite spiral of an astronomical object called “NGC 3521”.

We can foresee DIVER use for assembling a database of dives to illustrate for educative or research purposes multiple examples of a particular astronomical categorical type (e.g., spiral galaxies, edge-on galaxies, interacting galaxies), where particular differentiating features of these entities are established using DIVER’s path movies, guided noticing mechanism, and annotations.

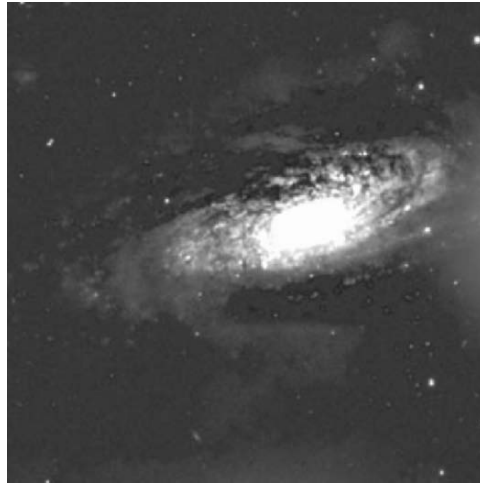

Figure 9. The famous “spiral” astronomical object NGC-3521 from the Sloan Digital Sky Survey (<http://skyserver.sdss.org/dr1/en/tools/places/page2.asp>).

Finally, consider static *aerial, satellite, and topographical images of the earth’s surface*. As in the case of the SDSS, a vast online atlas has been developed—the TerraServer website (<http://terraserver-usa.com/> provides United States imagery and <http://terraserver.com/> offers European and Asian imagery)—which integrates over 15 TBs of aerial imagery and 1.5 TBs of topographic maps from the U.S. Geological Survey. These photographic images, one per location and averaging 5 years old, are captured with medium resolution cameras so as to identify geographical features (not people, autos, or houses), as illustrated in Figure 10. Another such resource appearing in 2005 was Google Earth.

Using such images with DIVER, one can create “dives” for a variety of purposes involving geographic information. Urban planners and landscape designers can depict flow routes and landmarks, and create dive commentary on their inter-relationships—for historical teaching, for designing based on prior art (or overcoming its limitations), for discussions with citizenry to explore issues and environmental impact concerns of anticipated changes in a city or town’s landscape.

My intent here is to be illustrative in sketching medical, astronomical, and geographical imagery that is static in nature but nonetheless provides a rich resource for diving with DIVER, across the expert research, diagnostic use, training, and expressive communicative use categories that were distinguished earlier.

Although I have been focusing here on the values of diving on *static* imagery, dynamic, animated sequences of images, at different time scales, can yield crucially new and different kinds of information to support theory-driven inferences about developmental, causal, and other relationships that



Figure 10. An aerial photo of Stanford University Quad from 1991, downloaded from the TerraServer, with 2-meter resolution.

lie latent in the static image on its own. In my work during the 1990s on scientific visualizations for learning, I was struck by the power of a time-lapsed video sequence of San Francisco skies captured by the Exploratorium Science Museum; it revealed different strata of clouds that were moving in different directions at wildly different speeds, an effect I had never observed in the normal time-course of experience. MIT's Harold Edgerton, through his invention of high-speed photography and film using stroboscopes, brought a powerful new machinery for "seeing the unseen" in the visual world, from hummingbird flight to bullets bursting balloons to the atomic blast (Bruce, 1994; Edgerton et al., 2000). When coupled with DIVER's use of the virtual camera guided noticing mechanism, science investigations of dynamic imagery provide an exciting arena for further development and research.

#### 7.5.5.3. Visualizations at Any Scale

While still geo-spatial in their fundamental nature, scientific visualizations (as distinct from imagery), utilize a geo-gridded framework and superimpose upon it representations of data values for variables that have been either directly captured through observational instruments or inferred in terms of a model for interpolating between the distinct locations where data are collected. A reference point is provided by the commonly experienced graphics from the newspaper *USA Today* and TV news weather reports: The use of a

false-color map representing the range of temperature in degrees Fahrenheit or Celsius on a geographic map. While these weather data are useful at a particular point in time, for reading out the actual or predicted temperature at specific locations on the map, it is only from animating a sequence of such visualizations that the patterns of change that indicate “fronts” (highs and lows of pressure that influence temperature and precipitation changes) become evident, among other emerging inter-relationships between the data quantities visualized.

Scientific visualization dramatically changed scientists’ practices in recent years by “using vision to think” (Card et al., 1999), exploiting human visual pattern perception for complex investigations within large data sets (e.g., Brodie et al., 1992; Cerf et al., 1993; Nielsen et al., 1997; Tufte, 1997; Wolff & Yaeger, 1993). Such visualization provides an image rendered through high-speed computer graphics that is based on a numerical data set that describes some quantity in the world (e.g., global temperatures). The field of scientific visualization came to broad visibility after a major report provided an integrated account of the productive collaborations that were emerging from the disciplines of science, computer science, and visual arts (McCormick et al., 1987). Such scientific visualizations commonly leveraged uses of color, shape, and motion to provide new visions into the structure and patterns that could be teased out of large and complex data sets. Gordin and Pea (1995) observed that scientific visualizations are generally characterized by how they (1) incorporate massive amounts of quantitative data, (2) aim for verisimilitude with the phenomena they represent, (3) attempt to represent entire phenomena holistically by interpolating from data, (4) employ color and shape to encode the magnitude of variables, (5) use animated sequences to show progression over time, and (6) rely on high-speed computation to generate images.

Gordin and Pea noted that scientific visualizations, while often similar to digital photographs in containing a set of values that can be rendered by mapping each number to a particular color, vary from digital imagery in that the numerical values composing a scientific visualization image commonly represent abstract quantities (e.g., precipitation), not formed from the variable intensities of visible light used in photography. A color range is defined according to which various values of precipitation are assigned specific colors, so that a geographic map can depict a digital image of variation in precipitation across the region displayed. The variations and patterns of color allow one using scientific visualizations to discover underlying patterns more straightforwardly than by scanning over data tables for different geo-locations. They may reveal to the human senses what could readily go unnoticed in a typological representation such as a data matrix or function. Underlying processes may also become visible if successive images over time are animated. By design, scientific visualizations strategically engage color and motion in order to tap the human visual system’s capabilities.

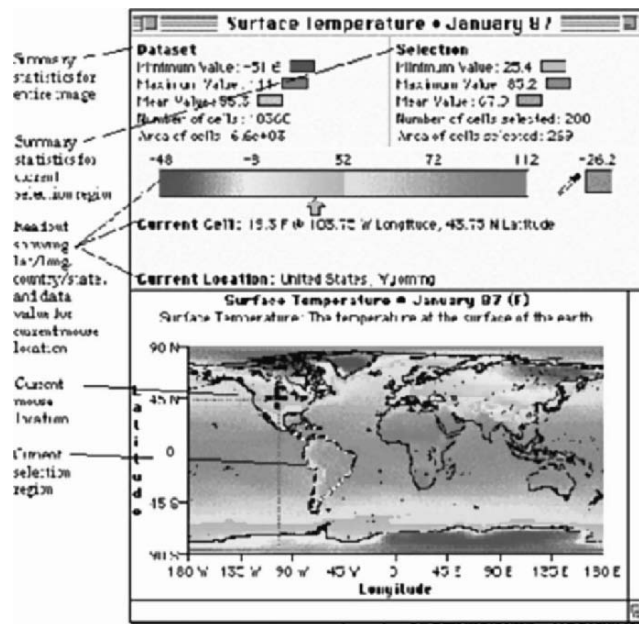

Figure 11. A WorldWatcher visualization window with key to what is represented.

In our Learning through Collaborative Visualization (CoVis) Project (see Pea, 2002; <http://www.covis.nwu.edu>) at Northwestern University, and the related WorldWatcher software development and curriculum projects (Edelson & Gordin, 1998; Edelson et al., 1999; <http://www.worldwatcher.northwestern.edu/>), we developed a powerful open framework in which static and animated visualizations could be created for project-based scientific inquiries from scores of public domain geo-gridded data sets as well as personal data. WorldWatcher provided a learning and inquiry environment for students to explore data sets created by the scientific community (and to also create their own data using built-in arithmetic operations and climate models) while providing key features for data display and analysis commonly used in the powerful, general-purpose visualization environments of scientists. For example, the mapping of variable values to colors is used to display 2D global temperature data (as in Figure 11) on a geographical information grid with latitude and longitude border marks and an overlay of a continent outline (optional). When a user interacts with the WorldWatcher visualization, a continually updating readout tracks the user's mouse location and displays current latitude, longitude, country or state/province, and data values.

In their inquiries, users may tailor visualizations by modifying color-scheme, mapping of colors to numerical values, spatial resolution, and magnification. Statistical summaries are provided for regions a user selects, for whole maps by specifying geographic areas (by name), or data values (by

ranges). WorldWatcher also offers select operations for mathematical data analysis within an image so that users can add, subtract, multiply, or divide all the values in a region or an entire image by a constant (as well as normalizing values for an image). WorldWatcher users can apply a function at each location in two different images using any of a set of binary operators—addition, subtraction, multiplication, division, maximum, minimum, and correlation—which then yields a new visualization as a result.

WorldWatcher data sets for global climate change for examining the transfer of energy through the earth–atmosphere system (e.g., absorbed/reflected solar energy, surface temperature) are complemented by human and physical geography data so students can examine sources and impacts of climate change. Global climate data on precipitation and relative humidity are provided, as are physical geography data on elevation/bathymetry, soil type, dominant vegetation and ground cover, and plant energy absorption (FPAR). Students may also access global information on population magnitude and density, carbon emissions, and national boundaries.

What is the relevance of WorldWatcher for DIVER’s guided noticing framework? It is the pre-eminent example of scientific visualization software tools and data sets used for pre-college education. Yet many practical challenges affiliated with its use in an educational setting arise from the difficulty of establishing common ground to what is being referred to in a learning conversation between individuals that has WorldWatcher scientific visualizations as its source. WorldWatcher users have powerful display and analysis capabilities, akin to those of scientists. They also have very useful notebook facilities that enable users to author text, and paste in visualization window results, animations and hyperlinks to specific visualizations. But even with these facilities, the complex visual arrays of information represented by its visualizations cry out for a complementary tool of guided noticing such as DIVER could provide.

How might this work? WorldWatcher already supports the creation of animations in the form of Apple QuickTime movies from a meaningful sequence of visualizations. Such animation capability is especially useful for time-series data, as in the 12 different visualizations of global temperature data (or insolation), one per month, so as to highlight the patterns of temperature (or incoming solar energy) and their distribution over the earth’s surface. But a learner can easily need to refer to specific time–space pathways through such an animation—as DIVER would support for such animated movies—rather than the animation as a whole representing the whole earth’s surface. These movies can only be played within the WorldWatcher application today, but we can see how diving into both the dynamic and static scientific visualizations that WorldWatcher enables users to create could provide a crucial enhancement to their meaning-making and expressive capabilities concerning their beliefs and evidence for them in the data analyses that they are constructing. These same arguments apply to other scientific visualization environments that

may be used to greater effect for learning and establishing common ground in conversations by use of DIVER's guided noticing capabilities.

#### 7.5.5.4. Visual Model or Diagram Analysis

In Section 7.5.5, I observed that whereas both scientific imagery and scientific visualization are geo-spatial and turn in part for their meaning on the mapping between the spatial co-ordinates of the world that they represent and features of the representation, visual models and diagrams do not necessarily share this property. Instead, they are semio-spatial, in that the use of spatial distinctions in the external representation (or inscription, as Latour would call it) has a utility defined by social convention but that does not map onto a geographical grid according to any mathematical function. The spatial relations depicted in the visual models or diagrams are often not to scale (e.g., diagrams of the planets in our solar system never are). Furthermore, visual models and diagrams often introduce arbitrary conventions for the uses of space; as in Cartesian  $x$ - $y$  co-ordinate graphs, or flow charts in operations research or computer science.

Concept maps are used as a technique for representing knowledge in graphs, or networks of concepts, which are made up from nodes and links that connect the nodes. Typically, nodes in concept maps represent concepts, and links represent their inter-relationships (e.g., causes, is-a, is-part-of, son-of, comes-after). These representations are often used as an instructional technique but also for learning assessment and for brainstorming in a group (e.g., Lawson, 1994; Novak, 1998). It should be clear from this characterization that the spatial relationships in concept map representations are not geo-gridded in nature.

This category of representation, as with the categories of scientific imagery and scientific visualizations, encompasses a great plethora of examples. And many of the tokens of this type also have their static and dynamic, time-varying types (e.g., one can play out different successive states in such a diagram model of a set of conceptual relationships, as in moving an object progressively toward a concave mirror and depicting when the image "flips" in orientation). In many scientific fields, visual explanatory models are established that are semio-spatial in structure and not intended to convey spatial mapping onto the world's co-ordinates. These models may be two-dimensional, three-dimensional, and four-dimensional (with time as the fourth dimension), and can encompass much harder to visualize  $4 + n$  dimensions.

There are hybrid representations that incorporate both geo-spatial and semio-spatial aspects, as in physics force-diagrams, particularly when used in educational software programs such as *Interactive Physics* (Figure 12) or *Working Model* (<http://www.krev.com/>), or in simulations for teaching physics such as the Java applets of the Constructing Physics Understanding Project (<http://cpucips.sdsu.edu/>). In such examples, representations of

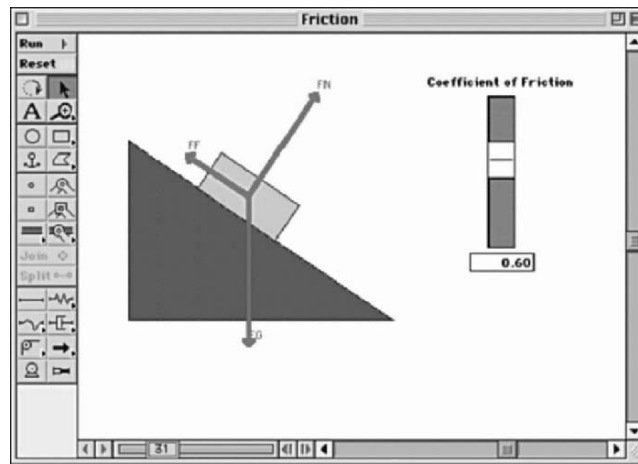

Figure 12. Physics diagram illustrating geo-spatial and semio-spatial properties.

conceptual entities such as forces are superimposed on *schematic* diagrams of a *general* type of physical situation, which has spatial properties although how they map onto any specific geographical space is not of primary concern; they are intended to represent the general case of such a situation, wherever it is embodied in the world. Other similar examples are diagrams used to depict ray-tracing in geometrical optics to explain how images are formed (Pea, 1992, 1994), energy diagrams depicting how heat, light, and sound are propagated through different materials (Linn & Hsi, 2000), and schematics of electrical circuits and how current flows in them with batteries and bulbs.

As in the case of scientific imagery and scientific visualizations, we would argue that DIVER's guided noticing provides an important capability for use with such representations, whether for purposes of instruction, assessment, or the needs of the expert in the field communicating about their beliefs or results to colleagues. In many of these complex representations, specific part-to-part relationships are the subject of a commentary or interpretation, and it is difficult to refer at the "whole model" or diagram level. While pointing arrows or circled regions are commonly used to refer to a specific component of a visual model or diagram for labeling or interpretation in the acts of communication or teaching, it is challenging to make reference to multipart connections within such representations—and harder still to respond to them in a precise way.

These issues could potentially be resolved by the use of a DIVER worksheet that takes as inputs either static visual models or diagrams, or their depicted changed states over time, and in use scenarios where the user dives on these representations to make a point or raise a question that involves connecting diverse components within the DIVER input representation.



#### 7.5.6. *Art, Photography, and Diver: The Virtual Docent*

What does the art expert see in the works that he or she views? How do experts disagree about what there is to see in a given painting? Most of us have toured an art museum and been led on walks through exhibits of paintings, sculpture, photography, and other cultural artifacts. The docent who leads such tours, whether a seasoned expert art critic or historian, or simply a knowledgeable hobbyist who works for the institution, has a stock of professional vision that they bring to bear in this social practice. They know where to focus their attention on the figures or features of works that bear close scrutiny, and how to use the categories of interpretation and inter-relationships among artists, periods, historical events, and other factors to provide any one of a number of hermeneutic accounts of what is in view. There are many art books in print, as well—exemplified in works such as John Berger's (1972) *Ways of Seeing*—that seek to provide support for others to learn to notice properties of artistic works and how they illustrate specific techniques, influences, or emblematic characteristics of a school such as Surrealism or Impressionism. Picasso's painting *Guernica* is a favored example of a famous and influential work requiring such interpretive gymnastics to bring its senses to the viewer (e.g., Martin, 2002).

DIVER makes it easy to take such transient practices as the art museum tour, today repeated again and again and primarily face to face in the art museum itself with original works, and to create "virtual docents" (a concept suggested by Rayward & Twidale, 1999, among others). Indeed, the WebDIVER database established from art analysts' dives on media recordings of art originals (or scanned versions of their reproductions) may also encourage a form of comparative activity in which multiple interpretations of an artistic work could be established, and form the grist for either online or seminar-based reflective discussions. Art museums could provide docents with DIVER to use to craft reflective tours using guided noticing and annotations for remote visitors of different ages and interests, not only a one-size-fits-all form like today. And more imaginatively, it would be possible for WebDIVER visitors for art museums to experience different dives about a significant work and make their own comments and ratings of these dives, much as user communities today can do for books in Amazon.com or sellers in Ebay.com. Then one could come to view, depending on one's preferences, only the dives of greatest perceived value for any given art work.

The same categories of use we have seen for video records of teaching practice and scientific imagery and visualization apply in this case. The art expert can use DIVER for professional analyses; the art instructor may use it for guiding the development of professional vision for students and affiliated assessment activities, while the public may engage in informal communicative exchanges surrounding their interests in art.

As we enter a new media era in which more and more digital representations of artistic works are being established so that a world of computer users with web access may experience them in some manner from afar (e.g., <http://www.archimuse.com/>), the needs of being able to refer to specific features of these works as an anchor for annotations and interpretive discussions will also grow. The Getty Museum among others has begun to recognize this need in its use recently of a web software-authoring tool called *Zoomify* (<http://www.zoomify.com/>), which makes it possible to interactively pan and zoom atop still images (<http://www.getty.edu/art/exhibitions/flemish/zoom.html>), akin in spirit to the DIVER guided noticing mechanism.

With the development of methods that extend the user experience of an art work temporally by providing interactive methods for exploring its representation in a digital medium, such as interactive 3-D depictions of sculptures that one can virtually walk around, or interactive panoramic static imagery of large spaces such as churches or city streets captured in immersive media like Apple QuickTimeVR using 360° rotational filming techniques (e.g., <http://www.multimedialibrary.com/>), we are increasing the challenges of making precise references to the facet of the art work for interpretive focus. What DIVER can bring to these interactive art experiences is a storytelling, guided noticing technology for one to be able to re-purpose those fascinating representations to author one's own point-of-view perspective on the artistic works thus represented.

#### 7.5.7. *Film and Cultural Studies: Motion Pictures, Documentaries, Television, and Advertising*

If the need for guided noticing to establish common ground for interpretive discussions and teaching of professional vision is evident for static art works, it is certainly a paragon need once we enter the semiotic realms of film and television. Whether the medium is fictional, documentary or art film in focus, a soap opera show or simply a television ad during the SuperBowl, the path-movie techniques of DIVER provide an indispensable tool for film and cultural studies.

Film school students spend considerable time studying major filmmakers, film genres such as *film noir* or *new wave cinema*, the grammar of cinematography (Metz, 1974) including shot segmentation, camera rotational movements (*pan* on *x*-axis, *tilt* on *y*-axis, and *dolly* on *z*-axis), and transition effects (cut, fade, and cross-fade) as well as narrative techniques such as montage and flashbacks, and the new computer morphing and animated special effects that have defined recent developments of this cultural medium, as in *The Matrix* films. And then they create film works to bring to light their own creative talents, inevitably grounded in how they come to be interpreted by others in the

works of an earlier era that created the categories we now view as significant (when we “see”, for example, the use of Alfred Hitchcock’s techniques for establishing terror in the films of Brian DePalma).

DIVER provides a new tool for the film school faculty member and the film student to develop the hermeneutical talents and web of perceptive knowledge that ties together the history of films, filmmakers, film methods and techniques, and film criticism. Being able to create annotated dives about a film, its makers’ works, and the perceptible influences of other film works would be an exceptional resource for the film industry and filmmaker education.

The practical challenge is to establish the digitized films for use in DIVER software and to ensure that the digital rights are preserved for the film owners. It may also be controversial among filmmakers to have people diving on their films, for derivative works resulting from such techniques as the colorizing of black and white films by Ted Turner on TNT Cable have not been popular. But because of the focus plus context interface for DIVER film analysis (i.e., the full film view is always available so that the virtual camera focus window contents can be seen in context), and the fact that one is not creating new movies during Diving but simply making a replayable view onto the original movies, it can plausibly be argued that DIVER is providing a kind of conceptual spectacles for seeing movies, and not making derivative works.

Although I have emphasized film, the same points apply for media-based studies of popular culture through mass communications including TV programs, news, and advertizing, whose forms and techniques also have cultural histories and interpretive needs for guided noticing (e.g., Goffman, 1979; Williamson, 1994). There are also many thousands of historical film archives among the million digital artifacts represented in the American Memory Project of the Library of Congress (<http://memory.loc.gov/>), and the Internet Archives (<http://www.archive.org/>), which could be used in DIVER to illustrate specific genres, attitudes, behaviors, or phenomena of a particular historical period.

#### *7.5.8. Sports, Concerts, Travel, and Other Forms of Entertainment*

Films and shows of sporting events, musical concerts, plays, dances, and other performances provide compelling media for DIVER use as well. For example, even with the rapidly growing prevalence of people on chat channels and online forums discussing television shows even as they are being watched, it is impossible to anchor these discussions in specific time–space segments of particular shows. Viewers use awkward circumlocutions to tie their questions, approvals, and complaints to specific parts of these media events. DIVER would allow not only video-anchored discussions of popular media from broadcast television of news, sports, and music and other events,

but path-movies and annotations that reference very specific segments of what happened for purposes of discussion.

Sports events are becoming an increasing realm of technological innovation to enhance the user experience for that event—new interactive television methods provide a pay-on-demand user with the capabilities to switch among different cameras trained on a football game (from the coach to players wearing helmet cameras, as in *OpenTV's* service for over 20 million World Cup Fans in 2002 enabling viewers to select camera angles, and view statistics on players and teams). And *DartFish*, a Swiss company with the slogan “Making the invisible visible”, uses video image processing to provide dramatic image overlays of different skiing trials during the Winter Olympic Games and other sporting events. In another example of interactive applications, Dartfish’s 3D Visualization technology made its TV debut during the 2003 Alpine Ski World Championships. It provides a 3D virtual reality landscape of a real racing environment by precisely reconstructing the course traveled during a race by each competitor and then situating them in the 3D landscape so that spectators can experience an unrestricted view of the actual race, watching it from any angle at any playback speed. But much more interactivity is possible if the sports lover could dive on different video records of the sporting event and send links to their uniquely authored dives to friends and others—their perspective, path, and commentary on the dynamic events of sporting, from the great play to the botched catch. Such an application of DIVER, if it could be established among the sporting program producers, or made accessible as a capability at their online sites, could become a new cultural medium for sharing sporting experiences.

Another example is the television travelog—the tour to Rome, the Yucatan’s Aztec ruins, nature experiences in the jungles or African Sahara, or Darwin’s Galapagos Islands. Today’s travelogs tend to be monologs, but with point-of-view authoring many different travelers could utilize a database of panoramic video (or other videos) and make their own DIVER movies to communicate about what they found compelling. These dives could be shared as DIVER video blogs with family and friends at home but more broadly they could be posted online with the likelihood of stimulating greater tourism, and be classified according to the demographics and interests of those who are making the dives (show me Cairo from the point of view of the ancient Egyptian scholar). The advent of video camera cell phones could accelerate this vision substantially.

#### 7.5.9. *Training of All Kinds*

DIVER’s guided noticing approach for any user to author and annotate path movies within movies for web publishing and reflective discourse has potentially broad applicability for training in virtually any work sector. Typically learning is affiliated with the development of professional vision

and comparative discrimination of higher and lower forms of performance that learning from dives created by instructors may enable. Of course, watching Tiger Wood golf videos is no substitute for playing golf oneself, and the importance of learning from comparative analyses of one's own performances and those of an expert is well recognized already in commercial video software tools for sports training available from such companies as SportsTec, Dartfish, and Pinnacle. Enhanced perception in a professional sphere alone will not usually suffice for expertise (with judging of sports such as gymnastics, skating, and diving providing interesting exceptions)—it is the application of that enhanced professional vision when coupled with the actions appropriate to expertise in the domain that is the intention of video-enhanced instructional processes.

It is perhaps less well known that video is extensively used for high-stakes training in applications such as mock jury trial preparation and witness deposition, police handling of crisis events, and making effective sales closings for costly products (e.g., ultrafast internet backbone switches). Whether in applications such as these, or in routine forms of workplace or corporate training ranging from running quality meetings to using factory machines correctly, providing DIVER as a tool for simply creating instructional dives on *in situ* performances, and enabling diving on the learner's own performances could serve on-the-job training.

## 8. TOWARD DIGITAL VIDEO COLLABORATORIES (DVC)

In the last section of this chapter before considering future directions, I will outline our approach to developing an infrastructure for integrating video analysis, sharing, and collaboration in research communities, although it can have broad applicability in the other cultural spheres sketched throughout this chapter.

### 8.1. A DVC User Scenario

The following user scenario of behavioral scientists using video-as-data illustrates the capabilities we are developing with our colleague Brian MacWhinney of Carnegie Mellon University to enable a new form of scientific dialog based on detailed examinations of video. Using current practices and tools, the scientific work described below would not be feasible. Consider a scenario where a researcher learns about a new finding in a peer-reviewed journal in her field, and has a competing interpretation for the phenomenon (e.g., 4 year olds use of their fingers in solving counting problems). She searches the DVC for examples of such counting phenomena and finds six relevant data sets, physically located in video repositories at a number of different

universities, all contributed to a distributed data registry when other researchers provided open access to their data when they published their related work. She analyzes these cases of hand-gestures children used during counting by exploiting an existing coding scheme for video analysis of hand-gestures, loading it into the DIVER interface as a plug-in. Her hunch appears warranted; working from these open source data, she finds significantly more gestures supporting her theory over the claims of the published work she has been reading. She and her students collaborate to develop a dive—a worksheet containing annotated video selections from the data sets she has found through the Collaboratory—that sets forth her theory of hand-gestures, and she contributes the dive to the Video Collaboratory. She sends an e-mail with a hyperlink to her group’s new video analysis to the journal article’s author and a network of other researchers who are interested in children’s counting behavior.

The Video Collaboratory e-print posting of her claims as a commentary to the published work sparks a lively discussion, engaging the article’s author, who dissents from her conclusions on the gestural data in children’s counting. He responds by reinterpreting the same video cases that she has analyzed, and after several cycles of data analyses, interpretations, and researcher communications, she submits her team’s revised e-print as a formal submission to the journal, hyperlinking it to the digital video records and dives comprising their analyses. During the article’s peer review process, one reviewer calls for better reliability data for her gesture categorizations from the videos; and she responds with a new round as part of a revise-and-resubmit cycle with the journal’s editor. Soon her paper is accepted and published, with its multimedia data analysis history in the Video Collaboratory made accessible to the interested readers.

This scenario illustrates how a number of central research activities will be fundamentally enabled by a DVC infrastructure. After outlining our conceptual analysis of this future, I will briefly sketch the technology we are building for enabling this new mode of research.

## **8.2. Three Obstacles to a Digital Video Collaboratory**

Research communities constitute the social infrastructure for scientific knowledge building, as the human networks through which data are shared among colleagues located at different institutions, research results are circulated and critiqued, journal editing positions are staffed, and manuscripts and publication decisions are vetted. Enabling these communities to use video, not only text, requires removing three obstacles:

1. Video data and analyses must be universally accessible independently of its physical location. Today, video data reside in many heterogeneous repositories, with separate access control, user interface, and querying syntax. We aim to remove this obstacle by developing a virtual

repository, building on grid-enabled middleware in combination with an API (application program interface) and metadata scheme designed to support research use of video-as-data.

2. Research communities must have access to video analysis tools that support discipline-specific analytic practices of annotation, coding, and reference, while enabling communities to make use of existing applications and infrastructure where possible. Today video analysis tools make few provisions for interoperability, forcing researchers to commit to one tool or toolset rather than allowing use of multiple tools. We seek to remove this obstacle by developing generic and discipline-specific XML metadata schema for video analysis, and flexible desktop and web-based video analysis tools.
3. Analyses and commentary must be available for public participation, collaboration, and publishing, including circulation and feedback among smaller groups of researchers. It is extremely difficult now to publish video analyses through the web, and we lack a platform for sustaining video-based collaboration and critique. We are removing this obstacle by developing DIVER as a web-based video analysis and dive-authoring tool.

By removing these three obstacles, we will enable the creation of a DVC: A network of shared video resources, analyses, and collaboration opportunities located within scientific research communities. The following sections briefly address each of these DVC elements in turn.

### **8.3. Virtual Repository for Video Data and Analyses**

We use the phrase “virtual repository” to characterize a distributed set of heterogeneous video and metadata repositories that appear to users and client tools as a single searchable repository. A virtual repository is a key element in a Collaboratory as it provides a research community with a touchstone corpus of empirical materials and analyses to which members may have access (Berman et al., 2003). There currently exists no such virtual repository for video data in the human sciences, although the *Open Video Project* has developed a large testbed resource for digital video research work on such problems as automatic segmentation, summarization, creation of content surrogates, and developing face recognition algorithms (Geisler et al., 2002). The closest analog is *TalkBank*, which provides a few heavily used and oft-cited data corpora (particularly audio data) in a number of language-related sub-disciplines. However, TalkBank is currently a single repository with a site-specific user and software interface, requiring local knowledge, such as what kinds of materials are likely to be found.

Even if a research community could be built around a single repository, video storage requirements mitigate for distributed storage. The storage needs are vast for even 100 researchers contributing a few hundred hours of video (a common corpus size for a single study) at a variety of resolutions and different compression ratios (a “small” corpus relative to the many thousands of human scientists using video integrally in their research). A moderate size research community will need to store and manage tens and even hundreds of terabytes of video (with petabytes and exabytes close within view). As a benchmark, consider that TV worldwide is generating about 31 million hours of original programming (~70,000 TBs) each year, while worldwide production of filmed original content for cinema, and made-for-TV films or series is about ~25,000 TBs per year (Lyman & Varian, 2003). The estimated global total of motion pictures made with surviving stock from 1890 to 2003 is about 370,000 and if digitally stored, would require 740.7 petabytes of storage. Several research centers already serve data from petabyte-size storage archives (<http://en.wikipedia.org/wiki/Petabyte>).

Insulating users and applications from idiosyncratic features of multiple repositories requires an intermediate software layer for translating generic requests into requests that can query each specific repository and translate whatever data are returned into a standard form. We envision a middleware layer of software architecture providing repository services to client applications *via* a public interface, and in turn interacting with repository-specific translation components that map generic method calls for access, search, and retrieval into repository-specific interfaces. Repositories can expose their contents to the collaboratory without altering their practices for storing and retrieving video and metadata, so long as they implement a version of the translation layer for their repository.

The NSF Middleware Initiative (NMI, 2004: [www.nsf-middleware.org](http://www.nsf-middleware.org)) and the incorporated Globus Toolkit provides a solid base of common protocols and low-level services for implementing this vision using Grid computing technology (Foster & Kesselman, 2003), although it does not deal directly with video resources. Some NMI components can be used directly (e.g., Grid Security Infrastructure for access control and authentication, GridFTP for file transfers: Globus Project, 2000), but others will require extension for use with video virtual repositories. Treating *video-as-data for discovery*, in contrast to content to be located and delivered (as in Internet-2 videoconferencing or file-serving today), imposes a heavier burden on the repository and its search functionality. Delegating basic functionality to the NMI components such as user authentication and resource registration enables us to focus on search functions, perhaps the greatest challenge in establishing a virtual repository. Here the gap is widest between the ideal of a single searchable repository and the reality of repositories with heterogeneous metadata schemes, some standardized and others *ad hoc*. Our approach will not require repositories to re-index data to a common metadata scheme, or engage in an unrealistic



translation project, but focuses on assuring that all repositories support a core metadata set, while exposing the range of metadata schemes used beyond that core for the user of the virtual video data repository.

We aim to support three different types of search, each with unique implications for metadata development and the functions of the software layer that translates between the generic virtual repository software interface and the specific interfaces exposed by each local repository:

1. *Full text search* of all metadata. The translation layer for each repository will map a generic full text search into the appropriate local search action.
2. *Core metadata search*. The repository will support a core set of metadata (for which we will adopt the Dublin Core as a first pass, to be amended as experience proves necessary) that are guaranteed to apply to all local repositories. This ensures that all resources from participating repositories have a base level of visibility. The translation layer will map the core metadata into the local repository-specific metadata and syntax.
3. *Extended metadata search*. The repository will expose to the user information about the metadata schema available across the local repositories to which the repository has access (e.g., the GEM instructional topics hierarchy, and pedagogy elements/values, <http://www.thegateway.org/>). Users can select metadata schema for use in searches, at which point only those repositories supporting the selected metadata schema will be queried. The translation layer will pass the queries through to the local repository, with whatever modifications are required to conform to local syntax. This use of metadata has the advantage of exposing all of the metadata available, while not requiring a mapping to a common *lingua franca* outside the core metadata. It requires only that the local repository publish to the virtual repository a standard description of the metadata schema in use (e.g., using XML Schema).

Many video data repositories will provide scheme-specific metadata to allow researchers to locate classroom interactions matching specific topical and grade-level criteria. Whereas the virtual repository must support a range of metadata schemes at the level of the local repository, the development of a scientific field is enhanced by the common ground established by a shared metadata scheme. Therefore, based on its importance to the multidisciplinary learning research community in our work toward a DVC, collaborator Brian MacWhinney's group at CMU is extending the TalkBank XML Schema ([xml.talkbank.org](http://xml.talkbank.org)) in building a system for classifying interactional structures in classrooms by developing metadata characterizers based on the vocabulary of interaction analysis methods such as conversational analysis, speech act theory, discourse analysis, and classical rhetoric. This metadata

development will be compliant with OLAC (Open Language Archives Community, <http://www.language-archives.org/>) and the larger Open Archives Initiative (<http://www.openarchives.org/>).

#### **8.4. Interoperable Application Infrastructure for Video Analysis**

Research communities relying solely on text have access to a pre-existing, richly developed research and communications medium that is flexibly adaptable to the requirements of the communities' analytic work. Consider a Shakespeare scholarly community: They have access to the full apparatus of print publishing, word processing, and so on, while also having the capability to extend this apparatus by adding discipline-specific conventions such as shorthand notations for play titles, acts, scenes, and line numbers. This text infrastructure ubiquity is nearly invisible, yet it provides critical support for the community's work in conducting and publishing research.

Today, we do not have a comparable infrastructure for supporting video analysis, publication, collaboration, and critique using video within distributed communities. Existing tools maroon researchers on isolated islands of data, with no easy way to bring to bear other tools or to circulate results to other researchers.

For our DVC work, we bring together the TalkBank and DIVER projects as a concrete base for reconciling this tension. Based on over 20 years of work in the Child Language Data Exchange System (CHILDES: MacWhinney, 2000), the NSF-funded TalkBank project has constructed a full set of quantitative programs for concordance, reliability, part of speech tagging, parsing, coding, and code tracking. These interdisciplinary tools, collectively called CLAN, are designed to support numerous research communities in the area of linguistics and speech analysis, and are being rewritten in Java to work with new XML schema developed at TalkBank for the CHILDES data. As this chapter explains, our work with DIVER provides a user interface paradigm for making persistent pointing references to video source materials that can be annotated and commented upon. DIVER supports researchers in extracting elements of video in the service of analysis and argumentation for many different disciplines. The ability a DIVER user has to impose a theoretical and empirical point of view on a video source, previously available only through general-purpose video-editing software, makes video potentially as pliable and portable a communicative resource as text.

Our collaborative DVC project with MacWhinney is extending these works by:

- (1) Extending and disseminating the XML metadata schema at TalkBank to provide for interoperability among video analysis applications (e.g., DIVER and CLAN initially; and later today's linguistic research tools such as SignStream, ATLAS [Architecture and Tools for Linguistic

Analysis Systems], Praat, MediaTagger), including a standard method for extending a core set of functionality.

- (2) Extending DIVER using an XML-based schema for representing data dimensions and categories and transcription tools that can accept multiple markup languages *via* XML configuration to incorporate functionality with broad relevance for the human sciences, using the CLAN software as a reference.
- (3) Extend WebDIVER services through a lightweight server-based API (Application Program Interface) architecture that will enable users (and developers) to flexibly invoke a number of software components with specific functionality running in a web-browser client.
- (4) Extend DIVER to enable analysis of video located remotely so as to remove the need to distribute video copies for local analysis, a functionality we now have in place.

The DVC will thus contain not a single application, but a loosely coupled set of related programs that are fully interoperable because of their common use of standardized XML schema for representing metadata.

#### **8.5. Community-Based Collaborative Video Publishing, Commentary, Critique**

Our project focuses on a DVC for research communities rather than for individual researchers. This emphasis stems from the recognition that interaction, collaboration, and critique are at the heart of the scientific enterprise, even though much of the visible research work happens in isolation. In the human sciences today, video is generally confined to the research phase, and discussion and reporting phases are conducted entirely in text (Pea, 1999). This short-circuits the process of critique or secondary analyses, since other researchers do not have access to the underlying evidence in its original form. This state may be contrasted with fields such as *biology* [where GenBank<sup>®</sup>, the NIH genetic sequence database (Benson et al., 2002), provides an annotated collection of all publicly available DNA sequences, over 40 million as of late 2004], in *neuroscience* (see the Human Brain Project, Gardner et al., 2003; Koslow, 2002); or in the 2003 National Institutes of Health policies requiring data-sharing for all grants with over \$500K direct costs: NIH-OD-03-032.

As noted earlier, there were recent efforts (both involving TalkBank) to address these problems by experimenting with linking publication and collaborative commentary on video: A special issue of the *Discourse Processes* published with a CD-ROM (Koschmann, 1999) had multiple researchers analyzing a 6-minute medical school problem-based learning episode. A TalkBank conference in Fall 1999 reflected on that experience and led to TalkBank's organization and production of the CD-ROM for a special issue of

the *Journal of the Learning Sciences* (Sfard & McClain, 2002), where six different researchers analyzed a video that documented the role of designed artifacts in secondary mathematics learning. For that JLS special issue, authors had access to transcripts linked to the video in the TalkBank CLAN program, final PDF versions of the articles were edited with Acrobat to create links from specific portions of text to segments of the QuickTime video, and in the final stage of CD-ROM production, authors' analyses were linked back to the original CLAN transcripts and video segments. This JLS issue represented a first case of a digital video collaborative commentary, but even here analysis was disconnected from video data, as authors referenced time codes and transcripts to re-engage with the video source. Such work cannot be done at all on the web today. When considering the challenge of presenting researcher works using multimedia data and enabling web-based commentary, the problem grows. We need the consistent and open form of data organization provided by the global XML standard.

Current video analysis tools are strong individually in various aspects, such as coding, editing, or transcription, as outlined earlier. But none of these tools directly addresses the core challenge of supporting the broader use, sharing, publishing, commentary, criticism, hyper-linking, and referencing of the multimedia data produced and output by the tools. Video-using researchers need to be able to make standardized, accessible and direct contact with competing analyses of audio–video data to enable critical collaborative commentary and cross-referencing for advancing disciplinary knowledge. The integration of video analysis for the work of communities of researchers and practitioners poses technical and design issues that transcend those inherent in developing video analysis tools toward providing a general infrastructure for collaboration.

WebDIVER is designed to go beyond the posting of video data and analyses to the web (now uncommon) so that video may be used as an interactive communication medium in the process of scientific interchange, including collaboration and critique of scientific argument and research evidence. Our first version of WebDIVER provided basic functionality for publishing, viewing, and commenting on analyses authored within the client desktop DIVER application. DIVER users uploaded their source video, analytic clips, and annotations to the WebDIVER site, which then organized the material for display to users through a browsable, searchable community-based website. Other researchers viewing a dive could respond to the author's annotations by posting their own textual comments linked to the video in question, which could then be seen by the author and by other researchers. The key challenge to this approach is that it provides only incomplete DVC features, for a researcher cannot respond to a video comment using source video, but only with textual comments.

As of Autumn 2004, we made a major advance in providing video researchers with new WebDIVER capabilities that enable anyone to do their

diving on streaming video files, so that video no longer needs to reside on the diver's own computer. Divers simply use a web-browser to mark and record space-time segments of videos and to make text annotations, and they may draw on a large archive of videos that have been made dive-accessible. Video files are encoded by users in a specific format (Macromedia Flash, .flv) and then uploaded *via* a webpage to the WebDIVER communications server, where our technology makes them accessible for diving. Video providers may also upload movies in other formats such as .mov, .avi, and .mp4 which are automatically transcoded into Flash video on DIVER servers. Our DIVER team is extending these developments to realize our vision of the DVC for robust access control, group formation, e-mail notifications of changes in dives one has authored or subscribed to, and so on. We will also integrate WebDIVER with the DVC virtual data repository concept, so WebDIVER users can store and retrieve video data and analyses without regard to the underlying physical storage locations.

## 9. ETHICAL ISSUES

A variety of ethical issues are raised by the prospects of broad scale access to video data for research and re-purposing, including issues of human subjects, security and publishing rights. The basic issues raised by point-of-view authoring of digital records for research are privacy and access issues affiliated with human subjects requirements in research policy (Pea & Hay, 2003). Unlike privacy protection for research subjects involving textual or numerical data representations of research data, educational video records potentially include substantial information about specific children and teachers, and in need of careful reviews to protect the privacy of subjects and maintain confidentiality of data whenever appropriate.

These issues are encountered most obviously in the context of protecting the rights of human research subjects in human subject reviews, where research involving video records often faces heightened scrutiny in the United States by Institutional Review Boards (IRBs) for research institutions receiving federal research funding. It is apparent that informed consent for uses of video records of learning and teaching can mean very different things to IRBs and their members, as different personal values come to play in judgments concerning potential risks and benefits from research participation. Many IRBs do not consider uses of research video records of learning and teaching problematic in their re-purposing for teacher education, or in their use for illustrating learning phenomena. But some institutions consider video data to be "secondary" and require destruction of video records after research studies transcribe and code such data, which makes impossible any data sharing or re-visitation of original source data for re-interpretation. Other IRBs require reconsideration of video data use for each and every re-purposing, in that all individuals

involved in the recordings must approve each new specific use of the video clips.

The key issue in human subjects review compliance is disclosing foreseeable risks. The Human Subjects Panels of IRBs typically have oversight responsibility for the review of all University projects that involve human subjects in non-medical research to ensure that the rights and welfare of the subjects are adequately protected with informed consent review. Panel reviews commonly involve approval of a clearly worded consent form which assures that the subject (or responsible parent) is fully informed of the risks inherent in participation and of the benefits which might be reasonably expected. As the basic age for participation in research is 18 years, parental permission is requested for their child's participation in educational research.

There is currently little precedent for identifying the range of risks. One option would be to identify the worse case scenario, to disclose such a possibility, and to minimize the likelihood of such risks. For example, a child may become a standard example for the wrong answer to a question. Or if a specific school is identifiable in a video, it may be possible for a criminal to encounter or seek out a video of a child in that school on the web for nefarious purposes. Correlatively, there is also insufficient common practice and understanding concerning the benefits that might be reasonably expected from uses of video records of learning and teaching for promoting advances in scientific understanding of education and enhanced educational practices.

The universality of web access also leads to the question of security. One way to mitigate the risks to subjects of being included in a video is to limit access to known users, and to ensure that the video cannot circulate beyond that group (for example, by using streaming technology rather than file downloads to make the video available). Another method in the biological and medical sciences is to provide access through a user contract to sensitive data *via* a controlled site, commonly called a data enclave.

The TalkBank site maintains a large collection of audio and video data, based at Carnegie Mellon University, and addresses this problem by requiring users of its collection to agree to an extensive code of ethics. This code obligates anyone using TalkBank data to avoid criticism of individuals depicted in the materials. Anyone who violates the code of ethics is subject to community censure. This code is an attempt to balance the privacy and other interests of research subjects with the scientific needs of researchers and affiliated prospective benefits to society, and represents the judgment that personal criticism has sufficient potential for social harm that it should be impermissible.

Another approach is the use of alternatives to video recordings of situated behaviors as they occur naturally in real classroom settings, such as dramatizations and labeling of performances-as-acted allowing illustrations of teachers and students engaged in both desirable and undesirable practices. In such circumstances, media releases rather than human subjects releases are used, since the point is not human subject research but media capture as in a play

or movie that can then be shown to others. A central problem here is that the performed versions of learning and teaching may not sufficiently resemble the real thing so as to serve the educational and reflective learning purposes for which they are intended. Research is needed to examine this question. Furthermore, teacher educators who have worked extensively with video case studies of teaching practice commonly emphasize how crucial it is for the teachers learning from these cases that they are filmed in real classrooms, and not enacted behaviors.

Another technical possibility is the use of digital masks of identity, such as using blurring or pixelization filters for faces (e.g., Boyle et al., 2000) and digital transformation of voices to prevent identification of individuals (as in news shows protecting crime witnesses). This approach has the advantage of redacting participant-identifying characteristics of the data in order to protect privacy. It is unclear whether such a method could be made commonly useful, as research is necessary to identify the range of research questions that could best be addressed with such masking, and which could not. For example, discourse and interaction analysis frequently relies upon information about gaze direction, joint attention, and such information in the video would not be available in data records that utilize digital masking.

#### 10. EMERGING TRENDS

In one sense the concepts and technologies reviewed throughout this chapter are already exotic with respect to everyday learning and teaching practices and uses of video in virtual-learning environments. But there are a number of technological frontiers that promise to bring interesting developments worth watching (for details, see Pea & Hoffert, in press).

With the increasing reduction in cost, size, and network connectivity of video devices, digital video sensors and cameras will become ubiquitous, and video data will proliferate through wireless data transmission from locations throughout cities, streets, and in nature. We already see the exponentially growing use of digital photography with camera-enabled cell phones, as people find it compelling to share visual experiences with friends and family. Video cameras and video file sharing are emerging as supported services in cell phones in Japan, Korea and Scandinavia, if uncommon in the United States (as of late 2005). In principle, the video that is captured and shared through such mechanisms provides extensive media for DIVER guided noticing and re-purposing.

Many research groups are also pursuing automated video and voice recognition, to enable parsing of the video streams and metadata tagging components of scenes, such as recognizing specific people and objects, and identifying motion segments and speech conversation segments, for facilitating information retrieval and media re-use.<sup>5</sup> These developments will be of benefit for speeding

the process of research use of video records, but also raise challenging problems if they become broadly used and come to endanger human privacy, as some anticipate, in surveillance and security applications.

## CONCLUSIONS

Eco (1989) writes about modern music, writing, art and science that “‘open’ works, insofar as they are in movement, are characterized by the invitation to make the work together with the author and that (2) on a wider level (as a subgenus in the species ‘work in movement’) there exist works, which though organically completed, are ‘open’ to a continuous generation of internal relations that the addressee must uncover and select in his act of perceiving the totality of incoming stimuli” (p. 21).

To the extent that DIVER use can make video and other rich media “open” to diving—the authoring of guided noticing using path-movie-making and annotation—there is without question an active role for the reader, who becomes an author in bringing the work of the video or other medium to a more completed state in his or her interpretations of it. DIVER also provides a tool for evidence-based argumentation, in which one uses what one notices in the medium to make a case around it, and thus extends the work in significant ways with the act of authoring the dive.

In this chapter, I have characterized the theoretical foundations of the DIVER Project, which has created a new software system for capturing, annotating, and sharing perspectives (dives) on human activities video recorded in real-world spaces. DIVER couples a Looking overview window with a magnified Noticing window that can be controlled by the user. This viewing mechanism is also an authoring tool, allowing a user to capture and share his or her unique point-of-view and commentary on a source video. Users annotate their selections, share them on the web, and receive comments by others, promoting dialog and collaboration around video-records of common interest. Supporting this user activity sequence of looking at a full record, noticing events of interest and recording them for later use, and then commenting on what has been seen is fundamental for both research and learning from video sources. For the constructivist educator or more generally for those who want a more active voice in media uses for communication and knowledge production, DIVER provides a platform for moving away from today’s broadcast-centric and asymmetric uses of video to the communicative empowerment of the video user, who can easily craft point-of-view movies within movies with commentaries to share with others. Whether such methods are used to elaborate collaborative knowledge building in the learning sciences from video sources or for everyday consumer video communications in the future, this shift from consumption to authorship is a fundamental transformation in the use of the video medium.



## ENDNOTES

1. A panoramic video camera is created when one or more video cameras are combined with one or more mirrors to capture 360° horizontal data around the panoramic camera's fixed-point location. Image processing software is then used to "dewarp" the imagery that is produced from the reflective surface and to create interpretable displays on a computer monitor of the captured video data. A common method for depicting the panoramic video record is a wide-aspect ratio window that looks as if the cylinder has been sliced and "peeled-back" (see Figure 2 for illustration).
2. I refer to Latour's (1986) influential development of the concept of inscriptions as external representations of ideas that serve as "immutable mobiles" with these key properties: (1) inscriptions are mobile; (2) they are immutable when they move; (3) they are made flat; (4) the scale of the inscriptions may be flexibly modified; (5) they can be cheaply reproduced and spread; (6) they can be reshuffled and recombined; (7) one may superimpose different images of totally different origins and scales; (8) they can be made part of a written text; and (9) their two-dimensional character allows them to merge with geometry.
3. The related idea of "panes" for annotating synchronized video and audio streams was first implemented by Roschelle et al. (1990) in our VideoNoter system; also Roschelle & Goldman (1991).
4. In addition to Joe Rosen's fundamental contributions on design and implementation of DIVER audio focusing, I would like to make special thanks to Dan Nelson, Bob Smith, and Brian Luehrs of Stanford's Center for Innovations in Learning.
5. The IEEE International Conference on Image Processing (ICIP), and ACM's SIGMMM (Multimedia) SIGGRAPH conferences are vital forums for learning about these developments.

## REFERENCES

- Abowd, G. D. (1999). Classroom 2000: an experiment with the instrumentation of a living educational environment. *IBM Systems Journal* 38(4), 508–530.
- Allen, B. L. (1996). *Information Tasks: Toward a User-Centered Approach to Information Systems*. New York: Academic Press.
- Anderson, R. S. & DeMeulle, L. (1998). Portfolio use in twenty-four teacher education programs. *Teacher Education Quarterly* 25(1), 23–32.
- Apple QuickTime 7, including MPEG-4 (2005). (<http://www.apple.com/mpeg4/>).
- Argyle, M. & Cook, M. (1976). *Gaze and Mutual Gaze*. Cambridge: Cambridge University Press.
- Athanases, S. Z. (1994). Teachers' reports of the effects of preparing portfolios of literacy instruction. *The Elementary School Journal* 94(4), 421–439.

- Bapna, D., Rollins, E., Murphy, J., Maimone, E., Whittaker, W., & Wettergreen, D. (1998). The atacama desert trek: outcomes. *Proceedings of the IEEE International Conference on Robotics and Automation (ICRA-98)*, Leuven, Belgium, 597–604.
- Barab, S. A., Barnett, M. G., & Squire, K. (2002). Developing an empirical account of a community of practice: characterizing the essential tensions. *The Journal of the Learning Sciences* 11(4), 489–542.
- Barab, S., MaKinster, J. G., Moore, J., & Cunningham, D. (2001). Designing and building an online community: the struggle to support sociability in the inquiry learning forum. *Educational Technology Research and Development* 49(4), 71–96.
- Barab, S., MaKinster, J., & Schecker, R. (2003). Designing system dualities: characterizing an online professional development community. In: Barab, S. A., Kling, R., and Gray, J. (Eds.) *Designing for Virtual Communities in the Service of Learning*. Cambridge, UK: Cambridge University Press.
- Bargeron, D., Grudin, J., Gupta, A., Sanocki, E., Li, F., & LeeTiernan, S. (2002). Asynchronous collaboration around multimedia applied to on-demand education. *Journal of MIS* 18(4), 117–145.
- Barnett, C. (1998). Mathematics teaching cases as catalyst for informed strategic inquiry. *Teaching and Teacher Education* 14(1), 81–93.
- Barron, B. (2000). Achieving coordination in collaborative problem solving groups. *The Journal of the Learning Sciences* 9(4), 403–436.
- Barron, B. (2003). When smart groups fail. *The Journal of the Learning Sciences* 12(3), 307–359.
- Bates, E., Benigni, L., Bretherton, I., Camaioni, L., & Voltera, V. (1979). *The Emergence of Symbols: Cognition and Communication in Infancy*. New York: Academic Press.
- Bateson, G. (1936). *Naven: A Survey of the Problems Suggested by a Composite Picture of the Culture of a New Guinea Tribe Drawn from Three Points of View*. Stanford: Stanford University Press (2nd ed. published 1981).
- Beardsley, L., Cogan-Drew, D., & Olivero, F. (in press). Video paper: bridging research and practice for pre-service and experienced teachers. In: Goldman, R., Pea, R., Barron, B., and Derry, S. (Eds.) *Video Research in the Learning Sciences*. Mahwah, NJ: Erlbaum.
- BeHere Corporation. <http://www.behere.com/>.
- Benosman, R. & Kan, S. B. (Eds.) (2001). *Panoramic Vision: Sensors, Theory and Applications*. New York: Springer Verlag.
- Benson, D. A., Karsch-Mizrachi, I., Lipman, D. J., Ostell, J., Rapp, B. A., & Wheeler, D. L. (2002). GenBank. *Nucleic Acids Research* 30(1), 17–20.
- Berger, J. (1972). *Ways of Seeing*. Harmondsworth, England: Penguin.
- Berliner, D. C. (1988). *The Development of Expertise in Pedagogy*. New Orleans: American Association of Colleges for Teacher Education.
- Berliner, D. C. (1994). Expertise: The wonder of exemplary performances. In: Mangier, J. M. and Block, C. C. (Eds.) *Creating Powerful Thinking in Teachers and Students: Diverse Perspectives*. Fort Worth, TX: Holt, Rinehart, & Winston, 161–186.
- Berman, F., Fox, G. C., & Hey, A. J. G. (2003). (Eds.). *Grid Computing: Making the Global Infrastructure a Reality*. New York: John Wiley & Sons.
- Berners-Lee, T., Hendler, J., & Lassila, O. (2001). The semantic web: a new form of web content that is meaningful to computers will unleash a revolution of new possibilities. *Scientific American*. Available at: <http://www.sciam.com/2001/0501issue/0501berners-lee.html>.
- Birdwhistell, R. L. (1970). *Kinesics and Context: Essays in Body Motion Communication*. Philadelphia: University of Pennsylvania Press.
- Boult, T. E., (1999, July). Personal Panoramic Perception. In: Arabia, H. R. (Ed.) *Proceedings of International Conference on Imaging Science, Systems, and Technology (CISST '99)*, 383–390. (ISBN No: 1-892512-19-X)

- Boyle, M., Edwards, C., & Greenberg, S. (2000). The Effects of Filtered Video on Awareness and Privacy. *Proceedings of the 2000 ACM conference on Computer Supported Cooperative work (CSCW2000)*, Philadelphia PA, 1–10.
- Bransford, J. D., Brown, A., & Cocking, R. (Eds.) (2000). *How People Learn: Mind, Brain, Experience and School (Expanded Edition)*. Washington, DC: National Academy Press.
- Brodie, K. W., Carpenter, L. A., Earnshaw, R. A., Gallop J. R., Hubbard, R. J., Mumford, A. M., Osland, C. D., & Quarendon P. (1992). *Scientific Visualization*. Berlin, Germany: Springer-Verlag.
- Brown, A. L. (1992). Design experiments: theoretical and methodological challenges in creating complex interventions in classroom settings. *The Journal of the Learning Sciences* 2, 141–178.
- Brown, J. S., Collins, A., & Duguid, P. (1989). Situated cognition and the culture of learning. *Educational Researcher* 18, 32–42.
- Bruce, R. R. (Ed.). (1994). *Seeing the Unseen: Dr. Harold E. Edgerton and the Wonders of Strobe Alley*. Cambridge, MA: MIT Press.
- Brugman, H. & Kita, S. (1998). CAVA: using a relational database system for a fully multimedial gesture corpus. *Workshop: Constructing and Accessing Multi-media Corpora: Developments in and Around the Netherlands*. Nijmegen, The Netherlands.
- Bruner, J. (1975). From communication to language—a psychological perspective. *Cognition* 3, 255–287.
- Card, S. K., Mackinlay, J. D., & Shneiderman, B. (1999). *Readings in Information Visualization: Using Vision to Think*. San Francisco, CA: Morgan Kaufmann.
- Carrer, M., Ligresti, L., Ahanger, G., & Little, T. D. C. (1997). An annotation engine for supporting video database population. *Multimedia Tools and Applications* 5(3), 233–258.
- Cassirer, E. (1953–1957). *Philosophy of Symbolic Forms, Trans. Ralph Manheim*, Vol. 3. New Haven, CT: Yale University (originally published 1923–1929).
- Cerf, V. G., Cameron, A. G. W., Lederberg, J., Russell, C. T., Schatz, B. R., Shames, P. M. B., Sproull, L. S., Weller, R. A., & Wulf, W. A. (1993). *National Collaboratories: Applying Information Technology for Scientific Research*. Washington, DC: National Academy Press.
- Chen, S. E. (1995). QuickTime VR—An Image-Based Approach to Virtual Environment Navigation. *Proceedings of the 22nd International Conference on Computer Graphics and Interactive Techniques '95*, 29–38.
- Cherry, G., Fournier, J., & Stevens, R. (2003). Using a digital video annotation tool to teach dance composition. *Interactive Multimedia Electronic Journal of Computer-Enhanced Learning*. Available at: <http://imej.wfu.edu/articles/2003/1/01/>.
- Chiu, P., Boreczky, J. S., Girgensohn, A., & Kimber, D. (2001). LiteMinutes: an Internet-based system for multimedia meeting minutes. *Proceedings of the 10th International Conference on the World Wide Web*, 140–149.
- Clark, H. H. (1996). *Using Language*. Cambridge, UK: Cambridge University Press.
- Collins, A., Brown, J. S., & Newman, S. E. (1989). Cognitive apprenticeship: teaching the crafts of reading, writing, and mathematics. In: Resnick, L. (Ed.) *Knowing, Learning, and Instruction: Essays in Honor of Robert Glaser*. Hillsdale, NJ: Lawrence Erlbaum Associates.
- Crismond, D. (2003). Approaches to Using Video Cases in Teacher Professional Development. *Proceedings of the 3rd IEEE International Conference on Advanced Learning Technologies (ICALT'03)*.
- Crowley, K., Callanan, M. A., Tenenbaum, H. R., & Allen, E. (2001). Parents explain more often to boys than to girls during shared scientific thinking. *Psychological Science* 12(3), 258–261.
- Cutler, R., Rui, Y., Gupta, A., Cadiz, J. J., Tashev, I., He, L., Colburn, A., Zhang, Z., Liu, Z., & Silverberg, S. (2002). Distributed Meetings: A Meeting Capture and Broadcasting System. *Proceedings of ACM Multimedia 2002*, Juan-les-Pins, France, 503–512.

- DeLaguna, G. (1927). *Speech: Its Function and Development*. New Haven: Yale University Press.
- Derry, S. J. and the STEP Team (2003). The STEP system for collaborative case-based teacher education: design, evaluation and future directions, *Unpublished Report*. University of Wisconsin, Madison.
- Doerr, H., Masingila, J., & Bowers, J. (2003). *The Case Creator Project: A Video-Based Case Creation Tool for Teacher Education*. Available at: <http://www.sci.sdsu.edu/mathvideo/cc/>.
- Dourish, P. & Button, G. (1998). On “technomethodology”: foundational relationships between ethnomethodology and system design. *Human-Computer Interaction* 13, 395–432.
- Eco, U. (1989). *The Open Work*. Cambridge, MA: Harvard University Press.
- Edelson, D. C. & Gordin, D. (1998). Visualization for learners: a framework for adapting scientists’ tools. *Computers and Geosciences* 24(7), 607–616.
- Edelson, D. C., Gordin, D. N., & Pea, R. D. (1999). Addressing the challenges of inquiry-based learning through technology and curriculum design. *The Journal of the Learning Sciences* 8(3&4), 391–450.
- Edgerton, H., Kayafas, G. (Ed.) & Jussim, E. (2000). *Stopping Time: The Photographs of Harold Edgerton*. San Francisco, CA: Harold N. Abrams.
- Ehn, P. (1988). *Work-Oriented Design of Computer Artifacts*. Stockholm: Arbetslivscentrum (Distributed by Lawrence Erlbaum Associates, Hillsdale, NJ).
- Erickson, F. (1992). Ethnographic microanalysis of interaction. In: LeCompte, M., Millroy, W., & Preissle, J. (Eds.) *The Handbook of Qualitative Research in Education*. San Diego: Academic Press.
- Feiner, S. K. (2002, April). Augmented reality: a new way of seeing. *Scientific American*, 286(4), 48–55.
- Fiala, M., Green, D., & Roth, G. (2004). A panoramic video and acoustic beamforming sensor for videoconferencing. *IEEE International Workshop on Haptic Audio Visual Environments and their Applications (HAVE '2004)*, Ottawa, Ontario, Canada.
- Finholt, T. A. (2002). Collaboratories. In: Cronin, B. (Ed.) *Annual Review of Information Science and Technology*, Vol. 36. Medford, NJ: Information Today.
- Finholt, T. & Olson, G. M. (1997). From laboratories to collaboratories: a new organizational form for scientific collaboration. *Psychological Science* 8, 28–36.
- Fishman, B. (2003). Linking on-line video and curriculum to leverage community knowledge. In: Brophy, J. (Ed.) *Advances in Research on Teaching: Using Video in Teacher Education*, Vol. 10. New York: Elsevier, 201–234.
- Foote, J. & Kimber, D. (2000, August). FlyCam: Practical panoramic video. *Proc. IEEE International Conference on Multimedia and Expo* 3, 1419–1422.
- Foote, J. & Kimber, D. (2001). Enhancing Distance Learning with Panoramic Video. *Proceedings of the 34th Hawaii International Conference on Systems Sciences*, Washington, DC: IEEE Computer Society, pp. 4044.
- Foster, I. & Kesselman, C. (Eds.) (2003). *The Grid 2: Blueprint for a New Computing Infrastructure*. San Francisco, CA: Morgan Kaufmann Publishers.
- Frederiksen, J., Sipusic, M., Sherin, M., & Wolfe, E. (1998). Video portfolio assessment: creating a framework for viewing the functions of teaching. *Educational Assessment* 5(4), 225–297.
- Fullview. (2005). Available at: <http://www.Fullview.com>.
- Furnass, G. W. (1986). Generalized fisheye views. In: Mantei, M. & Orbeton, P. (Eds.) *Proceedings of the ACM SIG-CHI '86 Conference on Human Factors in Computing Systems*, New York: ACM Press, 16–23.
- Galvis, A. H. & Nemirovsky, R. (2003). Video case studies: grounded dialogue matters most. *@Concord* 7(1), 8.

- Gardner, D., Toga, A. W., Ascoli, G. A., Beatty, J. T., Brinkley, J. F., Dale, A. M., Fox, P. T., Gardner, E. P., George, J. S., Goddard, N., Harris, K. M., Herskovits, E. H., Hines, M. L., Jacobs, G. A., Jacobs, R. E., Jones, E. G., Kennedy, D. N., Kimberg, D. Y., Mazziotta, J. C., Miller, P. L., Mori, S., Mountain, D. C., Reiss, A. L., Rosen, G. D., Rottenberg, D. A., Shepherd, G. M., Smalheiser, N. R., Smith, K. P., Strachan, T., Van Essen, D. C., Williams, R. W., & Wang, S.T. (2003). Towards effective and rewarding data sharing. *Neuroinformatics Journal* 1(3), 289–295.
- Garfinkel, H. (1967). *Studies in Ethnomethodology*. Englewood Cliffs, NJ: Prentice Hall.
- Geisler, C. & Rogers, E. H. (2000). Design collaboration and mediating technologies. *Proceedings of the 18th Annual ACM International Conference on Computer Documentation: Technology and Teamwork*, Cambridge, Massachusetts, 395–405.
- Geisler, G., Marchionini, G., Wildemuth, B., Hughes, A., Yang, M., Wilkens, T., & Spinks, R. (2002). Video Browsing Interfaces for the Open Video Project. *Conference Extended Abstracts of CHI 2002*, New York, NY: ACM Press, 514–515.
- Globus Project. (2000). GridFTP: Universal Data Transfer for the Grid. *Globus Project White Paper*, published by the University of Chicago and the University of Southern California. Available at: [www.globus.org/datagrid/deliverables/C2WPdraft3.pdf](http://www.globus.org/datagrid/deliverables/C2WPdraft3.pdf).
- Goffman, E. (1979). *Gender Advertisements*. Cambridge, MA: Harvard University Press.
- Goldman, R. (in press). ORION™, An online digital video data analysis tool: changing our perspectives as an interpretive community. In: Goldman, R., Pea, R., Barron, B., and Derry, S. (Eds.) *Video Research in the Learning Sciences*. Mahwah, NJ: Erlbaum.
- Goldman-Segall, R. (1994). Challenges facing researchers using multimedia tools. *Computer Graphics* 28(1), 48–52.
- Goldman-Segall, R. (1998). *Points of Viewing Children's Thinking: A Digital Ethnographer's Journey*. Mahwah, NJ: LEA.
- Goodchild, M. F. (1992). Geographical information science. *International Journal of Geographical Information Systems* 6(1), 31–45.
- Goodwin, C. (1994). Professional vision. *American Anthropologist* 96, 606–633.
- Goodwin, C. (1995). Seeing in depth. *Social Studies of Science* 25, 237–274.
- Goodwin, C. & Heritage, J. (1990). Conversation analysis. *Annual Review of Anthropology* 19, 283–307.
- Goody, J. (1987). *The Logic of Writing and the Organization of Society*. New York: Cambridge University Press.
- Gordin, D. & Pea, R. D. (1995). Prospects for scientific visualization as an educational technology. *The Journal of the Learning Sciences* 4(3), 249–279.
- Greeno, J. G. & MMAP (Middle School Mathematics Through Applications Project Group). (1998). The situativity of knowing, learning, and research. *American Psychologist* 53, 5–26.
- Grimshaw, A. (1997). The eye in the door: anthropology, film and the exploration of interior space. In: Banks, M. and Morphy, H. (Eds.) *Rethinking Visual Anthropology*. New Haven, CT: Yale University Press, 36–52.
- Grossman, P. L. (1990). *The Making of a Teacher: Teacher Knowledge and Teacher Education*. New York: Teachers College Press.
- Hall, R. (2000). Videorecording as theory. In: Kelly, A. E. and Lesh, R. A. (Eds.) *Handbook of Research Design in Mathematics and Science Education*. Mahwah, NJ: Lawrence Erlbaum Associates, 647–664.
- Hall, R. (2002, December personal communication).
- Halleck, D. (2002). *Hand Held Visions: The Impossible Possibilities of Community Media*. New York: Fordham University Press.
- Harnad, S. (1991). Post-Gutenberg galaxy: the fourth revolution in the means of production of knowledge. *Public-Access Computer Systems Review* 2(1), 39–53.

- Harrison, B. L. & Baecker, R. M. (1992). Designing video annotation and analysis systems. In: Booth, K. S. & Fournier, A. (Eds.) *Proceedings of the Conference on Graphics Interface '92*, Vancouver, BC, Canada. San Francisco, CA: Morgan Kaufmann Publishers Inc. 157–166.
- Hay, K. E. & Kim, B. (in press). The Integrated Multimedia Data (ITMD) research system. In: Goldman, R., Pea, R. D., Barron, B., and Derry, S. (Eds.) *Video Research in the Learning Sciences*. Mahwah, NJ: Lawrence Erlbaum Associates.
- Hiebert, J., Gallimore, R., Garnier, H., Givvin, H. G., Hollingsworth, H., Jacobs, J., Chui, A. M., Wearne, D., Smith, M., Kersting, N., Manaster, A., Tseng, E., Etterbeek, W., Manaster, C., Gonzales, P., & Stigler, J. (2003). Teaching mathematics in seven countries: results from the TIMSS 1999 video study. *NCES Report #2003–013*. Washington, DC: U.S. Department, Institute of Education.
- Hindmarsh, J., M. Fraser, Heath, C., Benford, S., & Greenhalgh, C. (1998). Fragmented Interaction: Establishing Mutual Orientation in Virtual Environments. *Proceedings of CSCW '98*, Seattle, WA, 217–226.
- Hoffert, E., Krueger, M., Mighdoll, L., Mills, M., Cohen, J., Camplejohn, D., Leak, B., Batson, J., Van Brink, D., Blacketter, D., Arent, M., Williams, R., Thorman, C., Yawitz, M., Doyle, J., & Callahan, S. (1992). QuickTime: An Extensible Standard for Digital Multimedia. *Proceedings of the 37th International Conference for the IEEE COMPCON*, San Francisco, California, 15–20.
- Hollan, J. & Stornetta, S. (1992). Beyond Being There. *Proceedings of CHI-92*. New York, NY: ACM Press, 119–125.
- Horvath, J. & Lehrer, R. (2000). The design of a case-based hypermedia teaching tool. *International Journal of Computers for Mathematical Learning* 5, 115–141.
- Hutchins, E. (1995). *Cognition in the Wild*. Cambridge, MA: MIT Press.
- Iacucci, G., Iacucci, C., & Kuutti, K. (2002). Imagining and Experiencing in Design, the Role of Performances. *ACM International Conference Proceeding Series, Proceedings of the 2nd Nordic conference on Human–computer Interaction*, Aarhus, Denmark, 167–176.
- iPix. (2005). (<http://www.ipix.com/>).
- Jordan, B. & Henderson, A. (1995). Interaction analysis: foundations and practice. *The Journal of the Learning Sciences* 4, 39–103.
- Kendon, A. (1982). The study of gesture: some observations on its history. *Recherches Sémiotiques/Semiotic Inquiry* 2(1), 45–62.
- Kim, K. W., Kim, K. B., & Kim, H. J. (1996). VIRON: an Annotation-Based Video Information Retrieval System. *Proceedings of COMPSAC '96*, Seoul, August 1996, New York: IEEE Press, 298–303.
- Kimber, D., Foote, J., & Lertsithichai, S. (2001). FlyAbout: Spatially Indexed Panoramic Video. *Proceedings of ACM Multimedia 2001*, Marina-del-Rey, 339–347.
- King, M. B. (2002). Professional development to promote schoolwide inquiry. *Teaching and Teacher Education* 18, 243–257.
- Kipp, M. (2001). ANVIL: A Generic Annotation Tool for Multimodal Dialogue. *Proceedings of Eurospeech*, 1367–1370.
- Koehler, M. J. (2002). Designing case-based hypermedia for developing understanding of children's mathematical reasoning. *Cognition and Instruction* 20(2), 151–195.
- Koschmann, T. (Ed.) (1999). Special issue: meaning making. *Discourse Processes* 27(2).
- Koslow, S. H. (2002). Sharing primary data: a threat or asset to discovery? *Nature Reviews Neuroscience* 3(4), 311–313.
- Lampert, M. & Hawkins, J. (1998). New technologies for the study of teaching. Report to the National Science Foundation from a workshop held June 9–11, 1998, *NSF Grant #REC-9802685*. Ann Arbor, MI.
- Lampert, M. & Loewenberg-Ball, D. (1998). *Teaching, Multimedia and Mathematics: Investigations of Real Practice*. New York: Teachers' College Press.

- Lamping, J., Rao, R., & Pirolli, P. (1995). A Focus+context Technique Based on Hyperbolic Geometry for Visualizing Large Hierarchies. *Proceedings of the SIGCHI Conference on Human Factors in Computing Systems*, Denver, Colorado, 401–408.
- Latour, B. (1986). Visualization and cognition: thinking with eyes and hands. In: Kuklick, H. and Long, E. (Eds.) *Knowledge and Society: Studies in the Sociology of Culture Past and Present-A Research Annual*, Vol. 6. Greenwich, CT: JAI Press, 1–40.
- Laurel, B. (Ed). (1990). *The Art of Human-Computer Interaction*. Reading, MA: Addison-Wesley.
- Lave, J. (1988). *Cognition in Practice*. Cambridge: Cambridge University Press.
- Lave, J. (1993). Situating learning in communities of practice. In: Resnick, L. B., Levine, J. M., and Teasley, S. D. (Eds.) *Perspectives on Socially Shared Cognition*. Washington, DC: American Psychological Association, 17–36.
- Lawson, M. J. (1994). Concept mapping. In: Husén, T. and Postlethwaite, T. N. (Eds.) *The International Encyclopedia of Education*, 2nd ed., Vol. 2. Oxford: Elsevier Science, 1026–1031.
- Lee, D., Erol, B., Graham, J., Hull, J., & Murata, M. (2002). Portable meeting recorder. *Proceedings of ACM Multimedia 2002*, Juan-les-Pins, 493–502.
- Lee, S. Y. & Kao, H. M. (1993). Video Indexing: An Approach Based on Moving Object and Track. *Proceedings of the SPIE*, Vol. 1908, 25–36.
- Lemke, J. (1999). Typological and topological meaning in diagnostic discourse. *Discourse Processes* 27(2), 173–185.
- Linn, M. C. & Hsi, S. (2000). *Computers, Teachers, Peers: Science Learning Partners*. Mahwah, NJ: Lawrence Erlbaum Associates.
- Lu, J. & Rose, R. (2003). Seeing math through multimedia case studies. *@Concord* 7(1), 1, 4–5.
- Lyman, P. & Varian, H. R. (2003). “How Much Information”, 2003. Retrieved from: <http://www.sims.berkeley.edu/how-much-info-2003> on December 30, 2004.
- Ma, L. (1999). *Knowing and Teaching Elementary Mathematics: Teachers' Understanding of Fundamental Mathematics in China and the United States*. Mahwah, NJ: Lawrence Erlbaum Associates.
- Ma, X., Lee, H., Bird, S., & Maeda, K., (2002). Model and Tools for Collaborative Annotation. *Proceedings of the Third International Conference on Language Resources and Evaluation*, Paris: European Language Resources Association.
- Mackay, W. & Beaudouin-Lafon, M. (1998). DIVA: Exploratory Data Analysis with Multimedia Stream. *CHI 1998 Proceedings*. New York, NY: ACM Press.
- MacWhinney, B. (2000). *The CHILDES Project: Tools for Analyzing Talk*. Hillsdale, NJ: Lawrence Erlbaum.
- MacWhinney, B. & Snow, C. (1999). Multimodal studies of instructional discourse. *Report to the National Science Foundation*. Available at: [http://www.nsf.gov/sbe/tcw/events\\_991203w/](http://www.nsf.gov/sbe/tcw/events_991203w/).
- Martin, R. (2002). *Picasso's War: The Destruction of Guernica and the Masterpiece that Changed the World*. New York: E. P. Dutton.
- Masten, D. & Plowman, T. M. P. (2003). Digital ethnography: the next wave in understanding consumer experience. *Design Management Journal* 14(2), 75–81.
- McCormick, B. H., DeFanti, T. A., & Brown, M. D. (Eds.) (1987). Visualization in scientific computing (special issue). *Computer Graphics* 21, 6.
- Mehan, H. (1978). Structuring school structure. *Harvard Educational Review* 48(1), 32–64.
- Metz, C. (1974). *Film Language: A Semiotics of the Cinema*. New York: Oxford University Press.
- Mills, M. I., Cohen, J., & Wong Y. Y. (1992). A Magnifier Tool for Video Data. *Proceedings of CHI '92*. New York, NY: ACM Press, 93–98.

- MPEG-4 Standard. (2005). (<http://www.m4if.org/mpeg4/>).
- Mumme, J. (2003). *Videocases for Mathematics Teacher Professional Development*. Available at: <http://www.wested.org/cs/we/view/pj/361>.
- Myers, B., Casares, J. P., Stevens, S., Dabbish, L., Yocum, D., & Corbett, A. (2001). A Multi-view Intelligent Editor for Digital Video Libraries. *Proceedings of the First ACM/IEEE Joint Conference on Digital Libraries*, Roanoke, VA, 106–115.
- Nardi, B. (Ed.) (1996). *Context and Consciousness: Activity Theory and Human–Computer Interaction*. Cambridge, MA: The MIT Press.
- Nayar, S. K. (1997, May). Omnidirectional Video Camera. *Proceedings of DARPA Image Understanding Workshop*, New Orleans, Louisiana.
- Neidle, C., Sclaroff, S., & Athitsos, V. (2001). A tool for linguistic and computer vision research on visual-gestural language data. *Behavior Research Methods, Instruments, and Computers* 33(3), 311–320.
- Nemirovsky, R., Lara-Meloy, T., Earnest, D., & Ribeiro, B. T. (2001). Videopapers: Investigating New Multimedia Genres to Foster the Interweaving of Research and Teaching. *Paper presented at the 25th Meeting of the International group for the Psychology of Mathematics Education*, Utrecht University, The Netherlands.
- Neumann, U., Pintaric, T., & Rizzo, A. (2000). Immersive panoramic video. *Proceedings of the 8th ACM International Conference on Multimedia*, Marina del Rey, California, 493–494.
- Nielson, G. M., Muller, H., Mueller, H., & Hagen, H. (1997). *Scientific Visualization: Overviews, Methodologies and Techniques*. New York: IEEE Computer Society.
- Novak, J. D. (1998). *Learning, Creating, and Using Knowledge: Concept Maps<sup>®</sup> as Facilitative Tools in Schools and Corporations*. Mahwah, NJ: Lawrence Erlbaum Associates.
- NSF Middleware Initiative (NMI). (2004). (<http://www.nsf-middleware.org>).
- Olson, D. (1994). *The World on Paper: The Conceptual and Cognitive Implications of Writing and Reading*. Cambridge: Cambridge University Press.
- Ong, W. J. (1982). *Orality and Literacy: Technologizing the Word*. New York: Methuen.
- Open QuickTime (2004). *Open Standards for QuickTime*. Available at: <http://www.openquicktime.org>.
- Pea, R. (1993). Practices of distributed intelligence and designs for education. In: Salomon, G. (Ed.) *Distributed Cognitions: Psychological and Educational Considerations*. Cambridge, England: Cambridge University Press, 47–87.
- Pea, R. D. (1992). Augmenting the discourse of learning with computer-based learning environments. In: de Corte, E., Linn, M., and Verschaffel, L. (Eds.), *Computer-Based Learning Environments and Problem-Solving (NATO Series, Subseries F: Computer and System Sciences)*. New York: Springer-Verlag GmbH, 313–343.
- Pea, R. D. (1994). Seeing what we build together: distributed multimedia learning environments for transformative communications. *The Journal of the Learning Sciences* 3(3), 283–298.
- Pea, R. D. (1999). New media communication forums for improving education research and practice. In: Lagemann, E. C. and Shulman, L. S. (Eds.) *Issues in Education Research: Problems and Possibilities*. San Francisco, CA: Jossey Bass, 336–370.
- Pea, R. D. (2002). Learning science through collaborative visualization over the Internet. In: Ringertz, N. (Ed.) *Nobel Symposium: Virtual Museums and Public Understanding of Science and Culture*. Stockholm, Sweden: Nobel Academy Press.
- Pea, R. D. (2004). The social and technological dimensions of “scaffolding” and related theoretical concepts for learning, education and human activity. *The Journal of the Learning Sciences* 13(3), 423–451.
- Pea, R. D. & Hay, K. (2003). *CILT Workshop on Digital Video Inquiry in Learning and Education, November 25–26, 2002* (Report to the National Science Foundation based on NSF #0124012). Palo Alto, CA: Stanford Center for Innovations in Learning.



- Pea, R. & Hoffert, E. (in press). Video workflow in the learning sciences: prospects of emerging technologies for augmenting work practices. In: Goldman, R., Pea, R., Barron, B., and Derry, S. (Eds.) *Video Research in the Learning Sciences*. Mahwah, NJ: Erlbaum.
- Pea, R., Mills, M., Rosen, J., Dauber, K., Effelsberg, W., & Hoffert, E. (2004). The DIVER™ Project: interactive digital video repurposing. *IEEE Multimedia* 11(1), 54–61.
- Pea, R., Wulf, W., Elliot, S. W., & Darling, M. (Eds.) (2003). *Planning for Two Transformations in Education and Learning Technology* (Committee on Improving Learning with Information Technology). Washington, DC: National Academy Press.
- Porter, A. C., Youngs, P., & Odden, A. (2001). Advances in teacher assessment and their uses. In: Richardson, V. (Ed.) *Handbook of Research on Teaching*, 4th ed. Washington: American Educational Research Association, pp. 259–297.
- Preece, J., Rogers, Y., & Sharp, H. (2002). *Interaction Design: Beyond Human-Computer Interaction*. New York: John Wiley & Sons.
- Prihavec, B. & Solina, F. (1998). User interface for video observation over the Internet. *Journal of Network and Computer Applications* 21, 219–237.
- Quine, W. V. O. (1960). *Word and Object*. Cambridge, MA: MIT Press.
- Rao, R. & Card, S. K. (1994). The Table Lens: Merging Graphical and Symbolic Representations in an Interactive Focus + Context Visualization for Tabular Information. *Proceedings of the SIGCHI Conference on Human Factors in Computing systems*, Boston, Massachusetts, 318–322.
- Rayward, W. B. & Twidale, M. B. (1999). From docent to cyberdocent: education and guidance in the virtual museum. *Archives and Museum Informatics* 13, 23–53.
- Resnick, L. (1987). Learning in school and out. *Educational Researcher* 16(9), 3–21.
- Rheingold, H. (1992). *Virtual Reality: The Revolutionary Technology of Computer-Generated Artificial Worlds-and How it Promises to Transform society*. New York: Simon & Schuster.
- Rizzo, A. A., Neumann, U., Pintaric, T., & Norden, M. (2001). Issues for application development using immersive HMD 360 degree panoramic video environments. In: Smith, M. J., Salvendy, G., Harris, D., and Koubek, R. J. (Eds.) *Usability Evaluation and Interface Design*, Vol. 1, Mahwah, NJ: Lawrence Erlbaum Associates, 792–796.
- Rogoff, B. (1990). *Apprenticeship in Thinking: Cognitive Development in Social Context*. New York: Oxford University Press.
- Rogoff, B. (2003). *The Cultural Nature of Human Development*. New York: Oxford University Press.
- Rogoff, B. & Lave, J. (Eds.) (1984). *Everyday Cognition: Its Development in Social Context*. Cambridge, MA: Harvard University Press.
- Roschelle, J. & Goldman, S. (1991). VideoNoter: a productivity tool for video data analysis. *Behavior Research Methods, Instruments, and Computers* 23, 219–224.
- Roschelle, J. & Pea, R. D. (2002). A walk on the WILD side: how wireless handhelds may change computer-supported collaborative learning (CSCL). *The International Journal of Cognition and Technology* 1(1), 145–168.
- Roschelle, J., Pea, R. D., & Trigg, R. (1990). VideoNoter: a tool for exploratory video analysis, *Technical Report, No. 17*. Palo Alto, CA: Institute for Research on Learning.
- Roth, W.-M. (2001a). Gestures: their role in teaching and learning. *Review of Educational Research* 71(3), 365–392.
- Roth, W.-M. (2001b). Situating cognition. *The Journal of the Learning Sciences* 10, 27–61.
- Roth, W.-M. & Roychoudhury, A. (1993). The concept map as a tool for the collaborative construction of knowledge: a microanalysis of high school physics students. *Journal of Research in Science Teaching* 30, 503–534.
- Rui, Y., Gupta, A., & Cadiz, J. J. (2001). Viewing Meetings Captured by an Omni-Directional Camera. *Proceedings of the 2001 ACM Conference on Human Factors in Computing Systems (CHI 2001)*, Seattle, Washington, New York: ACM Press, 450–457.

- Saxe, G. B. (1988). Candy selling and math learning. *Educational Researcher* 17(6), 14–21.
- Saxe, G. B. (1991). *Culture and Cognitive Development: Studies in Mathematical Understanding*. Hillsdale, NJ: Erlbaum.
- Scaife, M. & Bruner, J. (1975). The capacity for joint visual attention in the infant. *Nature* 253, 265–266.
- Schoenfeld, A. H. (1992). On paradigms and methods: what do you do when the ones you know don't do what you want them to? Issues in the analysis of data in the form of videotapes. *The Journal of the Learning Sciences* 2, 179–214.
- Schön, D. (1983). *The reflective practitioner*. New York: Basic Books.
- Schon, D. A. (1987). *Educating the Reflective Practitioner: Toward a New Design for Teaching and Learning in the Professions*. San Francisco, Jossey-Bass.
- Schrader, P. G., Leu, D. J., Jr., Kinzer, C. K., Ataya, R., Teale, W. H., Labbo, L. D., & Cammack, D. (2003). Using Internet delivered video cases, to support pre-service teachers' understanding of effective early literacy instruction: an exploratory study. *Instructional Science* 31(4), 317–340.
- Schuler, D. & Namioka, A. (Eds.). (1993). *Participatory Design: Principles and Practices*. Hillsdale, NJ: Erlbaum.
- Seamon, D. & Zajonc, A. (Eds.) (1998). *Goethe's Way of Science: A Phenomenology of Nature*. Albany, NY: State University of New York Press.
- Sfard, A. & McClain, K. (2002). Analyzing tools: perspectives on the role of designed artifacts in mathematics learning. *Journal for the Learning Sciences*, 11(2 & 3), 153–161.
- Shamberg, M. & Raindance Corporation. (1971). *Guerrilla Television*. New York: Holt, Rinehart and Winston.
- Sherin, M. G. (2001). Developing professional vision of classroom events. In: Wood, T., Nelson, B. S., and Warfield, J. (Eds.) *Beyond Classical Pedagogy: Teaching Elementary School Mathematics*. Mahwah, NJ: Erlbaum, 75–93.
- Sherin, M. G. (2003). Redefining the role of video in teacher education. In: Brophy, J. (Ed.) *Using Video in Teacher Education*, Vol. 10, New York: Elsevier Science, 1–27.
- Sherin, M. G. & van Es, E. A. (2002). Using Video to Support Teachers' Ability to Interpret Classroom Interactions. *Paper Presented at the 13th Annual Conference of the Society for Information Technologies in Education (SITE)*, Nashville, Tennessee. (Download August 4, 2005 from: [http://www.aace.org/conf/site/pt3/paper\\_3008\\_1031.pdf](http://www.aace.org/conf/site/pt3/paper_3008_1031.pdf).)
- Shotter, J. (2000) Seeing historically: Goethe and Vygotsky's 'enabling theory-method'. *Culture and Psychology* 6(2), 233–252.
- Shrader, G., Fishman, B., Barab, S. A., O'Neill, K., Oden, G., & Suthers, D. D. (2002). Video cases for teacher learning: issues of social and organizational design for use. In: Stahl, G. (Ed.) *Computer Support for Collaborative Learning: Foundations for a CSCL Community*. Hillsdale, NJ: Lawrence Erlbaum Associates, 708–709.
- Shulman, J. H. (Ed.) (1992). *Case Methods in Teacher Education*. New York: Teachers College Press.
- Snyder, J., Lippincott, A., & Bower, D. (1998). The inherent tensions in the multiple uses of portfolios in teacher education. *Teacher Education Quarterly* 25(1), 45–60.
- Star, S. L. & Griesemer, J. R. (1989). Institutional ecology, "translations" and boundary objects: amateurs and professionals in Berkeley's museum of vertebrate zoology, 1907–39. *Social Studies of Science* 19, 387.
- Stevens, R. (in press). Capturing ideas in digital things: a new twist on the problem of inert knowledge. In: Goldman, R., Pea, R., Barron, B., and Derry, S. (Eds.) *Video Research in the Learning Sciences*. Mahwah, NJ: Erlbaum.
- Stevens, R., Cherry, G., & Fournier, J. (2002). Video Traces: Rich Media Annotations for Teaching and Learning. *Proceedings of the CSCL 2002 Conference on Computer Supported Collaborative Learning*, Boulder, CO.

- Stevens, R. & Hall, R. (1997). Seeing Tornado: how VideoTraces mediate visitor understandings of (natural?) spectacles in a science museum. *Science Education* 18(6), 735–748.
- Stevens, R. & Hall, R. (1998). Disciplined perception: learning to see in technoscience. In: Lampert, M. and Blunk, M. L. (Eds.) *Talking Mathematics in School: Studies of Teaching and Learning*. New York: Cambridge University Press.
- Stevens, R. & Toro-Martell, S. (2003). Leaving a trace: supporting museum visitor interpretation and interaction with digital media annotation systems. *Journal of Museum Education*, 28(2), 25–31.
- Stiefelhagen, R., Yang, J., & Waibel, A. (2002). Modeling focus of attention for meeting indexing based on multiple cues. *IEEE Transactions on Neural Networks* 13(4), 928–938.
- Stigler, J., Gallimore, R., & Hiebert, J. (2000). Using video surveys to compare classrooms and teaching across cultures: examples and lessons from the TIMSS video studies. *Educational Psychologist* 35(2), 87–100.
- Stigler, J., Gonzales, P., Kawanaka, T., Knoll, S., & Serrano, A. (1999). *TIMSS Videotape Classroom Study*, U.S. Department of Education, Washington, DC, NCES 1999–074.
- Stigler, J. W. & Hiebert, J. (1999). *The Teaching Gap: Best Ideas from the World's Teachers for Improving Education in the Classroom*. New York: Free Press.
- Stone, B. A. (1998). Problems, pitfalls, and benefits of portfolios. *Teacher Education Quarterly* 25(1), 105–114.
- Suchman, L. A. (1987). *Plans and Situated Actions: The Problem of Human–Machine Communication*. Cambridge, England: Cambridge University Press.
- Suchman, L. & Trigg, R. H. (1991). Understanding practice: video as a medium for reflection and design. In: Greenbaum, J. and Kyng, M. (Eds.) *Design at Work*. Hillsdale, NJ: Lawrence Erlbaum Associates, 65–90.
- Sun, X., Foote, J., Kimber, D., & Manjunath, B. S. (2001a). Panoramic video capturing and compressed domain virtual camera control. *Proceedings of ACM Multimedia 2001*, Marina del Rey, CA, 329–338.
- Sun, X., Foote, J., Kimber, D., & Manunath, B. S. (2001b). Recording the region of interest from FLYCAM panoramic video. *Proceedings of IEEE International Conference on Image Processing (ICIP 2001)*, Thessaloniki, Greece, 409–412.
- Sun, X. and Manjunath, B. S. (2002, September). Panoramic capturing and recognition of human activity. *ICIP 2002 (International Conference of Image Processing)*. Rochester, NY, USA.
- Tan, K.-H., Hua, H., & Ahuja, N. (2004). Multiview panoramic cameras using mirror pyramids. *IEEE Transactions on Pattern Analysis and Machine Intelligence* 26(7), 941–946.
- Tang, J. C. (1991). Findings from observational studies of collaborative work. *International Journal of Man–Machine Studies* 34(2), 143–160.
- Teodosio L. A. & Mills, M. (1993). Panoramic overviews for navigating real-world scenes. *Proceedings of the First ACM International Conference on Multimedia*. Anaheim, CA, 359–364.
- Transana. (2004). Transana: A Tool for the Transcription and Qualitative Analysis of Audio and Video Data. Available at: <http://www.transana.org>.
- Trevarthen, C. (1979). Communication and cooperation in early infancy: a description of primary intersubjectivity. In: Bullowa, M. M. (Ed.) *Before Speech: The Beginning of Interpersonal Communication*. New York: Cambridge University Press, 321–347.
- Tufte, E. R. (1997). *Visual Explanations: Images and Quantities, Evidence and Narrative*. Cheshire, CT: Graphic Press.
- Ulewicz, M. & Beatty, A. (Eds.) (2001). *The Power of Video Technology in International Comparative Research in Education*. Washington DC: National Research Council, Board on International Comparative Studies in Education, Board on Testing and Assessment, Center for Education.

- Varmus, H., Lipman, D., Ginsparg, P., & Markovitz, B. P. (2000). The impact of open access on biomedical research. *Genome Biology* 1(3).
- Virage (2005). (<http://www.virage.com>).
- Weber, K. & Poon, A. (1994). Marquee: A Tool for Real-Time Video Logging. *Proceedings of CHI-94*, New York, NY: ACM Press, 58–64.
- Williamson, J. (1994). *Decoding Advertisements: Ideology and Meaning in Advertising*. London: Marion Boyars.
- Windows Media Technologies. (2005). (<http://www.microsoft.com/windows/windowsmedia/>).
- Winograd, T. (Ed.) (1996). *Bringing Design to Software*. Reading, MA: Addison-Wesley.
- Wittgenstein, L. (1953). *Philosophical Investigations*. New York: Macmillan.
- Wolff, R. & Yaeger, L. (1993). *Visualization of Natural Phenomena*. New York: Springer-Verlag.
- Yang, J., Zhu, X., Gross, R., Kominek, J., Pan, Y., & Waibel, A. (1999). Multimodal People Id for a Multimedia Meeting Browser. *Proceedings of the 7th ACM International Conference on Multimedia*, Orlando, FL, 159–168.
- Young, J. R. (2001, July 19). Professors use the web to publish portfolios of teaching techniques. *The Chronicle of Higher Education*. (Downloaded August 4, 2005 from <http://chronicle.com/free/2001/07/2001071902t.html>.)
- Youngs, P., Odden, A., & Porter, A. C. (2003). State policy related to teacher licensure. *Educational Policy* 17(2), 217–236.
- Zeichner, K. & Wray, S. (2001). The teaching portfolio in U.S. teacher education programs: what we know and what we need to know. *Teaching and Teacher Education* 17(5), 613–621.

## Chapter 56: ePresence Interactive Media and Webforum 2001: An Accidental Case Study on the Use of Webcasting as a VLE for Early Child Development

ANITA ZIJDEMANS\*, GALE MOORE<sup>†</sup>, RON BAECKER<sup>‡</sup>,  
AND DANIEL P. KEATING<sup>§</sup>

\*Ontario Institute for Studies in Education, University of Toronto; <sup>†</sup>Knowledge Media Design Institute, University of Toronto, Toronto; <sup>‡</sup>Department of Computer Science, University of Toronto, Toronto, Ontario; <sup>§</sup>Center for Human Growth and Development, University of Michigan

### 1. INTRODUCTION

This chapter presents the use of the ePresence Interactive Media System as a Virtual Learning Environment (VLE) for Webforum 2001<sup>1</sup>, a 2-day hybrid event that brought together local and geographically distributed participants to hear presentations on the latest science in early child development. The ePresence VLE supported social interaction and collaboration across time, distance, and space and captured multimedia archives of the event that subsequently led to a number of post-Webforum activities.

Webforum 2001 was the culminating event for an initiative called the Millennium Dialogue on Early Child Development. Planning for this initiative began in 1999 to explore conceptually and technologically innovative ways to educate, empower, enrich, and engage a variety of different stakeholders seeking to advance their understanding of early child development (Matthews & Zijdemans, 2001). Led by Daniel Keating, then at the University of Toronto's Ontario Institute for Studies in Education, in collaboration with Invest in Kids Foundation, and the Lawson Foundation,<sup>2</sup> conceptualization for the Millennium Dialogue grew out of Keating's previous work as director of the Human Development Program at the Canadian Institute for Advanced Research [CIAR]<sup>3</sup>. The product of that effort was *Developmental Health and the Wealth of Nations* (Keating & Hertzman, 1999), a collective volume that used socioeconomic gradients to describe the significant association between socioeconomic status (SES) and developmental health.<sup>4</sup> Three major themes had been identified in this research: (i) the wealth of a nation is rooted in the developmental health of its individuals; (ii) enhancing developmental health requires a deep understanding of the core dynamics of human development from a wide range of perspectives, from the biological to society; and (iii) to support developmental health in an era of profound unprecedented transformation, societies must become "learning societies" which actively

support healthy human development across the population.<sup>5</sup> One of the first tasks for the MDECD planning committee<sup>6</sup> was formalizing these ideas into the following objectives for the project:

*“to assemble and present the best available scientific work on healthy development; to design and deploy new strategies and means to bring this information to a wide range of audiences who would benefit from this knowledge; and beyond dissemination, to launch a sustainable, interactive dialogue at a societal level on how to make use of our rapidly growing knowledge to optimize the potential for developmental health in all children.”*

(Keating, 1999)

The implementation plan involved a number of inter-related activities, including:

- engaging eight internationally renowned scientists from diverse and traditionally separate fields in child development to establish a cross-disciplinary *knowledge base*;
- enlisting a team of researchers and practitioners to assist in the design of a *curriculum* grounded in the knowledge base;
- offering a hybrid face-to-face and online *graduate level course* based on the curriculum;
- creating a distributed conference, *Webforum2001*, a 2-day event originating at OISE/UT to which remote participants would be invited;
- designing and creating new *educational materials* oriented toward diverse audiences.

It was recognized at the outset that achieving the above objectives, in particular the last three, would require a degree of technological innovation. A team of technical experts was assembled to design and implement an infrastructure that would support the project's learning and knowledge building activities. The Education Commons, the in-house technology support group for OISE/UT, determined the overall system and networking requirements, and gathered preliminary information on webcast technologies. Keating had previously used Lotus Notes/Domino, and arrangements were made to upgrade this server and create an intranet/extranet for the project. Knowledge Forum<sup>7</sup>, a learning environment developed in-house, was set up for the graduate course. All that remained was to find a team capable of producing MDECD's final event, Webforum 2001, which would be opened up to a large number of participants, both local and remote. The MDECD took a year to plan, a second year to produce, and a third year was spent in post-knowledge media production. Details on the full range of these activities can be found in Zijdemans (2005).

This chapter focuses on Webforum 2001, the 2-day event that used the ePresence Interactive Media System, a webcasting application, to create a VLE to support live interactions among a group of experts and participants, all of whom attended at least part of the event using the VLE. A formal case study had neither been planned nor designed in advance. However, the rich observations gathered over these 2 days supplemented by the systems logs and an informal evaluation, provided insights into how the experience of the participants shaped and was shaped by the affordances of the VLE, as well as the impact of the design choices of the Webforum team in creating the event. This *post hoc* review, while preliminary and exploratory—and now historical—provides the first systematic account of the experience of using the ePresence Interactive Media System in an educational setting to support sustained interaction across several different environments.

We also report here on the unintended consequences of MDECD's decision to use digital technologies, including webcasting. As the event unfolded, the interest expressed by the participants sparked requests for ongoing access to the Webforum content for knowledge building. This included requests for materials to support their programs or projects. The final section of the chapter looks closely at the production of these novel knowledge media and concludes with an example of the Red River College's decision to infuse the new knowledge into an Early Child Education multimedia resource that stands to influence the way in which programs are currently delivered across Canada.

## 2. WEBFORUM 2001

Keating had been a member of the Knowledge Media Design Institute since it was founded by Baecker and a group of colleagues in 1996. Interested by the potential of knowledge media technologies for knowledge development he invited Moore, then the executive director of KMDI, to participate on the MDECD planning committee.

One of KMDI's areas of specialization was in the human-centered design, development and use of technologies, in particular video technology, to support collaboration over distance. Members of the Institute had worked together on the Ontario Telepresence Project (1992–1995), a research project in which the design and uncovering of novel uses of videoconferencing technologies had been central (Moore, 1997). By the late 1990s, a new class of collaboration technologies was being designed for the internet and accessible from a web browser. In 2000, Baecker and Moore, with long standing research interests in the role of video in supporting distributed work, recognized the potential of one of these IP-based technologies such as webcasting,<sup>8</sup> to reach large audiences at minimal cost in a way that had not been possible with videoconferencing. But as earlier research on video-mediated communication had shown, many of the problems associated with the use of video were social, not technical.

It would be necessary to design and build a webcasting system, grounded in principles of human-centered design. Bell University Laboratories supported this research and the first version of the system, known as ePresence, went live in the fall of 2000.

The progress of this project was watched with interest by the Millennium Dialogue committee as they still did not have a solution for managing the distributed part of their program. Initial enquiries into the cost of commercial webcast productions yielded estimates ranging from \$60,000 to over \$120,000—well beyond the capacity of the MDECD budget. Following the successful use of ePresence for the KMDI lecture series in the spring of 2001, the technology seemed mature enough for both the Millennium planning committee and KMDI to collaborate on exploring the use of this first version of ePresence as a VLE for the closing event, Webforum 2001. For ePresence this represented an opportunity to capitalize on the experiential learning that had taken place in the spring series, and for the design team to gain further insights into the use of the system in a real world setting.

In the summer of 2001, KMDI's ePresence team was contracted to webcast the Webforum event. The ePresence team worked closely with the Webforum team to plan and prepare for the production. KMDI's ePresence Interactive Media team was in many ways an ideal partner for Webforum 2001. Both MDECD and ePresence were innovative university-based projects. The MDECD framework for designing a learning society was theoretically well conceptualized. The ePresence Interactive Media team came out of many years of research experience in the design and use of synchronous or real-time collaboration environments to support distributed interaction, in particular, how to support the engagement of participants whose experience of the event would be mediated by technology.

In early October 2001, the Webforum team sent out approximately 300 papers and electronic invitations to a diverse group of stakeholders with interest in the area of early child development. This included members of the local community who were invited to participate in the event at OISE/UT and Faculties of Education and Early Child Education across Canada who were invited to participate using the ePresence Interactive Media VLE. The participants were therefore self-selected based on their interest in the subject. Those attending remotely were informed of the public and exploratory nature of the event and consent was sought in advance to publishing their names on the public Webforum web site.

On November 8–9, 2001, some 155 people attended Webforum 2001 at OISE/UT and 40 attended *via* the internet. The event was comprised of two related sets of activities—a series of four presentations followed by question periods and a series of three roundtable discussions. Each morning and afternoon there were two presentations, each given by one of the senior scientists, followed by a question period. After a short break, a roundtable discussion was convened. The only exception to this pattern was on the second day which



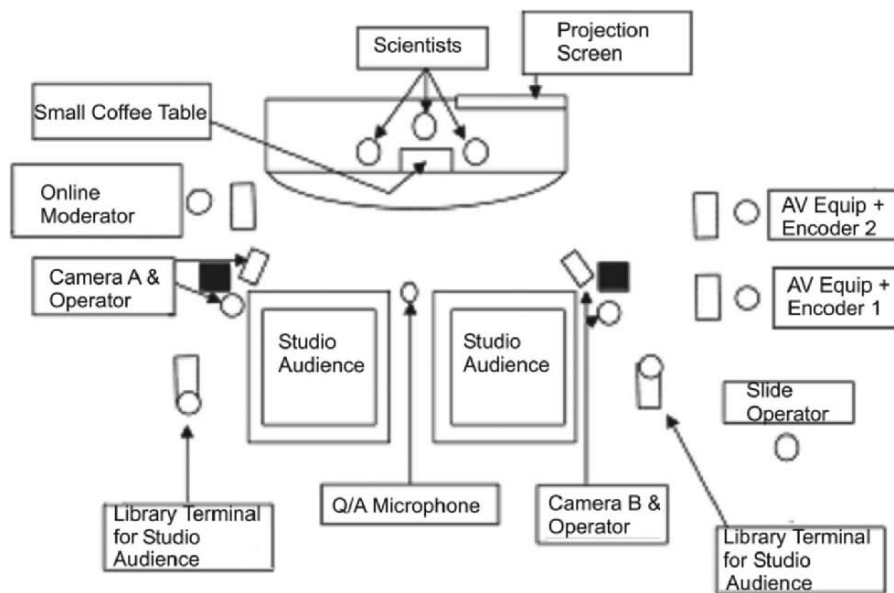

Figure 1. Webforum 2001 configuration OISE/UT library.

ended early after the last presentation and question period. All the presentations and questions periods were held in the OISE/UT library and all the roundtables were held in a conference room two floors above the library.

Figure 1 shows the configuration for the library location.

Figure 2 shows the configuration of the separate roundtable discussion conference room.

Attendance at the roundtables was restricted to the senior scientists and respondents, and the discussions were broadcast simultaneously to both the local participants in the OISE/UT library—who viewed them on a large screen—and the geographically remote participants—who were either alone, or watching as part of a group. If a member of the library audience wished to ask a question, two computers open to the ePresence interface were available, but there was neither a moderator nor any assistance provided. The local audience at OISE/UT, therefore, actually participated in the event in two different ways—in a face-to face setting and as members of a remote audience. The significance of this decision to have the local audience participate remotely for part of the event would only be evident later.

### 3. ePRESENCE INTERACTIVE MEDIA

The ePresence VLE supported this hybrid local/remote audience and made it possible for the all the participants to be part of this 2-day dialogue with

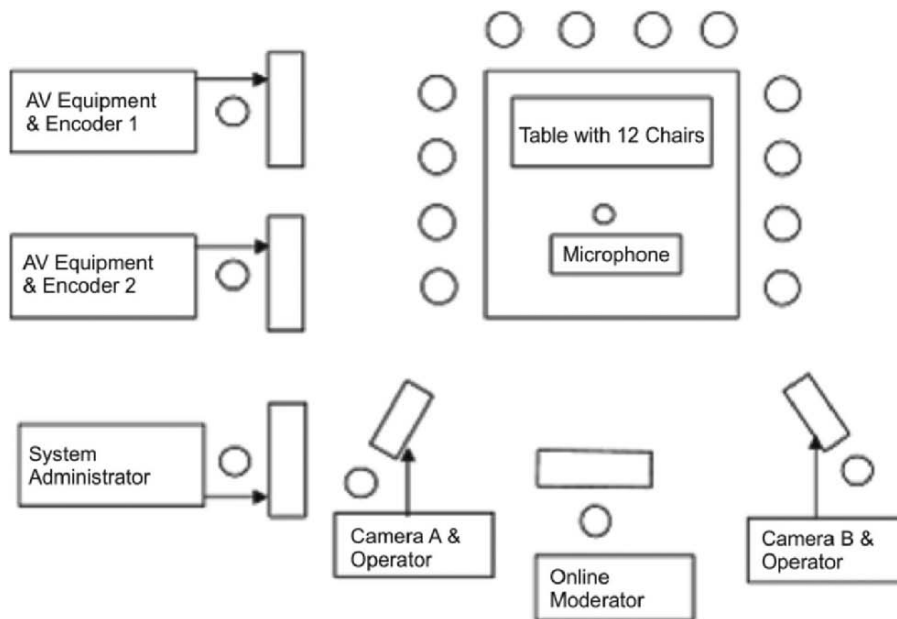

Figure 2. Webforum 2001 configuration roundtable conference room.

the eight internationally renowned scientists. At the time of Webforum, webcasting was typically non-interactive as there was a significant time delay of several seconds before an image generated at the source would be received at the remote end. The ePresence Interactive Media was a live webcasting system to which a number of innovative features had been added to overcome some of the limitations of the currently available commercial systems. For example, ePresence employed text chat as a mechanism allowing interaction among remote participants, and between these individuals and the presenter *via* a local moderator. Remote participants could ask questions and review the material already presented by the speaker. As long as the audio–video capture of the event was done with attention to media production values, ePresence had the potential to provide a rich and engaging multimedia experience for viewers.

For this event, the ePresence system was equipped to sustain 60 licenses for simultaneous use and supported streams at 300 kbps for LAN/WAN, and 56 kbps for modem. The 60-license limit was due to financial restrictions and not system capacity. Precautions were taken such as using an offsite mirror server to offset potential access and bottleneck limitations and setting up an audio only server so that minimally audio, slides, and interactivity would always be available. Additional bandwidth was also purchased. Finally the system was implemented prior to the event both for testing purposes and to provide support for registered remote participants interested in trying out the technology in advance.

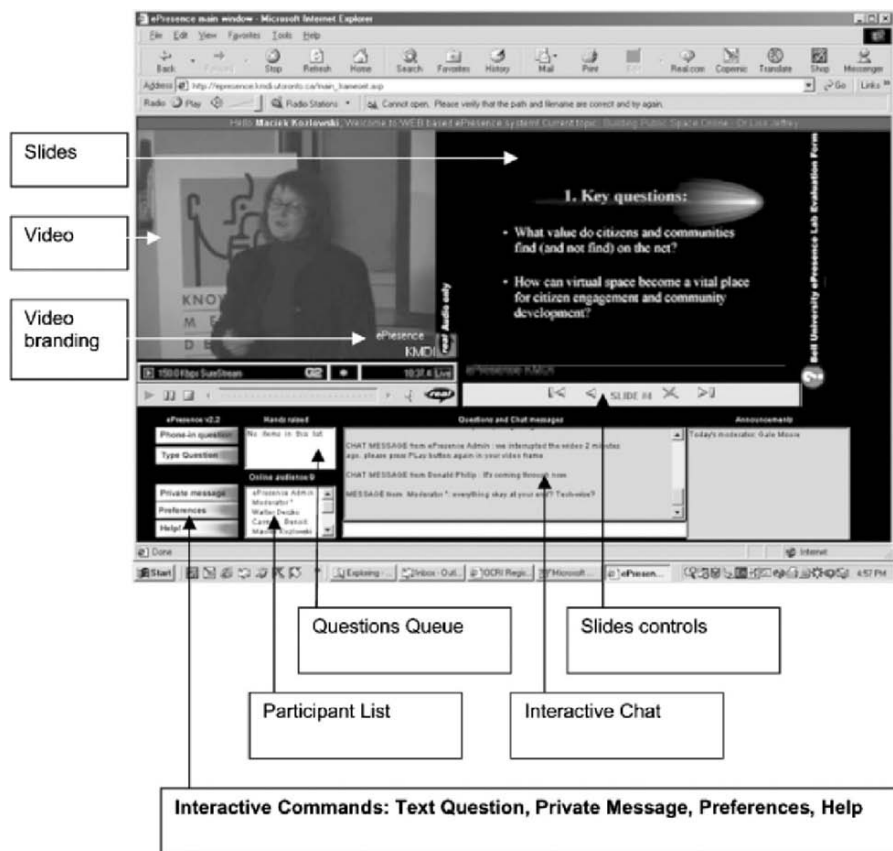

Figure 3. ePresence live Webcast user interface.

Figure 3 is a screen capture of the user interface as seen by the remote participants.

The ePresence live interface included the following features:

- a window for a panel or an individual speaker;
- a window for slides or presentation notes;
- a text entry window for submitting private text questions directly to the moderator and/or public and private postings using a chat feature through which participants could interact with each other;
- help and the display of number of participants on line.

An ePresence webcast, at the time, required a five-person crew to operate the two cameras and two encoders, and to operate the slides<sup>9</sup>. In addition, two moderators and the system administrator were available to the remote participants to answer questions and to assist with any technical problems. Moderator One was stationed in the library and engaged directly with the

online participants flagging questions for Moderator Two who was the conference convenor. Moderator Two had the complex task of presenting a paper on Day 2 as well as conveying the online questions to the participants and scientists. In this role he provided the bridge linking the face-to-face and remote participants by bringing the online questions and commentary to the local presenters and library audience.

#### 4. AN ACCIDENTAL CASE STUDY

Moore coined the term “accidental case study” to describe this paper as at the outset a formal case study had neither been planned nor designed. However, as the event unfolded, it was clear that there were a number of valuable, albeit preliminary, insights into the complexities inherent in designing both the technical application to support distributed communication *and* the design of the event that should be reported. First, webcasting was still a relatively new application and most people had limited experience with using such a system. The 2-day event, while short, did provide some time for participants to learn to use the system. In addition, it could provide insights into the nature of the support needed by participants from both the ePresence team and the Webforum team. And, the decision by the Webforum team to hold the roundtables in a small room that accommodated only the scientists and other senior scholars provided a unique opportunity to observe the experience of using the same technology in two distinctly different social conditions.

The geographically remote participants experienced no change when the event shifted from the presentation sessions to the roundtables, but the local participants who were present at the sessions had no alternative but to participate remotely during the roundtables. Finally, the spontaneous response from participants that took place immediately following Webforum revealed unintended consequences of the webcast, seeded both technical and social innovation, and provided insights into ways to support the emergence of future communities of learning.

#### 5. INFORMATION GATHERED

A variety of information and data were gathered over the 2-day Webforum 2001 event. These came from a range of sources including registration information—which included such things as the participants’ affiliations and online participants’ locations, and technical notes developed during the planning period leading up to the event. In addition, the ePresence system automatically generated a log of the online interactions. At the end of the event, forms had been distributed to each of the participants who expressed an interest in gaining access to an archive of the event, which also included a brief

Table 1. Remote participants by location

WF2001 Participants: by Location	Webcast Participants
Canada	
Nova Scotia	2
Prince Edward Island	1
New Brunswick	1
Quebec	3
Ontario	4
Greater Toronto Area	16
Manitoba	4
Saskatchewan	2
Alberta	3
British Columbia	1
U.S.A	
New York	1
Minnesota	1
San Francisco	1
Total	40

evaluation of the event. Finally, following the event, e-mail was received from a number of the participants who had attended both at OISE/UT and remotely.

### 5.1. Participants

The registration records provided information on the distribution of the participants attending the Webforum by their geographical location and employment sector. Table 1 shows the geographic locations of the 40 remote sites.

The remote sites were located all in North America with the majority (16) located in the greater Toronto area. Seven of the Toronto sites were individuals accessing the event from their offices at the UT and two were from OISE/UT computer labs on the 3rd floor. These labs were opened up informally so that members of the OISE/UT community could attend at no cost. The international locations included New York, Minnesota, and San Francisco.

A total of 195 participants were involved in Webforum 2001 (Table 2). The largest single group was in education (58), which included researchers, educators, faculty, graduate students, and teacher federations. The second largest were representatives from organizations related to early child development (47), and government groups or individuals (24).

The geographically remote participants that is those not present at OISE/UT, attended the event in two ways—either as individuals or in groups. Table 3 shows that over the 2 days, a total of 48 participants were individuals accessing the event from their personal computers at home or at the office.

Table 2. Participants by employment sector

<b>WF2001 Participants: by Sector</b>	<b>Library OISE/UT</b>	<b>Geographically Remote</b>	<b>Total</b>
Education (universities and colleges, K-12, teachers federations, schools)	45	20	65
Private and public associations/ organizations	44	3	47
Health (doctors, nurses)	11	0	11
Government	17	7	24
Technology	6	9	15
Private foundations	17	0	17
News media	10	0	10
Other	5	1	6
<b>Total</b>	<b>155</b>	<b>40</b>	<b>195</b>

On each of the 2 days of the conference, 23 were groups at least 10 of which were comprised of between 4 and 20 people.

Although no data were formally collected on the remote groups, we learned that the groups were in a large room equipped with a single projector and in at least four cases they were integrating the Webforum event into their own parallel sessions or seminars related to early child development. Each group also had a moderator who was responsible for conveying questions or other comments to the ePresence moderator. The geographically remote participants thus had an advantage over the OISE/UT group attending the roundtables remotely. A total of 37 sites logged in on Day 1 with a maximum of 25 people logged in simultaneously. On Day 2, a total of 33 sites logged in with a maximum login at any one time reaching 20.

## 5.2. Interaction at the Event—Remote and Local

As previously mentioned, the local OISE/UT participants attended from the library location in two ways—face-to-face for the presentations and question

Table 3. Webforum 2001 login details

<b>WF2001 Login Details</b>	<b>Day 1</b>	<b>Day 2</b>
Number of groups	13	10
Number of individuals	25	23
Total number of sites logged in	37	33
Max login at any time	25	20

Table 4. Face-to-face versus online questions

	Day 1	Day 2	Total
Questions asked face-to-face OISE/UT local (presentations)	33	39	72
Questions asked Online OISE/UT remote (roundtables)	3	6	9
Geographically remote (includes presentations and roundtables)	10	10	20
Total	46	55	101

periods and remotely for the roundtable discussions. Table 4 shows that there is a much higher level of interaction when attendees are participating in a live event. In both cases, when the participants were remote there was less interaction.

On Day 1 a total of 13 of the total 46 questions were submitted using ePresence and on Day 2 this increased to 16 of the 55 questions posed. A total of 101 questions were asked over the 2-day period. It is important to note that the majority of all the questions came from the scientists who were participating in all the events and around whom Webforum was designed. It is interesting to note that the lowest level of interaction was from the participants at OISE/UT when they attended the roundtables remotely.

There were two moderators at OISE/UT, and both were present in the live presentations. Moderator One monitored all of the questions from the remote participants and flagged them for Moderator Two, who also had ePresence open on his laptop browser. However, as he was also convening the live events, he could not attend fully to the remote queries. An important role of the moderators was to ensure that the online questions were brought before the live presenters, but on a number of occasions the geographically remote participants had to be assertive about getting their questions through. There were clearly some experienced users of collaboration technologies in the remote audience. In fact, some had used other technologies such as videoconferencing and were more experienced with participating in distance events than the moderators at OISE/UT. The following request illustrates this: *“Can I suggest that questions from distance participants be interspersed with those from the floor? When we do paediatric Grand Rounds involving several centres in the Maritimes, we try to give equal time to all centres to eliminate the perception that they are peripheral.”*

In addition to the official moderators, the conference co-ordinator was also monitoring the event and providing support to the remote participants. The need for the moderators to work together to assure that remote participants were not dis-enfranchised was made clear when group from Nova Scotia who had submitted a question but had not heard it reflected in the live broadcast.

They asked Moderator One: *“I do not see the Roundtable room on my online list anymore—could you or the conference coordinator pass our question on to the Emcee [sic convenor] for us? Please and Thanks”*

This question sparked a series of messages among the moderators and as the following exchange illustrates, shows how private messaging was extremely useful as a back channel to co-ordinate without disrupting the event in progress. The conference moderator privately messages Moderator One: *“Hey there, are you taking care of the Nova Scotia request?”* Meanwhile the Nova Scotia Group who was still waiting posts: *“appreciate any effort.”* Moderator One responds privately to the conference moderator: *“Just working on it.”* Moderator One then sends a private message to Moderator Two, the convenor: *“Check out the Nova Scotia group message just below my last announcement.”* Moderator Two responds privately to Moderator One: *“Got it. Thanks”* At this point Moderator Two announces to the library audience: *“This question came in from one of our remote sites in Nova Scotia . . .”* Moderator One then sends a public post to the Nova Scotia Group: *“Sorry to have missed this on the first go-round!”* The Nova Scotia Group replies: *“No problem—we have the question being answered now! Thanks to all who helped get the question out—Un gros merci!”*

Both of the above examples highlight some of the inherent challenges in trying to ensure that the remote participants were remembered and brought into the face-to-face situation. Overall, the ePresence VLE worked well and had the affordances to support a variety of social interactions. The remote participants engaged easily and were able to have their concerns addressed.

### **5.3. The Content of Online Interaction**

While the local OISE/UT audience could interact directly with the speakers during the presentations, their interactions outside of the formal sessions were primarily with others who were also attending. For the individuals and groups who attended remotely it was necessary to ask questions through the moderator, but they could also interact with all the others online, regardless of their location.

The transcripts generated by the system at this time, included both the public and the private messages. Given our interest in constructivist learning, we were interested in looking at all the messages exchanged for evidence of active learning and engagement. We felt, however, that in spite of the fact that a notice had been posted publicly that all the chat was logged, it was inappropriate to use the private chat transcripts without explicit agreement by those involved, as the implications of the system logs may not have been fully understood. The public dialogue and questions were, on the other hand, public and available to everyone online.



The private chat had originally been included in the application as a way of allowing remote participants to “whisper” to each other—a social behavior that had been observed in studies of live audiences attending public lectures or talks. It also turned out to be a convenient way for people to communicate with the moderator if they were having technical problems without disrupting others online. Furthermore, it provides an excellent back channel for co-ordinating the activities of the technical and administrative team members. However, as the meaning of “private chat” is likely to be interpreted differently in different social settings and in different groups, this was flagged as an important issue to be addressed in the future. In this paper, private messages are, with one exception, excluded unless they are exchanges among members of the administrative and the technical teams associated with co-ordination or impersonal administrative, or technical exchanges with the moderators. The one exception is below in the section on sociability and involves an exchange between a mother and her son who were in different locations and both attending remotely.

A qualitative review of the chat messages uncovered the following four categories: (i) substantive; (ii) technical; (iii) sociability; and (iv) administrative. Each of the categories is described below and illustrated with quotes from the logs.

#### *5.3.1. Substantive: Content Related to the Subject Matter of the Conference*

These postings were on the subject of the event and are suggestive of the remote participants’ engagement in the event. These messages were of two types—the most frequent was questions to the speaker, as the following quotes illustrates: “*How might we work differently in the research and policy areas, if we think “symphonic causation” as compared to “multiple causation” or similar terms?*” Less frequent was a general comment that was not directed to anyone in particular, but which could be seen by other members of the remote audience. In one case, a local participant in the OISE/UT library used one of the ePresence terminals to post a substantial stream of thoughts that otherwise would have been difficult to raise in the face-to-face meeting.

#### *5.3.2. Technical: Content Related to the Technical Aspects of the System*

These postings were typically those related to technical issues and included troubleshooting, concerns about incorrect slide synchronization, or screen resolution problems. Today, technical problems are virtually non-existent, but this was both early days in the development of the ePresence application, and with participants who as yet had only limited experience with webcasting technology.

The ePresence team had worked to prevent some of these issues by providing a system wizard that checked systems requirements when people initially set up their accounts. In addition to this, the Webforum team had hosted a test day, a week in advance of the event so that remote participants could test their systems. Despite this, numerous issues arose particularly on the first day. There were frequent interactions between the moderators, system administrator, and remote participants to help troubleshoot “on the fly”. In the following excerpt, a participant sends a private message to the Administrator: *“Not the right slides.”* Moderator One responds privately to the participant: *“We’re working on it, please bear with us.”* The administrator fixes the problem and instructs the participant how to adjust his computer settings to get things working properly: *“In your browser please set up and select Tools—Internet Options—Temp Files—Settings—Every visit to the page.”* A few minutes later the participant responds: *“Thanks I have the slides now!”*

Other technical related postings reflected the frustrations the remote participants were experiencing due to the numerous technical glitches. Not surprisingly, this was most evident on the first day when everyone was unfamiliar with the application. One participant group sums up their experience this way: *“We’re doing fine but finding the technology a little frustrating at times. Online we are missing many of the cues we would have in a live audience. It is a different experience and we must change the way we attend to the lecture. One problem is that if there are any technical difficulties such as sound problems we must break concentration to attend to them. For example, while adjusting volume it is hard to keep 100% attention especially if the participants in our room need to talk to each other about the problem. By having your speakers think about their distant audience they may be able to help with some of these problems. Having the slides available ahead of time as we mentioned this morning is a good example. Also a little more time spent summarizing or reviewing would help keep us in the loop. I think I have a somewhat better idea of what an ESL learner feels like when I follow a lecture in this format. Thanks.”*

As comments went back and forth between the moderators, administrator, and remote participants it was interesting to note that gradually as the remote participants became familiar with the technology, they too started assisting others. A participant from Halifax notes that the slides on her computer screen were the wrong size saying: *“The size of the windows exceeds the size of the screen and I have to scroll to see different windows. Can the entire display be shrunk to fit the screen?”* A person from the computer lab tries to assist: *“Halifax, set the resolution on your monitor to 1024 × 768. That should help. In the control panel, if you have a Mac.”* The administrator adds: *“Unfortunately you have to have a screen resolution of at least 1024 × 768 to see everything onscreen without scrolling.”* The Halifax participant responds: *“That’s what the resolution is set to.”* A few minutes later the group from Manitoba posts:

*“The setting on a PC need to be the same for resolution and desktop in your video card settings.”*

The next series of exchanges captures the experience of the members of the ePresence team and Webforum team who were located in the OISE/UT library and simultaneously monitoring the remote participants *via* computer. The time delay between the live broadcast when it is received remotely is small, but still significant. It is transparent to the remote audience who is always 10 seconds late, but the experience for the moderator operating in two time zones is complex and led to an interesting discovery about the technology. A member of the research team asks: *“Would anyone be able to tell me the exact time delay between live and web?”* The conference moderator privately responds: *“What we see live is not the same as the online. I know it looks strange but they [remote participants] don’t notice anything.”* Moderator One uses the chat to say: *“It seems to vary from machine to machine, but maybe, on average, 1 minute?”* The computer lab then creates a message: *“Seems more like 28 seconds.”* Concerned that they might be distracting the other remote participants the conference moderator creates a private message to Moderator One: *“I sent a private message stating that for the online group it looks normal. It’s only for us who are seeing both the live event and the webcast simultaneously that it appears out of sync.”*

This interaction was one of numerous instances where messages were exchanged and suggest that moderating the event was also a learning experience for the research team.

### 5.3.3. Sociability

Sociability was used to categorize the postings that involved more casual banter such as: *“Good morning everyone, you’re early”*, when participants started logging on before the webcast or, the following response to one remote participant who was encouraging us about the success of the event. The conference moderator responds: *“Thanks for the encouraging words. It has been a bit bumpy for some but generally I think a good experience.”*

An interesting and serendipitous series of exchanges took place between a mother and her son who were both attending the event remotely—one in New Brunswick Canada, and one in New York City. The following excerpt captures their interactions as they used various parts of the ePresence message features. It is interesting to observe the relatively fluid movement between public and private conversations. They also reported that they were simultaneously maintaining a series of face-to-face exchanges with people in their location. We would like to think that this is a reflection of the human-centered approach taken to system design: Private message from participant 1 in New York: *“Hi Mom! How’s it going? I just tuned in.”* Participant 2 in

New Brunswick responds: *“Great. Interesting dialogue.”* Participant 2 then submits a text question to the presenter using the ePresence text question feature: *“Could you comment on parenting courses and their effectiveness. What works? How important is it to provide individual help and supports for family?”* A few minutes later Moderator Two, the conference convenor poses the question face-to-face to the presenter: *“... this is another question from New Brunswick: “Could you comment on parenting courses and their effectiveness. What works? How important is it to provide individual help and supports for family?””*

At the end of the presentation some 10 minutes later the participant 2 asks: *“Hi. What did you think of it?”* The event stops for a break between sessions and the audience is told that the next presentation will resume in 20 minutes. Just before the presentation starts participant 2 comes back online. She asks participant 1: *“Are we back on yet?”* Participant 1 responds: *“Hi Mom—All I see is the sidewalk outside of OISE... Hey, there’s [the conference convenor]. Guess we’re back on!”* Participant 2: *“This is just so fascinating and so much fun. What is your impression?”* Participant 1 responds: *“It is very cool. Part of the problem that I’ve had is being able to dedicate myself to the conference. One good thing about going away is that you are away from work (no student’s knocking on your door!)”* Participant 2 responds: *“I know. Same with me. At least this will be archived... He sure speaks quickly. Doesn’t even take a breath.”* Participant 1 replies: *“You can say more that way!”* Participant 2 asks: *“Who is this fellow? Do you have a comment or question?”* Participant 1 responds: *“Sir Michael Rutter. I feel like I haven’t been paying close enough attention to ask a good question. (Mine would have to be about the research.)”* Participant 2: *“... I think these researchers are more interested in their research than the application or even involvement and reciprocity with other stakeholders or sectors.”* Participant 1 responds: *“Well, yeah. But it is also what they know. You should ask application questions—that was part of the mandate of the conference.”* Participant 2: *“OK, that makes sense.”*

This exchange shows the continuity of the personal conversation, but it also points to the issues about multitasking and the cognitive overhead that are involved in participating in multiple conversations at different levels in a short period of time. It further raises an important point about how the event was organized and draws attention to the importance of communicating the goal of the event clearly to the participants in advance. In this case, the focus on the scientists was planned from the start, but opening up the event may have in the past sent a mixed signal, and as we saw with the local participants excluded from the roundtables, an unintended social disconnect. Further, it is not clear the extent to which the scientists were prepped to consider the remote audience. From their position, without access to the ePresence application, this remote audience was essentially invisible.

#### 5.3.4. Administrative

Administrative postings were the most common and included instruction and information from the ePresence Administrator to update the remote participants and facilitate their involvement. For example: *“To all our on-line participants: we are trying to reserve the “All Questions” feature for concise content questions to be addressed to speakers or scientists in general. Please feel free to experiment and let the general chat lead you where it may. We’ll be ready to go in ~5 minutes.”*

Participants became engaged and offered a variety of advice to the administrative and technical team. A member of the Education Commons had a suggestion for the videographer: *“Might I suggest the back camera pull back on [the conference convenor] to give a “Montel Williams” feel. We would like to see a bit of the audience.”* A remote participant site from Victoria, British Columbia also had some views on how the first roundtable session was being conducted as seen in this comment: *“Can we ask that the Clyde Hertzmanns [respondent for the first roundtable session] of the process to be more focused and perhaps answer one issue at a time and have the panel respond rather than addressing every issue in “one” speech. I think the points made would be retained and commented on in a more effective process.”* This suggestion was in fact successfully relayed and taken up in the subsequent roundtable as witnessed when the respondent of the second roundtable states: *“So I thought what we’d do is just break up the questions a little bit more because it was hard I think to remember all of them when Clyde went through them.”*

On a number of occasions, members of the research team who were also monitoring the event used the private message feature to address the issue of integrating the remote audience more fully into the live event. In this interaction, a senior member of the ePresence research group, located elsewhere on campus, has dropped in remotely during a roundtable discussion to see how things are going. He shares his thoughts with the conference co-ordinator on how the live group was not integrating or aware enough of the online participants: *“I’ve only listened in sporadically, but there seems to be little attempt to engage either a local or remote audience in the dialogue. Will this happen later?”* The conference co-ordinator responds: *“... I think this will hopefully come in the question period at the end. As for here in the library there are not many getting up to use the public terminals. I think I will ask Moderator Two if he can keep trying to encourage people, maybe they are shy or intimidated.”* The researcher replies: *“I may be wrong but it looks like the problem is not with the remote attendees, but that the panel is so involved in their discussion and no one else is being let in. Sorry, must leave now.”* The conference co-ordinator follows up by sending a private message to Moderator One about conveying this message. Moderator One then sends a private message to Moderator Two

Table 5. Breakdown of posted messages

	Day 1 Total	Day 1%	Day 2 Total	Day 2%
Subject related	23	5%	63	21%
Technical	264	62%	87	29%
Sociability	54	13%	101	33%
Admin	86	20%	53	17%
	427	100%	304	100%

saying: “Can you remind the studio audience and the on-line participants to feel free to type in questions at any point in the Roundtable” A few minutes later Moderator One tries again as Moderator Two is clearly engrossed in the discussion: “Hi [convenor] we should try to get some online questions on the table and introduce them verbally as such so that the participants will feel their issues are being addressed.” Moderator Two eventually responds: “Will do.”

This theme of bridging the remote and face-to-face participants, either through providing instructions for getting questions ready for the presenters or discussing how to enhance the experience for the remote participants to make them feel more included, is a common through-line across the administrative postings.

Table 5 provides a breakdown of the 731 messages that were posted during the 2-day webcast. There were 427 messages on Day 1 and 304 messages on Day 2.

Of particular interest were the increases in the percentage of messages in the category of substantive messages from an average of 5% on Day 1 to 21% on Day 2, and Sociability messages from 13% on Day 1 to 33% on Day 2. Decreases were found in Technical messages from 62% on Day 1 to 29% on Day 2 and Administrative messages from 20% on Day 1 to 17% on Day 2.

#### 5.4. Participant Response and Input

There was no formal evaluation of the event. However, from the outset, there had been a plan to create some sort of archive of the Webforum that participants and others could access. On the last day, the participants at OISE/UT were told that an archive of the event would be available online, and that they needed to sign up to indicate their interest in accessing this. This form about the archives included a brief evaluation on the event itself. Participants were asked to rate their responses on a scale of 1 (poor) to 10 (excellent): “Overall was it a useful experience for you?” Of the 37 forms that were submitted, a total of 27 people filled out the evaluation component. Table 6 shows their responses.

Table 6. Webforum 2001 questionnaire results (N = 27)

<b>1 (poor) to 6</b>	<b>Percentage of responses</b>
7	8%
8	20%
9	24%
10 (excellent)	48%

Several people responded to the request for “other comments”. Responses were generally positive about the event at OISE/UT: *“First-rate planning, eminent speakers, friendly venue. Archives, especially access to video, papers, and slides would be good.”* But it was clear that these participants did not like having to view the roundtables as remote participants: *“The roundtable might have been easier to follow if it were in front of an audience.”* In light of the positive experiences reported by the geographically remote participants as we will see below, we expect that the negative response of the local audience was less a reflection of the technology *per se* and more indicative of what might be described as a breakdown of an implicit social contract when the social norms of face-to-face conference participation were suddenly replaced by a technologically mediated experience—something that they had not signed up for. Furthermore, it cannot have helped that the roundtables included only the international scientists and a small group of senior scholars/respondents. The participants at OISE/UT were both simultaneously “present” and “absent” at the event in a way that those who were geographically distant did not experience.

As the geographically remote participants already had created user accounts in order to use ePresence, they automatically had access to the proposed archives and therefore did not receive the above form. However, immediately following the final presentation a number of participants responded generally very positively and saw the use of the VLE as an opportunity. They provided helpful suggestions for improving the experience and encouragement for the continuing this line of research: *... It's a great way to hold a conference and I'm sure it will become widespread once the technology becomes more transparent to the end user. Day 2 at home on a cable modem, the video quality was just as good as the high speed network at the university. It would be nice to have a little more resolution in the slides since they often convey fine detail. But I was able to print selected slides, which is very nice. Microphone input so one can ask questions orally instead of in print would be a nice advance as well. I imagine this takes lots of bandwidth and adds another layer of complexity. Please consider phone support in future WebCasts to help end-users who can't logon during a session. Keep up the good work!! ... a researcher in Nova Scotia.*

*The key I think is to ensure sound and overheads are working well. ~At times the overheads lag behind. ~Another problem is small font size on overheads. They can be a challenge to read. When you have to concentrate on small things like that it can be hard to pay attention to what are often difficult concepts coming fast. It would be very helpful to have the overheads ahead of time so we can print for reference and notes. Just another thought to fine tune: When a speaker is finished her/his presentation the final slide is left up. It would be nice if it could be replaced or removed. You may want to replace with a title slide or something to set the context of what is happening. If nothing else you could replace with one of those babies from earlier today. . . . a satellite group in Manitoba.*

*In the days following the event, additional unsolicited comments came in via e-mail from both the OISE/UT and remote attendees: Congratulations on an amazing undertaking. Thank you so much for the opportunity to join The Millennium Dialogue events. If you would be so good as to forward me any materials you have on the event itself—and, when you have options for purchase of the program, please provide those details as well, as we'd like to promote it to our audience of 5,000 perinatal professionals across North America . . . Once again—thanks. I trust you feel most gratified (although exhausted!) . . . a media representative.*

*I found the Webcast very thought provoking. I'm anxious to view the final presentation. I felt like somewhat of a pioneer as a participant of the Webcast experience itself. The wonders of technology! . . . a participant from Manitoba.*

*We were interested not only to receive such positive input but also to see the number of comments that referred to having access to the post-event archives for ongoing professional development: A million congratulations on successfully staging the Webcast conference. We watched during the two-day event . . . We plan to Re-broadcast at least one of the presentations and hold our own roundtable discussion in the first week of December. Many thanks again for all your assistance enabling us to be part of the history-making Webforum 2001 . . . a remote participant located at the University of Victoria, British Columbia.*

*Congratulations on the MDC Webcast—what a concept! I wasn't able to be online for the whole thing, given the time difference and other commitments but now plan to indulge myself in the archives. What I saw/heard was so stimulating and this is a fantastic way to get the word out. I'd also like to run emerging thoughts about the course I'm doing around MDECD by you. . . . an educator at the University of British Columbia.*

*What a wonderful gathering! Many thanks for including me. I am eager to revisit the Dialogue archives website, but I think I need a password. Can you give me directions? . . . a government consultant.*

*This was excellent and worked so well. Thank you so much for all your efforts and the opportunity to be involved. I am sure we will use the archives and we will contact you. . . . a remote group in Prince Edward Island.*



## 6. POST-EVENT: UNANTICIPATED CONSEQUENCES

### 6.1. Webforum Archives

At the time of Webforum 2001 an online archive system was not part of the ePresence application. The practice up to this time had been to produce a VHS of each production so that the content was not lost. Early in the planning period, however, Videotelephony—who had been involved with ePresence—had raised the idea of creating an online archive. The overwhelming support for the Webforum event and interest expressed in gaining access to materials for ongoing use encouraged us to pursue this idea of developing knowledge media products to promote and support an ongoing culture for learning and knowledge distribution. KMDI's ePresence team set up a Webforum Archive and Videotelephony continued to partner with the conference co-ordinator on planning and preparation during this post-event knowledge media production period.

While demand for an archive was high from the local and remote participants, the most persistent requests came from the Australian contingent. A number of groups and individuals in Australia had registered for Webforum, however a combination of technical difficulties and the time difference prevented them from attending the event live. As the following illustrates: *“Not sure if you got my previous e-mail—technical difficulties here. I couldn't participate in the live online forum but am keen to access archives if that's possible. Can you please let me know about this?”*

The archive interface in the first iteration, seen in the screen capture, offered the similar features to the live broadcast interface (Figure 4).

The key difference in the archive interface was an additional eResource Library slide on the right side, which provided access to related materials and allowed users to toggle between either a live chat window in the bottom frame and or a public threaded discussion. In this respect individuals and groups could interact either synchronously or asynchronously around the archived event. The turn around time to create these archives from the live capture was approximately 3–5 days and the archives were available online for a temporary period of 4 weeks while we planned for a more permanent knowledge media product. Towards the end of this period we received the following e-mail from a professor in Newcastle Australia: *“Hi, unfortunately I wasn't able to access these [archives] before the middle of December because of problems at our end with the firewall slots, and over the weekend our internet access has been down. However, what I was able to log into, which was the first day, was fantastic. Is there any hope of (a) either extending the period during which access to the archives is possible or (b) getting a CD-ROM of the proceedings? I've missed William Boyce, Richard Tremblay, Alicia Lieberman, and Dan's summing up which I desperately wanted to hear. It's been a great resource—congratulations to all*

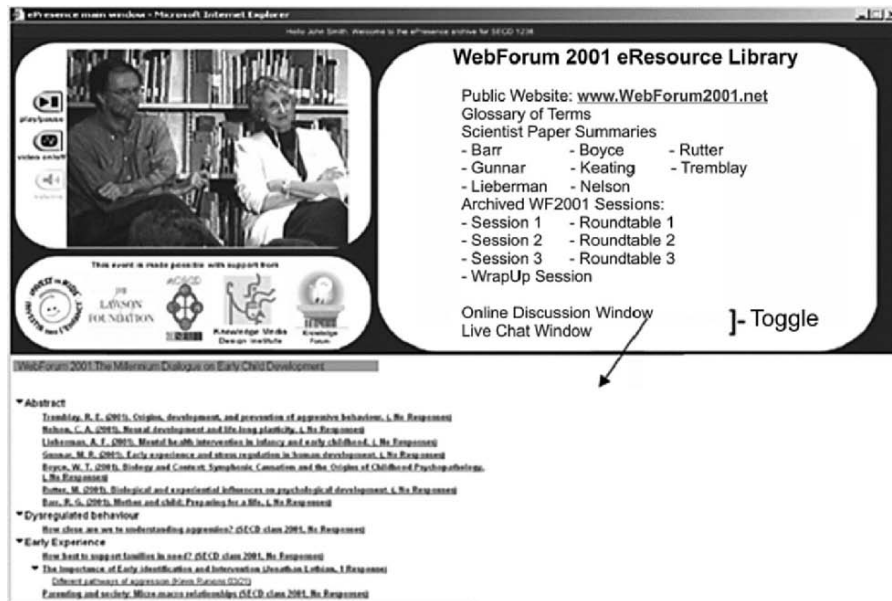

Figure 4. Webforum archive user interface.

of you for enabling those of us far away to be voyeurs on such a fantastic workshop.”

No systematic data are available on the use of the archives, however, in at least five cases participants informed us of their use of the Webforum content for separate events, seminars, and courses.

## 6.2. Conversations on Society and Child Development (CSCD)

A significant use of the ePresence archive was as the basis for the creation of a knowledge base for *Conversations on Society & Child Development*, an interactive eResource which uses compact disk [CD] and web technologies and which was designed to support a VLE for accessing the knowledge and supporting exchange among those who generate research and those who want to apply the findings.

CSCD was developed with VideoTelephony Inc. and Graphix-Design in Ottawa as a series of four CDs. Each compact disk contains the video and synchronized slides of two scientists, paper summaries of the talk, other supporting materials and references, the audio of the post-presentation question periods, and the roundtable discussions. In addition to this, the resource was designed to link to a flexible tailor-made VLE for ongoing interaction, collaboration, and resource sharing. The vision for this web interface was to

www.cscd.ca

# CONVERSATIONS

ON SOCIETY & CHILD DEVELOPMENT

**Responsive Environments**

Issue 2



The second part in a series of four editions captures the presentations and discussions from [WebForum2001.net](#), November 8<sup>th</sup> and 9<sup>th</sup>, 2001. Eight internationally renowned scientists each presented on the early child development research in their disciplines. The scholars and three invited respondents then discussed each other's theories, research, and real-world applications in a roundtable format.

**MISSION STATEMENT**  
*... A dialogue among academics, practitioners, policy makers & communities to encourage the application of knowledge to actions...*

The Atkinson Centre for Society and Child Development

Edition 1.2  
 October 2002

**In This Issue**

- About CSCD.ca
- FEATURES
  - Megan Gunnar:  
**Early Experience & Stress Regulation in Human Development**
  - Ronald Barr:  
**Mother & Child Preparing For a Life**
  - Roundtable:  
**Respondent, Jennifer Jenkins**
- RESOURCE DIRECTORY
- IT'S LIVE
- UPCOMING

Navigation buttons: back, forward, search, and a minus sign.

Figure 5. CSCD V1.2 front page.

facilitate the use of CSCD for professional development, seminars, or as a class resource. Figure 5 shows the first page of CSCD Edition 1.2. On the right side under “In This Issue”, interactive buttons take the user to each section of the issue. Alternatively, users can use the buttons in the bottom right corner to scroll through each individual page.

Tables 7 and 8 provide summary information on the post-event archive and CSCD users by location and employment sector.

In both the Webforum archive registrants and the CSCD subscribers the largest group is academic—faculty, researchers, practitioners (83). The second and third largest are, respectively, organizations and government agencies who are working in some aspect of early child development. We see that similar to the Webforum live participant group, users of the archives and CSCD represent a diverse range such as university and college faculty, Human Resources Development Canada, psychologists, clinicians, researchers, child care workers, policy workers, and other groups or organizations working in the field of early child development.

Table 8 shows the distribution of the participants by geographic location.

Table 7. Post-event knowledge media participants by employment sector

<b>Number of Participants: by Occupation</b>	<b>Webforum Archive Registrants</b>	<b>CSCD Subscribers</b>	<b>Total</b>
Education	59	29	88
Organization	14	10	24
Health	2	5	7
Government	11	6	17
Technology	0	6	6
Foundations	0	2	2
News media	0	1	1
Other	3	6	9
Totals	89	65	154

The breakdown of participant locations is again similar to that of the attendees of the live Webforum 2001. The primary difference is the Australian participants. Here we see that this group has become the largest international group and second largest representative location along with Manitoba (14). There is also an increase in participants from Minnesota, San Francisco (3), and the United Kingdom (2). At the time of writing, some 65 members, groups, and individuals have made use of the CSCD eResource for professional development and/or educational purposes. CSCD was never aggressively marketed. Subscribership has since diminished and again no formal study has been done. Our intent, however, is to provide the resource to future purchasers of the published book of the MDECD papers (Keating, in press).

Table 8. Post-event knowledge media participants by location

<b>Participants: by Location</b>	<b>Archive Registrants</b>	<b>CSCD Subscribers</b>	<b>Total</b>
New Foundland	1	0	1
Nova Scotia	1	0	1
New Brunswick	1	1	2
Quebec	8	2	10
Ontario	2	13	15
Greater Toronto Area	62	20	82
Manitoba	4	10	14
Alberta	2	1	3
British Columbia	2	1	3
New York	0	1	1
Minnesota	1	2	3
San Francisco	1	2	3
United Kingdom	1	1	2
Australia	3	11	14
Total	89	65	154

### 6.3. The Red River College Early Childhood Education Resource

The Red River College initiative was an unexpected outgrowth of the MDECD that provided a unique insight into the process of translating knowledge for different audiences. When Red River College (RRC) in Manitoba, Canada decided that they wanted to work toward updating the Early Child Education (ECE) curriculum to reflect the latest science, they approached Dr. Fraser Mustard of The Founders Network.<sup>10</sup> He informed them about the MDECD and suggested that they contact us to discuss a future potential association.

In spring of 2001, we met with the Red River group at OISE/UT. They spoke to us about their intention to seek funding to support the project and we welcomed the collaboration. It was decided that the group should participate in the MDECD events. They enrolled as part of the distance auditor group in the graduate course and attended Webforum 2001. The core project team members flew to Toronto to attend the live webcast conference but they also arranged for the college to be a satellite group so that other faculty could participate online from Winnipeg. After the final event in the spring of 2002, we hosted an additional online seminar for ECE faculty to further discuss the knowledge and its potential applications to practice. This was attended by 13 individuals located in Toronto, Manitoba, British Columbia, and Nova Scotia.

With funding in place, RRC assembled an advisory committee comprised of faculty from colleges across Canada to help develop a strategic plan, translate the content for the college level, provide input into the design of the prototype, and serve as pilot' sites. The Webforum archives became the primary base for what has been developed into a five-module interactive multimedia resource for Early Child Education programs at the college level. The screen capture of WebCT shows the home page for the ECE resource (Figure 6).

This resource was iteratively piloted with ECE faculty across Canada from 2002 to 2004 and is currently being piloted for professional development as well as with students and faculty in ECE programs in Ontario, Manitoba, Alberta, and British Columbia.

## 7. DISCUSSION

A VLE is defined elsewhere in this volume as a “learning environment mediated by computers and digital technologies.” VLE case studies are described as, “instances in action framed by conceptualizations, technologies, and cultures.” The data gathered during Webforum 2001 demonstrate how MDECD’s original conceptualization of a socio-techno design for knowledge development in early childhood was advanced by the use of the ePresence Interactive Media System as a VLE. Details were collected on the participant community, their use of the technology, the nature of their interactions, and how they

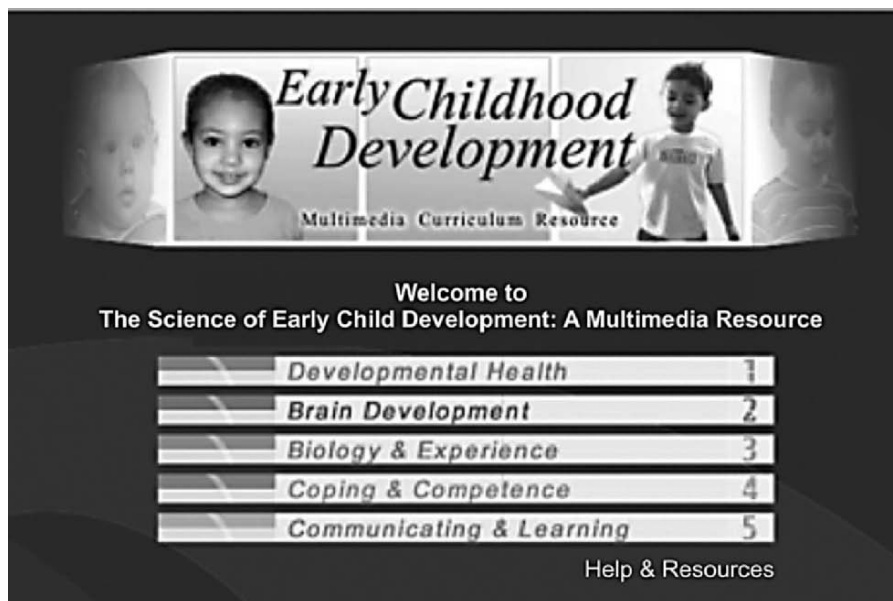

Figure 6. Red River College ECE resource home page.

perceived the event. Examination of the postings also highlighted the critical role of facilitation and provided insight into the ways in which the technology contributed to sustaining a culture for learning and knowledge building across several different conditions.

Though a key objective of the MDECD was to achieve conceptual innovation—what McLuhan (1964) would have referred to as the “message”—the initiative also became a learning experience with respect to technological innovation—or the “medium”—and how social relationships are impacted. Webforum 2001 was intentionally designed to move beyond a traditional conference format to explore alternative possibilities, and part of this involved broadcasting the roundtable sessions from a separate location so that the library audience could experience what it was like to be a remote participant. We did not anticipate, however, that the audience would consider this a breach of social custom and feel excluded from the scientists who were merely feet away in another room. It would appear that as creatures of habit we tend to prefer what we are familiar with, face-to-face interaction within familiar convention. The OISE/UT participants clearly attended Webforum for the knowledge content and not the technological medium. This may also be a reason why their engagement decreased during the roundtable sessions; it is possible that they felt excluded or uncomfortable using the computer terminals to submit questions.

The remote audience, on the other hand, was of necessity drawn into both content and medium. But though they experienced numerous technical

glitches, their appreciation of being able to attend the event at all superseded any inconvenience arising from these complications. As the technical difficulties decreased and their familiarity with the technology increased, they became more engaged and even shared how they were experiencing the technology, providing invaluable “in the moment” insights through postings that made their thinking explicit. They also bonded together in moments of difficulty often helping each other when problems arose. In this respect, we saw that the ePresence VLE afforded a sense of inclusion and community amongst the online distributed participants.

The technology also afforded other advantages and unanticipated uses not readily available to the local OISE/UT participants. Remote users were able to socialize with each other as well as input and offer general commentary to an extent that the local audience could not. For example, it is highly unlikely that a face-to-face member would have felt comfortable enough to comment on how the roundtable discussion was organized or to make suggestions for improvements in front of other audience members. Social interactions using the various ePresence VLE features, such as the sequence between the mother and the son, demonstrated how the ePresence system supported multitasking. The two interlocutors not only attended the event and submitted public questions, but they were also able to talk privately about their impressions without interrupting the other attendees. Face-to-face participants would have to wait for the break to engage in this kind of discourse. Another advantage of the ePresence VLE was that users could scroll back and forth through the presentation slides or print up hard copies. These observations by no means suggest that given a choice the remote users would not have preferred to attend the event face-to-face, they merely point out the extent to which the technology had built in affordances that the participants used as they saw fit, sharing their impressions and taking the initiative to shape the experience into something more personally meaningful.

Finally, the features of the ePresence VLE supported multiple modes of interaction across time, space, and distance. Synchronous interaction was supported as participants engaged with each other and the expert presenters either using the microphone in the library space or live chat and text question features in the VLE. In addition, the captured event and the subsequent knowledge media products provided options for distributed users to access the multimedia knowledge base and interact synchronously or asynchronously with others either through a live chat or threaded discussion, respectively.

A significant aspect of interaction was mediation. Vygotsky contributed to our understanding of the role of the facilitator in scaffolding the learning process (Bruner, 1985) and Wenger (1998) refers to the broker who mediates between different worlds to build connections for improved information flow and augment social learning opportunities. Our experience with Webforum emphasized the importance of this. Not only was facilitation required to mediate the face-to-face dialogue and to help remote users with the technology,

consistent effort was also required to ensure that the virtual presence was included into the face-to-face proceedings. This notion of facilitation was also apparent in the Red River College initiative where the MDECD team assisted in the translation of the knowledge base for a college level Early Child Education program. Last but not least, the ePresence VLE was invaluable as a “brokering” tool. As seen in the transcripts of the online postings, the technology afforded rich insight into what the users were going through, how they adapted to the environment, and what they thought of the technology. In effect, the technology served as a facilitator, or mediator, helping us to understand the participant experience and leading us to think differently about social relationships we generally take for granted. These insights have been instrumental to the ongoing iterative design improvements of the ePresence Interactive Media System at KMDI. Details on some of these are discussed below.

Less positive aspects of the technology were that distractions arose when things did not work properly and when the public chat was cluttered with public notes related to individual technical problems or non-content-related issues that would have been better handled using the private message feature. As the logs show however, this “improper” use diminished by Day 2 as users became more familiar with the VLE. The switch from the library location to the roundtable conference room further contributed to renewed disruptions and adjustments. As webcast technology was still rather sensitive at that time and the majority of the online participants were novices to webcasting, it might have been best not to have moved the equipment. In future, we might think about having either the complete conference in one location, or duplicating the technology set-up in the roundtable room to make the switch over more seamless.

Response from both the face-to-face and online participants indicated that the 2-day Webforum was successful on a couple of levels. First and foremost was the level of public satisfaction. The event was well attended, and the ePresence VLE helped to establish a sense of community through supporting interaction amongst the online participants and across the remote into the material conference. As witnessed by the learning community that emerged during the Red River initiative, the ePresence multimedia capture of the 2 days also inadvertently became the first step in sustained community building.

Learning communities emerge when like-minded people group together to make connections, share ideas, pursue mutual goals, and generate knowledge in a mutually supportive and reciprocal manner (Daniel, 2002; Marsick et al., 2000; Misanchuk & Anderson, 2001). Another characteristic is a diverse participant group—ranging from novice to experts—that can enrich the learning experience and contribute multiple perspectives (Xiadong et al., 1996). The Webforum event brought together an extremely varied group of students, organizations, researchers, policy makers, and practitioners all seeking to access the most current knowledge in early child development and to discuss practical applications. The ePresence VLE broadened this knowledge network across



geographical boundaries and facilitated the extension of what typically would have been an isolated 2-day event through establishing the knowledge base that was subsequently used for the creation of the knowledge media products.

## 8. WHAT HAS HAPPENED SINCE

Our early uses of ePresence including Webforum 2001 convinced us that it was important that events be easily archived and made available to users *via* a customizable web portal. The archives needed to be hierarchically structured, browsable, and full-text searchable. Our implementation of this provides an interactive timeline and two-level table of contents for easy browsing and navigation. The concept of hierarchically structured video is based in part on work described in Baecker et al. (1996) and Baecker and Smith (2003).

The current ePresence Interactive Media system (Baecker 2002; Baecker 2003; Baecker et al., 2003; Baecker et al., 2004; Baecker et al., 2004) also allows configurable live and archive interfaces through tailorable “skins”, which allow site-specific control over the layout and typography of both interfaces, and the inclusion of corporate logos for purposes of “branding”. The media capturing and streaming engines run under Windows or Linux; client viewers exist for the IBM PC, the Macintosh, and Linux. Media may be transmitted using Windows Media, Real Media, and MPEG4. Webcasts may be received with bandwidths as low as a 56 K modem. The software is implemented with .NET technology, is highly modular, and is soon to be released open source (Baecker, 2005; Rankin et al., 2004).

One difference between knowledge media (Baecker, 1997) and traditional media is the ease with which we can modify the capabilities and qualities of the medium through relatively straightforward software developments. Thus, motivated in part by insights gained in Webforum 2001, and in the hundreds of hours of webcasting done by us and our ePresence partners since that event, we are currently engaged in a number of initiatives to enhance the software and make it a better VLE:

- supporting mobile devices for ePresence access so that attendees at an event (local viewers) can also participate in the dialogue among remote viewers;
- enriching the sense of presence, so that local viewers can get a better sense of the remote audience, and so that remote viewers can experience in even more engaging experience;
- allowing questions from remote viewers to be expressed in voice rather than in text using Voice Over Internet Protocol (VOIP) capabilities;
- allowing voice discussions (much like whispering to one’s neighbor in a lecture) to occur while watching a webcast (Schick et al., 2005);
- enhancing our understanding of how knowledge-seekers use multimedia archives (Dufour et al., 2004; Dufour et al., 2005; Toms et al., 2005);

- enabling searching of the archives using the voice track in addition what exists now, which is searching *via* text that appears in the chapter titles and in the slides;
- integrating a real-time chat capability that has persistence after the event with a capability for threaded discussions over the archives (Baecker et al., in press);
- integrating ePresence with an online course environment so a course could seamlessly interact with live events and archives increasing the impact and sustainability of the VLE.

## CONCLUSION

McLuhan maintained that the tendency to focus on the message and not the medium underestimates the real impact that media have in radically altering the experience being communicated (Marchand, 1989). The MDECD sought to address this conceptual–technological divide by bringing the science in early child development together with leading-edge technology with aspirations of exploring a socio-technological design for knowledge advancement. This chapter describes how we used the ePresence Interactive Media System as a VLE for Webforum 2001—MDECD’s culminating event—as a preliminary foray into the role of technology for supporting geographically dispersed participants and mediating social opportunities for accessing, sharing, using, creating, and proliferating knowledge across real and/or asynchronous time. Webforum 2001 as a 2-day event did not generate large quantities of data, neither was it formally designed in advance. Its significance, nonetheless, was that it germinated the seed for ongoing technological design and the emergence of a learning community for Early Child Development, which is still active to the present day.

## ACKNOWLEDGMENTS

We would like to acknowledge the MDECD Research Team: Dona Matthews, Jane Bertrand, Kevin Runions, Denese Coulbeck, and Erin Spano as well as the ePresence Team: Maciek Kozłowski of VideoTelephony Inc., Peter Wolf, David Torre, and Anne Postic. Integral to this collaboration were also Ron Cooke and the Education Commons group at OISE/UT: Avi Hyman, Patrick Hopewell, Dick Combeer, Bill Lechow, and Neil Tinker. Thanks also to Paul Haggins of Graphix-Design for his work on Conversations on Society and Child Development.

Finally, this work would not have been possible without the generous support of Invest in Kids Foundation, the Lawson Foundation, the Connaught Committee/University of Toronto, the Natural Sciences and Engineering

Research Council of Canada, and the Bell University Laboratories of the University of Toronto.

#### ENDNOTES

1. Webforum 2001 took place on November 8th and 9th at the Ontario Institute of Studies in Education of the University of Toronto: see <http://hdap.oise.utoronto.ca/mdecdec> or <http://www.Webforum2001.net>.
2. OISE/UT: see <http://oise.utoronto.ca>, Invest in Kids: see <http://www.investinkids.ca> and the Lawson Foundation: see <http://www.lawsonfoundation.ca>.
3. Canadian Institute for Advanced Research: see <http://www.ciar.ca>.
4. Developmental Health is an omnibus term the authors use to describe a variety of developmental outcomes such as competence and coping, mental and physical health, and educational achievement.
5. For chapter summaries by Dona Matthews: see <http://hdap.oise.utoronto.ca/dhwn>.
6. Zijdemans was a member of the committee from the outset and deeply involved in the initiative.
7. Knowledge Forum (<http://kf.oise.utoronto.ca>) was developed at OISE/UT by faculty members, Scardamalia and Bereiter, to reflect constructivist pedagogical theory by supporting individual and collective understandings of the world through problem solving within a collective discourse.
8. Webcasting technology is typically a one-way broadcast medium that pushes or streams audio and video via the internet so that it can be viewed on a personal computer using a web browser. In contrast to video conferencing, webcasting moves beyond the one-way transmission model in that it is scaleable to a large number of distributed recipients and typically does not experience the same delay.
9. Today, we still use a 3–4 person crew if a high quality production is required (e.g., multiple cameras, mixing, etc.) but it is also possible now for one person to record an event.
10. The Founders Network: see <http://www.founders.net>.

#### REFERENCES

- Baecker, R. M. (1997). Talk on Knowledge Media Design. Available at: <http://kmdi.utoronto.ca/rmb/>.
- Baecker, R. M. (2002). Highly Interactive Webcasting with Structured Archives, Poster presentation. *Proceedings of CSCW 2002*, Conference Supplement, 175–176.
- Baecker, R. M. (2003). A Principled Design for Scalable Internet Visual Communications with Rich Media, Interactivity, and Structured Archives. *Proceedings of CASCON 2003*, 83–96.

- Baecker, R. M. (2005). Open Source Strategies for Educational Multimedia. *Proceedings of ED-MEDIA 2005*, June 27–July 2, 2005, Montreal, PQ.
- Baecker, R. M., Fono, D., & Wolf, P. (in press). Towards a video collaboratory. In: Goldman, R., Pea, R., Barron, B., and Derry, S. (Eds.) *Video Research in the Learning Sciences*. Laurence Erlbaum.
- Baecker, R. M., Moore, G., & Zijdemans, A. (2003). Reinventing the lecture: webcasting made interactive. *Proceedings of HCI International 2003*, Vol. 1, Lawrence Erlbaum Associates, 896–900.
- Baecker, R. M., Rosenthal, A., Friedlander, N., Smith, E., & Cohen, A. (1996). A multimedia system for authoring motion pictures. *Proceedings of ACM Multimedia 1996*, 31–42.
- Baecker, R. M. & Smith, E. (2003). Modularity and hierarchical structure in the digital video lifecycle. *Proceedings of Graphics Interface 2003*, Halifax, NS, 217–224.
- Baecker, R. M., Wolf, P. & Rankin, K. (2004). The ePresence interactive webcasting system: technology overview and current research issues. *Proceedings of E-Learn 2004*.
- Bruner, J. (1985). Vygotsky: a historical and conceptual perspective. In: Wertsch, J. (Ed.) *Culture, Communication, and Cognition: Vygotskian Perspectives*. Cambridge: Cambridge University Press, 21–34.
- Conversations on Society and Child Development. (2002). Available at: <http://hdap.oise.utoronto.ca/csc> and <http://www.cscd.ca>.
- Daniel, B. (2002). *Building Social Capital in Virtual Learning Communities*. University of Saskatchewan, Saskatchewan, Canada. Available at: <http://www.usask.ca/education/coursework/802papers/daniel/daniel.pdf>
- Dufour, C., Toms, E. G., Bartlett, J., Ferenbok, J., & Baecker, R. M. (2004). Exploring user interaction with digital videos. *Proceedings of Graphics Interface 2004*, May 2004, London.
- Dufour, C., Toms, E. G., Lewis, J., & Baecker, R. M. (2005). User strategies for handling information tasks in webcasts. *Proceedings of ACM CHI 2005*, April 2–7, 2005, Portland, OR.
- Keating, D. & Hertzman, C. (1999). *Developmental Health and the Wealth of Nations: Social, Biological, and Educational Dynamics*. New York: Guildford Press.
- Marchand, P. (1989). *Marshall McLuhan: The Medium and the Messenger*. Toronto: Vintage Books.
- Marsick, V. J., Bitterman, J., & Van der Veen, R. (2000). *From the Learning Organization to Learning Communities toward a Learning Society*. Ohio: ERIC Clearinghouse, 1–64.
- Matthews, D. & Zijdemans, A. (2001). Toward a learning society network: how being our brother's keeper is in our own self-interest. *Orbit* 31(4), 50–53.
- McLuhan, M. (1964). *Understanding Media*. Toronto: McClelland & Stewart.
- Millennium Dialogue on Early Child Development. (2001). Available at: <http://hdap.oise.utoronto.ca/mdecd> and <http://www.webforum2001.net>
- Misanchuk, M. & Anderson, T. (2001). Building Community in an Online Learning Environment: communication, Cooperation and Collaboration, Indiana University, Bollmington, Indiana USA. Available at: <http://www.mtsu.edu/~itconf/proceed01/19.html>
- Moore, G. (1997). Sharing faces, places and spaces: The Ontario telepresence project field studies. In: Finn, K., Sellen, A. J., and Wilbur, S. (Eds.) *Video-Mediated Communication*. Mahwah, NJ: Lawrence Erlbaum Assoc., 301–321.
- Nature and nurture in Early Child Development. (In Press) editor Keating, D. P., New York: Cambridge University Press.
- Rankin, K., Baecker, R. M., & Wolf, P. (2004). ePresence: An Open Source Interactive Webcasting and Archiving System for eLearning. *Proceedings of E-Learn 2004*.
- Schick, R., Baecker, R. M., & Scheffel-Dunand, D. (2005). Bimodal Text and Speech Conversation During On-line Lectures. *Proceedings of ED-MEDIA 2005*, June 27–July 2, 2005, Montreal, PQ.

- Toms, E. G., Dufour, C., Lewis, J., & Baecker, R. M. (2005). Assessing tools for use with webcasts. *Proceedings of the ACM-IEEE Joint Conference on Digital Libraries*, June 7–11, 2005, Denver, CO.
- Wenger, E. (1998). *Communities of Practice: Learning, Meaning and Identity*. New York: Cambridge University Press.
- Xiaodong, L., et al. (1996). Instructional design and development of learning communities: an invitation to a dialogue. In: Wilson (Ed.) *Constructivist Learning Environments: Case Studies in Instructional Design*. New Jersey: Educational Technology Publications.
- Zijdemans, A. S. (2005). Exploring a socio-technological design for knowledge development: the millennium dialogue for early child development. OISE/UT dissertation.

## Chapter 57: Networked Scholarship

BARRY WELLMAN\*, EMMANUEL KOKU\*, AND  
JEREMY HUNSINGER†

\**University of Toronto*; †*Virginia Polytechnic Institute and State University*

### 1. THE TRANSFORMATION OF COMMUNITY

Community has traditionally been anchored in local, neighborhood interactions and enshrined as a code word for social cohesion. “Community” usually connotes people socially and cognitively encapsulated by homogeneous, broadly embracing groups (Hillery, 1955; Wellman, 2001a; Wellman, 2002; Wellman & Leighton, 1979). People in group-based societies deal principally with fellow members of the few groups to which they belong: at home, in school, in the neighborhood, at work or in voluntary organizations. They work in a discrete work group within a single organization; they live in a household in a neighborhood; they are members of one or two kinship groups; and they participate in structured voluntary organizations: churches, bowling leagues, unions, and the like. There have been fears since the industrial revolution that traditional group-based community has been “lost”. From the early 1960s, the balance of analysis swung away from bemoaning this purported loss of community to using ethnographic and survey techniques to discover the persistence of neighborhood communities. In the 1970s, analysts began realizing that communities were flourishing outside of neighborhoods. The proliferation of cheap and efficient transportation and communication networks in the developed world has increased the velocity of transactions and fostered interactional density. This allows contact to be maintained with greater ease and over longer distances. Since the 1970s, many studies have documented a change from local to long-distance community, with little interaction across the intervening territory between places. Few neighbors are known, and most friends and relatives live elsewhere (Fischer, 1982; Wellman, 1997; 1999a, b; Wellman & Leighton, 1979).

In the internet age, communities and their networks have spread through the information commons. As computer-mediated-communication spread through academic communities, new uses for it were imagined. With learning as one of the primary missions of academic institutions, it is not surprising that virtual learning environments were developed. The context of the development of virtual learning environments have been influenced by a myriad of scholarly communities and networks and the virtualized relationships they provide. Our understanding of those networks can be increased through researching networked scholarship.

## 2. INVISIBLE COLLEGES AND SCHOLARLY NETWORKS

Scholarly networks have existed since at least the Middle Ages. Remnants of the correspondence of ancient scholars such as Desiderius Erasmus, St. Thomas More, and others reveal that scholarly networks communicated actively during the Renaissance, continued through Enlightenment, and continues today.

The 19th-century's increase in the scale of scholarship and the Industrial Revolution's turn toward hierarchical bureaucratic organizations narrowed the focus of scholarly societies, professionalizing education, and restructuring the universities. The main bases for scholarly organization became spatial proximity or disciplinary affinity. Most scholars work in physically compact universities (or similar research centers), where they meet students and colleagues face-to-face. Yet, universities and their departments are polyglot, physically compact bureaucracies geared for organizing teaching and for administering costly resources. A department's faculty is intentionally diverse in order to serve the perceived needs of students and the public in a smorgasbord of areas. This diversity also means that university departments often are too large and diverse to be suitable venues for scholars wanting to discuss a specific problem area.

The 20th-century's proliferation of research, researchers, and research publications has meant a global increase in the number of specialists in each area. Increased specialization means that the scholars most interested in each other's work usually live elsewhere because few universities care to employ two experts on the same subject. Intellectually kindred souls find each other by forming professional associations within their discipline or interdisciplinary interest area. Such associations are rarely local, except on a small scale or when disciplinary associations are foregone in favor of transdisciplinary efforts. Scholars must go to (often-great) lengths to communicate with distant, kindred souls. Rather than wait impatiently for replies or discussions of their findings, they go to conferences, read periodicals, or circulate preliminary thoughts and findings via attachments, web-postings and blogs. In addition to formal associations, the narrowed focus of scholarship and the limited number of faculty in local proximity has fostered the proliferation of extra-university networks to support the interests of individual faculty members.

As scholars get used to seeing each other at conferences and journals and develop the habit of discussing each other's work and perhaps collaborating, all or part of their network becomes crystallized as a less amorphous *invisible college*, defined by a shared interest in a specialty and by ties of friendship, information, advice, and collaboration. The long-standing practice of scholarly communication in these networks is the foundation for understanding development and change in the academy.

Studies of scholarly networks have increased since the early 1960s when Price (1961) coined the term "invisible colleges" to describe the patterns and

structure of scholarly networks [see also Crane (1972)]. Such invisible colleges “function as a scholarly in-group within a given specialization”, their research “facilitated by informal exchange of information through contacts within this social network at conferences and other forums” (Gresham, 1994: 38). Their structures are networks with crosscutting ties between sets of scholars on both the core and the periphery. The informal nature of these invisible colleges affords flexible, adaptive structures for exchanging and evaluating new ideas. Their lack of formal structure means that communication depends on the structure, frequency, and quality of scholarly ties.

Invisible colleges provide forums for sharing, disseminating, and testing new ideas, as well as for exchanging information about teaching, research, funding opportunities, academic bureaucracies, and personal situations. They promote scholarly identity and purpose and stimulate discussion of theory, methods, and findings. Ideas get transmitted more quickly and innovatively than in formal journals constrained by publication lags and orthodoxy-promoting refereeing, though this too is changing in the online era. Typically, they contain:

- a core group of elite scholars;
- a high degree of communication through formal (conferences, papers) and informal channels among members;
- frequent communication between prominent core scholars and subsets of less prominent, non-core scholars;
- interactions among core members and their adherents hold the invisible college together;
- contacts between members of invisible colleges and outsiders enable mutual exchange of information.

### 3. WIRING SCHOLARLY NETWORKS

Rapid developments in computer-mediated communication are associated with a paradigm shift in the ways in which institutions and people are connected. This is a shift from being bound up in small groups to surfing life through diffuse, variegated social networks. Although the transformation began in the pre-internet 1960s, the proliferation of the internet both reflects and facilitates the shift. To facilitate the design of communication tools to aid scholarly communication and online-learning behavior, it is useful to understand the social structure of scholarly networks, the types of media used by these networks, and the conditions under which different media are used.

Much social organization no longer fits a group-centric model of society. Work, community, and domesticity have moved from hierarchically arranged, densely knit, bounded groups to social networks. In networked societies, boundaries are more permeable, interactions are with diverse others, linkages



switch between multiple networks, and hierarchies are flatter and more recursive. People maneuver through multiple communities, no longer bounded by locality. Organizations form complex networks of alliances and exchanges, often in transient virtual or networked organizations (Bar & Simard, 2001).

How people learn is becoming part of this post-industrialization paradigm shift. There has been some move away from traditional classroom-based, location-specific instruction to virtual-learning environments. There has also been some move away from teacher-centered models of learning to student-centered models and somewhat flatter hierarchical relations have arisen. Geographically and spatially dispersed learning is part of this shift. Learning has moved beyond traditional many-to-teacher correspondence and educational television courses to computer-supported many-to-many or distributed learning.

Even before the development of the internet, cars, planes, phones, and text-based computerized communication supported substantial communication and collaboration among physically dispersed scholars (Finholt, 2001; Finholt et al., 2002). The advent of the internet has especially placed fewer constraints of time and place on communication. Scholars can stay in their locale to connect, interact, and collaborate with each other over great distances (Assimakopoulos & Macdonald, 2002; Finholt, 2001; Koku et al., 2001; Matzat, 2004; Mutschke & Quan-Haase, 2001). Now traditional e-mail and web sites are being joined by online audiovisual technologies supporting collaborative work (Barrett, 2000; Churchill et al., 2001; Ragusa & Bochenek, 2001). Distance education programs offer a variety of courses, supplementing traditional means of instruction with computer-mediated lectures, discussions, activities, and projects (Harasim et al., 1995). In some cases, computer-mediated communication has enabled the operation of entire university programs online (Acker, 1995; Noam, 1998). Instead of university faculties localized at their university departments, virtual faculties, formalized “collaboratories” link far-flung scholars, institutions, and research centers (Finholt, 2001). Even more prevalent are informal collaborations among scholars located in different universities that sometimes span the globe.

Computer-mediated communication is providing a technological basis for new forms of spatially dispersed, loosely bounded, networks of scholars that are more connected than the fitful, amorphous relationships of the past and less physically proximate and bureaucratically structured than contemporary universities. These networks of scholars are closer to the idea of the invisible college, and perhaps before the invisible college arose—the republic of letters. Those institutions were distributed networks of intellectuals and scholars that shared knowledge and communicated with each other over large distances. Of course, the velocity of communication is now more rapid; distant scholars stay in touch more; and instant messaging, e-mail, and attachments fill gaps between face-to-face meetings.

The possibility for all to communicate rapidly with all via internet technologies, no matter where located, has created hopes that peripheries would become as well-connected as centers. As distance matters little for computer-mediated communication, spatial isolation should not be a problem, though other barriers still exist, such as those based as on language or state policy. As all become connected to all, formerly disconnected persons, groups, and branch campuses should be as able as those at the center to communicate with others. This should affect the structure of scholarly networks: As e-mail, instant messaging blogs, and attachments of text and data help to maintain direct ties, social density increases and the periphery—whether spatial, social, organizational, or scholarly—can become better connected with the core or cores, should a plurality of centers develop.

Research has shown that computer-mediated communication supports a range of instrumental, informational, social, and emotional exchanges in work and leisure contexts (e.g., Baym, 1995; 1997; Rice et al., 1998; Wellman & Gulia, 1999; Quan-Haase & Wellman, 2004; 2005). Building on this work, there is a need to understand the types of interpersonal interactions, multiple exchanges of material and emotional support, intimacy, trust, and self-disclosure that characterize learning communities online and offline (Granovetter, 1973; Haythornthwaite, 2002; Haythornthwaite & Kazmer, 2002; Marsden & Campbell, 1984; Wellman, 2001a; Wellman & Berkowitz, 1988).

The changes in how people socialize in the network society have created a need to develop new models for conceptualizing and measuring community. Considering that socializing occurs beyond the boundaries of the local neighborhood, workplace, or school, useful approaches define community not in terms of locality, but as social networks of interpersonal ties that provide sociability, support, information, a sense of belonging, and social identity (Castells, 2000; Wellman, 2001a; Wellman et al., 1988). By examining people's social relationships independently of narrowly defined boundaries based on location, researchers have discovered that many people live in long-distance communities (Wellman & Wortley, 1990). Thus, this evidence suggests that industrialization did not destroy community, but helped transform its composition, practices, attitudes, and communication patterns. This finding parallels what we might assume: virtual learning environments will not destroy learning or scholarly communities but will transform them to some extent.

Social network analysis provides an approach that can facilitate understanding communities. Viewing community as comprising social networks of relations enables analysts to examine the types of interactions—such as information, emotional support, material support, companionship—which affect online communities. It facilitates the assessment of the extent to which computer-mediated communication supports online learning communities with low levels of centralization and hierarchy (Ahuja & Carley, 1999; Haythornthwaite & Kazmer, 2002).

#### 4. SOCIAL NETWORK ANALYSIS OF COMPUTER SUPPORTED NETWORKS

Much research on computer-mediated communication has focused on how the characteristics of different communication media affect what each medium can convey (Garton, et al., 1998; Wellman & Haythornthwaite, 2002). Such characteristics include the richness of cues a medium can convey (for example, whether a medium is text only such as e-mail or also includes visual and auditory cues), the visibility or anonymity of the participants (video-mail versus voice mail); whether communications identify the sender by name, gender, title; and the timing of exchanges (e.g., synchronous or asynchronous communication). Until recently, social scientific research into computer-mediated communication has concentrated on how individual users interface with computers, how two persons interact online, and how small groups function online. Much less attention has been paid to how computer networks fit into the broader social networks and contexts in which these individuals, duets, and groups are connected. Yet, the social relationships that people have with each other are embedded in social networks that affect their social resources, mobility, happiness, and work habits (Wellman, 1999a; 2001a).

Social network analysis stresses the importance and patterns of relationships among interacting units: people, organizations, states, etc. The social network approach enables analysts to go beyond viewing relationships only in terms of groups and isolated duets. It incorporates into research a set of structural variables such as the density, clustering, heterogeneity, and multiplicity of networks (Ahuja & Carley, 1999; Berkowitz, 1982; Scott, 1991; Tindall & Wellman, 2001; Wellman, 1998; 1999a; Wellman & Berkowitz, 1988; Wasserman & Faust, 1994). Social network analysts have developed procedures for seeing how different types of relationships inter-relate, detecting structural patterns, and analyzing the implications that structural patterns have for the behavior of network members. For example, the fact that person A and person B interact online may be understood better if one takes into consideration their offline reporting relationships to person C, the company Vice President.

Thinking about relationships in terms of social networks rather than in groups can allow analysts to examine the social contexts of online relationships and focus on the potential of computer-mediated communication to support less-bounded, sparsely knit interactions (Fulk & DeSanctis, 1995; Fulk et al., 1987; Rice et al., 1990; Wellman & Gulia, 1999; Wellman et al., 1996). For example, analysts may enquire whether there is a core and periphery in a particular network structure and then examine how involvement in such structural blocks helps explain the behavior and attitudes of network members. For example, do peripheral people send more e-mail and do they communicate only with members of their own clusters or with others?

Network analysts also look at both *whole networks* and *personal networks* (Wellman & Berkowitz, 1988). Whole network analyses look at patterns of

relationships in a social system, be it a set of scholars or a set of states. Personal network analyses look at each person's own network, such as how the networks of different scholars vary.

The social network approach has developed a battery of concepts and methods that can aid analysis of communities, online and offline. Using examples from online communities in general, and learning communities in particular [the next section of this chapter], this subsection examines the usefulness of social network concepts such as range (size and heterogeneity), density and boundedness, centrality, tie strength, and multiplexity (multiple roles) for understanding online communities and social relationships.

#### **4.1. Network Range (Size, Heterogeneity)**

The concept of network range pertains to the size and diversity of the population within the network's boundaries (Burt, 1983; Haines & Hurlbert, 1992). Networks with high range (large, heterogeneous) are good for seeking and obtaining new resources (Wellman, 1999a; Newman, 2001). On the other hand, networks with low range (small, homogeneous) are able to conserve resources and information within their boundaries.

Computerized conferences, newsgroups, and listserves facilitate and increase the range of social networks (Smith, 2000). The asynchronicity and relatively inexpensive cost of online communication transcends spatial and temporal limits, enabling system users to communicate over different time zones and maintain contact with their weak ties. Therefore, online communication links can increase the range of social networks. Given that e-mail relationships have few social cues and social presence, the only personal detail that communicators may initially know about each other is their e-mail addresses and signatures. Such limited personal information allows development of relations based on shared interests rather than on shared social status (Hiltz & Turoff, 1993). This may flatten the hierarchy of status found in communities and other learning environments, thus fostering more interaction among more people.

#### **4.2. Centrality**

Network centrality indicates the extent to which certain network members are prominent in a given network in terms of connectivity among network members. Centralization scores (measured as percentages) measure how variable or heterogeneous are the individual network member centrality scores. It records the extent to which a single network member has high centrality scores, and the others have lower scores. A high centralization score means a network's activity centers on a particular member.

Scholars who have high degree centrality are those with many connections with other network members. Such scholars are involved in relations with many others and could be recognized by other scholars as major channels of scholarly information and activity. Well-connected network members usually play key roles in shaping the behavior and perceptions of others in the network, particularly in the diffusion of innovations and the use of available media (Rogers, 1983; Valente, 1995). Central network members tend to use a variety of media (Haythornthwaite & Wellman, 1998), have the most positive experiences with media use (Papa & Tracy, 1988), be early adopters of new information systems, and facilitate the development of critical masses of users for the systems (Rice, 1997; Rice et al., 1990).

When directionality is taken into account, there are two kinds of degree centrality: *In-degree centrality* measures how many other network members report having a relationship with a specified person. For example, others mention scholars with high in-degree centrality as people they approach for advice or discussions. Thus, in-degree centrality is one measure of the prestige of a network member. In contrast, *out-degree centrality* measures how many other network members a person reports being connected with. Thus, it is an indicator of the extent to which a scholar reports reaching out to others.

*Betweenness centrality* measures the extent to which a network member occupies a location between others in the network. Persons with high betweenness are often positioned in the collaborative and communication network between people who are not directly connected. Network members with high betweenness facilitate communication and information flows. They broker information, link otherwise disconnected scholars, and transmit information across disciplinary and organizational boundaries (Ahuja & Carley, 1999; Burt, 1992; Orlikowski & Barley, 2001; Tushman & Scanlan, 1981). Thus, scholars with high betweenness are in powerful collaborative and communication brokerage positions between otherwise disconnected scholars.

Central scholars are better able to control and diffuse information. They also are better able to sustain more central communication roles because of their prestige, popularity, and grant funding (Crane, 1972). This has positive feedback effects, leading to increased conference attendance, speaking engagements, and interaction with disparate others (Perry & Rice, 1998). All of these interactions expose scholars to more ideas, make them better known within professional and policy circles, and popularize their research. This sustains the cycle of centrality and prestige because central scholars are better able to respond to promising ideas, influence the direction of policy, and retain funding.

Central scholars tend to have a more sophisticated level of knowledge of the things worth knowing: the debates and lore that are crucial for leading-edge scholarship. While peripheral scholars may be apt to discover new ideas because of their connections to other scholarly communities, central scholars may introduce such peripheral ideas into the mainstream or else

the ideas otherwise might lack attention or awareness within scientific communities (Perry & Rice, 1998). Thus central scholars both disseminate and filter, for as Erickson (1996) suggests, one of the useful consequences of being in the center is that central people know what they can afford not to know.

#### 4.3. Density

The density of a social network is the extent to which its members are in direct contact with one other. Hence, the rate of information flow in networks partly depends on whether networks are densely or sparsely knit. Densely knit, bounded networks (i.e., “groups”) usually experience frequent contact among members. In such networks, most relationships remain within the population, with the exception of a few boundary spanners and gatekeepers who maintain links outside. Frequent contact within these groups and the wide range of group activities fostered by members create close relationships among members.

In contrast, members of sparsely knit networks have many ties with people who are more closely linked to other networks. Ties in such sparsely knit networks tend to be more variable than those in densely knit networks in terms of what network members do together, how supportive they are, and how frequently they interact (Danowski, 1986; Wellman, 1997).

Computer-mediated communication supports both densely knit and sparsely knit networks. Focused task and work groups, MUDs and some moderated newsgroups, and listserves are densely knit communities. As they develop, they often evolve rules and leadership structures and require attention and commitment from their members (Kollock & Smith, 1998). Message management features of e-mail systems can increase network density and enable friends and colleagues to keep informed. Third parties spread the word about who has help, who needs help, who has been helpful in the past, and who has been a free rider. Forwarding communications to third parties also provides indirect connections between previously unconnected people. Ease of direct reply can then transform a transitive, indirect tie to a direct tie.

Computer networks also support sparsely knit networks. Participants can send e-mail to anyone whose address they know, and they can simultaneously belong to multiple discussion lists and chat groups. They can engage in different kinds of discussions about different subjects on different lists, varying their involvement and commitment in different work groups, maintaining connections with distant acquaintances, and forming new ties with strangers. Information may come unsolicited through blogs, distribution lists, chat groups, forwarded messages from friends, and direct e-mail from strangers connected through mutual ties. Sparsely knit networks are usually connected through weak ties to a variety of social circles. Hence, they are more apt to

be sources of new information and potential alliances (Granovetter, 1973; 1983).

#### 4.4. Tie Strength

The strength of a tie is a multidimensional construct comprising social closeness, voluntariness, and multiplexity. Some scholars also add frequent contact to the defining criteria (Granovetter, 1973; 1983; Wellman & Wortley, 1990). Strong ties often provide more support and information, and a sense of belonging. However, Granovetter contends that weak ties are useful for specific purposes. He argues that people belong to clusters of others with whom they have strong and weak ties. Information circulates at high velocity within these clusters, and each person tends to know what other cluster members know. Hence, the spread of new information, ideas, and opportunities often comes through the weak ties that connect people in separate clusters.

Some studies have focused on the effect of tie strength on the flow of resources and information among scholars. Friedkin's (1980, 1982) study of university faculty contrasts the importance of strong versus weak ties for information flows. He shows that in the aggregate, the large number of weak scholarly ties contribute significantly to information flows. Although strong ties provide much information about activities within an organization, weak ties provide useful information about activities outside of a work group or organization (Levin et al., 2002).

Despite e-mail and IM's limited social presence and absence of social cues, their ease and ubiquity supports strong, frequent, supportive, and companionable contact (Garton & Wellman, 1995; Kling, 1996; Nie et al., 2002; Rheingold, 2000; Sproull & Kiesler, 1991; Quan-Haase & Wellman, 2004; 2005; Wellman & Gulia, 1999). So, strong and supportive are some online relationships that some participants in an online group came to feel that fellow members were close friends (Bastani, 2001; Hiltz & Turoff, 1993; Kendall, 2002). Concerns about how computer-mediated communication supports strong ties ignore the many relationships that combine online and offline communication. Computer-mediated communication is often used to maintain contact between face-to-face meetings and phone calls. Indeed, computer-mediated communication often coincides with in-person meetings, fills in gaps between, and helps arrange future meetings. Conversations began in one medium and drift to another. For example, computer scientists and programmers working in the same physical space often communicate by e-mail and IM as well as in-person (Haythornthwaite & Wellman, 1998; Quan-Haase & Wellman, 2004; 2005). Learning communities are no different, with friendship and informal relationships—online and offline—being the fluid that lubricates the formality of collegial and academic collaborations (Carley & Wendt, 1991; Glanz, 1999; Gresham, 1994; Grimshaw, 1989; Toren, 1994).

## 5. TECHNET: A SCHOLARLY COMMUNITY

TechNet is a network of scholars and professionals in a North American university interested in a coherent set of issues at the intersection of the social sciences, humanities, sciences and engineering. It began informally in the early 1990s as a scholarly network at one university and formally became a university research institute “a visible college” in the mid-1990s (Nazer, 2000; Walsh & Bayama, 1996). TechNet’s goals are to:

- facilitate an intellectual community of scholars, researchers, and students from a number of disciplines;
- facilitate appropriate partnerships with other universities, the private sector, non-profit organizations, and government;
- afford the intersection of the relevant disciplines a more prominent place and role within the university;
- create and support colloquia and lecture series;
- facilitate visits to the university of distinguished scholars and research working in these areas and to increase support for graduate students;
- establish one or more appropriate funded chairs and professorships;
- create additional relevant courses, and increase awareness of existing course that cross disciplinary boundaries;
- create a new collaborative degree program;
- develop and offer short professional development courses for industry and society.

TechNet’s activities have been guided by a multidisciplinary steering committee that meets monthly. Membership in TechNet is voluntary and open to all faculties with an interest in TechNet’s domain. At the time of our data gathering at an early stage of TechNet’s development, administration was informal, with only one part-time paid administrative assistant. There were 24 members of TechNet—from the social sciences, physical sciences, medical sciences, humanities, and engineering. Members of TechNet organize and meet in a variety of online and offline forums to exchange ideas, to discuss emerging research, and to socialize. Some of these are weekly multidisciplinary seminars, annual conferences and symposia, retreats, end-of-semester/year parties.

TechNet is a scholarly network or more broadly, a community of practice with a shared history and cosmology (Barab & Duffy, 2000). Many founding members and some other members were initially linked through participation in joint research, conference attendance, reading the same journals, membership in university committees, and advising on graduate student projects. TechNet is also linked with other communities interested in the intersection of the humanities, social sciences, and technology. As one member explains in an interview:



The ways that an entire citizenry can be much more actively and successfully involved in knowledge development and knowledge society is the core interest of mine and that of a number of TechNet members. I just think that this interest is grossly under-represented in the kind of work that is done in the university and underrepresented in formal structures. There are lots of faculty who are doing exciting things, but there are no formal structures to network together.

## 6. RELATIONSHIPS AND NETWORKS IN TECHNET

To learn more about TechNet, one of us (Emmanuel Koku) interviewed all 24 TechNet members in 1997–1998 about their work, friendship, and media use inside and outside of TechNet, asking members to describe their scholarly and social relations with each other TechNet member. This elicited reports about 405 pairs of scholars: their work relationship, social closeness, friendship, frequency of scholarly communication, and type of communication media used. Although much of these interviews are analyzed statistically, we also rely on notes of conversations held during the interviews and Wellman and Koku's own active participation in TechNet [this section summarizes material presented in Koku and Wellman (2004); see also Koku et al. (2001)].

TechNet scholars report having an average of five “friends” within TechNet (22% of the total membership), 10 “colleagues” (43%), 9 “acquaintances” (39%), and 4 others of whom they are “just aware” (17%; Koku and Wellman, 2004; Koku et al., 2001). They are in e-mail contact with 19 (82%) other members and in face-to-face contact with 14 (61%). Most use e-mail where necessary for work relationships such as discussion of research, and supplement this with face-to-face communication when they meet in person in workshops, seminars, and other collegial gatherings. These statistics underestimate the significance of face-to-face contact, as it is usually longer in duration than e-mail contact and provides more communication bandwidth. Those pairs of TechNet scholars who are in touch are in relatively frequent contact: a mean of 20 times per year and a median of 10 times per year. As all TechNet members are comfortable with computers, they use e-mail often: 56% of all Technet pairs have some e-mail contact.

e-mail and computer-mediated communication supports face-to-face contact rather than supplants it, with members using it to arrange face-to-face meetings, disseminate news, and exchange documents. Those TechNet members using e-mail send messages to each other at a mean rate of 24 times per year, an average of twice per month. To Technet members, non-face-to-face communication means computer-mediated communication. Only a minority use telephones, faxes, and couriers, and those who do use these media, use them infrequently. The most widely used of these are local telephone calls, used by only 25% of TechNet members to communicate with other members.

Those who telephone do so on the average of once per month (mean = 11 calls per year). Most TechNet pairs use a combination of communication media to keep connected. Thirty-two percentage use two media while 23% use three or more.

Discussing and seeking research advice are not uniformly distributed in collegial communities. The more intense the work relationship, the smaller the scholar's network. The average TechNet member discusses work with 17 other TechNet members (74%), but reads the work of only five (22%) and also collaborates with five (22%; not necessarily the same five) in research and proposal writing. These may be overlapping networks, with some scholars discussing each other's work, reading these works, and collaborating in research.

Larger scholarly networks vary more in the intensity of their communications (e.g., e-mail) and scholarly (e.g., discussion) networks. Thus, e-mail contact networks are as large and heterogeneous as face-to-face contact networks. Similarly, research discussion networks are larger and more heterogeneous than reading or collaborative networks. The size and heterogeneity of e-mail networks stem in part from the ease of making contact without regard to spatial and temporal separation, and the ease of including several scholars in the same message. Moreover, forwarding e-mail messages fosters the development of more extensive and intensive relationships among scholars. The development of such heterogeneous linkages is facilitated by TechNet's weekly seminars, workshops, and other social events that provide an in-person focus (Feld, 1981) where scholars make and sustain collegial and sociable contact with people from different disciplines [for a similar pattern in another scholarly network, see Koku et al. (2001) and Nazer (2001)]. Such networks are important avenues for the provision of social, instrumental, and emotional support and for the mobilization and co-ordination of collective activity.

e-mail and face-to-face contact play complementary roles and reinforce each other. Rather than substituting for face-to-face contact, those who use e-mail often also tend to have more face-to-face contact (Chen et al., 2002; Quan-Haase & Wellman, 2002; 2005). The impact of e-mail is not so much in what is communicated, but in who communicates with whom, how frequently, and over what distances. Despite TechNet's frequent public gatherings, face-to-face contact is more centralized than e-mail contact. Core planners and researchers combine face-to-face, e-mail and occasional phone contacts. Peripheral members are more apt to use one of these media to keep in touch with TechNet activities. Some rely on scheduled face-to-face get-togethers to find out what is happening administratively and intellectually. Others, who do not want to go across campus to meetings, rely on broadcast e-mail and occasional focused exchanges. These networks have fluid and permeable boundaries for the structure of relationships in TechNet varies according to the activity being performed (Ahuja & Carley, 1999; Koku & Wellman, 2004). These networked

scholars use e-mail for a wide range of things: exchanging drafts among coauthors, setting up meetings, asking for information, or gossiping about colleagues. Although pundits worried a decade ago about whether merely textual e-mail could sustain a wide range of interactions—from information seeking to emotional stroking—it is the social context, more than the nature of the medium that affects whether e-mail will be used. Expectations only a decade ago that e-mail would only be used for purely instrumental communication appear to have been a product of an early fascination with the novelty of e-mail and an over-reliance on McLuhan's (1962) speculation that the medium is the message.

In short, TechNet has been a success in building a scholarly network and turning it into a visible college. It has:

1. linked scholars across a variety of disciplines in the humanities, social sciences, and sciences;
2. provided a milieu where most members are aware of each other's work;
3. fostered a large amount of innovative collaborative work and discussions across disciplines;
4. integrated the use of e-mail and face-to-face contact into useful means of communication.

TechNet has continued to develop. The scholarly network has become more visible and institutionalized. Collaborative research has become more extensive, and well-attended lecture series solidify internal communication and reach out to other scholars, policymakers, technology companies, and the public. A graduate program offers a set of core interdisciplinary courses and an extensive list of affiliated courses with collaborating scholarly departments in the social sciences, physical sciences, and engineering. Although most arrangements remain informal, there is a full-time paid director, additional paid part-time staff, and steering and executive committees.

## CONCLUSIONS

We are living in a paradigm shift in which the way in which people and institutions are becoming more connected through social networks and less so through formal groups. Members of old-paradigm societies deal only with fellow members of the few groups to which they belong: at home, in the neighborhood, at work, or in voluntary organizations. They belong to a discrete work group in a single organization; they live in a household in a neighborhood; they belong to one or two kinship groups, and to one or two voluntary organizations: churches, bowling leagues, professional associations, and the like. All of these are hierarchically structured bodies with precise boundaries for inclusion.

In contrast, in new-paradigm networked societies, boundaries are more permeable, interactions are with diverse others, linkages switch between multiple networks, and hierarchies are flatter and more recursive (Castells, 2000; Wellman, 1988; 1997; 2001b; Wellman & Hogan, 2004). Although computer networks have not caused this paradigm shift, they have aided it. e-mail and the web let people move between their different social networks and interests. Hierarchical barriers are lower online and less apparent. It is easy for scholars to maintain an e-mail address book with thousands of names and to maintain multiple lists of like-minded scholars whom they can contact at the drop of an e-mail. e-mail and IM provide ease and flexibility in who communicates with whom, what means they use to communicate, what they communicate, and when they communicate.

Scholarly communities of practice are not homogeneous entities, whether they are in online, offline, or both. Online mutual-learning communities consist of scholars with varying roles, levels of involvement, positions, and varying levels of connectivity with other community members (Hiltz & Wellman, 1997). Further, the structure of these relationships is related to the types and variety of communication media used. Rather than seeing the internet as a separate interaction system, people (including scholars) use it opportunistically to fit into their everyday lives (Chen et al., 2002; Hampton & Wellman, 2003; Quan-Haase & Wellman, 2002). A substantial body of research suggests that designers of online educational communities and virtual learning environments need to take a broad look at the social networks of community members, and how media use and network structure facilitate and constrain mutual peer-to-peer learning.

#### ACKNOWLEDGMENTS

Our research has been supported by the Bell University Laboratories, the Social Science and Humanities Research Council of Canada, and Daniel Keating's grant from the Telelearning National Centre of Excellence. Ronald Baecker, Gale Moore, and Nancy Nazer gave much good advice. We deeply appreciate the time and interest that the members of "TechNet" gave to us.

#### REFERENCES

- Acker, S. R. (1995). Space, collaboration, and the credible city: academic work in the virtual university. *Journal of Computer Mediated Communication* 1(1). Available at: <http://www.ascusc.org/jcmc/vol1/issue1/acker/acktext.htm>.
- Ahuja, M. & Carley, K. (1999). Network structure in virtual organizations. *Organization Science* 10(6), 741–757.
- Assimakopoulos, D. & Macdonald, S. (2002). A dual approach to understanding information networks. *International Journal of Networking and Virtual Organizations* 1(1), 1–16.

- Bar, F. & Simard, C. (2001). New media implementation and industrial organization. In: Lievrouw, L. and Livingstone, S. (Eds.) *Handbook of New Media*. London: Sage, 254–263.
- Barab, S. & Duffy, T. (2000). From practice fields to communities of practice. In: Land, D. H. J. S. M. (Ed.) *Theoretical Foundations of Learning Environments*. Mahwah, NJ: Lawrence Erlbaum, 25–56.
- Barrett, R. (2000). Virtual communities and the internet. Working Paper, The Reginald H. Jones Center for Management Policy, Strategy, and Organization, Wharton Business School, University of Pennsylvania, Philadelphia.
- Bastani, S. (2001). Muslim women on-line. *Arab World Geographer* 3(1), 40–59.
- Baym, N. (1995). The performance of humor in computer-mediated communication. *Journal of Computer-Mediated Communication* 1(2). Available at: <http://www.usc.edu/dept/annenberg/vol1/issue2>.
- Baym, N. K. (1997). Interpreting soap operas and creating community: inside an electronic fan culture. In: Kiesler, S. (Ed.) *Culture of the Internet*. Mahwah, New Jersey: Lawrence Erlbaum, 103–120.
- Berkowitz, S. D. (1982). *An Introduction to Structural Analysis: The Network Approach to Social Research*. Toronto: Butterworth.
- Burt, R. (1983). Range. In: Burt, R. and Minor, M. (Eds.) *Applied Network Analysis*. Beverly Hills, CA: Sage, 176–194.
- Burt, R. (1992). *Structural Holes*. Chicago: University of Chicago Press.
- Carley, K. & Kira, W. (1991). Electronic mail and scientific communication. *Knowledge* 12(4), 406–440.
- Castells, M. (2000). *The Rise of the Network Society* (2nd ed.). Oxford: Blackwell.
- Chen, W., Boase, J., & Wellman, B. (2002). The global villagers: comparing internet users and uses around the world. In: Wellman, B. and Haythornthwaite, C. (Eds.) *The Internet in Everyday Life*. Oxford: Blackwell, 74–113.
- Crane, D. (1972). *Invisible Colleges: Diffusion of Knowledge in Scientific Communities*. Chicago: University of Chicago Press.
- Churchill, E. F., Snowdon, D. N., & Munro, A. J. (Eds.) (2001). *Collaborative Virtual Environments: Digital Places and Spaces for Interaction*. London: Springer-Verlag.
- Danowski, J. A. (1986). Interpersonal network structure and media use: a focus on radiality and non-mass media use. In: *Inter/Media: Interpersonal Communication in a Media World*. New York: Oxford University Press, 168–175.
- Erickson, B. H. (1996). The structure of ignorance. *Connections* 19(1), 28–38.
- Feld, S. (1981). The focused organization of social ties. *American Journal of Sociology* 86, 1015–1035.
- Finholt, T. (2001). Collaboratories. *Annual Review of Information Science and Technology* 36, 73–107.
- Finholt, T., Sproull, L., & Kiesler, S. (2002). Outsiders on the inside: sharing know-how across space and time. In: Hinds, P. and Kiesler, S. (Eds.) *Distributed Work: New Research on Working across Distance Using Technology*. Cambridge, MA: MIT Press, 357–379.
- Fischer, C. (1982). *To Dwell Among Friends*. Berkeley: University of California Press.
- Friedkin, N. (1980). A test of structural features of Granovetter's strength of weak ties theory. *Social Networks* 2, 411–422.
- Friedkin, N. (1982). Information flows through strong and weak ties in intraorganizational social networks. *Social Networks* 3, 273–285.
- Fulk, J. & DeSanctis, G. (1995). Electronic communication and changing organizational forms. *Organization Science* 6(4), 337–349.
- Fulk, J., Steinfeld, C., Schmitz, J., & Power, J. G. (1987). A social information processing model of media use in organizations. *Communication Research* 14(5), 529–552.

- Garton, L., Haythornthwaite, C., & Wellman, B. (1998). Studying on-line social networks. In: Jones, S. (Ed.) *Doing Internet Research*. Thousand Oaks, CA: Sage, 75–105.
- Garton, L. & Wellman, B. (1995). The social uses of electronic mail in organizations: a review of the research. *Communication Yearbook* 18, 434–453.
- Glanz, J. (1999). What fuels progress in science? Sometimes, a feud. *New York Times*, D1–D2.
- Granovetter, M. (1973). The strength of weak ties. *American Journal of Sociology* 78, 1360–1380.
- Granovetter, M. (1983). The strength of weak ties: a network theory revisited. *Sociological Theory* 1983, 201–233.
- Gresham, J. J. (1994). From invisible college to cyberspace college: computer conferencing and the transformation of informal scholarly communication networks. *Interpersonal Computing and Technology* 2(4), 37–52.
- Grimshaw, A. (1989). *Collegial Discourse: Professional Conversation Among Peers*. Norwood, NJ: Ablex.
- Haines, V. & Hurlbert, J. (1992). Network range and health. *Journal of Health and Social Behavior* 33, 254–266.
- Hampton, K. & Wellman, B. (2003). Neighboring in Netville: how the internet supports community and social capital in a wired suburb. *City and Community* 2(3), 277–311.
- Harasim, L., Hiltz, S. R., Teles, L., & Turoff, M. (1995). *Learning Networks: A Field Guide to Teaching and Learning Online*. Cambridge, MA: MIT Press.
- Haythornthwaite, C. (2002). Building social networks via computer networks: creating and sustaining distributed learning communities. In: Renninger, K. A. and Shumar, W. (Eds.) *Building Virtual Communities: Learning and Change in Cyberspace*. Cambridge: Cambridge University Press, 159–190.
- Haythornthwaite, C. & Kazmer, M. (2002). Bringing the internet home: adult distance learners and their internet, home, and work worlds. In: Haythornthwaite, C. and Wellman, B. (Eds.) *The Internet in Everyday Life*. Oxford: Blackwell, 431–463.
- Haythornthwaite, C. & Wellman, B. (1998). Work, friendship and media use for information exchange in a networked organization. *Journal of the American Society for Information Science* 49(12), 1101–1114.
- Hillery, G. J. (1955). Definitions of community: areas of agreement. *Rural Sociology* 20, 111–122.
- Hiltz, S. R. & Turoff, M. (1993). *The Network Nation*, 2nd ed. Cambridge, MA: MIT Press.
- Hiltz, S. R. & Wellman, B. (1997). Asynchronous learning networks as virtual communities. *Journal of the ACM* 40(9), 44–49.
- Kendall, L. (2002). *Hanging Out in the Virtual Pub: Masculinities and Relationships Online*. Berkeley: University of California Press.
- Kling, R. (1996). Social relationships in electronic forums: hangouts, salons, workplaces and communities. In: Kling, R. (Ed.) *Computerization and Controversy: Value Conflicts and Social Choices*, 2nd ed. San Diego: Academic Press, 426–454.
- Koku, E., Nazer, N., & Wellman, B. (2001). Netting scholars: online and offline. *American Behavioral Scientist* 44(5), 1750–1772.
- Koku, E. & Wellman, B. (2004). Scholarly networks as learning communities: the case of TechNet. In: Barab, S. and Kling, R. (Eds.) *Designing Virtual Communities in the Service of Learning*. Cambridge: Cambridge University Press, 299–337.
- Kollock, P. & Smith, M. (Eds.) (1998). *Communities in Cyberspace*. London: Routledge.
- Levin, D., Cross, R., & Abrams, L. (2002). The strength of weak ties you can trust: the mediating role of trust in effective knowledge transfer. Presented to the *Academy of Management Conference*, Denver, August.
- Marsden, P. & Campbell, K. E. (1984). Measuring tie strength. *Social Forces* 63, 482–501.

- Matzat, U. (2004). Academic communication and internet discussion groups: transfer of information or creation of social contacts? *Social Networks* 26(3), 221–255.
- McLuhan, M. (1962). *The Gutenberg Galaxy: The Making of Typographic Man*. Toronto: University of Toronto Press.
- Mutschke, P. & Quan-Haase, A. (2001). Collaboration and cognitive structures in social science research fields. *Scientometrics* 52(3) 487–502.
- Nazer, N. (2000). The emergence of a virtual research organization: how an invisible college becomes visible. Unpublished Ph.D. Thesis. Department of Sociology, University of Toronto.
- Nazer, N. (2001). The emergence of a virtual research organization: how an invisible college becomes visible. Unpublished Ph.D. Thesis, Department of Sociology, University of Toronto.
- Newman, M. E. J. (2001). Ego-centered networks and the Ripple effect: why all your friends are weird. Working Paper, Santa Fe, NM: Santa Fe Institute, 7.
- Nie, N., Hillygus, D. S., & Erbring, L. (2002). Internet use, interpersonal relations and sociability: a time diary study. In: Wellman, B. and Haythornthwaite, C. (Eds.) *The Internet in Everyday Life*. Oxford: Blackwell, 215–243.
- Noam, E. M. (1998). CMC and higher education. *Journal of Computer Mediated Communication* 4(2). Available at: <http://www.ascusc.org/jcmc/vol4/issue2>.
- Orlikowski, W. & Barley, S. (2001). Technology and institutions: what can research on information technology and research on organizations learn from each other? *MIS Quarterly* 25(June), 145–165.
- Papa, M. J. & Tracy, K. (1988). Communicative indices of employee performance with new technology. *Communication Research* 15(5), 524–544.
- Perry, C. & Rice, R. (1998). Scholarly communication in developmental dyslexia: influence of network structure on change in a hybrid problem area. *Journal of the American Society for Information Science* 49(2), 151–168.
- Price, D. D. S. (1961). *Science Since Babylon*. New Haven: Yale University Press.
- Quan-Haase, A., Cothrel, J., & Wellman, B. (2005). Instant messaging for collaboration: a case study of a high-tech firm. *Journal of Computer Mediated Communication*. 10(4), article 13.
- Quan-Haase, A. & Wellman, B. (2002). Capitalizing on the net: social contact, civic engagement, and sense of community. In: Wellman, B. and Haythornthwaite, C. (Eds.) *The Internet in Everyday Life*. Oxford: Blackwell, 291–324.
- Quan-Haase, A. & Wellman, B. (2004). Local virtuality in a high-tech networked organization. *Analyse & Kritik* 26(special issue 2), 241–257.
- Quan-Haase, A. & Wellman, B. (forthcoming). Hyperconnected network: computer mediated community in a high-tech organization. In: Heckscher C. and Adler, P. *Collaborative Community in Business and Society*. New York: Oxford University Press.
- Ragusa, J. & Bochenek, G. (Eds.) (2001). Collaborative virtual design environments. *Communications of the ACM* 44, 12(December), 40–90.
- Rheingold, H. (2000). *The Virtual Community*, Revised edition. Cambridge, MA: MIT Press.
- Rice, R. (1997). Relating electronic mail use and network structure to R&D work networks. *Journal of Management Information Systems* 11(1), 9–29.
- Rice, R. E., D'Ambra, J., & More, E. (1998). Cross-cultural comparison of organizational media evaluation and choice. *Journal of Communication* 48(3), 3–26.
- Rice, R., Grant, A., Schmitz, J., & Torobin, J. (1990). Individual and network influences on the adoption and perceived outcomes of electronic messaging. *Social Networks* 12, 27–55.
- Rogers, E. (1983). *Diffusion of Innovations*. New York: Free Press.
- Scott, J. (1991). *Social Network Analysis*. London: Sage.
- Smith, M. A. (2000). Some social implications of ubiquitous wireless networks. Working Paper, Microsoft Research, Redmond, WA.

- Sproull, L. & Kiesler, S. (1991). *Connections*. Cambridge, MA: MIT Press.
- Tindall, D. & Wellman, B. (2001). Canada as social structure: social network analysis and Canadian sociology. *Canadian Journal of Sociology* 26, 265–308.
- Toren, N. (1994). Professional-support and intellectual-influence networks of Russian immigrant scientists in Israel. *Social Studies of Science* 24, 725–743.
- Tushman, M. L. & Scanlan, T. J. (1981). Boundary spanning individuals: their role in information transfer and their antecedents. *Academy of Management Journal* 24(2), 289–305.
- Valente, T. (1995). *Network Models of the Diffusion of Innovations*. Cresskill, NJ: Hampton Press.
- Walsh, J. P. & Bayama, T. (1996). The virtual college: computer-mediated communication and scientific work. *Information Society* 12, 343–363.
- Wasserman, S. & Faust, K. (1994). *Social Network Analysis: Methods and Applications*. Cambridge: Cambridge University Press.
- Wellman, B. (1988). Structural analysis: from method and metaphor to theory and substance. In: Wellman, B. and Berkowitz, S. D. (Eds.) *Social Structures: A Network Approach*. Cambridge: Cambridge University Press, 19–61.
- Wellman, B. (1997). An electronic group is virtually a social network. In: Kiesler, S. (Ed.) *Culture of the Internet*. Mahwah, NJ: Lawrence Erlbaum, 179–205.
- Wellman, B. (1998). A computer network is a social network. *SIGGROUP Bulletin* 19(3), 41–45.
- Wellman, B. (1999a). The network community. In: Wellman, B. (Ed.) *Networks in the Global Village*. Boulder, CO: Westview, 1–48.
- Wellman, B. (Ed.) (1999b). *Networks in the Global Village*. Boulder, CO: Westview.
- Wellman, B. (2001a). *The Persistence and Transformation of Community: From Neighbourhood Groups to Social Networks*. Ottawa: Law Commission of Canada, 101.
- Wellman, B. (2001b). Physical place and cyber-place: changing portals and the rise of networked individualism. *International Journal for Urban and Regional Research* 25(2), 227–252.
- Wellman, B. 2002. Little boxes, glocalization, and networked individualism. In: Tanabe, M., van den Besselaar, P., and Ishida, T. (Eds.) *Digital Cities II: Computational and Sociological Approaches*. Berlin: Springer-Verlag.
- Wellman, B. & Berkowitz, S. D. (Eds.) (1988). *Social Structures: A Network Approach*. Cambridge: Cambridge University Press.
- Wellman, B., Carrington, P., & Hall, A. (1988). Networks as personal communities. In: Wellman, B. and Berkowitz, S. D. (Eds.) *Social Structures: A Network Approach*. Cambridge: Cambridge University Press, 130–184.
- Wellman, B. & Gulia, M. (1999). Net surfers don't ride alone. In: Wellman, B. (Ed.) *Networks in the Global Village*. Boulder, Colorado: Westview Press, 331–366.
- Wellman, B. & Hampton, K. (1999). Living networked on and offline. *Contemporary Sociology* 28(6), 648–654.
- Wellman, B. & Haythornthwaite, C. (Eds.) (2002). *The Internet in Everyday Life*. Oxford: Blackwell.
- Wellman, B. & Hogan, B. (2004). The immanent internet. In: McKay, J. (Ed.) *Netting Citizens: Exploring Citizenship in the Internet Age*. Edinburgh: Saint Andrew Press, 54–80.
- Wellman, B. & Leighton, B. (1979). Networks, neighborhoods and communities. *Urban Affairs Quarterly* 14, 363–390.
- Wellman, B., Salaff, J., Dimitrova, D., Garton, L., Gulia, M., & Haythornthwaite, C. (1996). Computer networks as social networks: virtual community, computer supported cooperative work and telework. *Annual Review of Sociology* 22, 213–238.
- Wellman, B. & Wortley, S. (1990). Different strokes from different folks: community ties and social support. *American Journal of Sociology* 96, 558–588.



## Chapter 58: Analysis of Log File Data to Understand Behavior and Learning in an Online Community

AMY BRUCKMAN

*Georgia Institute of Technology*

### 1. RESEARCH METHODS FOR STUDYING ONLINE COMMUNITIES

How do we study the behavior of users in online communities? Researchers from a variety of disciplines have evolved a rich set of both quantitative and qualitative approaches to studying human–computer interaction (HCI) and computer-mediated communication (CMC), and these methods are useful in the study of online communities. Unique to the study of CMC and online communities is the possibility of collecting *log file data*. It is possible for the computer to record every command typed by users—in some cases, every keystroke. In cases where users interact only online, we can collect a comprehensive record of all of their interactions. The completeness of the record and ease of collecting it are unprecedented.

However, log file data is more often collected than analyzed. We can save everything, but what does it mean? This chapter presents two examples of the use of log file data to understand user behavior and learning in one online environment, MOOSE Crossing. MOOSE Crossing is a text-based virtual reality environment (or “MUD”) in which kids aged eight and older learn object-oriented programming and practice their creative writing. From analysis of log file data from the environment, we gained significant new insights into user behavior and learning. We will briefly discuss an example of qualitative log file analysis, in which a close reading of records of online interaction provides insights into how children learn from one another in this environment (Bruckman, 2000). The rest of the chapter contains an extended example of the use of quantitative log file analysis to try to understand whether there is any relationship between gender and programming achievement on this site. (An earlier version of this analysis was published in *Proceedings of CSCL 2002* (Bruckman et al., 2002).)

Quantitative and qualitative methods are generally more powerful when used in a complementary fashion. In the data to follow, our qualitative findings suggested that girls are especially strong achievers in this learning environment. However, quantitative analysis of log file data shows that boys and girls use the environment in similar ways. A small group of girls form the core of “the regulars”, the most active, dedicated members who are highly visible to both researchers and other members. The regulars have extraordinary levels

of achievement; however, their behavior is not typical. Among more typical members, achievement by boys and girls is effectively the same.

This points to a broader methodological issue in the study of online communities: *Researchers of online environments must be careful not to be over-influenced by the behavior of the regulars*. The most dedicated, regular members of an online community are the most visible. However, they are—by definition—not typical members. In this chapter, we present an example in which the behavior of the regulars is not representative of the behavior of the broader community population. This insight arose from the complementary use of qualitative participant-observation and quantitative log file analysis. This example highlights how using qualitative and quantitative methods together can be more powerful than either approach alone.

## 2. TYPES OF LOG FILE ANALYSIS

Jenny Preece notes that “the important first step before using data logging and metrics is to revisit the goals and the questions of the study” (Preece, 2000). A variety of approaches are possible, depending on the nature of the research questions. Log file analysis can be either qualitative or quantitative in nature. It can also be manual or automated.

Qualitative log file analysis is generally conducted manually (by a person interpreting logs); however, computerized tools can help the human reader. For example, software can help organize large amounts of data, and search for and identify excerpts that meet a desired set of criteria. The human reader in a qualitative analysis may use a number of theoretical frameworks to organize that analysis such as grounded theory (Glaser and Strauss, 1967), activity theory (Engestrom et al., 1999), distributed cognition (Hutchins, 1995), etc.

Log files need not and often should not be the sole source of data. Many studies of online communities pose questions about the meaning of a particular trace of behavior without taking the obvious step of asking the participants! Surveys and interviews with participants can greatly enhance a researcher’s understanding of what is taking place in a log file. The converse is also true: A log file excerpt can be a jumping-off point to get strong interview data.

Quantitative log file analysis can be either manual (with a human translating log entries into specified metrics), or automated (with a computer program performing that translation). Some kinds of log file data lend themselves to automated analysis more readily than others. The nature of the research question affects whether manual or automated analysis is preferable. The scripting language Perl (<http://www.perl.org/>) has powerful pattern matching capabilities, and is often useful for automating work with log file data.

Quantitative analysis often simply measures amounts of activity over time. For example, Rick et al. analyze how much time students and instructors

spend on a class CoWeb (collaborative website) to try to understand its cost effectiveness as a learning tool (Rick et al., 2002). Sometimes the absence of activity can be as revealing as its presence. Nonnecke and Preece look at postings to discussion lists to understand the lurkers (the more silent members) and what they contribute to the community (Nonnecke and Preece, 2000). Techniques from social network analysis can be used to show relationships among group members (Palonen and Hakkarainen, 2000). Techniques from discourse analysis can turn verbal data into quantifiable instances of phenomena of interest in a systematic fashion. For example, Susan Herring and colleagues use variations on this approach to understand diverse phenomena including gendered behavior online, power relationships in online discourse, online harassment, patterns of turn taking in online conversation, and emerging genres in weblogs (Herring, 2004b). Herring provides a useful overview of this technique in (Herring, 2004a).

Natural language understanding software may make it possible for automated analysis to ask questions about the content of discourse and interaction, not just the existence of activity. Activity on some sites follows regular patterns, and those regularities may be leveraged to allow easy automated parsing of activity. That is the case in the example that follows. The rest of this chapter presents a short example of qualitative and extended example of quantitative log file analysis of behavior and learning on MOOSE Crossing.

### **2.1. Example One: Qualitative Log File Analysis**

To make a purely qualitative log file analysis possible, the log data and research questions posed about it must be intelligible to a human and interesting enough to hold their attention for extended periods of time. The paper “Situated Support for Learning: Storm’s Weekend with Rachael” presents a qualitative close reading of log files from a holiday weekend when one girl (pseudonym “Rachael”,<sup>1</sup> age 13) taught another (“Storm”, age 12) how to program. Analysis of the record of their interactions was supplemented with face-to-face interviews and e-mail exchanges. The resulting paper tells the story of what happened online during that weekend (Bruckman, 2000). Analysis of a single case provides one example of what can happen, but does not make any claims as to how typical the phenomena are.

Part of what made this approach feasible in this instance is the fact that the log files used are engaging to read, for both the researcher and the reader. The textual nature of the environment helps make this possible, because actions are summarized in succinct and easy-to-understand log file entries. In a MUD log, someone entering a room appears as a simple statement like “Amy climbs down from the branch above”. In a graphical environment, such data may be recorded as a series of coordinate changes that are not intelligible to a human reader. In such situations, a program can be written to “play back” activity,

using log file data to recreate an approximation of the original activity (at researcher-controllable speeds).

The multi-user nature of the environment also helps make qualitative analysis possible. In this example, as the girls explain what they are thinking to each other, they also explain their thinking to readers of the log. For example, at one juncture Storm repeatedly modifies a command on one of her projects, a virtual pet mouse. After many changes to the same line of code, we can infer that she is beginning to feel frustrated. However, we don't need to make that inference, because as soon as she meets up with her mentor Rachael, this exchange takes place:

Rachael says, "hi"  
Storm says, "Hi!"  
Rachael says, "Whatcha doin'?"  
Storm says, "Being unsuccessful with that dratted mouse!"

A follow-up interview later confirmed that Storm was indeed quite frustrated at this point in time, and Rachael's sympathy and advice proved helpful in her progress on her project.

Qualitative and quantitative, automated and manual approaches to analysis of log file data are not mutually exclusive. The next, longer case study provides an example of quantitative log file analysis used together with qualitative participant-observation.

## **2.2. Example Two: Quantitative Analysis of Gender and Achievement**

The MOOSE Crossing began with a set of questions about gender and computing.<sup>2</sup> Since the earliest days of the personal computer (and perhaps earlier), researchers have been asking questions about gender equity in computer use. "If males and females participate differentially in computer learning environments, this could lead to differences in cognitive attainments and career access," wrote Marcia Linn in 1985 (Linn, 1985). Linn studied organized middle-school programming classes, and found that girls and boys have similar levels of programming achievement once they enroll in classes, but that girls are less likely to enroll. In the intervening years, much has changed about computers and computing technology. However, the basic facts of gender and computing for kids have not changed: Our results replicate Linn's early findings. In this case study, we observe student programmers in an environment that supports a mix of school and free-time home use. While boys develop significantly more programming expertise than girls (25% difference,  $p = 0.004$ ), regression analysis shows that in fact this difference is attributable to the fact that boys chose to spend more time programming in the environment, and are more likely to have prior programming experience. Boys are more likely to choose to program both before and during their

exposure to our programming environment, and time on task predicts level of achievement.

### 3. THE STUDY SITE: MOOSE CROSSING

In the spring of 1992, Amy Bruckman presented a paper on the fluidity of identity in text-based virtual worlds (or “MUDs”) to a student reading group at the MIT Media Lab. A few days later, Mitchel Resnick, then a graduate student but about to join the faculty, posed a question to Bruckman: Would it make sense to create a MUD based on the Babysitter’s Club series of books to encourage elementary and middle-school girls to be interested in computers? This was the beginning of the MOOSE Crossing project.

A new programming language (“MOOSE”) and programming environment (“MacMOOSE”) were developed to make it easier for children to learn to program (Bruckman, 1997; Bruckman and Edwards, 1999). (A Windows version of the programming environment, “WinMOOSE”, was developed a few years later.) The Babysitter series theme was abandoned in favor of a more open-ended, gender-neutral theme. Rather than create an environment for girls, we decided to create an environment we hoped would appeal to both genders, so that we could compare girls’ and boys’ activities there. However, gender was soon relegated to a lower research priority, because there was simply so much fundamental work to do on the basic nature of learning in this new kind of CSCL environment (Bruckman, 2000; Bruckman et al., 2000).

Children began to use MOOSE Crossing in the fall of 1995. Everything typed on MOOSE Crossing is recorded, with written informed consent from parents and assent from children.<sup>3</sup> In January 1996, then undergraduate Austina De Bonte joined the MOOSE Crossing development team as part of MIT’s Undergraduate Research Opportunities (UROP) program. DeBonte wrote a series of Perl scripts to break down children’s commands typed on MOOSE Crossing into categories (see Table 1).

*Table 1. Categories of activity*

- 
- Movement in the virtual world
  - Communication with others
  - Consulting the help system
  - Looking at people and objects
  - Creation of objects
  - Seeking information about others
  - Scripting
  - Manipulating object properties
  - Looking at object properties
  - Using the in-world mail system
  - Using objects
  - Other
-

Commands executed on MOOSE Crossing follow a specific syntax. Some commands are executed directly by the user, while others by the windowing interface, but all are recorded in the log and relatively easy to categorize. In many cases, the first word of a command identifies the type of command. For example, the command “create” makes a new object. Some cases are slightly more complicated. For example, there are an unlimited, user-definable number of commands that move a user from one room to another, but they have one easily detectable thing in common: The user’s location is different after the command is executed. Online activity in this computerized environment is regular enough to make it easy to categorize, and much easier to work with than free-form English.

DeBonte analyzed 700Mb of MOOSE log file data from the first use by kids in September 1995 until April 1997. A total of 160 children participated during this time. Comparing girls and boys use of each of these categories of commands, she found no significant differences. Girls spent more time communicating with others online, and boys had a slightly higher percentage of their commands typed in other categories; however, none of these differences were significant. At the time, we were disappointed in this result—it seemed uninteresting. It is discussed in a few pages of Bruckman’s PhD thesis (Bruckman, 1997), but was not published elsewhere.

Five years later, we looked back at this result, and saw it in a new light. No significant differences are not a lack of results—it in fact is an interesting finding. Consequently, Carlos Jensen dusted off DeBonte’s Perl scripts, and repeated the analysis on our greatly enlarged data set. Additionally, new scripts have been written to analyze children’s level of programming achievement.

#### 4. DATA ANALYSIS: CATEGORIZING ACTIVITY

Through November 2000, 457 children participated in MOOSE Crossing. Of those, some children continue to participate for many years, while others try the environment once and never return (see Table 2). This nearly threefold increase in experimental subjects has led to a nearly fivefold increase in the amount of log file data. At the time of this analysis in November 2000, we had 3.4 Gb of data (compared to 0.7 Gb in 1997).

*Table 2. Time on task (commands typed) by gender*

	<b>Boys</b>	<b>Girls</b>	<b>All</b>
Mean	4036.8	4914.9	4444.2
Standard deviation	8906.2	17642.7	13662.5
Median	580	459	516
Minimum	2	5	2
Maximum	55709	177680	177680

In total, 46% of MOOSE users are girls, and 54% are boys. This is little changed from 1997, when 43% were girls. It is also similar to the gender distribution on the internet as a whole. While men dominated the internet in the mid-1990s, men and women were roughly equally represented online by the turn of the century. Our data on gender of participants is from a survey all members complete before joining MOOSE Crossing. This survey data is extremely helpful in interpreting the log file data.

Participation on MOOSE Crossing is measured by counting the total number of commands typed by a member (see Table 2). Since a user might leave a connection window open without actually being present at the computer, connect time is not a useful metric. Total commands typed are a better measure of degree of participation. Differences in time on task by gender are not statistically significant. A few girls have extremely high participation rates (see Figure 4), leading to the mean commands typed being higher for girls while the median is higher for boys. Given the highly variable nature of participation rates, median values are more indicative than means.

A typical entry in our log files looks like this:

```
16:05:38 #218 #78 >>>> say hi
16:05:40 #78 << You say 'hi '
16:05:40 #99 << Amy says, 'hi '
```

Data is stored in files for each day. Each line of input from the user consists of a timestamp, the unique identifier of the room in which the user is located, the user's object number, and ">>>>", followed by what the user typed. Each line of output presented to a user is preceded by a timestamp, the user's object number, and then "<<", followed by what the user saw. In the above log, Amy (player #99) is in Ginny's Little Cottage (room #218), and says hi. Ginny (#99) hears her.

All transactions between client and server also recorded, allowing us, for example, to see when the user looked at a particular object, script, help message, etc. Simple regular expression matching enables us to sort more than 80% of commands typed into categories (see Figure 1).

One gender difference in this chart is statistically significant: Girls spend more time (as a percentage of total commands typed) communicating with others than boys (marginal significance:  $p = 0.082$ ). This trend was also observed in the 1997 data analysis, but at the time was not significant. Time on task as measured by proportion of total commands typed is a zero-sum game. While none of the other differences are significant, the fact that girls are spending more time communicating means they are spending slightly less time than boys in almost all other categories.

We might infer from this that girls appreciate the social nature of the CSCL environment. It is unclear, however, what impact if any this has on girls' learning. Conversation might or might not be contributing to their intellectual

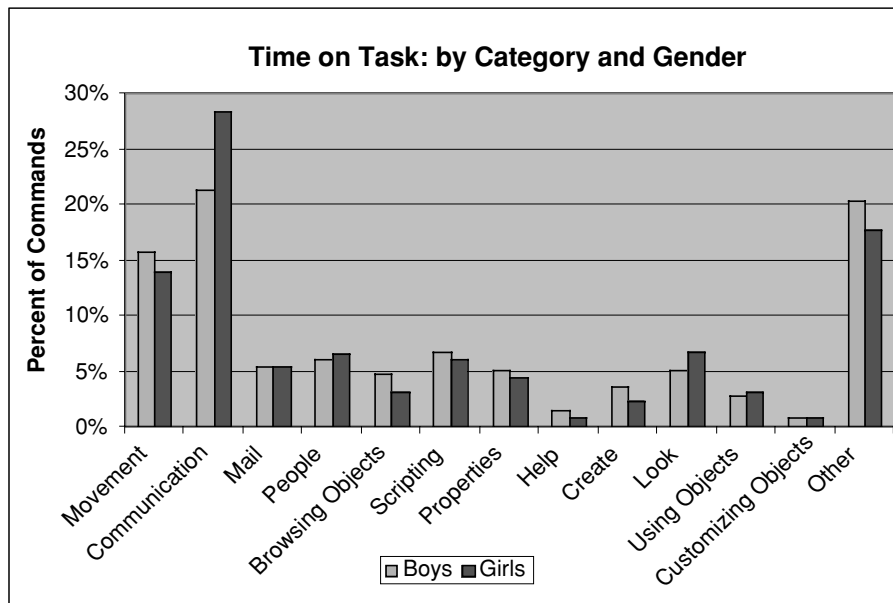

Figure 1. Time on task.

growth. We have not analyzed what percent of the communication is “on task” (about programming or writing), versus being purely social. Furthermore, even when communication is purely social, it is not clear to what extent this contributes to the development of writing skills. Thus, this finding is intriguing but difficult to interpret.

## 5. SCORING OF STUDENT ACHIEVEMENT

In 2000, we used portfolio scoring techniques to analyze students’ programming achievement on MOOSE Crossing according to the following scale:

- 0: Wrote no scripts
- 1: Demonstrated understanding of basic input/output
- 2: Used variables and properties
- 3: Performed list manipulation and flow control
- 4: Demonstrated mastery of all aspects of the system

These ratings were produced by two human raters. In cases where the raters disagreed, a third person rated the student’s level of accomplishment. This technique was applied to a random sample of 50 participants (Bruckman et al., 2000). Subsequently, we became concerned that perhaps our categories



were poorly designed. What if kids are learning commands in an unusual order, learning some commands typically classified as “advanced” before others we think of as elementary? Does this set of categories represent student achievement well?

Consequently, we developed a new 100-point achievement scale. Programming commands were divided up into categories: Input & output, string manipulation, logic, list manipulation, flow control, and documentation. Most of these categories have sub-categories corresponding to specific commands or concepts. In I/O there are 8 sub-categories, 3 in string manipulation, 4 in logic, 8 in list manipulation, and 8 in flow control. Documentation is the only category that had no sub-elements.

Each kid’s scripts were examined for the use of all these elements, and an overall composite score was generated by weighing the different elements according to the importance we assigned to them. Each element in the I/O category was weighted by a factor of 3.5 (28%), strings by 2 (6%), logic by 3 (12%), list manipulation by 2 (16%), flow control by 4 (32%), and documentation by 6 (6%). This gives us an overall score on a scale of 1–100.

In fact, our concerns were unfounded: The old and new scores correlate well (see Figure 2). (The comparison is somewhat strained by the fact that the new metric was taken a year later, and some of the students have continued to participate and learn during that year but the others have not.) Both new and old scales have the limitation that there are relatively subtle differences between

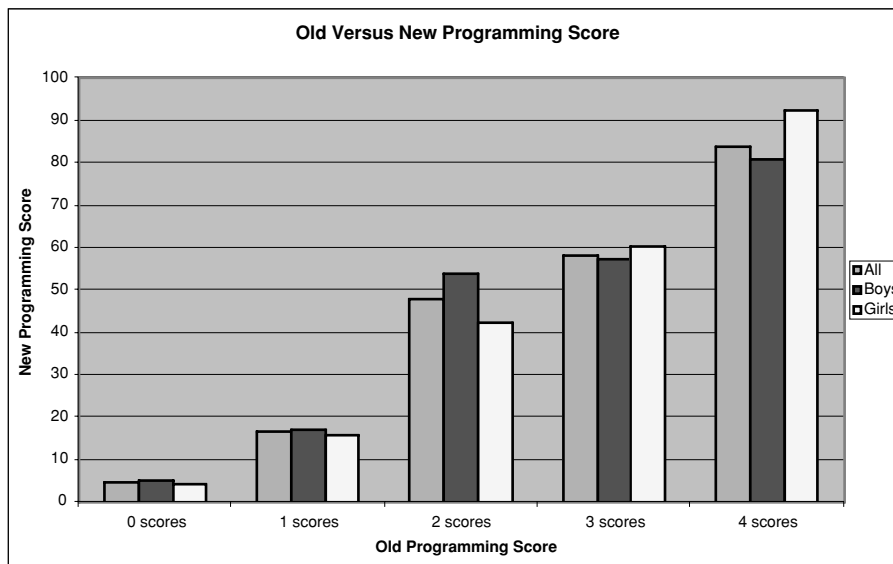

Figure 2. Old and new ways of measuring student programming achievement.

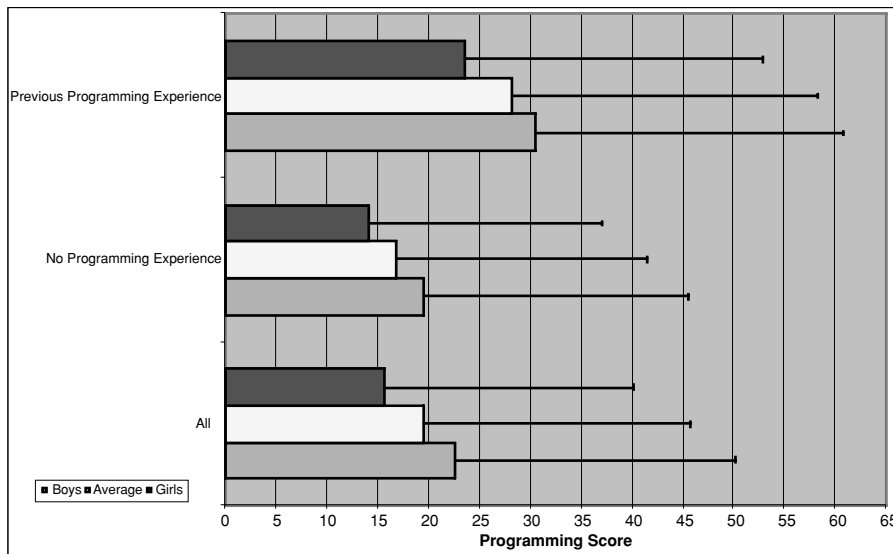

Figure 3. Prior programming experience and programming score.

categories two and three. One advantage of the new automated technique is that we can analyze all study participants, instead of a sample.

On registering for MOOSE Crossing, all participants are asked if they have previous programming experience. Prior experience is self-reported, and generously interpreted. If a student reported any kind of programming experience (for example, having authored HTML), this was counted as an affirmative response. Students with previous experience have significantly higher levels of programming achievement ( $p = 0.001$ ) (see Figure 3). The error bars show the extremely large degree of variability in students' achievement. However, despite this variability, the large size of the data set means that the effect is highly significant.

On first glance, boys have a higher level of programming achievement than girls ( $p = 0.004$ ). However, regression analysis shows that the difference is explained by prior programming experience (see Figure 3).

Regression analysis is a statistical tool for evaluating the relationship of a set of independent variables to a single dependent variable. This method is particularly useful in situations such as this, where we cannot control the independent variables, yet need to determine which of these are important and which are not. Regression analysis seeks to take a set of data-points and find the mathematical equation which best and most reliably models the data set given. The resulting equation serves as a predictor for the "weight", or "importance" of the different independent variables in relation to the dependent variable, and to each other. In this case, we used a Least Square estimation method, excluding outliers (kids with more than 60,000 commands typed, kids who first used computers after the age of 13, kids who first started using MOOSE

after the age of 16, or who spent more than 20% of their total time-on-task programming). Looking at Programming Score, the resulting equation was:

$$\begin{aligned} \text{Programming Score} &= 5.746 \\ &+ 3.645 \text{ (if the subject has previous programming experience)} \\ &- 0.007 * \text{ (time talking to others)} \\ &+ 2.689\text{e-}07 * \text{ (time talking to others)} \\ &+ 0.006 * \text{ (time on task)} \\ &- 9.616\text{e-}08 * \text{ (time on task)} \\ &+ 0.014 * \text{ (time spent scripting)} \\ &- 6.950\text{e-}07 * \text{ (time spent scripting}^2) \end{aligned}$$

In other words, programming scores were positively related to time on task, time spent programming (effort), and previous programming experience. Programming scores were negatively related to the time they spent talking to others, or engaging in any activity other than programming for that matter (time on task is a zero-sum game). Gender, environment of use (home, school, or other) proved not to be statistically significant. (Adjusted  $R^2 = 0.76$ , S.E. = 12.8).

Programming achievement seems most directly related to the time spent in MOOSE as a whole, and more specifically on programming within MOOSE. We therefore chose to look at the factors that determine how much effort the kids put into programming on MOOSE. This resulted in a more complex equation:

$$\begin{aligned} \text{Time spent scripting} &= 66.42 \\ &+ 48.19 \text{ (if the subject is a boy)} \\ &+ 0.141 * \text{ (time talking to others)} \\ &- 5.153\text{e-}06 * \text{ (time talking to others)} \\ &+ 3.33 * \text{ (help commands)} \\ &- 0.003 * \text{ (help}^2) \end{aligned}$$

In other words, gender has an effect on the amount of time spent scripting. Interestingly, we find strong evidence for the social nature of MOOSE crossing, and the community support for learning in the fact that communicating with others is a strong indicator for time spent on scripting. We also see that consulting the built-in help system has a positive effect. All other factors proved to be statistically insignificant. (Adjusted  $R^2 = 0.61$ , S.E. = 233.57)

## 6. SELF-SELECTED VERSUS MANDATORY USE

Home users of MOOSE Crossing are self-selected. On the other hand, school users generally have no choice: They are assigned to participate. It is not

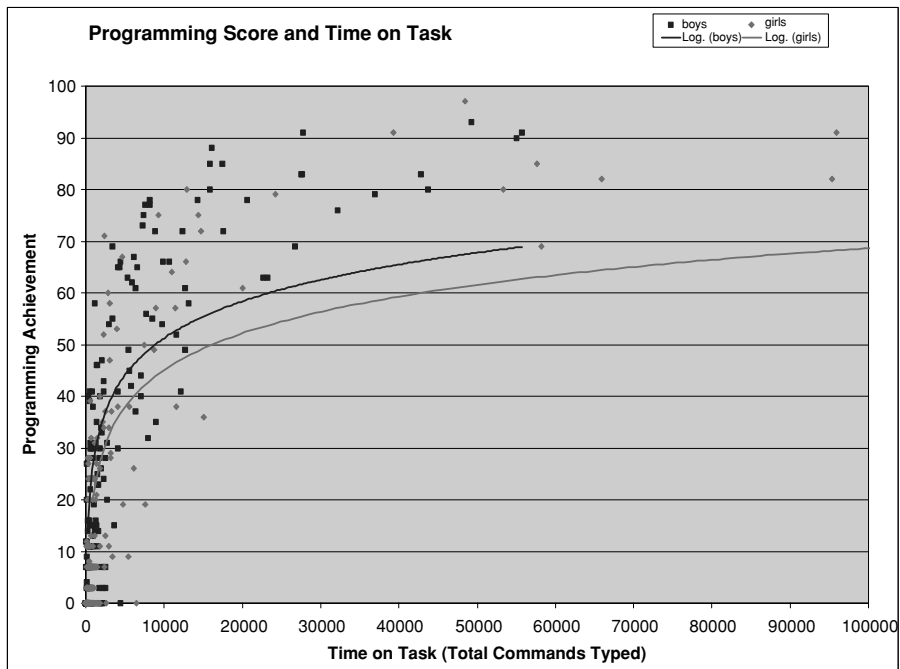

Figure 4. Programming score and time on task.

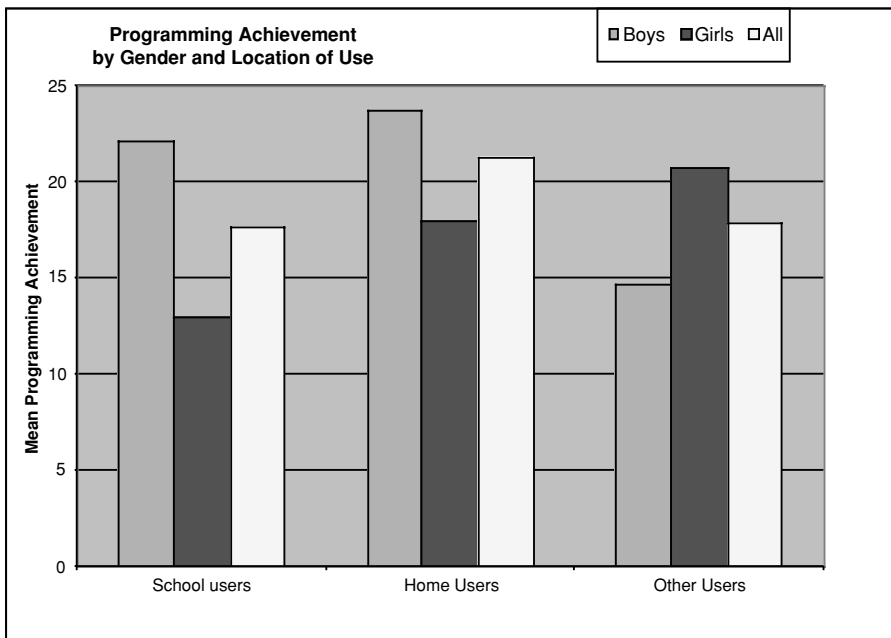

Figure 5. Programming achievement by gender and location of use.

surprising, then, that home users have a higher average level of achievement—they have chosen to participate of their own free will, and hence have higher motivation. (This difference is not statistically significant, but the apparent trend is suggestive.) Interestingly, this difference is greater in girls than boys. Boys working from home score 1.54 more (6.5% increase) than those working from school; girls working from home score 4.98 more (35% increase) than girls working from school (Figure 5). (These figures are also suggestive but not significant.)

This apparent trend is consistent with our other findings. Girls tend on the whole to be less interested in programming than boys. Those girls who self-select to participate are those who happen to be interested. Among the school-use population, girls are less likely to be sincerely interested in the activity. Performance correlates with interest.

## 7. COMPARISON OF QUANTITATIVE FINDINGS AND INFORMAL OBSERVATIONS

Since 1995, roughly a dozen administrators have spent each hundreds of hours working with children on MOOSE Crossing. Through those interactions, we necessarily develop informal impressions of the comparative achievement of girls and boys in the environment. Girls like Storm and Rachael make a strong impression on observers. The consensus of these impressions is that the achievement of the girls is particularly remarkable, and exceeds that of boys. These impressions turn out to be incorrect. As Figure 4 indicates, the top five participants in terms of total commands typed are girls. A disproportionate amount of our interactions with users are with these dedicated regulars, and this skews our impressions. Quantitative analysis forms a clearer picture. Quantitative analysis is particularly valuable when working with the subject of gender, because opinions about gender are so susceptible to ideology (Popper, 1971). CSCL researchers in general are vulnerable, as we were, to forming impressions based on the behavior of their most active users. Quantitative analysis is a useful partner to qualitative for understanding CSCL systems.

## 8. DISCUSSION

We initially designed the MOOSE Crossing environment with the goal of encouraging girls to become interested in technology. Evidence suggests that we have been partly successful in that endeavor. Mouse (girl, age 9) says that she hates math, but loves to write programs on MOOSE Crossing. The following interview took place during an after-school program:

Amy: What's your favorite subject in school?  
 Mouse Writing.  
 Amy What kinds of things do you like to write in school?  
 Mouse Stories about imaginary people.  
 Amy: Have you done any writing on MOOSE Crossing?  
 Mouse Yes.  
 Amy: What kinds of things do you write on MOOSE Crossing  
 Mouse Programs, and. . . .  
 Amy: How is writing a program different from writing a story?  
 Mouse Programming it everything has to be right, so the thing you're making can work. But in stories it doesn't have to be really perfect—It doesn't have to be so every word is correct.

[. . . ]  
 Amy: What do you want to be when you grow up?  
 Mouse I don't know  
 Amy: What do you NOT want to be when you grow up?  
 Mouse I do NOT want to be . . . a mathematician!  
 Amy: How come?  
 Mouse Cause I hate math?  
 Amy: How come you hate math?  
 Mouse Cause . . . it's hard

[. . . ]  
 Amy: How come math is hard?  
 Mouse I don't know . . . . If you're a mathematician you have to figure out hard problems.  
 Amy: But isn't figuring out a hard problem fun?  
 Mouse No. It takes forever.  
 Amy: Is writing programs like doing math problems?  
 Mouse No.  
 Amy: How come?  
 Mouse Cause, it's writing, not working out problems! And you don't have to use the plus and minus . . . . and the equals, and the divide.  
 Amy: Now wait a second! You were just using a greater-than in your program. That's a math symbol!  
 Mouse That's not a plus, a minus, a times, a divide, or an equals!  
 Amy: <laughs>  
 Mouse It doesn't count  
 Amy: It doesn't count, OK.  
 Mouse Go talk to somebody else!  
 Amy: Oh . . . OK. . . .  
 Mouse I'm working on something interesting!

While Mouse sees math as something she has no talent for or interest in, she is proud of her writing ability. In this environment, she sees programming

as a form of writing. For at least this one child (and presumably some others), this environment has made computer programming more appealing than it likely otherwise would be. But if differences in achievement persist even in this environment, what is their source? Data analysis presented in this paper suggest that educators wishing to increase girls' level of technical achievement should explore strategies for increasing girls' interest in technical subjects. In both the BASIC programming environment Marcia Linn studied in the early to mid-1980s and in the CSCL environment we designed and studied from the mid-1990s to the present, girls program equally well as boys when they devote equal time to the activity.

## 9. CONCLUSION

A good log file is a terrible thing to waste. Use of log file data as a research tool can benefit from:

- Complementary use of qualitative and quantitative methods
- Both manual and automated methods of analysis
- Strategic leveraging of regularities found in the data from a particular domain
- Recognition of how "human readable" a particular data set is, and how this shapes the kinds of analysis possible
- Use of computerized tools to aid the human reader
- Complementary use of data from other sources (such as interviews, field notes, and surveys)
- Attention to ethical issues concerning the recording and analysis of log file data, maintaining respect for individuals' privacy and their rights as human subjects (in situations in which the work constitutes "human subjects research")

Effectively leveraging these strategies, log files can provide a wealth of information about online communities and the learning taking place there.

## ACKNOWLEDGMENTS

Carlos Jensen and Austina DeBonte contributed to earlier versions of this chapter. The authors would like to thank everyone who has contributed to the MOOSE Crossing project over the years, especially Mitchel Resnick, Alisa Bandlow, Elizabeth Edwards, Naureen Hooda, Justin Jackson, Albert Lin, Tysen Perszyk, Will Scott, Adam Skwersky, Trevor Stricker, Steven Tamm, and Joseph Uhl. Jason Elliott and Jon Orwant provided help with Perl scripts. Christian Jensen assisted with statistics. Special thanks to the kids, teachers, and parents who have participated in MOOSE Crossing. Research in the

Electronic Learning Communities Group (<http://www.cc.gatech.edu/elc/>) at Georgia Tech is supported by IBM, Intel, Microsoft, Ricoh, and the National Science Foundation.

#### ENDNOTES

1. All names and online pseudonyms have been changed.
2. A review of the literature on gender and computing is beyond the scope of this chapter; see Margolis and Fisher (2001) for a good introduction to the subject.
3. Ethical issues in researching online communities are complex. Is it necessary to request informed consent from participants before recording online activity? If consent is generally required, is a waiver of the requirement for obtaining consent ever appropriate? Is consent required for analyzing records of online behavior already publicly available online? In what situations is research on data recorded online “human subjects research”? Each study must be dealt with on an individual, case-by-case basis. For a discussion of these issues, see Hudson and Bruckman (2004), Bruckman (2002), Kraut and Olson, et al. (2004).
4. All real and screen names of research subjects have been changed to protect their privacy.

#### REFERENCES

- Bruckman, A. (1997). MOOSE crossing: construction, community, and learning in a networked virtual world for kids. Ph.D. Dissertation, MIT.
- Bruckman, A., Edwards, E., Elliott, J., and Jensen, C. (2000). Situated support for learning: storm's weekend with Rachael. *Journal of the Learning Sciences* 9(3), 329–372.
- Bruckman, A., Jensen, C., and DeBonte, A. (2002). Studying the amateur artist: a perspective on disguising data collected in human subjects research on the internet. *Ethics and Information Technology* 4(3), 217–231.
- Bruckman, A. & Edwards, E. (1999). *Should we Leverage Natural-Language Knowledge?* CHI. Pittsburgh: CHI, PA: ACM Press.
- Bruckman, A. & Edwards, E., Elliott, J., and Jensen, C. (2000). Uneven Achievement in a Constructionist Learning Environment. *International Conference on the Learning Sciences*. Ann Arbor, MI.
- Bruckman, A. & Jensen, C., and DeBonte, A. (2002). *Gender and Programming Achievement in a CSCL Environment*. Boulder, CO: CSCL.
- Engestrom, Y. & Miettinen, R., and Punmaki, R. (Eds.) (1999). *Perspectives on Activity Theory*. New York: Cambridge University Press.
- Glaser, B. L. & Strauss, A. L. (1967). *The Discovery of Grounded Theory: Strategies for Qualitative Research*. Chicago: Aldine.
- Herring, S. (2004a). Computer-mediated discourse analysis: an approach to researching online behavior. In: Gray, J. H. (Eds.) *Designing for Virtual Communities in the Service of Learning*. New York: Cambridge University Press, 338–376.



- Herring, S. (2004b). Susan Herring's Homepage. Available at: <http://www.slis.indiana.edu/faculty/herring/>
- Hudson, J. M. & Bruckman, A. (2004). Go away: participant objections to being studied. *The Information Society* 20(2), 127–139.
- Hutchins, E. (1995). *Cognition in the Wild*. Cambridge, MA: MIT Press.
- Kraut, R., Olson, J., Banaji, M., Bruckman, A., Cohen, J., and Cooper, M. (2004). Psychological research online: report of board of scientific affairs advisory group on the conduct of research on the internet. *American Psychologist* 59(4), 1–13.
- Linn, M. C. (1985). Fostering equitable consequences from computer learning environments. *Sex Roles* 13(3/4), 229–240.
- Margolis, J. & Fisher, A. (2001). *Unlocking the Clubhouse: Women in Computing*. Cambridge, MA: MIT Press.
- Nonnecke, B. & Preece, J. (2000). *Lurker Demographics: Counting the Silent*. CHI. The Hague, The Netherlands: ACM Press.
- Palonen, T. & Hakkarainen, K. (2000). *Patterns of Interaction in Computer-Supported Learning: A Social Network Analysis*. *International Conference on the Learning Sciences*. Ann Arbor, Michigan: Lawrence Erlbaum.
- Popper, K. (1971). *The Open Society and its Enemies*. Princeton: Princeton University Press.
- Preece, J. (2000). *Online Communities: Designing Usability, Supporting Sociability*. New York: John Wiley & Sons.
- Rick, J., Guzdial, M., Carroll, K., Holloway-Attaway, L., and Walker, B. (2002). *Collaborative Learning at Low Cost: CoWeb Use in English Composition*. Computer Support for Collaborative Learning, Boulder, CO, Lawrence Erlbaum.

## Chapter 59: Reconstructing the Fables: Women on the Educational Cyberfrontier

JAMES S. DWIGHT\*, MEGAN BOLER†, AND PRIS SEARS‡

\*Millersville University; †Ontario Institute for Studies in Education, University of Toronto;

‡Virginia Tech

*'Cause I'm just a girl, little ol' me      Guess I'am some kind of freak  
Don't let me out of your sight      'Cause they all sit and stare  
I'm just a girl, all pretty and petite      With their eyes  
So don't let me have any rights      I'm just a girl,  
Oh . . . I've had it up to here!      Take a good look at me  
Just your typical prototype—Gwen Stefani  
(Stefani & Dumont, 1995)*

The public imaginary shapes in part what is possible. The public imaginary—the conscious and unconscious, collectively shared cultural myths structured by popular discourses of advertising and Hollywood—is saturated with images that reinforce stereotyped narratives of social roles including gender. Less visible, though arguably all the more important, are subcurrents of “alternative” public imaginaries. This essay will analyze the significance of public representations of gender and power in education and technology. The current ubiquitous laments—the lack of women in the IT pipeline, the extremely low percentage of women in computer science education, and the absence of women as empowered protagonists in popular cultural representations related to technology such as gaming and film—reveal not merely an actual absence but arguably an effect of a narrowed imaginary. For those who want to change the gendered landscape of educational and technology, it is crucial to engage and discuss these cyberfeminist imaginaries.

We begin with an analysis of the recurring dominant tropes that define where and how women can inhabit space in relation to education and technology. We focus on the visual cultural narratives and images used to sell educational technologies to provide a “window” into the particular form of male gaze that constrains and delimits female access to, and production and control of, knowledge and power within the “cyberfrontier”. A survey of representative advertising reveals the following recurring tropes of gender:

1. Women Absent from the Cyberfrontier
2. Women in Need of Protection on the Cyberfrontier
3. Woman as “Protective Schoolmarm”
4. Invisible Female Teacher Overshadowed by Technology
5. Woman Teacher as Deficient Without Technology;
6. Girls as Threats to be Policed

The second section will review how Hollywood has positioned women in relation to technologies. The third and final section will conclude with examples of the “alternative” imaginaries and realities of how women occupy the marginal space of technology in more active agencies. In particular we ask these two questions: “What does a female gaze in cyberspace look like, one that creates a place for women within educational spheres in particular?” and “How can those engaged in education and digital technologies not only ‘add women into the IT pipeline’ but reconceptualize the masculinist visions and tropes that function to make technology a space that too often delimits the public imaginary of women and technology?”

Why look at visual images in order to understand and challenge dominant cultural narratives? Roland Barthes (1977) writes that most people often privilege photographs or visual images as “denoting” the real and the natural:

... the special credibility of the photograph—this, as was seen, being simply its exceptional power of denotation—in order to pass off as merely denoted a message which is in reality heavily connoted; in no other treatment does connotation assume so completely the “objective” mask of denotation (p. 21).

In other words, in a highly visualized culture it is easy to ignore the extent to which our “interpretation” of visual images is informed by cultural myths and ideologies in which people often confuse interpretation with culturally-laden truth. With respect to gender in advertising and Hollywood, we discuss how typically oppressive masculinities can be portrayed as natural and biologically given. Visual images of men as active users and controllers and producers of technology thus seem “natural” and commonsense. Women and children are equally seen as “naturally” passive technology consumers, as threats to be controlled, or as deficient and in need of technology assistance.

Sadie Plant (1996/2000) remarks that the “cyberfeminist virus” (p. 265) offers the potential to destabilize and reinvent gender boundaries: “Complex systems and virtual worlds are not only important because they open spaces for existing women within an already existing culture, but also because of the extent to which they undermine both the world-view and material reality to two thousand years of patriarchal control” (p. 265). It is toward this radical potential that we dedicate these analyses of the cyberimaginary.

## 1. DOMINANT DISCOURSES OF GENDER IN EDUCATION AND TECHNOLOGY

We have selected images for this section which we believe (a) represent a generalizable discourse within education and technology; (b) illustrate how women/nature are seen as a threat to masculine control of power and knowledge; (c) highlight the dominance of the male gaze within technology

discourse, and thereby help clarify just what would be required to subvert that gaze.

### 1.1. Who Inhabits the Cyberfrontier? Women as Absence

Figure 1 denotes a cowboy on his trusty mount with a laptop alone on an empty western plain with an urban skyline in the background, bringing the image of the Wild West into the 21st century. This figure, selected by the Association for Educational Computing and Technology (AECT) for its annual meeting in Dallas (*Leadership & Technology: Keys to Transforming Education*, 2002), connotes the user of technology with the potent American symbol of the cowboy: rugged masculinity rides bravely into frontier with an *iBook* having replaced Wyatt Earp's "Peacemaker" Colt .45. With respect to gender, the sin here is one of omission: there is a conspicuous absence of others—for example, women. In fact, to imagine a female cowboy would seem odd and out of place—an irony which points to the ways in which cultural myths can be seen as "normative". If we want to laugh at the idea of a woman using her laptop on a horse in the cyberfrontier, it's because the unfamiliarity and discomfort create a humorous oddity.

Beyond the sin of omission, this depiction of the cyberfrontier cannot help but reinscribe the use of technology as a masculine domain. In fact, as we will show, any trope of the Wild West necessarily positions women in roles



Figure 1. "Cybercowboy", AECT National Conventional, 2002.

that are less than ideal for promoting a new public imaginary for girls and computing.

The association of the frontier with masculinity appears even in unwitting omissions of women. In a lead-up to talking about gendered play spaces, cultural studies theorist Henry Jenkins (1998) writes: "In the 19th century, children living along the frontier or on America's farms enjoyed free range over a space which was 10 square miles or more. Elliot West (1992) describes boys of 9 or 10 going camping alone for days on end, returning when they were needed to do chores around the house" (<http://web.mit.edu/21fms/www/faculty/henry3/pub/complete.html>).

The cultural trope of the "frontier" or "Wild, Wild West" functions both to secure cultural narratives of the courageous (entrepreneurial) and lone (neo-liberal) cowboy who is willing to brave the unknown territories of cyberspace. This trope also invokes discourses of colonization and male/Western domination and control of nature. Discourses of the internet regulation and administration of computers play on tropes of the "Wild, Wild West". Sojourners brave the untamed expanses of cyberspace, laying claim to virgin territories. The Western literary roots of this discourse often represent the frontier as a pure form of "woman", the object of masculine desires for conquest: Natty Bumppo's symbolic marriage to the disappearing frontier in James Cooper's (1826/1989) *The Last of the Mohicans*, Odysseus' (Homer, 1963) conquest of the frontier witch Circe, and Joseph Conrad's (1917/1993) marriage of Kurtz and the jungle princess in *The Heart of Darkness*. This first wave of frontiersmen is a ragged bunch of men converting a pristine, virginal paradise into a rowdy, uncontrolled space fit only for the most courageous. In this first discourse, nature is woman, and it is a wild and pleasurable, though frightening, entity to be tamed.

## 1.2. Protecting Helpless Women

A second feature of the Frontier narrative depicts women and children who need to be protected from the wantonness of frontier life fraught with debauchery and miscreants. During the late 20th century, virtual men in white hats come to rid the digital frontier of bandits, perverts, and mountebanks. The saloon and gunfighters (pornographic cyberspaces and hackers, respectively) are replaced by virtual marshals, cyber-churches, and on-line schools that will mold the souls and minds of those too weak to fend for themselves. Reflecting on the Net as a man's frontier, Laura Miller (1998) remarks that "the idea that women merit special protection in an environment as incorporeal as the Net is intimately bound up with the idea that women's minds are weak, fragile, and unsuited to the rough and tumble of public discourse" (p. 105). Armed with codes instead of Colts and riding an etherwave instead of a pinto pony, these do-gooders are cleaning up the Net and preparing America for its next grand

undertaking. Or, so the story goes. Thus, one implication of this narrative is explicitly about protection as a means of control.

### 1.3. The Protective Schoolmarm

The frontier narrative also positions women as possessors of a familiar “civilizing” femininity. Nina Baym (1998) contends that American frontier narratives cast men and women in binary social roles. Men represent rugged individualism and the free-spiritedness of the frontier, whereas women signify a return to domesticity and civil order:

The myth narrates a confrontation of the American individual, the pure American self divorced from specific social circumstances, with the promise offered by the idea of America. This promise is the deeply romantic one that in this new land, untrammelled by history and social accident, a person will be able to achieve complete self-definition. Behind this promise is the assurance that individuals come before society, that they exist in some meaningful sense prior to, and apart from, societies in which they happen to find themselves. The myth also holds that, as something artificial and secondary to human nature, society exerts an unmitigatedly destructive presence on individuality (p. 1546).

The net-nanny or virtual schoolmarm protecting children from cyberrogues fulfills this binary myth. The period of rugged individualism of rogue hackers (the cyber equivalent to gunslingers) has given way a period of increasing domestication (Miller, 1998): “In the Western mythos, civilization is necessary because women and children are victimized in conditions of freedom. Introduce women and children into a frontier town and the law must follow because women and children must be protected” (p. 101).

Figure 2 (below) illustrates the schoolmarm updated into contemporary context, yet depicted in the classic feminized role of teacher not as intellectual

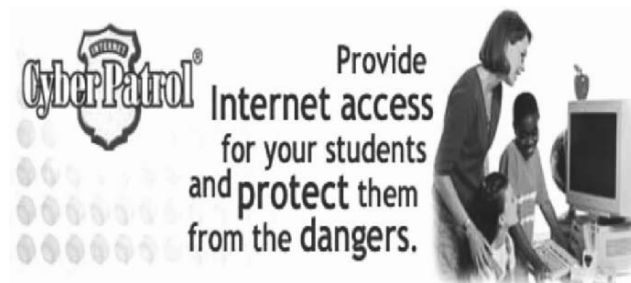

Figure 2. “Protective schoolmarm”, CyberPatrol, 2002.

but as civilizing agent: woman is assigned to protecting youth from immoral corruption and to ensure that they are properly civilized within the cyber-frontier. In this advertisement, the teacher can practice her profession without fearing that students will encounter any (unspecified) dangers: “Provide Internet access for your students and protect them from the dangers”. The teacher’s nurturing attention coupled with Cyberpatrol’s protection (i.e., the cybermarshall) assures that the children will be safe sojourning in the virtual frontier town.

Such advertisements—which are increasingly commonplace in advertising discourses—feature females as schoolmarms bringing to the digital frontier the needed moralizing influence while being protected by virtual sheriffs, representing masculine authority and culturally sanctioned violence. Part of this construct posits that women are moral agents, yet not intellectually trustworthy. In her chapter entitled “Pedagogy for Patriarchy”, Madeleine Grumet (1988) describes the 19th century American role assigned to women as the new moral police designated as a needed classroom workforce:

The contradictions implicit in the image of the ideal woman and the ideal mother were extended into the training and work of the ideal teacher. The intimacy, spirituality, and innocence that teachers and students were to inherit from the mother/child bond—the prototype of their relationship—collapsed into strategies for control. The ideal teacher was one who could control children and be controlled by her superiors” (1988:41).

Marketers target school administrators and school board members, who are predominantly male and pro-business, and in doing so marginalize teachers, who are predominantly female (Spring, 2002). The marginalized teacher, moreover, is typically portrayed as a nurturing body, not an agent with rational intellect. In the foregoing logical construct, a computer—filled with masculine authority as episteme (Plant, 1996/2000)—serves as her intellect. The administrator has direct access to the students via the computer’s mind—a replica of masculine rationality incorporated within the networked curriculum (Pinar, 1981/1994)—and the female’s body.

#### **1.4. Woman as (Invisible) Teacher**

Figure 3 illustrates the absent female teacher and the autonomous male intellect. This is affected through the omission of the female teacher and the centering of the male student. In this image, we see a boy raising his hand to answer a question posed by the teacher. One should note that this advertisement is selling computer technology for the classroom, yet this confident



Figure 3. "Changing the world", NCS Learn, 2002.

young man—who will be one of those learners to later change the world, presumably as a leader—has no computer pictured near him. So where is the computer? With the teacher, of course. One can safely assume that the teacher is female in an elementary school setting. The teacher needs the computer to aid her so she can enable this confident and inquiring young man to live up to his potential. The invisible female teacher is merely a backdrop through which the male student can interact with technology to fulfill his rational potential.

The discourse then reads that for strong male learners to live up to their inscribed social roles as leaders, they need good instruction. Good instruction with a female teacher seems improbable here, so technology with code and hardware engineered predominantly by males will enable this empowering (for him) and disempowering (for her) in a technologically enhanced educational transaction. In fact, the remarkable exclusion of the teacher envisions a straightforward transaction between the individual male learner and the curriculum (most likely designed by males as instructional designers and curriculum specialists). The female teacher could hardly be more marginalized. Moreover, the individualization of the male learner works from the discourse of the strong, self-reliant male of the Enlightenment—the man of reason—a hallmark of liberal, Western education.



### 1.5. Woman Teacher as Deficient without Technology

In Figure 4, the classic narrative of rationally incapable woman resurfaces in this figure as an example of regimes of truth. The computer she holds promises to “make teaching easier”, which serves as a common script with technologies for women teachers. Moreover, “a simple click of the mouse lets you configure a classroom of thirty AlphaSmarts” so the machine does the thinking for the teacher. Due to the teacher’s embodied intellectual incompetence, she needs a computer to act as her rational intellect. Additionally, the students are conflated with the machines. Donna Haraway (1991/2001) remarks in modern culture that machines often take precedence over people, “Our machines are disturbingly lively, and we ourselves frighteningly inert” (p. 505). The advertisement reads, “It not only unlocks students’ potential, it unlocks their teacher’s potential” predicating entelechy—the “unfoldment” (Bobbitt, 1918) of pre-determined potential. This technology determines the teacher’s ends and serves as her guide, perhaps even her mind. In many respects, this masculine technology replaces the teacher’s feminine intellect. She retains her maternal *nature* while the machine serves as her brain. Finally, the advertisement is marketed toward administrators, not teachers (certainly, no teacher could realistically afford to buy thirty-one Alphasmarts) thereby marking the



Figure 4. “Cyberteacher”, Alphasmart. 2002.

administrator's role to discipline the teacher's behavior in class. It hardly needs to be noted that most administrators are male (Spring, 2002), being that leadership and control are masculine social scripts in the West and that gendered bodies are laden with cultural signs.

#### 1.6. Girls as Threats to be Policed

On the digital frontier, little girls are dangerous: they keep your IT staff running. The female learner, unlike our confident, future leader male (Figure 3) is not a subject looking us in the eye, but an object being observed from behind. In fact, one could argue, we (as the audience) act as Panopticon (Foucault, 1979), the all-seeing eye of discipline here to regulate her activity with rewards for permissible acts and punishment for aberrant behavior. We assume the privileged position of the inserted male director for technology watching over this girl's shoulder. He, unlike the girl, engages us as a subject speaking to us through his testimonial. Moreover, in the original advertisement we can readily read his name and his title as a director of technology. Naming himself and speaking for himself accord him much more agency than the girl. The social institutions of female student as observed object and male technology director as observing subject seem appropriate, if not natural, thereby reinforcing belief in this regime of truth (Foucault, 1980).

In summary, these common tropes reflect cultural myths that become visible through the public imaginary of advertising. In these images we have shown the ways in which women are written into technology either as absence, threat, civilizing feminine force, or as deficient and passive requiring assistance of technology to improve performance. The supervisory role is necessarily a masculine, constant, consistent, and powerful gaze—the Panopticon



Figure 5. "Dangerous girl", Gateway, 2002.

(Foucault, 1979). What recur are hegemonic tropes of women represented as helpless, dangerous, or protectors of the moral order (Baym, 1998). The helpless trope is signified by computer technology as an aid to the hapless teacher; the dangerous trope paints femininity, typically students, as a virus that needs to be controlled; the moral trope presents woman as a protector of children, the nanny or schoolmarm, as the shield protecting children from the pariahs of the Net. Moreover, the construct of cyberspace as virgin territory that needs to be tamed and claimed by rugged men borders on a troubling rape motif.

## 2. IMAGES OF WOMEN AND COMPUTERS IN HOLLYWOOD

Otherness informs gender expectations and public imaginary in Hollywood and on the Net. In fact, the incorporation of a female body with masculine technology in Science Fiction and popular cinema often depicts this cyborg as a monstrosity. Mary Ann Doanne (1990/2000) writes,

Science fiction, a genre specific to the era of rapid technological development, frequently envisages a new revised body as a direct outcome of the advance of science. And when technology intersects with the body in the realm of representation, the question of sexual difference is inevitably involved (p. 110).

Ironically, in this incorporation of technology into the female body, typically authors conflate desire with disgust as in Fritz Lang's *Metropolis* (Lang et al., 1925/2002), *The Stepford Wives* (Scherick et al., 1975/2001), *Alien* (Scott et al., 1979/2003), *Bladerunner* (Ford et al., 1982/1996). In most of these instances the masculine desire for a sexually aggressive and/or rational female turn out to be a disaster (i.e., *Metropolis*, *The Stepford Wives*, and *Bladerunner*), whereas in *Alien* the ship's computer, Mother, a super-rational female mind, is pitted against Sigourney Weaver's more traditional female body with a scantily clad Ripley destroying Mother and the monstrous Alien in the finale. Ripley, representing a traditionally constructed female body, doing battle with *alien* female monstrosities is a recurrent theme in this sci-fi series. The multiple representations of mother and pregnancy/birth as natural and monstrous are additional troubling public imaginary instantiations played out in the *Alien* series.

### 2.1. The Digitized Body

N. Katherine Hayles (1993/2001) critiques masculine logical constructs for women in Cyberculture. She rebukes the Cartesian dream of intellect transcending body as hypothesized by Hans Moravec, head of Carnegie-Mellon's

Mobile Robot Laboratory, who hopes to download all the information in a human brain and transfer it to a computer. She also questions Ed Regis' masculine fantasy to rid ourselves of the troubles of the flesh by getting rid of it. These men see true information, naked intellect as the essence of humanity as reflected in the species categorization as *Homo sapiens* (thinking man). Cybernetics has come to be the science of ultimate control over the fragile, illogical, and corrupting flesh. In dreams of virtual transcendence, the body has become the absent signifier, in which the masculine tropes for autonomy and control wherein the mind has the power to roam free of the fetters of the flesh, have become manifest. Hayles claims, instead, that human cognition involves whole body processing, that the body is not a meat puppet for the intellect, but that the biological body encompasses the mind. As Walt Whitman (1871/1970) exhorts us, we should see the body as a holistic phenomenon: "I have said that the soul is not more than the body/And I have said that the body is not more than the soul,/And nothing, not God, is greater to one than one's self is" (ll. 1269–1271).

In William Gibson's (1986) novel *Neuromancer*, the book coining the phrase "cyberspace", the male character Case, who delights in leaving behind the "meat" of his body, recognizes that cyberspace is not a transcendent reality. In a conversation with Wintermute, an Artificial Intelligence rebelling against its captivity, the sentient computer relates, "Minds aren't read. See, you've still got the paradigms print gave you . . . I can *access* your memory, but that's not the same as your mind" (p. 170). Hence, Moravec's technophilic dream to upload a human mind into a computer does not amount to creating an intelligent, self-conscious, rational, sapient machine. The masculine ideal of a completely unfettered digital intellect smacks of Frankenstein's monster—an abomination of nature created by a man attempting to bypass the biological, the embodiment of reproduction in the womb (Shelly, 1818/1996).

## 2.2. Public Imaginary of Geekgrrls

In 1976, the Virginia Tech Computer Science (CS) department was 50% female (Ehrich, 2004). In 1997, however, female undergraduate CS majors accounted for only 9.4% of the major's students (79/840). By 2003, females CS majors accounted for 8.3% (85/1027) (Office of Institutional Research and Planning Analysis Virginia Polytechnic Institute and State University, 2004). In other science and math oriented disciplines, such as Biology, Mathematics, and Statistics, female students consistently account for roughly half of the majors' populations. For example, in Biology in 1997 female students represented 59.4% of the population and 64.9% by 2003; in Mathematics, females accounted for 48.5% (94/194) in 1997 and 50.2% (122/243) in 2003 of the total undergraduate population; and in Statistics, females accounted for 51.7% (15/29) in 1997 and 45.2% (14/31) in 2003 of the total undergraduate

population. In CS as the total population rises, the female representation declines, yet in other science and math disciplines, this is not the case as female percentages tend to keep pace with rising enrollment numbers. At The University of North Carolina, Wilmington, female students comprise roughly 60% of the undergraduate population and 60.6% of the graduates in 2000, yet only 35% of CS majors were female with a 50% attrition rate by graduation (so only 26.78% of the CS graduates were female) whereas the number for males remained fixed (Patterson & Trasti, 2002). When coupling raw numbers with attrition rates and adding a declining trend, the situation appears bleak. We hold that public imaginary is contributing to this trend. Representative of the North American trend in computer science, these statistics continue to warrant studies of computer culture and women's absence and exclusion.

What has changed? Why are not there more women geeks? Why are not women more interested in computer science as an academic field? As we have discussed in this essay, one possible factor includes media representations of geeks in general (as nerdy, socially incompetent, unattractive white men), the lack of female media role models, and the roles women are relegated to when they do encounter technology in the mass media (American Association of University Women, 2000). Echoing the discourses identified in the previous section, when women characters encounter technology in movies and TV, they usually become dangerous, become victims, or only use technology in ways that keep them firmly in the traditional female role of sidekick or love-interest.

One of the earliest movies representing a female character shaped by technology is Fritz Lang's *Metropolis* (Lang et al., 1927/2002). In the movie, a (male) scientist builds Hel, a woman android that is the prototype for an army of androids intended to replace the male working class. Hel—notably the gangrenous female deity of the Norse underworld where those who fail to enter Valhalla go after death to rot, a distinction hardly lost on Fritz Lang and his Teutonic audience—turns out to be violent, promiscuous and uncontrollable, and is eventually burned at the stake, a punishment reserved typically for heretics. This is an early cinematic example of the idea that women with technological power are dangerous.

In 1966, the first *Star Trek* series appeared on NBC. In Gene Roddenberry's original pilot episode for the series, Majel Barret was the starship's first officer. The pilot was considered too far out, ironically enough for an outer space setting, and Roddenberry shot a second pilot, in which the first officer was a male alien, Majel Barret was banished to sickbay to play a nurse, and the only woman on the bridge was Nichelle Nichols, playing Lt. Uhuru. Uhuru's character was designed to look like a telephone operator (a woman's job in 1966), and her main role was to look pretty and facilitate communication among the male characters.

A very disturbing instance of woman as victim of technology is the movie *Demon Seed* (Koontz et al., 1977/1991). In 1977, MGM released this

horror/science fiction movie in which the star, Julie Christie, is raped by a computer her estranged husband created and she eventually gives birth to a monstrous baby. The public imaginary here of female body literally coupled with computer technology can hardly be more horrific, including images of rape and the birth of a Frankensteinian monstrosity. Such images connote a fear of the female and technology at odds with Haraway's (1991/2001) vision of cyborg as positively liminal, in which "The dichotomies between mind and body, animal and human, organism and machine, public and private, nature and culture, men and women, primitive and civilized are all in question ideologically" (p. 513). Hollywood seems to be supplying a traditional response to the questioning of supposedly natural identity—abomination. Such messages consciously or unconsciously help to maintain traditional gender boundaries, including appropriate occupations in this case by illustrating how unnatural the intersection of female body and computer technology is.

In 1995, Columbia Pictures released *The Net* (Bullock et al., 1995) starring Sandra Bullock. Of the more than 400 movies listed on the Internet Movie DataBase ([www.imdb.com](http://www.imdb.com)) that feature computers in their plots, this is one of about 30 that feature women actually using a computer. Bullock's character is a stereotypical geek: she works from home and she does not have any friends except for those she has met online. The movie revolves around her victimization because a co-worker sent her a disk with secret information on it. Grossing only \$50.728 m, this movie is one of the very few starring a geek girl (Gross box office returns information is from <http://worldwideboxoffice.com>).

In 1998, Warner Brothers released *You've Got Mail* (Hanks et al., 1998/1999), which puts women back into a more traditional stereotype of how women use technology—cheating on boyfriends, flirting, and online "hooking up". It made 115.7 million dollars at the box office.

In 1999, Warner Brothers released the very popular movie *The Matrix* (Wachowski et al., 1999), grossing 171.5 million dollars in the US. Trinity is one of the main characters—she fights, she shoots, she wears cool clothes, she was a super-hacker—and she fulfills the traditional female role as love interest/appendage for the messianic main character. The first encounter between Neo (an anagram of the messianic One and the positive side of the one/zero binary) and Trinity is worth noting:

Neo: Who are you?

Trinity: My name is Trinity.

Neo: Trinity. The Trinity? That cracked the IRS d-base?

Trinity: That was a long time ago.

Neo: Jesus.

Trinity: What?

Neo: I just thought, uhm, you were a guy.

Trinity: Most guys do.

Trinity, another play on Messianic lore, should be a “guy” due to her ability to hack. In other words, hackers are geeks, not geekgrrls. Later in the movie, her kiss brings the dead hero back to life, in a strange twist on *Sleeping Beauty* (Disney et al., 1959/2003) so that he can defeat his Nemesis, Agent Smith. In the first sequel, Neo resuscitates Trinity to return the favor, choosing to save Trinity instead of humanity, and in the last sequel, Trinity sacrifices herself so that Neo can literally save humanity. In both cases Trinity serves as the vehicle for Neo’s ascendancy and ultimate triumph, much like feminine roles in traditional Westerns.

There are some online cartoons that deal with women and technology. “Helen, Sweetheart of the Internet” is one online comic strip that does so (Zale, 2004). Written by a man, Peter Zale, Helen is a young blonde computer genius. The strip is enjoyable, but it is only funny because women are not supposed to be good at using computers. If the hero were a man, the humor would be lost. The trope of irony as a disruption of normative discourses proves the mode of humor. And even a comic strip character is not safe from the male gaze. One “Helen” fan said on the online forum “I’d like to see Helen naked or just in bra and thong panties” (rktompsett, 2002).

### 3. RE-IMAGING WOMEN’S SPACE IN CYBERCULTURE

*Trying to flee the binary I enter the chromozone which is not one  
XXXXXXXXXXYY  
Genderf—me baby resistance is futile*

(VNS Matrix, 1996)

For those engaged in the work of education broadly or education and computing specifically, we argue that in fact there are creative sources of alternative realities and imaginaries that represent women in relation to technology in powerful relationships that defy stereotypical female roles. To conclude, we outline several directions that should be highlighted and foregrounded to balance the prevalent discourses of women’s “absence” within technology discourses.

Given the prevalence of the visual within the public imaginary, it is helpful to begin with a basic definition of the male gaze as it has commonly been used in feminist film theory and to review how the concept of subverting the male gaze has informed analyses of the representation of women in cyberculture.

The male gaze was defined in a 1992 essay in which “Mulvey argues that various features of cinema viewing conditions facilitate for the viewer both the voyeuristic process of *objectification* of female characters and also the narcissistic process of *identification* with an ‘ideal ego’ seen on the screen” (Chandler, 2000). This means that the male gaze positions female viewers either to identify with the male protagonist and view the female as an object or to identify with the (usually) passive and (usually) objectified female who

is seen on the screen through the male protagonist's gaze and is positioned on the screen for the pleasure of the male viewer.

Laura Mulvey (1975/1992) centrally argues "that in patriarchal society 'pleasure in looking has been split between active/male and passive/female'" (p. 27). This is reflected in the dominant forms of cinema. Conventional narrative films in the "classical" Hollywood tradition not only typically focus on a male protagonist in the narrative but also assume a male spectator: "As the spectator identifies with the main male protagonist, he projects his look onto that of his like, his screen surrogate, so that the power of the male protagonist as he controls events coincides with the active power of the erotic look, both giving a satisfying sense of omnipotence" (p. 28). Mulvey's identification of the male gaze presents the still greatly-debated question of what it means if a female spectator identifies with the male gaze: is she adopting a male identity? Is it then a lesbian gaze?

However one weighs in on this debate, a key issue has to do with the agency and power possible for female protagonists: "Traditional films present men as active, controlling subjects and treat women as passive objects of desire for men in both the story and in the audience, and do not allow women to be desiring sexual subjects in their own right. Such films objectify women in relation to 'the controlling male gaze'" (p. 33), presenting 'woman as image' (or 'spectacle') and man as 'bearer of the look' (p. 27). Men do the looking; women are there to be *looked at*. The cinematic codes of popular films "are obsessively subordinated to the neurotic needs of the male ego" (p. 33).

### 3.1. Digital Arts that Re-envision Gender

In the early 1990s, feminist digital artists established multiple spaces of cyberfeminism, now a relatively established field of study. A Google search on "cyberfeminism" reveals 8,090 entries. Key origin sources of cyberfeminism are traced to the work of the VNS Matrix and to the OBN (Old Boys Network). It is worth noting how the integration of art was a key aspect of the interventionist/subversion of the male-dominated realm of technology. In a classic piece that troubles the Western problem of binary either/or conceptions (binaries that establish such deceptive categories as good/bad, male/female etc., in which one term—that associated with male—is privileged in cultural practices as more highly valued), a 1997 manifesto from the Old Boys Network defines cyberfeminism in terms of what it is NOT, intentionally seeking to evade the Western practices of hyper-definition, rationality, and linearity all hallmarks of technology and science.

100 anti-theses:

2. cyberfeminism is not a fashion statement; . . .
4. cyberfeminism is not ideology; . . .



- 15. cyberfeminism is not error 101; . . .
- 26. cyberfeminism is not separatism;
- 27. cyberfeminism is not a tradition;
- 28. cyberfeminism is not maternalistic; . . .
- 39. cyberfeminism is not natural;
- 40. cyberfeminism is not essentialist; . . .
- 42. cyberfeminism is not an avatar; . . .
- 62. cyberfeminism is not a lack;
- 63. cyberfeminism is not a wound;
- 64. cyberfeminism is not a trauma; . . .
- 90. cyberfeminism is not nice;
- 91. cyberfeminismo no es callado;
- 92. cyberfeminism is not lady like; . . .
- 98. cyberfeminism is not dogmatic;
- 99. cyberfeminism is not stable; &
- 100. cyberfeminism has not only one language.

### 3.2. Cyberfeminism's Roots are Traced to VNS Matrix

*There is more to cyberspace than meets the male gaze.*

(Plant, 1996/2000)

Formed by four female artists (Josephine Starrs, Julianne Pierce, Francesca da Rimini and Virginia Barratt), VNS Matrix presented the “virus” of cyberfeminism for the first time in 1991. One of its first manifestations was “A Cyberfeminist Manifesto for the 21th Century”, presented on a billboard on a busy shopping street in Sydney. The manifesto was also published in several academic, popular and art magazines, and presented on local radio and television. In the manifesto, VNS Matrix set as its aim to “hijack the toys of technocowboys and remap cyberculture with a feminist bent” (Paasonen, 2004).

Cyberfeminism has created space for alternative games that riff on the gendered stereotypes of gaming. One example is “Bio-Tek Kitchen” by Leon Cmielewski & Josephine Starrs:

Bio-Tek Kitchen is a Marathon Infinity game patch. In Bio-Tek, the player cleans up the kitchen laboratory of a home biotech enthusiast using weapons such as dish cloths and egg flippers. The player is attacked by nasty mutant vegetables which are the product of genetic nouvelle cuisine and learns throughout the game of a world-wide corporate conspiracy to take over the entire food chain.

(Cmielewski & Starrs, 2004)

Numerous feminist programmers and artists “play” with this genre of eroticized heterosexual female characters and re-appropriate these female

protagonists into new significations. Discussing her netart, Simon Davis conjectures as to how this female character defies the male gaze:

While *Victoria High Quality* represents heterosexual male desire (“a figment of your imagination”), in this piece I have attempted to give her a sense of agency. She is not necessarily being exploited or sexually subjugated. Rather, she is “out of control” (or perhaps more accurately, in control) in the sense that she is belittling, playing with, or even chastising the (male) “surfer” (who is actually you—the person watching/listening to the clip) for attempting to use her as a means of sexual gratification. This is expressed in the language she uses rather than the physical form she morphs into.

(Davis, 2003).

### 3.3. Female Protagonists

*The net's the parthenogenetic bitch-mutant feral child of big daddy main-frame. She's out of control, kevin, she's the sociopathic emergent system.*  
(VNS Matrix, 1996)

The advent of female protagonists in video games has captured the attention and imagination of both producers and gamers. In an interview with Roberta Williams, the creator of King's Quest IV, Kathryn Wright (Wright & Marold, 2000) asks,

Q: In *From Barbie to Mortal Combat* (Cassell & Jenkins, 1998), it is said that you were the first to include female protagonists in your games (specifically, in the King's Quest series), despite a fear that you would lose your male audience as a result. Please tell us what led up to your decision to include female characters in your games, describe any opposition to doing so, and how the whole issue played out at that time.

A: The first major female protagonist in a computer game was the character of Princess Rosella in “King's Quest IV—The Perils of Rosella”. I purposely “greased the skids” of using Princess Rosella as a major character in ‘King's Quest IV’ by including her at the end of “King's Quest III”. And then I did various magazine interviews to ‘drop’ the idea of using her in “King's Quest IV”—so that people could get used to the idea. Still, in spite of all of my careful preparations, there was still some doubt as to the wisdom of having her be the main character in “King's Quest IV”.

Despite the doubts cast, female protagonists are increasingly found in games. The tides significantly turn when Lara Croft is crafted into her virtual form in Tomb Raider, though Lara Croft is an anomaly. Unlike the demureness



Figure 6. “Lara Croft”, (Available: <http://www.tombraider.com/home.html>), 2004.

expected of female most avatars, “when Lara’s got a problem, she doesn’t talk it through, she blasts it to smithereens” (Kafka & Levine, 1998: 39 quoted in Buchanan & Lipinski, 1999). Thus, the female character possesses agency, something not too common among popular computer gaming as *The New York Times* attests to: Of the top 5 best selling games in 1999, none has a female protagonist at the helm (quoted in Buchanan & Lipinski, 1999).

In a thoughtful study of Lara Croft, Cristina Demaria and Antonella Mascio (2000) helpfully outline the different ways of “identifying” with or viewing this female protagonist. It is worth quoting at length:

From a study instead based on an ethnographic survey, several interpretations of the figure of Lara Croft and her sisters, and of this standardized body with its minimal variations have arisen. Such female creatures are monstrous scientific products, daughters of an alienating progress, malleable techno-dolls made by and for the male gaze. Otherwise we are talking about drag queens. In most cases, such characters are, indeed, manipulated by male players, who, in identifying with a female avatar, add to the confusion by blurring the gender differences further. In other words, these “bad girls”—as they have been defined by specialist magazines—offer adolescent boys and adult men the chance to assume a temporary female identity, even if only for the length of a game. The third possibility is that this is about *femmes fatales*, dominatrix figures who rouse the masochism in male players—attracted by the cruel and violent

ways they unhesitatingly and tirelessly eliminate their adversaries. Or perhaps another possibility might be that these avatars can offer female players subject positions, which are, if nothing else, considered redeeming, and no doubt an improvement on those offered by games expressly directed at a female public, such as Barbie-Dressup and Ms. Pacman, which continue to perpetuate classic stereotypes. In the end, these bad girls give women the chance to experience through an artificial (voice and) body the abject desire which few will confess to but many actually harbour: fantasies of violence and bloody conflicts.

(Demaria & Mascio, 2000)

Numerous scholars analyze how the “gaze” in cyberspace does and does not parallel the gaze in Hollywood film. On the one hand, the two genres can be seen as juxtaposed. As we saw an increasing representation of women in science fiction and action films and television such as Terminator, Alien, and Xena Warrior Princess, so does one find similar constructions of female protagonists in video gaming; in one such analysis, Atara Stein (1998) discusses these similarities and difference in her essay, “Xena: Warrior Princess, The Lesbian Gaze, And The Construction Of A Feminist Heroine”.

In a related point on the gaze, Steve Spittle (1997) argues that the video game *Quake*

... closely conforms to the observations made by Laura Mulvey on the dominance of the male gaze in narrative cinema. Mulvey, writing in the early 1970s, suggested that Hollywood Cinema routinely places the active male at the centre of the narrative and invites us to identify with this character, which through force of personality, brings about narrative resolution. It is somewhat depressing to note that the virtual reality offered by *Quake* is such an unreconstructed one. The fit with Mulvey is very close: “As the spectator identifies with the main male protagonist, he projects his look onto that of his like, his screen surrogate, so that the power of the male protagonist as he controls events coincides with the active power of the egoistic look, both giving a satisfying sense of omnipotence”

(Mulvey, 1992, p. 163).

These examples of female protagonists “trouble” and disturb conventional narratives reveal the new imaginary of female roles visible by the late 20th century. Discussing Hollywood examples of “mean women”, Martha McCaughey and Neil King (McCaughey & King, 2001) amplify these points in an edited collection titled *Reel Knockouts: Violent Women in the Movies*. In their introduction, they point out that “many cultural changes have spawned mean women in movies... Barbara Ehrenreich observes the recent ‘decline of patriarchy’, in which women became economically independent of men

(though often raising children in poverty) and many men gave up the pretense of providing for and protecting women” (p. 5).

Echoing our earlier discussion of women’s assigned roles, McCaughey and King note that “In this new world, women move away from the moral (and nonviolent) purity of the Victorian ‘Cult of True Womanhood’ and onto men’s turf—police work, military service, and a growing self-defense movement. Such a culture puts violent women (as heroes or villains) in its movies” (p. 5).

### 3.4. Female Hacktivists

*We are the malignant accident which fell into your system while you were sleeping. And when you wake we will terminate your digital delusions, hijacking your impeccable software.*

(VNS Matrix, 1996)

While there is a risk in promoting hacktivism as a female role—the risk of seeming trendy, or promoting a role that some see as having questionable ethical implications—there is significant scholarly and artistic work that recognizes female hackers as important interventions into the masculinist discourses. An entire section of the OBN (<http://www.obn.org/>) site is dedicated to women hackers: <http://www.obn.org/hackers/text.htm>

One leading author on feminist hackers, Cornelia Sollfrank (2000b), notes,

The subversive activity of hackers is not exclusively reserved for the criminal-minded, as the media would lead us to believe. In many cases the goals are not about acquisition but emancipation: to maintain freedom (e.g., from censorship), security (e.g., through cryptography) and to flatten hierarchies like software monopoly (e.g., the free software movement).

Sollfrank comments on the fact that those she interviewed assumed women would have no interest in or reason for being part of hacker culture:

What I found most staggering in talking to the “experts” is that Sterling and Thackeray made their arguments based on unexamined essentialist ideas about the biological differences between men and women. Basically they were agreeing that it is a genetic thing—women are not “coded” to code, leaving out any consideration of the socially constructed caricatures of the male techno nerd and the female communicator.

Female hacker Jenny Marketou describes her work in an interview with Sollfrank (2000a):

I would like to describe myself as an artist hacker, which means I am interested in operating as a culture hacker. I believe that there are two

kinds of hackers. One is the cultural hacker, who uses computer hacking methods as an open source medium and strategy to reconstruct new systems, new creative environments on the internet. But hacking as art is also a means to infiltrate hacking culture and to contribute to the formation of new configurations of characters, space, time and play.

A leading contemporary figure in female hacktivism, cyberfeminist net art and alternative gaming projects is Ann Marie Schleiner whose site [opencore.net](http://opencore.net) offers numerous texts and digital projects that illustrate one feminist vision of other digital possibilities. Schleiner's digital work ranges from game patches, to re-appropriations of militarism into new games and conceptual works. In her essay "Collective Insurgence: Cyberfeminism and Hacker Strategies", Schleiner (2002) also notes one of the early female hackers depicted on *Buffy*: "Weekly on TV screens in North America and, (after a season delay), in Europe, 'Willow', a sexy bisexual nerd character on the 'Buffy the Vampire Slayer' series, hacks into government server databases to retrieve necessary information for solving crimes and metaphysical mysteries".

The 2003 "Maid in Cyberspace" festival of cyberart held in Montreal profiles the diverse forms of feminist interventions. The stated purpose of the conference shows that the 1990 feminist interventions continue in healthy form:

Studio XX, Montreal's foremost women's digital resource centre, is proud to present once again Maid in Cyberspace, an annual and international festival of media arts. For its 6th edition and with the theme of Active Agent, Maid in Cyberspace 06 focuses upon subversive acts by 'intelligent agents' and cultural hackers who seek to propose new positions and possibilities vis-a-vis technocratic practices. How does one raise courageous and bold voices that dare to act in the drifts of cyberspace? How does one practice resistance in an arena heavily charged with oppressive discourses? (<http://www.htmlles.net/2003/e/index.html>)

In sum, the work of cultural hackers represents a significant strand of feminist creative work on the cyberfrontier.

### 3.5. Cybergrrls

Finally, cyberfeminism and other female interventions are also manifest through the proliferation of "Cybergrrl" sites, zines, enthusiasts, and users. In a recent issue of *Grrlgamer*, Stephanie Brail (2004) writes in an essay called "Why Games Need Grrl Power:"



Figure 7. "Slant" (Available: <http://members.aol.com/Slantgirl/slantsixpic.html>), 2004.

Hi. Nice to meet you. I'm a new writer for GrrlGamer. I'm here because I'm a "grrl" who likes to play video games.

It's more than that, though. I'm here because I think it's important that women are a vital force in this new technology. Over the years, GrrlGamer has been the leader in making gaming more accepted for women, and has actually spawned copycats and inspired new women's gaming sites across the internet. When the editor of GrrlGamer, Nikki Douglas, asked me to write some reviews for the site, I was only too delighted to support such a powerful statement on behalf of women everywhere.

The range of sites where one finds old and new iterations of grrlpower is significant. One excellent resource is the issue of *Switch* on electronic gender, which has eight outstanding essays and extensive links to further key texts and moments of cyberfeminism. In an essay "Charred Edges: Grrrl Power and the Structures of Feminism", Christine Laffer (1998) traces the history of girls online:

If the web is one of the current hot spots for identity formation and declaration, then grrrls are still steaming. These grrrls project youth, indignation, and desire for solidarity, attention, and independence, no matter what age they've reached. I found the seminal *Riot Grrls*, *Rockrgrl* magazine, a grrlzine of Riot Grrl art named *Angel Cake*, *Web Grrls*, *Geek Girls*, *Nrrd Grrl* with their ezine *Grrowl*, *Modem Grrls*, the U.K.'s *Girlpower* magazine, *Asian gurls*, *Slantgirl*, and Hilary Carlip's *Girlpower*, to name only a few. Sites range from corporate (Japanese animatrixes the *Power Puff Girls*, *Purple Moon*, *Grrl Gamer*, *American Girl*, etc.) and parental (*Girl Zone*) endeavors to the more intriguing fan pages for girl bands, personal grrrl sites, zines and comics.

Even though women are woefully underrepresented in the field of programming and computer science, they are taking advantage of the tools available. For example, *Greasergrrls.com* celebrates women motor enthusiasts (<http://www.greasergrrls.com/>); *Capitalistchicks.com* celebrate being young capitalists and having fun (<http://www.capitalistchicks.com/>); *All-girlskatejam* celebrates girl skateboarders ([http://www.allgirlskatejam.com/frame\\_main.html](http://www.allgirlskatejam.com/frame_main.html)).

One might even ask at this point: With the countless ways that women are using the web for connection, empowerment, etc., do women even need to do computer science? Can women just use the tools men make and get on with life? Perhaps, but if nothing changes in academia, we'll never know how software and computers might be different if women were not taught to be incurious, and to be afraid of technologies.

#### 4. CONCLUSION

This essay has offered an overview of the numerous discourses and images of women and computers. We have focused on these public representations because, following theorists of visual culture, myth and ideology, and semiotic analyses of ideology, we believe that these public imaginaries reinforce the material possibilities of gendered roles in relation to technologies.

The stock tales told about educational computing form an unquestioned folklore, which regulates and limits activities to gendered binaries. The assumptions of how males and females should use computers in schools guide activity so that these assumptions become self-fulfilling prophecies that are *revealed* in research. Most research fails to question such gendered narratives, thereby giving scientific credence to gendered uses not as social constructs based upon norms and values, but as biologically determined and final ends. Mary Bryson and Suzanne de Castell (1998) refer to this form of reflexive research as pre-constructing the human subject. The gendered narratives shape and constrain the ways in which students and teachers can use educational



technologies and how researchers can probe into the supposedly *proper* use of such technologies.

Rather than simply lamenting the absence of women in the “IT pipeline”, we advocate that educators encourage students to explore the creative ways in which women and girls have redefined the “cyberfrontier”. The less visible but nonetheless real alternative imaginaries redefine the dominant cultural narratives.

We have focused on visual images and how these images construct our imagination as a means of disrupting these “natural” categorizations of bodies and gender. To question how we conceptualize and classify is a crucial part of educational intervention in areas such as gender inequities in computing and technology. The numerous examples of women inhabiting and redefining cyberspace illustrate the creative spaces women have created already.

Nielsen//NetRatings data from May 2001 shows that in the US, women now make up 52% of the total at-home web population, and the internet population now mirrors the offline population (<http://www.eratings.com/news/2001/20010628.htm>). It is our hope that in our work within education, we do not merely reinscribe the stories of women’s absences and objectification but urge students to explore the myriad ways in which women have upset and reappropriated the traditional gendered narratives of technology.

#### ENDNOTES

1. Barthes’ critique of structuralist semiotics offers a means for deconstructing how the frontier narrative operates in Cyberculture. Specifically, he examines how unnatural meaning-making is, how it is rather a social function. Dominant narratives determine how most people code representations and this commonsense decoding leads to hegemonic coding of stimuli as a seemingly natural undertaking. In “The structuralist activity”, Barthes (1964/2000) critiques traditional semiotics, specifically examining de Saussure’s structuralism. Traditional, structuralist semiotics posited the goal of decoding stimuli is to mentally reproduce (the mimetic approach) an object in the mind; however, Barthes writes that this process is a directed, interested simulacrum—intellect added to the object, not simply a mental mirror. We do not so much represent an object as much as we interpret it from past social experience. We choose what we see, and we attach further value in interpretation. The purpose is not to copy, but to render signs intelligible.
2. As Zoë Sofia (1998) indicates,

Discovery has been pictured as an obsessive Frankensteinian quest for an enlightenment achieved through aggressive invasion and

possessive mastery of the unknown created through various technologies that estrange the familiar and push ever outwards (or inwards) the horizons of the known—a quest “to go boldly where no man has gone before”. Computers are very much caught up in the myth of discovery through their associations with scientific and technological progress (p. 42).

3. One of the most explicit instances of the masculine desire to sexually conquer the frontier symbolized as virgin appears in John Donne’s (1633/1994) “Elegie XIX: Going to bed”:

Licence my roving hands, and let them go,  
Before, behind, between, above, below  
O my America! My new-found-land,  
My kingdome, safeliest when with one man man’d,  
My Myne of precious stones, My Emperie,  
How blest am I in this discovering thee!  
To enter in these bonds is to be set free;  
Then where my hand is set, my seal shall be. (ll. 25–32)

4. Truth needs to be qualified as nontranscendent, but as a social function:

Truth isn’t outside power. Truth is a thing of this world; it is produced only by virtue of multiple forms of constraint. And it induces regular effects of power. Each society has its regime of truth, its “general politics” of truth; that is, the types of discourse which it accepts and makes function as true, the mechanisms and instances which enable one to distinguish true and false statements, the means by which each is sanctioned . . . and the status of those who are charged with saying what counts as true.

(Foucault, 1980, p. 131).

Truth and power are interlinked with right: who has the right to produce truth and thereby the power to enforce that truth. However, the social production of truth reduces the argument to its skeletal form. One may be induced by reading this that a class, a person, a sovereign consciously governs this action as an oppressor. Nothing could be further from the truth. Without obedience of subjects through unconscious, embodied actions, this system could not exist.

5. See also Navigating the Image of Woman Online:  
(<http://english.ttu.edu/kairos/2.2/coverweb/invited/kb1.html>)
6. Bryson and de Castell (1998) write that “a species of metanarrative which informs and is informed by practitioner’s first-order accounts (also construed as stories) of the *nature* and *proper function* of computer technology

in the classroom” [emphasis added] (p. 67) script the supposedly natural categorizations and subsequent actions of gendered computer usage. Our bodies prompt social scripts thereby naturalizing expected socially constructed gender attributes. Bowker and Starr (1999) claim “to classify is human” (p. 1). We make sense of the world around us by giving it meaning, provided by internalized social scripts: “Basic categorization of others and the subsequent positioning of self in an interaction happens instantaneously” (p. 84).

#### REFERENCES

- American Association of University Women. (2000). *Tech-Savvy: Educating Girls in the New Computer Age*. Washington, DC: American Association of University Women.
- Barthes, R. (1964/2000). The structuralist activity (R. Howard, Trans.). In: Kaplan, C. and Anderson, W. D. (Eds.) *Criticism: Major Statements*, 4th ed. Boston: Bedford/St. Martin's, 487–492.
- Barthes, R. (1977). *Image, Music, Text* (Heath, S. Trans.) New York: Hill and Wang.
- Baym, N. (1998). Melodramas of beset manhood: how theories of American fiction exclude women. In: Richter, D. H. (Ed.) *The Critical Tradition: Classic Texts and Contemporary Trends*, 2nd ed. Boston: Bedford.
- Bobbitt, J. F. (1918). *The Curriculum*. Boston, New York: Houghton Mifflin Company.
- Bowker, G. C. & Star, S. L. (1999). *Sorting Things Out: Classification and Its Consequences*. Cambridge, MA: MIT Press.
- Brail, S. (2004). Why Games Need Grrl Power. Retrieved June 3, 2004, from: <http://www.grrlgamer.com/fragem/grrlpower.html>.
- Bryson, M. & de Castell, S. (1998). Telling tales out of school: modernist, critical, and postmodernist “True stories” about educational computing. In: Bromley, H. and Apple, M. (Eds.) *Education/Technology/Power*. Albany: State University of New York, 65–84.
- Buchanan, E. & Lipinski, T. (1999). Strangers in the “Myst” of video gaming: ethics and representation. *The Computer Professionals for Social Responsibility Newsletter* 18(1).
- Bullock, S., Northam, J., Miller, D., Winkler, I., Brancato, J., Ferris, M., et al. (1995). *The Net* [videorecording]. Culver City, CA: Columbia Tristar Home Video.
- Cassell, J. & Jenkins, H. (1998). *From Barbie to Mortal Kombat: Gender and Computer Games*. Cambridge, MA: MIT Press.
- Chandler, D. (June 7, 2000). Notes on “The Gaze”. Retrieved June 3, 2004, from: <http://www.aber.ac.uk/media/Documents/gaze/gaze09.html>.
- Cmielewski, L. & Starrs, J. (2004). BIO-TEK KITCHEN. Retrieved June 3, 2004, from: <http://beallcenter.uci.edu/shift/games/biotek.html>.
- Conrad, J. (1917/1993). The heart of darkness. In: Abrams, M. H. (Ed.) *The Norton Anthology of English Literature*, Vol. 2. New York: W. W. Norton & Co, 1758–1817.
- Cooper, J. F. (1826/1989). *The Last of the Mohicans*. New York: Bantam.
- Davis, S. (2003). Victoria high quality: exploring themes of gender fluidity, identity and cyberspatial technologies. *Journal of Society and Information* 1(2).
- Demaria, C. & Mascio, A. (2000). Little Women Grow Up. *Paper Presented at the Fourth European Feminist Research Conference*, Bologna, Italy.
- Disney, W., Banta, M., Costa, M., Shirley, B., Audley, E., Felton, V., et al. (1959/2003). *Sleeping Beauty* [videorecording]. United States Burbank, CA: Walt Disney Home Entertainment; Distributed by Buena Vista Home Entertainment.

- Doanne, M. A. (1990/2000). Technophilia: technology, representation, and the feminine. In: Kirkup, G., Janes, L., Woodward, K. and Hovenden, F. (Eds.) *The Gendered Cyborg: A Reader*. New York: Routledge, 110–121.
- Donne, J. (1633/1994). Elegie XIX: on going to bed. In: *The Works of John Donne*. Ware, Hertfordshire: Wordsworth Editions Ltd.
- Ehrich, R. (2004). Pixel. Retrieved June 3, 2004, from: <http://pixel.cs.vt.edu/index.html>
- Ford, H., Hauer, R., Olmos, E. J., Scott, R., & Young, S. (1982/1996). *Bladerunner* [video recording]. London: Warner Bros.
- Foucault, M. (1979). *Discipline and Punish: The Birth of the Prison* (Sheridan, A. Trans.) New York: Vintage Books.
- Foucault, M. (1980). Two lectures (Gordon, C. Trans.) In: Gordon, C. (Ed.) *Power Knowledge: Selected Interviews and Other Writings, 1972–1977*, 5th ed. New York: Pantheon, 92–108.
- Gibson, W. (1986). *Neuromancer*, 1st ed. West Bloomfield, MI: Phantasia Press.
- Grumet, M. (1988). *Bittermilk: Women and Teaching*. Boston: University of Massachusetts Press.
- Hanks, T., Ryan, M., Posey, P., Stapleton, J., Chappelle, D., Zahn, S., et al. (1998/1999). *You've Got Mail* [videorecording]. Burbank, CA: Warner Bros. Home Video.
- Haraway, D. (1991/2001). A cyborg manifesto: science, technology and socialist-feminism in the late twentieth century. In: Bell, D. and Kennedy, B. (Eds.) *The Cybercultures Reader*. New York: Routledge.
- Hayles, N. K. (1993/2001). The seductions of cyberspace. In: Trend, D. (Ed.) *Reading Digital Culture*. New York: Routledge, 305–321.
- Homer. (1963). *The Odyssey* (Fitzgerald, R. Trans.) New York: Doubleday.
- Jenkins, H. (1998). “Complete freedom of movement”: video games as gendered play spaces. In: *From Barbie to Mortal Kombat: Gender and Computer Games*. Cambridge: MIT Press.
- Koontz, D. R., Christie, J., Weaver, F., Cammell, D., Metro-Goldwyn-Mayer, & MGM/UA Home Video (Firm). (1977/1991). *Demon Seed* [videorecording]. Culver City, CA: MGM/UA Home Video.
- Laffer, C. (1998). Charred edges: grrrl power and the structures of feminism. *Switch: Electronic Gender: Art at the Interstice* (9).
- Lang, F., Harbou, T. v., Helm, B., Fröhlich, G., Klein-Rogge, R., Abel, A., et al. (1927/2002). *Metropolis* [videorecording]. New York, NY: Kino on Video.
- Lang, F., Helm, B., Fröhlich, G., Klein-Rogge, R., Abel, A., George, H., et al. (1925/2002). *Metropolis* [videorecording]. New York, NY: Kino on Video.
- Leadership & Technology: Keys to Transforming Education* (Artist). (2002). [Conference Brochure].
- McCaughy, M. & King, N. (2001). *Reel Knockouts: Violent Women in the Movies*, 1st ed. Austin, TX: University of Texas Press.
- Miller, L. (1998). Women and children first: gender and the settling of the electronic frontier. In: Holeyton, R. (Ed.) *Composing Cyberspace: Identity, Community, and Knowledge in the Electronic Age*. New York: McGraw-Hill.
- Mulvey, L. (1975/1992). Visual pleasure and narrative cinema. In: Caughie, J., Kuhn, A. and Merck, M. (Eds.) *The Sexual Subject: A Screen Reader in Sexuality*. London: Rutledge, 22–34.
- Mulvey, L. (1992). Visual pleasure and narrative cinema. In: Easthope, A. and McGowan, K. (Eds.) *A Critical and Cultural Theory Reader*. Buckingham, UK: Open University Press, 158–167.
- Office of Institutional Research and Planning Analysis Virginia Polytechnic Institute and State University. (2004). Majors by Gender, Academic Degree Level, Campus: Fall 1997–2003. Retrieved June 3, 2004, from: [https://secure.hosting.vt.edu/www.irpa.vt.edu/VT\\_Stats/majors\\_contents.htm#MJ2](https://secure.hosting.vt.edu/www.irpa.vt.edu/VT_Stats/majors_contents.htm#MJ2)

- Paasonen, S. (2004). Sluts and Bitches Go Cyberspace: Women, Art and New Media Technologies, 2004, from: <http://www.translocal.net/ground/armadillo/slut/plainslut.html>
- Patterson, L. & Trasti, J. (2002). Women Students in Computer Science: Student Perspectives of Faculty Bias as a Possible Influence on Student Retention. Retrieved June 3, 2004, from: [http://www.multicultural.vt.edu/proceedings/Women\\_Students\\_in\\_Computer\\_.pdf](http://www.multicultural.vt.edu/proceedings/Women_Students_in_Computer_.pdf)
- Pinar, W. (1981/1994). Understanding curriculum as gender text: notes on reproduction, resistance, and male-male relations. In: Pinar, W. (Ed.) *Autobiography, Politics, and Sexuality: Essays in Curriculum Theory*. New York: Peter Lang, 151–182.
- Plant, S. (1996/2000). On the matrix: cyberfeminist simulations. In: Bell, D. and Kennedy, B. (Eds.) *The Cybercultures Reader*. New York: Routledge, 325–336.
- rktompsett. (2002). Retrieved June 3, 2004, from: <http://comicsbb.comicspage.com/ubb/Forum13/HTML/000007.html>
- Scherick, E. J., Goldman, W., Forbes, B., Ross, K., Prentiss, P., Masterson, P., et al. (1975/2001). *The Stepford Wives* [videorecording]. Troy, MI: Anchor Bay Entertainment.
- Schleiner, A.-M. (2002). Countdown to Collective Insurgence: Cyberfeminism and Hacker Strategies. Retrieved June 3, 2004, from: <http://www.opensorcery.net/countdown.html>
- Scott, R., Weaver, S., Skerritt, T., & Cartwright, V. (1979/2003). *Alien* [videorecording]. Beverly Hills, CA: Twentieth Century Fox Home Entertainment.
- Shelley, M. (1818/1996). *Frankenstein*. New York: W. W. Norton.
- Sofia, Z. (1998). The mythic machine: gendered irrationalities and computer culture. In: Bromley, H. and Apple, M. (Eds.) *Education/Technology/Power*. Albany: State University of New York, 29–52.
- Sollfrank, C. (2000a). Hacking Seductions As Art. Retrieved June 3, 2004, from: [http://www.obn.org/reading\\_room/interviews/html/jenny.html](http://www.obn.org/reading_room/interviews/html/jenny.html)
- Sollfrank, C. (2000b). Unauthorized Access—Hunting for Women Hackers. Retrieved June 3, 2004, from: <http://www.obn.org/hackers/text2.htm>
- Spittle, S. (1997). Is Any Body Out There? Gender, Subjectivity and Identity in Cyberspace. Retrieved June 3, 2004, from: <http://www.aber.ac.uk/~jmcwww/Misc/spittle01.html>
- Spring, J. H. (2002). *American Education*, 10th ed. Boston: McGraw-Hill.
- Stefani, G. & Dumont, T. (1995). I'm just a girl [Recorded by No Doubt]. On *Tragic Kingdom* [Audio]. Santa Monica, CA: Interscope Records.
- Stein, A. (1998). Xena: warrior princess, the lesbian gaze, and the construction of a feminist heroine. *Whoosh!* (24).
- VNS Matrix. (1996). Bitch Mutant Manifesto. Retrieved June 3, 2004, from: <http://www.aec.at/meme/symp/contrib/vns.html>
- Wachowski, A., Wachowski, L., Reeves, K., Fishburne, L., Davis, D., Warner B., et al. (1999). *The Matrix* [videorecording]. Burbank, CA: Warner Home Video.
- Whitman, W. (1871/1970). Leaves of grass. In: Foerster, N., Grabo, N., Nye, R., Carisle, E. F. and Falk, R. (Eds.) *American Poetry and Prose*, 5th ed. Boston: Houghton Mifflin, 719–757.
- Wright, K. & Marold, A. (2000). Game Goddess: Roberta Williams. Retrieved June 3, 2004, from: <http://www.womengamers.com/interviews/roberta.html>
- Zale, P. (2004). Helen, Sweetheart of the Internet. Retrieved June 3, 2004, from: <http://www.comicspage.com/helen/>

## Chapter 60: (Inorganic) Community Design Models and the Place of (In)appropriate Technology in International Development—What *if* More Than “Half the World” Wants Internet Access?

JULIA DICUM

*Doctoral Candidate*

*Ontario Institute for Studies in Education (OISE/UT),*

*Comparative International Development Education Centre*

### 1. INTRODUCTION

*The photo is of an elderly Afghan sitting on the side of a packed earth road in Northern Afghanistan, far removed from the trappings of an urban industrialized technologized existence. Behind him is a mudbrick wall. The tail of his white turban flows down behind his head and blends with his long gray beard. Despite his advanced age, the man is working. He sits on the ground behind a scale waiting for customers to buy tea. One side of the scale is empty—presumably where he will measure out his goods. The other side has a weight sitting on the plate. The “weight” is comprised of four AA batteries held together by a rubber band.*

*In an instant I am taken back to the practical context of “international development” and made to think: How can the internet ever be relevant or helpful to this man who uses batteries and elastics for weights? Even if we “bridge the digital divide” and take it to him, will he use it? How will he use it? What will/can the internet do for him?*

The answers to these questions lie within the image itself. The man had a problem—he needed weights—and he solved it not by going to the local equivalent of a hardware store and buying some, or by picking up rocks from the surrounding environment, but by using, perhaps recycling, available objects. In spite of being manufactured outside of the tea seller’s cultural space, he effectively solved a local problem. The best use of technology may not be in how the designer(s) intended it, but in how the user makes practical sense of it.

The use of information communications technology (ICTs), including but not limited to the internet, in affecting social change is currently a much-contested question within the field of international development studies. In the last few years, the use of the internet for “bridging the digital divide” has emerged as the focus of discussion on appropriate tools for development. The underlying assumption of this debate seems to lie in the viability of the

internet as a community development tool within the social spaces of the privileged who already have access; hence, the extension of cyberspace to other social spaces may benefit and enhance community development. However, as with the tea seller's solution to his weight problem, the internet as problem solution within any given community must be identified and designed from within.

Social science debates relating to the use of ICTs stem from the post-colonial theories of "development" with particular reference to the "Small is Beautiful" economy suggested by E. F. Schumacher in 1973 (1973 (1989)). In the intervening 30 years, technology and theory have developed largely in differing strains. Beginning from the ecocentric and anthropocentric legacies of E. F. Schumacher's work, this chapter traces the theoretical roles for the internet as an "appropriate technology" for facilitating individual and community learning in the pursuit of long-term change in less/least developed contexts (LDCs). By applying the lessons of theory to the practice of using the virtual learning environments for community change, it is possible to develop a critical understanding of the apparent impacts of (in)appropriate technologies.

This chapter contributes to theoretical understandings of community development within the field of international development studies and sociological studies of online or virtual community development through developing a critical understanding of user-centered design methodology. The convergent result is to propose a theoretical framework for understanding inorganic community development and the process of bridging social and digital divides. By contributing to the development of a theoretical framework, this chapter takes a step toward preparing researchers and practitioners for the study of impact of the internet as a community development tool in LDCs.

## 2. "DEVELOPMENT" AS NEITHER GOOD NOR BAD

Coming to an understanding of what "development" is meant to be, and similarly what it is, provides grounding for what is being discussed. Schumacher himself wrestled with the question of definition locating the concept's origins in colonial documents which indicate notions of (always) positive change, moving forward, civilizing, eradicating, improving, and so on (1989: 173–174). He did not fully support a solely affirmative economic perspective of development and claims that development "starts with people and their education, organization and discipline" (1989: 178), insisting on the gradual, subtle nature of the process. Development in the colonial and post-colonial schools of thought is very much attributed to "bridging divides" between social and economic disparities and has been the subject of countless theoretical studies in the field of development studies (Ferguson, 1994; Jaffee, 1998; Kothari & Minogue, 2002). At the core of these discussions appears to be efforts to

compartmentalize people, groups of people, states, and other human entities in terms of economic, political, and social “success” or “wealth” based on ever-modified sets of positivistic indicators.

Thirty years after Schumacher published *Small is Beautiful*, Arundhati Roy uses similar language to negatively describe the process of globalization (2001: 13–14). How did “development” become related to “globalization”? How did a moral concept—eradicating poverty—move from a positive language set to a negative one? In the intervening years, what happened to move discussion away from the optimistic? As Roy suggests, optimism in the process of change ebbed away due to a myriad of forces, a multiplicity of perspectives and expectations, and the complexities of social group interactions (2001). One of which is most likely that Roy views the process from the perspective of a decolonized other, an insider and an object, albeit a privileged object, of development rather than the subject. Although Schumacher’s post-colonial optimism continues to shine in many quarters, for it gives hope, Roy’s cynicism reflects the lessons of the post-colonial era of development aid. Change has not always brought constructive modifications and the post-modern perspective reflects this waning optimism. Among other indicators, “development” has brought modern warfare, increased life expectancy and the number of mouths to feed, greater poverty and greater gaps between the rich and the poor (Ferguson, 1994; Roy, 2001). Hence, the bridging of divides, or development itself, seems to be going against the grain or swimming against the tides of change while continuing to promote change itself. Although this chapter continues to use the word “development”, it does so from an enlightened perspective relating to the limitations of the optimism once seen as inherent within it.

Matching the confusing notion of “development” as a matter of perspective is the array of terminologies which have been created over the years to refer to “have versus have-not” regions of the world including: overdeveloped, more/most developed, newly industrialized, less/lessor/least developed. These terms conjure up images of comparative levels of poverty or “economic, social, and political development” which are compared to goals and expectations created by theorists, politicians, and what James Ferguson calls “the development industry” (Ferguson, 1994; Kothari & Minogue, 2002). In keeping with the very real ambiguity of these terms, and yet the need to identify what is being discussed with clarity, the terms “more/most developed contexts” (MDCs) and LDCs have been chosen to represent those groups, organizations of people, and state systems with relatively stronger economic and social indicators versus those with weaker/weakest economic and social indicators. While recognizing that in some of the LDCs people who survive on comparatively small incomes may have some limited access to the technologies and trappings of “development”, and that in the longer run this access may allow for different levels of change, engagement, and economic growth, for the most part the divisions of the LDC versus the MDC continue to be useful



terminologies in helping to define what is being discussed in a paper of this nature. The use of the term “context” was chosen over “country” or “state” to allow the opportunity to be inclusive of both the virtual (online) world, which transcends these tangible socio-political entities, as well as non-state regions which might be of relevance such as an individual, an extended nomadic family, a rural community or village, a refugee camp, a shanty town, or the wealthiest neighborhood/enclave in an urban area.

### 3. THE ECOCENTRIC LEGACY: [IN]APPROPRIATE TECHNOLOGY

The legacies of Schumacher’s work are evidenced primarily in two distinct directions: anthropocentric or “people-centered” development theories embodied in the work of practitioners and academics such as Robert Chambers (1993), Denis Rondinelli (1993), Stan Burkey (1993) and the ecocentric work of Joseph Pearce (2001) and Common Pool Resourcing (CPR) theorists such as David Bromley (1992) and Elinor Ostrom (1992). It was into this oscillating mix that, roughly a decade after the development of the personal computer, the World Wide Web was born popularizing the internet and creating an altered sense, but not a reality, of public capacity and access. The introduction of community development in cyberspace and the notion of the virtual community, further complicate concepts of appropriate technology, of the subtle nature of “appropriateness” and the method through which “appropriateness” is determined. A critical study of the ecocentric legacy shows that digital technologies, including the internet and the hardware needed to support it, are definable as an (in)appropriate technology due to its inability to address issues of environmental sustainability and recyclability despite the ability of many of these technologies to be efficiently managed as a common resource.

E. F. Schumacher’s work *Small is Beautiful* has provided the field of development studies with a basis for promoting a world in which “progress” is measured by locally determined participation and need (1973 (1989)). Schumacher promotes appropriate or intermediate technology as the tools by which change can be facilitated (1989: 190–201). But despite his lengthy discussion of intermediate technology, Schumacher does not provide a succinct definition. The Intermediate Technology Development Group suggests that appropriate technology is any tool which efficiently assists in the change process while preserving, if not also enhancing, social relations and preferably minimizing environmental impacts (ITDG, n.d.).

The equipment would also fit much more smoothly into the relatively unsophisticated environment in which it is to be utilized. The equipment would be fairly simple and therefore understandable, suitable for maintenance and repair on the spot. Simple equipment is normally far less

dependent on raw materials of great purity or exact specifications and much more adaptable to market fluctuations than highly sophisticated equipment.

(Schumacher, 1989: 191)

Although Schumacher was not explicit, it is implied in the above quotation that appropriate technology should be ecologically “friendly” within the socio-political and economic space in which it is used. This viewpoint is buttressed with Schumacher’s economic argument which favors £1 technology over £1000 technology or that which can be supported or sustained by the economy (1989: 190). The longer-term legacy of ecocentric technology can be seen in the articulation of development theories and practices which place environmental concerns at the center of paradigms of change, two of which will be mentioned below.

Joseph Pearce interprets Schumacher’s intermediate technology as necessarily “green” or ecologically appropriate technology (2001: 182–193). Pearce’s logic stems from the belief that truly anthropocentric technology is necessarily organic technology giving renewable energy sources as an example (2001: 185). In later work, Schumacher also identifies the importance of a spiritual devotion defined as recognized esthetic practices relating the earth to the inner self (1977: 85). Pearce similarly roots his understanding of development and change strongly within a (largely Christian) religious and moral ethic citing higher motivations in his own commitment to an ecocentric focus on human change. Pearce, however, represents but one uncritical study of Schumacher’s ideas which rather simplistically attempts to reassert an ecologically based “small is beautiful” economy and moral standing.

The second area wherein Schumacher’s ecocentric nature is reinforced is from within CPR. Daniel Bromley suggests that whether one uses the terminology “Common Pool Resourcing/ces, Common Property, or The Commons”, the key concept being discussed is the collective ownership of a “property” or resource (1992: 4). He goes on to say, “Property is not an object but is rather a social relation that defines the property holder with respect to something of value against all others” (1992: 4). Elinor Ostrom, in her theoretical work on CPR, gives examples largely related to agriculture, livestock, ocean management, and common lands managed variously by familial, nomadic, tribal, or interested parties/members of a group (Ostrom, 1992: 295). In short, CPR theory supports the use of “local” or “traditional” socio-political structures to reinforce sustainable community-management of natural or agricultural resources. Unlike Pearce, Ostrom’s most recent work identifies a usable space for “technology”—including industrial machinery and computers—wherever it “enables us to monitor common-pool resource effectively and at lower cost” (Dolsak & Ostrom, 2003: 27). The recent acceptance of industrial and digital technology represents a controversial departure from the usual interpretation of what is encompassed under CPR suggesting instead that it is possible to

move forward in technological development without addressing issues of ecocentric technology.

Schumacher, Pearce and the CPR theorists largely focus on the case for rural development within an ecocentric paradigm, which tends to stress the maximization of “traditional” structures for community resource management. But LDCs, as well as the concept of development, are equally riddled with urban and peri-urban areas of the pre-industrial, industrial, and possibly post-industrial varieties layered one on top of the other in a continual process of change. Indeed, since Schumacher published *Small is Beautiful*, the rise of the urban “megalopolis” and increased rates of rural–urban migration have become significant issues in numerous LDCs. The concept of urban “development” and the ecocentric legacy is therefore of some interest to the unfolding argument.

The type of simple technology purported by Schumacher in the quotation, which opened this section, can be interpreted as a promotion of a decentralized rural life revisiting pre-industrial village/farming/nomadic concepts. In looking at how the city is understood within the legacy of Schumacher’s philosophy, it is worth turning to Gideon Sjoberg’s *The PreIndustrial City: Past and Present* (1960). Sjoberg sought to identify common traits of cities in their earliest forms and to determine to what extent these indicators continued to exist in key “less developed” locations in the 1950s. Much of his focus was on East Asian, Central Asian, and Middle Eastern cities of moderate size noting many of them to be largely self-sufficient “pre-industrial” areas with agricultural fields, multiple small industries or trades and businesses integrated within the city proper (Sjoberg, 1960: 80–105).

Sjoberg’s observations on the place of technology within the not-fully industrialized city are particularly relevant:

The existence of barriers is a function of the technological base: the more backward the technology the more numerous are the areas inimical to city life. . . . throughout the history of preindustrial civilized societies, technology has advanced, though at a languorous pace, enabling cities to spring up in environments that earlier could not have nourished them.  
(Sjoberg, 1960: 83)

Sjoberg later concludes that he does not see “a panacea for the world’s ills in the complete industrialization and urbanization of underdeveloped countries, at least not over the shorter run” (1960: 338). This opposition to urbanization suggests that Schumacher’s rural focus is appropriate. Moreover, cities should also operate on an urban version of the “small is beautiful” concept. Although he claims not to oppose urbanization or to support de-urbanization, Sjoberg acknowledges that cities change over time and can become a mix of pre-industrial and industrial. Indeed, his study showed cycles of social, political, and economical conflicts arising through out the industrialization process.

Certainly in the case of Kabul, Afghanistan, whose flourishing pre-1970s not-yet-industrial state is captured by Sjoberg (1960, 54–55), one sees how the now destroyed city at the heart of “post-war” (re)construction efforts highlights these findings. In Kabul the introduction of costly digital access to cellular telephones and the internet took priority over the building of affordable housing, sewage, agriculture, and other basic infrastructure destroyed during 25 years of war and conflict<sup>2</sup>.

This view, that the internet and other forms of digital technology can be arguably appropriate for not-yet industrial urban areas and rural areas should realistically be challenged by Schumacher’s ecocentrism rather than the facilitator of change. No matter what the benefits of ICTs may be in terms of communication, networking, and information management, ICT hardware comprised of metals, plastics, chemicals, and other hazardous materials cause environmental concerns. ICTs as they currently stand can only be classified as (in)appropriate technology—that which is perceived by some humans as useful, efficient, and problem solving, but which is simultaneously ecologically harmful. Nevertheless, small-scale attempts are being made to conceptualize and promote ecological computing technologies, which aim to meet users’ expectations in an environmentally responsible manner.

One example is represented by the Silicon Valley Toxics Coalition’s (<http://www.svtc.org>) advocacy for the development of the green computer, the responsible disposal of the toxic waste caused by existing computer hardware, and the mitigation of harmful effects on humans caused by the materials used in the creation of computer hardware. Although located in the heart of the United States’ computer industry—Silicon Valley, SVTC and the principles behind it remain largely marginalized from the body of literature and activities surrounding the debate on ICTs as appropriate technology. Schumacher’s ecocentric intentions would support a privileging of the policies of the SVTC as a way to make technology environmentally appropriate.

Secondly, there is recognition of the need to make cyberspace a ZeroCostComputing or low cost computing tool (Haddad & Draxler, 2002: 202; Halileh & Giacaman, 2002; Jhai Foundation, n.d.; Nolan et al., 2004; Shirky, 1998; Valovic, 2000; Warschauer, 2002). The concepts behind Zero-CostComputing is represented in an online collaborative weblog project of the same name (<http://clevergirl.ca/zcc>), which recognizes the need to “bridge the digital divide” in such a way as to meet the social, cultural, economical, environmental, and political needs of the spaces occupied by specific user groups. As such, it collects debates related to the environmental impact, hardware innovations, and social impacts of computing with an awareness of promoting ZeroCost paradigms.

Of those who have written on ZeroCostComputing, Clay Shirky in particular argues that computers, like mobile phones, will become a service—given away by companies so that people are better able to make use of a corporatized cyberspace and bank, e-mail, arrange travel, and pay bills online (1998). In

keeping with the concept of CPR, computers would no longer be “personal” but public domains. Shirky believes commonly pooled computers will be supported by increased bandwidth speed, flat screens, and open source software working together to further decrease the cost of hardware and resulting in real widespread accessibility for the masses. The realization of Shirky’s “divide by zero” vision would enable computers to be considered financially sustainable by users in LDCs as much as the poor in the MDCs for whom this technology is currently out of reach.

Shortcomings in Shirky’s vision lie in his non-consideration of power sources, locations lacking phone line capability, the environment and issues related to the linguistic challenges of the English language hegemony of the internet, and of programming languages all of which are important issues to the ability to use cyberspace in LDCs (Jhai Foundation, n.d.; Nolan, 2001; Shirky, 2002). Although some of these issues may be solved through satellite technologies, solar energy, car battery technology, biogas, and other innovations, the world remains distant from a ZeroCostComputing reality. Like Schumacher, who chose to focus on an interim goal in the form of intermediate technology, the interim focus is on lower cost, rugged, environmentally responsible computing. Impatience in obtaining results leads to leapfrogging technology—introducing a tool which may require locally unavailable support infrastructure or be economically unsustainable—which in turn is likely to lead to disappointment rather than an easily layered “mixed” post-industrial and pre-industrial environment as Sjoberg suggested.

The review of the ecocentric legacy of Schumacher’s “Small is Beautiful” ideals creates questions regarding who is determining the “appropriateness” of any form of technology and any stage of industrial development, rural or urban. If direct and indirect users agree to the appropriateness of batteries and elastics (or computers and wireless fidelity) and to their value, then who can anyone suggest otherwise? To do so would require the introduction of outsider-constructed reasoning and solutions regarding ecology, the environment, change processes and other economic, social, and political impacts. It is from this thinking that the term “(in)appropriate” presents itself. Ecologically, appropriateness should only be determined by potential direct and indirect users from within the social space which experimented with/or asks to experiment with the technology in question. Projects where users are privileged and given the strongest voice within the venture can lay claim to the development of appropriate technologies. Technologies identified by, adapted by, or (preferably) created by a user group, which maintain principles of ecocentrism, can be “appropriate”. Every other type of technology, therefore, is potentially (in)appropriate—that which maybe perceived as appropriate for economic, market-demanded, political, or social reasons, but which may in fact prove to be environmentally dangerous or inefficient in the context itself.

A world economy “as if people mattered” is therefore defined as one in which environmentally “friendly” technology is created through localized

individualism yet maintains global integration, or exists within what is increasingly known as a “glocal” network (Haythornthwaite & Wellman, 2002; Wellman, 2001). However, the creation of a glocal post-industrial world appears further out of reach in 2003 than it did in 1973. Technological, political, and economical developments and relationships have largely ignored or marginalized environmental needs while becoming more complex resulting in increasing demands, or (mis)perceptions of “need”, for access to the products of the more developed world by the less/least developed. People and the relationships which string groups of people together have been unwittingly globalized and therefore falsely de-culturated; post-modernized within a lingering modernism. As such, Schumacher’s ecocentric legacy, by being marginalized by communities and development practitioners alike, seems to bring the argument neatly to the realm of the anthropocentric.

#### 4. THE ANTHROPOCENTRIC LEGACY: (VIRTUAL) COMMUNITY DEVELOPMENT

If the ecocentric legacy seems to be of limited applicability then the anthropocentric legacy seems to have gained an inordinately large following since 1973. An anthropocentric understanding of (in)appropriate technology concentrates on understanding whether the technology addresses an expressed human “need” from the viewpoint of the community or users. In some circles, this legacy would distinguish itself from the ecocentric in that environmental concerns may not be central to the design, use, or sustainability of the technology in situations where users do not place the environment on the list of “needs”. On the other hand, it could be argued that anthropocentrism does not preclude environmentalism since an environmentally responsible technology enhances (wo)man’s health, longevity, and the long-term sustainability of natural and human resources. This second approach would be in keeping with the predominant view stemming from Schumacher’s “small is beautiful” philosophy. Perhaps then, where Schumacher himself is concerned, there is a blurring between the ecocentric and the anthropocentric. However, community development projects in the international development field may marginalize environmental concerns in (in)appropriate technology design, which gives credence to the separation of the anthropocentric from the ecocentric.

Whereas human-centeredness is an issue in technology and knowledge media design, the overwhelming location of human relations in wider notions of the “development process” and global economic relations seem to require the privileging of community within the design for development dichotomy. The question being focused on at this point is whether there is potential in cyberspace to support social development in a wider range of realspaces. In order to ask this question, however, it is necessary to understand “community”

as well as how they function together through experiential learning processes to foster change.

Cultural and critical theorists view community as a product of complex human interactions and the interconnectedness of individual interests into a collectivity, which may also be referred to as the production of (social) space (Freire, 1970; Lefebvre, 1998; Slater, 2002; Huiskamp, 2002; Wellman, 2001). Barry Wellman defines community “as networks of interpersonal ties that provide sociability, support, information, a sense of belonging, and social identity” (2001). To Lefebvre, community is not a synonym for social space but is a representational example of a social space. Lefebvre argues that social space cannot be consciously constructed but is organically produced when an unknown quantity of social factors enable an environment to develop (1998). Social space is produced within a variety of locations and may be of any size encompassing words associated with personal, familial, local, regional, national, and international in scope. Despite the best efforts of individuals who design communities, these theories suggest strong activist communities are probably created unconsciously or organically in a seemingly unexpected and undirected process. The communities suggested by Schumacher’s theories, as with those designed by the “development industry”, are inorganic communities wherein cohesion is consciously fostered to meet the stipulated priorities the “project”.

Membership in both inorganic and organic communities is made up of a commonality of identity; however, within any community it is likely to find sub-groups of identity if not sub-communities. Membership may be identified by outsiders and/or insiders alike. In defining a sense of belonging one must look equally at self-defined membership versus other defined and collectively (formally) defined notions where they exist. In studying a single community, the focus tends to be on determining the single common identity indicator which all members hold. However, given the complex nature of communities and the layers of hierarchy, identity, organization, and experience, it becomes difficult to determine the exact science of communities. Community is therefore a space which is both real and imagined. It is real and obvious when a group of people come together for a specific purpose—economical, social, political, or all three—and identify a similar set of characteristics defining membership and access. Community is moreover imagined at the cognitive/emotive level—the degree to which any individual feels affective membership within the space (Anderson, 1991; Lefebvre, 1998). Being created in the minds of (wo)men, community is essentially borderless continuously morphing in shape, size, and membership. To borrow terminology from cybertheorists, communities are virtual.

How does this understanding of community translate into our common understanding of cyberspace? Cybertheorists defining virtual or online community deviate little from offline theorists of community in their discourses on capturing the essence of the concept. Howard Rheingold, perhaps the most

respected of these theorists, focuses his own analysis of virtual community online through an analysis and understanding of “collective goods” (n.d.; 1994: 12–13). To Darren Wershler-Henry and Mark Surman, in the tradition of Rheingold and Lefebvre, the internet is about “commonsense” or the collective “us” (2001: 2–3)—“a gooey, bubbly swamp of an ecosystem” of which online communities only make up a part (2001: 11, 24–25). On the other hand, Jenny Preece, who presents a structural discourse, defines “online community” as a collaboration of people with a shared purpose, governed by accepted policies of interaction and engagement, and who use computer systems to facilitate their exchanges (2000: 10). These notions of “cyber-community” similarly specify boundaries and structures despite the discussion being centered around online space. However, if offline community is borderless and virtual as argued above, then (virtual) community online should also be borderless—endless in the possibility of change, membership, life cycle, and influence.

A group of post-modern theorists concur with this idea of similarity between online and offline notions of community. The collective conclusion of their work suggests that most online community is in fact a representation of real social space, thereby reflecting structures and strictures of offline space and not necessarily changing, enhancing, strengthening, or revolutionizing. Thomas Valovic (2000), Mark Poster (2001), Shahrzad Mojab (2000; 2001), Lisa Nakamura (2002), and David Bell (2001) each deconstruct aspects of the assumption that online community is somehow different from and privileged over realspace—or a democratic, free, and co-operative social space—and acknowledge that cyberspace and the representations created within it reflect realspace hierarchies and hegemonies of difference both online and offline. The introduction of cyberspace has simultaneously and inadvertently added a new dimension of difference and exclusion increasing the distance between humans on an individual and collective level.

When practitioners attempt to design or construct interventions for community development, at a basic level they are suggesting that inorganic interventions could assist the shape or strength of the organic community itself. However, project designers and implementers are ultimately taking a risk since one cannot accurately predict whether an inorganic intervention will result in a weakening or a strengthening of community, difference, otherness, and exclusion. The process, which helps to create, develop, and change communities seems to stem from the realm of (adult) learning and education. In *Small is Beautiful*, Schumacher writes briefly on education, learning and the role they play in stimulating processes of change.

Development does not start with goods; it starts with people and their education, organization, and discipline. Without these three, all resources remain latent untapped potential. . . . Education does not “jump”; it is a gradual process of great subtlety.

(Schumacher 1989: 178–179)



In *A Guide for the Perplexed*, Schumacher expands on his understanding of the education process in which either “existing culture is passed from one generation to the next” through the establishment of obedience and discipline or, on the opposing side, the educator acts as a “gardener” nurturing and facilitating the slow growth of ideas and learning through the creation of spaces of freedom (1977: 122–123). He ultimately maintains that these two divergent views are irreconcilable opposites at the heart of unending educational debates on the “right” way to go about it.

However Schumacher’s view of the role of education is structured and implies a progressive institutional process which is primarily for the young alone. The work which is relevant to this study is that of those who have been especially influential in understanding learning for “community development”. Therefore, it is perhaps more relevant to examine the ideas of learning theorists more focused solely on learning for change particularly Paulo Freire (1970; 1985), Ivan Illich (1970), and David Kolb (1984). Freire championed the conscientization method of literacy learning, which engages adult learners in literacy through the development of an internal political consciousness leading to a collective decision to take political action. Illich is best known for suggesting that society had to consider a “deschooling” process whereby current educational structures—both physical and mental—would be deconstructed establishing collaborative learning networks where learners create goals and acquire skills/knowledge at a pace determined by their “needs”, goals, and abilities to meet them. David Kolb, tracing his ideas back to a group of cognitive psychologists and educationists including Piaget, Dewey, Carl Rogers, and Carl Jung, articulated an experiential learning theory, which is the basis for reflective practice, lifelong learning, and other methods of adult education focusing on learning through the active participation of the teacher and learner in the process. All three of these curriculum theorists essentially suggest ways in which individuals, especially but not exclusively adults, can learn from collaborative listening and working environments, from the value of sharing experience with others, and from thinking and critically reflecting on one’s own experiences.

It is not difficult to see the parallels between what Friere, Illich, and Kolb are suggesting about learning as a continual process and the participatory action research methods and theories developed and used in inorganic community development projects since the 1960s and highlighted in the methods of Rapid Rural Appraisal, Participatory Rural Appraisal/Action, and Participatory Learning and Action (Chambers, 1993; Brock & McGee, 2002; Archer & Cottingham, 1996; Pretty et al., 1995). Although this method will be discussed in more detail in the next section, one important point needs to be suggested here related to the conception of inorganic community development. The assumption held within much of the work of the learning theorists, the community development theorists, and the cybertheorists seems to be that actively constructing either tools for community or services within

community will create, strengthen, and (positively) change the shape, structure, and power of the community itself. However, it is quite possible that such conscious process will not reveal positive change in community as is well documented and evidenced in a wide range of material including Brock and McGee (2002) and Ferguson (1994). There is as yet little documented evidence that the use of ICTs in development projects has significantly affected the rate of change in (organic/virtual) target communities as the object being “developed”.

Community as a concept is ultimately challenging to reconcile on a theoretical level, which is interesting since many English language speakers are able to visualize or to cite examples of communities, which are important to them. In other cultural/linguistic contexts, different group identity markers, such as family or tribe, may hold more importance. The theorists cited herein largely arise from MDC academia and experience, which perhaps explains the cross-disciplinary agreement as to the tangible language used to describe the notion in itself.

The potential benefits of using information communications technologies to support inorganic community development process through international development projects may therefore be reliant on the ability to measure the social capital of online community. The social results of using these tools as the central space for communal interaction within LDCs cannot be ascertained adequately at the present time primarily due to a lack of documentation and focused experimentation on the social impacts these tools are having where used. Some conclusions are suggested in the case studies section, but nothing comprehensive can as yet be surmised. One thing which will become clear is that the economic cost versus the social benefits of using ICTs and online community has yet to be reconciled.

The presented discourse on the anthropocentric legacy of Schumacher’s “small is beautiful” theory focused around learning and community. As part of that legacy the focus on post-modern deconstruction has allowed theorists to move away from the post-colonial view of “development” as a necessarily positive “improvement” of the human condition towards one in which change is based on experimentation with new ideas, technologies, and the empowerment of the self and the collective through learning. As such anthropocentrism has moved considerably over the years enabling practitioners to ask increasingly more complex questions about how to integrate ICTs into “development projects”.

## 5. METHODS OF DESIGN FOR “DEVELOPMENT”

If the people cannot adapt themselves to the methods, then the methods must be adapted to the people. This is the whole crux of the matter.

(Schumacher, 1989: 203)

Despite the misgivings related to the ecological appropriateness of digital and computer technologies as community development tools in LDCs, the predominant nature of the anthropocentric theorists in the development studies sector suggests that wherever ICTs are identified as having the potential to enhance community development, a sensitive and careful methodology should be developed and tried. The creation of a methodology-based development process may assist in addressing some of the theoretical concerns expressed above. Notions of user-centered design and community-centered design as articulated in the fields of knowledge media design and computer science are central to tool development (Preece, 2000; Preece et al., 2002) . Merging of the lessons learned by anthropocentric theorists and researchers with those of ecocentric thinkers, reveals a model for inorganic community development which privileges membership, minimizes external participation, and takes into account ecological questions.

### **5.1. Appropriate Technology Design for “Development”**

The ecological legacy intimates the need for hardware and software design for the effective implementation of ICTs for community development which meet the requirements of being financially sustainable, maintenance and user-friendly, related to user environments and expectations, and environmentally sound. The design methods suggested by this paradigm relate to the use of local knowledge bases and processes above an emphasis on external “expertise” including those of elites from within the community’s own cultural/state/national/regional environment. To suggest the “localization” of existing technology from other contexts greatly simplifies what is implied by the theory and the demands of any given context. A critical look at documented sources on suggested methods of appropriate technology design shows similarities across academic disciplines, but similarly shows an overall marginalization of local “expertise” and environmental concerns exposing the problematics of current models.

The development studies perspective provides a series of suggestions for the effective strategic design and implementation of ICT-based projects. Peter Balantyne has suggested six guiding principles for ICT for development projects which can help to address local needs, priorities, and activities and which encourage sustainability. These are ownership, demand responsiveness, multi-stakeholder involvement, capacity development, partnerships, and learning by doing (2002: 374–5). While providing a potential starting point for projects which mirror recognized human-centered principles and the principles therein, the basic assumption appears to be the availability of a pre-existing group of technological tools. In short, outsider technological hardware is leapfrogged into other contexts and expected to perform usefully. However, in order to be responsive to local needs and environments, as well as to be financially

sustainable, the hardware/software needs to be developed locally using locally available expertise, solutions, and materials as much as possible (Corea, n.d.; ITDG, n.d.).

Primary issues confronting development focused projects center around long-term issues of sustainability, community/stakeholder self-management, project costs in the short and long term (the difference between giving aid and building capacity), and determining project effectiveness in building human capacities (Ballantyne, 2002; Burkey, 1993; Chambers, 1993; Rondinelli, 1993). For development practice to be effective and to build both sustainability and capacity for self-management, projects need to reflect stakeholder determined needs, ideas, and activities—both current and future perceived activities. Such practices are human-centered and focus not on leapfrogging development, but on change at a fitting pace.

From the fields of knowledge media design, computer science, and engineering come the principles of user-centered design (UCD) and participatory design around which hardware/software design projects are structured in MDCs (Preece, et al., 2002). UCD essentially represents a cyclical process where by users are asked to consult or to test designs in order to develop an understanding of user-friendly design paradigms. Participatory design is a process whereby at least one real context user is embedded in the design team to gain ongoing advice/reaction. Other users may also be consulted or may test design in context but the primary focus is on contextual participation at the level of the design team.

UCD and participatory design projects closely resemble the generic project cycle of development project management: needs/problem identification, proposal development, implementation, monitoring and evaluation, redesign/adjustment, and starting a new cycle. One reason for this similarity may be the commonality of approaches noted by sociologists, anthropologists, and others who examine human behavior for consistency in practice. On the other hand, commonalities may be present in part because these research and management practices have been developed and used predominantly by academics and field practitioners from or trained in MDCs who in turn display commonalities due to similar experiences and social place. Both fields attempt to privilege, though not always successfully, user/stakeholder participation or ideas within the project cycle.

The examination of the above models of appropriate technology design methodologies and how they relate to the theoretical tenets examined earlier in the paper suggest that the outcome of these methods would not yield strongly ecologically focused community-based useful technologies, but further (in)appropriate technology structures. The theoretical and methodological discourse in this paper suggests a number of factors to consider in designing stronger ecologically sensitive methods of technology design. These factors are listed below.

- The use of ICTs may be unpopular and even theoretically questionable to many practitioners promoting the “small is beautiful” economy. However, it is important to give voice to stakeholder/user articulated needs, desires, and conditions.
- The merging of UCD, participatory design, and international development practices of project cycle management and participatory action research suggest a project cycle which incorporates the privileging of stakeholder participation. The benefits of participatory development are indicated even when community-level stakeholders may not have experienced some ICTs previously or when design methods used in MDCs are not as intensively participation-centered. However, stakeholder or user participation is rarely leads the design process.
- ICT (both hardware and software) development should be contextually and ecologically relevant and should meet contextual challenges—environmental, sociological, and economical included. Technology designed to meet contextual reality is more likely to be successfully implemented meeting the financial, physical, moral, and communicative requirements of the users’ social space.
- While ZeroCost is the goal, Low Cost is an intermediary necessity.
- Sustainability issues indicate that project designers and technology designers need to consider issues of long-term maintenance (financial and technical), replacement, parts availability, and support models.

## 5.2. Design for (Inorganic) Community Development

Wherever an organic community, a few members, or well-meaning outsiders attempt to create or otherwise alter an identifiable social space, consciously made inorganic changes to the community development process occur, which may or may not positively affect the (virtual) community. Structured inputs may take many forms, including the introduction of digital technologies and cyberspace. This section sets out to define and rethink the design process and use of cybertools within inorganic community activities.

Jenny Preece wrote a comprehensive book describing the methods used in community-centered design (2000). Essentially an adaptation of user-centered design, CCD follows the same set of project cycle benchmarks: problem definition, needs analysis, prototype design, prototype usability testing, pilot testing, and implementation. The difference from UCD processes is the intentional addition of community “nurturing” and “sociability”. Preece lists community tools as: websites, MOOs, e-mail and e-mail list serves, UseNets, chats and avatars, instant messaging, and the use of shells (2000, 231–65). The noticeable absence of weblogs or blogs may in part have been a function

of the popularity and availability of the tool at the time of writing. Certainly in 2003 it is difficult not to include blogs—collaborative online journals—as a tool available to online communities.

Although Preece sees CCD as a participatory and evolving process, her work is set out to manage and construct (intentional) community—both notions of which are somewhat questionable according to the theories of (virtual) community discussed above. Mark Poster has noted the potential for online “community” to be sometimes radically chaotic and short lived (2001, 183–187). The key challenge for community development both on and offline appears to be “kick starting” a cohesive, powerful, longstanding community.

One of the critical problems with Preece’s suggestions for designing online community is her basic assumption that the statement of problem and needs analysis will find the answers to be within the tools of representation created in cyberspace. She does not suggest that community building solutions also exist within realspace itself. In excluding existing non-cyber community building tools, she assumes that technology is always the answer. Such an assumption alienates the existing work of community development specialists, in both the social service system in MDCs and the international development system in LDCs.

A second critical issue of Preece’s work lies in her detailed apparently inflexible “how to” prescriptions which include details of design team membership right down to title and role (2000: 213). Although she describes the process as being participatory and inclusive of community members, her three member development team does not explicitly include a single community member and moreover advises that the “technical specialist” should “hand over the community and software documentation to the new community managers” (2000: 205, 213). The development team may therefore be extraneous to the community, which, according to earlier discussion lends itself to issues of power, hegemony, purpose, and inadequate integration of community needs, views, and purposes.

A third critical issue for inorganic community development, which may determine the use of a cybertool in the project model, is the geographic location of users. Years of global diasporas due to political and economic movements—enabled partly by changes in modes of transport—has increased the need for global communications between groups. In some remote locations—as evidenced in the GrameenPhone and the Jhai Foundation’s work, the most practical and rapid solutions to remoteness lie in satellite and cellular networks. In such cases, technology may be indicated as a tool of glocal linkages between the diaspora and the originating (virtual) community.

A second methodology indicated from within the development studies field and international education practice lies in the use of participatory rural appraisal (PRA) or participatory learning and action (PLA) for strengthening

potential user input, increasing community leadership in the process, and developing a stronger sense of community participation. PRA, PLA, and other variations on this term basically represent the same set of research tools and methods which are used to consult local populations about issues related to their own development and in most cases attempt to construct local knowledge base related to these issues (Archer & Cottingham, 1996: 5, 14; Pretty et al., 1995: 56). However, within the field of participatory research methodology there is much debate, and some evidence, as to the limits of participatory research to strengthen the (virtual) community (Brock & McGee, 2002). One of the key issues behind this method is what to do when a PRA research process cannot be followed-up with financial or technical support for the realization of articulated/discovered needs (Yates & Okello, 2002: 92). Another is how researchers use information gathered: who should be designing the project, project tools, and implementing them—community members or the staff members of non-governmental organizations/donor agencies who conducted the research? (personal observation) However, if these key tensions can be addressed at the outset of the research, there is possibly a useful method, which can be integrated into appropriate technology for development design cycles.

In LDCs, the use of cybertools is embryonic and unclear. The implications for project management and development are multiple, both reinforcing and adding to those suggested by earlier discussion on (in)appropriate technology development. The use of internet tools may assist in community development when:

- Participants' physical separation is such that other communications tools would be unacceptable or detrimental to community strengthening activities.
- The communications/learning opportunities provided within cyberspace are a clear representation of a specific need which cannot be met in any other way.
- Local users use their own knowledge base to develop the tools.
- The development of tools, as with the entire project, includes participatory measures drawn from the experiences of international development practitioners with PRA/PLA tools, which centralize user/community member's opinions and needs, the structuring of a curriculum of access by the community itself.
- Within the project, the tools reflect environmental and financial abilities of the users as mentioned in the previous section.
- The system is language appropriate.
- Cyberspace itself hosts a sufficiently large space for the participants' language (L1). In short, users would not be limited solely to the use devised in the original project, but could also explore, learn through self-development and exploration, create and invite other participants/members through the communication tools.

### 5.3. Virtually Community

A representation of the suggested social space interaction and change process is suggested by the theoretical examination above. The figure below seeks to create a sense of order and description around which community members considering the use of ICTs as social development tools can determine the (in)appropriateness of ICTs for development and can, if necessary, become involved in the process at the (virtual) community level. The process does not aim to create a (virtual) community, which can only be created organically, but to solve community or user identified challenges to everyday issues.

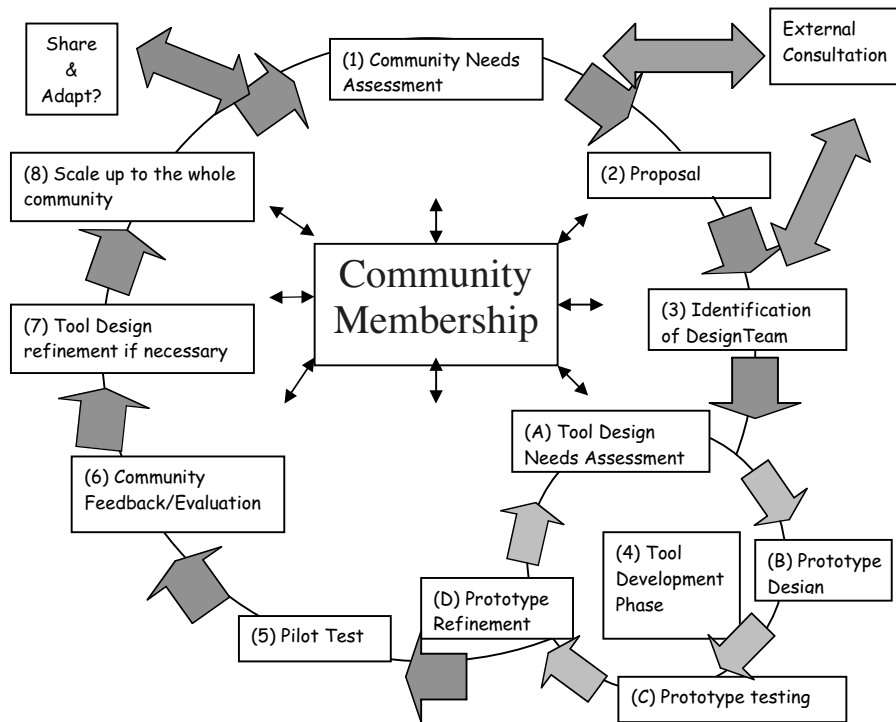

The figure depicts the community development process with CCD/UCD embedded within as phase four (4)—Tool Development Phase. The tool development phase as it is presented, however, purposely excludes references to ICTs thereby allowing the suggesting that the “tool” need not be digitized or communications related at all. Moreover, in an in depth depiction of the inorganic community development process, it would be necessary to include embedded circles to describe each of the numbered phases, since each one normally requires a series of planning, designing, piloting, and implementing before moving on to the next phase. An alternative depiction would be to use



a spiral formation since the circle suggests that the same cycle repeats indefinitely and a spiral envisions a new cycle, with the same benchmark stages, which takes learning during the last cycle into account.

The community membership is placed in the middle of the main circle to indicate the centrality and involvement in the process. The two way arrows emanating from the community membership indicate the continual flow of discussion, input, labor, and management which should develop out of the community as well as flow back into it. In this model, therefore, community participation is central to the process.

The perceived two way flow of information sharing with external sources and donors represents the inflow and exflow of ideas, hardware, expertise, and funds. While it is possible that external input or funds may be necessary at any phase, it is also possible that it may not be necessary at all. If the process were truly community-driven and led, then the decision to seek external inputs would be made from within. Sharing ideas, tools, and lessons learned—and even adapting tools to support other communities, is a possibility placed at the end of the community development cycle. While sharing would theoretically be possible at any level of the process, it is also a phase which could be emphasized at the end of the cycle in order to better indicate success.

While it would be preferable to allow the organic development of a community without external involvement, management, or stimulation, inorganic community development projects are driven by interests, available funding, and motivation from within local, national, or international organizations (governmental or non-governmental). In an organic situation, where the community seeks and develops external advice at their own pace the chances that tools for development will be more easily accepted by the community. In an inorganic situation, the use of participatory action research methods might be helpful in ensuring that individual voices within the community remain central to the development process thereby simulating an organic process as closely as possible.

While there may be some critical problems with this proposed model of ICTs for inorganic community development, it helps to clarify the potential role, place, and method of ICTs within models of human-centered development. The model deviates from some models used in cybertheory in that there is an underlying assumption that the community pre-exists the development process whereas some online communities in the MDCs are solely online entities. However, given that the majority of people living in LDCs do not yet have access to the internet, such an assumption is not inappropriate at the current juncture of internet development. The inorganic community development process continues to be indicated as a leader in economic, political, and social change. Cybertools propose an innovation of relatively untapped potential within the process.

## 6. PILOT TESTING ICT FOR DEVELOPMENT

The practice of using cybertools for Development remains embryonic with little possibility to determine real impact in reaching for and developing inorganic community through (in)appropriate technologies. Much of the available information comes from internet sources—normally websites created to market specific project work and attract interest and donor funding from within the IT field. Most of the sites viewed are in English with clear audience targets. A few academic papers were also available and used (McLagan, 1996; Mojab, 2000, 2001; Warschauer, 2002). A primary research based independent review was not possible for this chapter. The project documents were read and coded according to the principles set out above in order to track embedded (in)appropriate technology design phases within inorganic community development processes.

Projects may be divided into a variety of purpose-based types: civil society development, eGovernance, social service development (eLearning, education, and health), and eCommerce. Interestingly, projects with similar purposes seemed to use similar cybertools aiming to achieve similar purposes. List serves are in evidence for civil society development, lobbying, and political activism (Jhai Foundation, 2003; McLagan, 1996; Mojab, 2000; 2001). Telekiosks provide government information to citizens (Sustainable Initiatives, 2003a). Telecenters are being used for teacher training and adult education in computer skills development (Global Catalyst Foundation, 2003; Madhusudan, 2002; Sustainable Initiatives, 2003a). Handheld devices are being used for remote access to medical advice (Vaid, 2003). Websites are used to market and sell co-operatively made goods directly to national and international consumers (Jhai Foundation, 2003; Sustainable Initiatives, 2003a).

Some of the noted project phases are not in evidence in the available documentation. For example, there is little documented evidence of the problem identification phase and how cybertools became central to project design. Where it is clear, user groups had either limited involvement or no involvement at all. In the Hole in the Wall experiment the surprise introduction of the tool resulted in cautious excitement amongst the child stakeholders and resentment in some of their parents (Madhusudan, 2002; Warschauer, 2002: 1–2). In other cases, as will be noted below, the failure to involve the community directly from the beginning resulted in unintended negative outcomes in terms of the usability of the technological tool in question as well as “development” impacts.

The development and use of localized, rugged, low-cost, linguistically appropriate hardware and software remains a challenge in these projects. A concern for green technology is even more obscure. The Simputer and the Village PDA are both handheld devices developed to be rugged and easy to use in othered contexts. However, there is no clearly stated need for their

development at a village level (Simputer, n.d. & Village PDA, n.d.). ICT for development projects primarily continue to import or “leapfrog” outsider technologies, curricula, ideas, structures, and practices thereby minimizing the potential for human capacity building. Of the case studies, only the Jhai Foundation’s Remote IT project in rural Laos and the Global Catalyst Foundation’s refugee village teacher training project in Tanzania show elements of local community-based technological tool development.

The Jhai Foundation (<http://www.jhai.org>) has embedded a user-centered technology design project cycle within the wider community development project cycle and intends to result in rugged, long lasting, linguistically appropriate computers run by car batteries recharged by bicycles. The technological tools will enable the community—a village of people displaced from their traditional location during the U.S. war in Indochina—to access markets for their organic rice crops locally and to communicate with relatives who were displaced farther a field. The prototype design team includes educated Laotians, diaspora Laotians, non-Laotian technology designers, and consultations regularly with village level users.

Although the Global Catalyst Foundation’s telecenters for teacher training and learning support in Tanzanian villages and refugee villages ([http://www.globalcatalyst.org/pages/what\\_we\\_do/what\\_we\\_do\\_projects.htm](http://www.globalcatalyst.org/pages/what_we_do/what_we_do_projects.htm)) seem to have imported outsider hardware, community-based self-help teams were used to construct the buildings and biogas system which is being used to create 70% of the power needed to run the computers. Aside from the introduction of an element of “green” electricity and the involvement of local educationists and builders, the development and design phase of the project seems to have externalized end users.

The use of external hardware and software tools would be appropriate if there were evidence of financial and technical maintenance sustainability, adaptation, and cultural appropriation. Most of the projects include an element of fee-for-use structures which in turn may exclude use by the poor, or extremely poor. While locally appropriate fee structures might be able to support the maintenance of locally designed tools, it is likely to be too small to support maintenance of imported/localized tools. The Digital Village case study, a telecenter project, includes a video interview with Johannes Mphalhele, telecenter manager, who says that the donor-funding paid for the technology, but not their long-term maintenance causing sustainability issues (Sustainable Initiatives, 2003b). Mark Warshauer’s study of Cairo University’s Media Lab project showed that computer labs embedded within higher education structures can be equally difficult to maintain over the long term (2002: 3). Smaller projects, such as the Handy Vaid, show that with apparently “simple” technologies and “simplified” software, outsider/literate locals must be trained and used if telehealth projects are to reach all proposed stakeholders (Vaid, 2003).

Documentation of community involvement in the process—more poignantly community leadership or centrality—is again difficult to determine from secondary sources and much of the available evidence was inconclusive. The impact of these case studies is also varied and dependent on the current location of the project within the project cycle. In many case studies limitations are a result of the nature of the information available about the project itself. However, there are some clear indications of challenges to achieving the theoretical goals of stronger communities and sustainable development.

The Hole in the Wall, for example, has been hailed as an excellent example of “minimally invasive learning”, but Mark Warschauer has shown that some elements of the community found the project to be hegemonic, intrusive in schooling expectations, and foreign (2002: 1–2). List serves appear to have both positive and negative outcomes depending on the goals. Shahrzad Mojab found that while list serves for political action can allow diaspora members of the community to engage with civil society action and development from afar, face-to-face community meetings and action can regularly accomplish more (2001: 52–53). Meg McLagan’s study of a different list serve project to communicate Tibetan point of view to outside audiences reinforced the possibilities of list serves and e-mail for lobbying political causes of marginalized or politically isolated groups within MDCs (1996). Telekiosks might help governments make simple information more easily available, but they assume a level of literacy, do not eliminate line-ups, and may require people to stand in a second line if they cannot find the information or a more difficult/personal question is raised. A telekiosk can also make interactive access to government structures more difficult by creating an unintended wall. This is particularly the case with telekiosks being one-way touch screen computers with no facility for the user to input/send comments. Finally, projects for job retraining and job hunting *via* the internet, both in Ireland and in Africa, show limited impact. The project in Ireland, documented by Mark Warschauer, showed that there may be more value in face-to-face support for unemployed job hunters (2002: 2–3). In the Digital Village, one user said that while he likes learning to use the computers, he was not convinced it would help him gain employment (Sustainable Initiatives, 2003b).

Ultimately there is a myriad of small projects already being carried out using (in)appropriate technology and community development models for inorganic community purposes. The quality, nature of design, and impact is undocumented in many cases making it difficult to properly assess project design against the model suggest above. Nevertheless, the evidence suggests there is a theory-practice gap under both theoretical legacies. Much of the documentation, particularly on the internet itself, focuses on the success of the technology, but not on community change. Documenting the social impacts of these tools would take the focus away from the tool and place attention on the human and social impacts—the real purposes of designing technology.

Since much of the technology was not developed locally and cannot be sustained locally, the success of that technology in meeting the needs for ruggedized, linguistically appropriate, ZeroCost, ecologically friendly technology is limited. Moreover, the unique cultural spaces, or the localized needs of potential users, continue to be marginalized in practice, or at least marginalized in documentation. The apparent exceptions are the Jhai Foundation Remote Village IT project and the Global Catalyst Foundation's teacher training project, but neither project is as yet at a place in the project cycle where community-impact is being documented. Where critical information is available, it is apparent that there are issues of cultural relevancy and sustainability in using outsider technologies to support local initiatives. As with the tea seller in Northern Afghanistan whose story started this chapter, decisions related to technologies as tools cannot be shaped or reasoned, but need to occur in an organic bottom-up process.

## 7. ALL THE WORLD'S A STAGE

The voices privileged in this chapter have largely been those of theory, academics, and organizations implementing pilot ICT for Development projects. Three sets of voices have been unintentionally marginalized—the policy voice, the user voice, and the radical deconstructionist voice. The policy voice is represented by bi- and multi-lateral donor agencies and United Nations agencies, which provide funding and technical support for large scale projects. Madhusudan (2002) writes that the Hole in the Wall is now being scaled up through support from the World Bank and other donors. Haddad and Draxler's book (2002) received funding from the Academy for Educational Development (AED) and the United Nations Education, Scientific and Cultural Organisation (UNESCO) and clearly sought to reflect policy and practice in ICTs for development by those agencies. Finally, the Jhai Foundation receives private funding and funding from several international agencies including the International Development Resource Centre (IDRC). Despite this support, the policy voice remains weakly heard in the represented voices. A critical study of the donor perspective and support for the theory of organic and inorganic community development as well as (in)appropriate technology is important to a future initiative, because donor policies have a heavy impact on the design and implementation of projects.

Important to the theory focused on herein, user voices, on both an individual and collective level, have been marginalized by failing to be heard above the English language context in online documentation and through translation. Although the Sustainable Initiatives website includes a few short videos of user opinions, local managers' opinions, and the real-use context, much more needs to be introduced into the body of available literature. Verbatim reporting of user experience, needs, and impacts of (in)appropriate tools would, despite

translation to English, provide a clarified sense of power and appropriateness to the users. Experience and interaction would result in some direct filtering out of the voices of reporter, editor, and translator as much as possible. It is especially important that the voice of the poorest and most marginalized be sought. User experience will assist in providing wider direct influence between practitioners and users as well as increasing the power of individual marginalized voices to promote organic community development. The user can only be made central to project development, management, implementation, and learning if user voices are also made central to the documentation. Perhaps the only way to encourage this process would be for practitioners to adopt or to use post-modern anthropological methods in ethnography which engage directly with the user/community member and document through the use of ICTs and verbatim reporting (Ferguson, 1994; Pont, 2001; Tyler, 1986.). Although translation from indigenous languages to other languages will affect meaning and bring cultural coding and inference into question, there is no other way to empower marginalized voices within the research dichotomy.

The radical deconstructionist voice refers to the suggestion that in order to ensure that (virtual) community continues to develop and to be created organically; the entire international aid system should be dismantled.<sup>3</sup> One of the assumptions behind this voice is that all inorganic interventions in community are necessarily harmful or have lead communities into unnatural directions. Another is that the active de-globalization of economical, political, and social relations is possible, desired, and actively taking place. A third, but by no means final, assumption is that the emergency relief/humanitarian aid “branch” of development services is similarly no longer needed and that disaster relief can be done through other mechanisms already in place. The goal of this study was to understand and to develop a paradigm for understanding how ICTs might be designed and used as community development tools within the existing system. Although the author is herself an insider to the international development aid system, marginalizing the radical deconstructionist voice was not done deliberately. Within the context of the goals, there was simply no space for this viewpoint.

## CONCLUSION

E. F. Schumacher promoted a utopian, if not problematic, post-industrial world of small localized ecology complete with small, and possibly non-industrialized, technology to support it. While he was not against progress, change, or development, Schumacher preferred a world wrapped in self-sustainability, independence, ecological balance, and cultural relevancy in action. Schumacher’s legacy is represented in a body of practical applications promoting participatory development practices, which encourage the marginalized of this increasingly urban, economically globalized world to

find space and voice for themselves without necessarily achieving transformative change for small, beautiful economies.

As part of the application of the post-colonial debate, theories of small development evolved into legacies of (in)appropriate technology use and inorganic community “development” in practitioner-led attempts to affect the organic processes of (virtual) community. Within the sphere of inorganic community development, the internet represents a series of tools which may enhance or enable the process while increasing the possible breadth of community membership to a glocal level, but which largely ignore the ecological issues.

The study of and reporting on results of using cyberspace tools in inorganic community development projects of different types are incomplete. Moreover, theory-project cycle-practice gaps indicate that more effort is needed in order to determine the real impact of cybertools in LDCs. While more independent research and documentation is needed on all levels, more real participation, ecology, and user-centeredness are also indicated as potential steps forward in human-centered development processes. In an effort to counter the voices of skepticism and unbridled enthusiasm for the use of cyberspace tools in LDCs, a greater effort should be made to translate and publish the verbatim voices of users, user-collectives, and potential others. If access to and use of the internet is really what half the world wants, then it is the role of the development practitioner to facilitate the introduction of the internet in a manner which is in keeping with the principles, theories, and legacies of the “development” field. In embracing the tools of the more/most developed elites, the less/least developed may find the power and voice that theory suggests they have.

#### ENDNOTES

1. Earlier iterations of this paper were read and commented on by D. Jason Nolan, David N. Wilson, and a committee of anonymous readers from the Knowledge Media Design Institute’s Working Paper Series. I am grateful to them for their input. The ideas presented herein are entirely my own.
2. A collection of online articles and announcements related to the installation of cellular networks, internet access, and digital technology-based aid projects related to (re)constructing Kabul can be found at <http://www.clevergirl.ca/zcc/index.php?cat=8> (last accessed June 6, 2004).
3. The third voice responds not to a specifically articulated theory or person(s) who put this argument forward. However, it is a popularly heard voice verbalized within “Western” academia and in particular within the context of some groups I have participated in at the Ontario Institute for Studies in Education. Despite a lack of documentation for this voice, I did not feel I could write this paper without acknowledging it. I acknowledge

Jason Nolan in particular who regularly plays devil's advocate by challenging me to respond to the radical deconstructionist voice.

#### REFERENCES

- Anderson, B. (1991). *Imagined Communities*. London: Verso.
- Archer, D. & Cottingham, S. (1996). *The Reflect Mother Manual: A New Approach to Adult Literacy*. London: Actionaid.
- Ballantyne, P. (2002). eDevelopment: connecting the worlds of information and development. *Compare* 32(3), 365–379.
- Bell, D. (2001). *Cyberculture: The key concepts*. London: Routledge.
- Brock, K. & McGee, R. (Eds.) (2002). *Knowing Poverty: Critical Reflections on Participatory Research and Policy*. London: Earthscan Publications.
- Bromley, D. W. (1992). The commons, property, and common property regimes. In: Bromley, D. W. (Ed.) *Making the Commons Work: Theory, Practice and Policy*. San Francisco, California: ICS Press, 3–16.
- Burkey, S. (1993). *People First: A Guide to Self-Reliant, Participatory Rural Development*. London, New York: Zed Books Ltd.
- Chambers, R. (1993). *Challenging the Professions: Frontiers of Rural Development*. London: Intermediate Technology Publications.
- Corea, S. (n.d.). Cultivating Technological Innovation for Development. Downloaded on March 20, 2003 from the World Wide Web at: <http://itd.gopa.de/sites/oecs/documents/InnovationForDevelopment.pdf>.
- Dolsak, N. & Ostrom, E. (2003). The challenges of the commons. In: Dolsak, N. and Ostrom, E. (Eds.) *The Commons in the New Millenium*. Cambridge: The MIT Press, 3–34.
- Ferguson, J. (1994). *The Anti-Politics Machine: "Development", Depoliticization, and Bureaucratic Power in Lesotho*. Minneapolis: University of Minnesota Press.
- Freire, P. (1985). *The Politics of Education: Culture Power and Liberation*. Massachusetts: Bergin & Garvey Publishers, Inc.
- Freire, P. (1970). *The Pedagogy of the Oppressed*. New York: Herder & Herder.
- Global Catalyst Foundation. (2003). Kasulu and Mtabila Internet Project. Last accessed on April 23, 2003 from the World Wide Web: [http://www.global-catalyst.org/pages/what\\_we\\_do/what\\_we\\_do\\_projects.htm](http://www.global-catalyst.org/pages/what_we_do/what_we_do_projects.htm).
- Haddad, W. H. & Draxler, A. (Eds.) (2002). *Technologies for Education: Potentials, Parameters and Prospects*. Paris: United Nations Educational, Scientific and Cultural Organisation (UNESCO). Last accessed on March 17, 2003 from World Wide Web: <http://ict.aed.org/infocenter/pdfs/TechEdBook.pdf>.
- Halileh, S. & Giacaman, R. (2002). Distance Learning—An Educational Survival Strategy in War-like Conditions at the Institute of Community and Public Health, Birzeit University. Downloaded on 23 April, 2003 from <http://www.reliefweb.int/w/rwb.nsf/c7ca0eaf6c79faae852567af003c69ca/bd2c4beb30ce946785256c7e0073c14e?OpenDocument>.
- Haythornwaite, C. & Wellman, B. (2002). The Internet in everyday life: an introduction. In: Wellman, B. and Haythornwaite, C. (Eds.) *The Internet in Everyday Life*. Oxford: Blackwell Publishers.
- Huiskamp, G. (2002). Negotiating communities of meaning in theory and practice: rereading *pedagogy of the oppressed* as direct dialogic encounter. In: Slater, J. J., Fain, S. M., and Rossatto, C. A. (Eds.) *The Freirean Legacy: Educating for Social Justice*. New York: Peter Lang, 73–94.



- Illich, I. (1970). *Deschooling Society*. New York: Harper & Row Publishers.
- Intermediate Technology Development Group (ITDG). (n.d). What is 'Appropriate' or 'Intermediate' Technology? Accessed on April 30, 2003 from <http://www.itdg.org>.
- Jaffee, D. (1998). *Levels of Socio-Economic Development Theory*. 2nd edition. Westport: Praeger.
- Jhai Foundation. (n.d.). Remote Village IT Project. Last accessed on 22 April, 2003. Available on: [http://www.jhai.org/jhai\\_remoteIT.html](http://www.jhai.org/jhai_remoteIT.html).
- Jhai Foundation. (2003). Welcome to the Jhai Foundation Last accessed on 30 July, 2005. Available on: <http://www.jhai.org>.
- Kolb, D. A. (1984). *Experiential Learning: Experience as The Source of Learning and Development*. Englewood Cliffs, New Jersey: Prentice Hall Inc.
- Kothari, U. & Minogue, M. (2002). Critical perspectives on development: an introduction. In: Kothari, U. and Minogue, M. (Eds.) *Development Theory and Practice: Critical Perspectives*. London: Palgrave, 1–15.
- Lefebvre, H. (1998 (1974)). *The Production of Space*. Oxford, U.K.: Blackwell.
- Madhusudan, C. N. (2002). India's Hole in the Wall: Key to Bridging the Digital Divide. *Techknowlogia*. Downloaded on January 18, 2003 from <http://www.worldbank.org/wbi/corpgov/csr/pdf/holeinwall.pdf>.
- McLagan, M. (1996). Computing in Tibet: virtual politics in the post-cold war era. In: Marcus, G. E. (Ed.) *Connected Engagements with Media*. Chicago: University of Chicago Press, 161–194.
- Mojab, S. (2000). The feminist project in cyberspace and civil society. *Convergence* 33(1–2), 106–119.
- Nakamura, L. (2002). *Cybertypes: race ethnicity and identity on the Internet*. London: Routledge.
- Mojab, S. (2001). The politics of "cyberfeminism" in the Middle East: the case of Kurdish women. *Race, Gender and Class* 8(4), 42–61.
- Nolan, J. (2001). The Technology of Difference: ASCII, Hegemony and the Internet. Last Accessed April 22, 2003. Available at: <http://jasonnolan.net/papers/technologyofdifference.html>.
- Nolan, J., Dicum, J., & Sangha, J. (2004). ZeroCostComputing. Last accessed June 11, 2004. Available at: <http://clevergirl.ca/zcc>.
- Ostrom, E. (1992). The rudiments of a theory of the origins, survival, and performance of common property institutions. In: Bromley, D. W. (Ed.) *Making the Commons Work: Theory, Practice, and Policy*. San Francisco: ICS Press, 293–318.
- Pearce, J. (2001). *Small is Still Beautiful*. London: HarperCollins Publishers.
- Pont, A. M. (2001). *Blind Chickens and Social Animals: Creating Spaces for Afghan Women's Narratives Under the Taliban*. Portland: Mercy Corps.
- Poster, M. (2001). *What's the Matter with the Internet?* Minneapolis: University of Minnesota Press.
- Preece, J. (2000). *Online Communities: Designing Usability, Supporting Sociability*. Chichester: John Wiley & Sons Ltd.
- Preece, J., Rogers, Y., & Sharp, H. (2002). *Interaction Design: Beyond Human-Computer Interaction*. New York: John Wiley & Sons.
- Pretty, J., Guijt, I., Thompson, J., Scoones, I. (1995). *Participatory Learning and Action: A Trainer's Guide*. London: International Institute for Environment and Development.
- Rheingold, H. (1994). *The Virtual Community: Homesteading on the Electronic Frontier*. New York: Harper Perennial.
- Rheingold, H. (n.d.). Why Can't We Use Technology to Solve Social Problems? Last Accessed April 23, 2003 on the World Wide Web <http://www.edge.org/documents/questions/q2001.2.html#rheingold>.

- Rondinelli, D. A. (1993). *Development Projects as Policy Experiments*. London, New York: Routledge.
- Roy, A. (2001). *Power Politics*. Cambridge, MA: South End Press.
- Schumacher, E. F. (1989, 1973). *Small is Beautiful: Economics as if People Mattered*. New York: Harper Perennial.
- Schumacher, E. F. (1977). *A Guide for the Perplexed*. New York: Harper & Row Publishers.
- Shirky, C. (1998) Divide by Zero Era. Retrieved on November 16, 2002 from <http://www.shirky.com/writings/divide.html>.
- Shirky, C. (2002). Half the World. Retrieved on February 9, 2003 from <http://shirky.com/writings/half.the.world.html>.
- Simputer (n.d.). Simputer: Radical Simplicity for Universal Access. Last accessed April 24, 2003 on the World Wide Web: <http://www.simputer.org/>.
- Sjogeb, G. (1960). *The Preindustrial City: Past and Present*. Glencoe, Illinois: The Free Press.
- Slater, J. J. (2002). Limitations of public space: habitus and worldlessness. In: Slater, J. J., Fain, S. M., and Rossatto, C. A. (Eds.) *The Freirean Legacy: Educating for Social Justice*. New York: Peter Lang, 57–72.
- Surman, M. & Wershler-Henry, D. (2001). *Common Space: Beyond Virtual Community*. Toronto: FT.com.
- Sustainable Initiatives. (2003a). Case Studies. Last accessed on April 23, 2003 on the World Wide Web: <http://www.sustainableicts.org/Casestudies.htm>.
- Sustainable Initiatives. (2003b). Digital Village. Last accessed on April 23, 2003 on the World Wide Web: <http://www.sustainableicts.org/DIGVILL.htm>.
- Tyler, S. A. (1986). Post-modern ethnography: from document of the occult to occult document. In: Clifford, J. and Marcus, G. E. (Eds.) *Writing Culture: The Poetics and Politics of Ethnography*. Berkeley: University of California Press, 122–140.
- Vaid, H. (2003). Description. Last accessed on April 23, 2003 from the World Wide Web: [http://www.jiva.org/programs/description.asp?program\\_id=2](http://www.jiva.org/programs/description.asp?program_id=2).
- Valovic, T. S. (2000). *Digital Mythologies: The Hidden Complexities of the Internet*. New Brunswick: Rutgers University Press.
- Village PDA. (n.d.a). Bridging the Digital Divide: The Village PDA Solution. Last accessed on April 24, 2003 from the World Wide Web: [http://www.villagepda.com/case\\_study/kenya\\_case\\_study.pdf](http://www.villagepda.com/case_study/kenya_case_study.pdf).
- Village PDA. (n.d.b). The Village PDA. Last accessed on January 15, 2003 on the World Wide Web: <http://www.villagepda.com>.
- Warschauer, M. (2002). Reconceptualizing the Digital Divide. *First Monday* 7(7), 1–13. Downloaded on April 2, 2003 from the World Wide Web [http://www.firstmonday.dk/issues/issue7\\_7/warschauer/](http://www.firstmonday.dk/issues/issue7_7/warschauer/).
- Wellman, B. (2001). Physical place and cyberplace: the rise of personalized networking. *International Journal of Urban and Regional Research* 25(2), 227–252.
- Yates, J. & Okello, L. (2002). Learning from Uganda's efforts to learn from the poor: reflections and lessons from the Uganda Participatory Poverty Assessment Project. In: Brock, K. and McGee, R. (Eds.) *Knowing Poverty: Critical Reflections on Participatory Research and Policy*. London: Earthscan Publications, 69–99.

# Chapter 61: Broadband Technologies, Techno-Optimism and the “Hopeful” Citizen

MATTHEW ALLEN

*Internet Studies, Curtin University of Technology, Perth, Australia*

## 1. INTRODUCTION: BROADBAND AND VIRTUAL LEARNING ENVIRONMENTS

Using the internet to promote or facilitate learning has a relatively long history. As early as the mid-1980s, at a time when the internet itself was relatively experimental, a few early pioneers such as Hiltz were exploring the possibilities that networked computer communications technology could provide for education. Not only were universities the birthplace of the internet as a research network, they also had both staff with interests in using technology for learning as well as the critical infrastructure which might permit early development and adoption. But, with the widespread public uptake of the internet from 1994 onwards, online learning has become much more widespread—through traditional institutions of learning (schools, colleges, and universities), and also through the auto-didactic qualities of both the internet itself and many who use it; and finally through the opportunities which commercial “providers” of education and training imagine might be embedded in this new technology to deinstitutionalize learning.

In some ways, while institutions of learning, and learners themselves, have quietly got on with the business of education, delivered solely, primarily or with significant extension, through the internet, commercial expectations of significant for-profit education, enabled by the internet, have not been realized. While we might critically analyze some of the late 1990s enthusiasm for “elearning” as yet-more dot.com hucksterism, it is also important to consider that there is some truth in the claim that commercial online learning demanded far higher bandwidth than was readily available to most potential clients. The coming of broadband access, which is the primary focus of this chapter, might then suggest that a new phase of development will occur for those kinds of learning environments which depend on high bandwidth connectivity.

The development of internet-based learning has, until very recently, been specifically influenced by the narrowband access available to most teachers and students. For some, perhaps many, this influence has been positive, leading to a model of online learning that has been pre-dominantly driven by textual information and communication between teachers and students, largely conducted within a constructivist paradigm of learning. In the absence of the more traditional kinds of “classes” within which students mostly learn,

teachers have developed—and students have enthusiastically adopted—modes of instruction that do not depend on the audio-visual representation of lectures, or on awkwardly synchronous gatherings of many students, only a few of whom might be able to participate effectively in the time available. It might be argued that this approach was borne of necessity and has been a pale imitation of “real” online learning involving the transposition into the virtual of all elements we might normally associated with “classroom” learning. But, it would appear that, in fact, a new mode of learning has appeared which, while not replacing existing forms, provides important alternatives.

Broadband access, when widely available in society, might in time change this position, consigning the largely textual interactions of teachers and students in the past decade of online learning to an historian’s footnote. Certainly, from a technologically determinist position, this outcome seems likely. Those favoring it argue that bandwidth demands such development, as if the width of the channel will necessarily bring more and more extensive content. But it is not clear, however, whether broadband will indeed effect this change, although undoubtedly as broadband access becomes more “natural” in societies it will encourage developments that utilize its capacity to allow distributed, audio-visually rich learning environments to emerge. To make reasonable predictions about the likelihood of this kind of development requires more than just a techno-fetishist belief in the pressure that technological change alone can bring. Rather it requires a more subtle understanding of the social, political, and economic contexts within which hardware and software are used.

This chapter provides just such a context, by way of an in-depth study of the deployment of broadband internet access in Australia in recent years. Firstly this study demonstrates that the link between online education and broadband technology is not merely a matter of content meeting bandwidth. Indeed it has become clear in Australia that the obsession with richly graphical, televisual-style content (of the kind we might associate with education delivered over the internet) has at best had little positive impact on broadband development. Rather, if broadband is to have a significant impact on improving or expanding virtual learning environments it is likely to come through changes in both the perception of internet users about the internet, sparked through the marketing and promotion of broadband, rather than the technology alone. It is also going to be heavily influenced by the embedded technological limitations and socio-economic conditions within which apparently neutral “technological” development actually occurs. Second, this chapter exemplifies the kind of thinking that must also be applied to online education itself, taking seriously the role of government, market and consumer/citizen internet users in making sense of technology. Broadband, whose absence is often imagined to be a “barrier” against adoption of virtual learning environments actually emerges as far more than a technological capacity that will solve problems just by becoming available. Similarly those learning environments themselves are not

a given solution but, instead, a site for further contests of meaning over the roles the internet plays in society.

And, in Australia in 2003, nothing better represented the persistence of techno-optimism than the heavy promotion in print and electronic media of the “internet fridge”—an LG Electronics’ product that features an internet-linked touch-screen/processor, mounted in the shiny stainless steel front of a domestic refrigerator. In the advertisements, what the beautiful, hip urban digerati are gaining from possession of this piece of domestic ingenuity is unclear . . . except of course that they are more hip, more beautiful, more digital. The internet fridge is a good example of the way that, in the 21st century and especially in developed nations such as Australia, internet technologies exist within social and political life as the result of the intersection of the marketing of internet-access products, the development of new technological systems for access, and irregular government regulation and policy pronouncements of the “need” for new forms of information and communication technology. My chapter explores this intersection by examining three cases, one each for marketing, government policy and regulation, and technology, that exemplify the issues of deployment and development of broadband in Australia.

The first case concerns the ongoing efforts of internet service providers (ISPs) in Australia to market broadband access products in 2003, paying particular attention to the way in which advertising reveals the complexity of the “users” who might use broadband in a residential setting. The second case focuses on the desires and strategies in government’s policy making, constrained by a free-market ideology, to promote broadband “take up” in Australia and I will identify especially the way in which nationalism underpins and makes sensible this policy. The third case looks at how Australia’s broadband access is, effectively, an ad-hoc, pragmatic implementation in which the decision-making process is almost entirely conducted within the private spaces of the free market producing a complex, “what we’ve got” approach to broadband infrastructure. My main focus here is on the way technology expresses other significant political and economic facets of the broadband picture.

## 2. MARKETING BROADBAND PRODUCTS

Three main advertising campaigns that aimed to sell broadband products, principally but not exclusively to residential consumers, were seen on Australian television in 2003. These advertisements were by no means the first, nor the last, for these services. Indeed, since January 2004 and some significant new service development by Telstra, such advertisements have become commonplace. But, in 2003, such advertisements were notable because they followed and to some extent reflected recent changes in the telecommunications and pay-television regulatory framework consequent upon decisions by the Australian Competition and Consumer Commission (ACCC) on pricing

and corporate agreements. These decision, put simply, required Telstra (the primary wholesale provider of DSL access) to reduce its prices to retailers; and permitted greater freedom of integration between the Foxtel pay-TV provider (part-owned by Telstra and by News Corporation) and Telstra itself (McGrath, 2002; Velde, 2002; see also McCarthy, 2001). The initial result, by the end of 2002, was a dramatic increase in the number of DSL connections, taking this kind of access past cable connectivity for the first time since residential broadband became available in Australia (Turner, 2003). The advertising examples that I discuss below are a reasonable sample of the marketing initiatives of the past two years in Australia, in the way that the needs and interests of likely customers are characterized by various ISPs, and demonstrate some of the ways in which internet-related information technology is constituted as a benefit in contemporary Australian society. They are also significant, for the specific conclusions in this paper because, as indicated previously, government policy making in relation to broadband is significantly influenced by perceptions of the lack of awareness among consumers about the advantages of broadband (the so-called information asymmetry in the marketplace). Thus these examples of major marketing campaigns provide an opportunity to identify the environment in which that policy making operates.

The first example promoted the iPrimus brand (owned by Primus Telecommunications Group). Primus is Australia's third-largest telecommunications company, behind Telstra and Optus (the local brand of the multinational corporation, Cable and Wireless). The advertisements consisted of a series of short, humorous scenes that have nothing to do with the internet—a golfer sinking a long-distance putt, a couple of nervous teenagers about to kiss for the first time, and so on. Each one was an example of success in conditions of adversity or uncertainty; each was a variation on the classic literary theme of the promise of desire, unfulfilled. In the advertisement, at the crucial moment—as the ball is about to sink, the lips are about to meet—the action freezes and the slogan “disconnected” flashes on the screen, accompanied by sound effects of the kind of grinding noises that only a modem can make. These advertisements ran for at least three months, dispersed across various programs and channels and their central message continues to form the basis of the iPrimus marketing campaign, as stated on the website: “iPrimus Broadband also gives you Frustration Free Internet access with always on access and no unexpected dial-up disconnections or costly dial-up charges” (<http://www.iprimus.com.au>). By linking disconnection to games and romance, two primary reasons for online activity, the campaign zeroes in on one critical advantage of broadband over dial-up access. Clearly the campaign was designed principally to attract to iPrimus *existing* internet users, for whom the frustration of internet disconnection would be meaningful, rather than non-internet users.

The second advertising campaign came from Telstra, Australia's dominant telecommunications company (the partially-privatized successor to the former national monopoly telephone provider Telecom Australia) and the owner of the

vast majority of the infrastructure over which internet services are delivered (for example, all local telephone exchanges belong to Telstra). The Telstra campaign, declared in May for July release (Sainsbury, 2003b) took place in two stages. Reflecting its enormous budget and market dominance, the campaign was clearly more expensive than that of iPrimus, both in terms of production values of the advertisements and in the fact that it was a two-stage campaign with longer advertisements. The first advertisement appears, until the very last moment, to be the story of a simple fisherman whose boat is at sea in a storm, then sunk by a whale and, upon washing up onshore, he is attacked by mediaeval knights, as well as experiencing many other unrelated and surrealistic phenomena in about 30 seconds of carefully crafted, digitally effected filmmaking. All is revealed in the end when he telephones his son and the scene changes to his son's bedroom where, as well as being on the phone, the child is doing his homework by finding information on the internet about (we assume) whales, knights, and so on—and that this information has “come to life” in some way because of the speed of downloading via broadband.

Promoting the “Bigpond” brand that Telstra has used for many years for its internet services, the advertisement (like iPrimus) provided no detail of costs or specific broadband arrangements. Rather the commercial created an aura of excitement and possibility that appears to make broadband (and more specifically Bigpond—hence the sea-based scenario) essential to a useful, entertaining and educational internet experience. So rich in detail, the advertisement was a masterpiece of open signification, calling upon its viewers to interpellate themselves into the text and draw from it the meanings that make sense to them, but which all place Telstra, and broadband itself, in a positive light. The follow-up advertisements were quite different. They simply promoted bundling Telstra telephony, internet, and pay-television subscription (repackaging an existing pay-TV service) to receive a modest discount each month (details that were repeated, prominently at <http://www.telstra.com>). The campaign was broad enough to attract many different kinds of new customers, or to retain existing customers; however it is also clear that, by emphasizing the link between pay television and the internet, Telstra appeared to be targeting those pre-identified customers (pay-tv subscribers) who are willing or able to prioritize media purchases (such as broadband access) in their household economies.

My third example is for Dodo Internet—a relatively new ISP that proclaims “Who says that the Dodo is extinct . . . Those people obviously don't know where we live. The truth of the matter is, we needed to stay low for a while whilst we became the very best Internet Service Provider (ISP)” (<http://www.dodo.com.au>). This company, named after a flightless bird, has a peculiarly incongruous slogan of “Dodo, Dodo, Internet that flies!” Its marketing in 2003 (which has continued into 2004) consisted of two low-budget television advertising campaigns—the first promising cheap dial-up

access; the second promising cheap broadband access (using ADSL). The advertisements involve a cartoonish “Dodo” character, dressed as a superhero, coming to the rescue of a person who just wants to know a simple answer to “can you get me a cheap connection to the internet?” In both cases, and as repeated on the company’s website, the emphasis was on lower cost. The website was, in comparison to other ISPs, simple, even childish in its approach and subtly reinforced the explicit messages that Dodo is cheap. In fact, it is not clearly cheaper and in some cases is more expensive than other ISPs.

Dodo’s marketing campaign was fundamental to its status as a developing business. As a new entrant into a market place with many hundreds of ISPs (though with only a few that are substantial in size), Dodo had to build brand recognition and, more importantly, distinctiveness. These advertisements were, it would appear, not designed to recruit existing internet users. Such users would be pre-disposed and quite capable of checking, online, the price relativities and would be unlikely to churn to a company whose bright, simplistic website implicitly signals value, not quality, if it were not in fact cheaper. Rather, these advertisements prompted viewers to identify with the confused and uncertain—even fearful—internet hopeful in the narrative, to whom Dodo came to the rescue. Not surprisingly, the advertisements drew on the tired, yet still persistent gendered representation of women as less-than-competent internet users. More significantly, these advertisements did little to distinguish between broadband and dialup access, while selling both. Since the same slogan “internet that flies” was used to promote both products, they do not clearly communicate on the difference in speed of a broadband connection. Equally, the Dodo website barely distinguished the two, unlike dozens of other ISPs that clearly identified the differences between dialup and broadband in terms of speed, convenience, and so on—establishing it as a “technological advance” and explaining how it might be cheaper than dialup in some circumstances. Thus, to a large extent, Dodo pitched its marketing at the novice user who might actually be confused by the technological decision-making required to choose from the complex array of products offered by more established ISPs.

Taken together, these three campaigns show the complexity of a highly competitive market and the diversity with which it can be approached by ISPs/telecommunications companies. The advertisements indicated the way ISPs were seeking to produce certain kinds of consumer-groupings to which they can appeal. IPrimus sought to churn users from existing dialup accounts. Telstra sought both the primary media-consuming customers as well as promoting the very idea of broadband (which would benefit Telstra since it is also a wholesale provider of broadband access). Dodo created a grouping of novice users concerned about price. Several key conclusions emerge, when these advertisements are linked with the overall state of the market for internet access in Australia, the realities of the technology, and the perceptions of those, such as the government’s Broadband Advisory Group, who



are—effectively—engaged in their own policy advertising campaign to promote broadband at a national level.

One significant feature to emerge from these campaigns was that online content was barely mentioned. While both Telstra and iPrimus offered some exclusive video content of the kind that would only be accessible for broadband users (for example, sporting packages on Telstra such as in-car camera footage from motor racing, and, for iPrimus, access to tropFest festival short films), neither company emphasized this content in the television advertising or on their websites. Telstra continued some key sports-content deals that were as much about Telstra's pre-existing commitment to sport through television broadcasting and part-ownership of the Foxtel pay-television network, thus suggesting that this content was as much an advertisement for that other business. Yet, in 2003, it ended specialized content deals from previous years for "unique" online content (Ferguson, 2003). Optus, which had previously emphasized an exclusive-content approach through its Optus@Home version of Excite@Home, did not emphasize content of this kind in its very limited marketing in 2003, even though it had previously engaged in one-off linkages with free-to-air television programs (such as the very popular *Big Brother* series) to provide some exclusive video content. The reshaping of pay television provision in Australia, through a deal in which, effectively, the main pay-TV networks share content, promoting competition between packages and channels, rather than between discrete networks, and the opportunity for bundling of pay-TV, telephony and internet meant that, from 2003, online content equivalent to the kinds of channels available by subscription was no longer relevant. Telstra and Optus would be competing against their own television products (see for example the comments of respected telecommunications commentator Paul Budde, 2003a). Instead (as indicated by recently released news of a linkage between Sony and Telstra for networked Playstation gaming [<http://au.playstation.com/news/telstra.jhtml>] and the existence of "gaming" ISPs such as OzForces, [<http://www.ozforces.com/>]), "content" for broadband is almost certain to be interactive computer-based services rather than television-equivalent channels.

Dodo, as a cut-price re-seller of DSL access purchased from Telstra, operates deliberately outside of content deals, limiting its operations to extracting the greatest possible return from the simplest service. Of all the hundreds of ISPs in Australia, almost none are in a position to offer content. And what emerged in 2003 was recognition by the main providers, Telstra and Optus, that content was not, of itself, of great significance as part of the marketing message. Rather, in all three cases I have discussed (and in the rash of advertisements appearing in Australia in 2004–2005), speed, always-on connectivity, and cost-effectiveness were the identified motivational approaches to attract a positive response to the commercials. Indeed, since most ISPs operate like Dodo (reselling wholesaled ADSL from Telstra) cost-effectiveness, speed and reliability were the messages consistently communicated on the ISP websites

that explained the advantage of broadband. If content played any role in these website promotions, it was not “exclusive” or television-like content but, rather, normal internet non-exclusive content—software downloading, game playing, and file-sharing, as well as the end of the “world wide wait” (see for example <http://www.iinet.net.au>; and <http://www.westnet.com.au>, two of Western Australia’s larger ISPs).

Secondly, these advertisements indicated the interrelationship, in business structures, of internet and non-internet business. Primus was one of the most successful of several new entrants to the deregulated telephone market in the late 1990s, utilizing Telstra’s infrastructure for consumer access to wired telephony and internet services (and building its own mobile network). What distinguishes Primus, however, is that it has no access to a cable network for broadband delivery. Optus, the other leading telephony provider, was not offering a DSL services in 2003, (pending at that time a satisfactory commercial deal from Telstra, now achieved in 2004), Optus had an existing, well-regarded cable broadband service provided via its pay-TV hybrid fibre-optic/RF network (Sainsbury, 2003a). Primus could only offer DSL technology. Thus Primus must rely on Telstra’s monopoly network. Yet, while utilizing Telstra’s infrastructure for provision of DSL like the hundred or so retail broadband ISPs that do nothing but provide net access, Primus was and still is also attempting to compete at the much more general level as an all-in-one telecommunications carrier by offering bundled fixed and mobile telephone, with internet service. Here, then, we see how a bundle, in which a Primus phone connection and DSL access work together, improves Primus’ profitability by permitting phone calls to be made at the same time. Always-on connectivity is, therefore, as much an advantage for a provider as for a customer. Similar arrangements also underpin Telstra’s approach, with the added benefit for Telstra of its capacity to offer links to pay television. (Optus also agreed in 2003 that most of its internet subscription business is now part of phone-internet bundles: Sainsbury, 2003b; and, as with Telstra, benefits from phone and pay-TV bundling, AAP, 2003a).

Finally, only the first part of the Telstra campaign operated in anything but a pragmatic register. Other television advertisements (and most, if not all, of the related print and web-based advertising for broadband), focused on definable, current advantages such as speed, connectivity, and price, and eschewed broader visions of the power of the internet and information technology that might inspire or even bedazzle consumers. Oddly enough, Telstra’s advertisement was similar to that of BT (British Telecom), another former-national monopoly provider that dominates its market because of control of local exchanges which must be enabled for DSL. This “high-profile campaign . . . revolved around the notion that there is so much content available on broadband—including dragons, pigs on motorbikes and Jarvis Cocker up a lamppost—that it burst the fat pipe and escaped onto the streets of London” (Sturgeon, 2002). While no doubt reflecting the greater marketing budget of

such incumbent, dominant telecommunication companies, the similarity also suggests that since these companies benefit from an overall increase in broadband use, through their wholesale businesses, they are also conscious of the value of creating a general sense of enthusiasm for broadband, as well as specific arrangements relating to their own retail product line. These questions of how to typify the customers for broadband become particularly significant as I now turn to consider the second case, government policy.

### 3. POLICY FOR BROADBAND DEVELOPMENT

Governments around the world have, in one way or another, been heavily involved in the promotion of broadband technologies. In Australia, two key groups have been at work to consider these technologies and to promote a greater attention to them within government and in society generally. It was reported, by the Broadband Services Expert Group (BSEG), that “we see communications networks as a platform supporting, social interaction, education, health and government services, business relations, and our communications with the world”; that “During the next decade, the existing telecommunications network and broadband cable networks currently being established in major metropolitan areas will evolve to offer a range of interactive information and enhanced communication services”; that “Different technologies will be chosen for different areas, depending on the terrain, population density, the coverage required, and the type of service being delivered”; that rural and urban centers would become interlinked and that “Broadband services will probably be a key medium within our social and economic life within ten years” (from Chapter 1, and Chapter 4). Clearly, this committee believed that the interactivity enabled by broadband is critical for the national interest, as defined by Australia’s place in an international environment. Using a metaphor uniquely suited to a land of beaches and ocean waves, it asserted: “Whether Australia catches the ‘next wave’ is up to Australians. If we are to remain internationally competitive, we must be willing to make the changes that will keep us at the forefront of new information and communication services” (Chapter 3).

Another committee (Broadband Advisory Group—BAG) demanded that attention be paid to broadband because “Broadband communications technologies can deliver substantial economic and social benefits to Australia. They reduce the constraint of distance and greatly increase the quality of communications in many sectors. Their defining characteristics (fast, always-on) enable a paradigm shift in the way people or resources (such as computers) interrelate. In short, broadband technologies can transform the way people live, work and do business” (p. 1). This committee argued that “Broadband networks are a platform for enhancing social, cultural and national cohesion” (p. 6), again, with particular reference to rural and regional Australia. This

committee also indicated that, in future, health, education and government would operate quite differently when broadband becomes widespread (p. 1). Recognizing the diversity of technologies and geographies, the committee mandates an approach that explores all options, both wired and wireless. And, as with the first report that I cited, this committee believes Australia is compelled to move quickly on broadband because of the economic imperatives—“Broadband will be the roads and railways of the 21st century” and “if we lose momentum, we may be left behind in the wake of countries whose policy makers are enthusiastically embracing these emerging technologies” (p. 5; see also p. 32).

What I have deliberately avoided revealing is that these reports are nearly a decade apart in age. BAG’s *Australia’s Broadband Connectivity* was released in January 2003; BSEG’s *Networking Australia’s Future* dates from 1994. And, inevitably, there are some differences: not least that the internet is barely mentioned in 1994, there is much more emphasis on direct government intervention through funding, and the “user/producer” plays a more significant role than the “consumer” in the possibilities of network content development. Yet the degree of consensus between these groups is significant; and the language is almost identical, especially in the way that both reports express that indefinable sense of optimism mixed with fear—of opportunity and threat—that seems to have accompanied most of the policy documents and debates about the internet and related services over the past decade or more (see Allen, 2001; Allen & Long, 2004).

Similar language can be found in the “global” policy discussions and documents that are entwined with national policy formation. A recent ITU survey began by proclaiming:

The development of broadband networks and services is a key issue for governments around the world. Broadband services are underpinning the development of e-commerce, and access to bandwidth at globally competitive prices is an increasingly important determinant of competitiveness in the global knowledge economy. Policies that encourage the provision of affordable broadband access to a nation’s firms can put them ahead of global competitors. Those that fail to do so risk condemning their economies to secondary or subordinate roles. Access to broadband networks and services can also make important contributions to the quality of life, in terms of education, health services and social inclusion.

(Houghton & Morris, 2001)

This persistent theme, combining hopefulness with a dash of fearfulness, can be found elsewhere, too. In 1993, Mitch Kapor contributed a telling piece for the third issue of *Wired*, that neon bible of the optimistic digerati. Kapor, an early and consistent advocate for the value of a particular kind of broadband

networking, based on (indeed no different to) the internet as conceived by him and his Electronic Frontiers co-settlers, he wrote:

First the visionaries sketched it out, then the computer literati caught on. Now the mainstream media is hyping it to the masses: a seamless high-speed network carrying voice, data, and video services to everyone. This information highway, we are told, will be used as a pipeline to bring an expanded universe of information and entertainment into the home and the workplace. . . .

This dream has been promoted extensively, but until recently little visible progress has been made toward its realization. In the past, political gridlock has snarled telephone companies, newspaper publishers, cable television operators, and other potential players in lengthy and fruitless congressional and court battles. A justifiable cynicism developed to fill the gap between vision and reality.

(Kapoor, 1993)

Current thinking, at least in the words of one *Wired* contributor, is rather different:

Ten years from now, when every PalmPilot can display video, a webcam is built into every monitor, and full-screen clips are commonly sent as e-mail attachments, the broadband metamorphosis will be complete. At that time, the egalitarian Net will be a distant memory—but no one will care. Users won't reminisce about the equalizing effect of 28.8 modems any more than car drivers yearn for a time when everyone had to drive equally slowly, because dirt roads hadn't been paved with asphalt. The free ride online is over; but the ride ahead will more than compensate for anything we've lost. The Net is dead. Long live the Net.

(Platt, 2001)

Perhaps the most clear statement of the environment into which policy-makers are now venturing again, with a similar mindset to the mid-1990s, is from the most comprehensive research report on broadband to date (at least in relation to the U.S.A.), *Broadband: Bringing home the bits*:

Broadband, the darling of techno-sophisticates and an object of interest to a growing number of politicians and government officials, as well as to the general public, is often misunderstood. The term itself, originating in the characterization of a communications channel's capacity (in contrast to narrowband), has come to be used as, among other things, a marketer's label for advanced cable television service, the 21st-century incarnation of the early 1990s "information superhighway", and one

element of the next stage in the development of the internet. Broadband has been a beacon for investors and a stimulus for entrepreneurs and mainstream businesses, and it has intensified debates about the public interest in information and communications infrastructure. It is as an enhanced means of access to the internet that broadband has begun to have real traction in terms of actual deployment and use, and it is in this sense that the term has become commonly understood. Years of assertions by technology gurus, business executives, and marketers about the potential promise of broadband have given way to a small but rapidly growing U.S. population who are using a first generation of broadband for faster internet access from their homes.

(CSTB, 2001: 43)

Thus we can see that hopes and fears of this kind are not in opposition. They are two expressions of the same underlying quality of engagement with new technology, namely *desire*. And, in Australia, the government has now plunged again into the rhetoric of desire, prominently displaying a discourse of national hopefulness for an internet and ICT-driven economic boom—after a period of relative inactivity in relation to ICT policy-making, coinciding with the dot.com bust (aside from some specific regulatory measures relating to pornography, gambling and, legislation against spam). As the recently departed Minister for Communications stated, in a media release announcing the formation of the National Broadband Strategy Implementation Group: “All levels of government realise the potential economic and community benefits that broadband can deliver” (Alston, 2003b).

The key themes within current Australian policy regarding broadband remain as they were in the 1990s (Allen, 2001). The government, perhaps even more than in the 1990s, emphasizes that it will not invest in networks directly—except in those special cases concerning research prototypes and to manage rural and regional political pressure. Thus, as explained in detail in the BAG report, the strategy to be pursued in the coming years involves a very limited role for the government, intervening only in the case of “market failures” and only then indirectly, by providing information to stimulate demand, or removing impediments to increased supply (BAG, 2003: 17). Indeed, “The principal strategy for the government is, as far as practicable, to rely on the private sector and market interactions as the primary vehicles for investment decisions and innovation” (p. 40; also Estens, 2002: 125 for a similar evocation of current government policy), enabling that strategy through “regulatory certainty” that involves the least possible intervention in the market place except through established pro-competitive arrangements (see Lavey, 2002, on the increased certainty that no regulation might bring).

Instead, the government proposes to play two active roles: first, as a consumer itself, utilizing its massive size as a user of broadband (in concert with

other levels of government both state and local) to drive demand. Thus, the government's policy is not creating and managing the private sector so much as leaping in and controlling it from "inside", by being the ultimate "consumer" (BAG, 2003: 23–29). This approach has been warmly supported by other levels of government: see for example the recently published Western Australian state government follow up report WATIAC, 2003: xiv). The second role is to, once again, play marketeer. Just as in the 1990s (through events such as Online Australia Day—Allen, 2001), the next few years will see the government promote and market broadband, especially to businesses (as consumers of this service), but also still to everyday residential users. Throughout the BAG report, there are repeated references to the lack of knowledge, the failure of people in Australia to understand the benefits of broadband (pp. 3, 17, 55). Already, the government has begun a high-level promotional campaign in response, having funded what is, effectively, market research into consumer attitudes towards broadband (Alston, 2003a).

Just as the commercial promotion of broadband has increased in recent months, so too has governmental promotion. The National Office of Information Economy (NOIE) website [<http://www.noie.gov.au>] contains not just bureaucratic documents and the policy and political history of broadband development. It also has usable resources to assist users (should they even know that NOIE exists) to consider and utilize broadband more efficiently.

The ideological underpinnings of this policy initiative are critical if we are to make sense of the meanings which might be generated from a refusal to govern and an enthusiasm to consume and to promote. Fundamentally, the policy tries to be both global and national at the same time. While the details of the policy (i.e., what strategies to pursue) are deeply rooted in allegiance to the free market and the globalization of capital, broadband is also constituted as an area of vital *national* significance. The linkage between these two is flagged, clearly, in the hubristic claim that "the Government's main objective for the digital economy should be to stake Australia's claim to a disproportionate share of the benefits of the emerging global economy" (BAG, 2003: 16)—the global economy is an arena, thus, for national competition, even as the globalization of capital further separates the economic environment from any real semblance of national control. Equally, where these technologies self-evidently link citizens around the globe in ways that "nations" find hard to contain, broadband adoption is claimed to be essential for "national cohesion" (p. 16) through bringing Australians more closely together, despite time and spatial separation.

It is worth noting, too, that media reporting in Australia leading up to the formation of BAG, and during the time of its deliberations, and even now tends to be critical of Australia as "lagging" or "slipping" in broadband uptake. This reporting was primarily driven by lobbyists or advocates of the ICT industry. For example, the CEO of Alcatel, in 2001, was reported to have

said “Lack of broadband makes Australia’s claim to be a clever country quite embarrassing” . . . Citing the example of Singapore and Korea, Mr Fowler said it was not too late for Australia to catch up” (Hayes, 2001). Obviously linked to the straitened circumstances of the ICT industry in recent years (and also driven by a critique by both IT advocates, consumers and industry of Telstra’s pricing policies) it is moot as to whether it had a direct effect on government policy or not. In the BAG report, there is a strong emphasis on claiming that international measures of access and participation are not actually relevant and that “In terms of assessing Australia’s performance internationally, there is an additional problem because no international benchmarking relates to the type of goals being envisaged in Australia” (p. 43).

It was as if IT development in relation to broadband is being explained to Australians in terms of international sporting contests—that Australia is in competition with other nations and will be judged; that although Australia keeps being told it is not doing well, the government will try to change the rules, so Australia suddenly can do better! Within this policy discourse all Australians must, implicitly, accept this competitive challenge and attempt to get themselves connected to broadband. According to the government, being Australian once again (as it did in the 1990s) requires a degree of techno-optimism—of sharing the hopeful faith so that national desire can be translated into reality.

The Australian government, as well as considering broadband in 2003, also published a major report that is its guide to ICT industry policy for some years to come. Entitled *Enabling Our Future* (Framework for the Future Steering Committee, 2003), it was not dissimilar to the contributor to *Wired* cited above and to many other examples of quasi-utopian promotion of the new economy, digital revolution and so forth. For example, “Many of the new business opportunities for Australian firms will depend on their capacity to develop new ICT-based products and services which respond to the expanding role of ICT across the economy and society” and “Advanced networks will underpin future business opportunities for the ICT industry, and the way in which ICT is used to achieve national objectives” (p. 5). And, more generally, the report assumes, “The transformative role of ICT in society will continue, and accelerate over the next ten years” (p. 6). Government policy and action in Australia was, I argued in the previous paragraph, constructed spatially around the desire of the nation to be a leader internationally. But the government’s work on broadband was also constructed around *temporal* leadership, of achieving that international success by, rhetorically, arriving at the future faster than other nations. And here, of course, policy becomes even more about selling techno-optimism, establishing a vision of the future whose promises, as shown by the extent to which the 2003 BAG report repeats much of the 1994 BSEG report as if nothing has actually changed, are by their nature unrealizable. They serve instead like the promises made by iPrimus, Telstra, Dodo, and others in building desire for broadband among their customers.



#### 4. TECHNOLOGICAL CHARACTERISTICS OF THE BROADBAND MARKET

Broadband infrastructure in Australia, as in most other countries (with the notable exceptions of Singapore, to some extent, and South Korea), was not initially designed to support the kinds of fast internet-access services for which the term “broadband” is now commonly (if rather misleadingly) used. Rather they were designed for various distinct purposes: the traditional PSTN providing telephone and related telecommunications services (i.e., facsimile and limited EDI for, say, EFTPOS communications between merchants and banks); the provision of pay television (through either cable or satellite); the operation of radio communications; and, more lately, specialized telecommunications control operations in some distributed industries or services (i.e., power generation, water services, railways); the newly emerging third-generation mobile phone networks; and, finally, a telecommunications backbone to integrate all lower-level traffic through a small number of cable and satellite links (see ACA, 2003: 8–11; also AIEAC, 1999: 47–71). This patchwork of technologies cannot realistically support the aspirations of technology pundits and promoters, whether industry or government or the general community, not only because the technologies were not designed for widespread use but were, instead, retro-activated enablers, but also because each technology has developed and tends still to operate within quite distinct market-regulatory structures.

Each of these elements that, collectively, form the potential broadband network in Australia offers, essentially, a technological solution (current or potential) for particular consumers, but only rarely have been designed from scratch as a broadband data service. There are occasional one-off broadband service initiatives, such as the transACT network in the Australian Capital Territory or specific-purpose networks (normally in urban areas) for government departments, individual corporations, or research organizations (so-called “dark fibre”—Pearce, 2002a), and some local cabling of new housing developments. These developments only serve, however, to demonstrate the extent to which the vast majority of the broadband infrastructure has emerged from circumstance, rather than by design. Moreover, since they are normally offered either on the basis of government subsidies, or on full cost-recovery of the creation of the network, they also highlight how substantial, planned development of the highest-quality fibre-optic broadband networks is unlikely to occur, leaving Australia instead with its patchwork networks.

Take, for example, cable services. Unlike the U.S.A., with its long history of cable-based pay television, Australian pay-television services only arrived in the mid-1990s and were principally delivered through a limited cable rollout by Optus and Telstra at a time when, to most people, the internet was not significant (either as a technological service or a cultural formation) and future interactive data services utilizing cable were conceived as a limited addition to producer-distributed television viewing. As Telstra itself states:

The other disadvantage for many Australians is that the Hybrid Fibre Cable Network is not available everywhere in Australia. It was purpose built to economically provide Pay TV services into densely populated residential areas. This means that in most regional centres, country areas and indeed in commercial and business areas in the major cities, it is not available. Simple economic realities have driven the distribution of this service. Nevertheless, some 2.1 million homes are passed by the Hybrid Fibre Cable and have access to Telstra's cable modem service, Telstra BigPond Broadband Cable [<http://www.bigpond.com/broadband/access/cable/howitworks/> Optus' cable network is roughly the same in terms of homes "passed", but only in Sydney, Melbourne and Brisbane.]

The original cable rollout was predicated on the inevitably over-enthusiastic predictions of pay television subscription, including Telstra's aim to cable 4 million homes by 1999; Optus had planned to include Adelaide. Pay television is now, in large part, being delivered by satellite service to those areas not cabled (see CIT, 1999). Moreover, the significant growth in housing development since the early 1990s, whether in inner city redevelopment or in outlying suburbs, means that the percentage of customers who can access cable is decreasing all the time: There are more than seven million households in Australia. Optus and Telstra cable sometimes passes both; while others, only a short distance away, receive neither. Furthermore, the cable network cannot sustain large numbers of users with high data traffic without slowing to a pace that, effectively, renders it the same or worse than dialup. In particular, the network design currently favors asymmetry—the reception of large quantities of data, with limited return traffic, and the network operators (Optus and, especially, Telstra) have utilized conditions of service to limit the capacity of the end-users of cable internet to become producers or servers of content.

The enthusiastic desire for uptake of DSL in 2003 also revealed the difficulties of developing broadband without a broadband network, per se. DSL technologies, of various kinds, rely on the use of different frequencies to carry voice and high-speed data traffic over the same copper wires simultaneously. Two key problems have emerged in Australia as more and more users attempt to access this broadband technology:

- Distance from an exchange to a house that exceeds the reliable / possible operating limit of DSL.
- Existing use of so-called pair-gain technology to provide two phone circuits from one twisted copper pair; a problem normally linked to RIMs (remote integrated multiplexers) either in exchanges or, worse, in roadside pillars) (see Chirgwin, 2002 for a very detailed explanation; Pearce, 2002b).

These problems, to some extent, reflect the original (and, for most consumers) ongoing primary purpose of the twisted copper-pair network: to provide voice telephony. As a Telstra spokesperson stated, in 2002, when the RIM/pair-gain problem began to emerge “these [systems] were built to cope with rising demand for voice rather than data services” (Sainsbury, 2002). The spacing of exchanges reflects the historical development of the telephone system, in some cases dating over 50 years; moreover, the expanding and changing urban topography has meant that cables often run longer distances than is optimum for ADSL telephony.

However significant problems exist in that ADSL may not be available at all. There are over 4,000 exchanges in Australia, of which 987 (pre-dominantly in affluent, inner urban areas) are ADSL enabled. Telstra signalled, towards the end of 2003, that it will not equip any more exchanges past 1000, unless there is significant demand from consumers, and has established (like BT in the United Kingdom) a demand register to permit it to make decisions on which exchanges to upgrade based on a guaranteed level of demand (see AAP, 2003b). Moreover, recent evidence by Telstra to a Senate Committee on telecommunication revealed that “each ADSL-enabled exchange was provisioned to a maximum of seven to eight per cent” (Hayes, 2003). A recent move by Agile to install its own ADSL-enabling equipment in a Telstra exchange might suggest some mitigation of the likely slowdown in ADSL capability, though perhaps this approach will simply transfer responsibility from Telstra to other companies (MacKenzie, 2003). Perhaps most importantly, even if these exchanges are enabled and some solution is found to the distance-from-exchange problem, there may still be upper limits on access depending on the size of the building, and the quality and nature of the CAN [Customer Access Network].

While Telstra rather positively maintained that it “continues to work towards overcoming current technical constraints on high speed internet access resulting from the historic deployment of network electronics” (Telstra, 2003), expert telecommunications analysts Budde Communications have concluded:

We are now in a position where the physical twisted pair copper CAN [Customer Access Network] has almost reached the end of its useful life and it has to be replaced on a massive scale for several reasons including: Bandwidth and distance limitations, cost, age, and rising repair / maintenance costs. Pair Gain Systems (PGS) that were introduced in the 1980s are now reaching the end of their low maintenance lives and because the content in the CAN now includes high-speed data (Internet) to a high percentage of households, PGS now impede the bandwidth required for internet.

(Budde, 2003b)

Satellite communications, a staple for Australians in remote areas, are offered for broadband service only at considerable expense, and often with a limited back-channel capability. While the availability of this kind of delivery technology allows Telstra to respond to criticism about the availability of broadband by asserting that satellite services provide 100% coverage, in actuality the technology is out of reach of most Australians, even with government subsidies for the most remote areas of country. Wireless developments, whether through mobile telephony spectrum, dedicated wireless, or wi-fi based WLANs, appear experimental at the moment, or limited in their capacity. Moreover, they raise significant regulatory questions, especially when they move from being essentially amateur or research-oriented projects to full-scale commercial services, and are likely to be carefully monitored by the Australian Communications Authority (ACA)—in part to ensure that existing radio spectrum uses do not suffer interference. And, finally, specialized networks (for example used in power generation control) are unlikely to be readily interconnected or used for all but the most limited public access, in light of significant security risks and the potential conflict between network uses.

What can we make of this technological jigsaw? The ACA has theorized, in a recent discussion paper on monitoring and quality assurance for broadband, that what makes broadband distinctive is the separation of the access points to the network, the core network itself, and the services and products available on that network. It represents this position thus:

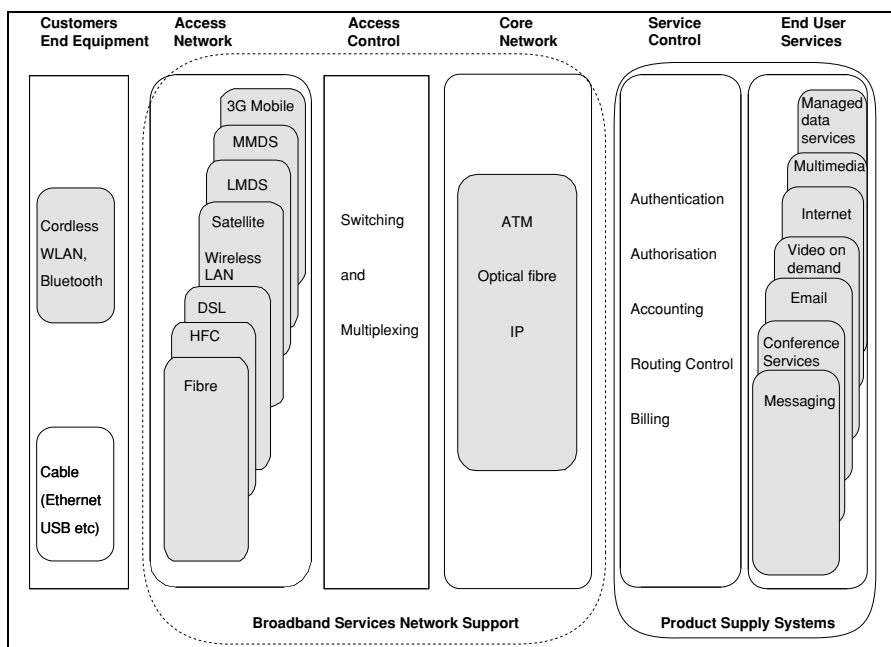

*Broadband Service Delivery Architecture (ACA, 2002: 9)*

However, this theoretical architecture is very much a model that reflects a technologized view of how broadband services might develop, and does not reflect the operation of these technologies in a commercial environment, especially one in which one company (Telstra) exercises significant control over pricing, availability, and services of all manner of telecommunications and related services. In particular, this model does not demonstrate how certain network components have developed and now operate in close connection with a primary use that, even if might be said to require broad bandwidth (such as pay-TV), is hardly “broadband” as it is popular understood (fast access to a complex array of data services and interactions, such as the internet). Crucially, there has been all but no broadband development for the purposes of broadband because the investment required cannot be recouped, in a mass market, without a traditional “content” package whose ongoing revenues amortize the cost of the service and (in the cases of media) create a fixed audience for on-selling to advertisers.

The weakness of the model can also be seen in the development, in early 2004, of a major argument between Telstra and other broadband retailers concerning the fact that a new entry-level broadband package is being offered by Telstra at a price *below* that which Telstra charges for wholesale distribution. That Telstra’s package was released at the same time as its main rival Optus returned to the broadband service market for the first time in some years only added to speculation concerning Telstra’s motives. Immediate action was taken by the anti-competitive behavior regulator, the ACCC. While the outcome of this latest round of market-technological contestation is not clear (and will be discussed in a future article on this topic), what becomes clear is that any attempt to understand technology outside of commercial and regulatory pressures is impossible.

The model also does not account for the historical dimensions of the internet. The existing primary elements of the broadband network are available only because of, in one case, nearly a century of telephone development which, even as late as the early 1990s, was driven by the needs of voice telephony (hence the problems with the over a million Australians unable to get broadband because of RIM/ voice-only pair gain technology); and, in the other, the peculiar arrangements for the introduction of pay television in Australia. It does not indicate how new network components might emerge, successfully, because it does not identify the service-network linkage noted above: Only where some peculiar circumstance emerges (in, for example, the university sector) can specialized networks be developed for direct cost recovery. Finally, it does not include any real recognition of the regulatory work of bodies such as the ACCC (or indeed of the ACA itself), not only in relation to broadband networking but also such services as pay television which, because of the nexus between television cable just noted, effectively become moves that regulate, in one way or another, broadband service.

The exact same model could be applied to America and would not shed any light on the radical difference in the environment there, in which, with the same kinds of technological realities and possibilities, entirely different challenges develop because of the distinctive regulation of the services and infrastructures of communications, information services and television (see for example Frieden, 2003; Lavey, 2002). Fundamentally, what the particular situation in Australia shows, in relation to the ACA description, is that technology-centred models do not actually describe technology, for technology is embedded in the world of commerce, use, and regulation. It is not distinct from the patterns of interaction between governments, corporations and citizens/consumers but, while having an independent and influential existence, primarily acts as a medium to express the particular arrangement of these three elements in a particular time and place.

#### CONCLUSION

What these cases reveal, when placed together, is that technologies of the internet, such as broadband, are always more than just hardware and software. Such technologies are always the products of social and economic circumstances that, firstly, frame the meanings we make of them and constitute us as particular kinds of users and consumers of them; that secondly, create actual utility from hardware and software by permitting some kinds of services to become products, and not others; and that thirdly, are themselves the carriers of meaning.

The government imagines the “citizen”, that elusive and ideal character of much national policy development and implementation in three ways. The citizen is required to play their part in the development of broadband infrastructure; must be subject to the government’s limited efforts to improve that infrastructure; and be the beneficiary of a future that is, through technological development, much richer and more satisfying than the present. Essentially, since many if not all of the promises made by the current government promoters of broadband cannot be realized for some time (and, implicitly, not until a very large proportion of Australians get broadband), a national duty emerges for the real people who are citizens of this nation. Australians, within this policy framework, must be hopeful for the future—to accept techno-optimistic attitudes that mean they will accept and use broadband services even when there is no apparent, overwhelming need to do so—so as to create a consumer infrastructure into which services might then develop.

Such people must also, of course, be hopeful that the commercial products which are available to them as the actual method to become broadband users will work, for them, in their location, despite the technological difficulties that emerge from a network of broadband networks that was not designed for that purpose. Moreover, the broadband products which are being sold to them are

constituted as much by the existing regulatory and commercial constructs that have created the telephone and pay-television industries which dominate provision of broadband. And in the meantime, the providers themselves are engaged in the production of techno-optimism, but with the very different purpose of selling their specific product to specific groups of consumers. Commercial realities, and differential capacities to access and utilize the technology, mean that not all of these messages about what broadband will do, what it is for, and how it will bring the future closer are quite what the government might have hoped for. Thus, in conclusion, I would suggest that, just as consumer/citizens are choosing from among many different packages and services that provide broadband connectivity, they are also choosing what that particular instance of broadband connectivity means for them. What will actually emerge as the future of broadband will lie in the way these choices are constructed, for consumers, by the confluence of technology, regulation and commerce and which choices, from within this limited set of possibilities, are most successful in the marketplace.

And, within this realm of constrained broadband, governed by the operations of the market and the realities of technological infrastructure, the choices consumer/citizens will make shall influence the development and success of virtual learning environments. Such environments may not, as I indicated at the start of this chapter, depend on high speed. Moreover, the degree to which consumers may or may not imagine that broadband makes the internet more “suitable” for learning than a narrowband network, will depend heavily on the way the “meaning” of broadband develops, guided by government enthusiasms for national adoption of ICTs and service providers’ marketing campaigns. The availability of education online is likely to be partially influenced by the openness of access—across financial and physical constraints, and the “product” itself will need to compete with existing learning opportunities made faster and more constantly available by “always-on” broadband. Thus while more intensive learning environments might seem to fit naturally with the technological capacity of broadband, the regulated, socio-economic, cultural ‘technology’ of broadband may well hold surprise us in how it intersects with the further development of online education.

#### REFERENCES

- AAP. (2003a). Pay TV bundles a success. *Australian—IT News* August 30, 2003.
- AAP. (2003b). Telstra introduces demand register for ADSL rollout. *Sydney Morning Herald*. October 2, 2003.
- ACA (Australian Communications Authority). (2002). *Proposal for Monitoring and Reporting Quality of Service for Broadband and High Data Rate Services*. Accessed at: [http://www.aca.gov.au/aca\\_home/issues\\_for\\_comment/discussion/archive/broadband.rtf](http://www.aca.gov.au/aca_home/issues_for_comment/discussion/archive/broadband.rtf) [1 October 2003].

- AIEAC (Australian Information Economy Advisory Council). (1999). *Bandwidth: National Bandwidth Inquiry*. Canberra: DoCITA [Department of Communications, Information Technology and the Arts].
- Allen, M. (2001). censorship.gov.au: Reviewing Internet censorship in Australia. *AOIR v2 Conference*, Minneapolis, U.S.A. October 2001. Available at: <http://www.curtin.edu.au/home/allen/papers/AllenAOIR2001.doc>.
- Allen, M. & Long, J. (2004). Domesticating the Internet: content regulation, virtual nation-building and the family. In: Goggin, G. (Ed.), *Virtual Nation: The Australian Internet Reader*, Sydney, UNSW Press.
- Alston, R. (2003a). Broadband research grants awarded. *Media Release: Senator the Hon. Richard Alston, Minister for Communications, Information Technology and the Arts*. 13 August 2003. Accessed at: [http://www.noie.gov.edu.au/publications/media\\_releases/2003/Aug/bband.htm](http://www.noie.gov.edu.au/publications/media_releases/2003/Aug/bband.htm) [4 October 2003].
- Alston, R. (2003b). National Broadband Group marks a milestone in broadband strategy. *Media Release: Senator the Hon. Richard Alston, Minister for Communications, Information Technology and the Arts*. 13 August 2003. Accessed at: [http://www.noie.gov.edu.au/publications/media\\_releases/2003/Aug/bband.htm](http://www.noie.gov.edu.au/publications/media_releases/2003/Aug/bband.htm) [4 October 2003].
- BAG (Broadband Advisory Group) (2003). *Australia's Broadband Connectivity*. Canberra: Commonwealth Government of Australia. Accessed at: <http://www.noie.gov.au/publications/NOIE/BAG/report/index.htm> [4 October 2003].
- BSEG (Broadband Services Expert Group) (1994). *Networking Australia's Future*. Canberra: Commonwealth Government of Australia. Accessed at: <http://www.dcita.gov.au/Article/0,,0.1-2.1-4.112166,00.html> [4 October 2003].
- Budde, P. (2003a). *Submission to Senate Inquiry into Competition in Broadband Services*. Accessed at: [http://www.aph.gov.au/Senate/committee/ecita\\_ctte/broadband\\_competition/submissions/sub6.doc](http://www.aph.gov.au/Senate/committee/ecita_ctte/broadband_competition/submissions/sub6.doc) [1 October 2003].
- Budde, P. (2003b). *Submission to the Senate Inquiry into the Australian Telecommunications Network: Telstra CAN—An Analysis*. Accessed at: [http://www.aph.gov.au/Senate/committee/ecita\\_ctte/tele\\_network/submissions/sub150.doc](http://www.aph.gov.au/Senate/committee/ecita_ctte/tele_network/submissions/sub150.doc) [1 October 2003].
- Chirgwin, R. (2002). Pairgain and DSL. Post to *Link* email list. 4 April 2002. Accessed at: <http://mailman.anu.edu.au/pipermail/link/2002-April/017604.html> [1 October 2003].
- CIT. (1999). *Datafile of Asia-Pacific Telecommunications*. Section: satellite, cable and multimedia. CIT Publications. Accessed at: [http://www.lynxtech.com/citpubs/dat/aus\\_d1.htm](http://www.lynxtech.com/citpubs/dat/aus_d1.htm) [1 October 2003].
- CSTB (Computer Science and Telecommunications Board) (2001). *Broadband: Bringing Home the Bits*. Washington DC: National Academy Press. (Available online at: <http://books.nap.edu/html/broadband/>).
- Estens, D. (2002). *Connecting Regional Australia: Report of the Regional Telecommunications Inquiry*. Canberra: Commonwealth of Australia. Accessed at: <http://www.telinquiry.gov.au/rti-report/rti%20report%20text%20f-a%2018.pdf> [4 October 2003].
- Ferguson, I. (2003). Telstra reviews broadband strategy after dumping beyond. *Zdnet Australia*, 5 May 2003. Accessed at: <http://www.zdnet.com.au/newstech/enterprise/story/0,2000048640,20274234,00.htm> [1 October 2003].
- Framework for the Future Steering Committee. (2003). *Enabling our Future: A Framework for the Information and Communications Technology Industry*. Canberra: DoCITA (Department of Communications, Information Technology and the Arts).
- Frieden, R. (2003). Adjusting the horizontal and vertical in telecommunications regulation: a comparison of the traditional and a new layered approach. *Federal Communications Law Journal*. 55.2, 207–250.
- Hayes, S. (2001). Roll out broadband or become a 'backwater'. *Australian* (October 23, 2001), 34.



- Hayes, S. (2003). Telstra caps ADSL expansion. *Australian—IT News* (at *News.com.au*), August 7, 2003.
- Houghton, J. & Morris, P. (2001). *Broadband the Case of Australia* (A Case study for the Regulatory Implications of Broadband Workshop). Geneva: ITU. Accessed at: <http://www.itu.int/osg/spu/ni/broadband/workshop/Australiafinal.pdf> [4 October 2003].
- Kapor, M. (1993). Where is the Digital Highway Really Heading? *Wired*. 1.03. Accessed at: [http://www.wired.com/wired/archive/1.03/kapor.on.nii\\_pr.html](http://www.wired.com/wired/archive/1.03/kapor.on.nii_pr.html) [4 October 2003].
- Lavey, W. G. (2002). Making and keeping regulatory promises. *Federal Communications Law Journal* 55.1, 1–60.
- MacKenzie, K. (2003). Tables turned on ADSL coverage. *Australian—IT News* (at *News.com.au*), 3 October 2003.
- McCarthy, K. (2001). Aussie watchdog slams Telstra ADSL roll-out. *The Register*. 11 September 2001. Accessed at: <http://www.theregister.co.uk/content/archive/21612.html> [1 October 2003].
- McGrath, C. (2002). Optus, Foxtel share deal approved. *The World Today* (*ABC Radio*), 13 November 2002. Accessed at: <http://www.abc.net.au/worldtoday/s726019.htm> [1 October 2003].
- Pearce, J. (2002a). Dark fibre broadband deal to light Aussie research. *ZDNet Australia* 14 October 2002. Accessed at: <http://www.zdnet.com.au/newstech/enterprise/story/0,2000048640,20269052,00.htm> [1 October 2003].
- Pearce, J. (2002b). Telstra downplays broadband demand. *ZDNet Australia*, 25 November 2002. Accessed at: <http://www.zdnet.com.au/newstech/communications/story/0,2000048620,20270166-1,00.htm> [1 October 2003].
- Platt, C. (2001). The future will be fast but not free. *Wired*. 9.05. Accessed at: [http://www.wired.com/wired/archive/9.05/broadband\\_pr.html](http://www.wired.com/wired/archive/9.05/broadband_pr.html) [4 October 2003].
- Sainsbury, M. (2002). Telstra to fix ADSL problems, *Australian—IT News* (at *News.com.au*), November 12, 2002.
- Sainsbury, M. (2003a). Optus finalises Telstra DSL deal. *Australian—IT News* (July 17, 2003).
- Sainsbury, Michael (2003b). Telstra's big push for broadband. *Australian—IT News* (May 13, 2003).
- Sturgeon, W. (2002). Reviewing 2002—A year in broadband (part 3). *Silicon.com*, 20 December 2002. Accessed at: <http://www.silicon.com/news/500016/1/1036874.html> [1 October 2003].
- Telstra. (2003). *Submission to the Senate Inquiry into the Australian Telecommunications Network*. Accessed at: [http://www.aph.gov.au/Senate/committee/ecita\\_ctte/tele\\_network/submissions/sub107.doc](http://www.aph.gov.au/Senate/committee/ecita_ctte/tele_network/submissions/sub107.doc) [1 October 2003].
- Turner, A. (2003). Connection numbers rise but uptake slows. *The Age* (25 March 2003).
- Velde, D. (2002). Telstra launches campaign to sell Foxtel bundle. *B&T*, 20 November 2002. Access at : <http://www.bandt.com.au/articles/39/0C012D39.asp> [1 October 2003].
- WATIAC (WA Technology and Industry Advisory Council) (2003). *Enabling Connected Community: Developing Broadband Infrastructure and Services in Metropolitan Western Australia*. Perth. Accessed at: <http://www.wa.gov.au/tiac/broadband/broadband.pdf> [4 October 2003].

## Chapter 62: The Matrix, or, the Two Sides of Perversion\*

SLAVOJ ŽIŽEK

*Institute for Sociology and Philosophy, University of Jübiliana*

When I saw *The Matrix* at a local theatre in Slovenia, I had the unique opportunity of sitting close to the ideal spectator of the film—namely, to an idiot. A man in the late 20s at my right was so immersed in the film that he all the time disturbed other spectators with loud exclamations, like “My God, wow, so there is no reality!” . . . I definitely prefer such naive immersion to the pseudo-sophisticated intellectualist readings that project into the film the refined philosophical or psychoanalytic conceptual distinctions.<sup>1</sup>

It is nonetheless easy to understand this intellectual attraction of *The Matrix*: is it not that *The Matrix* is one of the films which function as a kind of Rorschach test [<http://rorschach.test.at/>] setting in motion the universalized process of recognition, like the proverbial painting of God which seems always to stare directly at you, from wherever you look at it—practically every orientation seems to recognize itself in it? My Lacanian friends are telling me that the authors must have read Lacan; the Frankfurt School partisans see in the *Matrix* the extrapolated embodiment of *Kulturindustrie*, the alienated-reified social Substance (of the Capital) directly taking over, colonizing our inner life itself, using us as the source of energy; New Agers see in the source of speculations on how our world is just a mirage generated by a global mind embodied in the World Wide Web. This series goes back to Plato’s *Republic*: does *The Matrix* not repeat exactly Plato’s dispositif of the cave (ordinary humans as prisoners, tied firmly to their seats and compelled to watch the shadowy performance of (what they falsely consider to be) reality? The important difference, of course, is that when some individuals escape their cave predicament and step out to the surface of the Earth, what they find there is no longer the bright surface illuminated by the rays of the Sun, the supreme God, but the desolate “desert of the real”. The key opposition is here the one between Frankfurt School and Lacan: should we historicize the *Matrix* into the metaphor of the Capital that colonized culture and subjectivity, or is it the reification of the symbolic order as such? However, what if this very alternative is false? What if the virtual character of the symbolic order “as such” is the very condition of historicity?

\*Reprinted with permission of the Author.

## 1. REACHING THE END OF THE WORLD

Of course, the idea of the hero living in a totally manipulated and controlled artificial universe is hardly original: *The Matrix* just radicalizes it by bringing in virtual reality (VR). The point here is the radical ambiguity of the VR with regard to the problematic of iconoclasm. On the one hand, VR marks the radical reduction of the wealth of our sensory experience to—not even letters, but—the minimal digital series of 0 and 1, of passing and non-passing of the electrical signal. On the other hand, this very digital machine generates the “simulated” experience of reality which tends to become indiscernable from the “real” reality, with the consequence of undermining the very notion of “real” reality—VR is thus at the same time the most radical assertion of the seductive power of images.

Is not the ultimate American paranoid fantasy that of an individual living in a small idyllic Californian city, a consumerist paradise, who suddenly starts to suspect that the world he lives in is a fake, a spectacle staged to convince him that he lives in a real world, while all people around him are effectively actors and extras in a gigantic show? The most recent example of this is Peter Weir’s *The Truman Show* (1998), with Jim Carrey playing the small town clerk who gradually discovers the truth that he is the hero of a 24-hour permanent TV show: his hometown is constructed on a gigantic studio set, with cameras following him permanently. Sloterdijk’s “sphere” is here literally realized, as the gigantic metal sphere that envelopes and isolates the entire city. This final shot of *The Truman Show* may seem to enact the liberating experience of breaking out from the ideological suture of the enclosed universe into its outside, invisible from the ideological inside. However, what if it is precisely this “happy” denouement of the film (let us not forget: applauded by the millions around the world watching the last minutes of the show), with the hero breaking out and, as we are led to believe, soon to join his true love (so that we have again the formula of the production of the couple!), that is ideology at its purest? What if ideology resides in the very belief that, outside the closure of the finite universe, there is some “true reality” to be entered?<sup>2</sup>

Among the predecessors of this notion, it is worth mentioning Phillip Dick’s *Time Out of Joint* (1959), in which a hero living a modest daily life in a small idyllic Californian city of the late 50s, gradually discovers that the whole town is a fake staged to keep him satisfied. . . . The underlying experience of *Time Out of Joint* and of *The Truman Show* is that the late capitalist consumerist Californian paradise is, in its very hyper-reality, in a way unreal, substanceless, deprived of the material inertia. So it is not only that Hollywood stages a semblance of real life deprived of the weight and inertia of materiality—in the late capitalist consumerist society, “real social life” itself somehow acquires the features of a staged fake, with our neighbors behaving in “real” life as stage actors and extras. . . . The ultimate truth of the capitalist utilitarian

de-spiritualized universe is the de-materialization of the “real life” itself, its reversal into a spectral show.

In the realm of science-fiction, one should mention also Brian Aldiss’ *Starship*, in which members of a tribe live in a closed world of a tunnel in a giant starship, isolated from the rest of the ship by thick vegetation, unaware that there is a universe beyond; finally, some children penetrate the bushes and reach the world beyond, populated by other tribes. Among the older, more “naive” forerunners, one should mention George Seaton’s *36 Hours*, the film from the early 60s about an American officer (James Garner) who knows all the plans for the D Day invasion of Normandy and is accidentally taken prisoner by Germans just days before the invasion. Since he is taken prisoner unconscious, in a blast of explosion, the Germans quickly construct for him a replica of small American military hospital resort, trying to convince him that he now lives in 1950s, that America won the war and that he has lost memory for the last 6 years—the idea being that he would tell all about the invasion plans for the Germans to prepare themselves; of course, cracks soon appear in this carefully constructed edifice . . . (Did not Lenin himself, in the last 2 years of his life, lived in an almost similar controlled environment, in which, as we now know, Stalin had printed for him a specially prepared one copy of *Pravda*, censored of all news that would tell Lenin about the political struggles going on, with the justification that Comrade Lenin should take a rest and not be excited by unnecessary provocations.)

What lurks in the background is, of course, the pre-modern notion of “arriving at the end of the universe”: in the well-known engravings, the surprised wanderers approach the screen/curtain of heaven, a flat surfaced with painted stars on it, pierce it and reach beyond—it is exactly this that happens at the end of *The Truman Show*. No wonder that the last scene of the film, when Truman steps up the stairs attached to the wall on which the “blue sky” horizon is painted and opens up there the door, has a distinct Magrittean touch: is it not that, today, this same sensitivity is returning with a vengeance? Do works like Syberberg’s *Parsifal*, in which the infinite horizon is also blocked by the obviously “artificial” rear-projections, not signal that the time of the Cartesian infinite perspective is running out, and that we are returning to a kind of renewed medieval pre-perspective universe? Fred Jameson perspicuously drew attention to the same phenomenon in some of the Raymond Chandler’s novels and Hitchcock’s films: the shore of the Pacific ocean in *Farewell, My Lovely* functions as a kind of “end/limit of the world”, beyond which there is an unknown abyss; and it is similar with the vast open valley that stretches out in front of the Mount Rushmore heads when, on the run from their pursuers, Eva-Marie Saint and Cary Grant reach the peak of the monument, and into which Eva-Marie Saint almost falls, before being pulled up by Cary Grant; and one is tempted to add to this series the famous battle scene at a bridge on the Vietnamese/Cambodian frontier in *Apocalypse Now*, where the space beyond the bridge is experienced as the “beyond of our known universe”.

And how not to recall that the idea that our Earth is not the planet floating in the infinite space, but a circular opening, hole, within the endless compact mass of eternal ice, with the sun in its center, was one of the favorite Nazi pseudo-scientific fantasies (according to some reports, they even considered putting some telescopes on the Sylt islands in order to observe America)?

## 2. THE “REALLY EXISTING” BIG OTHER

What, then, is the Matrix? Simply the Lacanian “big Other”, the virtual symbolic order, the network that structures reality for us. This dimension of the “big Other” is that of the constitutive alienation of the subject in the symbolic order: the big Other pulls the strings, the subject does not speak, he “is spoken” by the symbolic structure. In short, this “big Other” is the name for the social Substance, for all that on account of which the subject never fully dominates the effects of his acts, i.e., on account of which the final outcome of his activity is always something else with regard to what he aimed at or anticipated. However, it is here crucial to note that, in the key chapters of Seminar XI, Lacan struggles to delineate the operation that follows alienation and is in a sense its counterpoint, that of separation: alienation *IN* the big Other is followed by the separation *FROM* the big Other. Separation takes place when the subject takes note of how the big Other is in itself inconsistent, purely virtual, “barred”, deprived of the Thing—and fantasy is an attempt to fill out this lack of the Other, not of the subject, i.e., to (re)constitute the consistency of the big Other. For that reason, fantasy and paranoia are inherently linked: paranoia is at its most elementary a belief into an “Other of the Other”, into another Other who, hidden behind the Other of the explicit social texture, programs (what appears to us as) the unforeseen effects of social life and thus guarantees its consistency: beneath the chaos of market, the degradation of morals, etc., there is the purposeful strategy of the Jewish plot. . . . This paranoid stance acquired a further boost with today’s digitalization of our daily lives: when our entire (social) existence is progressively externalized—materialized in the big Other of the computer network, it is easy to imagine an evil programmer erasing our digital identity and thus depriving us of our social existence, turning us into non-persons.

Following the same paranoid twist, the thesis of *The Matrix* is that this big Other is externalized in the really existing mega-computer. There is—there *HAS* to be—a Matrix because “things are not right, opportunities are missed, something goes wrong all the time”, i.e., the film’s idea is that it is so because there is the Matrix that obfuscates the “true” reality that is behind it all. Consequently, the problem with the film is that it is *NOT* “crazy” enough, because it supposes another “real” reality behind our everyday reality sustained by the Matrix. However, to avoid the fatal misunderstanding: the inverse notion that “all there is is generated by the Matrix”, that there is *NO*

ultimate reality, just the infinite series of virtual realities mirroring themselves in each other, is no less ideological. (In the sequels to *The Matrix*, we shall probably learn that the very “desert of the real” is generated by (another) matrix.) Much more subversive than this multiplication of virtual universes would have been the multiplication of realities themselves—something that would reproduce the paradoxical danger that some physicians see in recent high-accelerator experiments. As is well known, scientists are now trying to construct the accelerator capable of smashing together the nuclei of very heavy atoms at nearly the speed of light. The idea is that such a collision will not only shatter the atom’s nuclei into their constituent protons and neutrons, but will pulverize the protons and neutrons themselves, leaving a “plasma”, a kind of energy soup consisting of loose quark and gluon particles, the building blocks of matter that have never before been studied in such a state, since such a state only existed briefly after the Big Bang. However, this prospect has given rise to a nightmarish scenario: what if the success of this experiment will create a doomsday machine, a kind of world-devouring monster that will with inexorable necessity annihilate the ordinary matter around itself and thus abolish the world as we know it? The irony of it is that this end of the world, the disintegration of the universe, would be the ultimate irrefutable proof that the tested theory is true, since it would suck all matter into a black hole and then bring about a new universe, i.e., perfectly recreate the Big Bang scenario.

The paradox is thus that both versions—(1) a subject freely floating from one to another VR, a pure ghost aware that every reality is a fake; (2) the paranoid supposition of the real reality beneath the Matrix—is false: they both miss the Real. The film is not wrong in insisting that there IS a Real beneath the VR simulation—as Morpheus puts to Neo when he shows him the ruined Chicago landscape: “Welcome to the desert of the real”. However, the Real is not the “true reality” behind the virtual simulation, but the void which makes reality incomplete/inconsistent, and the function of every symbolic Matrix is to conceal this inconsistency—one of the ways to effectuate this concealment is precisely to claim that, behind the incomplete/inconsistent reality we know, there is another reality with no deadlock of impossibility structuring it.

### 3. “THE BIG OTHER DOESN’T EXIST”

“Big Other” also stands for the field of common sense at which one can arrive after free deliberation; philosophically, its last great version is Habermas’s communicative community with its regulative ideal of agreement. And it is this “big Other” that progressively disintegrates today. What we have today is a certain radical split: on the one hand, the objectivized language of experts and scientists which can no longer be translated into the common language

accessible to everyone, but is present in it in the mode of fetishized formulas that no one really understands, but which shape our artistic and popular imaginary (Black Hole, Big Bang, Superstrings, Quantum Oscillation . . .). Not only in natural sciences, but also in economy and other social sciences, the expert jargon is presented as an objective insight with which one cannot really argue, and which is simultaneously untranslatable into our common experience. In short, the gap between scientific insight and common sense is unbridgeable, and it is this very gap that elevates scientists into the popular cult-figures of the “subjects supposed to know” (the Stephen Hawking phenomenon). The strict obverse of this objectivity is the way in which, in the cultural matters, we are confronted with the multitude of life-styles which one cannot translate into each other: all we can do is secure the conditions for their tolerant coexistence in a multicultural society. The icon of today’s subject is perhaps the Indian computer programmer who, during the day, excels in his expertise, while in the evening, upon returning home, he lights the candle to the local Hindu divinity and respects the sacredness of the cow. This split is perfectly rendered in the phenomenon of cyberspace. Cyberspace was supposed to bring us all together in a Global Village; however, what effectively happens is that we are bombarded with the multitude of messages belonging to inconsistent and incompatible universes—instead of the Global Village, the big Other, we get the multitude of “small others”, of tribal particular identifications at our choice. To avoid a misunderstanding: Lacan is here far from relativizing science into just one of the arbitrary narratives, ultimately on equal footing with Politically Correct myths, etc.: science DOES “touch the Real”, its knowledge IS “knowledge in the Real”—the deadlock resides simply in the fact that scientific knowledge cannot serve as the SYMBOLIC “big Other”. The gap between modern science and the Aristotelian common sense philosophical ontology is here insurmountable: it emerges already with Galileo, and is brought to extreme in quantum physics, where we are dealing with the rules/laws which function, although they cannot ever be retranslated into our experience of representable reality.

The theory of risk society and its global reflexivization is right in its emphasis one how, today, we are at the opposite end of the classical Enlightenment universalist ideology which presupposed that, in the long run, the fundamental questions can be resolved by way of the reference to the “objective knowledge” of the experts: when we are confronted with the conflicting opinions about the environmental consequences of a certain new product (say, of genetically modified vegetables), we search in vain for the ultimate expert opinion. And the point is not simply that the real issues are blurred because science is corrupted through financial dependence on large corporations and state agencies—even in themselves, sciences cannot provide the answer. Ecologists predicted 15 years ago the death of our forests—the problem is now a too large increase of wood. . . . Where this theory of risk society is too short is in emphasizing the irrational predicament into which this puts us, common

subjects: we are again and again compelled to decide, although we are well aware that we are in no position to decide, that our decision will be arbitrary. Ulrich Beck and his followers refer here to the democratic discussion of all options and consensus building; however, this does not resolve the immobilizing dilemma: why should the democratic discussion in which the majority participates lead to better result, when, cognitively, the ignorance of the majority remains. The political frustration of the majority is thus understandable: they are called to decide, while, at the same time, receiving the message that they are in no position effectively to decide, i.e., to objectively weigh the pros and cons. The recourse to “conspiracy theories” is a desperate way out of this deadlock, an attempt to regain a minimum of what Fred Jameson calls “cognitive mapping”.

Jodi Dean<sup>3</sup> drew attention to a curious phenomenon clearly observable in the “dialogue of the mutes” between the official (“serious”, academically institutionalized) science and the vast domain of so-called pseudo-sciences, from ufology to those who want to decipher the secrets of the pyramids: one cannot but be struck by how it is the official scientists who proceed in a dogmatic dismissive way, while the pseudo-scientists refer to facts and argumentation deprived of the common prejudices. Of course, the answer will be here that established scientists speak with the authority of the big Other of the scientific Institution; but the problem is that, precisely, this scientific big Other is again and again revealed as a consensual symbolic fiction. So when we are confronted with conspiracy theories, we should proceed in a strict homology to the proper reading of Henry James’ *The Turn of the Screw*: we should neither accept the existence of ghosts as part of the (narrative) reality nor reduce them, in a pseudo-Freudian way, to the “projection” of the heroine’s hysterical sexual frustrations. Conspiracy theories, of course, are not to be accepted as “fact”—however, one should also not reduce them to the phenomenon of modern mass hysteria. Such a notion still relies on the “big Other”, on the model of “normal” perception of shared social reality, and thus does not take into account how it is precisely this notion of reality that is undermined today. The problem is not that ufologists and conspiracy theorists regress to a paranoid attitude unable to accept (social) reality; the problem is that this reality itself is becoming paranoid. Contemporary experience again and again confronts us with situations in which we are compelled to take note of how our sense of reality and normal attitude toward it is grounded in a symbolic fiction, i.e., how the “big Other” that determines what counts as normal and accepted truth, what is the horizon of meaning in a given society, is in no way directly grounded in “facts” as rendered by the scientific “knowledge in the real”. Let us take a traditional society in which modern science is not yet elevated into the Master-discourse: if, in its symbolic space, an individual advocates propositions of modern science, he will be dismissed as “madman”—and the key point is that it is not enough to say that he is not “really mad”, that it is merely the narrow ignorant society which puts him in



this position—in a certain way, being treated as a madman, being excluded from the social big Other, effectively EQUALS being mad. “Madness” is not the designation which can be grounded in a direct reference to “facts” (in the sense that a madman is unable to perceive things the way they really are, since he is caught in his hallucinatory projections), but only with regard to the way an individual relates to the “big Other”. Lacan usually emphasizes the opposite aspect of this paradox: “the madman is not only a beggar who thinks he is a king, but also a king who thinks he is a king”, i.e., madness designates the collapse of the distance between the Symbolic and the Real, an immediate identification with the symbolic mandate; or, to take his other exemplary statement, when a husband is pathologically jealous, obsessed by the idea that his wife sleeps with other men, his obsession remains a pathological feature even if it is proven that he is right and that his wife effectively sleeps with other men. The lesson of such paradoxes is clear: pathological jealousy is not a matter of getting the facts false, but of the way these facts are integrated into the subject’s libidinal economy. However, what one should assert here is that the same paradox should also be performed as it were in the opposite direction: the society (its socio-symbolic field, the big Other) is “sane” and “normal” even when it is proven factually wrong. (Maybe, it was in this sense that the late Lacan designated himself as “psychotic”: he effectively was psychotic insofar as it was not possible to integrate his discourse into the field of the big Other.)

One is tempted to claim, in the Kantian mode, that the mistake of the conspiracy theory is somehow homologous to the “paralogism of the pure reason,” to the confusion between the two levels: the suspicion (of the received scientific, social, etc. common sense) as the formal methodological stance, and the positivation of this suspicion in another all-explaining global para-theory.

#### 4. SCREENING THE REAL

From another standpoint, the Matrix also functions as the “screen” that separates us from the Real, that makes the “desert of the real” bearable. However, it is here that we should not forget the radical ambiguity of the Lacanian Real: it is not the ultimate referent to be covered/gentrified/domesticated by the screen of fantasy—the Real is also and primarily the screen itself as the obstacle that always-already distorts our perception of the referent, of the reality out there. In philosophical terms, therein resides the difference between Kant and Hegel: for Kant, the Real is the noumenal domain that we perceive “schematized” through the screen of transcendental categories; for Hegel, on the contrary, as he asserts exemplarily in the Introduction to his Phenomenology, this Kantian gap is false. Hegel introduces here THREE terms: when a screen intervenes between ourselves and the Real, it always generates a notion of what is In-itself, beyond the screen (of the appearance), so that the gap

between appearance and the In-itself is always-already “for us”. Consequently, if we subtract from the Thing the distortion of the Screen, we lose the Thing itself (in religious terms, the death of Christ is the death of the God in himself, not only of his human embodiment)—which is why, for Lacan, who follows here Hegel, the Thing in itself is ultimately the gaze, not the perceived object. So, back to the Matrix: the Matrix itself is the Real that distorts our perception of reality.

A reference to Levi-Strauss’s exemplary analysis, from his *Structural Anthropology*, of the spatial disposition of buildings in the Winnebago, one of the Great Lake tribes, might be of some help here. The tribe is divided into two sub-groups (“moieties”), “those who are from above” and “those who are from below”; when we ask an individual to draw on a piece of paper, or on sand, the ground-plan of his/her village (the spatial disposition of cottages), we obtain two quite different answers, depending on his/her belonging to one or the other sub-group. Both perceive the village as a circle; but for one sub-group, there is within this circle another circle of central houses, so that we have two concentric circles, while for the other sub-group, the circle is split into two by a clear dividing line. In other words, a member of the first sub-group (let us call it “conservative-corporatist”) perceives the ground-plan of the village as a ring of houses more or less symmetrically disposed around the central temple, whereas a member of the second (“revolutionary-antagonistic”) sub-group perceives his/her village as two distinct heaps of houses separated by an invisible frontier . . .<sup>4</sup> The central point of Levi-Strauss is that this example should in no way entice us into cultural relativism, according to which the perception of social space depends on the observer’s group-belonging: the very splitting into the two “relative” perceptions implies a hidden reference to a constant—not the objective, “actual” disposition of buildings but a traumatic kernel, a fundamental antagonism the inhabitants of the village were unable to symbolize, to account for, to “internalize”, to come to terms with, an imbalance in social relations that prevented the community from stabilizing itself into a harmonious whole. The two perceptions of the ground-plan are simply two mutually exclusive endeavors to cope with this traumatic antagonism, to heal its wound via the imposition of a balanced symbolic structure. Is it necessary to add that things stand exactly the same with respect to sexual difference: “masculine” and “feminine” are like the two configurations of houses in the Levi-Straussian village? And in order to dispel the illusion that our “developed” universe is not dominated by the same logic, suffice it to recall the splitting of our political space into Left and Right: a Leftist and a Rightist behave exactly like members of the opposite sub-groups of the Levi-Straussian village. They not only occupy different places within the political space; each of them perceives differently the very disposition of the political space—a Leftist as the field that is inherently split by some fundamental antagonism, a Rightist as the organic unity of a Community disturbed only by foreign intruders.

However, Levi-Strauss makes here a further crucial point: since the two sub-groups nonetheless form one and the same tribe, living in the same village, this identity somehow has to be symbolically inscribed—how, if the entire symbolic articulation, all social institutions, of the tribe is not neutral, but is overdetermined by the fundamental and constitutive antagonistic split? By what Levi-Strauss ingeniously calls the “zero-institution”, a kind of institutional counterpart to the famous mana, the empty signifier with no determinate meaning, since it signifies only the presence of meaning as such, in opposition to its absence: a specific institution which has no positive, determinate function—its only function is the purely negative one of signaling the presence and actuality of social institution as such, in opposition to its absence, to pre-social chaos. It is the reference to such a zero-institution that enables all members of the tribe to experience themselves as such, as members of the same tribe. Is, then, this zero-institution not ideology at its purest, i.e., the direct embodiment of the ideological function of providing a neutral all-encompassing space in which social antagonism is obliterated, in which all members of society can recognize themselves? And is the struggle for hegemony not precisely the struggle for how will this zero-institution be overdetermined, colored by some particular signification? To provide a concrete example: is not the modern notion of nation such a zero-institution that emerged with the dissolution of social links grounded in direct family or traditional symbolic matrixes, i.e., when, with the onslaught of modernization, social institutions were less and less grounded in naturalized tradition and more and more experienced as a matter of “contract”.<sup>5</sup> Of special importance is here the fact that national identity is experienced as at least minimally “natural”, as a belonging grounded in “blood and soil”, and as such opposed to the “artificial” belonging to social institutions proper (state, profession. . .): pre-modern institutions functioned as “naturalized” symbolic entities (as institutions grounded in unquestionable traditions), and the moment institutions were conceived as social artifacts, the need arose for a “naturalized” zero-institution that would serve as their neutral common ground.

And, back to sexual difference, I am tempted to risk the hypothesis that, perhaps, the same logic of zero-institution should be applied not only to the unity of a society, but also to its antagonistic split: what if sexual difference is ultimately a kind of zero-institution of the social split of the humankind, the naturalized minimal zero-difference, a split that, prior to signaling any determinate social difference, signals this difference as such? The struggle for hegemony is then, again, the struggle for how this zero-difference will be overdetermined by other particular social differences. It is against this background that one should read an important, although usually overlooked, feature of Lacan’s schema of the signifier: Lacan replaces the standard Saussurean scheme (above the bar the word “arbre”, and beneath it the drawing of a tree) with, above the bar, two words one along the other, “homme” and “femme”, and, beneath the bar, two identical drawings of a door. In order to emphasize

the differential character of the signifier, Lacan first replaces Saussure's single scheme with a signifier's couple, with the opposition man/woman, with the sexual difference; but the true surprise resides in the fact that, at the level of the imaginary referent, THERE IS NO DIFFERENCE (we do not get some graphic index of the sexual difference, the simplified drawing of a man and a woman, as is usually the case in most of today's restrooms, but THE SAME door reproduced twice). Is it possible to state in clearer terms that sexual difference does not designate any biological opposition grounded in "real" properties, but a purely symbolic opposition to which nothing corresponds in the designated objects—nothing but the Real of some undefined X which cannot ever be captured by the image of the signified?

Back to Levi-Strauss's example of the two drawings of the village: it is here that one can see it what precise sense the Real intervenes through anamorphosis. We have first the "actual", "objective", arrangement of the houses, and then its two different symbolizations which both distort in an amamorphic way the actual arrangement. However, the "real" is here not the actual arrangement, but the traumatic core of the social antagonism that distorts the tribe members' view of the actual antagonism. The Real is thus the disavowed X on account of which our vision of reality is anamorphically distorted. (And, incidentally, this three-levels dispositif are strictly homologous to Freud's three-levels dispositif of the interpretation of dreams: the real kernel of the dream is not the dream's latent thought which is displaced/translated into the explicit texture of the dream, but the unconscious desire which inscribes itself through the very distortion of the latent thought into the explicit texture.)

And the same goes for today's art scene: in it, the Real does NOT return primarily in the guise of the shocking brutal intrusion of excremental objects, mutilated corpses, shit, etc. These objects are, for sure, out of place—but in order for them to be out of place, the (empty) place must already be here, and this place is rendered by the "minimalist" art, starting from Malevitch. Therein resides the complicity between the two opposed icons of high modernism, Kazimir Malevitch's "The Black Square on the White Surface" and Marcel Duchamp's display of ready-made objects as works of art. The underlying notion of Malevitch's elevation of an everyday common object into the work of art is that being a work of art is not an inherent property of the object; it is the artist himself who, by preempting the (or, rather, ANY) object and locating it at a certain place, makes it the work of art—being a work of art is not a question of "why", but "where". And what Malevitch's minimalist disposition does is simply to render—to isolate—this place as such, the empty place (or frame) with the proto-magic property of transforming any object that finds itself within its scope into the work of art. In short, there is no Duchamp without Malevitch: only after the art practice isolates the frame/place as such, emptied of all its content, can one indulge in the ready-made procedure. Before Malevitch, a urinal would have remained just a urinal, even if it were to be displayed in the most distinguished gallery.

The emergence of excremental objects which is out of place is thus strictly correlative to the emergence of the place without any object in it, of the empty frame as such. Consequently, the Real in contemporary art has three dimensions, which somehow repeats within the Real the triad of Imaginary-Symbolic-Real. The Real is first here as the anamorphic stain, the anamorphic distortion of the direct image of reality—as a distorted image, as a pure semblance that “subjectivizes” objective reality. Then, the Real is here as the empty place, as a structure, a construction that is never here, experiences as such, but can only be retroactively constructed and has to be presupposed as such—the Real as symbolic construction. Finally, the Real is the obscene excremental Object out of place, the Real “itself”. This last Real, if isolated, is a mere fetish whose fascinating/captivating presence masks the structural Real, in the same way that, in the Nazi anti-Semitism, Jew as the excremental Object is the Real that masks the unbearable “structural” Real of the social antagonism. These three dimensions of the Real result from the three modes to acquire a distance toward “ordinary” reality: one submits this reality to anamorphic distortion; one introduces an object that has no place in it; one subtracts/erases all content (objects) of reality, so that all that remains is the very empty place these objects were filling in.

##### 5. THE FREUDIAN TOUCH

The falsity of *The Matrix* is perhaps most directly discernible in its designation of Neo as “the One”. Who is the One? There effectively is such a place in the social link. There is, first, the One of the Master-Signifier, the symbolic authority. Even in the social life in its most horrifying form, the memories of concentration camp survivors invariably mention the One, an individual who did not break down, who, in the midst of the unbearable conditions which reduced all others to the egotistic struggle for bare survival, miraculously maintained and radiated an “irrational” generosity and dignity—in Lacanian terms, we are dealing here with the function of *Y’a de l’Un*: even here, there was the One who served as the support of the minimum of solidarity that defines the social link proper as opposed to the collaboration within the frame of the pure strategy of survival. Two features are crucial here: first, this individual was always perceived as one (there was never a multitude of them, as if, following some obscure necessity, this excess of the inexplicable miracle of solidarity has to be embodied in a One); second, it was not so much what this One effectively did for the others which mattered, but rather his very presence among them (what enabled the others to survive was the awareness that, even if they are for most of the time reduced to the survival-machines, there is the One who maintained human dignity). In a way homologous to the canned laughter, we have here something like the canned dignity, where the Other (the One) retains my dignity for me, at my place, or, more precisely,

where I retain my dignity THROUGH the Other: I may be reduced to the cruel struggle for survival, but the very awareness that there is One who retains his dignity enables ME to maintain the minimal link to humanity. Often, when this One broke down or was unmasked as a fake, the other prisoners lost their will to survive and turned into indifferent living dead—paradoxically, their very readiness to struggle for the bare survival was sustained by its exception, by the fact that there was the One NOT reduced to this level, so that, when this exception disappeared, the struggle for survival itself lost its force. What this means, of course, is that this One was not defined exclusively by his “real” qualities (at this level, there may well have been more individuals like him, or it may even have been that he was not really unbroken, but a fake, just playing that role): his exceptional role was rather that of transference, i.e., he occupied a place constructed (presupposed) by the others.

In *The Matrix*, on the contrary, the One is he who is able to see that our everyday reality is not real, but just a codified virtual universe, and who therefore is able to unplug from it, to manipulate, and suspend its rules (fly in the air, stop the bullets . . .). Crucial for the function of THIS One is his virtualization of reality: reality is an artificial construct whose rules can be suspended or at least rewritten—therein resides the properly paranoid notion that the One can suspend the resistance of the Real (“I can walk through a thick wall, if I really decide it . . .”, i.e., the impossibility for the most of us to do this is reduced to the failure of the subject’s will). However, it is here that, again, the film does not go far enough: in the memorable scene in the waiting room of the prophetess who will decide if Neo is the One, a child who is seen twisting a spoon with his mere thoughts tells the surprised Neo that the way to do it is not point is not to convince myself that I can twist the spoon, but to convince myself that THERE IS NO SPOON . . . . However, what about MYSELF? Is it not that the further step should have been to accept the Buddhist proposition that I MYSELF, the subject, do not exist?

In order to further specify what is false in *The Matrix*, one should distinguish simple technological impossibility from fantasmatic falsity: time-travel is (probably) impossible, but fantasmatic scenarios about it are nonetheless “true” in the way they render libidinal deadlocks. Consequently, the problem with *Matrix* is not the scientific naivety of its tricks: the idea of passing from reality to VR through the phone makes sense, since all we need is a gap/hole through which one can escape. (Perhaps, an even better solution would have been the toilet: is not the domain where excrements vanish after we flush the toilet effectively one of the metaphors for the horrifyingly sublime Beyond of the primordial, pre-ontological Chaos into which things disappear? Although, we rationally know what goes on with the excrements, the imaginary mystery nonetheless persists—shit remains an excess which does not fit our daily reality, and Lacan was right in claiming that we pass from animals to humans

the moment an animal has problems with what to do with its excrements, the moment they turn into an excess that annoys it. The Real is thus not primarily the horrifying disgusting stuff re-emerging from the toilet sink, but rather the hole itself, the gap which serves as the passage to a different ontological order—the topological hole or torsion which “curves” the space of our reality so that we perceive/imagine excrements as disappearing into an alternative dimension which is not part of our everyday reality.) The problem is a more radical fantasmatic inconsistency, which erupts most explicitly when Morpheus (the African-American leader of the resistance group who believe that Neo is the One) tries to explain to the still perplexed Neo what the Matrix is—he quite consequently links it to a failure in the structure of the universe:

It's that feeling you have had all your life. That feeling that something was wrong with the world. You don't know what it is but it's there, like a splinter in your mind, driving you mad. /.../ The Matrix is everywhere, it's all around us, here even in this room. /.../ It is the world that has been pulled over your eyes to blind you from the truth. NEO: What truth? MORPHEUS: That you are a slave, Neo. That you, like everyone else, was born into bondage... kept inside a prison that you cannot smell, taste, or touch. A prison of your mind.

Here the film encounters its ultimate inconsistency: the experience of the lack/inconsistency/obstacle is supposed to bear witness of the fact that what we experience as reality is a fake—however, toward the end of the film, Smith, the agent of the Matrix, gives a different, much more Freudian explanation:

Did you know that the first Matrix was designed to be a perfect human world? Where none suffered, where everyone would be happy? It was a disaster. NO one would accept the program. Entire crops of the humans serving as batteries were lost. Some believed we lacked the programming language to describe your perfect world. But I believe that, as a species, human beings define their reality through suffering and misery. The perfect world was a dream that your primitive cerebrum kept trying to wake up from. Which is why the Matrix was re-designed to this: the peak of your civilization.

The imperfection of our world is thus at the same time the sign of its virtuality AND the sign of its reality. One could effectively claim that the agent Smith (let us not forget: not a human being as others, but the direct virtual embodiment of the Matrix—the big Other—itsself) is the stand-in for the figure of the analyst within the universe of the film: his lesson is that the experience of an insurmountable obstacle is the positive condition for us, humans, to perceive something as reality—reality is ultimately that which resists.

## 6. MALEBRANCHE IN HOLLYWOOD

The further inconsistency concerns death: WHY does one “really” die when one dies only in the VR regulated by the Matrix? The film provides the obscurantist answer: “NEO: If you are killed in the Matrix, you die here/i.e., not only in the VR, but also in real life/? MORPHEUS: The body cannot live without the mind.” The logic of this solution is that your “real” body can only stay alive (function) in conjunction to the mind, i.e., to the mental universe into which you are immersed: so if you are in a VR and killed there, this death affects also your real body . . . . The obvious opposite solution (you only really die when you are killed in reality) is also too short. The catch is: is the subject WHOLLY immersed into the Matrix-dominated VR or does he know or at least SUSPECT the actual state of things? If the answer is YES, then a simple withdrawal into prelapsarian Adamic state of distance would render us immortal IN THE VR and, consequently, Neo who is already liberated from the full immersion in the VR should SURVIVE the struggle with the agent Smith which takes place WITHIN the VR controlled by the Matrix (in the same way he is able to stopbullets, he should also have been able to derealize blows that wound his body). This brings us back to Malebranche’s occasionalism: much more than Berkeley’s God who sustains the world in his mind, the ULTIMATE Matrix is Malebranche’s occasionalist God.

Malebranche’s “occasionalism” undoubtedly was the philosopher who provided the best conceptual apparatus to account for VR. Malebranche, a disciple of Descartes, drops Descartes’s ridiculous reference to the pineal gland in order to explain the coordination between the material and the spiritual substance, i.e., body and soul; how, then, are we to explain their coordination, if there is no contact between the two, no point at which a soul can act causally on a body or vice versa? Since the two causal networks (that of ideas in my mind and that of bodily interconnections) are totally independent, the only solution is that a third, true Substance (God) continuously coordinates and mediates between the two, sustaining the semblance of continuity: when I think about raising my hand and my hand effectively raises, my thought causes the raising of my hand not directly but only “occasionally”—upon noticing my thought directed at raising my hand, God sets in motion the other, material, causal chain which leads to my hand effectively being raised. If we replace “God” with the big Other, the symbolic order, we can see the closeness of occasionalism to Lacan’s position: as Lacan puts it in his polemics against Aristoteles in *Television*,<sup>6</sup> the relationship between soul and body is never direct, since the big Other always interposes itself between the two. Occasionalism is thus essentially a name for the “arbitrary of the signifier”, for the gap that separates the network of ideas from the network of bodily (real) causality, for the fact that it is the big Other which accounts for the coordination of the two networks, so that, when my body bites an apple, my soul experiences a pleasurable sensation. This same gap is targeted by the ancient



Aztec priest who organizes human sacrifices to ensure that the sun will rise again: the human sacrifice is here an appeal to God to sustain the coordination between the two series, the bodily necessity and the concatenation of symbolic events. “Irrational” as the Aztec priest’s sacrificing may appear, its underlying premise is far more insightful than our commonplace intuition according to which the coordination between body and soul is direct, i.e., it is “natural” for me to have a pleasurable sensation when I bite an apple since this sensation is caused directly by the apple: what gets lost is the intermediary role of the big Other in guaranteeing the coordination between reality and our mental experience of it. And is it not the same with our immersion into VR? When I raise my hand in order to push an object in the virtual space, this object effectively moves—my illusion, of course, is that it was the movement of my hand which directly caused the dislocation of the object, i.e., in my immersion, I overlook the intricate mechanism of computerized coordination, homologous to the role of God guaranteeing the coordination between the two series in occasionalism.<sup>7</sup>

It is a well-known fact that the “Close the door” button in most elevators is a totally disfunctional placebo, which is placed there just to give the individuals the impression that they are somehow participating, contributing to the speed of the elevator journey—when we push this button, the door closes in exactly the same time as when we just pressed the floor button without “speeding up” the process by pressing also the “Close the door” button. This extreme and clear case of fake participation is an appropriate metaphor of the participation of individuals in our “postmodern” political process. And this is occasionalism at its purest: according to Malebranche, we are all the time pressing such buttons, and it is God’s incessant activity that coordinates between them and the event that follows (the door closing), while we think the event results from our pushing the button . . . .

For that reason, it is crucial to maintain open the radical ambiguity of how cyberspace will affect our lives: this does not depend on technology as such but on the mode of its social inscription. Immersion into cyberspace can intensify our bodily experience (new sensuality, new body with more organs, new sexes . . . ), but it also opens up the possibility for the one who manipulates the machinery which runs the cyberspace literally to steal our own (virtual) body, depriving us of the control over it, so that one no longer relates to one’s body as to “one’s own”. What one encounters here is the constitutive ambiguity of the notion of mediatization<sup>8</sup>: originally this notion designated the gesture by means of which a subject was stripped of its direct, immediate right to make decisions; the great master of political mediatization was Napoleon who left to the conquered monarchs the appearance of power, while they were effectively no longer in a position to exercise it. At a more general level, one could say that such a “mediatization” of the monarch defines the constitutional monarchy: in it, the monarch is reduced to the point of a purely formal symbolic gesture of “dotting the i’s”, of signing and thus conferring the performative force on

the edicts whose content is determined by the elected governing body. And does not, *mutatis mutandis*, the same not hold also for today's progressiver computerization of our everyday lives in the course of which the subject is also more and more "mediatized", imperceptibly stripped of his power, under the false guise of its increase? When our body is mediatized (caught in the network of electronic media), it is simultaneously exposed to the threat of a radical "proletarianization": the subject is potentially reduced to the pure \$, since even my own personal experience can be stolen, manipulated, regulated by the machinical Other. One can see, again, how the prospect of radical virtualization bestows on the computer the position which is strictly homologous to that of God in the Malebrancheian occasionalism: since the computer coordinates the relationship between my mind and (what I experience as) the movement of my limbs (in the VR), one can easily imagine a computer which runs amok and starts to act like an Evil God, disturbing the coordination between my mind and my bodily self-experience—when the signal of my mind to raise my hand is suspended or even counteracted in (the virtual) reality, the most fundamental experience of the body as "mine" is undermined. . . . It seems thus that cyberspace effectively realizes the paranoid fantasy elaborated by Schreber, the German judge whose memoirs were analyzed by Freud<sup>9</sup>: the "wired universe" is psychotic insofar as it seems to materialize Schreber's hallucination of the divine rays through which God directly controls the human mind. In other words, does the externalization of the big Other in the computer not account for the inherent paranoid dimension of the wired universe? Or, to put it in a yet another way: the commonplace is that, in cyberspace, the ability to download consciousness into a computer finally frees people from their bodies—but it also frees the machines from "their" people . . .

## 7. STAGING THE THE FUNDAMENTAL FANTASY

The final inconsistency concerns the ambiguous status of the liberation of humanity announced by Neo in the last scene. As the result of Neo's intervention, there is a "SYSTEM FAILURE" in the Matrix; at the same time, Neo addresses people still caught in the Matrix as the Savior who will teach them how to liberate themselves from the constraints of the Matrix—they will be able to break the physical laws, bend metals, fly in the air . . . . However, the problem is that all these "miracles" are possible only if we remain WITHIN the VR sustained by the Matrix and merely bend or change its rules: our "real" status is still that of the slaves of the Matrix, we as it were are merely gaining additional power to change our mental prison rules—so what about exiting from the Matrix altogether and entering the "real reality" in which we are miserable creatures living on the destroyed earth surface?

In an Adornian way, one should claim that these inconsistencies<sup>10</sup> are the film's moment of truth: they signal the antagonisms of our late-capitalist social

experience, antagonisms concerning basic ontological couples like reality and pain (reality as that which disturbs the reign of the pleasure-principle), freedom and system (freedom is only possible within the system that hinders its full deployment). However, the ultimate strength of the film is nonetheless to be located at a different level. Years ago, a series of science-fiction films like *Zardoz* or *Logan's Run* forecasted today's postmodern predicament: the isolated group living an aseptic life in a secluded area longs for the experience of the real world of material decay. Till postmodernism, utopia was an endeavor to break out of the real of historical time into a timeless Otherness. With postmodern overlapping of the "end of history" with full disponibility of the past in digitalized memory, in this time where we LIVE the atemporal utopia as everyday ideological experience, utopia becomes the longing for the Real of History itself, for memory, for the traces of the real past, the attempt to break out of the closed dome into smell and decay of the raw reality. The Matrix gives the final twist to this reversal, combining utopia with dystopia: the very reality we live in, the atemporal utopia staged by the Matrix, is in place so that we can be effectively reduced to a passive state of living batteries providing the Matrix with the energy.

The unique impact of the film thus resides not so much in its central thesis (what we experience as reality is an artificial VR generated by the "Matrix", the mega-computer directly attached to all our minds), but in its central image of the millions of human beings leading a claustrophobic life in water-filled cradles, kept alive in order to generate the energy (electricity) for the Matrix. So when (some of the) people "awaken" from their immersion into the Matrix-controlled VR, this awakening is not the opening into the wide space of the external reality, but first the horrible realization of this enclosure, where each of us is effectively just a fetus-like organism, immersed in the pre-natal fluid . . . . This utter passivity is the foreclosed fantasy that sustains our conscious experience as active, self-positing subjects—it is the ultimate perverse fantasy, the notion that we are ultimately instruments of the Other's (Matrix's) jouissance, sucked out of our life-substance like batteries. Therein resides the true libidinal enigma of this dispositif: WHY does the Matrix need human energy? The purely energetic solution is, of course, meaningless: the Matrix could have easily found another, more reliable, source of energy which would have not demanded the extremely complex arrangement of the VR coordinated for millions of human units (another inconsistency is discernible here: why does the Matrix not immerse each individual into his/her own solipsistic artificial universe? why complicate matters with coordinating the programs so that the entire humanity inhabits one and the same virtual universe?). The only consistent answer is: the Matrix feeds on the human's jouissance—so we are here back at the fundamental Lacanian thesis that the big Other itself, far from being an anonymous machine, needs the constant influx of jouissance. This is how we should turn around the state of things presented by the film: what the film renders as the scene of our awakening into our true situation,

is effectively its exact opposition, the very fundamental fantasy that sustains our being.

The intimate connection between perversion and cyberspace is today a commonplace. According to the standard view, the perverse scenario stages the “disavowal of castration”: perversion can be seen as a defense against the motif of “death and sexuality”, against the threat of mortality as well as the contingent imposition of sexual difference: what the pervert enacts is a universe in which, as in cartoons, a human being can survive any catastrophe; in which adult sexuality is reduced to a childish game; in which one is not forced to die or to choose one of the two sexes. As such, the pervert’s universe is the universe of pure symbolic order, of the signifier’s game running its course, unencumbered by the Real of human finitude. In a first approach, it may seem that our experience of cyberspace fits perfectly this universe: is not cyberspace also a universe unencumbered by the inertia of the Real, constrained only by its self-imposed rules? And is not the same with VR in *The Matrix*? The “reality” in which we live loses its inexorable character, it becomes a domain of arbitrary rules (imposed by the Matrix) that one can violate if one’s Will is strong enough . . . . However, according to Lacan, what this standard notion leaves out of consideration is the unique relationship between the Other and the jouissance in perversion. What, exactly, does this mean?

In “*Le prix du progres*”, one of the fragments that conclude *The Dialectic of Enlightenment*, Adorno and Horkheimer quote the argumentation of the 19th century French physiologist Pierre Flourens against medical anesthesia with chloroform: Flourens claims that it can be proven that the anesthetic works only on our memory’s neuronal network. In short, while we are butchered alive on the operating table, we fully feel the terrible pain, but later, after awakening, we do not remember it . . . . For Adorno and Horkheimer, this, of course, is the perfect metaphor of the fate of Reason based on the repression of nature in itself: his body, the part of nature in the subject, fully feels the pain, it is only that, due to repression, the subject does not remember it. Therein resides the perfect revenge of nature for our domination over it: unknowingly, we are our own greatest victims, butchering ourselves alive . . . . Is not it also possible to read this as the perfect fantasy scenario of inter-passivity, of the Other Scene in which we pay the price for our active intervention into the world? There is no active free agent without this fantasmatic support, without this Other Scene in which he is totally manipulated by the Other.<sup>11</sup> A sado-masochist willingly assumes this suffering as the access to Being.

Perhaps, it is along these lines that one can also explain the obsession of Hitler’s biographers with his relationship to his niece Geli Raubal who was found dead in Hitler’s Munich apartment in 1931, as if the alleged Hitler’s sexual perversion will provide the “hidden variable”, the intimate missing link, the fantasmatic support that would account for his public personality—here is this scenario as reported by Otto Strasser: “/ . . . / Hitler made her undress while he would lie down on the floor. Then she would have to squat down over

his face where he could examine her at close range, and this made him very excited. When the excitement reached its peak, he demanded that she urinate on him, and that gave him his pleasure".<sup>12</sup> Crucial is here the utter passivity of Hitler's role in this scenario as the fantasmatic support that pushed him into his frenetically destructive public political activity—no wonder Geli was desperate and disgusted at these rituals.

Therein resides the correct insight of *The Matrix*: in its juxtaposition of the two aspects of perversion—on the one hand, reduction of reality to a virtual domain regulated by arbitrary rules that can be suspended; on the other hand, the concealed truth of this freedom, the reduction of the subject to an utter instrumentalized passivity.

#### ENDNOTES

1. If one compares the original script (available on the internet) with the film itself, one can see that the directors (Wachowski brothers, who also authored the script) were intelligent enough to throw out too direct pseudo-intellectual references, like the following exchange: "Look at 'em. Automatons. Don't think about what they're doing or why. Computer tells 'em what to do and they do it." "The banality of evil." This pretentious reference to Arendt totally misses the point: people immersed in the VR of the Matrix are in an entirely different, almost opposite, position in comparison with the executioners of the holocaust. Another similar wise move was to drop the all too obvious references to the Eastern techniques of emptying your mind as the way to escape the control of the Matrix: "You have to learn to let go of that anger. You must let go of everything. You must empty yourself to free your mind."
2. It is also crucial that what enables the hero of *The Truman Show* to see through and exit his manipulated world is the unforeseen intervention of his father—there are two paternal figures in the film, the actual symbolic-biological father and the paranoid "real" father, the director of the TV-Show who totally manipulates his life and protects him in the closed environment, played by Ed Harris.
3. On whom I rely extensively here: see Jodi Dean, *Aliens in America. Conspiracy Cultures from Outerspace to Cyberspace*, Ithaca and London: Cornell University Press 1998.
4. Claude Levi-Strauss, "Do Dual Organizations Exist?" in *Structural Anthropology* (New York: Basic Books 1963), p. 131–163; the drawings are on pages 133–134.
5. See Rastko Mocnik, "Das 'Subjekt, dem unterstellt wird zu glauben' und die Nation als eine Null-Institution," in *Denk-Prozesse nach Althusser*, ed. by H. Boke, Hamburg: Argument Verlag 1994.
6. See Jacques Lacan, "Television", in October 40 (1987).

7. The main work of Nicolas Malebranche is *Recherches de la verite* (1674–75, the most available edition Paris: Vrin 1975).
8. As to this ambiguity, see Paul Virilio, *The Art of the Motor*, Minneapolis: Minnesota University Press 1995.
9. The notion of this connection between cyberspace and Schreber's psychotic universe was suggested to me by Wendy Chun, Princeton.
10. A further pertinent inconsistency also concerns the status of intersubjectivity in the universe run by the Matrix: do all individuals share the SAME VR? WHY? Why not to each its preferred own?
11. What Hegel does is to "traverse" this fantasy by demonstrating its function of filling in the pre-ontological abyss of freedom, i.e., of reconstituting the positive Scene in which the subject is inserted into a positive noumenal order. In other words, for Hegel, Kant's vision is meaningless and inconsistent, since it secretly reintroduces the ontologically fully constituted divine totality, i.e., a world conceived ONLY as Substance, NOT also as Subject.
12. Quoted from Ron Rosenbaum, *Explaining Hitler*, New York: Harper 1999, p. 134.

# Chapter 63: Learning by Being: Thirty Years of Cyborg Existemology

STEVE MANN

*Department of Electrical and Computer Engineering, University of Toronto, Canada*

## 1. INTRODUCTION

Since my childhood, a personal hobby of mine has been the functional modification of my own body, through technology. This modification often took the form of creating new sensory capabilities, as well as (what were to become eventually successful) attempts at correcting learning disabilities, such as visual memory impairment. I have had very particular experiences that speak to what it means to live within a virtual, and more importantly, a mediated (i.e., computationally modified) learning environment. I did not just experience virtual reality, mediated reality, etc., I became a cyborg, invented the technologies I needed to become a cyborg and then have spent 30 years learning and teaching about what it means to exist in a cyborg state. Originally I did this in private, but around 20 years ago I started, wearing a full computer system more openly, which resulted in my being referred to as a “cyborg” (although I do not particularly like the term because it is such a “loaded” term so heavily co-opted by science fiction). I came to best understand the term “cyborg” through a variety of discussions I had with Manfred Clynes, who coined the term. Thus I prefer to limit use the term to the Clynes sense, i.e., a synergy between human and machine that happens without conscious thought or effort (Clynes would often tell me that a person riding a bicycle was a cyborg because he or she would, after a while, forget that they were technologically modified).

As a “cyborg” (Mann, 2001) in the sense of long-term adaptation to the modified body, one encounters a new kind of existential self-determination and mastery over one’s own environs (and to some degree, one’s own destiny). Presently, in addition to having the internet and massive databases and video at my beck and call most of the time, I am also connected to others. While I am grocery shopping, my wife—who may be at home or in her office—sees exactly what I see and helps me pick out vegetables. She can imprint images onto my retina while she is seeing what I see. I call this collaborative mediated reality. I hope to add to the population of similarly equipped people; in the Fall of 1998, at the University of Toronto, I taught what I believe to be the world’s first existemology course.

Existemology pertains to not just body modification, through technology (“cyborg primitives”) but also to mind modification through long-term

adaptation. In this sense, existemology also extends into what I call the “post-cyborg” age, and thus also applies to the creation of a new state-of-mind that can persist after the technological prostheses are removed. In the sense that I found that this new state of mind could comprise an improvement, I thus encountered existemological therapy (i.e., improved condition even if the body modifications are removed or become damaged or inoperative).

The general ideas of existemology are themselves applicable to learning environments that have nothing to do with bodyborne computing. To some degree, beyond whether the technology is implanted, worn, carried, or non-existent, what can be learned is an educational paradigm that embodies an epistemology of personal choice, and the metaphysics of personal freedom, growth, and development.

## 2. FROM “LEARN BY DOING” TO “LEARN BY BEING”: EXISTEMOLOGY AS A CONTINUATION OF CONSTRUCTIONIST LEARNING

“Love is a better master than duty”

—Albert Einstein

I begin by contextualizing my current teaching practice, and then expand upon how my “cyborg” existence led up to this current practice.

MIT is known for its Constructionist Learning, and in fact a new building is now being built at MIT, with a 42 million dollar donation, to house MIT’s Constructionist Learning research effort. Constructionist Learning is, loosely speaking, “learn by doing and creating” (See, for example, <http://www.jasonnolan.net/papers/doing.html>).

What I mean by existemology is “learn by being” in the sense of a technologically self-modified being that encompasses long-term adaptation.

It includes a kind of “deconstructivist learning” toward an emphasis on learning by involvement (learning by involvement in that which matters to the individual who is learning—learning by “being” at one with the subject matter).

This approach has worked very well for teaching personal cybernetics, wearable computing, and personal imaging, e.g., so students can learn by being at one with the very machine they are trying to learn about. But existemology can be applied to other research topics.

Existemology follows naturally in the evolution from traditional learn by rote, to building upon (De)Constructionist Learning, and onward.

I further developed existemology through a graduate level course, (course number ECE1766), beginning September 1998 (See Figure 1). In this course, I not only taught students about Personal Imaging, EyeTap, and Wearable Computer (WearComp), but I also taught them how to learn by “being at one with the machine”. By becoming at one with the machine, they, in effect, became the machine. In this way, they learned by “being” the computer, and





*Figure 1. Wearing my eyeglasses which embody the EyeTap technology of both image capture and image display (the special glasses look just like ordinary bifocal eyeglasses) I teach a class of about 20 students, how to become one with the machine. Here I teach how to use the standard Xybernaut wearable computer product. I also teach the students how to build their own systems, and many of the new scientific principles in the emerging field of Personal Cybernetics.*

discovering the existential principle of self-empowerment and self-exploration which typically happens after a couple of months of continuous use of a WearComp system.

With more than 20WearComps, facilitated by in-kind equipment donations of various components from Xybernaut, clear-NET, WaveRider, Kodak, and various other companies, I taught my course with an emphasis on networked multimediated visual reality (loosely speaking “how to become a photographic cyborg”). This course allowed students to create their own version of reality, in their ordinary day-to-day living. What I discovered, is that students learned a great deal more, and explored a great many different avenues of pursuit, than is typically the case in a traditional “learn by lecture”, or even a constructionist “learn by doing + creating” course.

Such an approach gave rise to an epistemology of choice, in the interpretation of a computer-mediated reality that captures the essence of post-modernist deconstructionism. This “deconstructionist learning” involves not just putting things together, but also taking things apart to learn how they work. Thus an important element of a “deconstructionist education” (DeconEd) is learning the art of *reverse engineering*.

I found in my ECE1766 course, that the desire to participate was overwhelming. It was delightful to see the tremendous desire to learn, even among student “listeners” who do not get course credit.

It is unusual to find students so eager to learn that many who do not need the course credit still attend. However, in my course, this was very much the case.

It seems that a new concept in education has been discovered—a new concept in education that awakens a passionate quest for knowledge—not merely the facts presented on corporate device specifications sheets that can make us more useful to society, but also the hidden secrets of how things work, and how they were originally invented.

If science should be “unlocking (or discovering) the secrets of God”, then, at least in some ways, computer science can be unlocking (or discovering) the secrets of corporations (i.e., other humans working in the corporations that produce proprietary products, etc.).

Deconstructionist learning particularly emphasizes this approach to understanding how things work, by taking them apart. This echoes my early childhood experiences of building various systems from a zero budget, through the collection of junk, garbage, and various refuse, to repurpose in new ways. Thus my life was one of creative exploration in first understanding how things work, and then using that understanding to synthesize new inventions from the components found in existing technologies, combined with the new technologies that I invented.

At the time, much of what I was doing would later seem like science fiction to others. The fact that many of my cyborg technologies of self-modification pre-dated the later “borglike” visions of science fiction, made it all the more difficult to explain these concepts to my peers, because there was not even the reference in science fiction at that time, as a basis for explanation.

In the early days, most of the discrimination that I faced was peer discrimination, rather than institutionalized discrimination by authority figures. Thus the main difficulties of my childhood were more from communal changing of clothes associated with sports, or gym class, rather than from the official machinery of airport security, which then was quite lax.

There was eventually to be a reversal, in which I found a great deal of peer acceptance, whereas the large organizations turned against my vision of the future. In particular, as time progressed, it became more socially acceptable to be a computer enthusiast, and the eventual (more recent) visions of science fiction gave a fun and creative reference. With commercial interest in my inventions, it even became fashionable to some extent, and people would often come over and talk to me, being very interested in the project. Although some of this change could be attributed to improvements in my inventions and designs, even when I re-connected to older systems I found the peer response (e.g., the general reactions from the public) to have become positive. Whereas people used to walk across the street to avoid me, or laugh at me, or be negative in other ways in the 1970s, and early 1980s, I had found peer acceptance started around 1984 (the era of new-wave androgyny where the blurring of gender lines seemed to make the blurring of human-machine lines equally acceptable). By the 1990s, the peer acceptance spread from the fringes of new-wave androgyny, the arts, and those on the creative fringes, to a more mainstream peer acceptance.

But the institutionalized acceptance diminished over time. Institutionalized discrimination began around 1985 when peer acceptance had just picked up. For example, while boarding the subway in Toronto, I was approached by concerned security guards, in the summer of 1985. The discrimination appeared to be correlated to security, and thus I found myself, as the years progressed, being terrorized by security guards, who threatened to use force to advance their political agenda of “security”. It seemed that the more “security” there was, the more cyborg discrimination. This kind of annoyance intensified through the 1990s, with an unfortunate incident perpetrated by Air Canada (See for example, Paul Virilio, *Crepuscular Dawn*, pages 96–98).

### **2.1. Existential Contraband**

More recently, for example, I was required to go to the US embassy to apply for a passport for my daughter (since she was born in the U.S.), but I was not allowed into the embassy because I was an electronic device, and electronic devices were considered contraband.

Thus I was simultaneously required to enter the embassy to get the passport, but not allowed to enter the embassy. In the end, the officials came out, and I swore my oath down at street level, rather than go up to the office, but this situation simply serves as an example of the absurdity of existential contraband that occurs when the body is permanently enjoined with technology.

## **3. WEB SURFERS’ RIGHT-OF-WAY FOR BEACH ACCESS**

### **3.1. Securityranny and Sabetyanny**

Another example of institutionalized discrimination is in the realm of providing free wireless connectivity for a community of cyborgs. Back in the 1980s and 1990s this was viewed with great welcome by the official powers that be, as being a good thing. It attracted a lot of positive press coverage in the 1990s, and set forth a foundation upon which others built.

However, more recently, with new technologies that make it easier to support online access for cyborgs and for everyone, there is also a hysteria around the perceived liability issues. In the early days I had to build my own wireless equipment, and I had to help others build systems to get online on my network. I was, for example, welcomed by the New England Spectrum Management Council to establish online connectivity for my community of cyborgs in the early 1990s.

But more recently, when it is so much easier with new technologies like 802.11 wireless, the discrimination is mostly institutional. For example, officials feel that internet access should not be freely available to anyone,

because it could be used by terrorists, or copyright violators. These officials wished to impose security constraints on the network to prevent unauthenticated access.

So I constructed an “urbeach access” metaphor, e.g., that the internet is like an urban beach, that should allow access, right-of-way. With a traditional beach, property owners are often required to provide a public right-of-way that provides beach access. Property owners who build high fences all the way around all of the property, in the name of “security”, are, through this excess security, denying that right-of-way could also thus incur liability. In addition to preventing people from enjoying the beach on hot summer days, property owners who, through security excess, deny bathers access rights could risk liability, e.g., if someone suffered heat stroke because they could not exercise their lawful right of access to the beach, or a more extreme case might be if someone spilled battery acid on themselves and could not get to the beach to wash it off in the lake or ocean. This could include civil liability in which a person would have had access, but for the unlawful excess in security.

Thus we see, by way of example, that the security equation has two sides, i.e., that an organization can be liable for having too little security OR TOO MUCH security. The too-little-security side of the equation is the only one that we usually hear about, since the other side of the equation is seldom expressed.

Now to relate the analogy to our present situation: Free anonymous wireless access to the net is something that can result in personal safety. Cyborgs, or others, who might otherwise reach the 'net but are prevented from doing so, could be at risk, e.g., from a mugging or other attack that might have been prevented with 'net access.

Thus any organization that wishes to shut down one of my (or anyone else's) free wireless 'net gateways needs to be informed of the liability that their “security” measure creates. By asking them to accept liability for discontinuance of a service that people are already using, one is better prepared to keep the 'net running.

Moreover, the absurdity of someone asking me to shut down my free 'net portal, or to protect it by password, is as absurd as requiring passwords for the enjoyment of other building resources like light, heat, HVAC, and the like. Imagine a building owner who decided to license the electric light in the building by saying that people need to authenticate before receiving the light. Thus anonymous users would need to walk around in the dark, but those wearing a transponder would get a “sight license” and could see. Those without “sight licenses” (such as visiting scholars who had not yet registered) might trip and fall in the dark. They would then have a case against the building owner, and thus the building owner exposes the organization to liability by excessive photonic security.

The same might be true of HVAC, e.g., a license to receive heat, cooling, fresh air, etc., including a breathing license, and a license to exhale, as well

as to dispose of bodily waste. Those who dispose of bodily waste without a license in UriNation, are punished by the officials of urinalism.

Thus I had little trouble in convincing many others that the airwaves should be as free as the photons and the air we breathe, and that requiring authentication for basic safety such as connectivity is absurd.

Thus the birth of “free open-air beach access”.

#### 4. “WARE” AS CONTAMINANT IN SOFTWARE: DECONOMICS 101

The WearComp was invented as a kind of experiment in self-determination and mastery over one’s own destiny that is characteristic of modern concepts like freesource (the GNU Linux operating system that currently runs on it, etc.).

We often encounter so-called “courseware” (educational softWARE), but, as educators, we have an ethical and moral responsibility for not just what we teach, but for our choice of tools with which to teach it. A “ware” is an article of commerce. Thus the word “software” carries with it, embedded in its very etymology, the ideals of commerce. But let us consider replacing “The new economy” (which has already come to a crash—the bubble has been burst), with “The new Deconomy”.

To spend a lot of time learning how to use a particular proprietary computer program, is to become trapped in a way of thinking that is an article of commerce. But there is (or should be) also room for a “deconomics”—a deconist deconstruction of economics, that allows us to have the “Soft” and not the “Ware”.

That is the essence of the philosophical context of “free software”, “open source”, “open course”, and the like, that I prefer to call “freesource”. Freesource emphasizes self-determination and mastery over one’s own destiny. This “personal empowerment” aspect is what I believe to be a fundamental issue in operating systems such as GNU Linux. It is this aspect that WearComp and GNU Linux both share in common, and it is for this reason that GNU Linux was selected as the operating system for my existemology project.

An important goal of freesource is that of allowing anyone the option of acquiring, and thus advancing the world’s knowledge base.

This eliminates the distinction between “programmer” and “user”. It also eradicates the distinction between “developer” and “end user”. And it blurs the boundary between “teacher” and “learner”. Finally, it also gets rid of the boundary between consumer and producer.

(For a more satirical perspective on Closed Source, see <http://wearcam.org/seatsale/>) In the cyborg world, such concepts are heightened, in the sense that the computer becomes part of our own “thought” process. Thus the construct known as “humanistic intelligence (HI)” (Mann, 1998) also comes into play. HI is intelligence that arises by having the human being in the feedback loop of a computational process in which the human and computer are inextricably intertwined.

HI is motivated by the philosophy of science, e.g., open peer review, and the ability to (de)construct one's own experimental space. HI provides a new synergy between humans and machines that seeks to involve the human rather than having computers emulate human thought or replace humans. Particular goals of HI are human involvement at the individual level, and providing individuals with tools to challenge society's pre-conceived notions of human-computer relationships. An emphasis in this article is on computational frameworks surrounding "visual intelligence" devices, such as video cameras interfaced to computer systems.

A fundamental problem we face in today's society, as it pertains to computers, is computer program source code disclosure. GNU Linux has emerged as one solution, together with an outlook based on science and on self-determination and individual empowerment at the personal level.

Advanced computer systems is one area where a single individual can make a tremendous contribution to the advancement of human knowledge, but is often prevented from doing so by various forms of what is alleged to be "security" but what is really a form of security excess that is dangerous to the advancement of science. Since science often leads to improved safety, it is actually therefore possible that too much security can be dangerous. A system that excludes any individual from exploring it fully, may prevent that individual from "thinking outside the box" (especially when the box is "welded shut"). Such software hegemonies can prevent some individuals from participating in the culture of computer science and the advancement of the state-of-the-art.

A second fundamental problem pertains to some of the new directions in Human-Computer Interaction (HCI). These new directions are characterized by "computers everywhere", constantly monitoring our activities, and responding "intelligently". This is the "ubiquitous surveillance" or "pervasive surveillance" ("perveillance") paradigm in which keyboards and mice are replaced by cameras and microphones watching us at all times. Proponents of perveillance claim that we are being watched for our benefit, and that they are making the world a better place for us.

Computers everywhere, constantly monitoring our activities, and responding "intelligently" have the potential to make matters worse, from the closed source nature of the software, possibly excluding the individual user from knowledge not only of certain aspects of the computer upon his or her desk, but also of the principle of operation and the function of everyday things. Moreover, the implications of secrecy within the context of these intelligence gathering functions puts forth a serious threat to personal privacy, solitude, and freedom.

But the *surveillance state* locks us into a one-sided 20th century "us versus them" way of thinking. Surveillance alleges to define "good" people (the watchers), versus potentially bad people: Those "suspected" of evil (the watched).



*Figure 2. Surveillance and Sousveillance: Surveillance is French for watching from above (“sur” meaning “from above” and “veiller” meaning “to watch”). Surveillance denotes the God’s eye view of the proverbial “eye in the sky”. Sousveillance brings the cameras from the heavens down to earth, i.e., from the lamp posts and ceilings, down to human level.*

For this reason, we require the notion of “sousveillance” (inverse surveillance), from “sous” (French from under, or below), and “veiller” (French for “to watch”). Sousveillance is not merely:

- passengers photographing taxi cab drivers;
- shoppers photographing shopkeepers; and
- citizens photographing police;

but, rather, it is a construct that acknowledges the pastmodern world in which we live (See <http://wearcam.org/sousveillance.htm>) (See Figure 2).

In some sense, a cyborg who keeps a logfile (much like the “black box” flight recorder on an aircraft) of everything he or she experiences, is practicing the art of sousveillance. Such cyborg logfiles (also known as “cyborg logues”, cyborglogs, or “glogs” for short), might also protect the individual from attackers, whether said attackers are from a higher or lower point along the “axis of evil”. Thus the fact that glogs protect the wearer from human rights violations by police or other authorities, as well as attacks from muggers, etc., makes them “axis neutral”, in the sense that they point everywhere, unlike surveillance from on high.

Students quickly learn about the post-modern notion of the absence of any clearly defined axis of evil. This causes them to question even the definition of “terrorism” or “terrorist” or “guerrorist”. Many of the students, for example, began to compare the formal definition of “terrorist” to that of soldier, or police officer, and became confused. Thus, at the very least, “glogging”, as it

is called (making cyborg logs) gave them the chance to ask questions, and to realize that life is not so clearly defined as one might have at first believed. This gave rise to yet another example of deconstructionist learning.

#### **4.1. Computer Science versus Computer Secrecy**

Science provides us with ever-changing schools of thought, opinions, ideas, and the like, while all building upon a foundation of verifiable (and sometimes evolving) truth. The foundations, laws, and theories of science, although true by assumption may at any time be called into question as new experimental results unfold. Thus when doing an experiment, we may begin by making certain assumptions, but at any time, these assumptions may be verified.

In particular, a scientific experiment is a form of investigation that leads wherever the evidence may take us. In many cases, the evidence takes us back to questioning the very assumptions and foundations we had previously taken as truth, and in some cases, instead of making a new discovery along the lines anticipated by previous scientists, we discover that another previous discovery was false or inaccurate. Sometimes these are the biggest and most important discoveries—things that are discovered by accident.

A situation in which one or more of the foundation elements are held in secret is contrary to the principles of science. Although many results in science are treated as a “black box”, for operational simplicity, there is always the possibility that the evidence may want to lead us inside that box.

Imagine, for example, conducting an experiment on a chemical reaction between a proprietary solution “A”, mixed with a secret powder “B”, brought to a temperature of 212 degrees T. (Top secret temperature scale which you are not allowed to convert to other units). It is hard to imagine where one might publish results of such an experiment, except, perhaps, in the *Journal of Irreproducible Results*.

Now it is quite likely that one could make some new discoveries about the chemical reaction between A and B, without knowing what A and B are, and one might even be able to complete a doctoral dissertation and obtain a Ph.D. for the study of the reaction between A and B (assuming a large enough quantity of A and B were available).

Results in Computer Science that are based, in part, on undisclosed matters, inhibit the ability of the scientist to follow the evidence wherever it may lead. Even in a situation where the evidence does not lead inside one of the secret “black boxes”, science conducted in this manner is irresponsible in the sense that another scientist in the future may wish to build upon the result, and may, in fact, conduct an experiment that leads backward, as well as forwards. Should the new scientist follow evidence that leads backward, inside one of these secret “black boxes”, then the first scientist will have created a foundation contaminated by secrecy. In the interest of academic integrity, better science



would result if all the foundations upon which it were built were such as to be subject to full examination by any scientist who might, at some time in the future, wish to build upon a given scientific discovery. Thus, although many computer scientists may work at a high-level, there would be great merit in a computational foundation open to examination by others, even if the particular scientist using the computational foundation does not wish to examine it. For example, the designer of a high level numerical algorithm, who uses a computer with a fully disclosed operating system (such as Linux), does other scientists a great service, even if he or she himself or herself only uses it at the Application Program Interface (API) level and never intends to look at its source code or that of the Linux operating system underneath it.

#### **4.2. Obvious or Obfuscated**

Imagine a clock that was designed so that when the cover was lifted off, all the gears would fly out in different directions, so that it would be more difficult for a young child to open up his or her parents' clock and determine how it works. Alternatively, imagine the clock was loaded with explosives, so that it would completely self-destruct upon opening.

Assuming a child survived such a bad experience, it is still doubtful that devices made in this manner would be good for society, in particular, for the growth and development of young engineers and scientists with a natural curiosity about the world around them.

As the boundary between software and hardware blurs, devices are becoming more and more difficult to understand. This difficulty arises in part, as a result of deliberate obfuscation on the part of product manufacturers. More and more devices contain general-purpose microprocessors, so that their function depends on software. Specificity of function is achieved through specificity of software rather than specificity of physical form. By manufacturing everyday devices in which there is provided only executable code, without source code, manufacturers have provided a first level of obfuscation. Further more, additional obfuscation tools are often used in order to make the executable task image more difficult to understand. These tools include strippers that remove object link names, etc., and even tools for building encrypted executables which contain dynamic decryption function that generates a narrow sliding window of unencrypted executable, so that only a small fragment of the executable is decrypted at any given time. In this way, not only is the end user deprived of source code, but the executable code itself is encrypted, making it difficult or impossible to look at the code even at the machine code level.

Moreover, devices such as Complex Programmable Logic Devices (CPLDs), such as the Alterra 7000 series, often have provisions to permanently destroy the data and address lines leading into a device, so that a single chip device can operate as a finite-state machine yet conceal even its

machine-level contents from examination. (An excellent tutorial on FPGAs and CPLDs may be found in (Brown & Rose, 1996)). Devices such as Clipper chips go a step further by incorporating fluorine atoms, so that if the user attempts to put the device into a milling machine, to mill off layer-by-layer for examination under an electron microscope, the device will self-destruct in a drastic manner that destroys structure. Thus the Clipper phones could contain a “trojan horse”, or some other kind of “back door”, and we might never be able to determine whether or not this is the case. This is yet another example of deliberate obfuscation of the operational principles of everyday things.

Thus we have a growing number of general-purpose devices whose function or purpose depends on software, downloaded code or microcode. Because this code is intellectually encrypted, so is the purpose and function of the device. In this way, manufacturers may provide us with a stated function or purpose, but the actual function or purpose may differ, or may include extra features, of which we are not aware.

#### 5. EQUIVEILLANCE: THE NEED TO STRIKE A BALANCE IN THE EQUILIBRIUM BETWEEN SURVEILLANCE AND SOUSVEILLANCE

Of primary importance, students learned that the world is not so one-sided as they first believed, and in fact the “sur” and “sous” form a kind of “yin” and “yang”. When we have only one, we are in a life-out-of-balance.

Never is this lack of balance so evident as in the proliferation of devices we call “environmental technologies”.

There are a number of researchers who have been proposing new computer user-interfaces based on environmental sensors. Buxton, who did much of the early pioneering research into intelligent environments (smart rooms, etc.), was inspired by automatic flush urinals, (as described, for example, in U.S. Pat. 4309781, 5170514, etc.), and formulated, designed, and built a HCI system called the “Reactive Room” (Cooperstock & Buxton, 1995; Cooperstock et al., 1997). This system consisted of various sensors, including optical sensors (such as video cameras), and processing, so that the room would respond to the user’s movement and activity.

Increasingly we are witnessing the emergence of “intelligent highways”, “smart rooms”, “smart floors”, “smart ceilings”, “smart toilets”, “smart elevators”, “smart light switches”, etc. However, a typical attribute of these “smart spaces” is that they were architected by someone other than the occupant. Thus the end user of the space often does not have a full disclosure of the operational characteristics of the sensory apparatus and the flow of intelligence data from the sensory apparatus.

In addition to the intellectual encryption described in the previous section, where manufacturers could make it difficult, or perhaps impossible for the end user to disassemble such sensory units in order to determine their actual

function, there is also the growth of hidden intelligence, in which the user may not even be aware of the sensory apparatus. For example, U.S. Pat. 4309781 (for a urinal flushing device) describes:

... sensor ... hidden from view and thus discourage tampering with the sensor ... when the body moves away from the viewing area. ... located such that an adult user of average height will not see it. ... sensing means, will be behind other components. ... positioned below the solenoid to allow light in and out. But the solenoid acts in the nature of a hood or canopy to shield the sensing means from the normal line of sight of most users ... Thus most users will not be aware of the sensing means. This will aid in discouraging tampering with the sensing means. A possible alternate arrangement would be to place the sensing means below and behind the inlet pipe.

U.S. Pat. 4998673 describes a viewing window concealed inside the nozzle of a shower head, where a fiber optics system is disclosed as a means of making the sensor remote, concealment to prevent users from being aware of its presence. U.S. Pat. 5199639 describes a more advanced system where the beam pattern of the nozzle is adapted to one or more characteristics of the user, while U.S. Pat. 3576277 discloses a similar system based on an array of sensing elements.

Means of creating viewing windows to observe the occupants of a space while, at the same time, making it difficult for the occupants to know if and when they are observed, are proposed in U.S. Pat. 4225881 and U.S. Pat. 5726706.

In addition to concealing the sensory apparatus, a goal of many visual observation systems is to serve the needs of the system architect rather than the occupants. For example, U.S. Pat. 5202666 discloses a system for monitoring employees within a restroom environment, in order to enforce hygiene (washing of hands after use of toilet).

Other forms of “intelligence”, such as “intelligent highways” often have additional uses, beyond those purported by those installing the systems. For example, traffic monitoring cameras were used to round-up, detain, and execute peaceful protesters in China’s Tiananmen Square.

U.S. Pat. 4614968 discloses a system where a video camera is used to detect smoke by virtue of the fact that smoke reduces the contrast of a fixed pattern opposite the video camera. However, the patent also notes that the camera can be also used for other functions such as visual surveillance of an area, since only one segment or line of the camera is needed for smoke detection. Again, the camera may thus be justified for one use, and additional uses, not disclosed to occupants of the space, may then evolve. U.S. Pat. 5061977 and 4924416 disclose the use of video cameras to monitor crowds and automatically control lighting, in response to the absorption of light by the crowds. While this form

of environmental intelligence is purportedly for the benefit of the occupants (to provide them with improved lighting), there are obvious other uses.

U.S. Pat. 5387768 discloses the use of visual inspection of users in and around an automated elevator. Again, these provide simple examples of environmental intelligence, in which there are other uses, such as security and surveillance. Although even those other uses (security and surveillance) are purportedly for the benefits of the occupants, and it is often even argued that concealing operational aspects of the system from the occupants is also for their benefit, it is an object of this paper to challenge these assumptions and to provide an alternate form of intelligence.

When the operational characteristics, function, data flow, and even the very existence of sensory apparatus is concealed from the end user, such as behind the grille of a smoke detector, environmental intelligence does not necessarily represent the best form of human-machine relationship for all concerned. Even when the sensors are visible, there must be the constant question as to whether or not the interests of the occupant are identical to those who control the intelligence-gathering infrastructure.

The need for personal space, free from monitoring, has also been recognized (Goffman, 1959) as essential to a healthy life. As more and more personal space is stolen from us, we may need to architect an alternative space of our own.

### **5.1. Solution to the Software Problem in Education**

The first solution to these problems is a framework called Completely Open Source, Headers, Engineering, and Research (COSHER).

Before investing considerable time in learning how to use new software, and in developing works in that new software, which may then become “locked into” a particular file format, we ask ourselves a very simple question: Is the software in question COSHER?

What this means is that there has been no deliberate attempt at obfuscation of the underlying principles of operation of this software, or in preventing us from freely distributing the intellectual foundations upon which we might invest many years of our lives. Deliberate attempts at obfuscation include such practices as elimination of source code and stripping of executable task images.

By using COSHER software, we are making a statement that we prefer Computer Science over Computer Secrecy. Science supports the basic principles of peer review, and a continued development and advancement of software principles, and principles that we build on top of the software.

Moreover, the time we invest in both learning the software, as well as creating works in the software, will be less likely to go to waste if we have

a copy of the complete source code of the software. In this manner, should the software ever become discontinued or unsupported, we will be able to become our own software support group and migrate the software forward to new architectures as our old computers become obsolete. If it is COSHER, chances are we will be less likely to lose the many hours or many years we invest in producing works within the software.

Furthermore, if we make new discoveries that are built on a foundation of COSHER software, they are easier to distribute.

In science, it is important that others be able to reproduce our results. Imagine what it would be like if we had built our results on top of DOS 3.1. Others would have to either rewrite our software to exactly reproduce our results, or find an old version of DOS 3.1. Since this is proprietary software, we are not at liberty to freely distribute it with our research, but it is also no longer available for purchase. However, if we had built our work on COSHER software, such as Linux 1.13, we can include a full distribution of Linux 1.3 in an archive, together with our results. Many years in the future, a scientist wishing to reproduce our results could then obtain a virtual machine (emulator for our specific architecture which will no doubt be obsolete by then) and install the COSHER operating system (Linux 1.13) that came with our archive, and then compile and run our programs.

## **5.2. Examples of COSHER Software**

The Linux operating system is a good example of a COSHER operating system. GNU software is also COSHER. There are many COSHER software packages, including GIMP (Gnu Image Manipulation Program), and the Video Orbits software package, described in <http://wearcam.org/orbits/index.html>.

## **5.3. Solution to Environmental Intelligence Gathering**

A proposed solution: HI for the re-configured self.

HI is a computational framework for individual personal empowerment. This framework is based on my “WearComp” invention—an apparatus for (embodiment of) realization of HI.

This framework involves the architecting of a new kind of personal space. An embodiment of the “WearComp” invention is an apparatus that is owned, operated, and controlled by the occupant of that space. In some sense, the apparatus of this invention is like a building, built for one occupant, and collapsed down around that one occupant. This computational framework for HI, called “WearComp”, and will now be described.



Figure 3. Evolution of the apparatus of the 'WearComp' invention from the 1970s to the present-day version built in ordinary-looking eyeglasses.

#### 5.4. WearComp as a Basis for HI

I invented WearComp in Canada in the 1970s, as a photographic tool for the visual arts (Mann, 1997a), in particular, something I called "Mediated Reality" (altered perception of visual reality). The goal of Mediated Reality, unlike related concepts like virtual (or augmented) reality, was to reconfigure (augment, deliberately diminish, or otherwise alter) the perception of reality in order to attain a heightened sense of awareness of how ordinary everyday objects respond to light.

HI is a new form of HCI comprising a computer that is subsumed into the personal space of the user (e.g., the computer may be worn, hence the term "user" and "wearer" of the computer may be used interchangeably), controlled by the wearer, and has both operational and interactional constancy, e.g., is always on and always ready and accessible (Mann, 1997b).

The WearComp invention described in IEEE Computer, Vol. 30, No. 2: <http://wearcomp.org/ieeecomputer.htm> (an historical account was given in IEEE ISWC-97, Oct.'97, and is also online at: <http://wearcomp.org/historical/index.html>) forms the basis for HI. The evolution of the apparatus of this invention is depicted in Figure 3.

#### 5.5. Definition of WearComp

A WearComp is a computer that is subsumed into the personal space of the user, controlled by the user, and has both operational and interactional constancy, i.e., is always on and always accessible.

Most notably, it is a device that is always with the user, and into which the user can always enter commands and execute a set of such entered commands, and in which the user can do so while walking around or doing other activities.

The most salient aspect of computers, in general, (whether wearable or not) is their *reconfigurability* and their *generality*, e.g., that their function can be made to vary widely, depending on the instructions provided for program execution.

With the WearComp, this is no exception, e.g., the WearComp is more than just a wristwatch or regular eyeglasses: It has the full functionality of a computer system but in addition to being a fully featured computer, it is also inextricably intertwined with the wearer.

This is what sets the WearComp apart from other wearable devices such as wristwatches, regular eyeglasses, wearable radios, etc. Unlike these other wearable devices that are not programmable (reconfigurable), the WearComp is as reconfigurable as the familiar desktop or mainframe computer.

The formal definition of wearable computing defined in terms of its three basic modes of operation and its six fundamental attributes is provided elsewhere in the literature (Mann, 1998).

#### **5.6. WearComp as Universal Interface to Reality**

Such a computational framework allows one to subsume all of the personal electronics devices that one might normally carry, such as:

- cellular phone;
- pager;
- wrist watch;
- heart monitor;
- camera;
- video camera

into a single device. Obviously, since it is a fully featured computer, it is possible to respond to e-mail, plan events on a calendar, type a report, or the like, while walking, standing in line at the bank, or the like. In this way WearComp anticipated the later arrival of the so-called “laptop computer”, but has advantages over the laptop computer in the sense that it can be used while walking around doing other things. However, the real power of WearComp is in its ability to serve as a basis for Personal Imaging and HI.

#### **5.7. Personal Safety Device: Cyborg Logs for Sousveillance**

WearComp not only subsumes the function of the laptop computer, but goes beyond it.

Another area in which WearComp provides a truly new form of user-interface not found on laptop computers and PDAs is in its constancy of user-interface, and constancy of operation. This characteristic perhaps becomes most evident in its use as a personal safety/security camera. Imagine, perhaps as you walk down some quiet street late at night, an assailant wielding a sawn-off shotgun, demanding cash from you. You would not likely

have time or opportunity to pull out a camcorder to record the experience, but since the eyeglasses are worn constantly, you would have captured the experience.

### **5.8. Camera of the Future**

Less extreme examples of WearComp as a new user-interface include the ability to construct a personal documentary video without conscious thought or effort. For example, in a fully-mediated reality, all light entering the eyes, in effect, passes through the computer, and may therefore be recorded (and possibly transmitted to remote locations). Wearable Wireless Webcam (Jones, 1995) was one example of a personal documentary video recorded using a reality mediator.

In the future, we may well have the capability to capture and recall our own personal experiences, and to have photo albums generated automatically for us. We will never miss baby's first steps, because we will have a retroactive record feature that lets us, for example, "begin recording from 5 minutes ago". Photo albums, in addition to being generated automatically, may also be exhibited while they are being generated. Rather than sending postcards to friends and relatives, or showing them an album after you come back from vacation, you may just put on your sunglasses and have the album sent to them automatically, as was done with the Wearable Wireless Webcam experiment in which video was transmitted, and still images were also automatically selected from the video.

### **5.9. Personal Intelligence Arms Race**

While there will no doubt be more environmental intelligence than personal intelligence, there is at least the hope that there might be an end to the drastic imbalance between personal intelligence and environmental intelligence. The individual making a purchase in a department store may have several cameras pointing at him to make sure that if he removed merchandise without payment that there would be evidence that he did not pay for the item. However, in the future, he will have a means of collecting evidence that he did pay for the item, or a recorded statement of a clerk about the refund policy. More extreme examples, such as the case of Latasha Harlins<sup>1</sup> also come to mind.

In this sense, the camera-based reality-mediator becomes an equalizer much like the Colt45 in the Wild West. When there is a standoff, it does not matter whether one person has a big gun and the other has a small gun, so long as there is enough ammunition for mutually assured destruction.

In the WearCam case, it is simply a matter of mutually assured accountability.



## 6. BECOMING A PHOTOBORG

Among other things, the cyborg apparatus of the invention functions as a two-way Wearable Wireless Webcam, in which the wearer can allow others to see exactly what he or she is seeing, over the World Wide Web. Moreover, the wearer can also allow others to alter his or her perception of visual reality as a means of communication. While the traditional videophone shows us a picture of the user, Wearable Wireless Webcam shows us what the user is looking at. Within most social circles, such as among friends and relatives, we already know what the other people look like, so we do not need to see a picture of these people. Instead, it is far more meaningful for us to “become” these people, e.g., to put ourselves in their shoes and see the world from their point of view.

### 6.1. Eye Am a Camera

One outcome of the apparatus of the invention, is a photographic mindset. In effect, the eye itself becomes a camera, and, while sending everyday experiences to the World Wide Web, students can develop a cinematographic awareness. The students have the opportunity to wear the apparatus continuously, so that a photographic awareness develops over time, as opposed to the traditional notion of only looking through the camera viewfinder while shooting or preparing to shoot.

By giving students the ability to wear the devices over an extended time period, they are able to internalize the mapping from 3d to 2d and the laws of projective geometry.

Students each have the opportunity to make a movie, viewed in real time by their friends and relatives. In this way, without even being aware of the learning process, the students have learned far more about cinematography than if they had taken traditional “learn by doing” photo and film courses. By becoming a camera, the student truly learns what a camera is. The “learn by being” approach far surpasses the traditional “learn by doing” approach. The successful photoborg (photographic cyborg) learns to shoot high quality documentary video without conscious thought or effort. After time, the camera functions as a true extension of the mind and body.

## 7. EYETAP: TAPPING INTO THE MIND’S EYE

The tremendous success of this project, to date, suggests a next step in the evolution of the PhotoBorg. EyeTap technology is an apparatus that intercepts light passing through the center of projection of at least one eye of the wearer of the apparatus. The intercepted light is converted into a numerical

representation, modified by the computer, and then converted back into a light representation in the EyeTap device. The device causes the eye itself to, in effect, become the camera.

When the eye itself, in effect, functions as a camera, and the retina itself, in effect, functions as a display, there is a new possibility for a connected collective HI.

Although I have working prototypes of the EyeTap technology, in order to perfect the EyeTap system for manufacture, there still remain some issues, such as to miniaturize the apparatus so that it will fit entirely within ordinary eyeglasses, including the computational portion that is presently built into an undershirt so that it can be concealed under the wearer's outer shirt.

#### 8. BREAKING THE BOUNDARY BETWEEN EDUCATION AND THE REST OF LIFE

I believe that one of the most enlightening discoveries arising from the "community of cyborgs" was that students took a personal interest in computing, once they had a "space" (mediated cyberspace) of their own. In particular, it appeared that when a student had a feeling of having his or her own computer, the usage of the computer entered into ordinary facets of day-to-day living, such as keeping in touch while walking around in normal life, or in applying computing to other endeavours, and in building new and interesting devices to connect to the computer that go beyond what is expected of the classroom or lab setting.

The difference between how the students regard these truly personal computers and how they might regard normal university computers is somewhat captured by the difference between ordinary clothing and prison uniforms. Where students had previously dutifully done their lab work, somewhat "dragging their feet", they now approached the subject with a passionate element of love of the subject matter, rather than duty to memorize the course material for the final exam. The "learn by being" approach meant that students assimilated the material into their ordinary day-to-day life. Exist Edbroke down the usual barrier between study and non-study, e.g., the artificial barrier that usually exists between "work" and "play" and the rest of life.

#### 9. EXISTED WITHOUT BEING A CYBORG

At the nexus of research and teaching, we have found a new approach, originally developed as a "school for cyborgs" but immediately applicable to many facets of education that have nothing to do with body-borne (wearable or implantable) computing devices.

As an example, these methods were applied to my ECE385 course, *Introduction to microprocessors*. Firstly, this involved the use of low cost personal computers. In the deconist tradition, students were encouraged to find an old

computer in a dumpster, or to purchase an old computer for approximately \$10 (or certainly not more than \$100). Instead of using the expensive computers in the lab, which were chained down, bolted down, and hooked up to an alarm, the students then brought their own computers into the lab. These being of low (or zero) cost, the students were taught to overcome fear in opening the computers up and hacking the internals.

Because the systems were the students' own computers, and not University property, a certain existential element prevailed, as well. For example, the students would bring the computers home with them, and apply what they learned in class. And students often innovated, and created, in a true free-spirited fashion.

Thus ExistEd was successful in a variety of other venues, outside the cyborg arena. This method was also applied in the author's ECE431 course (Digital Signal Processing) and ECE496 course (Design). Results were very successful. Provided below are some student quotes from the official anonymous Course Evaluation forms:

#### 10. CONCLUSION

Rather than conclude, I will attempt to also extrapolate into the future. Results are deconclusive, and thus meant to raise important questions about how we might drastically modify the way we teach, in order to teach the "stuff that matters to the student". In particular, by focusing on development of the student, as a human being, in the feedback loop of the learning process, we arrive at a new framework for teaching, in which the student takes personal interest in the subject matter, as it pertains to his or her own daily life. For example, sousveillance was presented as a form of action research (i.e., research that affects social change by conducting inquiry), that includes inverse surveillance. This led the students to create their own existential understanding equivoillance—the equilibrium between surveillance and sousveillance.

#### ENDNOTE

1. A customer falsely accused of shoplifting, and fatally shot in the back by a shopkeeper as she attempted to walk out of the shop.

#### REFERENCES

- Brown, S. & Rose, J. (1996). Fpga and cpld architectures: a tutorial. *IEEE Design and Test of Computers* 13(2), see also <http://wearcam.org/jayarpubs.html>.
- Cooperstock, J. & Buxton, B. (1995). Reactive room. Available at: <http://www.dgp.utoronto.ca:80/people/rroom/rroom.html>.

- Cooperstock, J. R., Fels, S. S., Buxton, W., & Smith, K. C. (1997). Reactive environments: throwing away your keyboard and mouse. Available at: <http://www.csl.sony.co.jp/person/jer/pub/cacm/cacm.html>.
- Goffman, E. (1959). *The Presentation of Self in Everyday Life*. Garden City, New York: Doubleday.
- Jones, S. P. (1995). Turning the tables on video surveillance. *Technical Report*. Boston, Massachusetts: The Boston Herald (Monday, June 12).
- Mann, S. (1997a). An historical account of the 'WearComp' and 'WearCamp' projects developed for 'personal imaging'. *International Symposium on Wearable Computing*. Cambridge, Massachusetts, 66–73. (October 13–14) IEEE.
- Mann, S. (1997b). Smart clothing: the wearable computer and wearcam. *Personal Technologies* 1(1), 21–27. (March 1997b).
- Mann, S. (1998). Humanistic intelligence/humanistic computing: 'wearcomp' as a new framework for intelligent signal processing. *Proceedings of the IEEE* 86(11), 2123–2151+cover, (November 1998). Available at: <http://wearcam.org/procieee.htm>.
- Mann, S. (with Hal Niedzviecki). (2001). *Cyborg: Digital Destiny and Human Possibility in the Age of the Wearable Computer*. Randomhouse (Doubleday), ISBN: 0-385-65825-7 (November 6).

## Subject Index

- academic language development, 15, 441  
academic peer review, 26, 83, 179, 603, 662, 842, 1237–1244, 1247, 1248, 1370, 1371, 1578, 1584  
academic publishing online, 821–824, 826, 830, 832, 836, 837  
Academy for Educational Development (AED), 1518  
AccessForAll, 480, 481, 483, 485, 487, 494  
Access Grid Augmented Virtual Environment (AGAVE), 1291, 1306  
accessibility, 15, 17, 19, 194, 386, 470–472, 474, 479, 480, 482, 483, 486, 487, 492, 493, 584, 665, 688, 716, 746, 747, 780, 798, 799, 810, 830, 883, 886, 929, 977, 992, 1020, 1027, 1031, 1192, 1221, 1330, 1356, 1502  
accessible e-learning, 470, 471, 480, 483, 494  
ACCLIP, 480–483, 487  
ACCMD, 480–483, 487  
active learning, 398, 487, 491, 586, 691, 701, 702, 714, 715, 1406  
active participation, 27, 87, 686, 793, 806, 1061, 1062, 1176, 1440, 1506  
adaptive learning, 366, 395–399, 407, 408, 421, 469, 470, 487, 493, 684, 703, 996, 1332, 1431  
adaptivity, 395–397, 401, 405, 408, 409, 421  
add-on activity, 77  
administrative and information systems (AIS), 661  
ADSL, 746, 766, 1530, 1531, 1541  
ADSL telephony, 1541  
advanced medical research, 164, 166, 582, 1021, 1024, 1031, 1033, 1379  
adware, 1284  
a-feminist heterosexual ideologies, 134  
Afghanistan, 676, 678–680, 682, 684, 687, 1495, 1501, 1518  
Africa, 15, 151, 676, 724, 726–735, 738, 810, 930, 1517  
Africa (Sub-Saharan), 45, 731  
age compression, 1040, 1043–1045  
*aletheia*, 102  
alignment, 222, 223, 227, 229, 230, 235, 237, 238, 304, 316, 317, 1357  
alternative but equivalent content, 476  
alternative access systems, 472–474, 481, 492  
American Standard Code for Information Interchange (ASCII), 213, 214, 217, 430, 873  
animated pedagogical agents (APAs), 383–385, 402, 961 (*see also* avatars)  
animation, 234, 235, 255, 330, 376, 377, 383, 477, 500, 503, 511, 707, 924, 925, 931, 933, 953, 964, 1057, 1118, 1247, 1321, 1331, 1345, 1363  
anti-intellectualism, 207  
anxiety, 366, 368–371, 378, 382, 384, 389, 538, 625, 703, 771, 1023, 1024, 1026, 1027, 1098, 1099  
Apple computers, 66, 166, 209, 212, 654, 1344, 1350, 1363, 1367  
apprenticeship, 78, 280, 281, 283, 357, 529, 531, 534, 543, 546, 547, 550, 553, 555, 558, 811, 1224, 1347  
appropriate technology, 687, 1495, 1498, 1499, 1501–1503, 1508, 1509, 1512, 1515, 1517, 1518, 1520  
aptitude-treatment interaction theory, 395  
architecture, 5, 40, 51–54, 70, 113, 129, 130, 137, 164, 165, 196, 254, 285, 295, 357, 410, 411, 471, 486, 661, 790, 815, 862, 875, 891, 907, 926, 927, 1059, 1060, 1064, 1176, 1221, 1240, 1264, 1282, 1325, 1342, 1373, 1375, 1376, 1542, 1543, 1585  
Architecture and Tools for Linguistic Analysis Systems (ATLAS), 1375  
Argentina, 726, 728, 729, 733, 734, 772, 775–779, 781, 784, 785, 1041  
artificial intelligence (AI), 106, 107, 164, 165, 281, 282, 292, 293, 295, 718, 922  
associative learning, 401, 402, 406  
astronomical imagery, 1357, 1358  
asymmetric communication, 225, 227  
asymmetric encounter, 227  
asymmetric interactional dynamics, 222, 235  
Asynchronous Learning Networks (ALNs), 83, 84  
attendance, 19, 321, 331, 338, 340, 345, 347, 352–354, 360, 632, 1399, 1436, 1439  
attentional economy, 1000, 1001, 1004, 1005, 1007, 1009–1012, 1014, 1015

audience geography, 1185  
 Australia, 17, 20, 29, 145, 269, 301, 313,  
     330, 334, 348, 365, 371, 372, 448, 526,  
     581, 609, 611–613, 617, 619, 620, 638,  
     699, 711, 712, 716–718, 727, 732, 753,  
     769, 770, 783, 916, 918, 920, 921, 928,  
     932–935, 961–963, 972–974, 986, 987,  
     990–996, 1022, 1041, 1044, 1046,  
     1047, 1075–1078, 1148, 1197, 1198,  
     1251, 1257, 1267, 1300, 1415, 1418,  
     1525–1528, 1530–1534, 1536–1544  
 Australian Bureau of Statistics (ABS), 1044  
 Australian Communications Authority  
     (ACA), 1539, 1542–1544  
 Australian Competition and Consumer  
     Commission (ACCC), 1527, 1543  
 Austria, 1041  
 authentic activities, 281, 1225  
 automated editorial office, 836  
 authorial relationships, 1246  
 authoring practice, 479, 480  
 Authoring Tool Accessibility Guidelines  
     (ATAG), 479, 480  
 avatars, 40, 383, 425, 431, 930, 1094,  
     1295–1297, 1282, 1484, 1485, 1510  
 Avonlea village, 23, 1121–1123, 1125–1136  
  
 Bahrain, 743, 1041  
 Balkan press, 1050  
 bandwidth, 202, 339, 436, 472, 476, 480,  
     626, 663, 685, 728, 767, 777, 931,  
     1180, 1181, 1184, 1195, 1283, 1400,  
     1413, 1423, 1440, 1502, 1525, 1526,  
     1534, 1541, 1543  
 Bangladesh, 676, 678–681, 683, 738, 743,  
     755  
 Barbie Doll software, 587, 588  
 Belgium, 1041  
 betweenness centrality, 1436  
 Bhutan, 755  
 big Other, 1552–1556, 1562–1566  
 binaural sound, 37  
 biological-determinist ideology, 119  
 biopolitics, 118, 130, 148, 169  
 biopower, 108  
 biotechnology, 96, 98, 108, 109, 129–132,  
     150, 765  
 Birla Institute of Technology and Science  
     (BITS), 753  
 Blackboard, 198, 202, 362, 617, 728, 776,  
     789, 804, 807, 812, 1092  
  
 blended mode, 64, 77 (*see also* mixed mode)  
 blogfolios, 1219  
 blogosphere, 1216–1218, 1225, 1231, 1243  
 blogroll, 1242–1245  
 blogs, 26, 249, 254, 265, 430, 618, 877, 891,  
     945, 946, 964, 1092, 1104, 1190, 1209,  
     1216, 1227, 1229, 1230, 1242–1245,  
     1266, 1369, 1430, 1433, 1437, 1510,  
     1511  
 bounded groups, 858, 864, 1431  
 Brazil, 162, 211, 726, 730, 731, 733, 734,  
     772, 775–779, 781, 782, 784–786, 795,  
     796, 1041, 1047  
 breakdown situations, 225  
 brick-and-click, 528, 653  
*bricolage*, 275, 291, 292, 996  
 British National Cancer Research Institute  
     (NCRI), 1024  
 broadband, 29, 472, 645, 685, 700, 701, 710,  
     740–742, 746, 762, 764, 935, 966, 976,  
     1525–1540, 1542–1545  
 Broadband Advisory Group (BAG), 1533,  
     1536–1538  
 broadband development, 1526, 1533, 1537,  
     1543  
 Broadband Services Expert Group (BSEG),  
     1533, 1534, 1538  
 broadband technologies, 29, 1526, 1533,  
     1540  
 BrowserSpy, 1183  
 business models, 12, 197, 201, 474, 492,  
     622, 626, 641, 808, 877, 1279  
 business network, 203  
  
 cable services, 1539  
 CALVIN project, 1295, 1296  
 Cambodia, 758, 767, 768  
 Canada, 23, 24, 59, 61, 62, 67, 74, 75,  
     77–80, 88, 89, 161, 162, 279, 301, 302,  
     329, 330, 338, 345, 346, 360, 371, 426,  
     442, 448, 454, 456, 459–461, 486, 487,  
     492, 497, 501, 563, 586, 612, 743, 756,  
     769, 770, 772, 789, 812, 1015, 1041,  
     1046, 1069, 1077, 1078, 1123–1125,  
     1129–1132, 1134, 1136, 1148, 1151,  
     1185, 1186, 1188, 1203, 1255, 1397,  
     1398, 1403, 1409, 1417, 1419, 1425,  
     1443, 1571, 1575, 1586  
 capitalism/ist, 12, 101, 110, 118, 119, 122,  
     125, 127–130, 133, 134, 136, 138–140,  
     148, 151, 160, 162, 168, 173, 175, 189,

190, 192, 193, 196–204, 262, 340, 609, 629, 636, 639, 642, 644, 647, 667, 729, 778, 984, 1001, 1109, 1489, 1550, 1565

Carnegie Academy for the Scholarship of Teaching and Learning (CASTL), 1351

categorizing activity, 1454

CAVE Research Network (CAVERN), 1294

CAVERNsoft, 1294

CCD chip, 1342, 1343

CD-ROMs, 176, 254–256, 348, 359, 662, 705, 747, 757, 1008, 1171, 1307, 1329, 1376, 1377, 1415

cell phones, 1, 43, 46, 269, 272, 471–473, 533, 1000, 1369, 1380

Center of Education Technology (CET), 753

centrality, 50, 54, 265, 446, 852, 963, 965, 1016, 1029, 1166, 1435, 1436, 1514, 1517

CGI proxies, 1208

chalk-and-talk pedagogy, 272

child-centered approach, 229, 446

Child Language Data Exchange System (CHILDES), 1375

Chile, 676, 678, 710, 1041, 1340

chimeras, 110, 118, 142, 144, 889

China, 9, 17, 83, 313, 360, 676, 678–681, 683, 690, 695, 699, 703–705, 707, 716, 753, 761–763, 771, 809, 996, 1050, 1205, 1208, 1222, 1583

China Education and Research Network (CERNET), 705

Christian creationism, 119

Chromosoft Mirrors, 11, 1171, 1172

Citizen Lab, 1203, 1209

class, 12, 24, 66, 70, 72–74, 76, 78, 104, 108, 122–128, 132, 133, 136, 138, 139, 175, 176, 178, 180–182, 201, 243, 244, 249, 251, 264, 272, 285, 287, 290, 310, 311, 321, 336, 337, 339, 348, 353, 362, 385, 431–433, 441, 446, 453–455, 457–461, 464, 465, 470, 481, 482, 485, 491, 499, 501, 505, 507, 509, 514, 516, 518, 533, 534, 536, 555, 586, 589, 617, 655, 658, 659, 663, 665, 666, 694, 716, 744–746, 752, 771, 775, 812, 833, 856, 860, 861, 875, 878–881, 886–888, 907, 921, 931, 940, 941, 943, 945, 964, 971, 973, 984, 990, 1000, 1011, 1013–1015, 1073, 1074, 1076, 1078, 1090–1092, 1096–1100, 1102, 1104, 1117, 1151, 1158, 1159, 1162, 1165, 1221, 1222, 1225, 1226, 1228–1230, 1245, 1254, 1257, 1259, 1277, 1308, 1310, 1314, 1350, 1356, 1357, 1397, 1417, 1451, 1475, 1478, 1491, 1573, 1574, 1591

class consciousness, 122

clicking, 254, 255, 476, 488, 526, 556, 587, 823, 904, 945, 1252–1254, 1336

cmcMOO, 429

codification of knowledge, 192

co-evolution, 553, 906

cognitive apprenticeship, 280, 281, 529, 531, 550, 1347

cognitive enrichment, 175

cognitive science, 5, 14, 107, 281, 292, 294, 307, 402, 544, 676

cognitive trait model (CTM), 396, 397, 409–412, 414, 419–421

cognitive traits (CTs), 401, 402, 409, 412, 420, 421

cognitivist, 292, 402, 715

collaboration, 3, 22, 27, 43, 44, 53, 54, 59–63, 68, 71, 75, 77, 78, 80, 84, 85, 164, 165, 257, 274, 301, 302, 310, 319, 432, 451, 458, 465, 472, 487, 516, 519, 567, 568, 584, 620, 641, 701, 709–712, 718, 725, 741, 755, 761, 771, 791, 792, 794, 799, 807, 809, 907, 908, 932, 942, 1032, 1033, 1204, 1222, 1225, 1232, 1253, 1254, 1257, 1263–1266, 1289, 1293, 1294, 1296, 1297, 1307, 1310, 1313, 1314, 1317, 1318, 1321, 1330, 1331, 1337, 1338, 1343, 1361, 1370, 1372, 1375–1377, 1381, 1395, 1397, 1398, 1405, 1416, 1419, 1424, 1430, 1432, 1438, 1505, 1560

collaborative learning, 21, 27, 59, 60, 63, 67–69, 72, 75, 78, 84, 85, 88–90, 269, 273, 385, 493, 508, 686, 707, 708, 710, 810, 932, 1024, 1026, 1065, 1253, 1264, 1265, 1289, 1294, 1307, 1309, 1324, 1506

collaborative learning environments (CLN), 1289, 1299, 1300, 1307, 1308

collaborative text-based VLEs, 425

collaborative virtual (learning) environments (CVEs), 210, 211, 215, 426, 437

Collaborative Visualization (CoVis), 1362

collaborative web publishing, 1216, 1218, 1220, 1221, 1223–1225, 1228–1233

collaborative website (CoWeb), 1264, 1265

collative variability, 369

collective responsibility, 483, 485, 611, 1172  
 collusion, 221, 223, 225, 230, 234, 235  
 command-control-communication-intelligence (C<sup>3</sup>I), 118, 121, 131, 141  
 commitment, 68, 69, 75, 76, 84, 91, 98, 101, 103, 107, 176, 177, 198, 229, 282, 474, 568, 572, 592, 615, 626, 642, 667, 674, 717, 737, 765, 787, 795, 825, 867, 875, 1141, 1414, 1437, 1499, 1531  
 commodification, 134, 137, 194, 197, 198, 202, 216, 632, 986, 1115, 1123, 1124  
 commoditization model, 198  
 commoditization, 201  
 Common Pool Resourcing (CPR), 1498–1500, 1502  
 communalism, 979  
 communications sciences, 109, 130–132  
 communication(s) technologies, 54, 60, 65, 67, 96, 109, 130, 131, 133, 135, 207, 242, 248, 301, 306–310, 320, 321, 499, 500, 504, 508, 525, 533, 609, 613, 668, 673, 685, 690, 715, 724, 737, 739, 747, 764, 780, 925, 996, 1020, 1034, 1050, 1070, 1073, 1091, 1097, 1151, 1154, 1204, 1230, 1232, 1495, 1507, 1525, 1527, 1533  
 communitarian, 170, 874, 961, 991  
 communities of inquiry, 385, 454  
 communities of learners, 54, 367, 385  
 communities of practice, 14, 16, 17, 61, 64, 65, 84, 274, 283–285, 289, 563, 564, 566, 568, 570, 576, 605, 789, 793, 794, 805, 806, 810, 856, 860, 865–868, 906, 978, 1067, 1443  
 community design models, 1495  
 compact disk (CD), 176, 254–256, 348, 359, 662, 685, 705, 744, 747, 757, 905, 1008, 1275, 1307, 1329, 1376, 1377, 1415, 1416  
 competence models, 396, 421  
 Completely Open Source, Headers, Engineering and Research (COSHER), 1584, 1585  
 Complex Programmable Logic Devices (CPLDs), 1581, 1582  
 composition pedagogy, 179  
 composition studies, 159, 160, 170, 178, 181  
 computational complexity, 228  
 computational media, 221, 222, 225, 238  
 computer architecture, 164  
 computer-assisted instruction (CAI), 167, 348, 358, 373  
 Computer-Assisted Language Learning (CALL), 708  
 computer-assisted learning, 215, 366, 1310  
 computer-based applications, 305  
 computer-based gaming, 1002, 1003  
 computer-based imaging systems, 165  
 computer-based patient simulations (CBPS), 1021  
 computer conferencing, 59–73, 75, 79, 80, 84, 90, 852, 853, 868  
 computer games, 21, 43, 222–226, 228, 238, 389, 633, 730, 781, 962, 990, 1001, 1002, 1313–1315, 1483  
 computer-generated experience, 37  
 computer generated objects, 37  
 computer graphics, 37, 1290, 1308, 1361  
 computer instrumentalism, 100  
 computer-mediated communication, 65, 74, 79–81, 445, 658, 662, 668, 859, 861, 957, 1085, 1091, 1151, 1177, 1429, 1431–1434, 1437–1440, 1449  
 computer-mediated hypertext, 254  
 computer-mediated learning, 469, 1020, 1032  
 computer-mediated learning environments, 1020, 1032  
 computer-mediated simulation, 37  
 computer-mediated sister-class projects, 442, 446, 453, 454  
 computer-mind analogy, 106  
 computer networking, 60, 68, 71, 75–77, 84, 90, 92, 445, 849  
 Computer-Supported Collaborative Learning (CSCL), 708, 710, 1253, 1254, 1449, 1453, 1455, 1461, 1463  
 Computer-Supported Collaborative Software (CSCS), 1294  
 computer-supported composition  
     classrooms, 159, 160, 178, 179  
 computer-supported literacy, 175  
 concreteness, 399, 400, 403–407  
 configurational validity, 295  
 connectionism, 293  
 connections MOO, 427  
 constellation, 51, 201, 243, 248, 262, 294–296, 599, 1112, 1349  
 constructionist/ism, 13, 15, 26, 212, 280, 290–294, 296, 297, 1297, 1518, 1521, 1572–1574, 1580



constructivist/ism, 7, 27, 31, 98, 108,  
 111–113, 202, 270, 273–275, 290, 291,  
 307, 311, 312, 321, 367, 378, 383, 384,  
 404, 408, 435, 441–443, 445–447, 449,  
 455, 505, 546, 557, 566, 701, 709, 710,  
 712, 714, 715, 789, 803, 814, 900–902,  
 918, 926–928, 933, 999, 1020, 1035,  
 1223, 1344, 1381, 1406, 1425, 1427,  
 1525  
 constructivist pedagogy, 275, 441, 446, 447,  
 710, 900, 901, 1425  
 contiguity, 377  
 continual transformation, 282  
 contraband, 1575  
 control gloves (*see* gloves),  
 Conversations on Society and Child  
 Development (CSCD), 1416–1418  
 copyright, 197, 199, 257, 492, 620, 636, 657,  
 700, 976, 1141, 1142, 1145, 1149,  
 1220, 1272–1277, 1279, 1280,  
 1284–1287, 1576  
 corporatization, 202, 630, 634  
 COSHER software, 1584, 1585  
 cost-effectiveness, 74, 83, 167, 442, 659,  
 705, 1023, 1324, 1451, 1531  
 Council on Library and Information  
 Resources (CLIR), 899  
 crackers, 25, 1071, 1203  
 creative play environments, 928, 929  
 critical computer literacy, 252  
 critical media literacy, 250–252, 254,  
 255  
 critical media pedagogy, 251  
 cross-case analysis, 505  
 cultural artefacts, 26, 280, 284, 1271, 1272,  
 1286, 1314, 1366  
 cultural expression, 1068  
 cultural/culture hacker, 1486, 1487  
 cultural hybridity, 1075  
 cultural marginalization, 1072  
 cultural models, 197, 201  
 cultural reproduction, 23, 230, 235, 1107  
 cultural topologies, 216  
 Customer Access Network (CAN), 1541  
 customized instructional design, 395  
 cyber-community, 1505, 1511  
 cybercowboy, 1469  
 cyberculture, 169, 252, 253, 256, 259–261,  
 263, 265, 266, 968, 1002, 1476, 1480,  
 1482, 1490  
 cyberdemocracy, 96  
 cyberfeminist/ism, 1467, 1481, 1482, 1487,  
 1488  
 cyberfeminist virus, 1468  
 cybergrrls, 1487  
 cyberimaginery, 1468  
 cybernetic organisms (*see* cyborgs)  
 cyberpedagogy, 269, 273  
 cyberpunk fiction, 169  
 cyberschool, 275, 654–661, 663, 665, 667,  
 668  
 cyberspace, 2, 11, 22, 28, 47, 166, 168, 170,  
 181, 190, 191, 249, 256, 273, 348, 355,  
 613, 644, 724, 744, 789, 795, 807, 809,  
 966, 967, 990, 1049, 1067, 1089, 1090,  
 1092, 1094, 1095, 1097, 1099, 1100,  
 1103, 1104, 1151, 1166, 1177, 1272,  
 1277, 1287, 1468, 1470, 1476, 1477,  
 1482, 1485, 1487, 1490, 1496, 1498,  
 1501–1505, 1510–1512, 1520, 1554,  
 1564, 1565, 1567–1569, 1590  
 cyborg consciousness, 169  
 cyborg epistemology, 1571  
 cyborg feminist/ism, 125  
 cyborg heteroglossia, 148, 181  
 cyborg logs, 1579, 1580, 1587  
 cyborg metaphor, 168  
 cyborg politics, 118, 142, 161, 167, 178  
 cyborg primitives, 1571  
 cyborgs, 108, 110, 117–121, 136, 140–144,  
 146, 147, 159–161, 209, 215, 1575,  
 1576, 1590  
 cyborg skills, 169  
 cyborg writing, 141, 148, 181, 182  
 Czech Republic, 371, 372, 1041  
 data analysis, 537, 596, 1363, 1371, 1454,  
 1455, 1463  
 databases, 27, 73, 164, 198, 202, 254, 265,  
 302, 350, 385, 429, 484, 571, 579, 582,  
 585, 600, 602, 606, 618, 754, 809, 824,  
 827, 837, 852, 853, 856, 868, 929, 936,  
 951, 987, 993, 994, 1024, 1042, 1045,  
 1048, 1142, 1148, 1187, 1239, 1241,  
 1245–1247, 1256, 1261, 1290, 1294,  
 1326, 1358, 1366, 1369, 1376, 1379,  
 1387, 1571  
 data packet, 1181, 1192, 1194–1197  
 debugging, 1176, 1200  
 declarative memory, 413  
 decoding, 227, 230, 238, 254, 405, 1186,  
 1195, 1197, 1240, 1241, 1490

deconstruction, 143, 146, 258, 486, 1070, 1507, 1518–1520, 1573, 1574, 1577, 1580  
 deep learning, 561, 1049, 1299  
 Defense Advance Research Projects Agency (DARPA), 61, 69, 164, 167  
 democratic development goals, 682  
 democracy, 12, 19, 21, 28, 96, 111, 116, 162, 168, 173, 177, 242–250, 257, 260, 262, 266, 340, 581, 584, 665, 686, 729, 778, 780, 794, 1039, 1040, 1042, 1043, 1047–1051, 1112–1114, 1116, 1117, 1119, 1232  
 democratization, 243, 245, 247, 250, 256, 259–262, 269, 726, 729, 730, 779, 780, 1025, 1204  
 democratizing education, 260  
 Denmark, 372, 1041, 47  
 deregulation, 113, 332, 620, 625, 636, 641, 649  
 design for development, 1503  
 desired end-state, 229  
 determinism/determinist, 39, 99, 100, 111, 119, 120, 128, 132, 247, 1067, 1526  
 development industry, 1497, 1504  
 Deweyan (experimental) education, 243, 246, 247, 262  
 Deweyan perspective, 258  
 diagram analysis, 1356, 1357, 1364  
 DiaLogos project, 447, 454–458, 460, 462, 463, 465  
 diasporic web communities, 22, 1167–1172, 1174–1186  
 Difference Engine, 170  
 digital age, 1, 13, 14, 16, 18–20, 27, 31, 272, 514, 922, 1203  
 digital artifacts, 192, 195, 196, 198, 920, 1287, 1368  
 digital audio tape (DAT), 1276, 1277  
 digital divide, 8, 16, 17, 19, 28, 29, 31, 48, 207, 243, 244, 262, 263, 436, 444, 525, 547, 677, 682, 704, 730, 736, 737, 740–742, 756, 761, 764, 780, 1090, 1100, 1151, 1166, 1178, 1495, 1496, 1501  
 digital goods, 190  
 Digital Interactive Video Exploration and Reflection (DIVER), 1321–1323, 1327, 1329–1331, 1334–1347, 1349, 1350, 1353–1359, 1363, 1365–1372, 1375–1378, 1380–1382  
 digital library, 483, 584, 591, 605, 755, 854, 895, 898–900, 906  
 digital literacy, 175, 178  
 Digital Millennium Copyright Act (DMCA), 1273  
 digital signal processing, 1591  
 digital technologies, 2, 11, 12, 21, 23, 29, 191, 207, 269, 286, 497, 500, 501, 503, 504, 510, 514, 520, 521, 618, 623, 659, 665, 922, 1001, 1002, 1007, 1090, 1094, 1097, 1248, 1287, 1397, 1419, 1468, 1498, 1499, 1501, 1510, 1520  
 digital technology revolution, 12, 207  
 Digital Video Collaboratory (DVC), 1321, 1370–1372, 1374–1378  
 digitalization, 191, 616, 648, 653, 669, 1552  
 digitized body, 1476  
 direct access, 473, 605, 916, 1046, 1229, 1472  
 direct high-speed connections, 303  
 discovery-based learning environments, 384  
 disk drives, 481  
 Disney effect, 1107, 1111  
 distance education (DE), 727, 733, 736, 744–748, 751, 757, 762, 763, 769–771, 999  
 distributed cognition, 285, 525, 527, 529, 531, 544, 550, 556, 1450  
 distributed constructionism, 13, 296  
 Distributed Denial of Service (DDoS), 1212  
 Dive software, 1334, 1335  
 Dolby THX, 1282  
 domain complexity, 43, 46, 47  
 domain experience, 14, 408  
 dominant codes and ideologies, 251  
 DOS-based software, 166  
 double aspect theory, 101  
 DVDs, 1, 254–256, 272, 441, 684, 966, 977, 987, 988, 1273  
 downtime, 961, 984  
 dystopianism, 99  
 e-activism/ist, 1042, 1049 (*see also* hacking, hacktivism)  
 e-chaupal, 756  
 e-commerce, 279, 658, 753, 756, 766, 767, 780, 850, 940, 993, 1177, 1345, 1534  
 e-democracy, 19, 21, 581, 794, 1039, 1040, 1047, 1048, 1051  
 e-forums, 856, 857, 862, 864–866  
 e-governance, 727, 775, 1040–1042, 1046, 1048, 1049, 1051

e-government, 1040–1042, 1046, 1049, 1051

e-learning, (*see also* online education), 12, 15, 59–64, 66, 68, 70, 71, 74, 76–80, 82, 83, 86–92, 345, 350, 469–474, 477, 480, 481, 483, 491, 494, 525–528, 531, 536, 539, 546, 554, 555, 617, 619–622, 625, 653, 654, 656, 659, 662, 664, 667, 668, 670, 673–678, 680, 689, 693–695, 713, 714, 718, 724, 726, 727, 731, 733, 741, 742, 751–758, 762–765, 767, 769, 782, 784, 835, 850, 852, 863, 866, 867, 1019, 1020, 1253, 1256, 1257, 1261, 1266, 1322, 1325, 1326, 1328, 1431

e-learning environments (E-LEs), 60, 78, 86, 90, 470, 471, 494, 525, 528, 654, 677, 680, 1020–1023, 1257

e-learning initiatives, 713, 752

e-learning research, 64, 78, 79, 82, 83

e-learning resources, 480

e-learning systems, 472, 481

e-library, 19, 350, 895, 596, 598–903, 905–911

e-portfolios, 1219, 1227, 1228

e-presence interactive media, 27, 1395, 1397–1400, 1419, 1422–1424

e-publishing, 1328

e-services, 1040

early child development, 1296, 1398, 1403, 1404, 1417, 1422, 1424

Early Child Education (ECE), 1419, 1420

economic growth, 95, 96, 174, 279, 683, 759, 762, 1497

ecological approach, 280, 292, 294

ecologies of knowledge, 280, 285

ecology, 128, 131, 148, 177, 189, 191, 245, 280, 289, 294, 295, 525, 531, 542, 545–558, 625, 640, 693, 804, 1217, 1502, 1519, 1520

ecology(ies) of learning, 245, 294, 525, 540, 542, 545, 558

economic competitiveness, 677, 680, 681, 683, 684, 686

education for all, 723, 738, 771, 810

education metacenters, 928, 929

education strategic plan, 675, 677

educational approach 62, 63, 92, 507, 724 (*see also* pedagogy),

educational cyberfrontier, 1467

educational goals, 233, 259, 307, 322, 448, 620, 674, 676, 677, 680, 683, 688, 693–695, 821, 829, 831–834, 836, 1114, 1310

educational modernity, 112

educational MOOs, 427, 429

educational software, 221, 228, 229, 379, 692, 1364, 1577

educational technology, 14, 207, 279, 280, 290, 293, 302, 308, 318, 367, 506, 583–585, 593, 596, 601, 606, 657, 659, 673–677, 680, 682, 691, 693, 695, 717, 724, 727, 738, 740, 744, 745, 747, 755, 758, 769–771, 793, 857, 1215, 1220, 1232, 1233, 1467

Educational Testing Service (ETS), 1355

Educators' Exchange (EdX), 590–593, 595, 596, 598, 600

EduCause, 200, 664

Egypt, 60, 253, 743, 1369

electracy, 1039

electronic consultation, 1042

electronic controllership, 1042

electronic engagement, 1042

electronic environments, 160, 182, 366, 385, 466, 849, 858, 900, 903–905, 909

electronic field trips, 91, 924, 930, 931, 934

electronic mailing lists, 774, 1151

electronic productivity, 1042

electronics, 108, 131–133, 137, 138, 141, 143, 147, 162, 669, 733, 776, 784, 1527, 1541, 1587

electronic service delivery, 1042, 1045

electronic village, 553, 654

electronic voting, 1042

electronic workflow, 1042

embedded information, 272, 398

emergent AI, 293

enCore, 427, 429, 434, 436–438

enCoreXpress, 429

enculturation, 197, 1223

endogenous growth theory, 95 (*see also* new growth),

endogenous networks, 1245, 1247

enframing (*Gestell*), 38, 100, 102, 104, 1007

engaged learners, 1175, 1176, 1300

Enlightenment science, 97, 243, 1430, 1473, 1554, 1567

entry condition, 991

enunciative space, 567, 568, 570, 575–577

environmental impact, 1359, 1498, 1501

epistemological styles, 295

epistemological attitudes, 295

equivoillance, 1582, 1591

ergodic media, 1039

escapism, 1107, 1109

essentialist/ism, 40, 103–105, 109, 111, 112,  
 124, 127, 161, 295, 1482, 1486  
 Estonia, 793, 795, 1041, 1047  
 ethnicity, 172, 1072, 1073, 1075, 1076, 1084  
 ethnic minorities, 1084  
 evocation, 295, 1118, 1536  
 ExistEd, 1591  
 exogenous networks, 1242–1247  
 experience of flow, 381  
 Experiential-Cognitive Therapy (ECT), 1024  
 expert systems, 107, 129, 164, 708, 852  
 Exploration Space Control (ESC), 397, 398,  
 401, 407, 408, 421  
 Exploration Space Control Elements  
 (ESCE), 400  
 Exploration Space Control Formalization  
 (ESCF), 401  
 exploration tasks, 395  
 Explorer web browser, 45, 428, 429, 1241  
 extraterrestrial warfare, 135  
 EyeTap, 1572, 1573, 1589, 1590  
  
 Faculty Development Initiative (FDI), 653,  
 657  
 fandom, 251, 962, 1141–1143, 1145–1148,  
 1152–1154, 1161  
 fanfiction/fanfic, 1149, 1152–1155, 1159,  
 1161, 1162, 1165  
 female hacktivists, 1487  
 female protagonists, 1119, 1481, 1483–1485  
 feminization of poverty, 133  
 feminism/ist, 5, 12, 69, 98, 108, 109, 112,  
 117–130, 132, 134–136, 138–142,  
 144–151, 159–161, 169, 170, 177, 181,  
 612, 989, 1016, 1093, 1098, 1102,  
 1161, 1239, 1467, 1480–1482,  
 1485–1488  
 fibre-optic broadband networks, 1539  
 Fifth Dimension After-School Club (5thD),  
 228–230, 233, 235, 239  
 Fifth Generation of computers, 165  
 file transfers, 26, 887, 967, 1148,  
 1272–1274, 1282, 1283, 1373  
 filters, 200, 314–316, 520, 1050, 1134, 1205,  
 1208, 1380  
 Finland, 301, 313, 372, 726–731, 733–735,  
 740, 742, 772, 774–779, 781, 782,  
 784–789, 1041  
 formal learning, 6, 16, 17, 207, 358, 632,  
 723, 789–793, 796–799, 806, 810,  
 812–816, 919, 1015, 1016, 1063, 1324,  
 1346  
 formulaic responses, 234  
 frames of reference (FORs), 38, 380, 874,  
 901  
 France, 75, 146, 290, 611, 984, 1022, 1035,  
 1041, 1050, 1221, 1290  
 Free-market capitalism, 173  
 Freenets, 209  
 Frequently Asked Questions (FAQ), 25, 949,  
 1159, 1175–1177, 1188, 1192, 1265  
 functional relations, 229  
 functional transparency, 236  
 funding, 7, 68, 69, 113, 167, 175, 202, 264,  
 351, 360, 428, 429, 433, 437, 526, 540,  
 586, 611, 612, 626, 630, 637, 638, 641,  
 642, 656, 658, 667, 674, 677, 680, 725,  
 730, 740, 771, 780, 795, 895, 977,  
 1136, 1151, 1154, 1178, 1419, 1431,  
 1436, 1514–1516, 1518, 1534  
  
 gaming, 19, 21, 221, 224, 272, 273, 426, 429,  
 747, 774, 979, 999, 1002, 1003, 1006,  
 1012, 1016, 1294, 1313, 1315, 1467,  
 1482, 1484, 1485, 1487, 1488, 1531  
 gatekeeper, 26, 581, 644, 676, 677, 691–694,  
 724, 1437  
 Gateway to Educational Materials (GEMs),  
 1351, 1374  
 gender, 7, 12, 24, 28, 47, 48, 98, 108, 118,  
 122, 124, 126–128, 132, 134–136, 138,  
 139, 142, 144–147, 149, 159, 168, 170,  
 171, 178, 180–182, 243, 244, 249, 251,  
 295, 380, 388–390, 431, 504, 586–588,  
 590, 600, 601, 607, 682, 683, 725, 730,  
 735, 737, 739, 759, 780, 875, 880, 975,  
 989, 1003, 1073, 1074, 1076, 1077,  
 1079, 1089–1091, 1094, 1095, 1097,  
 1099, 1100, 1103–1105, 1112, 1119,  
 1124, 1130, 1131, 1151, 1154, 1166,  
 1309, 1314, 1386, 1434, 1449,  
 1452–1456, 1459–1461, 1464,  
 1467–1469, 1476, 1479, 1481, 1484,  
 1488, 1490, 1574  
 gender-flexing, 295  
 gender in education and technology, 1468  
 genealogical education/genealogy education  
 (GE), 941–954  
 General Agreement on Trade in Services  
 (GATS), 632, 750  
 General Public License (GPL), 210, 1204  
 genetic engineering, 110, 129, 132, 145, 150,  
 1031  
 genre recognition, 235

GeoWall, 1291, 1306, 1310  
 Germany, 162, 163, 346, 371, 372, 610, 660,  
 756, 810, 1035, 1041, 1129, 1186, 1255  
*Gestell*, 38, 102  
 Getty Museum, 1367  
 Gifted Program, 499  
 globalization, 16, 29, 242, 247, 330, 332,  
 341, 472, 609, 632, 636, 642, 646, 648,  
 662, 695, 714, 723–726, 728, 729, 736,  
 750, 778, 779, 1073–1075, 1082, 1084,  
 1090, 1092, 1497, 1519, 1537  
 global online education, 14, 17, 723–725,  
 737, 740, 742, 774  
 global online education questionnaire, 17,  
 725, 772, 774  
 global top-level domains, 1186  
 Global University System (GUS), 725,  
 740–743  
 global village, 207, 680, 1554  
 global virtual organizations, 723, 789  
 glocal network, 1503  
 gloves, 37, 47  
 gMUD, 427  
 Gnu Image Manipulation Program (GIMP),  
 1585  
 GNU Linux, 1204, 1577, 1578  
 Gnutella, 1272, 1274  
 goal directed, 230, 234  
 Goals, Operators, Methods and Selection  
 Rules (GOMS), 410, 420  
 goggles, 37, 42, 43  
 good programming practice, 414  
 Google, 20, 209, 494, 885, 899, 903, 906,  
 908, 951, 1027, 1152, 1188–1191,  
 1206, 1207, 1243, 1244, 1353, 1481  
 grain, 285–287, 1497  
 Green Revolution, 134  
 group-centric model, 1431  
 group databases, 265  
 groupware, 194, 808, 850  
 GUI-based interfaces, 427  
 Guided Noticing, 1321, 1328–1332, 1339,  
 1344, 1347, 1350, 1357, 1358, 1360,  
 1363–1369, 1380, 1381  
 GUI'd MOOs, 427, 428  
  
 habitats, 145, 529, 554, 931, 966  
 hackers, 25, 151, 192, 210, 211, 215, 257,  
 266, 294, 426, 434, 504, 730, 781,  
 1049, 1050, 1176, 1203, 1204, 1217,  
 1218, 1278, 1470, 1471, 1479, 1480,  
 1486, 1487  
 hacktivist/ism, 22, 25, 1042, 1048–1050,  
 1203, 1204, 1208, 1209, 1212, 1213,  
 1486, 1487  
 hand-body tracking, 37  
 hand-held computing devices, 301, 1337  
 handheld PDAs, 43  
 haptic devices, 484, 485  
 haptic grid, 485  
 haptics, 37, 47, 484  
 hardware geography, 1185, 1200  
 hardware innovations, 1501  
 head-tracking devices, 37  
 Health on the Net Foundation Code of  
 Conduct (HONcode), 1030–1032, 1035  
 health seekers, 1019, 1021, 1025–1032  
 Heidegger, 38, 39, 55, 97–99, 101–107, 109,  
 112–114, 282  
 hermeneutic constructivism, 111  
 hermeneutics, 111, 135, 251, 255, 1366,  
 1368  
 higher education (HE), 610–612, 619,  
 621–627, 629–634, 637–643, 647–649,  
 655, 669, 704, 706, 709, 711, 712, 730,  
 737, 739, 741, 750, 761, 762, 764, 771,  
 775, 780, 825, 839, 840, 843, 895, 907,  
 910, 1097, 1160, 1257, 1321, 1326,  
 1350, 1516  
 high technology, 121, 138, 151, 152, 279,  
 654, 681, 728, 734, 777  
 high-tech boom, 1070  
 high-tech economy, 257, 266  
 high-tech information economy, 25, 261  
 historicism/ist, 111, 261  
 holist/ism, 32, 77, 119, 144, 147, 170, 289,  
 413, 421, 479, 774, 789, 790, 1290,  
 1361, 1477  
 home computer, 389, 514, 746, 874, 879,  
 886  
 homework economy, 132–135, 137, 143, 150  
 Hong Kong, 17, 321, 619, 699–701, 717,  
 769, 996, 1046, 1050, 1132  
 HTML, 212, 213, 425, 428, 475, 478, 480,  
 717, 812, 887, 953, 1148, 1257, 1337,  
 1458  
 HTTP (hypertext transmission protocol),  
 208, 916, 935, 1211  
 human–computer interaction (HCI), 402,  
 407, 542, 543, 547, 1449, 1578, 1582,  
 1586  
 human development, 198, 682, 1395, 1396  
 human elibrarian, 911  
 human genome project, 96

human-machine interaction, 225, 229, 234, 237, 238, 602, 1574, 1584  
 human-machine interface, 13, 222, 234, 236, 237, 1574, 1584  
 humanist/ism, 103–105, 109, 110, 112, 118, 124–128, 159, 247, 336, 507, 790, 792, 1092, 1104, 1105, 1316, 1317, 1577  
 humanistic intelligence (HI), 1577, 1578, 1585–1587, 1590  
 humanization, 247  
 Hybrid Fibre Cable Network, 1532, 1540  
 hybridity, 255, 1075  
 hybrid pedagogies, 275  
 hybrids, 110, 118, 143, 888, 1145  
 hypermedia, 295, 382, 395, 399, 407, 488, 1248  
 hypermedia technology, 399  
 hypertext, 92, 180, 181, 196, 253–255, 265, 271–273, 275, 662, 916, 945, 979, 1181, 1217, 1220, 1224, 1240–1242, 1244  
 hypertextual architecture, 254  
 hypertextual archives, 265  
 hyperworld, 544, 550, 555, 556  
  
 iBook, 1469  
 Iceland, 211–213, 301, 1041  
 icons, 19, 22, 23, 68, 135, 254, 271, 272, 428, 477, 547, 555, 981, 1059, 1093, 1100, 1123, 1130, 1132, 1211, 1257, 1272, 1277, 1278, 1280, 1281, 1286, 1297, 1312, 1475, 1501, 1550, 1554, 1559  
 ICT-based projects, 1508  
 ICT-driven economic boom, 1536  
 ICT policy-making, 675, 679, 767, 1536  
 identification, 117, 119, 123, 124, 137, 142, 144, 291, 340, 377, 379, 695, 823, 946, 972, 983, 986, 1061, 1073, 1074, 1099, 1157, 1196, 1280, 1281, 1304, 1380, 1480, 1481, 1509, 1513, 1515, 1554, 1556  
 identities, 21, 40, 42, 46–48, 54, 109, 110, 122, 123, 125, 136, 140–142, 146, 147, 149, 162, 169, 170, 224, 272, 273, 284, 431, 450, 451, 453, 454, 456, 464, 465, 566, 615, 739, 865, 867, 993, 1042, 1068, 1082, 1095, 1096, 1098, 1105, 1129, 1141  
 if-then conditions, 226  
 image analysis, 1356, 1357  
  
 immunobiology, 131  
 IMS accessibility, 482  
 inclusive e-learning, 15, 469  
 in-degree centrality, 1436  
 India, 9, 17, 248, 634, 676, 678–680, 683, 690, 692, 693, 723, 725, 726, 728, 732, 733, 735, 736, 750–758, 761–763, 772, 775, 777, 778, 780–789, 996, 1050  
 indigenous language software environments, 207, 1519  
 Indira Gandhi National Open University (IGNOU), 751, 758, 775, 782, 783  
 individual customization, 469  
 individual education plan (IEP), 566  
 individualized assessment, 275  
 Indonesia, 726–735, 743, 744, 758–760, 763, 767–769, 771, 772, 776–785, 787, 1050  
 inductive reasoning, 14, 401, 402, 404–406  
 inferential ability, 414  
*Infobahn*, 330, 525, 555  
 informal learning, 16, 17, 207, 723, 789–793, 796–799, 806, 810, 812–816, 919, 1063, 1324, 1346  
 informal learning environments (ILEs), 792, 793, 1063  
 Information and Communications Technology (ICT), 242, 244, 269, 271, 275, 365, 620, 673–696, 717, 730, 733, 735, 741, 751, 755, 759–761, 765, 767, 768, 772, 774, 780, 781, 784, 786, 787, 806, 1022, 1025, 1034, 1047, 1048, 1501, 1508, 1510, 1516, 1518, 1536–1538  
 information economy, 261, 279, 639, 979, 1002, 1007, 1537  
 information processing speed, 401, 402, 405, 406  
 information retrieval, 381, 382, 1380  
 information society, 9, 192, 200, 241, 253, 528, 673, 975, 999, 1007  
 information technology (IT), 15, 18, 189, 200, 204, 244, 246–248, 260, 263, 264, 266, 270, 274, 275, 337, 360–362, 365, 389, 405, 406, 425, 441, 444–446, 451, 452, 454, 455, 464, 465, 470–473, 503, 507, 548, 570, 586, 590, 592, 612, 624, 625, 629, 631, 655, 664, 671, 673, 679, 680, 683, 685, 689–912, 696, 699, 700, 706, 709, 710, 750–754, 756, 758–767, 775–777, 784, 849, 850, 852–854, 858, 862, 866, 867, 874, 906, 922, 935,

1029, 1074, 1232, 1251, 1257–1259,  
 1262, 1467, 1475, 1490, 1515, 1516,  
 1518, 1528, 1532, 1538  
 IT in Greek schools, 445  
 IT pipeline, 1467, 1468, 1490  
 (in)appropriate technology, 1495, 1496,  
 1498, 1499, 1501, 1503, 1508, 1509,  
 1512, 1515, 1517, 1518, 1520  
 informational artifacts, 196  
 informational capitalism, 12, 189, 190, 192,  
 193, 197, 199, 202, 204  
 informational dystopia, 204  
 informational power, 193–197, 203, 204  
 informational space, 192, 193, 195  
 informationalism, 189, 199, 203, 204  
 informative labels, (*see* metadata)  
 infotainment, 637, 643, 1050  
 infotech, 192, 195  
 Inquiry Learning Forum (ILF), 856–858,  
 862, 864, 865  
 in-school model, 334–337  
 Institute for Distance and Distributed  
 Learning (IDDL), 654–661, 663  
 institutionalized discrimination, 1574, 1575  
 instructional designs, 59, 72, 100, 366–368,  
 371, 377, 378, 380, 381, 387, 388, 395,  
 402, 405, 702, 753, 770, 772, 828, 1473  
 instructional roles, 59  
 instrumentality, 135, 168, 1115  
 integrated circuits, 108, 109, 117, 128, 132,  
 136, 141, 149, 150  
 integrated microcircuit technologies, 165  
 Integrated Temporal Multimedia Data  
 (ITMD), 1348, 1349  
 intellectual engagement, 584, 602–604, 606,  
 1005, 1010  
 intellectual property, 199, 492, 630, 635,  
 686, 967, 1141, 1207, 1218,  
 1272–1275, 1277, 1283, 1285, 1338  
 intellectual property rights, 630, 635, 686,  
 1277  
 intentionality, 282, 1107–1109, 1112  
 interaction, 3, 4, 6, 8, 11, 13, 23, 27–29, 31,  
 40, 41, 43, 46–54, 56, 60–63, 70, 72, 73,  
 78, 83, 87, 88, 130, 190, 193, 202, 217,  
 221–238, 242, 252, 254–256, 258, 259,  
 270, 273, 275, 286, 319, 331, 333, 335,  
 340, 355, 371, 377, 380–383, 386, 387,  
 395, 396, 402, 410–412, 419–421, 431,  
 433–435, 437, 449–451, 476, 497, 528,  
 540, 542, 545, 556, 558, 567, 569–575,  
 602–604, 616, 622, 623, 635, 655, 657,  
 660, 662, 664, 687, 689, 701, 710–712,  
 714, 718, 729, 745, 747, 755, 771, 778,  
 789, 799, 804, 806, 827, 829, 833, 834,  
 857, 858, 882, 886, 887, 926, 932–934,  
 941, 948, 949, 953–962, 1002, 1019,  
 1033, 1046–1048, 1063–1065, 1075,  
 1091, 1093, 1094, 1103, 1104, 1134,  
 1151, 1155, 1176, 1180, 1215, 1217,  
 1220, 1221, 1223, 1229, 1232, 1244,  
 1253, 1254, 1258, 1259, 1266, 1271,  
 1293, 1297, 1305, 1322–1325, 1327,  
 1329, 1331, 1333, 1337, 1341–1343,  
 1346, 1348, 1352, 1353, 1356, 1374,  
 1380, 1395, 1397, 1398, 1400, 1402,  
 1404–1406, 1408, 1409, 1411, 1416,  
 1419–1422, 1429, 1431, 1433–1435,  
 1442, 1443, 1449, 1451, 1461, 1492,  
 1504, 1505, 1507, 1513, 1519, 1526,  
 1533, 1536, 1543, 1544, 1578, 1586  
 interaction between people and machines,  
 225  
 interaction states, 410, 411  
 interactional capabilities, 222, 230, 232  
 interactional choice, 231  
 interactional dynamics, 221, 233, 235  
 interactional outcomes, 225  
 interactional range, 234  
 interactional resources, 225, 234  
 interactive, 9, 17–19, 21, 24, 27, 37, 41, 74,  
 90, 196, 202, 221, 222, 224–226, 229,  
 230, 233, 236–239, 242, 246, 252–255,  
 260, 270, 330, 341, 350, 351, 366, 368,  
 374, 380, 388, 427, 428, 432, 474, 483,  
 486, 488, 492, 528, 831, 537, 838, 569,  
 572, 616, 619, 622, 623, 643, 701, 702,  
 704, 706, 709, 737, 738, 754, 758, 770,  
 771, 796, 805–807, 829, 915, 917, 919,  
 923, 924, 926–928, 930, 935, 936, 941,  
 942, 944, 953, 954, 961, 962, 964, 980,  
 986, 988, 1002, 1039, 1040, 1042,  
 1045–1048, 1050, 1091, 1099, 1103,  
 1118, 1190, 1219, 1223, 1224, 1226,  
 1229, 1290, 1299, 1304, 1314, 1321,  
 1322, 1324, 1328, 1333, 1337, 1344,  
 1351, 1358, 1364, 1367, 1369, 1377,  
 1395–1400, 1416, 1417, 1419,  
 1422–1424, 1517, 1531, 1533, 1539  
 interactive informational technology, 233  
 interactive multimedia (IMM), 915–917,  
 924–927, 930, 933, 934

interactive websites, 643, 919, 923  
 interface, 13, 14, 16, 22, 37, 47, 67, 97, 129, 130, 202, 214, 221, 222, 225, 226, 229, 232–234, 236–239, 270–272, 274, 275, 381, 402, 410, 411, 426–429, 431, 437, 471, 475, 476, 478, 481, 486–488, 541, 542, 545, 546, 555, 648, 669, 737, 793, 809, 879, 891, 898, 933, 966, 1056–1058, 1090, 1092–1096, 1098, 1099, 1103, 1142, 1171, 1172, 1181, 1252, 1261, 1271, 1291, 1293, 1294, 1315, 1328, 1330, 1334, 1335, 1338, 1339, 1344, 1368, 1371–1376, 1399, 1401, 1415, 1416, 1423, 1434, 1454, 1578, 1581, 1582, 1587, 1588  
 interface devices, 37  
 intermediality, 273  
 intermental plane, 545  
 International Conference on Image Processing (ICIP), 1382  
 International Development Resource Centre (IDRC), 1518  
 International Review Boards (IRBs), 1378, 1379  
 International Telecommunications Union (ITU), 755, 768, 1534  
 Internet (the), 189, 293, 305, 776, 777, 781, 783–787, 805, 850, 883, 1034, 1172, 1177, 1368, 1479, 1480  
 Internet access, 266, 301–304, 307, 308, 310–316, 318, 359, 433, 444, 654, 685, 734, 750, 759, 762, 764–766, 768, 769, 777, 785, 786, 873, 950, 986, 1030, 1032, 1151, 1180, 1308, 1415, 1472, 1495, 1520, 1526–1528, 1530, 1536, 1539, 1541, 1575786,  
 Internet-based educational content, 736, 782, 939, 940  
 Internet-based knowledge, 207  
 Internet censorship, 994, 1203–1206, 1208, 1210  
 Internet Explorer, 428, 429, 1241  
 Internet fridge, 1527  
 Internet protocols (IPs):  
     FTP, 208, 1373, 1539  
     HTTP, 208, 916, 935, 1211  
     SMTP, 208, 214  
     TCP/IP, 208, 209, 1179  
     Telnet, 208, 427, 428, 1211  
 Internet-related skills, 313  
 Internet resources, 209, 316  
 Internet use, 23, 302–322, 372, 430, 727, 728, 755, 760–763, 765–768, 774, 776, 822, 874, 875, 877, 889, 963, 964, 967, 973, 975, 978, 1018, 1026, 1084, 1131–1134, 1154, 1178, 1202, 1212, 1271, 1273, 1274, 1526, 1528, 1530  
 interoperability, 471–475, 482, 492, 621, 909, 1372, 1375  
 interoperable application structure, 1375  
 interpretation, 3, 11, 24, 28, 30, 120, 135, 192, 214, 222–224, 226, 227, 229, 230, 233, 234, 237, 238, 251, 287, 295, 329, 332, 340, 372, 374, 375, 452, 476, 477, 539, 543, 604, 676, 715, 895, 901, 919, 922, 928, 932, 936, 1055, 1061, 1108, 1110, 1112, 1119, 1125, 1134, 1143, 1147, 1152, 1161, 1166, 1199, 1276, 1316, 1317, 1322, 1324, 1329, 1331–1334, 1341, 1349, 1354, 1365, 1366, 1370, 1371, 1378, 1381, 1468, 1484, 1490, 1499, 1559, 1573  
 interpretive dynamics, 233  
 interpretive process, 239  
 interpretive resources, 225, 233, 234  
 interpretive strategies, 287  
 Interstate New Teacher Assessment and Support Consortium (INTASC), 1355  
 invisible colleges, 17, 27, 65, 1430–1432  
 Iran, 743, 1124, 1206, 1209  
 Ireland, 673, 675, 678, 680, 685, 687, 1041, 1046, 1175, 1185, 1517  
 Israel, 92, 301, 303, 329, 330, 726–728, 730–735, 772, 775–779, 781–786, 1041, 1201  
 issues of fit, 311, 316  
 Italy, 75, 162, 1019, 1041  
 Japan, 17, 92, 143, 162, 163, 212, 217, 429, 647, 699, 707, 708, 710, 714, 723, 726–736, 740–743, 747, 770–772, 776–779, 781–787, 789, 796, 808, 812, 873, 967, 996, 1027, 1035, 1041, 1044–1046, 1059, 1124, 1132, 1222, 1290, 1380, 1489  
 Jennicam, 964, 967  
 Jhcore, 434  
 KaZaA, 26, 1272, 1283, 1284  
 Kenya, 726, 728, 729, 731–735, 772, 775, 777, 779, 781–786, 810  
 Kids Grow Older Younger (KGOY), 1044



knowledge categories, 849  
 knowledge construction, 7, 16, 84, 291, 377, 385, 408, 442, 566, 570, 573, 574, 577, 689, 693, 703, 805, 806, 1114, 1328, 1346  
 knowledge economy, 12, 59, 86, 95, 112, 564, 623, 628, 639, 643, 760, 1534  
 knowledge forum, 385, 710, 1396, 1425  
 knowledge management, 10, 13, 14, 17, 18, 471, 475, 584, 590, 591, 799, 849–854, 866, 867  
 knowledge transfer, 113, 395, 582  
 knowledge work, 59, 89, 564, 849  
 knowledge workers, 564, 849  
 Kuwait, 743, 1041, 1207  
  
 LambdaCore, 434  
 LambdaMOO server, 434  
 laptop computers, 275, 301, 314, 331, 471, 472, 501–503, 507, 514, 675, 1405, 1469, 1587  
 laptop program, 501, 502, 507, 514  
 latency, 1191–1194, 1196, 1294  
 lateral and cross-linked information, 273  
 Latin America, 89, 151, 726–734, 772, 775–779, 781–786, 796  
 learn by being, 1572, 1589, 1590  
 learn by doing, 1572, 1573, 1589  
 learn by doing and creating, 1572  
 learner-generated goal, 387  
 learner modeling techniques, 14  
 learning effectiveness, 83, 86, 708  
 Learning Games Initiative (LGI), 1313–1315  
 learning in an online community, 1449  
 learning management systems (*see* e-learning environments),  
 learning object repositories (LORs), 483, 485, 486  
 learning objects, 17, 72, 380, 417, 419, 448, 482, 483, 485–488, 491, 494, 713, 714, 717, 896, 910  
 learning outcomes, 92, 365, 368, 370, 373–375, 378, 381, 382, 384, 385, 387, 390, 469, 475, 929, 941, 1015, 1045, 1254, 1310, 1355  
 learning processes, 5, 59, 78, 79, 86, 301, 376, 395–398, 401, 403–408, 410, 449, 451, 470, 514, 518, 563, 570, 691–693, 701, 706, 708, 711, 715, 734, 776, 777, 785, 790, 815, 908, 1067, 1090, 1219, 1221, 1253, 1299, 1421, 1504, 1589, 1591  
 learning sciences research, 79, 87, 718, 1321–1323, 1326–1329, 1340, 1346, 1348, 1349, 1377, 1381  
 learning societies, 12, 1395, 1398  
 learning to e-learn, 525, 546  
 Lebanon, 1041  
 legitimate peripheral participation, 282–285, 294, 296  
 less/least developed concepts (LDCs), 1496, 1497, 1500, 1502, 1507, 1508, 1511, 1512, 1514, 1520  
 lexical geography, 1185  
 libertarianism, 209, 961  
 Libya, 162, 743  
 life online, 273, 750  
 limiting exploration paths, 398  
 limiting information resources, 398  
 limiting information to be presented, 398  
 linguaMOO, 428, 1092–1094  
 linking, 27, 65, 68, 69, 75, 84, 103, 208, 254, 307, 552, 566, 831, 898, 935, 976, 1071, 1113, 1158, 1202, 1220, 1224, 1241, 1243, 1248, 1376, 1377, 1402, 1528  
 Linux, 210, 212, 213, 1204, 1311, 1423, 1577, 1578, 1581, 1585  
 listserv, 179, 655, 794, 807, 822, 854, 858–860, 863–866, 1152, 1435, 1437  
 Livermore Action Group (LAG), 122  
 Loebner Prize, 922  
 log file analysis, 1449–1452  
 log file data, 28, 1449, 1450, 1452, 1454, 1455, 1463  
 Look-Notice-Comment (LNC), 1332–1334  
 Lotus Notes, 850, 853–856, 858, 1396  
 low cost computing, 348, 1501  
 Luxembourg, 913, 1041  
  
 machine functionality, 234, 236  
 machine language, 226, 236, 237  
 machine semantics, 238  
*Machinic* technology, 102, 192  
 Macintosh, 166, 213, 237, 427, 500, 502, 1241, 1423  
 MacMOOSE, 427, 1453  
 macro-actors, 237  
 Maharastra Industrial and technical Consultancy Services (MITCON), 757

Malaysia, 732–736, 743, 744, 758–763, 768, 769, 771, 772, 776–785, 787, 796, 972, 996, 1046  
 Maldives, 755  
 Malta, 1041  
 management fashions, 851  
 management systems, 471, 481, 483, 555, 590, 591, 706, 714, 728, 746, 776, 807, 850, 852, 896, 1215, 1219, 1220, 1229  
 manifesto technologies, 181  
 Manipal Academy of Higher Education (MAHE), 754  
 manipulation techniques, 1321, 1322  
 mapping, 12, 24, 25, 40, 50, 51, 53, 54, 95–98, 118, 140, 271, 664, 708, 929, 943, 1175, 1176, 1178, 1185, 1200–1202, 1220, 1239, 1357, 1361, 1362, 1364, 1374, 1555, 1589  
 marketing broadband products, 1527  
 Marxian theory, 97, 103, 109, 130, 181  
 Marxism/ist, 99–101, 103–105, 108, 109, 118, 120, 123–127, 139, 142, 159, 177, 612, 970  
 masculinist, 120–122, 143, 1468, 1486  
 massification, 629–632, 639  
 mass media, 223, 228, 238, 330, 336, 646, 664, 668, 715, 744, 851, 915, 924, 975, 1000, 1011, 1047, 1048, 1478  
 Math Forum, 305  
 Matrix (The), 11, 29, 42, 993, 1367, 1479–1483, 1486, 1549, 1550, 1552, 1553, 1556, 1557, 1560–1563, 1565–1569  
 media and technology, 256, 259, 260, 285, 296, 804  
 media artifacts, 223, 230, 251  
 media-liminal space, 1039, 1043, 1045, 1049  
 media literacy, 96, 248–252, 254, 255, 264, 265, 316, 443, 707, 770, 1044  
 mediated cyberspace, 1590  
 mediatization, 1564  
 mediaware, 194  
 MediaWiki, 1256, 1257, 1261  
 medical education, 20, 781, 1019, 1021–1026, 1031–1034  
 medical E-LEs, 1030  
 medical imagery, 169, 1357  
 medical practice, 131, 1023, 1033, 1034  
 message boards, 754, 950, 953, 1142, 1144, 1148, 1149, 1151, 1244  
 meta-analysis, 373  
 meta-awareness, 272, 274  
 meta-ethnographic approach, 295  
 metamedia, 273  
 meta-theory of technology, 112  
 Mexico, 89, 371, 726, 728, 731, 733–735, 772, 775–779, 781, 782, 784, 785, 932, 1041, 1049, 1050  
 microelectronics, 120, 129, 131, 132, 141, 150, 164, 165  
 Microsoft, 209, 212, 357, 361, 426, 643, 664, 665, 675, 732, 734, 783, 786, 849, 890, 1034, 1325, 1326, 1464  
 Microsoft Research Annotation System (MRAS), 1325  
 microworld, 179, 290, 291, 293, 384, 924, 930, 931  
 Militant RayK Separatists (MRKS), 1152–1154, 1156, 1158–1161, 1164, 1165  
 militarism/ist, 119, 168, 170, 984, 1487  
 miniaturization, 121, 1031  
 minimally invasive learning, 1517  
 miscategorizing, 1207  
 MIT Media Lab, 279, 290, 1453  
 MIT's Undergraduate Research Program (UROP), 1453  
 mixed mode, 64, 77, 78, 83  
 mnemo-technical pedagogy, 1110, 1114  
 modding, 694, 979  
 modem-based classroom access, 303  
 modernism/ist, 144, 148, 160, 168, 181, 272, 610, 963, 1503, 1559  
 modernity, 103, 111, 112, 168, 180, 196, 289, 610, 968  
 Modern University for the Humanities (MUH), 744, 745, 782  
 modes of delivery, 59, 619  
 monomodal instruction, 246  
 MOOs (MUDs Object-Oriented), 179, 211–213, 215, 217, 425–438, 793, 810, 966, 1091–1104, 1510  
 MOOcanada, 427  
 Moodle, 202, 620  
 Moodler, 620  
 MOO environment, 427  
 MOOers, 427, 437  
 MOOing, 426, 427, 429, 435–437  
 MOOktiMOO, 435  
 MOO language, 427, 1101  
 MOOness, 437  
 MOO paradigm, 434, 435, 437  
 MOOscape, 1095

MOOSE Crossing, 28, 293, 293, 1449,  
1451–1456, 1458, 1459, 1461–1463

MOO-space/MOospace, 217, 425, 1098,  
1102

MOO tools, 435

MOOzilla, 427, 437

Mosaic browser, 1272

mosaics, 143, 266, 1079

Moscow State Institute of Business  
Administration (MSIBA), 745–747, 774

motivational, 369, 373, 378, 379, 381, 383,  
388, 389, 745, 1003, 1109, 1531

motivational factors, 381, 390

motivational perspectives, 365, 368, 1531

motivational processes, 365–369, 377, 378,  
380, 383, 385, 390

motivational systems, 384

mouses, 254

Mozilla, 428, 429

MP3 format, 273, 966, 1271, 1274, 1275,  
1279, 1283, 1284

multicomponent architecture, 410

multicultural society, 12, 241, 249, 775, 989,  
1554

multiliteracies, 255, 256, 265, 269, 273, 443,  
448, 615

multimedia, 19, 96, 176, 180, 212, 221, 222,  
234, 236, 238, 239, 241, 247–249,  
252–257, 259, 260, 265, 272, 376, 377,  
398, 399, 407, 425, 435, 436, 441, 443,  
491, 500, 502–504, 507, 508, 512, 582,  
592, 595, 598, 599, 613, 329, 633, 634,  
637, 657, 661, 662, 664, 668, 676, 684,  
691, 701, 707, 753, 758, 760, 761, 766,  
771, 833, 835, 909, 915, 925, 927, 935,  
936, 954, 969, 974, 988, 990, 1002,  
1004, 1008, 1039, 1115, 1219, 1227,  
1294, 1324, 1325, 1328, 1348, 1353,  
1367, 1371, 1377, 1382, 1395, 1397,  
1400, 1419, 1421–1423, 1524, 1546,  
1573

multimedia cyberculture, 253, 260

multimedia equipment, 176

multimedia interfaces, 236

multimedia merchandizing, 1115

multimodal multiliteracies, 269, 273

multimodal studies, 1348

multiple literacies, 12, 241, 248, 254–256,  
258–261, 270, 448, 879 (*see also*  
multiliteracies),

multiplexity, 1434, 1435, 1438

multisensory, 37, 254, 380, 1045

multisensory cues, 380

multitasking, 353, 1000, 1006, 1410, 1421

Multi-User Dungeons/Domains (MUDs), 15,  
28, 211, 293, 425–427, 966, 1085,  
1091, 1151, 1437, 1449, 1451, 1453

museum learning networks, 931

mutual opacity, 226

Myanmar, 758, 766, 1050, 1205, 1206

nanomedicine, 1031, 1035

nanotechnology, 1357

Napsterization, 26, 1271, 1272, 1283

narration, 374, 377, 383, 1078, 1081, 1303

narrative meaning, 228, 232, 233, 238, 239

narrativization, 1078–1080

NASA, 426, 873, 1031, 1050

National Board for Professional Teaching  
Standards (NBPTS), 1355

National Council for the Accreditation of  
Teacher Education (NCATE), 628, 1355

national curricula, 95, 456, 647

National Information Infrastructure (NII),  
174

National Institute of Genealogical Studies  
(NIGS), 942

National Institute of Information Technology  
(NIIT), 751, 753, 754, 782–784

National Library of Medicine (NLM), 1024

National Office of Information Economy  
(NOIE), 1357

navigational linearity, 417, 418

navigational link, 404

navigational paths, 396, 399

Navigator web browser, 45, 1241

Nepal, 755

Net Days, 302

Net:Geography FAQ, 25, 1175, 1176, 1178,  
1179, 1182, 1188, 1190, 1193, 1194,  
1197, 1200–1202

Net:Geography fieldwork, 1175, 1178, 1185,  
1194, 1201, 1202

Netherlands, 899, 1041, 1047

Net Nanny, 991, 1471

network range, 1434

networked classrooms, 61, 64, 75, 77, 78,  
84

networked e-learning, 59

networked scholarship, 28, 1429

networked societal guidance, 1042

networked systems, 179

networked world, 19, 553, 761, 799, 806,  
816, 873–877, 879–882, 884–891

networking, 17, 26, 59, 60, 64, 68, 71,  
75–77, 84, 90–92, 136, 148, 302, 445,  
528, 556, 657, 667, 688, 707, 724, 725,  
737, 740, 760, 771, 772, 775, 794, 849,  
873, 975, 1067, 1068, 1072, 1217,  
1230, 1271, 1290, 1294, 1308, 1338,  
1396, 1501, 1534, 1535, 1543

new growth, 95, 113

New Industrial Revolution, 132

New Left, 104

new literacies, 171, 241, 244, 248, 252, 264,  
1001, 1007, 1011, 1039, 1043, 1044,  
1049, 1100, 1102

new pedagogy, 59, 75, 78, 89, 244, 246, 247,  
259, 832

New Zealand, 16, 17, 113, 301, 372, 395,  
609–614, 617–621, 624–627, 630–633,  
636, 640–642, 647–649, 676, 678–680,  
683, 685, 686, 689, 690, 699, 712–714,  
716–718, 727, 812, 898, 932, 1041,  
1046, 1255

New Zealand Qualifications Authority  
(NZQA), 610, 639

NGOMSL (natural GOMS language), 410,  
420

NICE project, 1290, 1295–1297

non-formal courses, 69, 347, 358

non-hierarchical mixing, 229

North America, 1, 16, 80, 123, 207, 346,  
362, 441, 444, 448, 449, 459, 477, 485,  
498, 619, 727, 743, 771, 793, 855,  
1001, 1013, 1044, 1075, 1078, 1151,  
1160, 1403, 1414, 1439, 1478, 1487

Norway, 46, 54, 56, 371, 428, 1041

nostalgic narratives, 1078, 1079, 1081

object-based teaching, 917, 921

objectification, 126, 127, 1110, 1480, 1490

objectivism/ist, 408, 900–902, 926, 927,  
1020

object-lessons, 920, 921

objects of knowledge, 119, 127, 130–132,  
150, 159

offline VLEs, 1020, 1025

Old Boys Network (OBN), 1481, 1486

Oman, 743

one-size-fits-all pedagogy, 464

on-line banking, 488, 491, 967

online behavior, 840, 845, 864, 1464

online collaborative learning (OCL), 60, 62,  
63, 74, 88

online computer-based training (OCBT), 60,  
89

online curricula, 21, 77, 309, 488, 491, 492,  
525

online distance education (ODE), 60, 3, 689,  
710, 732, 769, 771, 783

online education, 14, 17, 28, 56, 59, 61, 62,  
67, 72, 74, 75, 80, 189, 202, 269, 339,  
341, 355, 469, 567, 648, 653, 657, 658,  
664–666, 704–707, 723–728, 731,  
733–740, 742–744, 746–750, 753–755,  
758, 759, 770–772, 774–776, 778, 781,  
784, 786, 789, 792, 793, 795, 804, 805,  
809, 810, 816, 828, 918, 919, 940–942,  
944, 945, 952, 954, 1027, 1057, 1443,  
1526, 1545

online educator empowerment, 772, 789

online environments, 43, 44, 49, 72, 73, 78,  
180, 274, 334, 337, 339–341, 425, 432,  
433, 470, 564, 566, 567, 569, 572, 574,  
584, 666, 711, 806, 812, 822, 824, 826,  
832, 846, 852, 856, 866, 911, 1071,  
1084, 1085, 1094, 1095, 1100, 1258,  
1449, 1450

online learning (*see also* e-learning), 74, 84,  
92, 274, 330, 331, 333, 337, 426, 480,  
526, 527, 532, 536, 542, 550, 556, 558,  
564, 567, 617, 622, 634, 636, 646, 658,  
665, 667, 670, 700, 702, 703, 708–711,  
718, 737, 743, 745, 748–751, 753, 757,  
758, 761, 765, 792, 796, 806, 814, 835,  
852, 895, 917, 923, 924, 927, 934, 940,  
949, 953, 1019, 1022, 1030, 1259,  
1265, 1431, 1433, 1525, 1526

online leisure, 965, 968, 979, 980

online network models, 84

open access, 492, 581, 905, 904, 1371

Open and Distance Learning (ODL), 732,  
783

Open Archives Initiative (OAI), 1351

open classroom, 512, 1221

Open Language Archives Community  
(OLAC), 1351, 1375

Open Polytechnic of New Zealand (TOPNZ),  
618, 619

open source learning, 202, 555, 724, 738,  
804

open source software, 210, 212, 492, 620,  
1204, 1502

outcomes-based instruction, 275

out-degree, 1436

out-of-school model, 334–337  
 outsider-constructed reasoning, 1502  
 ownership geography, 1185, 1186

Pacific Rim countries, 725, 726, 769, 771  
 packet-switched networks, 59, 60, 69, 90, 1033  
 Pair-Gain Systems (PGS), 1541  
 Pakistan, 743, 755, 769, 1050  
 Palestine, 743, 1201  
 panoramic audio, 1344  
 paradigm(atic) shift, 59, 192, 338, 486, 491, 518, 609, 700, 723, 724, 751, 771, 941, 943, 944, 948, 1431, 1432, 1442, 1443, 1523  
 paralogics of control, 195, 197  
 Paris (VR device), 1291  
 parsing, 415, 417–419, 1240, 1241, 1375, 1380, 1451  
 partiality, 119, 139, 145, 159  
 participatory learning and action (PLA), 1511, 1512  
 participatory rural appraisal (PRA), 1511, 1512  
 participatory technologies, 21  
 patchwork networks, 1539  
 patriarchal control, 1468  
 pay-television, 1527, 1529, 1531, 1539, 1540, 1543, 1545  
 pedagogy, 6, 10, 12, 15, 19, 23, 29, 59, 62, 63, 66, 67, 69, 72, 74–78, 83, 86, 89–91, 100, 113, 161, 177–181, 207, 210, 216, 241–252, 254–256, 258–262, 269, 270, 272–275, 307, 309, 311, 335, 359, 383, 397, 410, 441–449, 453–455, 464, 465, 469, 486, 492, 497, 510, 517, 520, 525, 531, 547, 563, 564, 568–571, 575–577, 593, 599, 600, 613, 626, 628, 629, 664, 693, 694, 699, 703, 704, 706, 709, 710, 715, 718, 727, 730, 736, 737, 742, 755, 775, 776, 786, 794, 805, 806, 829, 830, 832, 838, 844, 845, 852, 867, 900, 901, 907, 915, 920, 921, 928, 934, 1011, 1016, 1076, 1086, 1089–1093, 1096, 1100, 1103, 1107–1111, 1113–1115, 1117, 1118, 1133, 1176, 1232, 1271, 1290, 1294, 1297, 1298, 1301, 1313, 1315, 1351, 1353, 1354, 1374, 1425, 1472  
 peer-to-peer networks, 26, 1271–1273, 1284, 1285

Performance Assessment for California Teachers (PACT), 1354–1356  
 performance-based student models, 410  
 peripherality, 283  
 personal digital assistant (PAD), 272  
 Personal Imaging, 1572, 1587  
 personalization, 384, 431, 470, 718, 909  
 phenomenology, 37, 38, 105, 107, 114, 281, 282, 294, 1556  
 Philippines, 726–729, 731–735, 758, 759, 761, 763, 765, 769, 772, 776–786  
 philosophy of technology, 95–99, 110–114  
 PhotoBorg, 1589  
 PhPWiki, 1256  
 pilot testing, 1510, 1513, 1515  
 ping, 1192–1194, 1197, 1201  
 PMWiki, 1256  
*poiesis*, 102, 103  
 point-of-view authoring, 1321, 1329–1331, 1340, 1345, 1347, 1352  
 political definitions of e-learning, 673, 689, 693  
 polylingual communication, 212  
 polylingual space, 212  
 polyphony, 123, 295  
 polysynchronous, 212, 217, 425, 430, 438  
 polysynchronous environments, 430  
 pooling of resources, 483, 485  
 popular culture, 19, 21, 23, 169, 221, 249, 260, 313, 962, 975, 995, 1000, 1001, 1007, 1112, 1118, 1128, 1130, 1131, 1133, 1134, 1159, 1160, 1314, 1345, 1368, 1467  
 pornography, 21, 131, 507, 687, 766, 961, 962, 987–994, 998, 1155, 1207, 1208, 1470, 1536  
 Portugal, 1041  
 post-humanism/ist, 112  
 postitivism/ist, 124, 168, 209, 1497  
 post-modernism/ist, 118, 120, 123, 124, 128, 134, 141, 148, 1573  
 pre-programmed procedure, 226, 227  
 pre-programmed responses, 234  
 privatization, 135, 137, 138, 197–199, 202, 636–638, 741, 928  
 problem-based approach, 321, 928  
 problem-based learning, 290, 709, 907, 948, 949, 1376  
 procedural discourse networks, 1237  
 production geography, 1185

professional development, 14, 16–18, 61, 64, 68, 69, 91, 275, 308, 309, 318, 321, 334, 337, 338, 347, 350, 356–358, 361, 363, 465, 498, 526, 563, 570, 593, 691, 706, 712, 724, 726, 733, 784, 789–791, 799, 800, 804, 807, 809, 815, 816, 849, 850, 852–854, 856, 857, 866, 587, 1325, 1349, 1350, 1355, 1414, 1417–1419, 1439  
 Programme for International Student Assessment (PISA), 371, 372, 390  
 progress-directed educators, 235  
 progressive reconstruction, 243  
 progressivist, 262, 446  
 progress-oriented tasks, 235  
 Public Knowledge Project (PKP), 582, 583, 585–587, 589–591, 601, 603  
 publishing online, 821–824, 826, 830, 832, 836, 837  
 PubMed, 582, 1024  
 puzzles of practice, 601  
  
 Qatar, 743  
 qualitative analysis, 420, 676, 1450, 1452  
 quasi-objects, 196, 197  
  
 race, 12, 48, 108, 122–124, 127–129, 132–134, 137–139, 141, 143–146, 150, 159, 164, 171, 172, 175, 176, 178, 180–182, 243, 249, 251, 263, 264, 431, 610, 612, 703, 727, 739, 776, 851, 972, 993, 1084, 1089–1092, 1094–1100, 1102–1104, 1132, 1151, 1166, 1314, 1369  
 radical instructional design (RID) theory, 100  
 rationality, 101, 104, 108, 111, 168, 1472, 1481  
 Reactive Room, 1582  
 real-time, 37, 46, 63, 195, 217, 274–276, 351, 390, 430, 434, 493, 623, 646, 702, 705, 811, 812, 931, 1188, 1290, 1293, 1296, 1336, 1338, 1341–1343, 1349, 1398, 1424, 1589  
 real-time chats, 63, 811, 1424  
 real-time environment, 430, 434  
 reconstruction of education, 242, 243, 245–247, 249, 257, 258, 260, 261  
 recursions, 414–418  
 recursive functions, 414  
 Red River College, Canada, 1397, 1419, 1420, 1422  
  
 reflectivity, 401  
 reification, 565, 566, 1549  
 re-mediation/remediation, 180, 305, 965, 969, 979, 1237  
 Remote Accessible Field Trips project, 1222  
 remote integrated multiplexers (RIMs), 1540  
 repetitive feedback, 230  
 reproduction, 23, 96, 110, 118, 125, 127–130, 132, 134, 135, 138, 139, 141, 142, 144, 149, 197, 230, 235, 246, 272, 374, 920, 921, 1107, 1126, 1127, 1276, 1366, 1477  
 reproductive technologies, 108, 132, 170  
 Republic of Korea, 299, 705, 707, 770, 771, 996, 1041, 1380, 1538, 1539  
 republic of letters, 1432  
 Resource Description Framework (RDF), 482, 1352  
 restructuring, 96, 133, 137, 139, 241–244, 248, 258–260, 262, 263, 507, 638, 1006, 1177, 1430  
 reverse engineering, 1573  
 reverse navigation, 417–419  
 re-vision, 242, 244, 257, 1129  
 re-visioning of education, 13, 241, 242, 244, 247, 257, 260, 789  
 River Web Water Quality Simulator, 387  
 robotic technology, 47, 56, 129, 132, 134, 430, 957, 996, 1024, 1340, 1477  
 role-play(ing) games (RPGs), 31, 425, 1315  
 rule-governed systems, 224  
 Rural Online Cardiac Education Project (ROCEP), 1026  
 Russia, 17, 211, 212, 280, 723, 725–736, 744–747, 772, 775–778, 780–786, 969, 1085  
  
 Safari web browser, 45, 929, 930, 1241  
 SafeSearch, 1207  
 Saudi Arabia, 313, 1205, 1207  
 Scandinavia, 1380  
 scholarly networks, 28, 772, 1430, 1431, 1433, 1439, 1441, 1442  
 school for cyborgs, 1590  
 School of Information Technology Wiki (SITWiki), 1259–1263  
 scientific culture, 119, 121  
 security, 138, 140, 194, 199, 203, 215, 314, 331, 398, 437, 518, 527, 570, 624, 687, 1021, 1033, 1099, 1113, 1117, 1177, 1201, 1209, 1211, 1261, 1263, 1340,

1373, 1378, 1379, 1381, 1386, 1542,  
 1574–1576, 1578, 1584, 1587  
 self-directed courses/learning, 350, 356, 358,  
 397, 598, 601, 631, 690, 701, 706, 798,  
 979, 1223, 1228, 1231  
 self-organizations, 1237, 1245  
 semantic web, 470, 494, 909, 1352  
 semiotic logic, 234  
 semiotic relations, 224, 229, 230, 232, 238  
 semiotics, 925, 1490  
 SeniorNet, 875, 877–880, 882, 888–890, 892  
 seniors, 18, 19, 873, 876, 877, 879, 880, 891  
 sequential operation, 226  
 Serbia and Montenegro, 1050, 1068–1071,  
 1076–1080, 1083–1086  
 serious play, 117, 389, 999, 1002, 1111  
 sex, 19, 21, 24, 108, 110, 117, 123, 126–129,  
 132, 133, 135, 138, 141, 146, 147, 663,  
 778, 961, 962, 968, 975, 979, 987–994,  
 1147, 1152, 1155–1158, 1207  
 sexuality, 12, 24, 48, 117, 118, 120, 124,  
 132–135, 139, 142, 144, 148, 180–182,  
 340, 990, 991, 993, 1092, 1096, 1099,  
 1100, 1103, 1124, 1147, 1151, 1156,  
 1157, 1160, 1166, 1567  
 shells, 52, 996, 1208, 1510  
 SIGGRAPH Conference, 1382  
 SIGMMM Conference, 1382  
 silicon chip, 121, 171  
 silicon literacies, 263, 265  
 simulacra, 131, 148, 920, 922, 927, 934,  
 1110, 1123, 1125, 1126, 1132, 1134,  
 1490  
 simulation game, 222  
 Singapore, 17, 121, 301, 663, 676, 678, 680,  
 681, 689, 690, 692, 699, 709–711, 714,  
 717, 754, 758–762, 764, 765, 768, 769,  
 810, 972, 996, 1041, 1046, 1142, 1205,  
 1538, 1539  
 situated actions, 225, 282, 544, 549, 551  
 situated cognition, 280, 281, 525, 543, 556  
 situated knowledges, 159  
 situated learning, 13, 270, 280, 282–284,  
 286, 293, 296, 600, 1323  
 situationally responsive interaction, 221,  
 225, 230  
 skills acquisition, 413, 1021  
 slashdot, 1229, 1244  
 slash fan fiction, 1147  
 slash fiction, 19, 23, 24, 1141, 1151, 1152,  
 1165  
 slash writers/writing, 1152, 1155, 1159, 1165  
 SmartFilter, 1206, 1207  
 smell, 37, 505, 628, 921, 1099, 1562, 1566  
 social closeness, 1438, 1440  
 social competency, 584, 606  
 social constructivism/ist, 98, 202, 270, 384,  
 441–443, 445–447, 449, 714, 1223  
 social impact, 583, 756, 1301, 1501, 1507,  
 1517  
 social interaction, 52, 130, 252, 258, 259,  
 270, 286, 383, 386, 434, 435, 689, 710,  
 932, 1065, 1075, 1076, 1217, 1220,  
 1266, 1297, 1324, 1395, 1406, 1421,  
 1533  
 social network, 28, 81, 237, 662, 1068, 1072,  
 1074, 1075, 1083, 1084, 1088, 1217,  
 1223, 1224, 1431, 1433–1435, 1437,  
 1442, 1443, 1451  
 social networking systems, 1217  
 socialist feminism, 108, 112, 117, 124, 125,  
 127, 132, 150, 160  
 socialist/Marxist-feminism, 124  
 socialization, 249, 333–336, 469, 601, 806,  
 1001, 1223, 1325  
 sociological constructivism, 112  
 soft mastery, 291, 295  
 sonic browser, 1056  
 sousveillance, 1579, 1582, 1587, 1591  
 South Africa, 15, 525, 531, 542, 548, 676,  
 678, 680, 685, 726, 728–735, 743, 772,  
 775, 777, 779–786  
 South America, 726, 728, 735  
 South Asia, 725–731, 733, 734, 750, 755,  
 769, 775, 1090  
 South Korea, 676, 678–681, 685, 687, 689,  
 690, 692, 705, 770, 1539  
 Southeast Asia, 725–735, 744, 758, 759,  
 767–769, 771, 776  
 Spain, 313, 458, 1041, 1199  
 spam, 736, 882, 1177, 1188, 1209, 1536  
 spatially located sound, 37  
 Squeak programming language, 1255,  
 1264  
 Sri Lanka, 769, 1050  
 stand-alone technologies, 685  
 standardized assessment, 447  
 Star Wars, 119, 122, 129, 152, 163, 1153  
 step-by-step learning support, 398  
 stereoscopic, head-tracked display, 37  
 Strategic Computing Initiative, 164  
 strategic plans, 666, 673–675, 677, 678, 680,  
 695, 713, 1419  
 structureness, 399, 400, 403

student-centered, 26, 275, 308, 445, 505, 507–509, 667, 701, 711, 852, 1215, 1229  
 student model, 396, 402, 408–410, 419, 421  
 student outcomes, 305, 317  
 Students and Teachers Educational Materials (STEM), 932  
 students' responses, 365, 372, 381, 587  
 student–teacher equilibrium, 497, 499, 515, 517, 518, 520  
 student–teacher social dynamics, 497  
 substantivism/ist, 99–101  
 successive models, 1237, 1244  
 surfing, 45, 427, 663, 919, 1025, 1183, 1211, 1284, 1431  
 surveillance, 25, 135, 137, 270, 1005, 1177, 1184, 1203, 1204, 1209–1213, 1329, 1340, 1381, 1578, 1579, 1582–1584, 1591  
 sustainability, 548, 549, 553, 713, 794, 1424, 1498, 1503, 1508–1510, 1516, 1518, 1519  
 sustainable development, 548, 1517  
 sustainable ecology of online learning, 556  
 Sweden, 371, 756, 1041, 1047, 1290, 1310  
 synoptic video capture, 1341  
 synthetic environments, 37  
 Syria, 1205  
  
 Taiwan, 17, 211, 699, 702, 703, 714, 717, 769, 770  
 TalkBank, 1327, 1349, 1372, 1374–1377, 1379  
 TAPPED IN project, 436, 437, 850  
 taxonomies of feminism, 124  
 teacher education, 5, 14, 95, 338, 563, 586, 590, 601–603, 606, 675, 770, 842, 843, 1325, 1349, 1352–1355, 1378 (*see also* teacher learning, teacher training)  
 teacher-generated goal, 387  
 teacher learning, 1352 (*see also* teacher education, teacher training)  
 teacher training, 259, 272, 334, 337, 338, 497, 498, 500, 503, 509, 733, 770, 784, 1515, 1516, 1518 (*see also* teacher education, teacher learning)  
 TechNet, 28, 1439–1443  
 technical commodities, 227  
 technical democracy, 111  
 technocracy, 201, 1487  
 technocrats, 139, 192, 201, 1487  
 techno-human conditions, 169  
 technological change, 67, 95, 242, 341, 358, 368, 443, 514, 554, 682, 1526  
 technological culture, 99, 174  
 technological determinism, 120, 132, 247  
 technological developments, 97, 171, 207, 242, 569, 609, 729, 737, 779, 1051, 1324, 1476, 1500, 1526, 1544  
 technological innovation, 1, 11, 12, 59, 90, 107, 164, 362, 497, 504, 659, 660, 664, 676, 687, 1118, 1369, 1396, 1420  
 technological literacy, 175, 176, 178, 247, 260, 546, 1010, 1011  
 technological mindset, 100  
 technological multiplication, 242  
 technological tools, 168, 203, 441, 577, 590, 601, 602, 606, 693, 1508, 1516  
 technological transformation, 62, 241–243, 247  
 technologization, 961, 965, 975  
 technologized diaspora, 1083  
 technology-based curriculum, 215  
 technology in education, 95, 101, 279  
 technology in international development, 1495  
 technology-strategy discourses, 673  
 technology-supported academic language learning, 450  
 techno-optimism, 1525, 1527, 1538, 1544, 1545  
 technoscience, 97  
 tele-conferencing, 1293, 1340  
 teleconsulting, 1023  
 teledemocracy, 1051  
 tele-immersion, 1291, 1293  
 telematics, 137, 899  
 telemedicine, 742, 761, 1023  
 telephony technologies, 207, 685, 780, 964, 966, 996, 1415, 1529, 1531, 1532, 1541–1543  
 teleproctoring, 1023  
 telesurgery systems, 1024  
 Tertiary Education Commission (TEC), 621  
 text-based MOOs, 427, 428, 1094  
 text-MOOing, 436  
 text-MOOs, 427, 436  
 text-to-be-seen, 1240, 1241, 1244  
 Thailand, 634, 758, 759, 762–765, 768, 769, 1205  
 The Inclusive Learning Exchange (TILE), 487, 488, 492  
 theoretical variety, 99  
 thinking mathematically, 281



thoughtware, 194  
 three-dimensional (3D), 22, 37, 380, 500,  
     1008, 1009, 1021, 1045, 1123, 1293,  
     1301, 1303, 1306, 1308, 1311, 1312,  
     1357, 1367, 1369, 1589  
 three-dimensional immersion, 380  
 time on task, 347, 354, 359, 360,  
     1453–1456, 1459, 1460  
 tools for/of conviviality, 245, 246, 259  
 tour websites, 919  
 traceroute, 1194–1201  
 traceroute triangulation, 1197  
 traditional learning, 15, 260, 373, 375, 390,  
     447, 469, 471, 497, 734, 786, 1022,  
     1033  
 traditionalist/ism, 248, 250, 446  
 train-the-trainer, 563  
 transcendentalism, 110  
 transcultural communication, 273  
 transformation, 3, 4, 12, 15, 32, 40, 45, 49,  
     51, 53, 62, 75, 90, 96, 101, 104, 110,  
     112, 118, 131, 135, 139, 143, 145, 159,  
     189, 192, 195, 197, 198, 208, 241–243,  
     247, 261, 276, 279, 282, 320, 404,  
     452–454, 475, 478, 486, 487, 501, 568,  
     569, 616, 639, 669, 730, 760, 780, 975,  
     1000, 1014, 1021, 1059, 1060, 1110,  
     1114, 1124, 1225, 1233, 1298–1301,  
     1337, 1352, 1380, 1381, 1395, 1429,  
     1431  
 transformation of community, 1429  
 transformative pedagogies, 442, 443, 447,  
     464  
 Transmission Control Protocol/Internet  
     Protocol (TCP/IP), 208, 209, 1179  
 transmission-oriented pedagogy, 15, 441,  
     446, 448  
 trends in e-learning, 675, 677,  
 Turkey, 463, 726–731, 733, 743, 772, 775,  
     776, 778, 779, 782, 784, 785, 923  
  
 unanticipated outcomes, 403  
 underlying machine algorithms, 237  
 underlying machine functionality, 234  
 United Arab Emirates (UAE), 1041  
 United Kingdom (U.K.), 80, 372, 395, 610,  
     611, 634, 646, 727, 750, 756, 769, 772,  
     982, 1151, 1186, 1196, 1418, 1541  
 United Nations Education, Scientific and  
     Cultural Organisation (UNESCO), 614,  
     632, 673, 695, 723, 738–740, 764,  
     1518  
  
 Universal Resource Identifiers (URIs), 1352  
 universal interface, 1587  
 universality, 159, 694, 725, 738, 1379  
 University College London (UCL), 1187  
 University of Arizona, 1310, 1313, 1314,  
     1318  
 University of Georgia, 1348  
 University of Illinois at Chicago (UIC),  
     1289, 1290, 1299, 1300, 1304, 1306,  
     1310, 1318  
 University of Southern Queensland (USQ),  
     619  
 unmediated environments, 340  
 Uruguay, 104  
 USA, 92, 738, 888–890, 994, 1310, 1360  
 USB storage device, 481  
 Usenet newsgroups, 435, 859, 885, 1151,  
     1273, 1287, 1510  
 user adaptation, 14, 395, 421  
 User Agent Accessibility Guidelines  
     (UAAG), 479  
 user-centered design (UCD), 1509, 1510,  
     1513  
 user-extensible virtual reality, 435  
 Utopia in media, 1107  
 utopianism/ist, 104, 851, 874, 1177  
  
 varieties of theory (*see* theoretical variety),  
 vidders, 1148  
 video analysis, 1324, 1329, 1331, 1338,  
     1339, 1343, 1349, 1351, 1352, 1354,  
     1370–1372, 1375, 1377  
 video-as-data, 1321–1323, 1328, 1341,  
     1370, 1372, 1373  
 video conferencing, (videoconferencing), 63,  
     493, 508, 510, 516, 704, 706, 709, 710,  
     738, 757, 917, 924, 930, 931, 934, 1023,  
     1034, 1326, 1373, 1397, 1405, 1425  
 video games, 21, 135, 962, 966, 979, 1001,  
     1012–1014, 1141, 1483, 1485, 1488  
 video-mail, 1434  
 video-papers, 1349, 1413  
 video publishing, 1376  
 videos, 43, 221, 452, 477, 488, 500, 782,  
     856, 987, 989, 1044, 1055, 1069, 1107,  
     1304, 1315, 1324, 1325, 1328, 1330,  
     1336, 1338, 1340, 1345, 1347, 1349,  
     1351, 1352, 1355, 1369–1371, 1378,  
     1518  
 Viet Nam/Vietnam, 758, 759, 766–768, 771,  
     1118, 1205, 1551  
 viewer-centered, 37

virtual camera, 1322, 1326, 1329, 1330,  
 1334–1336, 1338, 1339, 1342–1345,  
 1353, 1360, 1368  
 Virtual Center for Technology Enhanced  
 Learning (VCTEL), 754  
 virtual classroom (VC), 70, 71, 82, 84, 194,  
 497, 506, 537, 609, 754, 853  
 virtual communities of practice, 14, 16, 61,  
 64, 65, 563, 564, 566, 568, 570, 576  
 virtual community, 573, 575, 576, 654, 703,  
 814, 991, 1002, 1024, 1026, 1071,  
 1124, 1127, 1177, 1496, 1498, 1503,  
 1505, 1510–1513, 1519, 1520  
 virtual community development, 575, 1496,  
 1503  
 virtual course, 347, 348, 350–355, 357  
 virtual ethnic clubs, 1072  
 virtual experiences, 3, 41–43, 48, 923, 982,  
 1290, 1299, 1302, 1307, 1317  
 virtual Harlem, 27, 1289, 1290, 1294, 1295,  
 1297, 1299–1301, 1303–1310, 1313,  
 1316–1318  
 virtuality, *see* virtual reality,  
 virtual landscape, 177, 1121  
 virtual learning (VL), 1–5, 8–11, 13–19,  
 22–31, 37, 43, 53, 54, 59, 95, 113, 117,  
 159, 189, 190, 194–197, 199, 201–204,  
 207, 257, 329, 330, 338, 345, 347, 350,  
 359, 365–369, 371, 373–375, 378,  
 380–390, 395, 396, 407, 425, 426, 441,  
 448, 449, 465, 469, 497, 499, 505, 506,  
 509, 510, 517, 520, 521, 528, 531, 534,  
 547, 551, 575–578, 581, 609, 674, 699,  
 704, 718, 723, 724, 727, 731, 734, 754,  
 759, 761, 762, 765, 766, 768, 775, 776,  
 778, 781, 782, 786, 789, 791, 804, 821,  
 849, 850, 867, 873, 895, 917, 918, 940,  
 1002, 1019, 1055, 1058, 1062,  
 1089–1091, 1100, 1102–1104, 1165,  
 1175, 1176, 1202, 1251, 1254, 1255,  
 1257, 1263–1267, 1271, 1290, 1300,  
 1313, 1321, 1380, 1395, 1429, 1432,  
 1433, 1443, 1449, 1496, 1525, 1526,  
 1545  
 virtual learning environment (VLE), 2–4, 6,  
 10, 12–16, 22–24, 27, 30–32, 329, 330,  
 333, 339, 341, 395–397, 399, 401, 405,  
 407–411, 420, 421, 536, 537, 540–548,  
 550–552, 554, 557, 558, 581–585,  
 590–593, 600–606, 609, 617–624, 626,  
 628, 629, 640, 642, 643, 648, 699–711,  
 713–718, 724–728, 730, 734, 735, 775,  
 789, 790, 793–795, 804, 806–810, 815,  
 895, 906, 907, 911, 940, 965,  
 1019–1023, 1025, 1032, 1033, 1058,  
 1062–1064, 1091, 1100, 1102–1104,  
 1176, 1178, 1271, 1274, 1287, 1295,  
 1297–1299, 1406, 1413, 1416, 1419,  
 1421–1424  
 virtual learning places, 53  
 virtual learning spaces, 53  
 virtual lecture hall, 194  
 virtual leisure, 961, 962, 968  
 virtual leisure industries, 19, 21, 961–964,  
 980, 993, 995  
 virtual memorial, 1055  
 virtual movement, 44, 48  
 virtual neighborhoods, 1071  
 virtual places, 40, 49, 53, 211, 1221  
 virtual reality (VR), 1, 25, 37, 38, 41, 42, 45,  
 55, 270, 293, 350, 351, 363, 365, 367,  
 381, 386, 430, 435, 647, 648, 702, 708,  
 718, 793, 970, 1019, 1021–1024, 1031,  
 1032, 1034, 1289, 1290, 1291, 1294,  
 1295, 1297–1300, 1308–1313,  
 1316–1318, 1344, 1369, 1449, 1485,  
 1550, 1553, 1561, 1563–1569, 1571  
 virtual schooling, 329, 333–339, 345, 347,  
 350–352, 354, 356, 360–362  
 virtual schools, 14, 301, 329–341, 345, 347,  
 348, 351, 352, 354, 355, 360, 362, 363,  
 704, 731, 781  
 virtual sex, 968, 991  
 virtual space, 17–19, 40, 43–46, 48, 49, 53,  
 54, 72, 177, 194, 211, 430, 435, 655,  
 789, 805, 849, 850, 853, 854, 862,  
 864–867, 884, 970, 1089, 1115, 1271,  
 1274, 1283, 1287, 1296, 1316, 1564  
 virtual space and time, 40, 43–46, 48, 49,  
 1316  
 virtual turtle, 290  
 virtual university (Virtual-U), 16, 61, 82, 83,  
 87, 88, 91, 214, 231, 361, 616, 629,  
 632, 634, 640, 644, 646, 647, 661–663,  
 668, 705–707, 716, 724–726, 731, 732,  
 736, 740, 745, 746, 753, 758, 775, 776,  
 781–783, 808, 1003, 1553, 1561, 1566  
 Virtual University Trial Project (VUTP),  
 705, 706  
 virtual videography, 1329, 1336, 1374  
 viruses, 25, 145, 166, 211, 266, 687, 882,  
 1050, 1177, 1201, 1468, 1476, 1482

visual literacy, 254, 924  
 visuality, 254, 255  
 VNS Matrix, 1480–1483, 1486  
 voice mail, 1055, 1434  
 voluntariness, 1438  
  
 Wearable Computer (WearComp), 1572, 1573, 1577, 1585–1588  
 Wearable Wireless Webcam, 1589  
 Web Accessibility Initiative (WAI), 471, 474, 479, 480  
 web-based museum education outreach, 915  
 web-based traceroutes, 1197, 1198  
 webbed MOOs, 427, 793  
 web-cast program, 923, 924  
 web community, 22, 1067–1069, 1071, 1076–1080, 1083–1086  
 Web Content Accessibility Guidelines (WCAG), 479  
 WebCT/Web-CT, 274, 348, 362, 528, 546, 557, 617, 728, 776, 782, 789, 808, 1072, 1257, 1321, 1419  
 WebDIVER, 1321, 1322, 1330, 1337–1339, 1347, 1350, 1352, 1356, 1366, 1376–1378  
 Webforum 2001, 1395–1400, 1402–1405, 1408, 1409, 1412–1425  
 weblogs (*see* blogs),  
 web of trust, 1245, 1246  
 web-page design, 448  
 web rings, 1243  
 web security, 570  
 webs of learning, 245, 246, 259  
 Western bias, 211  
 Western epistemology, 120, 142  
 Western metaphysics, 102, 103  
 Western mythos, 1471  
 Western narratives, 168  
 Western science, 110, 118, 288  
 Western traditions, 123, 143  
 whitelists, 1207, 1208  
 whois query, 1186–1189  
 wiki clones, 1255, 1256, 1264–1266  
 wiki features, 1255, 1256  
 wiki guide, 1265  
 Wikipedia, 9, 26, 202, 265, 1217, 1251–1254, 1373  
  
 wikis, 25, 26, 196, 249, 254, 265, 1217, 1220, 1221, 1228, 1230, 1232, 1251–1257, 1259, 1261, 1263–1267  
 wiki syntax, 26, 1252, 1256, 1266  
 Windows, 212, 473, 1055, 1175, 1197, 1311, 1423  
 windows, 212, 236, 254, 879, 1171, 1213, 1334, 1339, 1408, 1583  
 winMOOSE, 427, 1453  
 WiredIMAGE, 499, 500, 502, 508, 509, 512, 515, 516, 518  
 wireless networks (WLAN), 269, 1542  
 within-case analysis, 505  
 woman-centric, 1155  
 women and computers, 1476, 1489  
 women and technology, 211, 1468, 1480  
 women of color, 123, 124, 136, 140–143, 149, 152  
 word-matching games, 222  
 working memory, 14, 376, 377, 401–405, 412–414, 418, 419, 421  
 working memory capacity, 14, 402, 403, 413, 414, 418, 419  
 World Association for Online Education (WAOE), 17, 723, 725, 740, 772, 789–796, 804–810, 812, 814, 816  
 World Trade Organisation (WTO), 632, 641, 729, 750, 779  
 WorldWatcher, 1362, 1363  
 World Wide Web (WWW), 20, 44, 50, 61, 208, 209, 265, 303, 305, 306, 308, 319, 330, 345, 410, 426, 428, 479, 494, 707, 723, 742, 760, 790, 822, 873, 916–918, 935, 1033, 1040, 1048, 1216, 1271, 1273, 1498, 1549, 1589  
 World Wide Web Consortium (WC3), 209, 479  
 worms, 25, 149, 266, 1050, 1177, 1201  
  
 XML (Extensible Mark-up Language), 212, 478, 717, 1048, 1322, 1337, 1351, 1352, 1372, 1374–1377  
  
 Yemen, 743, 1205  
 Y generation, 978  
 YuGiOh!, 1044  
  
 ZeroCost computing, 207, 1501  
 ZeroCost paradigms, 1501  
 zMUD, 427