

Jaan Valsiner  
Peter C.M. Molenaar  
Maria C.D.P. Lyra  
Nandita Chaudhary  
*Editors*

# Dynamic Process Methodology in the Social and Developmental Sciences

 Springer

# Dynamic Process Methodology in the Social and Developmental Sciences

Jaan Valsiner • Peter C.M. Molenaar •  
Maria C.D.P. Lyra • Nandita Chaudhary  
Editors

# Dynamic Process Methodology in the Social and Developmental Sciences

 Springer

*Editors*

Dr. Jaan Valsiner  
Clark University  
Dept. Psychology  
950 Main Street  
Worcester MA 01610  
USA  
jvalsiner@clarku.edu

Prof. Maria C.D.P. Lyra  
Universidade Federal de  
Pernambuco  
Centro de Filosofia e Ciências  
Humanas  
Recife-PE  
Brazil

Dr. Peter C.M. Molenaar  
Pennsylvania State University  
Dept. Human Development  
& Family Studies  
University Park PA 16802  
105, Henderson Bldg. S.  
USA

Prof. Nandita Chaudhary  
University of Delhi  
Lady Irwin College  
Sikandra Road  
New Delhi-110001  
India

ISBN: 978-0-387-95921-4      e-ISBN: 978-0-387-95922-1  
DOI 10.1007/978-0-387-95922-1  
Springer Dordrecht Heidelberg London New York

Library of Congress Control Number: 2009926490

© Springer Science+Business Media, LLC 2009

All rights reserved. This work may not be translated or copied in whole or in part without the written permission of the publisher (Springer Science+Business Media, LLC, 233 Spring Street, New York, NY 10013, USA), except for brief excerpts in connection with reviews or scholarly analysis. Use in connection with any form of information storage and retrieval, electronic adaptation, computer software, or by similar or dissimilar methodology now known or hereafter developed is forbidden.

The use in this publication of trade names, trademarks, service marks, and similar terms, even if they are not identified as such, is not to be taken as an expression of opinion as to whether or not they are subject to proprietary rights.

While the advice and information in this book are believed to be true and accurate at the date of going to press, neither the authors nor the editors nor the publisher can accept any legal responsibility for any errors or omissions that may be made. The publisher makes no warranty, express or implied, with respect to the material contained herein.

Cover illustration:

Printed on acid-free paper

Springer is part of Springer Science+Business Media ([www.springer.com](http://www.springer.com))

# Preface

## Dynamic Nature of Phenomena and its Study

This book has a clear mission—to restore the focus on the dynamic side of the social and psychological processes that are the object of interest for the social sciences. Such focus was there in the social sciences in the first decades of the 20th century. It was subsequently lost. The reasons for such loss are still awaiting a careful scholarly analysis—which would belong to the (so far non-existing) area of *developmental sociology* of science. While the ways in which scientists function have been subjected to careful ethnographic investigations in sociology of science (Knorr-Cetina, 1999) that coverage has excluded a look at the dynamic interchange between developing society and—within it—a developing science. Study of such social relations in their transformation of the society would amount to developmental sociology.

*Zeitgeists* change. By the end of the 20th century the focus on the study of processes (rather than outcomes)—through the investigation into their dynamics—has started to re-appear gradually. It is important to trace such re-focusing to the social fashions for one or another method—usually imported to the social sciences from other disciplines. Thus, for re-focusing on analysis of psychological and social processes, the Dynamic Systems Theory and Neural Network Models in the neurosciences paved the way. Neither of these currently fashionable models are new—we can see their roots in late 19th century<sup>1</sup>—but their power for the social sciences is in the out-migration to the “hard sciences” with the subsequent return with all the halo effect of “coming from the *real* science”. Of course the “hard sciences” are “more real”—than the social sciences—only by our social conventions—hence the “most real” sciences are the meta-level frameworks that designate some disciplines as “hard” and others as “soft”. If that argument is accepted—it is the social sciences that are *real*, and the set of meanings exported from our social philosophies to the study of physical, chemical, and biological functions *constructive projections*. Or, in

---

<sup>1</sup> The origins of neural network models can be found in Vladimir Bekhterev’s reflexology, and the dynamic systems theory benefits from the biological philosophy of Hans Driesch.

other terms—the reality of “the real” is determined by the constructor of the meaning of “the real”—who have to be very real themselves to make such designation.

Obviously, the social sciences suffer from some kind of inferiority complex—which perhaps is carefully socially maintained to keep them from acquiring an authoritative voice in socio-moral matters of a society. Knowledge of outcomes is useful for social engineering—for selection of personnel, assignment of phenomena of various assumed identities to different categories or caste systems. In contrast, the knowledge of processes is dangerous—knowing how the current social system works as a process may give cues for how to change it—and no powerful social system aspires for its own elimination.

However, in the beginning of the 21st century—that restored focus on the study of psychological and social processes is far from systematic. Hence the effort in this book to bring together contributions from researchers who use a wide array of research strategies—ranging from the quantitative to the qualitative in nature, and from single-case based to that of relying on populations in the applications of the methods. The usual contrast— <“**scientific**” = “**populational**”> versus <“**anecdotal**” = “**single case**”> has for decades fortified the misunderstanding of the traditional NOMOTHEIC/ IDIOGRAPHIC contrast. Study of single cases is not “anecdotal”—but systemic (Lewin, 1977). The contrast that is heavily disputed in the social sciences is that between elementaristic (populational) and systemic (single case) based routes to generalized knowledge. Both allow for nomothetic knowledge to be constructed—yet in very different ways.

Our book includes a rather heterogeneous field of new approaches—all united by focus on dynamic process, but rather dis-united in how they try to trace these processes. This lack of unity is a sign of a young, vigorous search for novel perspectives—hopefully leading to innovations. The book is a kind of state-of-the art cross section of the movements towards the study of processes in the contemporary social sciences. It includes both sophisticated quantitative perspectives and qualitative efforts which resist or deny quantification all together. Despite such irreconcilable differences in their trajectories to arrive at basic knowledge they are united by the goal—precisely such basic knowledge is needed for our contemporary social sciences, starting from psychology.

## **How the Distance from the Phenomena Makes Forgetting Processes Possible**

Researchers work intimately with their data—yet the data are not given entities, but by-products of the researchers’ application of their existing know-how to the phenomena. Whether the data derivation in a science is quantitative or qualitative, it entails distancing of the researcher’s experience from the immediate experience with the phenomena, for the sake of arriving at the power of abstractive generalizations. In this sense—data are facts (signs) that are impoverished in relation to the phenomena of their origin, and not yet empowered by the act of abstractive generalization.

There are three directions in the transformation of phenomena into data that have guaranteed the artifactual status of much of the evidence on which contemporary social sciences are based:

- Eliminating **the dynamic flow** of the phenomena in the data.
- Eliminating **the hierarchical order** (part <math>\diamond</math> whole relations) in the transformation of phenomena into data.
- Eliminating **the immediate context** of the phenomenon in its transformation into data.
- Eliminating **intersubjective divergences** in the appraisal of events for the sake of the illusion of “objectivity”.

Each of these elimination strategies blocks the movement of scientific knowledge into vast areas of relevant information about the phenomena. Elimination of evidence about the dynamic flow of phenomena in the data has blocked the advancement of developmental science for about a century (Cairns, 1998). The elimination of hierarchical order has made it difficult to handle issues of complexity. The elimination of context has led psychology to overlook the social nature of psychological phenomena.

Given all these obstacles to knowledge, it is obvious that the key to further breakthroughs in psychology is in the domain of general methodology—the cyclical relation of all features of generating new knowledge (Branco & Valsiner, 1997). In Fig. 1 we can observe a model of such cyclical relation.

Obviously psychology in the 21st century has much to learn from its own history—especially from the failures of the discipline to capture the crucial phenomena of human existence. It has been criticized for its pseudo-empiricism (Smedslund, 1997)—proving by empirical studies what is already known through the implications of the common language. The prevailing ethos of inductive generalization in psychology provides ample evidence for such claim. One could wonder what in our basic knowledge of some specific phenomena would be lost if we started to play the game of stepwise elimination of published data—how much of the existing “literature” in peer-reviewed journals of high “impact factor” could be eliminated

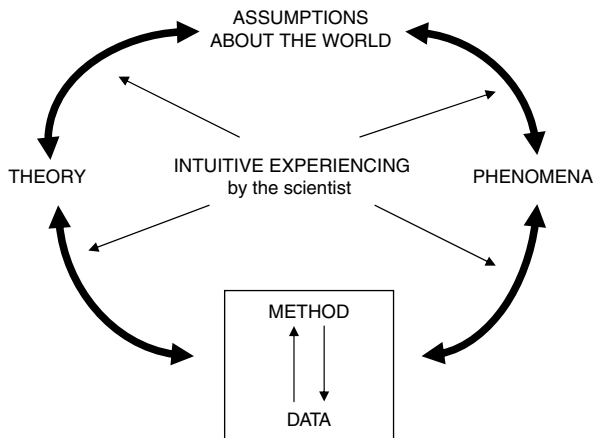

**Fig. 1** The methodology cycle (after Branco & Valsiner, 1997)

(“forgotten”) before our current generalized understanding starts to suffer from such purification of science?

### ***Knowledge Construction as Abductive Process***

Smedslund’s suggestion of replacement of the inductive generalization strategy with its deductive counterpart would restore general focus to otherwise “facts-driven” area of psychology. Yet it would not be sufficient—since generation of new knowledge is an abductive (i.e., neither inductive nor deductive—but synthetic) enterprise. Abductive synthesis—the only kind that can create new ideas (Peirce, 1935, CP 2.777)—entails a qualitative “jump” beyond what is known inductively, and what is assumed deductively. The issue so synthesis is a conceptual theme at which psychology has arrived a number of times—from Wundt, Baldwin, Piaget, Krueger, and Vygotsky to contemporary builders of neural networks—yet it has not been resolved.

Aaro Toomela (2007, and in this book) has recently brought to our attention the development of psychology in the second half of the 20th century along two trajectories—the North-American and the German-Austrian methodological orientations. Based on the analysis of these two trajectories already back in the 1930s (Watson, 1934), Toomela points out the intellectual impasse of the dominance of the quantitatively oriented North-American trajectory:

Last 60 years in psychological research have given us thousands, perhaps even millions, of ways how to predict statistically one psychological variable by way of another. At the same time, many fundamental questions have even not been asked because of limited methodological thinking. We still find “objective” scores without knowing how many different psychological mechanisms may underlie the same score. We do not know how psychological aspect of experimental conditions may have contributed to study results. Study of fragments gives very little to understanding of a human person as a whole... Statistical probabilistic prediction has become an end goal of studies even though *most of the thinking and insight should begin where the science of mainstream psychology seems to end now*. (Toomela, 2007, p. 18, emphasis added)

Any axiomatic acceptance of quantification (or—likewise-qualitative approach) as the guarantor of objectivity in psychology is possible only if the natural intuitive anti-position “*but the psychological phenomena as I experience them are all qualitative*” is weakened, or blocked (Brower, 1949, p. 326). Noticing such blockage does not eliminate quantification as a strategy for research—it merely restores the primacy of the qualitative questions to which quantitative answers are sought. The person—a young emerging scientist—may stop trusting one’s own introspection about psychological matters—and adopts the authoritative discourse from an introductory textbook on what “scientific methods” are. Yet textbooks are collectors—not creators—of basic and socially standardized knowledge. None of the findings that have made their way to the textbooks could have been obtained had their creators ardently following the textbooks of their times (Reddy, 2008).

However, a whole range of our contemporary scientific actions—from different perspectives—are on their way of reconstructing psychology. A major break is



slowly moving into contemporary psychology—abandoning the assumption that scientific evidence in psychology is necessarily (and automatically) quantitative:

There are many spheres of human behavior concerned with the production of cultural products in which any investigation that sidesteps the content of these products neglects an important (if not the most important) feature of the behavior. The most glaring example, of course, is the phenomenon of meaning, not just linguistic meaning, but meaning in all forms of symbolism. (Michell, 2004, p. 316)

Since meaning-making is the most central human psychological process, we find ourselves in a situation where sameness of the phenomena—accumulated into categories that we “detect” as “this is X” over our irreversible experience—are brought into question. This leads to the radical re-formulation of the social sciences as idiographic—and to the removal of the negative stigma attributed to the single cases that do not represent populations. Well—neither do populations represent each and every single case—a new look is needed.

### ***The Centrality of the Unique in the General***

We are witnessing a quickly developing trend towards the centrality of qualitative and single-case based methodological interests Worldwide—even in parts of the social sciences (e.g., education) in the United States. Of course the focus on the single case is a given in many sciences—one single excavated fossil pelvis of 3.5 million years of age is sufficient for paleoanthropologists to create generalized knowledge about not only the body build of *Homo erectus* that time, but also about its species specific behavioral adaptations (Simpson et al., 2008).

In psychology, Gordon Allport’s clear vision about the centrality of the single case (Allport, 1967) is finally—with some historical time-lag—about to become true. One of us has made it very explicit:

...psychology as an idiographic science restores the balance by focusing on the neglected time-dependent variation within a single individual (*IAT*). It brings back into scientific psychology the dedicated study of the individual, prior to pooling across other individuals. Each person is initially conceived of as a possibly unique system of interacting dynamic processes, the unfolding of which gives rise to an individual life trajectory in a high-dimensional psychological space. Bringing thus back the person into scientific psychology, it can be proven that her return is definitive this time. Classical theorems in ergodic theory, a branch of mathematical statistics and probability theory, show that most psychological processes will have to be considered to be nonergodic. For nonergodic processes ... (which include all developmental processes, learning processes, adaptive processes, and many more), explicit analyses of IAV for their own sakes are required to obtain valid results concerning individual development ... (Molenaar, 2004, p. 202)

This revolutionary claim renders most of the work done in psychology over the past half-century inconsequential (Molenaar, 2007). Non-ergodicity means that treating inter-individual variability (which we usually label indistinctively as “variance” or “individual differences”) as if it adequately reflected intra-individual (temporal) variability is not possible.

By rejection of the axiom of ergodicity in psychology we invalidate the interpretations of group-based data that are applied to individuals. Implications for both empirical research practices and practical applications of psychology are profound. Psychology has been exploring important topics—yet with methods that were inadequate to these topics. Methodological alternatives exist—hence the need for this book. Yet this book is only a beginning—it provides an impetus for further development of ideas, rather than a final or authoritative state of “a toolbox” of “new methods.” It is an invitation to a constructive dialogue by the readers—whichever may be their own scientific credo, and wherever in the World they may be located.

### ***The International Equality of Minds in Knowledge Construction***

Science tolerates no country boundaries. Our contemporary turn to the focus on the study of dynamic processes is a collective international effort. At our present time, no single country—or a continent—has a dominant status on the knowledge construction in the social sciences. This is a very important aspect that needs to be highlighted as possibilities of freedom and creativity. Differently from other scientific areas in which there is a dominance (or dependence for discover) of technological developments, heavily economically dependent on (for instance, the recent experiment in Switzerland in Quantum Physics, promoted by CERN’s group), social sciences, and so psychology, can rely on the diversity of social contexts as enhancing the scientist creativity. This makes, for one side, more international our endeavor and for other side, it promotes a kind of internationality that allows for diversity. This permits a type of freedom that is more independent of economic factors. This needs to be stresses and preserved. In a sense it is an application of a non-ergodicity principle to our scientific endeavor itself.

The phenomena of interest are present in any corner of the World, and the different cultural-historical backgrounds of the researchers provide constructive input for new look at the psychological and social processes. Our contemporary social sciences are about to transcend their past as “colonial disciplines”—set up to learn of the ways of the “distant and strange others.” In our present world—filled with active and quick migrations—“the strange other” may be our next-door neighbor (to whom we constitute another “strange other”—in the reverse). Both are equal—economically and legally—within the given society.

Similarly, new knowledge in the social sciences emerges from very different places all over the World. Different cultural histories set the stage for theoretical breakthroughs which were not possible within the Euro-centric social sciences. If the latter were caught in the tendency of explaining phenomena by classification and labeling, perspectives from other societies can help to overcome that limitation. Consider, for example, psychology’s perennial question of *self identity* of persons. Within the Euro-centric tradition “my identity” is a “thing”—something I “have” in “myself”—over time and across contexts. Since such constructed “thing”—a personal abstraction of a static essence—varies over situations, the question of “what is my *real* self?” emerge in the ordinary Eurocentric mind. In contrast—in the social

history of societies in India—where all deities swiftly move from one identity to another, assume different names in different renderings—the look for “my real self” is a foreign import. Instead, the very *process* of figuring out one’s life-world, the process of moving towards an identity state (without ever reaching that “static state”)—**is** the self-identity. There is much that the theorizing of contemporary social sciences could learn from non-European cultural-historical traditions.

### ***Introducing the Basic Themes of this Book***

The book is diverse—yet there are recurrent themes in it. Overall, the reader can find the impact of the Dynamic Systems Theories all over the book. That is not surprising, since in the last two decades that deductively driven formal system has fascinated social scientists in many ways. Chapter 1 (Lauro-Grotto et al.) covers intra-psychological psychodynamic processes, Chapter 19 (Vedeler and Garvey) views infant development through the lens of dynamic systems, and Chapter 27 (Kriz) outlines a wider set of thought nodels for using dynamic systems perspectives in the social sciences. In parallel to new perspectives on statistical methods appropriate for analyses of processes (Chapter 9—Hamaker, Chapter 11—von Eye and Bogat, Chapter 12—Molenaar and Ram; Chapter 13—Visser et al., Chapter 14—Timmerman et al.) we find in the book a theme of rejection of statistical methods in the study of complex developmental and social processes (Chapter 3—Toomela; Chapter 7—Przyborski and Slunecko). The new movement towards idiographic science is well represented in the book (Chapter 2—Lamiell; Chapter 4—Borsboom et al.; Chapter 10—Sato et al.) with concrete examples of how to do it (in education—Chapter 16—Wettstein and Thommen; in social contexts—Chapter 17—Chaudhary; in psychotherapy—Chapter 20—Molina and del Rio and Chapter 21—Santos and Gonçalves). Complexity of dynamic phenomena of human life courses is the theme shared widely between the chapters (Chapter 8—Salvatore et al., Chapter 22—Kadianaki; Chapter 23—Przyborski and Slunecko; Chapter 26—Scheithauer et al.). In a new synthesis looking at life course ruptures as catalysts for development, Zittoun (Chapter 18) provides a lead for new look at ontogeny as a dynamic process. Similar innovation in the methodology of microgenesis is offered in memory domains (Chapter 5—Wagoner; Chapter 6—Mori), while the ecological embeddedness of all developmental processes is emphasized by Bang (Chapter 25). All together, the book covers a wide mindscape of scholarly opportunities—perhaps it is an intellectual gold mine, or—a mine field. The readers are the only ones to judge.

Worcester, MA  
University Park, PA  
Recife, PE  
New Delhi

Jaan Valsiner  
Peter C.M. Molenaar  
Maria C.D.P. Lyra  
Nandita Chaudhary

December, 2008

## References

- Allport, G. (1967). Gordon W. Allport. In E. C. Boring & G. Lindzey (Eds.), *A history of psychology in autobiography*. (Vol. 5, pp. 1–25). New York: Appleton-Century-Crofts.
- Branco, A. U., & Valsiner, J. (1997). Changing methodologies: A co-constructivist study of goal orientations in social interactions. *Psychology and Developing Societies*, 9(1), 35–64.
- Brower, D. (1949). The problem of quantification in psychological science. *Psychological Review*, 56, 325–331.
- Cairns, R. B. (1998). The making of developmental psychology. In W. Damon & R. Lerner (Eds.), *Handbook of child psychology*. 5th ed. Vol. 1. *Theoretical models of human development* (pp. 25–105). New York: Wiley.
- Knorr-Cetina, K. (1999). *Cultures of science*. Chicago: University of Chicago Press.
- Lewin, M. (1977). Kurt Lewin's view of social psychology: Crisis of 1977 and the Crisis of 1927. *Personality and Social Psychology Bulletin*, 3, 159–172.
- Michell, J. (2004). The place of qualitative research in psychology. *Qualitative Research in Psychology*, 1, 307–319. from [www.qualresearchpsych.com](http://www.qualresearchpsych.com)
- Molenaar, P. C. M. (2004). A manifesto on psychology as idiographic science: Bringing the person back into scientific psychology, this time forever. *Measurement: Interdisciplinary research and perspectives*, 2, 201–218.
- Molenaar, P. C. M. (2007). Psychological methodology will change profoundly due to the necessity to focus on intra-individual variation. *IPBS: Integrative Psychological & Behavioral Science*, 41(1), 35–40.
- Peirce, C. S. (1935). *Collected papers*. Cambridge, MA: Harvard University Press.
- Reddy, V. (2008). *How infants know minds*. Cambridge, MA: Harvard University Press.
- Simpson, S. W., Quade, J., Levin, N. E., Butler, R., Dupont-Nivet, G., Everett, M., et al. (2008). A female *Homo erectus* pelvis from Gona, Ethiopia. *Science*, 322, 1089–1092.
- Smedslund, J. (1997). *The structure of psychological common sense*. Mahwah, NJ: Lawrence Erlbaum.
- Toomela, A. (2007). Culture of science: Strange history of the methodological thinking in psychology. *IPBS: Integrative Psychological & Behavioral Science*, 41(1), 6–20.
- Watson, G. (1934). Psychology in Germany and Austria. *Psychological Bulletin*, 31(10), 755–776.

# Contents

<b>1</b>	<b>The Unbearable Dynamicity of Psychological Processes: Highlights of the Psychodynamic Theories</b> .....	1
	Rosapia Lauro-Grotto, Sergio Salvatore, Alessandro Gennaro and Omar Gelo	
<b>2</b>	<b>Reviving Person-Centered Inquiry in Psychology: Why it's Erstwhile Dormancy?</b> .....	31
	James T. Lamiell	
<b>3</b>	<b>How Methodology Became a Toolbox—And How it Escapes from that Box</b> .....	45
	Aaro Toomela	
<b>4</b>	<b>The Two Disciplines of Scientific Psychology, or: The Disunity of Psychology as a Working Hypothesis</b> .....	67
	Denny Borsboom, Rogier A. Kievit, Daniel Cervone and S. Brian Hood	
<b>5</b>	<b>The Experimental Methodology of Constructive Microgenesis</b> .....	99
	Brady Wagoner	
<b>6</b>	<b>The Schema Approach: A Dynamic View on Remembering</b> .....	123
	Naohisa Mori	
<b>7</b>	<b>Against Reification! Praxeological Methodology and its Benefits</b> .....	141
	Aglaja Przyborski and Thomas Slunecko	
<b>8</b>	<b>Grasping the Dynamic Nature of Intersubjectivity</b> .....	171
	Sergio Salvatore, Rosapia Lauro-Grotto, Alessandro Gennaro and Omar Gelo	
<b>9</b>	<b>Idiographic Data Analysis: Quantitative Methods—From Simple to Advanced</b> .....	191
	Ellen L. Hamaker and Conor V. Dolan	
<b>10</b>	<b>Depicting the Dynamics of Living the Life: The Trajectory Equifinality Model</b> .....	217
	Tatsuya Sato, Tomo Hidaka and Mari Fukuda	
<b>11</b>	<b>Analysis of Intensive Categorical Longitudinal Data</b> .....	241
	Alexander von Eye and G. Anne Bogat	

**12 Advances in Dynamic Factor Analysis of Psychological Processes** ..... 255  
Peter C.M. Molenaar and Nilam Ram

**13 Hidden Markov Models for Individual Time Series** ..... 269  
Ingmar Visser, Maartje E.J. Raijmakers and Han L.J. van der Maas

**14 Multilevel Simultaneous Component Analysis for Studying  
Intra-Individual Variability and Inter-Individual Differences** ..... 291  
Marieke E. Timmerman, Eva Ceulemans, Anna Lichtwarck-Aschoff  
and Kristof Vansteelandt

**15 Idiographic Microgenesis: Re-visiting the Experimental Tradition  
of Aktualgenese** ..... 319  
Rainer Diriwächter

**16 Dynamic Methods for Research in Education** ..... 353  
Alexander Wettstein and Beat Thommen

**17 Social Dynamics in Complex Family Contexts and its Study** ..... 383  
Nandita Chaudhary

**18 Dynamics of Life-Course Transitions:  
A Methodological Reflection** ..... 405  
Tania Zittoun

**19 Dynamic Methodology in Infancy Research** ..... 431  
Dankert Vedeler and Andrea P. Garvey

**20 Dynamics of Psychotherapy Processes** ..... 455  
María Elisa Molina and Maria Teresa del Rio

**21 Dramatic Life Courses: Migrants in the Making** ..... 477  
Iriní Kadianaki

**22 Innovative Moments and Change Processes in Psychotherapy:  
An Exercise in New Methodology** ..... 493  
Anita Santos and Miguel M. Gonçalves

**23 Techno Parties, Soccer Riots, and Breakdance:  
Actionistic Orientations as a Principle of Adolescence** ..... 527  
Aglaja Przyborski and Thomas Slunecko

**24 Dynamic Processes and the Anthropology of Emotions  
in the Life Course and Aging: Late-Life Love Sentiments  
and Household Dynamics in Tuareg Psycho-Biographies** ..... 541  
Susan Rasmussen

**25 Synthetic Phenomena and Dynamic Methodologies** ..... 567  
Jytte Bang

**26 Developmental Science: Integrating Knowledge About Dynamic  
Processes in Human Development** ..... 595  
Herbert Scheithauer, Kay Niebank and Angela Ittel

**27 Cognitive and Interactive Patterning:  
Processes of Creating Meaning** ..... 619  
Jürgen Kriz

**Index** ..... 651

# Contributors

**Jytte Bang** is an associate professor at the Department of Psychology, University of Copenhagen. Her research interests are child development, processes of change and development in general as well as foundational issues (dualism) in psychology. Especially, she links those research interests and focus on how to conceive developmental processes within ecological and cultural-historical approaches to psychology. As a part of her work she is occupied with the development of qualitative research methods and methodologies. She has written several journal articles and book chapters addressing those matters. She is co-editing *Psyke & Logos* and is a member of the editorial board for *Culture and Psychology*. Address: Jytte Bang, Linnésgade 22, DK-1361, Kbh. K., Denmark. e-mail: jytte.bang@psy.ku.dk

**G. Anne Bogat** is Professor of Psychology at Michigan State University. She received her Ph.D. in Clinical Psychology from DePaul University, in 1982. She was Director of Clinical Training at Michigan State University for 11 years, and she served as President of the Society for Community Research and Action (Div. 27, APA) in the Academic Year 2007–2008. She has received numerous federal grants, conducting research in the areas of violence against women and mentoring. She has co-edited several special journal issues on topics concerning her research on violence against women. She has published numerous book chapters, encyclopedia entries, and articles in leading clinical, community psychology, and developmental journals, addressing topics in her main area of violence and in her theoretical area of person-orientation. e-mail: bogat@msu.edu

**Denny Borsboom** is associate professor at the Department of Psychology of the University of Amsterdam. He received his Ph.D. at that same university in 2003. His research interests cover the measurement problem in psychology, philosophy of science, psychometric modelling techniques, and validity theory. Denny Borsboom is the author of *Measuring the mind: Conceptual issues in contemporary psychometrics* (2005, Cambridge University Press) and has published on the conceptual problems of psychological measurement in journals such as *Psychological Review*, *Psychological Methods*, *Psychometrika*, and *Measurement*. e-mail: d.borsboom@uva.nl

**Daniel Cervone** is Professor of Psychology at the University of Illinois at Chicago. He earned his Ph.D. in Psychology from Stanford University in 1985. In addition to his time at UIC, Dr. Cervone has been a visiting faculty member at the University of Washington and at the University of Rome “La Sapienza,” and has been a fellow at the Center for Advanced Study in the Behavioral Sciences. He currently serves on the editorial boards of *Psychological Review* and the *European Journal of Personality*, and recently completed a term as Associate Editor at the *Journal of Research in Personality*. e-mail: dcervone@uic.edu

**Eva Ceulemans** is Assistant Professor at the Centre for Methodology of Educational Research, Catholic University Leuven, Belgium. Her research interests include hierarchical classes analysis and other types of clustering techniques, the modeling of multiway and multiset data, and the contextualized study of individual differences in personality, emotions, and affective dynamics. e-mail: eva.ceulemans@ped.kuleuven.be

**Nandita Chaudhary** is presently working as Reader at the Department of Human Development and Childhood Studies at Lady Irwin College, University of Delhi. She has a Ph.D. from University of Delhi and has been a Fulbright scholar at the Department of Psychology, Clark University, Worcester, Massachusetts. She has written several journal articles and chapters in books, and is actively involved with cross-cultural research and publication assignments. She has authored *Listening to Culture* published by Sage, New Delhi in 2004 and is Associate editor of the Sage journal *Culture and Psychology* and consultant editor for *Journal of Cross-Cultural Psychology*. She is actively engaged in research, teaching, writing, and advocacy about issues related to children and families in India. e-mail: nandita.chaudhary@gmail.com

**Maria Teresa del Rio** Ph.D. is a clinical psychologist graduated at the University of Joensuu Finland (1981), having received the specialty of family therapist (1992) and a Ph.D. from the Pontificia Universidad Católica de Chile (2007). Currently she is assistant professor of clinical psychology at the University Alberto Hurtado—Santiago Chile and she directs a post graduate program in systemic studies at the same institution. Her research is on child psychology, maltreatment and psychological elaboration in psychotherapy, particularly on the dialogical exchange between child and therapist, with a special focus on meaning making and the processes involved in semiotic mediation of psychological phenomena such as mutuality, ambivalence, and psychological distancing. The theoretical approach considered in her work integrates notions of systemic, constructivist and developmental perspectives to the study of a cultural, relational, and dialogical self. Address: Universidad Alberto Hurtado Almirante Barroso 26 Santiago, Chile, e-mail: mdelrio@uahurtado.cl

**Rainer Diriwächter** is an assistant professor of psychology at the Department of Psychology, California Lutheran University. His current interests lie with emotional experiences, Microgenesis, and the history of German psychology. He has published



several articles and book chapters that highlight the contributions of Völkerpsychologie and Ganzheitspsychologie. Recent book publications include “Striving for the Whole: Creating Theoretical Syntheses” (2008, Transaction Publishers; co-edited with Jaan Valsiner) and “Innovating Genesis: Microgenesis and the Constructive Mind in Action” (2008, Information Age Publishing; co-edited with Emily Abbey). Dr. Diriwächter is also the editor of the newly founded *Journal of Integrated Social Sciences* (JISS.org) and currently serves as editorial board member for the following peer-reviewed journals: *Culture & Psychology*, *Integrative Psychological and Behavioral Science* (IPBS), and the *Journal of Social, Evolutionary, and Cultural Psychology* (JSEC). Address: California Lutheran University, Department of Psychology, 60 West Olsen Rd. #3800, Thousand Oaks, CA 91360, USA. e-mail: rdiriwae@clunet.edu

**Conor V. Dolan** is associate professor at the Department of Psychology, University of Amsterdam. He obtained his Ph.D. under the supervision of Prof. P.C.M. Molenaar. His work is dominated by his interest in the theory and application of Structural Equation Modeling, and includes papers on group differences in IQ test scores, multi-group exploratory factor analysis, (longitudinal) finite mixture modeling, statistical power, and genetic covariance structure modeling. His present interests include statistical modeling of ability and age differentiation (with Dylan Molenaar—no relation of PCMM), and random effects modeling in association analysis (with Sophia van der Sluis). He owes much to his association with Prof. P.C.M. Molenaar and Prof. D.I. Boomsma (Biological Psychology, Vrije Universiteit), and to his association with his present colleagues. e-mail: c.v.dolan@uva.nl

**Mari Fukuda** is a student of graduate school of Humanities and Social Sciences, Okayama University, Japan. She received her master's degree in cultural science from Okayama University after receiving got a bachelor 's degree in psychology from Ritsumeikan University. Her academic interests are about the Quality of Life for the person with intractable disease. e-mail: fukudam.f@gmail.com

**Andrea P. Garvey** is a Psychology Professor at American River College in Sacramento, California, USA. Her primary research interests involve the application of dynamic systems principles to study infants' positive emotions and self in relational contexts. Migrogenetic designs are used to examine changing patterns in the mother-infant communication system, using intensive longitudinal video records of mother-infant dyads during the first seven months of the infant's life. More recently, GridWare has been incorporated into the analysis to assist in the visual identification of potential dynamic patterns (called attractor states) involving positive emotions and dyadic communication. She has authored and co-authored several research manuscripts, including a 2006 book *Change processes in relationships: Relational-historical research approach*, co-authored with Alan Fogel, Hui-Chin Hsu, and Lisa DeWest. Most recently, she is co-editing a book on microgenetic methodology with Maria Lyra and Micheline Silva, entitled *Microgenèse: Estudo do Processo de Mudança*, to be published in Brazil. Address: Department of Psychology, American

River College, 4700 College Oak Drive, Sacramento, CA 95831, U.S.A. e-mail: garveya@arc.losrios.edu

**Omar Gelo** is assistant professor and co-ordinator of the Doctoral Program for foreign students at Sigmund Freud University, Vienna. His research interests in the field of psychotherapy research concern the therapeutic process, with particular attention to metaphorical language, emotional-cognitive regulation, and the application of dynamic system theory to the study of psychotherapy. He is also interested in psychotherapy integration, the empirical study of therapeutic common factors, and in linking process and outcome in different psychotherapeutic orientations. e-mail: omar.gelo@sfu.ac.at

**Alessandro Gennaro** is a Ph.D. student in Clinical Psychology at the University of Salento (Lecce, Italy). He teaches Theory and technique of the psychological interview at the “Psychotherapy School of Psychology of the Life Cycle”—University of Padua. His scientific interests concern analysis of the psychotherapy process research and sensemaking dynamics in terms of dynamic systems. e-mail: gennaro\_alessandro@hotmail.com

**Miguel M. Gonçalves** is Associate Professor at the Department of Psychology in University of Minho (Braga, Portugal). He has been interested in narrative studies of the self and in narrative psychotherapy. He is presently developing a research project on the role that narrative innovations play in the promotion of psychotherapeutic change. Address: Department of Psychology, University of Minho, 4700 Braga, Portugal. e-mail: mgoncalves@iep.uminho.pt

**Ellen L. Hamaker** is an Assistant Professor in Methods and Statistics at the Faculty of Social Sciences, Utrecht University, Utrecht, The Netherlands. She obtained her Ph.D. under the supervision of Prof. P.C.M. Molenaar in 2004, and was a post doc at the University of Virginia with Prof. John R. Nesselrode. Her specializations are time series analysis and panel-based longitudinal techniques. In her work she focuses on bridging the gap between statistical techniques and the substantive interpretation of model characteristics, particularly in clinical and personality psychology. Recently she has taken up an interest in Bayesian statistics and model selection, and is working with Prof. Herbert Hoijtink (Utrecht University). e-mail: e.l.hamaker@uu.nl

**Tomo Hidaka** is a graduate student of master’s program in psychology, at graduate school of letters, Ritsumeikan University, Kyoto Japan. His research interest is communication support to the patients who have serious neurodegenerative disease called ALS (Amyotrophic Lateral Sclerosis). He conducts long-term fieldwork at the patient’s home focused on following two points. The first is how the local knowledge used in the field is created and maintained. The second is how a support network for the patients is expanded. The goal of his study is to build up the system for supporting the patients. He also studies about the science communication

between scientists and citizens in Science Café and explores the way to utilize it for patient advocacy. e-mail: thidakat@gmail.com

**S. Brian Hood** is Visiting Assistant Professor of Philosophy at Bucknell University. He received his Ph.D. in History and Philosophy of Science from Indiana University and was a Junior Visiting Research Fellow at Tilburg University at the Tilburg Center for Logic and Philosophy of Science in 2008. His dissertation *Latent Variable Realism in Psychometrics* (2008) concerns the theoretical status of latent variables and the philosophical foundations of psychological measurement. Additionally, he has defended the scientific integrity of psychometrics against charges that it is “pathological,” and he has argued for a “realist” conception of validity in psychometrics. e-mail: sbh013@bucknell.edu

**Angela Ittel** received her Ph.D. in Psychology at the University of Santa Cruz in California, USA, as a developmental psychologist and is a professor of Educational Psychology at the Institute of Education at the Technische Universität Berlin, Germany. In her work she has integrated interdisciplinary approaches to describe formal and informal processes of learning and development, particularly processes of psychosocial adjustment in late childhood and adolescence. She is a Co-editor of the *European Journal of Developmental Science* and also has a strong applied interest in transporting the principles of developmental science in to curricula development and teacher training. e-mail: ittel@zedat.fu-berlin.de

**Irini Kadianaki** is completing her Ph.D. thesis in social and developmental psychology at the University of Cambridge with the support of Alexander S. Onassis Public Benefit Foundation and Cambridge European Trust (George and Marie Vergottis Bursary). She is working on cultural psychological issues related to the migration transition, examining the cultural-symbolic coping of migrants moving to Greece. Her main interests involve the role of culture in human development and life transitions, issues of relocation, confronting otherness and dialogicality. Address: Irini Kadianaki, SPS, University of Cambridge, Free School Lane, Cambridge, CB2 3RQ, UK. e-mail: eik21@cam.ac.uk

**Rogier A. Kievit** is Ph.D. student at the Department of Psychology of the University of Amsterdam. He completed his masters degree with a dual focus on methodology and cognitive neuroscience. After his research master, he spent 15 months at Harvard University, working on mental imagery and mental rotation at the lab of Stephen Kosslyn. His interests range from conceptual, statistical, and theoretical issues of psychological science to current substantive topics in cognitive neuroscience. His Ph.D. project focuses on the theoretical and empirical development of statistical models to integrate brain and behavioral measures. e-mail: r.a.kievit@uva.nl

**Jürgen Kriz** studied psychology, philosophy, and astronomy/astrophysics in Hamburg and Vienna; 1972–1999 he had professorships in statistics, research methods

and philosophy of sciences at Department of Social Sciences at several universities and is 1980 until now professor for psychotherapy and clinical psychology, University of Osnabrück. Author of about 200 articles/book chapters and 15 books, editor of 10 books, some book series and journals, i.e., *Gestalt Theory*. Honorary member of systemic assoc. and internat.assoc. of existential analysis. 2005 “Grand Viktor-Frankl-Award of the City of Vienna” for his life work in the field of meaning-oriented humanistic psychotherapy. e-mail: juergen.kriz@uni-osnabrueck.de

**James T. Lamiell** is Professor of Psychology at Georgetown University in Washington, D.C. He obtained his Ph.D. at Kansas State University in 1976, and was for six years a member of the Psychology faculty at the University of Illinois at Urbana-Champaign before moving to Georgetown in 1982. As a three-time Fulbright scholar to Germany, Lamiell has held guest professorships at the University of Heidelberg (1990), the University of Leipzig (1998), and the University of Hamburg (2004). In Hamburg, Lamiell also held the position of Ernst Cassirer Guest Professor in the Institute of Philosophy. His teaching and research interests are in the history and philosophy of psychology, with particular focus on the works of the German philosopher/psychologist William Stern (1871–1938). He has authored *The Psychology of Personality: An Epistemological Inquiry* (Columbia, 1987), and *Beyond Individual and Group Differences: Human Individuality, Scientific Psychology, and William Stern’s Critical Personalism* (Sage, 2003). He has also published *Recollection, Testimony, and Lying in Early Childhood* (APA Books, 1999), a translation of Clara and William Stern’s *Erinnerung, Aussage und Lüge in der ersten Kindheit* (1909). e-mail: lamiellj@georgetown.edu

**Rosapia Lauro-Grotto** graduated in Theoretical Physics at Roma “La Sapienza” University and obtained a Ph.D. in Cognitive Neuroscience at the International School for Advanced Studies (I.S.A.S.—S.I.S.S.A.) in Trieste. She is currently Researcher at the Department of Psychology at Florence University. She is Responsible for the Methodological Training of the Ph.D. School of Psychology, Full Member of the Interdepartmental Center for Non Linear Systems and Complex Dynamics at Florence University and member of the Italian Society of Neuropsychology. Her research interests have focused on the investigation of the function/structure relationship in modelling brain functions and in the assessment and simulation of neuropsychological syndromes. She has now moved to the domain of psychodynamics, where she performs both theoretical research and interventions with Health Care professionals in different domains of the Public Health Institutions. e-mail: rosapia.laurogrotto@unifi.it

**Anna Lichtwarck-Aschoff** is Assistant Professor in the research program Developmental Psychopathology at the Radboud University Nijmegen in The Netherlands. She recently obtained her Ph.D. at the University of Groningen. Her Ph.D. research focused on identity development of adolescent girls from a dynamic systems perspective. Her primary research interests are interactional processes and relational dynamics, with a specific focus on parent-child relationships. e-mail: a.lichtwarck-aschoff@pwo.ru.nl

**Maria C.D.P. Lyra** is currently Full Professor of Psychology at the Federal University of Pernambuco, Brazil. She has been working in a research program that relies on the study of history and dynamics. She coordinates a research laboratory—Lab-Com—dedicated to study the process of communication in infancy using dynamic systems and dialogical perspectives to explain the emergence of *self* in early ontogeny. New insights into the nature of the developmental process using the new theory of abbreviation has become internationally well established in developmental psychology. Her methodological emphasis on the relationship between microgenetic and macrogenetic developmental processes is one of her contributions. The current direction of the LabCom—to utilize the breakthroughs of Dynamic Systems Theory and Dialogical Theories to explain the emergence of signification in early ontogeny—is at the forefront of developmental science. The LabCom is an internationally recognized leader in this area, and Professor Lyra has been a leading advisor to Brazilian scholars in the area of developmental science in their entry to the international scientific community. e-mail: marialyra2005@yahoo.com.br

**Peter C.M. Molenaar** is currently Professor of Developmental Psychology at Penn State University, after a long productive research career at the University of Amsterdam in the Netherlands. He is currently the World's leading authority in the field of mathematical modeling of dynamic processes in developmental science. His main contribution to science is in the investigation into the mathematical–statistical ergodic theory to study the relationships between intra-individual (idiographic) analyses and inter-individual (nomothetic) analyses of psychological processes. He is well-known for developing innovative statistical multivariate time series techniques for the analysis of intra-individual processes (e.g., dynamic factor analysis), which now are applied in several research centers throughout the World. He has proven, based on the classical ergodic theorems, that for nonstationary processes such as learning and developmental processes it is necessary to focus on intra-individual variation (person-specific time series analysis). This proof has led to a major re-orientation of psychometrics (e.g., test theory) and psychological methodology, which until now have been largely focused on analyses of inter-individual variation.

Molenaar has been a pioneer in the application of nonlinear multivariate statistical signal analysis techniques to solve the problem of mapping theoretical models of cognitive information-processing onto dynamically interacting EEG/MEG neural sources embedded in spatio-temporally coherent backgrounds. He has also used the adaptive resonance theory (ART neural networks) to study the effects of nonlinear epigenetical processes. Use of mathematical biological models of self-organization. More recently a new research line has been started to investigate the ontogenetic phenotypical variation of so-called cloned (artificial) neural networks. e-mail: pxm21@psu.edu

**María Elisa Molina** Ph.D. is a clinical psychologist graduated at the Universidad Católica de Chile (1985), having received the specialty of family therapist (1990) and a Ph.D. from the Pontificia Universidad Católica de Chile (2007). Currently she is director of the post graduate clinical psychology program at The University del

Desarrollo of Santiago Chile. Her research is on child sexual abuse and meaning construction in psychotherapy, with a special focus on the psychological processing of mothers and caregivers of abused children. Her research interest address the use of semiotic approach as a methodology to explore psychological processes, particularly psychotherapy, and semiotic mediation itself as a main process of psychological phenomena and human experience. The theoretical approach considered in her work integrates notions of systemic, constructivist and developmental perspectives to the study of a cultural, relational and dialogical self. Address: Universidad Del Desarrollo Escuela de Psicología. Avda. la Plaza 700 Las Condes Santiago, Chile. e-mail: memolina@udd.cl

**Naohisa Mori** is currently a professor of Human Sciences at Sapporo Gakuin University, who started his career as an experimental psychologist of memory. After receiving his master's degree from Tsukuba University, he learnt the social nature of memory and became interested in the social and institutional constraints on remembering. He made some participated observation on joint remembering in professional wrestling fans' circles. He has also been collaborating with lawyers in the examination of the credibility of confession and testimony. In this collaboration, he knew he had to study the veracity of an experience in remembering. He is dedicating himself to the development of the schema approach through empirical and theoretical studies. Professor Naohisa Mori Faculty of Humanities, Department of Clinical Psychology, Sapporo Gakuin University, 11 Bunkyo-dai, Ebetsu-shi, Hokkaido, Japan. e-mail: morichan@sgu.ac.jp

**Kay Niebank** is a clinical psychologist graduated at the University of Bremen, Germany. Currently he is research associate at Freie Universität Berlin, Germany and editorial assistant of the *European Journal of Developmental Science* ([www.ejds.net](http://www.ejds.net)). He has co-authored *Entwicklungswissenschaft* (Developmental Science), a textbook published by Springer, Heidelberg. His research interests involve the importance of special abilities like synaesthesia and savant syndrome for the fields of Developmental Psychopathology and Developmental Science. e-mail: kniebank@uni-bremen.de

**Aglaja Przyborski** is a psychologist and a psychotherapist with interests in further development of qualitative resp. reconstructive methods and their imparting in teaching methodology with a focus on the documentary method, discourse analysis, especially in its direction of the method of group discussion iconicity: pictures and films as a methodological option for psychology and social sciences. Research areas (empirical studies): Milieu- and gender-specific orientations (adolescence and migration), marketing research, media research. e-mail: aglaja.przyborski@univie.ac.at

**Maartje E.J. Raijmakers** is associate professor at the section Developmental Psychology, Department of Psychology, University of Amsterdam. She has a master's of Philosophy in philosophical logic and Artificial Intelligence. Her Ph.D. (cum

laude) in psychology under supervision of P.C.M. Molenaar & M. van der Molen (University of Amsterdam) was about “Epigenesis in neural network models of cognitive development.” Her research interests regard development of learning: including category learning and causal reasoning. Her approach is to distinguish different learning and reasoning strategies by the application of latent variable models that account for inter-individual and intra-individual differences. She has a multi-disciplinary approach to developmental research questions: empirical research, mathematical modeling of the acquisition and transfer processes, neural network models of learning mechanisms, and nonlinear dynamic models changes in development. e-mail: m.e.j.raijmakers@uva.nl

**Nilam Ram** is an assistant professor in the Department of Human Development and Family Studies at the Pennsylvania State University. He obtained his Ph.D. and interest in intraindividual concepts and methods while working with John R. Nesselrode and the University of Virginia. Nilam is interested in how short-term changes (e.g., processes such as learning, information processing, etc.) develop over the course of the lifespan and how intraindividual change and variability study designs (e.g., measurement bursts) might contribute to our knowledge base. Current projects include examinations of: age differences in short-term dynamics at the cognitive/affective/temperament interface; cyclic patterns in the day-to-day progression of emotions; and change in cognition and well-being over the lifespan, particularly in old age. Together with Peter Molenaar and other colleagues he is working to develop a variety of multi-person extensions of intraindividual analytic methods and investigating how we can maintain a focus on the individual while still tackling issues of aggregation and generalizability. e-mail: nilam.ram@psu.edu

**Susan Rasmussen** is Professor of Anthropology at the University of Houston. Her interests include religion, healing systems, gender, the life course and aging, and verbal art performance. She is the author of four books: *Spirit Possession and Personhood among the Kel Ewey Tuareg* (Cambridge University Press 1995); *The Poetics and Politics of Tuareg Aging* (Northern Illinois University Press 1997); *Healing in Community* (Bergein & Garvey 2001); and *Those Who Touch* (Northern Illinois University Press 2006), as well as numerous articles and chapters in journals and edited volumes. These publications are based upon field research in rural and urban Tuareg (Kel Tamajaq) communities of northern Niger and Mali, and briefly, among Tuareg expatriates in France. Address: Department of Anthropology, McElhinney Hall, University of Houston, Houston, TX, 77204-5080, USA. e-mail: rasmussen@uh.edu

**Sergio Salvatore** is full Professor of Dynamic Psychology at the University of Salento, Lecce, Italy; Chairperson of the “Psychological Sciences and Techniques” Degree Course Council. Director of the Doctoral Course in “Sciences of the Mind and Human Relations” (University of Salento). Co-editor of the peer reviewed Journals: *European Journal of School Psychology*; *Integrative Psychological and Behavioral Science*; *Psicologia Scolastica*. Associate Editor of *Rivista Psicologia*

*Clinica*—RPC Review of *Clinic Psychology*. Member of the Advisory Board of various peer-reviewed Journals. His scientific interests regard psychodynamic theorization of mental processes and methodology of empirical analysis of socio-symbolic dynamics. He also takes an interest in the theory and the analysis of psychological intervention in clinical, scholastic, organizational and social fields. On these issues he has designed and managed various scientific projects; he has published over ten books and a hundred articles in Italian and international Journals. Address: Department of Educational, Psychological and Teaching Science, Via Stampacchia, 45, 73100 Lecce. e-mail: sergio.salvatore@ateneo.unile.it

**Anita Santos** recently finished her Ph.D. on Clinical Psychology from the University of Minho (Braga, Portugal). She currently teaches Research Methods in Psychology at ISMAI—Instituto Superior da Maia (Maia, Portugal). Her research interests are related to psychotherapeutic process research, within the theoretical framework of narrative therapy and self dialogical theory. She has been co-author of several papers in this scientific area, namely with case studies and microgenetic analysis of psychotherapeutic processes. e-mail: anitasantos@docentes.ismai.pt or m.anitasantos@sapo.pt

**Tatsuya Sato** is a professor of psychology at the Department of Psychology, Ritsumeikan University, Kyoto, Japan. His general interests are in the history, theory and methodology of psychology. He is a founding editorial board (2000–2005) of the Japanese Journal of Qualitative Psychology (in Japanese) and he has actively involved in Japanese Association of Qualitative Psychology (JAQP). He is also an editorial board of History of Psychology and Psychology Studies (in Japanese), Japanese Journal of Law and Psychology (in Japanese), The International Journal of Idiographic Science and Culture and Psychology. In 1999 he was awarded the “Best Article Prize” of Japanese Association of Developmental Psychology. e-mail: satotster@gmail.com

**Herbert Scheithauer** is the Head of the Division Developmental Science and Applied Developmental Psychology at Freie Universität Berlin, Germany. Lectures in Developmental Science, Developmental and Educational Psychology. Faculty Member at the International Max Planck Research School “The Life Course: Evolutionary and Ontogenetic Dynamics” at Max Planck Institute for Human Development, Berlin. He is member of several advisory boards (e.g., Stiftung Deutsches Forum für Kriminalprävention [DFK]). He was principal investigator or research fellow in several longitudinal studies (e.g., Bremer Youth Study, Augsburg Longitudinal Evaluation Study of the Programme Papilio [ALEPP]) and has received several grants and funds. He has authored/co-authored several scientific papers in clinical child psychology, developmental psychology and developmental psychopathology/developmental science and is editor in chief of the *European Journal of Developmental Science* (www.ejds.net). e-mail: hscheit@zedat.fu-berlin.de

**Thomas Sluneko** is professor at the University of Vienna’s Faculty of Psychology. His interest in qualitative methodology is closely connected to his research focus in



psychology/theory of culture—a focus which developed out of an academic journey that led him through theory of science, media and systems theory, phenomenology, and ‘science & technology’-studies. Apart from this theoretic endeavours, Thomas Slunecko is a practicing psychotherapist, too. e-mail: thomas.slunecko@univie.ac.at

**Beat Thommen** is Professor at the Department of Special Needs Education, University of Applied Sciences in Bern, Switzerland. He is working as a lecturer for history of science and methodology and is leading the research section of the Department. He acquired his Ph.D. in 1983 at the Department of Psychology at the University of Fribourg/Switzerland, investigating everyday psychology of teachers. He has held lectureships at the Departments of Psychology at the Universities of Fribourg and Bern (Switzerland). His main fields of research are action theory and theory of social representations, behavior disturbances, and social processes in educational settings. In current research projects, theoretical, and methodological principals of dynamic systems theory are applied on the investigation of social processes in natural classroom-settings. e-mail: beat.thommen@phbern.ch

**Marieke E. Timmerman** is Associate Professor in Methods for Data Analysis at the Heymans Institute for Psychological Research at the University of Groningen in The Netherlands. Her research focuses on the development of models for multivariate data with complex structures, to obtain an understanding of the processes underlying those, mainly psychological, data. Her research interests include data reduction methods, latent variable models, classification, and multilevel, multiway and multiset models. She serves as an associate editor of *Psychometrika*. e-mail: m.e.timmerman@rug.nl

**Aaro Toomela** is Professor of Neuropsychology at Tallinn University, Estonia. He received his MD from the University of Tartu in 1986. After spending seven years as a child neurologist in the Department of Neurorehabilitation at the Tartu Children’s Clinic, he moved into psychology. From 1993 to 2000 he was a lecturer specializing in neuropsychology in the Department of Psychology at the University of Tartu. Research from that time concerned the consequences of brain damage, the development of memory and drawings, and the role of culture in the development of the human mind. He received his M.Sc. in 1996 and his Ph.D. in 2000 from the University of Tartu. To get acquainted with the applied aspects of psychology, Aaro Toomela moved to the military world, where he was a head of the Department of Social and Behavioral Sciences in the Academy of the Estonian Defense Forces. There he worked on the test battery for military personnel selection in the Estonian Defense Forces and on different aspects of the psychology of alcoholism and drug abuse. In the last five years Aaro Toomela has been back to the academic world working in the field of psychology at the University of Tallinn and in the field of education in the University of Tartu. Address: Aaro Toomela, Tallinn University, Department of Psychology, Narva mnt. 25, Tallinn, Estonia. e-mail: aaro.toomela@ut.ee

**Jaan Valsiner** is a cultural psychologist with a consistently developmental axiomatic base that is brought to analyses of any psychological or social phenomena. He is the founding editor (1995) of the Sage journal, *Culture & Psychology*. He is currently professor of psychology at the Department of Psychology, Clark University, USA. He has published many books, the most recent of which are the *Cambridge Handbook of Socio-Cultural Psychology* (2007, with Alberto Rosa) and *Culture in Minds and Societies* (New Delhi: Sage, 2007). He has established the new journal on individual case analyses—*International Journal of Idiographic Science* (2005—www.valsiner.com) and is the Editor-in-Chief of the Springer Journal *Integrative Psychological and Behavioral Sciences*. In 1995 he was awarded the *Alexander von Humboldt Prize* in Germany for his interdisciplinary work on human development, and Senior Fulbright Lecturing Award in Brazil 1995–1997. He has been a visiting professor in Brazil, Japan, Australia, Estonia, Germany, Italy, United Kingdom, and the Netherlands. e-mail: jvalsiner@gmail.com

**Han L.J. van der Maas** is professor and chair of Psychological Methods and director of the graduate school of Psychology at the University of Amsterdam. His research interests concern mathematical, computational and statistical models of psychological processes, especially developmental processes related to cognition. More applied work concerns new methods of computer adaptive testing in education. e-mail: hvandermaas@fmg.uva.nl

**Kristof Vansteelandt** obtained his Ph.D. in psychology at the Department of Psychology of the Catholic University Leuven, Campus Kortenberg, Belgium, and is presently working at the University Psychiatric Center of the Catholic University Leuven, Belgium. His main research concerns describing intra- as well as inter-individual differences and understanding the processes underlying these differences in several behavioural domains by making use of ecological momentary assessment and different formal models like multilevel models. e-mail: kristof.vansteelandt@uc-kortenberg.be

**Dankert Vedeler** is an Associate Professor Emeritus at the Norwegian University of Science and Technology (NTNU), Trondheim, Norway, where he earlier has coordinated an International Master's Course in Human Development. He studied philosophy in France before doing psychology in Sweden. His main interests are the development of infant intentionality and theoretical psychology. His research on infant intentionality is inspired by Merleau-Ponty and Alan Fogel. In theoretical psychology, he explores the contributions to the field of psychology of Gibsonian Ecological psychology, Dynamic Systems Approach, different theories of embodiment, and process oriented approaches to psychology. Address: Department of Psychology, NTNU, NO-7491 Trondheim, Norway. e-mail: dankert@svt.ntnu.no

**Ingmar Visser** is assistant professor at the Developmental Psychology group at the University of Amsterdam. His research interests center around learning processes and their development. His Ph.D. studied knowledge representations that are acquired incidentally through implicit learning and how such knowledge acquisition is best mod-

eled by neural networks and hidden Markov models. He continued the development of sophisticated mathematical modeling approaches after receiving a VENI grant from the Netherlands Organisation for Scientific Research (NWO). Current interests include latent variable models for learning and developmental processes, in particular discriminating continuous from discontinuous learning; the application of such models in several domains in (experimental) psychology; the characterization of learning processes, in particular in implicit learning and categorization. e-mail: i.visser@uva.nl

**Alexander von Eye** is Professor of Psychology at Michigan State University. He received his Ph.D. from the University of Trier, Germany, in 1976. He has held positions at the University of Trier and Erlangen-Nürnberg, and at the Max Planck Institute for Human Development and Education in Berlin, all in Germany, and at Penn State and, now, Michigan State, in the U.S. His main area of research is in quantitative methods and Applied Statistics. He focuses on methods of analysis of categorical data, modeling, longitudinal data, and computer simulations. He has developed Configural Frequency Analysis (CFA) to be a multivariate method that allows one to analyze data from a person-oriented perspective. He has authored three books on CFA and numerous books, book chapters, encyclopedia entries, and journal articles on methodological, statistical, and substantive psychological topics. e-mail: voneye@msu.edu

**Brady Wagoner** is completing his Ph.D. in psychology at University of Cambridge, with the support of the Gates Cambridge Trust and the ORS award. His main interests are the history of psychology, sociogenetic thought (e.g., Bartlett, Janet, Mead, Vygotsky, etc.), various psychological philosophies (e.g., existentialism and pragmatism), the experimental study of perceiving and remembering, and the absurd pursuit of mountain summits. He is on the editorial board of three international Journals (the *International Journal of Dialogical Science*, *Integrative Psychological and Behavioral Science* and *Psychology and Society*) and is co-creator of the *F.C. Bartlett internet archive* [Accessed at: [www-bartlett.sps.cam.ac.uk](http://www-bartlett.sps.cam.ac.uk)]. He editor of *Symbolic Transformation: the mind in movement through culture and society* (Routledge) and *Culture and Social Change: Transforming society through the power of ideas* (Information Age). e-mail: bw249@cam.ac.uk

**Alexander Wettstein** is a Lecturer at the Department of Special Education, University of Applied Sciences in Bern, Switzerland. He acquired his Ph.D. in 2007 at the Department of Psychology/University of Bern, Switzerland. His main field of research is on systematic behavior observation in educational settings. He conducted a series of field studies on social behavior in naturalistic educational settings. In 2008 he authored the *Observation System for the Analysis of Aggressive Behavior in Classroom Settings BASYS* and published a series of articles concerning the quality of teaching and social interaction in educational settings. He has hold lectureships at the Department of Psychology at the University of Bern and the Department of Educational Sciences at the University of Fribourg (Switzerland). e-mail: alexander.wettstein@phbern.ch

**Tania Zittoun** is Professor of Education at the University of Neuchâtel, Switzerland. Her current interests follow three lines: the study of transitions in the life course, the study of institutions that support or hinder these, and the study of semiotic mediation in psychological change, with a strong emphasis for the role of art and fiction as symbolic resource in sense making. She is the author of a book on naming during the transition to parenthood (*Donner la vie, choisir un nom*. Paris: L'Harmattan, 2005) and of books on youth, in institutions (*Insertions*, Bern: Peter Lang, 2006) and using symbolic resources (*Transitions. Development through symbolic resources* (Greenwich: InfoAge, 2006); she is also coeditor of *Joining society, on youth* (Cambridge: Cambridge University Press, 2004). e-mail: [tania.zittoun@unine.ch](mailto:tania.zittoun@unine.ch)

# Chapter 1

## The Unbearable Dynamicity of Psychological Processes: Highlights of the Psychodynamic Theories

Rosapia Lauro-Grotto, Sergio Salvatore, Alessandro Gennaro and Omar Gelo

The term *dynamic* generally refers to the psychology grounded on and informed by psychoanalysis—even if dynamic perspectives do not necessarily coincide with it. It is well known that in Freudian theory, the dynamic level of analysis is that focused on conflicts and their role in shaping psychological facts. Yet contemporary psychoanalytically oriented psychology gives a broader meaning to the label, and consequently *dynamic psychology* is the psychology concerning the affective source (motivation, instinct, intra-psychic, and/or interpersonal conflicts) shaping (inter)subjectivity. Thus, in contemporary psychology the term *psychodynamic* can be seen as a synecdoche where the whole—the psychoanalytically oriented psychology—is referred to by means of the part—the dynamic level of analysis as conceptualized by Freud. Here we assume this broad definition. Therefore, henceforth the term psychodynamic will be used as being synonymous with psychoanalytically oriented psychological theory.

### What Do We Mean by *Dynamic*?

As a starting point we will try to specify the semantics of the core concept of our discussion: *dynamic*. As matter of fact, the use of this term is characterized by a rather high level of polysemy. It is not within the scope of this work to achieve a systematic semantic analysis. In a stricter sense, we want to clarify the way we will use this concept in the discussion that follows.

We find it useful to distinguish between three general ways of using the term. As a premise, one can note that the attribute *dynamic* is often used in a metaphorical way, in order to connote certain phenomena—an object, a person, an event—as something active that is able to move (in space as well as in time) as well as to

---

R. Lauro-Grotto (✉)  
Department of Psychology  
Florence University  
Florence, Italy  
e-mail: rosapia.laurogrotto@unifi.it

transfer its motion onto another object. Yet, because we are interested here in the concept as a scientific tool, as one enabling researchers to deepen their understanding of psychological phenomena, we will focus on two other levels: *dynamic* as a theoretical concept and as a methodological tool.

### ***Dynamic as a Theoretical Concept and a Methodological Tool***

First of all, the term *dynamic* can be used with a specific theoretical denotation. According to this use, a phenomenon is to be conceived as *dynamic* insofar as its manifestations show a set of defining features.<sup>1</sup> In our opinion, the defining characteristic at stake is the *explicit dependence on time*. In other words, qualifying a phenomenon as *dynamic* means that its temporal dimension can not be excluded by any sensitive description of the phenomenon. Any description that does not take into account the temporal evolution of the phenomenon would not show any power of explanation.

It is worth noticing that generally speaking, every phenomenon has some form of temporality. As matter of fact, a phenomenon is such precisely because it is a pattern of variability and this pattern cannot but have a space-time extension (Valsiner, 2007). From this perspective, one can refer to Kant and recognize that time is a fundamental way of shaping experience, and thus the perception itself of the phenomena. Yet a distinction is required here. One has to distinguish between the phenomenon—which necessarily unfolds through time—and the model of it, that can either take (or not take) time into account as a necessary descriptive/explicative dimension. According to this distinction, dynamic models are opposed to structuralist ones, depicting the phenomena in terms of a-temporal relationships between the elements of the observed system (Sève, 1972).

One can find many examples of structuralist models. For instance, Ignacio Matte Blanco's bi-logic theory (Matte Blanco, 1975) depicts the unconscious in terms of logical rules (principle of symmetry and generalization) according to which it generates forms of emotional categorization of the experiences. According to this theory, one can explain the unconscious process of meaning making just by referring to these rules, therefore without taking time into account.

---

<sup>1</sup> If one assumes, as we do, a non realistic epistemology, it would be more coherent to say that from a theoretical point of view a phenomenon can be denoted as "dynamic" insofar as its manifestations are suited to being depicted accordingly to a model of functioning of such phenomenon having some given defining characteristics. An assertion like this reflects the general epistemological a-ontological assumption according to which any theoretical attribute should not be considered as a description of an intrinsic, essential property of the phenomenon, but rather as an observer's category usable as a semiotic device in order to encounter the observed (Maturana & Varela, 1980). However, having made this specification here, in order to avoid to weighing down the exposition, we will take it as being valid for the following pages.

## ***Psychodynamic Theory is Not a Synonym of the Dynamic Approach***

According to the meaning entailed in its definition, psychodynamics should be particularly oriented to mapping the psychological process in a dynamic way. Yet this is only partially true. Psychopathology models, basic theories of the mind's functioning (what psychoanalysts call "metapsychology", inter alia, Rapaport, 1960) as well as the conceptualization concerning clinical methodology (what psychoanalysts call "theory of the technique", inter alia Odgen, 2004), all these sub-domains of psychodynamics tend to entail a vision of the psychological phenomena as a "moving" process, that is unfolding through time and pushed or shaped by needs, goals to be reached, and conditions to be overcome. Just to give one example, inter-subjective psychoanalysts (inter alia, Storolow, Atwood, & Brandchaft, 1994) highlight how people engage in co-construing the meaning of the interpersonal experience, using the patterns of affective meaning available for this purpose. By doing so people either succeed in developing new dialogical frames or they do not. The latter outcome grounds the psychopathological condition. In the former case a new interpersonal world is developed as the basis for further dialogical developments.<sup>2</sup>

However, if we shift the focus from the theoretical plane to the methodological one, we must conclude that on this latter level the various psychoanalytic perspectives share a general inability to carry out empirical analyses informed by a dynamic conception of the phenomena under scrutiny. Thus, if we look around for pertinent empirical studies, one can find laboratory and/or field experiments (for a critical review of the experimental approach in clinical research, see Westen, 1998), and applications of the methods of differential psychology (as can be found in psychopathological studies. For a review, Gabbard (2005), or in the literature on Attachment Theory, e.g., for a review, Cassidy and Shaver (1999). Of course, the historical-hermeneutic perspective has a very important tradition in psychoanalysis. One can specifically encounter single case analyses (starting from the seminal Freudian single cases). Yet these kinds of studies are characterized by a literal and metaphorical mode of description (Orsucci, 2006) that makes it hard to produce the kind of knowledge that is systematically and consensually usable outside the cases described, as well as outside the often implicit theoretical assumptions of the person giving the account.

The above considerations make it clear why we have chosen to adopt the term *psychodynamic*, instead of dynamic psychology: Psychodynamic is not (necessarily) a 'dynamic' psychology! Actually the issue is more complex. As we have recalled, psychodynamic theories model a huge spectrum of psycho-

---

<sup>2</sup> Obviously, not every psychodynamic theorist shares such a (broadly speaking) developmental look. Psychoanalysis is far from being an unitary domain: As Wallerstein (1998) states, there are many psychoanalyses, not one. Therefore, it should not be surprising to recognize that to some extent a mechanistic point of view is still represented in the psychoanalytic field. It would not be hard to give an example of a psychodynamic theory that sees the phenomenon investigated as an epiphenomenon of an underlying a temporal mechanism.

logical processes—and, we add, psychosocial too—in ways that highlight their dynamic nature. Nevertheless, psychodynamics has not systematically and consensually elaborated a methodology of empirical investigation coherent with the dynamic nature of the processes of interest. In this chapter we intend to highlight the dynamic nature of various psychological phenomena by referring to the psychodynamic theory. In the connected chapter (Salvatore, Lauro-Grotto, Gennaro, & Gelo, 2009) we discuss some of the main methodological issues concerning the empirical investigation of psychological phenomena once they are conceptualized as intrinsically dynamic.

While using the notion of *dynamic* as a methodological tool, one can refer to the repertoire of formal models and corresponding techniques of investigation that have the Dynamic Systems theory (DS) as their source. It is important to distinguish between the two meanings. This is because thinking of a psychological phenomenon as dynamic does not necessarily entail using DS. Yet, on the contrary, the adoption of such a methodological frame first requires that the phenomenon is theoretically defined as dynamic.

## *Dynamic Systems*

In very general terms, a dynamic system is a mathematical model of a phenomenon: the phenomenon is a response to an external input that is dependent both on the input itself and on the inner state of the system. In fact at any instant  $t$  a dynamic system is described by the vector of a certain number  $n$  of time depending *on* state variables:  $x(t) = (x_1(t), x_2(t), \dots, x_n(t))$ . If time is a continuous variable then the law that explicitly determines the evolution of the system takes the form of a system of differential equations:

$$\begin{aligned} dx(t)/dt &= f(x(t), x_0, u(t), t) \\ y(t) &= h(x(t), x_0, u(t), t) \end{aligned}$$

where  $x(t)$  is the vector of the state variables,  $dx(t)/dt$  is its first derivative with respect to time,  $x_0$  provides its initial conditions, while vectors  $u(t)$  and  $y(t)$  are the input and output of the system, respectively. The first equation expresses the variation of the state variables as a function  $f$  of the state of the system at time  $t$ , of the input and of the initial conditions. The second equation describes the functional law  $h$  for the evolution of the output, that is the response of the system, from which the internal state has to be read out.

From the mathematical point of view, the description of a dynamic system implies the integration of the system of equations which allows for the computation of the function describing the temporal evolution of the state variables  $x(t)$ , the so called *transition function*. This function, once assigned to the state of the system at an initial moment  $t_0$ , allows the state of the system at any subsequent instant of time to be determined. Therefore, in connection to our previous dis-



cussion, the mathematical function is the formal law of the development of the phenomenon.<sup>3</sup> It is worth pointing out that the DS is not a unitary repertoire of models. Rather, it is a family of formal methods, each of them focusing on a kind of system or of conditions of systemic functioning. In accordance with the aim of our discussion, we concentrate on the models that are more useful for psychological investigation.

### *A Basic Typology of Dynamic Models*

Two fundamental features allow a useful classification of dynamic systems. First, systems are said to be *stationary* or *time invariant* if the equation's parameters are constant in time, and *non stationary* otherwise. A second crucial distinction we have to take into account is the one between *linear* and *non linear* dynamic systems. In the case of linear dynamic systems, even if the state of the variables depends on time, this dependence is stable. This characteristic is reflected on the formal level, in the fact that the temporal evolution function describing the state of the system is defined by of first order equation(s).<sup>4</sup> As a consequence, the linear dynamic system preserves the property of compositionality, or in converse terms, of the linear decomposition of variables, and the tools of matricial algebraic calculus can be applied. Non-linear systems are on the other hand described by equations of order higher than one (see Note 5). For this reason, in this case linear compositionality of the solutions is not given (Strogatz, 1994; Kaplan & Glass, 1995).

The simplest example of a linear dynamic system is given by the map (i.e., an equation for discrete time steps) representing the evolution of the density of a population evolving in an environment with unlimited food resources.

$$X(t + 1) = rX(t)$$

where  $r$  parameter expresses in a suitable way the dependence on the death rate and the reproduction rate. The evolution of the system is given by the law expressing the behaviour of the population density for  $t \rightarrow \infty$  (asymptotic behaviour). It

---

<sup>3</sup> DS specify the properties of the transition function of a dynamic system. Here we will try to rephrase the properties in a less formal way. *Consistency* implies the existence of a well defined state of the system at all time values and for all admitted input functions; *compositionality* implies that evolution in time can be described 'step by step', taking the state reached at a given time point as starting condition for subsequent computations; *causality*, implies that if two dynamic systems with identical transition function but starting their evolution from two different initial conditions and different inputs, are found to be in the same state at a given time point, and if they receive the same input thereafter, they will have the same evolution in time, irrespective of the differences due to the initial conditions and previous evolution.

<sup>4</sup> In general terms a first order dependence is expressed in the form of a polynomial having variables with low power=1, i.e.,  $y=ax+b$ . The typical feature of a linear dependence is that the correspondence between a given increment of the independent variable,  $\Delta x$ , and the corresponding increment of the dependent variable,  $\Delta y$ , is given by a constant, and therefore is not dependent on  $x$ .

depends on the value of parameter  $r$ . For  $r = 1$  the population density keeps constant ( $X(t + 1) = X(t)$ ) in time; for  $r > 1$  it has an exponential growth to infinity and for  $r < 1$  the population density has an exponential decrement towards 0.

In order to avoid confusion it is important to note that although the equation governing the evolution of the system is linear in the sense that  $X(t + 1)$  is linearly dependent on  $X(t)$ , this does not imply that the dependence of  $X$  on time  $t$  should be linear as well. On the contrary it can be shown that exponential growth or decrement of the dynamic variable  $X(t)$  on time<sup>5</sup> are the solutions of this linear equation. This is the known case of the exponential growth of the population in a bacterial colony in which all the bacteria split themselves in two at, say, every 20 min.

## Periodicity

According to our aim an interesting type of linear dynamic system is the one that shows a periodic behaviour. As an example, consider the harmonic oscillator,<sup>6</sup> corresponding to a point of mass  $m$  executing small oscillations due to a spring of elastic constant  $k$  in the absence of friction. This system has two independent solutions, describing the sinusoidal oscillation of the point around the rest position. Due to the property of *compositionality*, typical of linear systems, any linear combination of the two independent solutions will be a solution of the equation as well.

A convenient way of depicting the behaviour of a system in time is by representing its evolution by a trajectory in the phase space. This is a ‘shaped’ space—a variety in mathematical terms—it can be a plane, a cylinder, a torus, and so on... having the degrees of freedom of the system as dimensions: the points of the phase space are all and only the possible states of the system. The time evolution of periodic systems can be represented by a closed orbit, with every point representing the position of the system in the phase space at a given instant. The perpetual motion of a pendulum (in an empty space) is the typical example of this kind of trajectory. The interest of the periodic trajectory is that it allows the depiction of a behaviour that appears to be changing in time—i.e., the velocity of the mass point of the oscillator changes instant by instant, increasing and then decreasing, and so on—yet is globally stable, in the sense that the system tends to come back to the same point of (unstable) equilibrium. As we will show in detail below, this kind of cyclic trajectory is consistent with various psychodynamic conceptualizations.

<sup>5</sup> The typical feature of a non-linear dependence on time is that the correspondence between a given increment of the independent variable,  $\Delta X$ , and the corresponding increment of the dependent variable,  $\Delta t$ , is not constant. In our example, consider the case of an exponential growth of the density of a bacterial colony in vitro, described by the transition function  $X(t) = X_0 \exp(t)$ . In this case the population density roughly triples at each time step, with a  $\Delta X$  that becomes larger and larger as time elapses.

<sup>6</sup> This is indeed a second order linear system as it is the second derivative of the displacement from the rest position  $d^2x(t)/dt^2$  that is linearly dependent on  $x(t)$ , as the equation reads:  $d^2x(t)/dt^2 = -(k/m)x(t)$ .

## *Deterministic Chaos*

Deterministic chaos is another important branch of DS, in this case concerning non linear systems. Chaos characterizes the behaviour of non linear systems for specific values of the parameters in the set of equations defining the system. Consider as an example the map (i.e., an equation for discrete time steps) describing the temporal evolution of the population density  $X(t)$  in a given environment characterized by given values of the death rate, reproduction rate, and starving rate.

$$X(t+1) = R X(t)(1 - X(t))$$

Here  $R$  is the only parameter expressing the dependence on the death rate, reproduction rate and starving rate, which determines the qualitative nature of the behaviour of the system. In fact for  $R < 1$  the death rate dominates the behaviour of the system, which evolves towards extinction from all the possible starting values of  $X$  ( $X = 0$  is therefore the ‘fixed point’ toward which the system does spontaneously evolve). For  $1 < R < 3.45$  a stable fixed point with  $X \neq 0$  emerges and the fixed point  $X = 0$  becomes unstable. For  $R \geq 3.45$  the system undergoes a *bifurcation*, that is, instead of a single fixed point it expresses two different fixed points for the dynamics, with a cyclic fluctuation of the population density. As  $R$  further increases more and more bifurcations take place, and for  $R \geq 4$  the system enters the chaotic regime. This is a classical way in which a transition from a non chaotic to a chaotic regime can take place and it is known as the *bifurcation route to chaos*. It is important to note that the manipulation shifting the system from a periodic to a chaotic regime is the fine tuning of the *parameter* of the equation:  $R$  is therefore the *control parameter* of the system.

In general terms, chaos is an erratic, (apparently) random behaviour yet it is the effect of a definite—deterministic—rule. There are two fundamental properties defining a system as chaotic. Firstly, the *sensitiveness to the initial conditions*—a principle better known as the *butterfly effect*. Let us imagine a system starting with a given initial condition, say condition  $\alpha$ . Let us now imagine introducing a slight modification ( $\epsilon$ ) to this condition, transforming it to  $\beta$ . A non chaotic system keeps the slight modification constant for a long time, so that also after an arbitrarily long period of time the difference between the trajectory starting in  $\alpha$  and the trajectory starting in  $\beta$  remain more or less  $\epsilon$ . This does not happen in a chaotic system. In this case, even if the initial modification  $\epsilon$  is slight, yet the two trajectories (the initial and the modified) can dramatically diverge.

In sum, a small change in the initial condition creates impressive consequences over time, like the motion of the butterfly’s wings in Cape Town that—after a while—can produce a tornado in New York. Getting back to the previous example, two different populations starting their evolution in time with very similar initial densities in the same environment could end up with a totally different final destiny if the environment parameters amount to an  $R \geq 4$ !

It is worth noticing that this property is responsible for the intrinsic unpredictability of the system over a long enough period, because even slight differences in the measurement of the initial condition—and no measure can be absolutely

precise—lead to truly huge variation of the trajectories. A second property of chaotic systems is the *density of the periodic orbit*. The trajectory of a chaotic system keeps itself within a circumscribed portion of the phase space (strange attractor). This means that the system does not assume all the possible infinite values represented by the infinite points of the phase space; rather it reduces its variability through time—for this reason, the chaotic behaviour is a case of dissipative system. Nevertheless, the chaotic system is not periodic: however wide the range of time assumed, the system will not present the same state twice. In geometrical terms, the system will never pass twice through the same point of the phase space. This means that however small is the sub-region of the phase space in which the orbit of the chaotic system is confined, one will find infinite points, each of them representing the state of the system in a generic instant  $t$ . The presence of strange attractors leads to the recognition that even if the chaotic behaviour seems random, actually it is the expression of a different, more complicated order. A chaotic trajectory shows a *quasi-periodic* course: it reproduces similar cyclic behaviour over the time, yet always different to a certain extent.

## ***Self-Organization***

The last type of dynamic system is the kind that maps processes of self-organization. Like the chaotic system, this kind of model concerns complex order as carried out by a non linear system. Yet, differently from the chaotic system, a self-organized system is characterized by a huge amount of microelements—i.e., the neurons of a neural network of the Hopfield type, (Hopfield, 1986)—that can function either in a deterministic (noiseless case) or in a stochastic (noisy case) way. This kind of system is usually defined by assigning the transition function for each microelement (i.e., the updating rule determining for example that a neuron will fire when the weighted sum of the signals it receives from its neighbors passes a given activation threshold) on the basis of a theoretical description informed by the modeling of a physical or a biological system.

A crucial feature is that the microelements are constantly interacting with each other, and the law expressing the strength of the interaction is probabilistic in nature (Amit, 1989). These kinds of models focus on the description of the modality and the condition under which an emergence of order is achieved through—and by means of—the interaction of the micro-elements. For example in the Hopfield model (Hopfield, 1986) a network of many stochastic neurons exhibits stable states that are highly correlated with a set of patterns stored in memory. It is therefore possible to employ the model in order to simulate a content addressable associative memory. In this system a given pattern of memory (take for example, the representation that is formed once you are introduced to a colleague in an international meeting) is stored by enhancing the synaptic connections between the neurons that are activated during the first exposition to the stimulus. Once the system is presented with a corrupted or in some way altered version of the stimulus (i.e., you meet your

colleague again a few years later, in a different context and he looks older), the network dynamics is able to retrieve the original stored pattern, thus allowing the experience of recognition (maybe in the form of a kind of ‘AH-HA!’ experience). This type of memory system is said to be a content addressable memory because the cue that is needed in retrieval is a part of the content of the memory itself, in contrast with A.I. systems in which the actual location where the information is stored has to be specified in order to recall the information.

As an example of application consider the model described by Lauro-Grotto, Reich, and Virasoro (1997). In this model several networks of the Hopfield type are connected in order to simulate a multimodular semantic network. Each module represents a set of possible connotations of a given concept, i.e., its sensorial appearance (visual module, tactile module...), the way in which it can be employed (functional module), the name that designates it in its written and spoken form (verbal module) and so on. The constraint of the dynamics of the multimodular network can be explored both analytically and by simulations, and predictions can be made on the behavior of the system in the presence of neural damage. The behavior of the damaged model appears to be highly reminiscent of the behavior of patients suffering from semantic dementia, a neuropsychological deficit characterized by neural loss in the mediotemporal lobes.

Another example of this modelistic approach is the synergetic theory (Haken, 1992). Synergetics focuses on systems constituted by a very high number of microscopic components functioning in a stochastic way—i.e., the molecules of a fluid. Under specific conditions—depicted in terms of given values on one or more control parameter(s)—the behaviour of the micro-components starts to follow a common rule: an *order parameter* emerges in the dynamics of the system. This is a global variable that sensitively describes the dynamic behaviour of the system. For example in the case of the Hopfield network the order parameters are global variables that estimate the overlap or superimposition of network states and memorized patterns (the overlap being equal to 1 when the network state is perfectly reproducing one of the memorized patterns). All states corresponding to the retrieval of a given memory are characterized by the fact that they have a single overlap close to 1 while the others stay close to zero. At equilibrium the single neurons in the network can show fluctuations in their activation states, yet the fluctuations appear to be balanced across the system, so that the neurons altogether do co-operate in keeping the overlap values stable. According to the terminology of the theory, in cases of this kind, the micro-components enslave themselves to the order parameter. In so doing, a coherent pattern emerges as a global property characterizing the system as a whole. A typical example of a dynamic system exhibiting an order parameter in the physical domain is the laser: below given values of the control parameter, the photons stop their stochastic behaviour and enslave themselves to a common rule that transform them into a single mechanism with specific properties of order.

The crucial property of these types of dynamic systems is *universality*: the emergent behaviour appears to be independent from the actual form of the dynamics of the interacting elements provided that (1) the non linearity of the dynamics is taken for granted and (2) a sufficiently large amount of elements are put in interaction

(Mezard, Parisi, & Virasoro, 1987) This implies, for example, that the collective behaviour of a neural network of this type will be more or less the same if the neuron activation dynamics is changed from a sigmoid to a step function (both are non linear functions), provided that a large amount of neurons are placed in interaction. “‘More’ is different!” intones the theoretical physicist P. Anderson in the famous manifesto about Complex Systems (Anderson, 1972).

## **The Dynamic Nature of Psychological Phenomena**

Let us look at typical phenomena of the psychodynamic domain, whose modalities of working make it clear that there is the need to develop more sophisticated models of investigation than the traditional ones that entails a linear and stationary idea of the psychological phenomena.

### ***Periodicity***

First of all, psychodynamics highlights various examples of processes showing an intrinsically periodic trend. Maybe the best known of these examples is given by the bipolar disorder. This psychopathological syndrome is indeed characterized by the alternation of a phase of depressive and a phase of the maniacal state (DSM IV-R). These two conditions are dramatically opposed to each other, and in many cases are presented according to a regular cyclic period, regardless of the environmental variability. The evidence of such regularity is one of the main issues leading the majority of the clinic researchers to give a relevant rule to neurobiological determinants, even if no conclusive evidence has been provided in order to understand the exact role played by the neurotransmitter system. One may or may not agree with the strong biological point of view, yet the systematicity of the cyclic way the syndrome appears is a fact that cannot but lead us to consider periodicity as a constitutive characteristic of the phenomenon in question.

However, it emerges that cyclicity plays a role in other psychological diseases. For instance, various authors highlight how a subgroup of subjects affected by narcissistic personality disorder is characterized by the alternation of moments of grandiousness and high self-esteem and moments of low self-esteem, feeling of incompetence and fragility (Dimaggio & Semerari, 2004).

### ***Periodicity in Psychotherapy***

Another domain in which periodicity seems to play a critical role is that of the processes shaping the psychotherapeutic field. Let us consider the discussion on the role

played by the therapeutic alliance in psychotherapy. This concept was introduced at the end of the 1970s in order to distinguish between transference reaction and competent participation of the patient in the clinical process (Bordin, 1979). There are different specific definitions of this concept; yet more or less all of them concern three issues:

- the quality of the interpersonal bond between patient and therapist;
- the patient agreement on the goal of the treatment;
- the patient commitment to the work entailed in the treatment.

An increasing number of studies have been using this concept since its introduction (Lambert & Barley, 2001; Martin, Garske, & David, 2000). The therapeutic alliance has thus acquired the status of the most widely recognized dimension of clinical effectiveness.

However, it is interesting to observe a shift in this literature. Initially, authors assumed a linear linkage between therapeutic alliance and clinical quality and/or effectiveness of the psychotherapy: the more intense the work alliance, the greater the effectiveness. In the last ten years this assumption has been brought into question, in favour of a vision that sees the therapeutic alliance as having a cyclic trend which alternates between the positive and negative poles. Thanks to the seminal contribution of Safran and Muran (2000) it has become clear that what is clinically significant is not the absolute trend of the alliance, but the capacity of the therapeutic dyad to systematically cooperate in order to repair the inevitably micro-ruptures of their bond. This means that the clinical process unfolds in terms of a cyclic process of ruptures and repairing, of reciprocal closeness and separation.

Moreover, both psychoanalytically and cognitively oriented authors have argued in favour of the cyclic trend of a clinically effective treatment. The psychoanalyst Bucci (1998) models the psychotherapy process according to the concept of Referential Activity that she elaborated within a comprehensive theory of the relationship between conscious and unconscious thought. Referential Activity is the function of the mind that, within the symbolic domain, grasps components of pre-symbolic thought. In other words, the referential function enables the subject to mentalize the emotions, by bringing them into language. And it is indeed in language that one can see the referential function in action: Bucci's method of psychotherapy process analysis focuses on the incidence, within the therapist and patient's discourse, of affectively charged words. The method is based on a software with various vocabularies, each of them measuring an aspect of the affective charge of a rich list of words—using the dimensions of concreteness vs abstractness, specificity vs generality; capacity or incapacity of emotional resonance—Bucci (1998) has shown that clinically significant sessions of the psychotherapy process present a cyclic pattern with phases of high referential activity alternating with phases characterized by low referential activity. This pattern is consistent with the author's psychoanalytically informed theory assuming the mind as working in terms of phases of retrieval of affects experienced and phases in which the mind elaborates them in terms of reflective thought.

A similar look at the psychotherapy process—entailing a more general vision of the mind's functioning as well, is provided by the Therapeutic Cycle Method of

Mergenthaler (1996, 1998) (TCM). TCM is a method aimed at identifying clinically relevant moments in the psychotherapeutic process through the analysis of emotional-cognitive regulation. TCM assumes that psychotherapeutic change is produced when the patient is adequately able to regulate and reflect on affective experience (for related concepts, see Horowitz, Kernberg, & Weinschel, 1993). TCM works by means of a software for statistical content analysis (CM software), that calculates the occurrences of two sets of words, identified as markers for emotional (EM) and abstract (AB) language respectively. The periodic non-random variation of the combinations of these parameters allows four emotion-abstraction patterns to be classified as:

- a) *relaxing*, when both ET and AB are low (both are below the mean): Patients talk about material that is not manifestly connected to their central symptoms or issues;
- b) *experiencing*, when ET is high (over the mean) and AB low: Patients find themselves in a state of emotional experiencing. Patients may be raising conflictual themes and experiencing them emotionally;
- c) *reflecting*, when ET is low and AB high: Patients reflect and discuss topics with a high amount of abstraction and without intervening emotions. This may also be an expression of the defense known as intellectualization;
- d) *connecting*, when both ET and AB are high: Patients have found emotional access to conflictive themes and they can reflect on them. This state marks a clinically important moment that often coincides with a moment of insight or possibly a moment of change.

These four emotion-abstraction patterns have been shown to allow for the identification of emotional-cognitive regulation, significantly related to the psychotherapeutic process (e.g., Fontao & Mergenthaler, 2007; Mergenthaler & Gelo, 2007). TCM considers *connecting* to be a marker of the ability to reflect upon emotional experience, that should therefore be understood—according to the theoretical approach one refers to—in terms of emotional insight (Fontao & Mergenthaler, 2007), meta-cognitive functioning (Semerari, Carcione, Dimaggio, Nicolò, & Procacci, 2007), or reflective functioning (Fonagy, Gergely, Jurist, & Target, 2002). Finally, TCM does not allow the four patterns to be interpreted independently from each other and in a linear way. Rather, a specific periodical temporal combination of these emotion-abstraction patterns is considered to identify one or more *therapeutic cycles*. A therapeutic cycle is conceived to detect clinically relevant moments of active therapeutic engagement Fig. 1.1 shows the ideal clinically relevant process. It begins with a *relaxing* phase, when the patient is not affected by the previous state of arousal and therefore is in the better condition to be engaged in the psychotherapeutic exchange. Then, the therapeutic context allows affective contents/state of the mind to be triggered and experienced by the patient (*experiencing*). Much of the therapeutic work is then directed at triggering and allowing a process of reflection upon the affective states experienced (*connecting*). If the patient is now able to activate his cognitive processes, it will be possible to create a meta-cognitive link between the affective states experienced and the cognitive understanding of them,



**Fig. 1.1** The ideal clinically relevant process as modelled by TCM

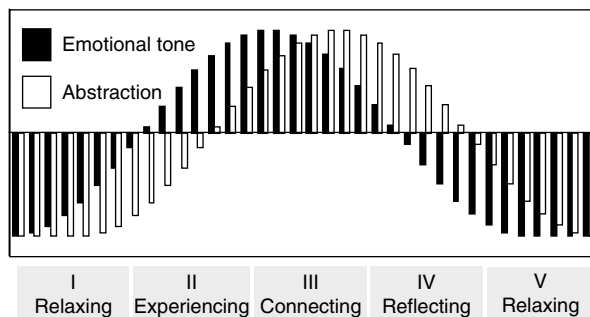

in so doing “filling up” the cognitive understanding with a deeper reference to its emotional content. This is considered to be a necessary prerequisite for therapeutic change. Finally, the emotional component diminishes, and it is now possible to reflect and cognitively elaborate what happened up to that moment, eventually creating a distance from the previously experienced affective states (*reflecting*).

According to the method, cycles can be considered a process-base mediator of outcome, having proven to enable the identification of clinically significant moments within the therapeutic process related to psychotherapy change (Kraemer, Lihl, & Mergenthaler, 2007; Lepper & Mergenthaler, 2005, 2007).

### *Non-Linearity*

A multiplicity of convergent perspectives leads to thinking that non linearity is the rule rather than the exception in psychodynamic matters. First of all, clinical processes often do not appear to be following continuous and constant trends. Despite the fact that clinicians usually tend to consider and empirically investigate clinical change as a linear and incremental process, there are a lot of clinical and empirical evidences leading such a traditional conception to be questioned. In a recent work, Hayes, Laurenceau, Feldman, Strauss, and Cardaciotto (2007) list some of these issues. Various studies have documented that only in some cases does the life trajectory following very dramatic and traumatic events evolve coherently with the local effect of the trauma, that is in terms of the onset of pathological conditions (so called Post-traumatic Stress Disorders). In various cases people are shown to be able to regain their pre-trauma condition. In further cases the traumatic event is shown to be the premise and the means for reaching an even better psychological condition (the so called Post-Traumatic Growth). Other studies have shown that people with clinical problems—e.g. with problems of substance abuse—can carry out deep change in their condition, as result of a sudden, rapid and global transition. Moreover, this kind of change is often preceded by periods of worsening of the clinical condition. Other clinicians have highlighted how the clinical improvement can follow a threshold mechanism, as a consequence of the accumulation of a set of

eliciting conditions, yet none of them enables one to be singularly effective. Finally, many studies on psychotherapy process-outcome show that the clinical improvement—often measured in terms of level of the symptomatology—does not spread homogeneously throughout the course of the clinical treatment. Rather, at least in good outcome cases, most of the outcome occurs in an early phase, with the following course presenting a lower rate of improvement (Lambert, 2004).

Second, in many cases the development of aspects having clinical relevance shows regular, but not linear, trends. Barkham, Stiles, and Shapiro (1993) have introduced the parameter of curvilinearity, concerning the rate of change in important clinical problems occurring during the course of psychotherapy. They did so in order to take into account what clinicians know very well: progress in psychotherapy is never constant; it may in fact show sudden accelerations or blocks. Authors have used a quadratic curve in order to model the curvilinearity, according to a hypothesis of a U-shaped clinical trend. Their findings clearly supported their hypothesis. However, they underline that other kinds of curves (cubic or of higher order) could also be used. Recently, some of us, working with other authors, have proposed and successfully tested a similar approach to the psychotherapy process (Salvatore, Gelo, Gennaro, Manzo, & Al-Radaideh, *in press*), called *Two Stage Semiotic Model* (TSSM). The TSSM asserts that good-outcome psychotherapy is characterized by a U-shaped trend of the super-ordinate meanings working as semiotic organizers of the discursive exchange between the patient and the therapist (cf. Fig. 1.2).

According to the TSSM, the psychotherapy process can be depicted as a two-phase course. In the first stage the patient-therapist exchange works fundamentally as an external source of limitation on the patient's system of assumptions, whereas in the second stage the patient-therapist dialogue works in support of the patient's activity of creating new meanings. Therefore, in the first stage, the therapeutic dialogue operates fundamentally in a de-constructive way, placing constraints on the regulative activity of the patient's expected super order meanings (Salvatore & Valsiner, 2006). In the second—constructive—stage, the patient-therapist dialogue

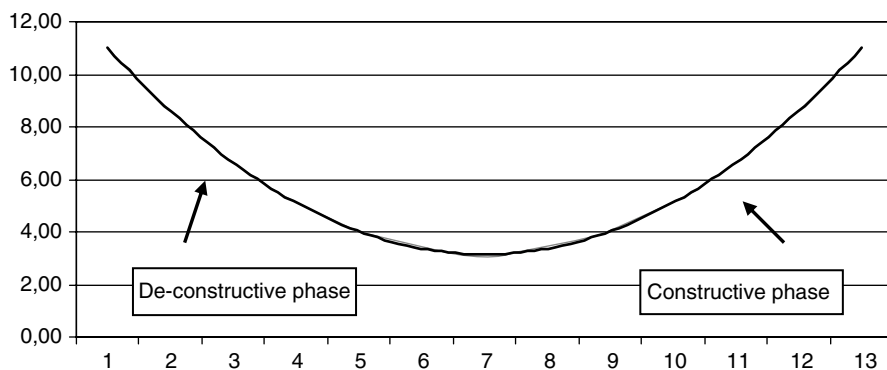

**Fig. 1.2** U-shaped trend of super-ordinate meanings working as semiotic organizers of patient—therapist discursive exchange

implements new super order meanings, replacing the previous ones in regulating the meaning-making experience.

Obviously, the two stages are not totally distinct and mutually exclusive. Both of them can be active throughout the whole psychotherapy process, within every session, though to different extents. However, TSSM asserts that at the macro-analytical level, in a clinically efficacious process one can differentiate the psychotherapy process into a first phase where de-constructive meaning-making is dominant and a second one where the dynamic of meaning-making acquires a constructive function. What is worth noticing here is the fact that this kind of study allows us to underline that clinical development does not have a constant trend—one where the composition effect principle is valid. Yet this does not necessarily entail a lack of regularity; instead, it points to a more complex, non linear regularity, to be described with a function of an order higher than one (empirical evidence concerning the TSSM assumption is presented in Salvatore and colleagues, this volume).

### *Chaotic Order*

Periodicity and non linearity are characteristics of the clinical phenomena that are very close to the experience of the researcher and professionals in the field. Moreover, the study of individual trajectories plays a central role in the cultural and methodological background of the clinical and psychodynamic disciplines. For this reason, it is easy to retrieve empirical investigations that—like the ones we referred to in the previous session—are consistent with such a standpoint. The task becomes harder in the case of deterministic chaos. As matter of fact, despite the interest shown by some researchers for this kind of dynamic processes,<sup>7</sup> very few empirical studies take into account and/or use chaos theory (Hayes et al., 2007).

### **Psychotherapy as a Chaotic Process**

Schiepek and colleagues provided the only empirical investigation of the psychotherapy process based on chaos theory (Kowalik, Schiepek, Kumpf, Roberts, & Elbert, 1997; Schiepek, Kiwalik, Schutz, & Kohler, 1997). They submitted 13 sessions of a psychotherapy case to a multi-stage analysis. First, the authors coded the psychotherapy by means of a qualitative coding system (the Sequential Plan Analysis) aimed at identifying the interactional strategy of both the client and the therapist. According to this

---

<sup>7</sup> “Chaos theory’s image of patterned complexity offers a far better picture theory (...) to guide our research efforts than does experimental design’s billiard ball determinism image of direct and linear causality. An alternative to experimental studies in psychotherapy is a research approach which recognizes the complexity of the psychotherapeutic process and attempts to analyze the complex unfolding of moment by moment performance of people in specific states and contexts” (Greenberg, 1991, p. 8).

method, more than 3400 ten-second segments of a psychotherapy session were coded into seven super-ordinate categories that refer to the therapist's and the client-therapist strategy of interaction such as "trust/create secure atmosphere"; "confrontation/search for insecurities" (by the therapist) and "search for sympathy/appreciation/good relationship" and "problem oriented work" (by the client). Authors interpret such categories as general plans of "self-presentation ... reflecting the strategic purposes and emotional schemata of the client or therapist" (Kowalik et al., 1997, p. 198).

For our purposes here, we need to examine the anatomy of the Kowalik et al. (1997) study. They had independent judges to attribute the intensity of each category to each of the 10 s units. As a result, seven parallel time series of data were obtained, representing the data base for the further analysis aimed at verifying the hypothesis of the chaotic behaviour of the psychotherapy process. As a starting point, the authors start with the assumption (cf. Schiepek et al., 1997) that the psychotherapy process can be modelled as a stationary (ergodic) non linear system—that is as a system whose dynamic state does not change through the time. On the basis of this assumption, they provide three different kinds of tests. Firstly they verify the deterministic nature of the time series, that is the possibility to interpret it as being different from noise. In order to do so, they apply a series of analyses based on the logic of the component analysis (Fourier transformation and Autocorrelation Function) as well as a measure informed by the topological analysis of the reconstructed phase space in which the time series are embedded (intuitively speaking, the phase space's axis is provided by specific temporal lags). They compare the output characterizing the time series with that produced by a noise trajectory and that produced by an already recognized chaotic system. The psychotherapy process shows a pattern similar to the latter and different from the former, and this leads the authors to conclude that the time series present the characteristic of a deterministic trend.

Secondly, in order to verify the presence of a chaotic attractor they measure its dimensionality, in search of a fractal dimensionality, which is a defining property of chaos. However, contrary to expectations, the results do not fit with the hypothesis of the presence of a strange attractor. The authors explain this unexpected result as a consequence of the low amount of data and/or of the high dimensionality of the time series, that is of the huge number of variables needed to explain their variability.

The variability of the stationary measures estimated in this study can be seen as an indication of the non-stationary character of the interaction between client and therapist. In addition, we may question the methodological suitability of the stationary dimensionality measures for the application to behavioural data, i.e., coarsegrained and relatively short time series (including only some hundred or thousand data points). (Schiepek et al., 1997, p. 184).

Third, they calculate the Largest Lyapunov Exponent (LLE) specifically aimed at verifying the salience of the sensitive dependence on the initial conditions. The LLE measures the maximum divergence—through time—between the time series trajectory on the phase space and another given trajectory produced by a slight perturbation of the original trajectory. If the parameter surpasses a certain threshold, this is interpreted as the reflection of the fact that the slight perturbation has produced a wide differentiation in the temporal evolution of the system. Findings support the hypothesis of a sensitive dependence.

The authors underline that taking the results of the first study (Kowalik et al., 1997) as a whole, even if they highlight cues of deterministic chaos, nevertheless they lead one to think that the time series analyzed are not consistent with the initial ergodic/stationarity assumption. According to this consideration, they developed a second stage of analysis in a further study (Schiepek et al., 1997), which was based on nonstationary measures: entropy rates and an adjusted version of the dimensionality test and of the LEE (local LEE). The findings of this second study support the hypothesis that the psychotherapy process not only presents a chaotic dynamics, but also a dynamics showing critical transition within and between the sessions.

Interestingly, the authors emphasize that these transitions have to be viewed only in analogy with the mathematical concept of *phase transition*. As matter of fact, the latter entails a change of the control parameter of the system—which is an environmental condition, external to the psychotherapy process. Such condition is evidently not included in the study in the case of psychotherapy.

The sudden chaoticity jumps we observed are not transitions in the sense of real “phase transitions,” as this would require a change of at least one control parameter. In order to observe such changes, experimental manipulation of the control parameters would be necessary, which has not been realized.

In general, the analogy between experimental and therapeutic process is applicable to a very limited extent, because the important sources for change during therapy arise from the client and the client-therapist relationship and not from outside.

The therapist is part of the therapeutic system and not an externally controlling source of an independent variable. Theoretically it is not yet clear what might be a suitable control parameter for therapeutic phase transitions. A possible candidate might be the client’s motivation for change, though this is not an environmental parameter like the energy input for the laser or the temperature gradient (...) but a parameter inherent in the process (Kowalik et al. 1997, p. 212).

This is a very significant point, highlighting a possible weakness in using chaos theory in the case of psychological phenomena (at least when depicted at the behavioural level).

### ***Sensitive Dependence on the Initial Conditions***

Apart from the above-mentioned study, we found no other example of empirical investigation of psychodynamic phenomena according to chaos theory. We therefore have to keep our discussion on a qualitative and analogical level, with the aim of offering some “hints of chaos” that could legitimate those who intend to bet on the validity (and heuristic utility) of modelling psychodynamic phenomena according to chaos theory.

Let us start with the principle of the *sensitive dependence on the initial conditions*. As already mentioned, this is a central characteristic of chaotic behaviour to the extent that among non specialists, chaotic behaviour often tends to be solely identified by this feature. The validity of this principle in the case of psychological phenomena is a critical issue. As a matter of fact, the sensitiveness seems to be the

opposite of equifinality, which is a central quality of psychological development (Sato, 2009). A psychodynamically oriented clinician should actually be quite in agreement with the assertion that the processes of affective intersubjective sense-making show ways of functioning that can easily be described as forms of sensitiveness to the initial conditions.

More particularly, the psychoanalytic literature collects a huge repertoire of vignettes from psychotherapy (e.g., Hoffman, 1998) which, in one way or another, highlight how patient and therapist continuously co-construct the affective sense of their encounter and how this affective semiotic co-construction is strongly depending on and carried out by means of nuances: the tone of the voice, the variability of speech speed, slight movements of the body, the angle of the glance, as well as the words used, the content choice... One who has psychodynamic clinical experience has no difficulty understanding what many clinical sketches suggest, that is, that very trivial incidental and casual details—e.g., the circumstance of the therapist arriving a little late, the words he uses to welcome the patient ...can have a very deep middle to long term impact on the course of the clinical process.

### ***Empirical Traces of Sensitive Dependence on the Initial Condition***

Venuleo, Salvatore, Mossi, Grassi, and Ruggeri (2008) analysed the discursive exchange occurring in high school teaching, between students and teacher. According to the point we would like to make here, this analysis shows how the affective intersubjective regulation of the participants' reciprocal positioning is carried out by means of subtle discursive devices (e.g., see the use of words like “guys”, “want” “somebody” in a sentence like this: “Well, guys, now I want to examine somebody”, as compared with a sentence like: “Well, students, we must have a test now”). This fine tuning is very hard to recognize in real time, but at the same very meaningful in creating the emotional sense of the social bond (Salvatore & Venuleo, 2009).

Salvatore, Quarta, and Ruggeri (in press) compare the effects of playing with violent videogames on the experience of aggressive feeling (measured by means of self reports in a sample of 14- to 18-year-old boys and girls). The subjects are distinguished according to two dimensions: the cultural value attributed to the videogames (a videogame eliciting a form of valorised violence—a policemen fighting against criminals in order to defend himself—versus an illicit form of violence—a criminal shooting people with intent to steal), and the situated social meaning of the activity of which playing is part (playing as a way of participating in an interpersonal frame—a competition—versus playing alone, as an individual activity). The results show that the effect of playing with a violent videogame is not invariant. Rather it varies according to the cultural and social meaning attributed to the playing. More particularly, the participants playing the illicit videogame alone show the lowest level of aggressive response. The participants playing the valorised videogame alone show the highest level of aggressiveness: the users playing interpersonally, whether it be the illicit or valorised videogame, present intermediate levels

of aggressive response. As far as the present discussion is concerned, these results show how a difference in the background of the experience (and individual or interpersonal background) has a significant role in shaping the psychological effect of the experience itself. In the final analysis, this finding highlights how the semiotic mediational role played by the context of the experience can be conceptualized as one way sensitiveness to the initial condition manifests itself in the realm of psychological phenomena.

### ***The Dissipative Trajectory***

A psychodynamic approach to language focuses on the constructive role affects play in language (Salvatore & Venuleo, 2008). In agreement with various socio-constructivist points of view (e.g., Rommetveit, 1992; Valsiner, 2007) this approach underlines that the signs are intrinsically polysemic (Mossi & Salvatore, [in press](#)). According to Wittgenstein (1958), the reciprocal attunement among people involved in a communicational exchange cannot therefore be considered a natural given premise grounded on some kind of universal clearness and completeness of the language—but it should be seen as a by-product of the communicational exchange itself (Salvatore, Tebaldi, & Poti, 2009). In the final analysis, this means that signs reduce their polysemy by means of the communication flow in which they are implemented.

This way of considering discourse dynamics suggests the possibility/utility of regarding sense-making as a dissipative system—that is, as a process characterized by the presence of a strange attractor. We remember here that a strange attractor is a region of the phase space in which the trajectory of the system is confined. This means that the system loses most of the freedom of assuming the potentially infinite number of states theoretically available (represented by the point of the phase space outside the strange attractor). Yet, at the same time, a strange attractor is such because the temporal trajectory of the system always occupies a different point, never passing twice through the same point (see above, the concept of density of the orbit). Therefore, even if the strange attractor represents a constraint upon the infinite variability of the behaviour of the system, it is however an infinite set of states of the system: the system always has a new state, at the same time quite similar to the previous and to the subsequent ones.

### ***Sensemaking and Strange Attractor***

The observation made above seems to fit the case of the dynamic model of sense-making that we referred to before. From this point of view the analogy with the strange attractor helps to understand more clearly how—by means of and through its very performance—sensemaking can reduce its polysemy, while keeping its

nature of infinite semiosis (Eco, 1976) always necessarily producing new patterns of meaning. Let us look at this point in greater depth. Firstly we notice how the ongoing communication is regulated by and, at the same time, reproduces a generalized super-order meaning. Such a generalized super-order meaning works as the frame of sense of the intersubjective sensemaking, suggesting the production of signs and their interpretation (Salvatore & Venuleo, 2008). Thus, for example, the moral value attributed to my action works as the frame of sense regulating the way I will speak of the effects of my conduct and the way others will interpret my speech (i.e., if my interlocutor and I are within the frame defining my action as a right, highly valuable action, the underlining of its gratuity will be performed by me as a way of projecting the value on my identity—I do the right thing not because I am forced to do it, but because I am right).

Yet the recognition of the regulating role played by the frame of sense entails a potential paradox. On the one hand, the frame of sense cannot be seen as a fixed semiotic entity—a la cognitive psychology mode, established once and for all. If this were so, there could be nothing new: people would be forced to always use and interpret signs in the same way, and therefore instead of infinite semiosis we would only have an endless repetition of the given meaning. And it is clear that such a scenario is very far from reality, where signs mostly work as an open field of signification (Valsiner, 2007) whose interaction makes it possible to pursue ever new paths of sensemaking. On the other hand, seeing the frame of sense as changing with time means that it no longer works as a super-order frame, that is, as the anchor field according to which the signs are interpreted. In other words, if sign **a** has acquired its meaning according to its position in a frame X that can be subjected to unconstrained changes, then sign **a** would be absolutely polysemic—in the final analysis, uninterpretable. This would be because it could assume infinite positions, as many as the infinite possibilities for changes of the frame. And this eventuality is clearly far from the reality of communication, where as well as being able to create novelty, people are at the same time able to share to a certain extent the meaning of the sign.

From a general theoretical viewpoint, the issue highlighted above leads us to conceptualize sense-making as a complex hierarchical system that is however characterized by reciprocal feed-forward linkages between levels, at the same time working as a constraint on the others (Valsiner, 2007). However, the point at stake here is that however one wants to conceptualize the micro-process of sensemaking, we have to recognize that it must be variable and invariable at the same time, in movement and static. The reference to the notion of strange attractor comes to our aid, allowing us to deal with what could be an impossible conceptual task. As we have underlined, a strange attractor describes a dynamic system, by definition having a different state in each instant. At the same time, a strange attractor is a constrained region of the phase space, therefore from this point of view it describes a system that—on a different scale of observation—does not change its state.

To restate this in more formal terms, let us think of an arbitrary long discursive exchange between two or more people. Imagine we are able to map the temporal



evolution of the meaning on a phase space with  $n$  dimensions, each of them depicting a significant characteristic of the meaning in a given instant  $t$ . Therefore, each point  $x$  of the space represents one of the infinite possible states of meaning in a given instant, as depicted by the corresponding  $n$  coordinate of  $x$ . A high polysemic process will be represented by an orbit occupying a wide area of the space. As the sensemaking reduces its polysemy, the trajectory mapping it will confine itself within a narrow region of the space. Yet, according to the infinite nature of semiosis, the meaning is never equal to itself through time. Therefore, even in the sub-region in which is confined, it always draws new trajectories. This means that it is working according to a strange attractor (one can find connections between this conceptualization of sensemaking in terms of strange attractor and the notion of Trajectory Equifinality Model, TEM, Sato et al., 2007, Sato et al., this volume).

### *An Empirical Depiction of Communication as a Dissipative System*

Some of the authors of the present article have recently carried out a study based on a quantitative analysis of the communication exchange performed in a 124-session psychotherapy process (Gennaro, Salvatore, Lis, & Salcuni, 2008) which offers an empirical illustration of the dissipative nature of the intersubjective exchange.<sup>8</sup>

The study assumes the lexical variability—that is the way words are distributed through the sentences and then combined with each other—as the operative definition of the meaning (Lancia, [in press](#)). According to this methodological approach, the meaning can be depicted as the way signs combine with each other—that is, the meaning can be empirically described in terms of the patterns of word co-occurrences within the same time unit/piece of discourse. For instance, if the words  $m$ ,  $n$ ,  $o$  tend to be present together through the discursive exchange, then this co-occurrence is the reflex—therefore the index—of a given meaning being expressed. On the grounds of these methodological assumptions, a text can be transformed into a digital matrix with each utterance as a row and each type of word present in the text as a column. The binary content of the cell  $ij$ -th (0/1) indicates the absence/presence of the word  $j$  in the utterance  $i$ . Then the matrix is subjected to a Multiple Correspondence Analysis (LMCA), whose output is a matrix of factorial coordinates.

It is worth noticing that each factor numerically describes a specific piece of the lexical variability; in other words, a pattern of co-occurrence of words/signs within the utterance. More precisely, each factor is shaped in a dichotomic way: as an opposition between two patterns of co-occurrence. This means that when certain words tend to co-occur, then another cluster of words tend to be absent. Moreover, each factor is associated to a different degree with each utterance, according to how the opposition between the two contrasting clusters characterises the utterance.

---

<sup>8</sup> Details are described in Salvatore, Tebaldi, and Poti (2009), the study from which the investigation in question is a further development.

**Table 1.1** An ideal example of a phase space describing the dynamics of meaning through time

Utterance	Factorial dimension a	Factorial dimension b	Factorial dimension c	Factorial dimension d
1	-0.001	2.001	-1.897	0.000
2	0.002	2.123	-2.101	0.001
3	-1.456	0.003	0.002	-1.344
4	-1.902	0.004	0.000	-1.999
5	-2.190	-0.089	0.102	-2.890

According to these statistical properties, each factor can be seen as: (a) a micro-component of the meaning—corresponding to a given pattern of oppositional association between words—that (b) qualifies each utterance to a certain extent. In other words, each row/utterance can be seen as the state of the meaning in a given portion of time (the time required to produce the utterance in question). This state is described by the row vector given by the values of all the factorial dimensions associated with that utterance. In conclusion, this means that the factorial matrix can be considered as the numerical representation of the phase space of the evolution of the meaning through the communicational exchange.

Table 1.1 shows an ideal example of a factorial matrix, with 5 utterances and 4 columns/factorial dimensions. As one can see, the first and second utterances are connoted mainly by the positive polarity of the micro-component of meaning b and the negative polarity of the component c; then a shift occurs, and the trajectory of the meaning moves toward a state—corresponding to utterances 3 and 4—characterized by the salience of the negative polarity of the micro-component a and d.

The study applied this methodology on the transcript of the communicational flow between patient and therapist of a good-outcome 124-session\4-year psychotherapy process. The factorial matrix obtained by the analysis presented more than 10.000 rows/utterances and 498 columns/factorial dimensions. More particularly, the analysis focuses on the association between singular micro-components. For this purpose, by means of further statistical transformations,<sup>9</sup> an index was calculated depicting the association between each main factorial dimension (those showing a higher level of lexical variability) and 14 blocks of psychotherapy sessions. The higher the index, the more the micro-component of meaning characterizes the communicational exchange carried out within the block of sessions. Figure 1.3 plots the trajectory of the relationship between two selected micro-components of meaning through the 14 sessions. Each point represents a given block. Each of the two coordinates represents the values of the association

<sup>9</sup> Firstly, the factorial matrix were segmented according to the 14 blocks of sessions. Secondly, each submatrix was subjected to a factorial analysis. In this way 14 second order factorial matrixes were obtained. Each of them had the first order factorial dimension as a row and the second order factors as a column. This means that the second order factors can be interpreted as the association between first order factors. Finally, each row-vector depicting a given first factorial dimension was transformed into a single value, through the computation of the Euclidean distance of the corresponding point on the phase space defined by the second order factors.

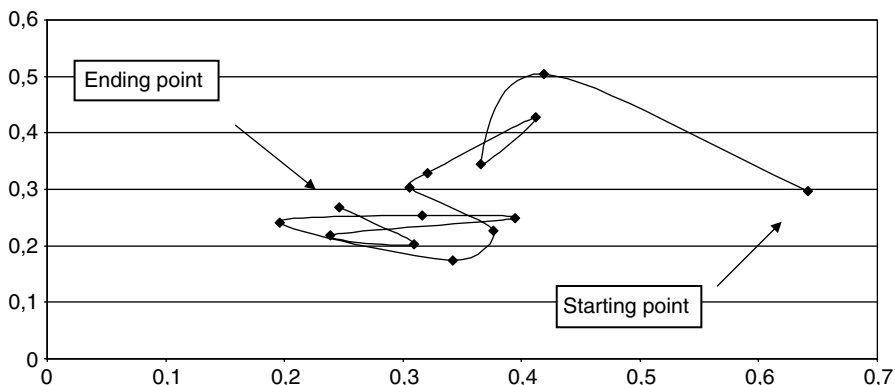

**Fig. 1.3** The temporal trajectory of the association between two micro-components of sensemaking in psychotherapy communication

between one micro-component and the block. As one can see, throughout the time, the trajectory tends to confine itself to a sub-region of the phase space, the marker of the dissipative dynamics.

### Self-Organizational Dynamics

Dissipative dynamics can be, but is not necessarily, associated with phenomena of self-organization, that is with the sudden formation of patterns reducing the variability of the behaviour of the system microelements—in the final analysis with the emergence of structures of order at the macroscopic level. In cases like these the dissipative dynamic can be seen as the reflection, at the macroscopic level, of the reduction in variability of the microelements’ behaviour.

### *Evidence of Self-Organization in Psychological Processes*

Tschacher, Schiepek, and Brummer (1992) focused on the phenomena of emergence in clinical psychology, referring to the synergetic as a conceptual framework and mathematical device for modelling self-organizational dynamics. The various contributors collected in the volume highlight how a wide range of clinical phenomena (the course of specific psychopathological conditions, the trends of symptomatology, the psychotherapy process) as well as other psychological aspects (cognition, perception, social and marital interaction) are characterized by processes of self-organization—that is of emergence of macroscopic order as a result of the enslaving of the microelements’ behaviour.

Each of the previous examples shows that the non linear processes and phenomena of self-organization occur everywhere within the traditional areas of clinical psychology research and practice. In order to gain an understanding of the dynamic of evolution of such systems, theories of non linear systems and especially synergetic conceptualizations will be necessary in the future. It should be clear by now that the synergetic approach to phenomena treated by clinical psychology neither leads to physicalist reductionism nor means mere metaphorical thinking. (Schiepek, Tschacher, & Kaimel, 1992).

Working within the framework of the synergetic perspective, in a recent work Tschacher, Scheier, and Grawe (1998) (cf. also Ramseyer & Tschacher, 2006; Tschacher, Ramseyer, & Grawe, 2007) have modelled the non verbal communication between patient and therapist (concerning a good outcome psychotherapy) as a self-organizing dynamics characterized by the emergence of a synchronization of the two participants' movements. If one considers the infinite source of body movement as the microelements of the system, the synchronization can be seen as the macroscopic reflex of the enslaving of the microelements to an order parameter. From a complementary point of view, synchronization can be modelled as a reduction of the phase space dimensionality, in other words as a constraint on the possible infinite combinations of the behaviour of the microelements (in this case: changes in body position).

Interestingly, a very similar result is found by Salvatore et al. (2009) in their analysis of the verbal interaction between therapist and patient (see above for details). The study assumes that sense-making is a self-organizing system with the meaning emerging from within rather than introduced by outside. From the authors' theoretical standpoint, meaning can be seen as the constraints that the communication produces on the virtually infinite possibilities of combination of signs. According to this general assumption, at the very first moment ( $t_0$ ) the communication between therapist and patient can be seen as a system with the maximum extent of entropy, that is characterized by the absence of any constraint on the freedom of signs to combine with each other. This condition is equivalent to saying that in the instant  $t_0$  patient and therapist do not share any system of meaning and therefore are in a condition of perfect reciprocal strangeness, that is of maximum communicational uncertainty. Obviously this is a theoretical model: even in the first moments of their encounter patient and therapist have some shared symbolic background, simply because they are part of a cultural environment. Nevertheless, the development of the therapeutic dyad is one of the social phenomena that more than any other approximates the theoretical model of perfect strangeness.

Moreover, it is a form of social interaction whose development from the beginning can be easily described, in this case by recording the verbal communication. This makes it a good candidate for studying the sociogenesis of meaning. According to the authors' central hypothesis, in the first moments of the interaction between patient and therapist a system of shared meaning suddenly starts to work as the symbolic framework—what the authors call “frame of sense”—regulating the further communication—and once functioning, it goes on for all the rest of the time. This phenomenon can be viewed as a dynamic of emergence—and therefore the

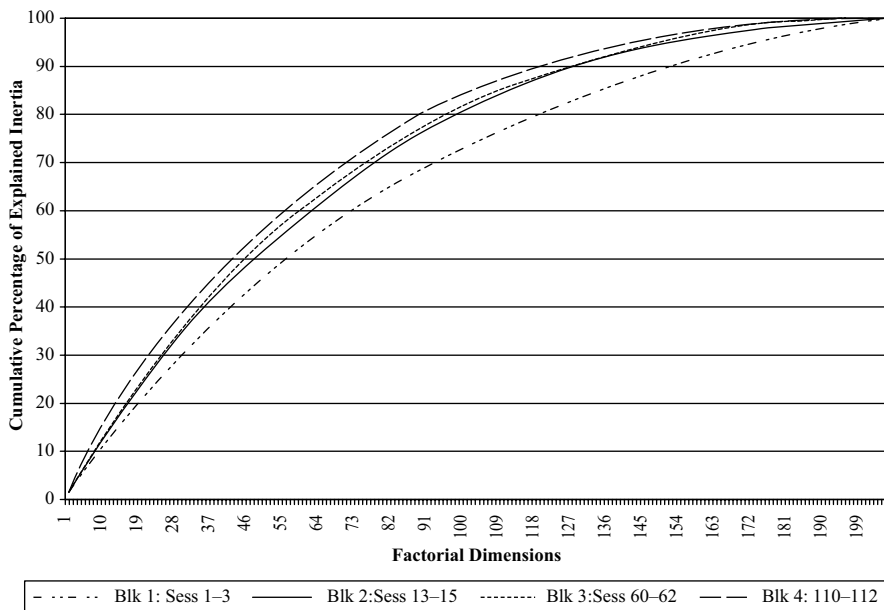

**Fig. 1.4** Cumulative percentage explained by the factorial dimension extracted by the 4 LMCA

communication has to be seen as a self-organizational system—because it is not the product of a specific agreement between the participants (which would entail the subjects importing ready-made meaning from outside); rather, it happens from within the system, as a consequence of its functioning.

In order to empirically depict this emergence dynamic, the authors analysed the transcripts of a 124-session psychotherapy process. More particularly, they performed 4 Lexical Multiple Correspondence Analyses (LMCAs), each of them applied to the subset of the whole matrix sentences x words corresponding to a segment of the whole text, therefore to a temporal window of the psychotherapy.<sup>10</sup> This study is based on the same methodological approach and data set as that in Gennaro et al. (2008). However, unlike the former, the latter does not deal with the trajectory of the state of the system through time; rather, it focuses on the phase space dimensionality produced by the Multiple Correspondence Analysis.

For this purpose the authors calculated the distribution of inertia associated to the factorial components. As Fig. 1.4 shows, after the initial sessions (Blk 1) the phase space reduces its dimensionality. In other words, the lexical variability explained (inertia) tends to be concentrated on the first hundred factorial dimensions. This means that, for instance, in comparison with the first LCMA, the other 3 LCMAs (concerning block 2, 3, 4) need a lower number of factorial dimensions to explain

<sup>10</sup> A first block corresponds to the initial phase of the psychotherapy (sessions 1–3), a second block corresponds to an early phase (session 13–15), then a middle block (sessions 60–62) and an almost final block (sessions 110–112).

89% of the inertia. Moreover, it is worth noticing that the reduction of the dimensionality does not follow an incremental course. Rather, it seems more like a single jump that happens just once (between block 1 and block 2)—and then remains constant across blocks 2, 3, and 4.

The authors interpret this finding as evidence consistent with the hypothesis of the emergent behaviour of sensemaking dynamics. As matter of fact, in the final analysis the reduction of the phase space dimensionality means that after a while a constraint on the possibility of sign combination emerges in the dialogue. Once this happens, each sign loses some degree of freedom, being allowed to associate itself only with a subset of the other signs. In other words, after the first moment of discursive interaction, the communication places constraints on the possibility of combination among words, preventing some combinations, making others other improbable, and others more frequent. On a macroscopic level, this means the emergence of an order parameter that on the interpretative level can be seen as a frame of sense regulating the discursive exchange.

It is worth noticing that this phenomenon of emergence of a structure of order seems to be specific to interpersonal exchange. In fact, the study compares the verbatim transcription of the psychotherapy process with the text of a novel. In the latter case, the phase space dimensionality increases—rather than decreasing—after the first moment, to remain constant in the rest of the text. The authors interpreted this finding by highlighting that while in the case of interaction among people the participants can create a shared frame of sense by means of their dialogue, an already shared system of meaning between writer and reader is required in order to make the novel readable. Once the text is approachable, it can work as a source of novelty, allowing for multiple paths of making meaning—therefore creating an increase in semiotic variability.

## Conclusion

In this chapter we have tried to show that psychological phenomena are to be seen as dynamic processes, because of their intrinsically temporal and developmental nature. The Mathematical Theory of Dynamic Systems can therefore be a source of useful approaches and tools enabling psychological theory to go beyond the reductive static conceptualization of its objects. In actual fact, the use of models coming from Dynamic System Theory (DS) has been spreading widely in various psychological fields (cognitive psychology, neurosciences, social psychology). In spite of its name, and more importantly, in spite of the characteristics of the phenomena it deals with, psychodynamics has left little room for this perspective. This is particularly true in the modeling of the inter-subjective processes of sensemaking. In our opinion, this results in the failure to grasp a major opportunity for development in the field.

It seems to us that two points are worth underlining in our discussion. Firstly, the dynamicity of the psychological process is not homogeneous. In fact, dynamicity has to be seen as a set of different concepts, within which an even larger

number of specific models can be encountered. We have highlighted the fact that psychological processes are suited to a conceptualization according to different aspect/properties of the dynamic theory, which in turn is merely a single conceptual system. More particularly, we focused on four different types of dynamic behaviour relevant to psychological phenomena. As we have seen, some psychological processes are better conceptualized as the expression of periodic trends, that is, as linear yet redundant trajectories; some other processes are to be seen in terms of a non linear course, entailing models going beyond the use of the traditional techniques of analysis based on linear algebra. Yet other processes seem to show traces of chaotic dynamics, characterized by dependence on the initial condition and dissipative behaviour (presence of strange attractor). Finally, in other cases the models and tools of the theory of the self-organization system seem to be the most useful way of coping with the phenomena.

Secondly, according to our discussion, the variability among the different approaches mentioned above has to be seen not as the reflection of the intrinsic nature of the psychological phenomena in question. In this sense, it is not an empirical matter. Rather, it is a theoretical choice entailing the decision of what aspect(s) of the phenomena should receive more attention and which should be placed in the background. Obviously this statement does not mean that the mundane manifestations of psychological processes are irrelevant. Yet they work as constraints on the viability of the theoretical choice, rather than input regulating it. This last statement has an important implication: the possibility of once again considering methodology as a theoretical activity: thinking of how one has to model the scientific object according to the aim of—and the resources for—its representation.

**Acknowledgement** We wish to thank the participants in the session of the Clark University's Kitchen Seminar (10 September, 2008) devoted to the discussion of a first draft of this text. The discussion that developed there provided meaningful feedback, helping us to bring the implications of our proposal into focus.

## References

- Amit, J. D. (1989). *Modeling brain function*. Cambridge: Cambridge University Press.
- Anderson, P. (1972). More is different. *Science*, 177, 393–394.
- Barkham, M., Stiles, W. B., & Shapiro, D. A. (1993). The shape of change in psychotherapy: Longitudinal assessment of personal problems. *Journal of Consulting and Clinical Psychology*, 61, 667–677.
- Bordin, E. S. (1979). The generalizability of the psychoanalytic concept of the working alliance. *Psychotherapy: Theory, Research and Practice*, 16, 252–260.
- Bucci, W. (1998). *Psychoanalysis and cognitive science*. New York: Guilford Press.
- Cassidy, J., & Shaver, P. R. (1999). *Handbook of attachment: Theory, research and clinical applications*. New York: The Guilford Press.
- Dimaggio, G., & Semerari, A. (2004). Disorganized narratives: The psychological condition and its treatment. In L. E. Angus & J. McLeod (Eds.), *The handbook of narrative and psychotherapy: Practice, theory and research* (pp. 263–282). London: Sage Publications.
- Eco, U. (1976). *Theory of semiotics*. Bloomington: Indiana University Press.

- Fonagy, P., Gergely, G., Jurist, E. L., & Target, M. (2002). *Affect regulation, mentalization and the development of the self*. New York: Other Press.
- Fontao, M. I., & Mergenthaler, E. (2007). Application of the therapeutic cycle model to the research study of microprocesses in group therapy. *Revista Argentina de Clínica Psicológica*, 14(1), 53–63.
- Gabbard, G. (2005). *Psychodynamic psychiatry in clinical practice* (4th ed.). Washington, DC: American Psychiatric Publishing, Inc.
- Gennaro, A., Salvatore, S., Lis, A., & Salcuni, S. (2008, June 18th–22nd). *Looking at the psychotherapy process as an intersubjective dynamic of sensemaking*. Paper presented at the 39th Annual meeting of the Society of Psychotherapy Research, Barcelona, Spain.
- Greenberg, L. S. (1991). Research on the process of change. *Psychotherapy Research*, 1, 14–24.
- Haken, H. (1992). Synergetics in psychology. In W. Tschacher, G. Schiepek, & J. Brummer (Eds.), *Self-organization and clinical psychology: Empirical approaches to synergetics in psychology*. Berlin: Springer Verlag.
- Hayes, A. M., Laurenceau, J. P., Feldman, G., Strauss, J. L., & Cardaciotto, L. A. (2007). Change is not always linear: The study of nonlinear and discontinuous patterns of change in psychotherapy. *Clinical Psychological Review*, 27, 715–723.
- Hoffman, I. Z. (1998). *Ritual and spontaneity in the psychoanalytic process*. New Jersey Hillsdale: The Analytic Press Inc.
- Hopfield, J. J. (1986). Neural networks and physical systems with emergent collective computational abilities. *Proceedings of the National Academy of Sciences USA*, 79(21), 2554–2558.
- Horowitz, M. J., Kernberg, O. F., & Weinshel, E. M. (Eds.). (1993). *Psychic structure and psychic change: Essays in honor of Robert Wallerstein*. Madison: International University Press.
- Kaplan, D., & Glass, L. (1995). *Understanding non linear dynamics*. New York: Springer-Verlag.
- Kowalik, Z., Schiepek, G., Kumpf, K., Roberts, L. E., & Elbert, T. (1997). Psychotherapy as a chaotic process: II. The application of nonlinear analysis methods on quasi time series of the client-therapist interaction: A nonstationary approach. *Psychotherapy Research*, 7(3), 197–218.
- Kraemer, S., Lihl, M., & Mergenthaler, E. (2007). Schlüsselstunden im Verlauf kognitiver Verhaltenstherapie von schizophrenen Patienten: Ein Beitrag zur Prozessforschung. *Verhaltenstherapie*, 17, 90–99.
- Lambert, M. J. (Ed.). (2004). *Bergin and Garfield's handbook of psychotherapy and behavior change* (5th ed.). New York: Wiley.
- Lambert, M. J., & Barley, D. E. (2001). Research summary on the therapeutic relationship and psychotherapy outcome. *Psychotherapy Theory Research Practice and Training*, 38, 357–361.
- Lancia, F. (in press). Word co-occurrence and similarity in meaning. In S. Salvatore & J. Valsiner (Eds.), *Mind as infinite dimensionality*. Charlotte, NC: Information Age Publishers.
- Lauro-Grotto, R., Reich, S., & Virasoro, M. A. (1997). The computational role of conscious processing in a model of semantic memory. In M. Miyashita, M. Ito, & E. Rolls (Eds.), *Cognition, computation and consciousness* (pp. 248–263). Oxford: Oxford University Press.
- Lepper, G., & Mergenthaler, E. (2005). Exploring group process. *Psychotherapy Research*, 15(4), 433–444.
- Lepper, G., & Mergenthaler, E. (2007). Therapeutic collaboration: How does it work. *Psychotherapy Research*, 17(5), 576–587.
- Martin, D. J., Garske, J. P., & David, M. K. (2000). Relation of the therapeutic alliance with outcome and other variables: A meta-analytic review. *Journal of Consulting and Clinical Psychology*, 68, 438–450.
- Matte Blanco, I. (1975). *The unconscious as infinite sets*. London: Gerald Duckworth & Company.
- Maturana, H. R., & Varela, F. J. (1980). *Autopoiesis and cognition: The realization of the living*. Dordrecht, Holland: Reidel Publishing Company.
- Mergenthaler, E. (1996). Emotion abstraction patterns in verbatim protocols: A new way of describing therapeutic processes. *Journal of Consulting and Clinical Psychology*, 64, 1306–1318.



- Mergenthaler, E. (1998). CM—the Cycles Model software. (Version 1.0). Sektion Informatik in der Psychotherapie. Ulm, Germany, Universität Ulm.
- Mergenthaler, E., & Gelo, O. (2007). Un'analisi qualitativa del Disturbo di Personalità Narcisista attraverso il Modello del Ciclo Terapeutico: uno studio single-case (Caso K.). In G. Nicolò & S. Salvatore (Eds.), *La ricerca sui risultati e sul processo in psicoterapia* (pp. 313–328). Roma: Edizioni Carlo Amore.
- Mezard, M., Parisi, G., & Virasoro, M. A. (1987). *Spin glass theory and beyond*. Singapore: World Scientific.
- Mossi, P. G. & Salvatore, S. (in press). *Psychological transition from meaning to sense*.
- Odgen, T. H. (2004). The analytic third: Implications for psychoanalytic theory and technique. *The Psychoanalytic Quarterly*, 73(1), 167–194.
- Orsucci, F. (2006). The paradigm of complexity in clinical neuro-cognitive science. *The Neuroscientist*, 12(5), 390–397.
- Ramseyer, F., & Tschacher, W. (2006). Synchrony a core concept for a constructivist approach to psychotherapy. *Constructivism in the Human Sciences*, 11, 150–171.
- Rapaport, D. (1960). *The structure of psychoanalytic theory. A systematizing attempt*. New York: International Universities Press.
- Rommetveit, R. (1992). Outlines of a dialogically based social-cognitive approach to human cognition and communication. In A. H. Wold (Ed.), *The dialogical alternative towards a theory of language and mind* (pp. 19–44). Oslo: Scandinavian University Press.
- Safran, J. D., & Muran, J. C. (2000). *Negotiating the therapeutic alliance: A relational treatment guide*. New York: Guilford Press.
- Salvatore, S., Gelo, O., Gennaro, A., Manzo, S., & Al-Radaideh, A. (in press). *Looking at the psychotherapy process as an intersubjective dynamics of meaning making. A case study with Discourse Flow Analyzer*.
- Salvatore, S., Lauro-Grotto, R., Gennaro, A., & Gelo, O. (2009). Attempts to grasp the dynamicity of intersubjectivity. In J. Valsiner, P. C. M. Molenaar, M. C. D. P. Lyra, & N. Chaudhary (Eds.), *Dynamic process methodology in the social and developmental sciences* (pp. 171–190). New York: Springer.
- Salvatore, S., Quarta R., & Ruggeri R. (in press). The effect of violent videogames in eliciting aggressiveness. A semiotic model.
- Salvatore, S., Tebaldi, C., & Pofi, S. (2009). The discursive dynamic of sensemaking. In S. Salvatore, J. Valsiner, S. Strout, & J. Clegg (Eds.), *Yearbook of idiographic science 2008* (Vol. 1). Rome: Firera Publishing Group.
- Salvatore, S., & Valsiner, J. (2006). “Am I really a psychologist?”. “Making sense of a super-human social role”. *European Journal of School Psychology*, 4(2), 127–149.
- Salvatore, S., & Venuleo, C. (2008). Understanding the role of emotion in sense-making. A semiotic psychoanalytic oriented perspective. *Integrative Psychological and Behavioral Science*, 42(1), 32–46.
- Salvatore, S., & Venuleo, C. (2009). The unconscious as source of sense: A psychodynamic approach to meaning. In B. Wagoner (Ed.), *Symbolic transformations: The mind in movement through culture and society*. London: Routledge.
- Sato, T. (2009). Constructing life course trajectories. In J. Valsiner, P. C. M. Moolenaar, M. C. D. P. Lyra, & N. Chaudhary (Eds.), *Dynamic process methodology in the social and developmental sciences* (pp. 217–240). New York: Springer.
- Sato, T., Yasuda, Y., Kido, A., Arakava, A., Mizoguchi, H., & Valsiner, J. (2007). Sampling reconsidered: Idiographic science and the analysis of personal life trajectories. In J. Valsiner, A. Rosa (Eds.), *The Cambridge handbook of sociocultural psychology* (pp. 82–106). Cambridge: Cambridge University Press.
- Schiepek, G., Kiwalik, Z. J., Schutz, A., & Kohler, M. (1997). Psychotherapy as a chaotic process: I. Coding the client-therapist interaction by means of sequential plan analysis and the search for chaos: A stationary approach. *Psychotherapy Research*, 7(3), 173–194.
- Schiepek, G., Tschacher, W., & Kaimel, E. (1992). *Self organization and clinical psychology*. Berlin: Springer.

- Semerari, A., Carcione, A., Dimaggio, G., Nicolò, G., & Procacci, M. (2007). Understanding minds: Different functions and different disorders? The Contribution of Psychotherapy Research. *Psychotherapy Research*, 7(1), 106–119.
- Sève, L. (1972). The structural method and the dialectical method. *International Journal of Sociology*, 2, 2–3.
- Storolow, R. D., Atwood, G. E., & Brandchaft, B. (1994). *The intersubjective perspective*. Hillsdale, NJ: Jason Aronson.
- Strogatz, S. H. (1994). *Nonlinear dynamics and chaos, with applications to physics, biology, chemistry and engineering*. Cambridge, MA: Perseus Books.
- Tschacher, W., Ramseyer, F., & Grawe, K. (2007). Der Ordnungseffekt im Psychotherapieprozess Replikation einer systemtheoretischen Vorhersage und Zusammenhang mit dem Therapieerfolg. *Zeitschrift für Klinische Psychologie und Psychotherapie*, 36, 18–25.
- Tschacher, W., Scheier, C., & Grawe, K. (1998). Order and pattern formation in psychotherapy. *Non linear dynamics psychology and life sciences*, 2, 195–215.
- Tschacher, W., Schiepek, G., & Brummer, E. J. (Eds.). (1992). *Self-organization and clinical psychology. Empirical approaches to synergetics in psychology*. Berlin: Springer Verlag.
- Valsiner, J. (2007). *Culture in minds and societies: Foundations of cultural psychology*. New Delhi: Sage.
- Venuleo, C., Salvatore, S., Mossi, P. G., Grassi, R., & Ruggeri, R. (2008). The didactic relationship in the changing world. Outlines for a theory of the reframing setting. *European Journal of School Psychology*, 5(2), 151–180.
- Wallerstein, R. S. (1998). One psychoanalysis or Many? *The International Journal of Psychoanalysis*, 69, 5–21.
- Westen, D. (1998). The scientific legacy of Sigmund Freud: Toward a psychodynamically informed psychological science. *Psychological Bulletin*, 124, 333–371.
- Wittgenstein, L. (1958). *Philosophische Untersuchungen*. Oxford: Basic Blackwell.

## Chapter 2

# Reviving Person-Centered Inquiry in Psychology: Why it's Erstwhile Dormancy?

James T. Lamiell

Just a few short years ago one of the co-editors of this volume published an article in the journal *Measurement* under the title: “A Manifesto on Psychology as Idiographic Science: Bringing the Person Back Into Scientific Psychology, This Time Forever” (Molenaar, 2004). To one who himself has long advocated just such a development, this bold manifesto was most welcome indeed. But the very claim to lately be bringing the person *back* into scientific psychology begs the questions: why has this proved necessary? and: where had the person been for all of those previous years?

In the present chapter, consideration is given to the manner in which early 20th century commitments within the sub-discipline of personality psychology managed to suppress person-centered inquiry in a way that made nearly invisible the fact that that was what was happening. Under the terms of those commitments, a research paradigm was developed that came to be regarded—widely but incorrectly—as wholly adequate, at least in principle, to the objective of advancing our scientific understanding of human individuality. This view seemed to obviate altogether the need for an approach to the study of persons that would differ in any fundamentally significant way(s) from the established paradigm. It thus seemed justifiable to dismiss challenges to this view—most notably that mounted by Gordon Allport (1897–1967)—on the grounds that the critics’ views either were not fundamentally different from mainstream thinking after all, or that they differed in ways that transgressed the boundaries of science and for that reason merited no further consideration (e.g., Cattell, 1952; Eysenck, 1954; Holt, 1962; Sanford, 1963; Skaggs, 1945). Either way, the mainstream view could—and did—remain entrenched, and it has only been in more recent times that alternative views have finally begun to marshal a substantial backing (see, e.g., Harré, 2006, who has expressed astonishment that this change has been so long in coming).

---

J. T. Lamiell (✉)  
Department of Psychology  
Georgetown University  
Washington, DC 20057, USA  
e-mail: lamiellj@georgetown.edu

In requesting of me a contribution to this volume, the editors explained their desire to consolidate within a single publication ideas that are of central relevance to the work's larger mission, but that heretofore have appeared in widely disparate publications. Consistent with this objective, one function of this contribution is essentially archival, namely, to include within the larger work a relatively concise and accessible treatment of historical developments and conceptual arguments that I have discussed at greater length, and from a number of different angles, in various other works published over the years (see, e.g., Lamiell, 1981, 1987, 1990, 1997, 1998, 2000, 2003, 2006, 2007). An additional function that might be served by this contribution is to make clear those points where continued resistance by adherents of traditional mainstream thinking is likely to be encountered.

## The Historical Need for a 'Differential' Psychology

In the foreword to what appears to have been the first textbook in 'differential' psychology, William Stern (1871–1938) designated the phenomenon of 'individuality' as "the problem of the 20th century" (Stern, 1900, p. 5). What Stern meant by this was that any viable scientific psychology would have to find a way to meet the challenge presented by the seemingly undeniable facts of, as he put it, "human particularities (*Eigenarten*) and differences (*Unterschiede*)" (Stern, 1900, p. 1). The contention was that there are certain important aspects of any given individual's mental life and behavior that inevitably would be left unexplained by whatever general laws experimental psychology might succeed in discovering. Stern believed that a 'differential' psychology, i.e., a psychology devoted to the systematic investigation of the aforementioned individual 'particularities and differences,' would help to highlight the need for a scientifically viable accounting of those otherwise unexplained phenomena.

Early in the first chapter of the 1900 book, in which Stern discussed the "nature and tasks" of differential psychology, he advised his readers of the need to "touch upon a terminological point" (p. 3), one that he elaborated as follows:

For this newly emergent branch of inquiry we already find various names being used which are not especially to my liking. 'Characterology' (Bahnsen), 'ethology' (Mill), 'individual' or '*individuelle* psychology' (Binet, Henri, Kraepelin among others). The first two of these expressions are decidedly too narrow. ... The name 'individual psychology' would be more useful were it not already firmly in use. But it is now already generally used in contrast to 'cultural' psychology (*Völkerpsychologie*) and 'social' psychology, and thus incorporates everything that relates to the mental life of the individual, and is not limited to refer to the separation of many individuals. (Stern, 1900, pp. 3–4, parenthetical material in original; bracketed material supplied by present author)

We see here that even as Stern was pointing to the need for a psychology that could meet the challenges posed by the facts of human *individuality*, he was also drawing attention to the fact that something called an *individual* psychology was already in place. Indeed, that was quite the case: the general-experimental psychology famously founded by Wundt in 1879 in Leipzig was also called, and properly

understood to be, an *individual* psychology: the objective of the discipline was to discover the general laws—*die allgemeinen Gesetze*—governing *individual* consciousness, and it was for just this reason that experiments were carried out on *individual* subjects, one at a time. How else to discover laws of consciousness that are in fact *general* in the understood sense of *allen gemein*, meaning *common to all individuals*, except through the investigation of single cases?

But it was precisely general psychology's exclusive concern for whatever could be found to be true of individuals in general that, while qualifying it as an *individual* psychology simultaneously rendered it blind or indifferent to all empirical manifestations of *individuality*, i.e., individual 'particularities and differences.' Therein lay the need for a complement to—not a replacement for—the general-experimental-individual psychology of the early 20th century, and Stern made explicit in the 1900 book that it was just such a psychology that he was seeking to formally establish. He needed a name for the new sub-discipline, however, and noted in this connection that

...the area of inquiry being christened here should take as its subject matter not only the differences between one individual and another but also the differences between peoples, social strata, gender, animal species, etc., in short, all psychological differentiation possibilities whatsoever. For this comprehensive program, the expression 'differential psychology' seems best. (Stern, 1900, p. 4)

One complicating factor here stems from the fact that, taken at face value, the expression 'individual differences' might be understood as referring to differences between distinct individuals (inter-individual differences) or to differences within an individual over time or across situations (intra-individual differences). There are places in Stern's (1900) book suggesting that he was interested in both types of differences. However, having settled on the name 'differential psychology' for the new sub-discipline he was seeking to establish, Stern proceeded in the 1900 book to delineate the sub-discipline's central tasks in a way that placed decided emphasis on inter-individual differences. In particular, he argued that the sub-discipline should be oriented toward (1) identifying the basic dimensions and categories of individual and group differences, (2) discovering the causes of those differences as they are presumably rooted in some combination of nature and nurture, and (3) illuminating the manner in which those differences are manifested in various domains of human behavior such as school, the workplace, and the home.

This circumscription of the scientific agenda of differential psychology would soon be widely adopted as definitive of *the* proper approach to a scientific understanding of human individualities. A rationale for proceeding in this way was clearly articulated by the highly influential E. L. Thorndike (1874–1949) in the very first pages of his 1911 monograph titled *Individuality* (Thorndike, 1911). He wrote:

We may study a human being in respect to his common humanity, or in respect to his individuality. In other words, we may study the features of intellect and character which are common to all men, to man as a species; or we may study the differences in intellect and character which distinguish individual men. (Thorndike, 1911, p. 2)

Noteworthy here is Thorndike's *equation* of the study of *individuality* with the study of *individual differences*. Having done this, he proceeded directly to a

statement of how knowledge of individual differences would be articulated with knowledge of general laws in order to achieve control over, or effect desired changes in, individual behavior:

The study of the facts and laws applicable to all men by virtue of their common humanity gives education its fundamental rules for the control of changes in intellect and character. The study of the facts and laws of individual differences enables us to apply these principles economically in the case of each individual whom we seek to educate. (Thorndike, 1911, p. 2).

As mentioned above, this is the view that rapidly came to dominate mainstream thinking generally (not just within the domain of educational psychology), and in fact there is little to distinguish it, in its essence, from the position Lee J. Cronbach (1916–2001) would adopt nearly five decades later in his famous call for the coordination of the ‘two disciplines’ of scientific psychology (Cronbach, 1957). Moreover, Thorndike’s perspective on the problem of individuality might have seemed to his contemporaries, at first blush, to be consonant with the view Stern was promoting in his 1900 book. In fact, however, the equation Thorndike made is *not* one that Stern had made or ever would make. In fact, it is an equation Stern would explicitly reject. If his convictions in this regard were not stated with crystalline clarity in the 1900 book (cf. Lamiell, 2003; Stern, 1927), his treatment of matters was considerably sharper in a sequel to that work, a book he titled *Die Differentielle Psychologie in ihren methodischen Grundlagen (Methodological Foundations of Differential Psychology)*. In this latter work, which, ironically, appeared in 1911 (the same year in which Thorndike’s *Individuality* was published), Stern set forth a vision of differential psychology as comprised of *four* basic research ‘schemes’ or ‘disciplines,’ two of which were based upon the study of inter-individual differences and two of which were not. Stern clarified the nature of these four research disciplines in terms of the basic concepts of *attributes* and *individuals* (see Stern, 1911, pp. 18–19):

‘Variation research,’ Stern explained, would entail the study of the distribution of a single attribute variable within a population of (indefinitely) many individuals.

‘Correlation’ research would entail the study of the co-variation between two or more attribute variables within a population of (indefinitely) many individuals.

Obviously, both of these research schemes entail the study of inter-individual differences. However, differential psychology as Stern envisioned it would also properly include two additional research schemes:

‘Psychography’ (*die Psychographie*) would entail the study of a single individual in terms of some (unspecified) number of attributes.

Finally, ‘comparison’ research would entail the study of two or more individuals, each characterized in terms of some (unspecified) number of common attributes.

Having laid out this fourfold conception of differential psychology as an empirical science, Stern emphasized that only the latter two of the four research schemes just named, psychography and comparison research, could properly be said to yield knowledge of individuals. Hence, it would be those two schemes—and especially psychography as the more basic of the two—that would be best suited to addressing ‘the problem of individuality’ as he envisioned things. In variation research

and in correlation research, Stern explained, individuals are actually serving merely as 'place-holders,' so to speak, representing various positions along the dimension represented by the attribute variable(s) that is/are in fact the entity(ies) under investigation. The knowledge yielded within these two disciplines, therefore, is actually knowledge of the attribute variable(s) in terms of which individuals have been differentiated, and not knowledge about the individuals who have been differentiated in terms of that/those attribute variable(s).

This distinction between knowledge of attributes, on the one hand, and knowledge of individuals, on the other, is crucial. Unfortunately, it is just this distinction that was lost on the overwhelming majority of mainstream thinkers in 20th century psychology—including but not limited to those who identified themselves as 'personality' investigators. In a way to be elaborated presently, the view came to prevail that knowledge about attribute variables, i.e., dimensions of individual differences, just *is* knowledge of the individuals who have been differentiated in terms of those attribute variables. On this view, then, the person is not 'lost' within the prevailing paradigm at all, and so there would be neither need nor scientific justification for trying to 'bring the person back' through some other means of investigation. To its adherents, what the favored approach seemed to entail was not a rejection of person-centered inquiry but instead the affirmation of such inquiry in the only way that it could be affirmed while remaining within the boundaries of science.

So the question is: How was this accomplished? The answer to this question is to be found in the way in which mainstream investigators came to understand the nature of the statistical knowledge produced through the investigative methods on which they have relied so extensively in carrying out their work.

## **Statistical Thinking in the Co-optation of Person-Centered Inquiry**

### ***The Ascendance of the 'Neo-Galtonian' Model for Psychological Research***

Reference was made above to Cronbach's mid-century call for a systematic coordination of scientific psychology's "two disciplines": experimental psychology, on the one side, and correlational psychology, on the other (Cronbach, 1957). The experimentalists, Cronbach noted, were interested in the effects on various aspects of psychological and/or behavioral life resulting from the differential treatment of organisms, while the correlationists (i.e., the investigators Danziger (1987) called the 'Galtonians') were concerned with the effects produced by "already existing variation between individuals, social groups, and species" (Cronbach, 1957, p. 671). Employing rudimentary statistical concepts in order to highlight the prospects for successfully merging these two programmatic concerns, Cronbach pointed out that in the day-to-day conduct of their work, the experimental psychologists were

primarily concerned with dependent variable differences between treatment group means, while the correlationists were keen to examine just those between-person differences within treatment groups that the experimentalists preferred to ignore. Viewing scientific psychology's overall situation this way, Cronbach (1957) pointed out, it was easy to see how the concerns of the two traditions could be coordinated in the effort toward a common goal, namely, achieving the most complete account possible of any given organism's psychological functioning and/or behavior.

What Cronbach (1957) advocated was an approach to psychological research that Danziger (1987) has aptly labeled 'neo-Galtonian.' In that approach, the essential features of which were worked out many years prior to Cronbach's pronouncements, experimentation does not proceed in accordance with the  $N=1$  procedures adopted by Wundt and Ebbinghaus and the other pioneering experimentalists, but is rather based on the notion of *treatment groups*: subjects are sampled from populations and randomly assigned, in numbers appreciably larger than 1, to one of two or more treatment conditions. The effects of the treatments are then ascertained by statistically comparing the dependent variable means associated with those respective treatment conditions. Obviously, such effects will be attenuated to the extent that between-person differences within the respective treatment conditions are large, but to the extent that those between-person differences can themselves be statistically accounted for by the correlationists, the experimentalist's quest for knowledge of treatment effects can actually be facilitated. This, of course, was Cronbach's (1957) central point: the goal shared in common by the treatment-groups experimentalist on the one hand, and by the Galtonian correlationist on the other, is *to account for between-person variance* in dependent variables and/or criterion measures. The statistical concepts and methods common to both forms of inquiry—involving the analysis of means, variances, and co-variances (i.e., correlations)—made the merger of these two research programs both possible and eminently sensible.

It has already been noted that this investigative model is essentially identical to the one that E. L. Thorndike had espoused much earlier as a framework within which to coordinate knowledge of individual differences with knowledge of the general laws of human psychological functioning in predicting, explaining, and controlling the behavior of individuals in various life settings (Thorndike, 1911, see discussion above). So the question is: Is statistical knowledge of the sort yielded by neo-Galtonian inquiry in fact a sound basis for claims to knowledge about individuals?

The correct answer to this question is *no*. However, throughout the last century and into the present one most mainstream investigators have proceeded in the conviction that the answer is 'yes.' The primary challenge for critics of mainstream thinking has thus been to explain as clearly and thoroughly as possible why this conviction is ill-founded. For reasons I have discussed elsewhere (Lamiell, 1987, 1997), the most visible 20th century critic of mainstream thinking, Gordon Allport, did not meet this challenge very effectively, and this has undoubtedly been a major factor contributing to the persistence of mainstream views up to the present. What follows, then, is a renewal of the ongoing effort to make clear to as broad an audience as possible why the need to 'bring the person back' into scientific psychology arose.



## Mainstream Convictions About the Nature of Aggregate Statistical Knowledge in Historical Perspective

At its founding and during its early years, experimental psychology did not entail statistical analyses of data obtained from large numbers of individuals who had been sampled from populations (Danziger, 1987, 1990). This is not because statistical methods had not yet been invented or come into use. On the contrary, the Belgian scholar Adolphe Quételet (1796–1874) had made such methods the foundation of his ‘social physics’ in the 1830s, and by 1879 they were in widespread use throughout the ‘moral sciences’ in an attempt to shed light on various aspects of societal functioning (see Porter, 1986). As noted earlier, however, psychology’s early experimentalists were seeking to discover lawful regularities that could be regarded as *general* in the sense of *common to all* individuals, and this called for investigations of individual subjects, one at a time. To the extent that statistical computations were undertaken at all, the objective was to estimate measurement error in multiple observations of single subjects, and not to estimate population parameters (Danziger, 1987, 1990).

Central to the thinking of the aforementioned Quetelet was the conviction that scientifically explaining—and hence being able to predict—individual behavior was not an attainable goal. He believed that order sufficient to be captured scientifically would emerge only at the aggregate level, and therefore the only ‘individual’ about whom the social physicist could make scientific pronouncements would be that fictitious but nevertheless heuristically serviceable entity, *l’homme moyen*, or the average man. In Quetelet’s view, social physics would not entail scientific pronouncements about real individuals:

If one seeks to establish, in some way, the basis of a social physics, it is he (*l’homme moyen*) whom one should consider, without disturbing oneself with particular cases or anomalies, and without studying whether some given individual can undergo a greater or lesser development in one of his faculties. (Quetelet, as quoted in Porter, 1986, pp. 52–53)

Clearly, Quetelet’s view is one that thinkers such as Thorndike and, in his turn, Cronbach, could not possibly have found adequate for their purposes. On the contrary, the ultimate objective of scientific psychology very much *is* to be able to explain and predict behavior in ‘individual cases’—including ‘anomalies’—and to determine such things as whether and in what way a given individual could ‘undergo a greater or lesser development in one of his faculties.’ Clearly, the methods of neo-Galtonian inquiry are formally suited to this objective only under the presumption that the aggregate statistical knowledge produced by such inquiry somehow constitutes a kind of ‘window’ onto individual-level behavior and psychological functioning.

Precedent for such a view could be found in the writings of the 19th century historian Henry Thomas Buckle (1821–1862). In his *A History of Civilization in England*, published in its first edition in 1857 (Buckle, 1857), Buckle enthusiastically embraced the very statistical methods advocated by Quetelet, arguing that “(from carefully compiled statistical facts) more may be learned about the moral nature of

Man than can be gathered from all the accumulated experiences of the preceding ages” (Buckle, 1857/1898, p. 17). Going beyond Quetelet, however, Buckle argued that aggregate statistical knowledge *is* informative about *individual* level functioning and that, therefore, the way to a thoroughgoing scientific account of individual behavior was through statistically oriented investigations. This commitment is clearly evident in Buckle’s discussion of suicide—by definition an individual act:

All of the (statistical) evidence we possess respecting (suicide) points to one great conclusion, and can leave no doubt on our minds that suicide is merely the product of the general condition of society, and that the individual felon only carries into effect what is a necessary consequence of preceding circumstances. In a given state of society, a certain number of persons must put an end to their own life. This is the general law; and the special question as to who shall commit the crime depends of course upon special laws; which, however, in their total action, must obey the large social law to which they are all subordinate. (Buckle, 1857, 1898, p. 20).

Buckle went on to re-emphasize to his readers that the proofs of his argument were “derived from statistics,” referring to that discipline as “a branch of knowledge which, though still in its infancy, has already thrown more light on the study of human nature than all the sciences put together” (Buckle, 1857, 1898, pp. 24–25).

The view of aggregate statistical knowledge lying at the very heart of neo-Galtonian research methods in psychology is essentially Buckle-ian in nature. Consider the simple case of an experiment involving the random assignment of each of 30 research subjects to one of two different treatment groups. The usual question is of the general form: What is the strength or magnitude of the effect, as measured on some dependent variable, of some independent variable defined by the differential treatment of research subjects? By traditional thinking, the answer to this question can be uncovered through a statistical analysis of the difference between the dependent variable means within the respective treatment conditions. Where that difference is statistically ‘large’ (as indexed, for example, by the percentage of total variance that can be attributed to the differential treatments), the ‘effect’ of the treatments may be regarded as commensurately ‘strong.’ Conversely, where the difference is statistically ‘small,’ the ‘effect’ of the treatments is to be regarded as commensurately ‘weak.’ In any case, the ‘effect’ of each of the two (or, as the case could be, more) treatments is presumed to be realized *in each of the individual subjects exposed to the respective treatments*. So, for example, if the average criterion test performance among pupils exposed to teaching method 1 is found to be  $x$  units lower than the overall average for all 30 students, then it is inferred that this ‘lowering’ effect is due to teaching method 1, and this effect is regarded as having been realized *in each* of the 15 pupils who were exposed to that teaching method. The opposite effect, whereby the average of the criterion test scores of the 15 pupils exposed to teaching method 2 is  $x$  units higher than the ‘grand’ mean, is likewise regarded as having been realized *in each* of the 15 pupils exposed to teaching method 2.

Of course, it will rarely if ever be the case empirically that all subjects exposed to the same treatment will be found to have identical standing on the criterion variable  $x$  units below or above the grand mean. But in neo-Galtonian inquiry this is not taken as evidence against the presumption that the treatment in question exerted its effect on each of the subjects exposed to it. On the contrary, such between-person variance

among subjects treated alike is seen as an indication that there must have been other factors influencing criterion variable performance in addition to and/or in interaction with—but *not instead of*—that treatment. This is just where the interests of the ‘correlationists’ come into play. For example, gender, or race, or ethnicity might be regarded as possibly relevant group-differences variables, to be investigated for their possible ‘effects’ on the criterion measure(s) both parallel to and in convergence with the treatment variable(s). In like fashion, individual differences variables such as intelligence or achievement motivation or personality factors might also be considered for their potential utility in accounting for between-person variance in the criterion variable(s).

But however extended or complex such neo-Galtonian research designs become, the presumption is always that the ‘effects’ of the variables (or variable combinations) investigated, as indexed statistically in terms of percentage of between-person variance accounted for, are being realized in each of the individual subjects investigated. Without this presumption, neo-Galtonian inquiry simply makes no sense as a framework within which to formulate scientific explanations for and/or predictions of individual behavior. Moreover, and just because this very presumption was widely accepted not only by mainstream thinkers but also by most of their critics, the latter were forced to see their task as that of explaining how some alternative investigative method(s) could, while remaining within the boundaries of science, *supplement* the knowledge about individuals achievable through neo-Galtonian methods.

In taking on *this* task, the critics of mainstream thinking were conceding that conventional neo-Galtonian methods do yield scientific knowledge about individuals, and it was this concession that fatally but quite unobtrusively sabotaged their efforts from the very start. For with this concession in hand, the way was free for mainstream thinkers to regard all empirical insufficiencies of neo-Galtonian studies as indicative not of the need for a fundamentally *different* kind of knowledge about individuals but instead of the need for *more of the same* kind of knowledge that neo-Galtonian methods are fit to produce. If in addition to this point one considers the widespread confusion on both sides of the long-running ‘nomothetic vs. idiographic debate’ over the proper meanings of the terms ‘nomothetic’ and ‘idiographic’ (cf. Lamiell, 1998), it is no longer difficult to see why Allport and other apologists for idiography ended up banished to the proverbial ‘corner’ (cf. Lamiell, 1987, 2003).

### **On Closer Examination: The Untenable Position of Neo-Galtonians Relative to Established Traditions Concerning Probabilistic Thinking**

The fact that in practice all of the between-person variance in criterion measures is never fully accounted for leaves the neo-Galtonian investigator ever in need of recourse to knowledge claims of a probabilistic sort. The general form of such claims is: ‘Based on the results of the statistical analysis, it can be said that the

probability that X obtains in the case of Smith is  $p$ .' The question that begs here is: How—if at all—does scientific authority accrue to knowledge claims of this sort? It is in pursuit of an answer to this question that the wheels of neo-Galtonian inquiry as a framework for the study of personality fall off.

One long-accepted hallmark of the scientific standing of claims to empirical knowledge is that they are at least in principle subject to empirical challenge (Popper, 1959/2002). So in the present context it must be asked: For what value(s) of  $p$  could empirical observations possibly challenge a knowledge claim of the general form just described? Clearly, if  $p$  is 1—which is tantamount to a claim of certainty that X obtains in the case of Smith—then discovering empirically that X does not obtain in Smith's case would challenge this claim. By the same token, if  $p$  is zero—which is tantamount to a claim of certainty that X does not obtain in the case of Smith—then discovering empirically that X does obtain in Smith's case would challenge the claim. But under all other possible values of  $p$ , which is to say under all values of  $p$  ever actually encountered in the scientific discourse of mainstream personality investigators, a claim of the sort 'the probability is  $p$  that X obtains in the case of Smith' is in principle empirically *incorrigible*. Discovering that X fails to obtain in Smith's case cannot empirically refute the claim that the probability of this finding was 'low,' but nor could discovering that X does obtain in Smith's case refute the claim that the probability of *this* finding was 'low.' In all instances of this sort, the putative claim to some bit of factual knowledge about Smith proves empty because such claims are entirely immune from empirical challenge: they always remain standing no matter what value of  $p$  (other than 1 or zero) is asserted and no matter what finally turns out to be the empirical case about Smith.

In his recent critical commentary on this line of argumentation as developed at greater length elsewhere (Lamiell, 2003), Hofstee (2007) remarked that:

those who adhere to it in practice are the kind of people any bridge-player would love to have for an opponent. The argument would counterfactually deny that people form expectations and make estimates, activities that are well represented by statistical models, and that these activities have definite survival value. In other words, the argument is a piece of sophistry. (Hofstee, 2007, p. 253)

In the present context, what is most interesting about this commentary is its implicit (though apparently unwitting) appeal to that long-standing tradition of thought about statistical thinking known as *subjectivism* (cf. Hacking, 1975; Porter, 1986). The essence of this view is that a probabilistic claim concerning some single event is meaningful not as a statement of empirical fact about that event but instead as a declaration of the strength of a subjective belief about that event held by the speaker. On this view, a statement of the sort 'the probability is high (low) that X obtains in the case of Smith' is properly understood as an expression of the speaker's level of confidence that X does or does not obtain in Smith's case.

Contrary to Hofstee's (2007) assertion, there is nothing in the argument sketched previously that denies this subjectivist understanding of the meaning of probabilistic statements. Neither, however, is there anything in the subjectivist understanding of the meaning of probabilistic statements that refutes the argument sketched previously. That argument was addressed to the question: How, if at all, do probabilistic

statements of the sort that can be warranted by neo-Galtonian investigations qualify *as claims to knowledge about the individual subjects studied in those investigations*? The suggestion by Hofstee (2007) that probabilistic statements by a neo-Galtonian investigator can be understood and justified as *declarations of his/her own subjective beliefs about those individual subjects* is both true and completely off point. Sophistry indeed!

To justify probabilistic assertions as claims to knowledge about the subjects of neo-Galtonian studies one must adopt a *frequentist* understanding of aggregate statistical knowledge (Hacking, 1975; Porter, 1986). On this view, such probabilistic claims are tied inextricably to the consideration of 'the subjects' as a *collective*, and so cannot sensibly be regarded as applicable to *any* single one of those subjects considered *individually*. To take a simple example: a claim that 'the probability is 0.7 that people scoring high on extraversion will show up at the next available party' can properly be understood to mean that given some indefinitely large sample of individuals scoring high on extraversion, 70% of them will show up at the next available party and 30% will not. This is an empirically testable proposition. However, into which of the two stipulated categories any given individual scoring high on extraversion will place him/herself by either attending or not attending the next available party is a matter on which the probabilistic knowledge claim is *silent*. From a frequentist perspective, a claim to *know* that in the case of *Smith*, who has scored high on extraversion, the probability is 0.7 that *she/he* will attend the next available is simply incoherent.

Unfortunately claims of just this sort are precisely the ones that neo-Galtonian 'personality investigators' have for decades indulged—and this is precisely how they have needed things to be. The subjectivist understanding of probabilistic claims will not work for neo-Galtonians because it would spotlight the fact that their probabilistic assertions are not really knowledge claims about their subjects at all, but are instead simply statements about the strength or magnitude of their own beliefs about their subjects. The frequentist understanding of probabilistic claims also will not work for neo-Galtonians because it admits such claims as claims to knowledge about 'the subjects' only when those subjects are considered as a collective and not when they are considered individually. The would-be solution to this dilemma has been to regard the empirical findings issuing from neo-Galtonian inquiry as if they warrant *knowledge* claims about *individual* subjects. The effort to 'bring the person back into scientific psychology' has proven necessary because the illusion that this latter position is tenable has been so compelling to so many for so long.

## Conclusion

The challenge to scientific psychology presented by what Stern termed 'the problem of individuality' is very nearly as great now as it was at the turn of the 20th century. To be sure: during 10-plus decades of Galtonian/neo-Galtonian inquiry, a great deal of empirical knowledge has been generated about a wide variety of indi-

vidual differences attributes, and nothing in the present argument can be understood as a categorical denigration of that knowledge per se. But as Stern clearly stated in his 1911 book, knowledge about the attributes in terms of which individuals have been differentiated is not knowledge about the individuals differentiated in terms of those attributes. Obviously, it is knowledge of individuals that is required in order to address the ‘problem of individuality.’

Were it not for mainstream psychologists’ widespread commitment to an untenable view of the nature of the aggregate statistical knowledge generated by Galtonian/neo-Galtonian research methods—a commitment that by now arguably qualifies as *perseveration*—Stern’s insight on this particular matter would likely have been appreciated much sooner. But this is not how things developed. Instead, and just because of that fateful commitment, it has seemed to the vast majority of those psychologists answering to the designation ‘personality investigator’ both possible and advisable to advance the scientific understanding of individualities through statistically driven studies of their differences. Dislodging this utterly mistaken belief has proven enormously difficult, and that is why genuinely person-centered inquiry in psychology has for so long been dormant.

At long last, however, it would appear that a new epoch has dawned.

## References

- Buckle, H. T. (1857/1898). *A history of civilization in England*. New York: D. Appleton and Company.
- Cattell, R. B. (1952). The three basic factor-analytic research designs—Their interrelations and derivatives. *Psychological Bulletin*, *49*, 499–520.
- Cronbach, L. J. (1957). The two disciplines of scientific psychology. *American Psychologist*, *12*, 671–684.
- Danziger, K. (1987). Statistical method and the historical development of research practice in American psychology. In L. Krueger, G. Gigerenzer, & M. S. Morgan (Eds.), *The probabilistic revolution: Vol. 2. Ideas in the sciences* (pp. 35–47). Cambridge, MA: MIT Press.
- Danziger, K. (1990). *Constructing the subject: Historical origins of psychological research*. New York: Cambridge University Press.
- Eysenck, H. J. (1954). The science of personality: Nomothetic! *Psychological Review*, *61*, 339–342.
- Hacking, I. (1975). *The emergence of probability*. Cambridge: Cambridge University Press.
- Harré, R. (2006). *Key thinkers in psychology*. London: Sage.
- Hofstee, W. (2007). *Unbehagen* in individual differences. *Journal of Individual Differences*, *28*, 252–253.
- Holt, R. W. (1962). Individuality and generalization in the psychology of personality. *Journal of Personality*, *30*, 377–404.
- Lamiell, J. T. (1981). Toward an idiothetic psychology of personality. *American Psychologist*, *36*, 276–289.
- Lamiell, J. T. (1987). *The psychology of personality: An epistemological inquiry*. New York: Columbia University Press.
- Lamiell, J. T. (1990). Explanation in the psychology of personality. In D. N. Robinson & L. P. Mos (Eds.), *Annals of theoretical psychology* (pp. 153–192). New York: Plenum Press.

- Lamiell, J. T. (1997). Individuals and the differences between them. In R. Hogan, J. Johnson, & S. Briggs (Eds.), *Handbook of personality psychology* (pp. 117–141). New York: Academic Press.
- Lamiell, J. T. (1998). ‘Nomothetic’ and ‘idiographic’: Contrasting Windelband’s understanding with contemporary usage. *Theory and Psychology*, 10, 715–730.
- Lamiell, J. T. (2000). A periodic table of personality elements? The “Big Five” and trait “psychology” in critical perspective. *Journal of Theoretical and Philosophical Psychology*, 20, 1–24.
- Lamiell, J. T. (2003). *Beyond individual and group differences: Human individuality, scientific psychology, and William Stern’s critical personalism*. Thousand Oaks, CA: Sage.
- Lamiell, J. T. (2006). La psychologie des “traits” dans le cadre de la recherche “néo-galtonien” au vingtième siècle: Comment elle est censée fonctionner, et pourquoi elle ne fonctionne vraiment pas. *Psychologie Française*, 51, 337–355.
- Lamiell, J. T. (2007). On sustaining critical discourse with mainstream personality investigators: Problems and prospects. *Theory and Psychology*, 17, 169–185.
- Molenaar, P. C. M. (2004). A manifesto on psychology as idiographic science: Bringing the person back into scientific psychology, this time forever. *Measurement*, 2, 201–218.
- Popper, K. (2002). *The logic of scientific discovery*. London: Routledge. (Original work published 1959)
- Porter, T. M. (1986). *The rise of statistical thinking: 1820–1900*. Princeton, NJ: Princeton University Press.
- Sanford, N. (1963). Personality: Its place in psychology. In S. Koch (Ed.), *Psychology: A study of a science* (pp. 488–592). New York: McGraw-Hill.
- Skaggs, E. B. (1945). Personalistic psychology as science. *Psychological Review*, 52, 234–238.
- Stern, W. (1900). *Über Psychologie der individuellen Differenzen* (Ideen zu einer ‘differentiellen Psychologie’). Leipzig: Barth.
- Stern, W. (1911). *Die Differentielle Psychologie in ihren methodischen Grundlagen*. Leipzig: Barth.
- Stern, W. (1927). Selbstdarstellung. In R. Schmidt (Ed.), *Philosophie der Gegenwart in Selbstdarstellung* (pp. 128–184). Leipzig: Barth.
- Thorndike, E. L. (1911). *Individuality*. New York: Houghton-Mifflin.

# Chapter 3

## How Methodology Became a Toolbox—And How it Escapes from that Box

Aaro Toomela

*How jelly gets inside a candy? There are three ways:*

1. *Take a small ball of a caramel, cover it with a jelly, and turn inside out;*
2. *Take a small ball of a caramel, drill a hole into it, and fill the hole with a jelly; and*
3. *THE JELLY HAS ALWAYS BEEN THERE*

The understanding that research methodology comprises an essential part of scientific theories about phenomena that are studied is not always brought into the center of theoretical reasoning. The inevitable connection of methodology and statements about the nature of the phenomenon studied becomes obvious when we ask for the proofs of theoretical statements about the phenomenon that a theory should explain. The only scientific way to give the proofs for a theory requires description of the research methodology—who was studied with what assessment methods and which was the exact procedure of data collection. If the analysis of the research methodology reveals questionable procedures or implicit restrictive theoretically not justified assumptions, all theory based on such a methodology must be questioned as well.

### Methodological Status of the Modern Mainstream Psychology

Anokhin—a Russian neurophysiologist and the founder of the functional systems theory, characterized the situation in the field of studies of the conditioned reflex in early 1960s as follows:

Extraordinarily complicating circumstance for the development of a scientific school is the situation where all different kinds of hypotheses, proven, plausible, and even questionable, suddenly acquire the meaning of unbreakable dogmas, absolutely reliable truths. History of science shows that from this moment on usually the progress of scientific research is

---

A. Toomela (✉)  
Department of Psychology  
Tallinn University  
Tallinn 10120, Estonia  
e-mail: aaro.toomela@ut.ee



inhibited, search for new ways is disrupted, growth into extension begins, endless duplication and variation of unimportant experiments without clear signs of generalizations and movement ahead emerges. (Anokhin, 1978b, pp. 154–155, my translation).

Modern mainstream psychology fits this description too well. In the methodological perspective, modern mainstream psychology relies heavily on unproven hypotheses and assumptions. For instance, modern mainstream personality research is based on non-representative samples of undergraduates or participants with exceptionally high level of education (Endler & Speer, 1998; Mallon, Kingsley, Affleck, & Tennen, 1998). It would not be a problem if the theories built on studies of such restricted samples would be constrained to highly educated persons. In modern personality studies, however, it is assumed that findings from restricted samples can be extended to all adults. This extension would be, of course, theoretically possible. But without direct empirical proof for such extension the status of personality theories remains questionable. In fact, personality structure revealed by common to modern mainstream psychology factor analytic methods in persons with low level of education does not correspond to that obtained in studies of highly educated persons (Toomela, 2003c).

This kind of example, however, scratches only the surface of the fundamental problems inherent to modern mainstream psychology. The basic way of thinking does not need to change in order to extend studies to unrepresented groups of humans. Modern mainstream psychology, however, relies on fundamental unproven assumptions that even have not turned into hypotheses but accepted without questioning. One of such assumptions, for instance, is related to the interpretation of data. It is simply *assumed* that all kinds of statistical data analysis methods based on covariation of variables can be used for understanding mental phenomena. Closer analysis of the question whether statistical data analysis can provide theoretically meaningful interpretation of collected data and lead to understanding of studied mental phenomena leads to unwanted conclusion: statistical data analysis methods used in modern mainstream psychology are not suitable for the development of the theory of mental processes (Toomela, 2008b). This fact—maybe controversial at the moment, but absolutely necessary to analyze before continuing with this pervasive today way of studies—would already be sufficient to declare that last 60 years of mainstream psychology have gone astray and majority of studies conducted during this period of time should simply be forgotten as useless for the development of psychology.

This conclusion can be supported by a long list of fundamental theoretical problems, each of them alone sufficient to reach the same conclusion—modern mainstream psychology is founded on erroneous principles. Modern mainstream psychology fails in 11 ways:

1. it is more concerned with isolated facts than with the development of a general theory;
2. focuses mostly on quantitative data;
3. ignores the fact that externally the same environment can psychologically be very different and not only external but also psychological environment must be “controlled” in the studies;

4. studies isolated fragments and ignores the role of a whole where the fragments naturally belong;
5. ignores single cases which do not conform to statistical generalizations based on groups;
6. relies on the analysis of variables and ignores the problem that variables encode information about behavior that may rely on psychologically very different mechanisms;
7. erroneously assumes that lack of covariation between variables is evidence for the lack of causal relationships between phenomena characterized by variables;
8. erroneously assumes that individual mind can be understood by generalizations made over groups of studied persons;
9. studies phenomena without defining the object of studies;
10. “explains” psychical events with past events, such as genes or evolution, without understanding that past can materially have no effect on the present; and
11. ignores dynamic and emergent properties of mind (see for detailed analyses of these issues, in addition to references below, Toomela, 2000a, 2008a,c).

### ***Basic Questions to New Methodology***

Theories about studied phenomena change together with accumulation of knowledge. Therefore, methodology as part of theories must also change. When new aspects of studied phenomena are revealed, it must be asked whether the methodology commonly used corresponds to new theories. The questions that need to be answered are fundamental. Instead of asking whether personality structure as revealed by factor analysis comprises five or some other number of factors, for instance, it must be asked, whether factor analysis based on inter-individual variation is appropriate at all for understanding personality structure. If the answer to that question turns out to be *no* (the answer to that question is no, indeed, cf. Molenaar, 2004; Molenaar & Valsiner, 2005; Toomela, 2008b, 2009b), then entirely different research methodology must be developed.

The new methodology should be built on explication of fundamental assumptions that underlie methodology, as much as possible at the current level of science development. In this book specifically the methodology for studying the dynamic processes is discussed from various perspectives. In order to build theoretically justified dynamic methodology, some important issues must be thoroughly understood before it becomes possible to delineate the main characteristics of the methodology.

The first question to be asked is whether actually the methodology for studying mental and social processes should be dynamic at all. Theoretically it is entirely possible that for understanding phenomena, even if the phenomena themselves are dynamic, there is no need explicitly addressing of dynamics at all. Perhaps it is possible to understand mental and social processes by using some static theoretical constructs alone?

Second question follows from the answer to the first question. If there are theoretical reasons to accept dynamic methodology then what is understood by the term ‘dynamic’ must be clearly defined. Always when there is more than one definition available for the same scientific notion it should be made clear which of the several available definitions is used in the particular theory that incorporates this notion. Otherwise the situation becomes incomprehensible; different scholars use the same name for studying qualitatively different phenomena and, naturally, end up with incompatible interpretations of the studied phenomena. Modern studies of culture, for instance, comprise one such field of psychology where many researchers conduct studies in different countries and assume that such cross-country psychology (Toomela, 2003a) can reveal something about culture. Other researchers, in turn, may study culture as a special kind of an environment that can be different for different persons living in the same country. At the same time, there can be important similarities between certain groups of persons living in different countries; such groups—University students, for example—may be culturally ‘strangers’ in their own country (Marsella, Dubanoski, Hamada, & Morse, 2000; Poortinga & van Hemert, 2001). Cross-country psychology cannot be incorporated into cultural theories where culture is assumed to vary inside a country.

These two questions are addressed in this chapter before delineating the requirements for the dynamic methodology. The approach taken here may look surprising: instead of building entirely new understanding it is assumed here that many answers to these fundamentally important questions can be found not in the future but in the past of psychology. There are strong reasons, however, to suggest that the pre-World-War II Continental-European psychology was theoretically substantially richer than the modern mainstream psychology (Toomela, 2007a, 2007b, 2009a, *in press*).

## **Do Social and Behavioral Sciences Really Need a Dynamic Methodology?**

Human actions—as actions—are dynamic already by definition. It does not necessarily follow, however, that methodology used for understanding these actions needs to aim directly at the dynamicity. Static explanation may still be possible. As with many other notions in psychology, the notions of causality, explanation, and understanding have been defined differently. Theoretical need for static or dynamic kind of explanation can directly be related to differences in understanding of causality.

### ***Modern Mainstream Psychology and Linear Nondynamic Cause → Effect Thinking***

Modern mainstream psychology follows a specific way to understand the notions of causality, explanation, and understanding. I analyzed the content of nine recent

randomly chosen Anglo-American textbooks of psychology (many of them were published several times, up to the 14th ed.). Most of the textbooks declared that the goal of psychology is to describe, understand and explain. Understanding and explaining needs description of causality. With no exception causality was understood in one and the same way: causality is only related to linear cause-and-effect relationships (Atkinson, Atkinson, Smith, Bem, & Nolen-Hoeksema, 1993; Bernstein, Roy, Srull, & Wickens, 1988; Carlson, Buskist, Martin, Hogg, & Abrams, 1997; Feldman, 1993; Gleitman, Fridlund, & Reisberg, 1999; Grusec, Lockhart, & Walters, 1990; Myers, 1995; Roediger, Capaldi, Paris, Polivy, & Herman, 1996; Smith et al., 2003). Such understanding is not limited to introductory textbooks. The same position can be found in professional-level general theoretical accounts of psychology (e.g., Bem & Looren de Jong, 1997; Lakoff & Johnson, 1999) as well as in works particularly dedicated to study of causality in psychology (e.g., Pearl, 2000; Sloman, 2005; Spirtes, Glymour, & Scheines, 2000). As I am going to demonstrate below, such a primitive view on causality hinders the development of the science of mind, psychology.

Cause-and-effect science does not need dynamic methodology at all. All explanations in such science are essentially static. If causality is understood as a linear relationship between a cause and an effect, then all the explanation searched for is reduced to identifying the causes. Event *A* is understood as a cause of another event *B*, if *A* is repeatedly observed before *B*, is contiguous to *B*, and seems to be necessarily related to the *B* (see for philosophical roots of this kind of thinking, Descartes, 1985a,b,c,d,e; Hume, 1999, 2000). Explanation essentially ends with identifying the probable causes. Cause itself in such understanding is static, dynamic aspect of causality is secondary; dynamicity is related only to the process in which cause causes an effect.

There are many constructs in the modern mainstream psychology that essentially are supposed to explain dynamics by static theoretical constructs, by linear efficient causes. Performance on intelligence tests, for example, is explained in the modern mainstream psychology by the static construct of intelligence which is supposed to be bigger or smaller in different individuals. Such quantitative differences are supposed to underlie individual differences in IQ test results (e.g., Mackintosh, 1998). In this context it is important that intelligence test performance always takes place in time and therefore is a dynamic process. Nevertheless, this dynamicity is not relevant for modern mainstream psychology because test performance emerges only as an effect of a static cause, intelligence. Personality is explained similarly in the modern mainstream psychology. According to the dominant today Five Factor Theory of personality, personality system is composed of biologically determined Basic Tendencies—Neuroticism, Extraversion, Openness to Experience, Agreeableness, and Conscientiousness (Allik & McCrae, 2002; McCrae & Costa, 1996, 1999). These basic tendencies are essentially understood as causes of behavioral stability over time and situations. This kind of explanation, even though aimed at understanding human dynamic activities, is static. All dynamicity is explained by static constructs that act similarly over time and situations. This way of reasoning is fully justified in the linear cause → effect thinking because it is assumed that

there are always more effects than causes (cf. Descartes, 1985a,b,c,d,e). Therefore a few identified causes can lead to numerous effects; one personality dimension may cause similar behaviors in many different situations and over time.

### ***Pre-WWII Continental-European Psychology and Dynamic Structuralist Thinking***

There is a fundamental problem with the linear cause → effect thinking. The problem is that the explanations found are not satisfactory. If, for example, we know that a wristwatch was broken because it fell from the table, we would not be able to know whether and if yes, then how, the watch can be repaired. We would need to know something different about the watch—what parts in what relationships should be there in the working watch, and what parts and/or relationships between those parts were altered because of falling. This is another way to conceptualize causation, explanation, and understanding. Philosophical roots of this kind of thinking can be found in Aristotle, who distinguished in *Metaphysics* (Aristotle, 1941) not one but four complementary kinds of causes:

All the causes [...] fall under four senses [...] some are cause as the *substratum* (e.g., the parts), others as the *essence* (the whole, the synthesis, and the form). The semen, the physician, the adviser, and in general the agent, are all *sources of change* or of rest. The remainder are causes as the *end* and the good of the other things; for that for the sake of which other things are tends to be the best and the end of the other things [...] (p. 753).

Usually in modern philosophical literature these four causes are named *material cause*, *formal cause*, *efficient cause*, and *final cause*, respectively. Linear cause → effect thinking assumes that causality is fully covered by the efficient cause. Aristotelian way of thinking was adopted, in a modified version, by scholars in the pre-WWII psychology. The beginning of the modern psychology is usually associated with the first experimental psychology laboratory in psychology opened by Wilhelm Wundt in 1879 at the University of Leipzig, Germany. According to Wundt (1897), attributes of psychical causality can be discovered by studying Psychological Elements, Psychological Compounds, Interconnections of Psychological Compounds, and Psychological Developments. Only on the basis of knowledge from studying the mentioned aspects of mind, Psychological Causality and its Laws can be formulated: “There is only *one* kind of causal explanation in psychology, and that is the derivation of more complex psychical processes from simpler ones.” (Wundt, 1897, p. 24, emphasis in the original). So, dynamicity—Psychological Developments—was an essential part of explanation already in Wundt’s thinking.

The view according to which mind can be understood as a hierarchically developing whole composed of distinguishable elements in specific relationships is called *structuralism* (Titchener, 1898, 1899). Structuralist position was taken by many eminent psychologists in the end of the 19th and the beginning of the 20th century, such as Kirkpatrick (1909), Koffka (1935), Köhler (1959), Külpe (1909), Ladd (1894), Sully (1892), Vygotsky (1994), Vygotsky and Luria (1994), Werner

(1948), and Wertheimer (1925). Thus, structural position was widespread and shared by many among the most eminent psychologists of the time. It might be mentioned that even though the basic principles were shared by many, there were some differences in emphasis. Gestalt psychologists, for example, emphasized the characteristics of the whole in their theory. Nevertheless, Gestalt psychology was essentially structural:

In psychology we may go so far as to say that one of the main tasks of Gestalt psychology is that of indicating the genuine rather than fictitious parts of wholes (Köhler, 1959, p. 98).

Structuralist thinking that characterized especially pre-WWII Continental-European psychology, has been practically abandoned by the mainstream psychology since about 1950s. It is important to mention, that there seems to be no scientific reasons to replace structuralist thinking with oversimplified linear cause → effect thinking (cf. Toomela, 2007a). Actually on the contrary, it seems that most important discoveries made by eminent mainstream psychologists during last half of a century turn out to be rediscoveries of principles well known to Continental-European psychologists before the WWII (Toomela, *in press*). The only justified reason I have been able to find for accepting only cause → effect thinking was provided by David Hume. According to him, the reason why only this kind of knowledge should be searched for is human ignorance! He declared that it is simply impossible to know anything beyond direct sensory observation of relationships between objects in the world; there is no way to know anything about the essence of hidden from direct observation “causal powers” as he called them (Hume, 1999, 2000). This position is obviously contrary to the spirit of any scientific pursuit for understanding.

It is interesting that even Humean thinking may lead to the study of dynamicity. In his era time was understood by many as composed of independent sequential particles. Following from this idea Hume (2000) wrote in 1740:

‘Tis evident, that time or duration consists of different parts: For otherwise we cou’d not conceive a longer or shorter duration. ‘Tis also evident, that these parts are not co-existent: For that quality of the co-existence of parts belongs to extension, and is what distinguishes it from duration. Now as time is compos’d of parts, that are not co-existent; an unchangeable object, since it produces none but co-existent impressions, produces none that can give us the idea of time; and consequently that idea must be deriv’d from a succession of changeable objects, and time in its first appearance can never be sever’d from such a succession (p. 29).

So, Hume clearly distinguished between static and dynamic aspects of the world. More importantly, he also suggested that dynamic world—that takes place in successive time—is related to *change* of objects in the world. Hume did not deny that world beyond sensory perception is complex; he acknowledged repeatedly that externally similar event can be based on hidden from direct observation different processes. He only denied the possibility that humans are ever able to understand these hidden powers. Structuralist thinking is an attempt to conceptualize the hidden from direct observation processes. Modern science is full of examples how phenomena in the world are explained structurally—phenomena are understood as qualitatively novel wholes that are composed of distinguishable (not separable!) elements in specific relationships. Often this way of thinking is also called systemic (von Bertalanffy,

1968). Physical objects are understood as wholes composed of atoms which, in turn, are built from subatomic particles; genetic processes are understood with the help of the theory of a gene; human body is understood as a system of interacting organs; all chemistry is structuralist to the roots. Modern medicine is based on structuralist-systemic thinking as well (Toomela, 2005). At the most basic level, psychology should not be different from other sciences because all sciences, including psychology, search for understanding and explaining the world beyond senses. There is no scientific reason to assume that psychology should be constrained to efficient causal thinking when in all other sciences structuralist-systemic conceptualization of causation, understanding, and explanation has been remarkably efficient. Analysis of the pre-WWII psychology also demonstrates that structuralist psychology was theoretically much ahead of the modern mainstream psychology (Toomela, 2007a, 2007b, 2009a, in press).

### ***Where is Dynamics in Structuralist-Systemic Explanation?***

Structuralist explanations may, superficially, seem static because structuralist position holds that no explanation can be sufficient without description of the structure of the studied phenomena—what are the elements and in which relationship that comprise the whole. This part of explanation is necessary indeed, because there is no way to conceptualize a process without description of a structure.

I am aware that many modern psychologist would suggest that they are studying processes and it is wrong to talk about static structures at all (e.g., Smith & Thelen, 1993; Thelen, 1995; Thelen & Smith, 1994). But let us try for a moment to construct an understanding of a process without using any concept that would refer to a structure; all concepts that would refer to distinguishable parts of the world would not be allowed in that case. What if we would like to try to understand sensory processes, vision, for instance? We know that a process of light-wave ... no, can we talk about light-wave because light seems to be corpuscular and field phenomenon at the same time? ... but OK, light is a field phenomenon and therefore maybe (I would not be so sure about that) a pure process, and we can begin in this way ... we know that a light-wave that enters the eye ... no, *eye* is not allowed as an element of the biological organism, no eye, therefore ... a process of light-wave interacts with the biological (is *biological* actually allowed because it implies biological organisms?) electrochemical (maybe *chemical* is also not allowed because chemistry is structural science?) processes; in the process of interaction of these two processes a process of sensation emerges; first interaction between simple processes ... no, *simple* is a dangerous term because we need criteria for distinguishing between simple and complex; how to do that without structural language, I am not aware of ... so ... first interactions between earlier processes take place; and then later these earlier processes interact with later processes that are also biological electrochemical processes; in these biological electrochemical processes psychological processes emerge, etc. Looks nonsense to me. Summing up, there seems to be no

way to explain processes without using any concept that would refer to some structure. The opposite, however, is entirely acceptable—structures can be described without mentioning processes. Therefore, structural thinking is essential part of any understanding.

There are some principles fundamentally important that explain why we need to describe structure in explanation of a dynamic phenomenon. First, structure constrains processes; not every process is possible with the particular structure. There is no way to make a stone alive without completely changing its structure, without making it a not-stone; there is also no way for a human anencephalic person to become conscious about oneself. The world is full of such structural constraints on processes. Therefore processes cannot be understood without describing structural limitations to them.

Second, pure process theory is completely unable to explain any change; we can name different processes, but explanation requires more. This ‘more’, again, comes with structural description. In structuralist theory, change can be related to one of two kinds: Either an element is included or excluded from the existing structure or the relationships between the same elements change. A wristwatch can contain all and only necessary parts, but if these parts are in wrong relationships, the watch will not show time. So, in structural theory change can be understood only as a change in structure; even more, the only (structuralist, not primitive efficient) cause for a change is related to temporal, successive change of elements of a structure and/or relationships between structural elements. Watch would never brake if there would be neither changing relationships between elements of it nor changing relationships between a watch as a whole with the surrounding environment.

Taken together, structuralist position holds that there is no understanding possible without describing static in a certain time-period structure. Structural theory, nevertheless, also explains why and in which sense structural theory must inevitably be dynamic. The reason is that properties of elements change when they enter into a hierarchically higher level whole (Koffka, 1935; Köhler, 1959; Vygotsky, 1982b, 1994; see also Toomela, 1996). Without clothes, humans would not survive long in Nordic winter. The same human is not the same after putting clothes on. The clothes are not the same too any more; socks start to move together with a hat, for instance, when they are both on the person. Here lies the reason why structural theory must be dynamic: the elements of a structure must be described before they enter the structure; otherwise we are not able to distinguish what properties characterize an element as such and what properties of an element emerge because the element is already included into the whole. In other words, coherently structural theory must be developmental; elements should be observed before they enter the whole, in the process when they enter the whole, and when they already are in the new whole.

Before going further, two more dynamic structural concepts needs to be introduced. First, in psychology it has been discovered a long time ago that externally similar behaviors may rely on different directly unobservable psychic processes and externally different behaviors may stem from the same underlying process (e.g., James, 1950; Koffka, 1935; Lewin, 1935; Toomela, 2008b; Vygotsky, 1996; Vygotsky & Luria, 1994; Werner, 1948). In structural terms it means that different



mental structures may underlie externally similar behaviors (e.g., Luria, 1969, 1973). So, the next aspect of structural dynamics is related to development—the particular composition of structures that underlie externally similar processes can change in phylogenesis as well as in ontogenesis. We need to agree with Hume that the only way to acquire any knowledge about world is through senses, through observing processes of the world. The major difficulty emerges when we need to reveal a composition of more than one hidden from direct observation structure if these different structures underlie externally similar processes. A scientist actually has a more fundamental difficulty; first it is necessary to discover at all that externally similar processes are based on internally different structures. So dynamic methodology needs to face this difficulty as well.

And second, mental and corresponding behavioral processes evolve in time. Therefore particular composition of mental and behavioral structures active at any given moment change in real time. This rule of functioning characterizes both non-human (e.g., Anokhin, 1975, 1978a) and human (e.g., Luria, 1969, 1973) mental and behavioral acts.

## How to Conceptualize Dynamics?

### *Linear Efficient Causal Approach to Dynamics*

Different views to causality and explanation that can be identified in psychology—linear efficient cause and structural—imply different views on how to understand what are dynamics, change, and development. Modern psychology warded off the developmental perspective from its theoretical core, questions are asked about being (ontology) of psychological phenomena but not about their becoming (Valsiner, 2003). This characteristic of the modern mainstream psychology can be understood as resulting from the oversimplified efficient causal thinking. In efficient cause thinking all the explanation and understanding becomes reduced to identification of causes. This kind of explanation itself, as was already shown by Hume (2000), is static:

The relation of cause and effect [... ..] *The objects it presents are fixt and unalterable. The impressions of the memory never change in any considerable degree; and each impression draws along with it a precise idea, which takes its place in the imagination, as something solid and real, certain and invariable.* (p. 76, my emphasis).

This way of thinking is essentially static because time dimension is excluded from the explanation. Causes are assumed to precede effects, including the effect being an emergence of novelty; if explanation is constrained to description of causes then there is no question how exactly cause leads to an effect, the process of the emergence of the effect is irrelevant to a theory. All dynamic questions are in this way excluded from the theories.

Observations of changes in the studied phenomena cannot always be understood by simply identifying causes. Apparently the hardest situation to cope with in this

respect is met by psychologists who are supposed to study development. Efficient causal thinking can accept one kind of change, which is quantitative change. Novelty is always explained by the effect of some static ‘causal powers’ to use a Humean term; in situations when such explanation turns out to be insufficient it is simply stated that all the change is related to quantitative growth. This kind of explanation replaced, for instance, structural stage theories with theories of quantitative growth around 1970s (see on different conceptualization of developmental stages, Toomela, 2000c).

To further support the link between efficient causal thinking and non-developmental nature of theories based on such thinking another interesting phenomenon in the history of psychology is relevant. Before the WWII, theory of brain and brain-mind relationships was in the periphery of psychology. This issue was discussed, of course, but as a separate question the answer to which would not change fundamentally theories of mind of that time (cf. e.g., Koffka, 1935; Köhler, 1940, 1959). In modern mainstream psychology the studies of brain and brain-mind relationships became increasingly important. It seems more and more that the only really “scientific” psychology in modern times is biological psychology. Nowadays, the majority of the most cited psychologist are either in the field of neuropsychology or genetics (cf. Toomela, 2007b) This increasing emphasis on “biological bases” of psychological processes is a natural consequence of efficient causal thinking. On the one hand, causes are material, they need to exist somewhere. On the other hand, emergence of novelty must be reduced to some cause that preceded the effect in time. These two propositions lead to the search for the place where causes are present before the phenomenon is observed. And what does exist before the phenomenon of mind is biological body, and nervous system as part of the body directly connectible to psychological processes. Therefore the brain must be the ultimate cause of all mental processes. There is no need to answer the question how exactly brain became able to be a cause of mind; it is sufficient to attribute this potential to some never explicated process that took place somewhere earlier in time, in evolution. So, essentially, modern mainstream psychology based on efficient causal thinking is forced to believe that, for every individual, the causes of mental processes have always been there, in the brain. And the psychology becomes reduced to finding these ultimate causes in the brain or in hereditary mechanisms that determine the properties of the brain. Modern Five Factor Theory, for instance, “explains” personality exactly in this way (Allik & McCrae, 2002; McCrae & Costa, 1996, 1999). This illuminating for efficient causality thinking explanation is not an explanation for structuralist thinking at all; on the contrary, such identified connection between a cause and an effect needs an explanation itself.

### *Other Approaches to Dynamics*

As the motto of this chapter shows, this kind of belief is not the only way to explain phenomena around us. The jelly, indeed, may always have been in the candy, and the personality dimensions or intelligence may always have been in the individual’s

brain or genes, but there are other possibilities of explanation as well. For psychology, these other possibilities are based on the idea of dynamics, change and emergence of novel phenomena. Structural psychology would explain emergence by introduction of new elements to the system and/or change of relationships between existing already in the system elements. Modern stage theories of development, for example, do not assume that all developmental change is related to quantitative growth; rather, development is related to differentiation and reintegration of the differentiated elements of the developing mind (e.g., Case, 1992; Fischer & Bidell, 1998; Toomela, 2003b). It is noteworthy in this context, that these modern theories all have their roots in pre-WWII Continental-European psychology, particularly in Piagetian and/or Vygotskian thinking.

In this context it would be inappropriate not to mention one increasingly popular today approach to the study of mind, dynamic systems approach. Dynamic systems approach tries to explicitly to address the issues of dynamics in different processes. Closer analysis of dynamic systems approach, however, reveals fundamental theoretical problems related to it (cf. e.g., Smith & Thelen, 1993; Thelen, 1995; Thelen & Smith, 1994; and Chapters 26, 27 in this book). Detailed analysis of these problems is beyond the scope of this chapter. Nevertheless, three questionable practices of that approach that first come to mind can be mentioned:

1. dynamic systems approach studies processes and sometimes implicitly, sometimes explicitly, denies the need for studying structural bases of the processes. I already described above, why nonstructural process-oriented approaches are misleading.
2. dynamic systems approach is mostly based on statistical analysis of variables. This approach is theoretically misleading too (Toomela, 2008b).
3. dynamic systems approach acknowledges the idea that changes observed in studied phenomena can be non-linear. But there is more than one kind of non-linear dynamics. Dynamic systems approach usually acknowledges only continuous changes whereas structural approach would mostly characterize many changes as discontinuous. So, for a dynamic systems approach it is entirely legitimate to talk about the size of some influence. For instance, in dynamic systems approach there can be “small” influences related to “big” changes. Qualitative changes, however, are qualitative, small or big are quantitative characteristics which may lack any qualitative interpretation altogether. Non-continuous qualitative changes, that characterize structural reorganizations, are as a rule ignored by dynamic systems approach. According to structuralist theory, together with abandoning the notion of non-continuous qualitative change, understanding of emergence, birth of novelty would be abandoned too.

In addition to these problems, there seem to be others. For instance, several fundamental concepts of the dynamic systems approach, such as ‘attractor’ or ‘self-organization’ are too vaguely defined for understanding real world phenomena even if the definitions of these concepts are clear mathematically. Also, dynamic systems approach does not define the notion of ‘process’ clearly enough. In this approach processes can be assumed to be causes; for instance, Chapter 26 in this book suggest

that “Individual differences in cortical architecture are neither due to genetic nor to environmental influences, but are caused by nonlinear developmental processes.” Ontological status of ‘process’ should be made clear here. For a structural approach process or a change cannot be a cause of anything, rather, process is characteristic of a structure changing in time.

Taken together, I believe dynamic systems approach that has aimed to explain developmental processes, dynamics, is not able to reach this aim. There are too many fundamental questions related to this approach that need to be answered before the power of it could be demonstrated.

## **Efficient Causality Epistemology and its Research Methodology**

### ***Toolbox Methodology of Research in Modern Mainstream Psychology***

Modern mainstream psychology mainly searches for explanation and understanding in the framework of efficient causality; identification of causes of psychological events is its main aim. As mentioned above, event *A* is understood as a cause of another event *B*, if *A* is repeatedly observed before *B*, is contiguous to *B*, and seems to be necessarily related to the *B*. In efficient causality thinking, it is implicitly today and explicitly in the philosophical roots of this kind of thinking (cf. Hume, 1999, 2000), accepted that it is impossible to understand the real causal powers hidden from direct observation; the only basis for discovering causal relationships is repeated observation of relationships between two contiguous events, one, a cause, preceding the other, the effect.

I am aware that modern mainstream psychologists would disagree with this statement; they would claim that their aim is explanation that goes beyond identification of causes. In majority of cases—and it is majority that determines the mainstream—this is not true. If we analyze theories modern mainstream psychology proposes, we discover in most instances that the psychological phenomena are eventually explained by the presence of some construct, such as intelligence, dimensions of personality, values, attitudes, etc., that are not further explained by themselves. If further explanation is searched for, then they are searched in phenomena that causally (only efficient causality is covered with this notion here) precede the explaining construct. So, intelligence and personality dimensions are explained by genes which, in turn, are explained by evolution. Values and attitudes are often explained similarly, but the “causes” are found in the environment, in social relationships and culture.

Limited efficient causality epistemology of research is directly related to very limited understanding of research methodology. Differently from other sciences, in modern psychology it is assumed that one and the same kind of methodology can be applied to all studied phenomena independently of the nature of what is studied.

This methodology is quantitative; statistical data analysis becomes almost the only acceptable research tool. All study procedures are constructed and data are collected in the way that allows the data to be analyzed statistically. What is searched for in such statistical analyses follows naturally from efficient causality epistemology: covariation of events. For this epistemology identification of covariation between events encoded in variables is the main aim, causes are identified on the basis of it.

Accumulation of observations forces the researchers to the conclusion that simple linear cause-effect explanation is sometimes too clearly in contradiction with the observations. Instead of looking for other kinds of research methodology, the same methodology is developed further. So simple pairwise correlation became insufficient and correlational procedures were and are developed further. Now we have not only relatively simple Multiple Regression, Canonical Correlation, and Factor Analysis procedures but also increasingly complex methods of Structural Equation Modeling and several other sophisticated methods to discover or to “confirm” complex patterns of covariations. Different statistical techniques for comparison of group means are essentially identical to correlational procedures; in comparison of group means covariation between group membership and other variables is searched for.

Research in this efficient causality epistemological frame becomes methodologically independent of the phenomena studied. All what is needed to know for conducting research is a collection of statistical data analysis procedures and a list of ways how to create variables that can be analyzed in this way. Modern mainstream psychology ignores the facts that clearly show the inadequacy of the toolbox methodology, the methodology which basically ignores the characteristics of the phenomena studied.

For instance, modern understanding of test validity is based on numerous statistical procedures for discovering covariations between test items or between a test and some other criterion test. The fundamental question is, is this approach appropriate for psychology? Asking this question gives an unwanted answer: the only question about validity is whether a measurement tool measures what it is intended to measure or not; and correlational procedures are not adequate for studying validity (Borsboom, Mellenbergh, & van Heerden, 2004).

Another, more general question to be asked is whether information encoded in variables can in principle allow unambiguous interpretation of them through statistical data analysis. Answering this question leads to the need for a new kind of methodology because the analysis of the ontology and epistemology of a variable shows that variables used in psychology cannot be interpreted unambiguously. Therefore no statistical procedure, that operates with ambiguously defined variables—practically all modern quantitative psychology—turns out to be theoretically noninterpretable (Toomela, 2008b).

From yet another perspective, the question to be taken seriously by the modern mainstream psychology should be whether the modern way of interpreting data at the group level can be adequate for understanding individuals. Psyche, after all, is a phenomenon that exists at the level of an individual. Group level analyses turn out to be inadequate too (Molenaar, 2004; Molenaar & Valsiner, 2005; Toomela, 2009b).

### *Are There Reasons to Look for Future Methodology in the Past?*

In the course of the development of a science it would be natural to discover again and again that new theories do not correspond to old methodologies and most fundamental questions need to be asked again and answered in novel ways. Human understanding develops and old understanding needs to be replaced by a new kind of understanding (Kuhn, 1970; Vygotsky, 1982a). Psychology seems to be in a curious situation where many necessary questions and answers should be searched for not in the future but in the past of the science, particularly in the pre-WWII Continental-European psychology. That older psychology was explicitly structural, dynamic-developmental, and—explicitly and in a theoretically justified way—rejected the oversimplified associationist psychology that was built on efficient causality epistemology. Roots of structural thinking that takes emergence, change and development to be the fundamental concepts for all theories, can be traced back at least to dialectical thinking of Hegel. For him, the first Notions of his scientific logic were *being* and *nothing* and *becoming*; the concept of emergence was central to his philosophy. He also required that theories should always be developmental:

Thoroughness seems to require that the beginning, as the foundation on which everything is built, should be examined before anything else, in fact that we should not go any further until it has been firmly established and if, on the other hand, it is not, we should reject all that follows. (Hegel, 1969, p. 41).

Gestalt psychology took as one of its most important theoretical concepts the idea of wholeness: wholes have qualities that do not characterize its elements. In this kind of thinking not only linear but also non-linearly continuous explanations would be inadequate; what was necessary to understand was the emergence of entirely novel qualities, the explanations need to explain discontinuities. The explanations in Gestalt psychology contained structural ideas of elements, relationships between elements, and emergent hierarchically higher level wholes. Pre-WWII Austrian-German psychology was one of the centers of structuralist thinking (cf. Toomela, 2007a, 2009a; Watson, 1934). The other centre became Russian psychology, especially the cultural-historical school of psychology founded by Vygotsky and developed by Luria and others (Luria, 1969, 1979; Toomela, 1996, 2000b, 2003a; Vygotsky, 1982b, 1994; Vygotsky & Luria, 1994) and functional-systemic school of neurophysiology (Anokhin, 1975, 1978a).

In this context it becomes a question how and why psychology rejected the fruitful methodological and theoretical principles common to pre-WWII Continental-European psychology and restricted thinking to fundamentally limited efficient causality epistemology and corresponding statistical quantitative methodology. There seems to be no rational reason for that change to take place (Toomela, 2007a). Already more than a century ago, it was suggested, “it is clear that the theory that antecedence and consequence are the sole content of the idea of causation fails altogether to square with the facts of life and nature” (Carliile, 1895b, p. 224; see also Carliile, 1895a). Nevertheless, cause-and-effect science became dominant in psychology after the WWII. The space limits do not permit to analyze in this chapter the possible reasons

as to why more developed thinking was replaced with less developed thinking in psychology. It is worthy to mention, though, that modern mainstream psychology has been historically and geographically “blind” during last half of a century; most important “discoveries” of modern psychology turn out to be rediscoveries of what was known by earlier scholars (Toomela, [in press](#)). Therefore it is justified to ask whether history can be a source for methodological ideas that would be novel in the modern context. The aim of such historical approach, would not be a call for doing psychology in the old way but rather a call for understanding that not everything that is new is better than the old and not everything that disappeared in the history of psychology disappeared for rational reasons (Toomela, [2007b](#)).

### ***Characteristics of Structuralist Dynamic Methodology***

The aims of the structuralist thinking are related to the understanding of structures; this understanding requires description of the elements of a structure, specific relationships between the elements, and qualities of the emergent whole. Elements, however, change in qualities when included into a higher order whole. Next, externally similar behaviors are often based on internally different mental structures, these structures change in phylogenesis and ontogenesis. Furthermore, mental processes and behaviors evolve in time; at different moments the same behavior and mental act underlying it, is also structurally different. Therefore structuralist methodology must be dynamic to the roots: it is necessary to study elements before the enter a whole; it is necessary to study the process in which the elements are organized into an emergent whole; and it is necessary to study the emergent whole itself. In other words, structuralist methodology must be developmental.

I even will not pretend that I am able to provide a full theoretical coverage of methodological issues necessary to understand for building a systematically dynamic-structural research methodology. The biggest challenge the science of psychology faces, I believe, is related to the structuralist understanding that psychologists are studying a whole, a whole of mind. It follows that study of every single aspect of mind must be conducted in the framework of understanding where exactly this studied aspect stands in the whole structure of mind. In other words, we need a unified theory of psychology; without such unified theory psychology cannot lead to understanding of mind in principle (Toomela, [2007c](#)). So far, we do not have such theory.

Next, structuralist methodology is based on understanding that methodology is an essential part of the theories about phenomena. Contrary to current modern mainstream practice of using basically the same methodology for studying everything, we need a methodology that corresponds to the studied phenomena. Methodological and substantial parts of a theory interact: substance is constrained by methodology and methodology depends on our current level of understanding the substance. Last 60 years have been dedicated mostly to identification of efficient causes of mental phenomena; this knowledge is not very useful for understanding

the hidden from direct observation secret powers, if to use Humean terminology, themselves. Therefore, our understanding of substance of mind is too limited to allow full understanding the methodology we need.

Nevertheless, I believe there are some methodological principles that should be followed; all these principles, more or less directly, stem from structuralist epistemology of the pre-WWII Continental-European psychology. In this chapter I scratched only a tip of the iceberg of theoretical questions related to the issues of causality, explanation, and understanding—the issues that underlie all scientific enterprises. All methodological issues need also thorough theoretical justification that is not possible to provide in this chapter for two reasons. One is the simple reason of space limitations and the other is a simple limitation of the author's current ignorance level. Therefore I only provide a kind of cook-book recipe list of principles that I have discussed in more details elsewhere. I have no reasons to believe that this list includes all necessary elements. But equally I have reasons to believe that these principles are important to follow. Here is the list. The list is constructed so that every next principle is more and more concrete, specific to the study of psychology. It is also important that none of the principles should be isolated from others; all principles can be fully understood only in the context of the other principles in the list.

First, methodology of research must be theoretically justified at different levels of analysis. The most general level of analysis is related to the issues of the nature of causality, understanding, and explanation. Structural-dynamic methodology assumes that scientific explanation is a description of structure; that description includes the description of elements that comprise the whole, specific relationships between these elements, and the emergent properties of the whole.

Second, elements can be described only before they enter the structure, therefore the research methodology is developmental-dynamic. Elements must be studied before they enter the whole, in the process of synthesis of the whole, and in the emerged whole. (See for a discussion of these first two issues this chapter and in Toomela, 1996, 2000b,c, 2003a,b).

Third, following from the principles of the structuralist theory, an element is understood as part of a whole. Therefore understanding requires a unified theory, theory that explicates the characteristics of a whole (Toomela, 2007c; Vygotsky, 1982a).

Fourth, there can be no methodology adequate for studying everything. Particularly, quantitative-statistical variable-based methodology should be rejected as inappropriate for understanding mind. Sufficient reason for this rejection is structuralist understanding that similar wholes can be built from different elements and different wholes can be built from similar elements. In psychology it means that externally the same behaviors may rely on internally different psychological structures and different behaviors may emerge from the same psychological structures. Variables encode information about behaviors, not about psychological processes per se. Therefore variables used in psychology cannot be interpreted unambiguously; and no statistical data analysis procedure can reduce this ambiguity of variables (Toomela, 2008b). The methodology psychology needs, must be qualitative. This



qualitative methodology must be based on series of single-case studies (Toomela, 2009b) with tools and procedures that correspond to the phenomena studied.

Fifth, qualitative methodology needed, is different from modern understanding of qualitative research. Modern mainstream methodology in most cases rejects the need for interference with study situations; data are based only on direct or indirect observations. However, any observation without experiment or theoretically justified interference with the research situation is open to the fallacy of “subjectivity.” Structural qualitative psychology must go beyond mere observation, to experiment or theoretically justified constraining of the study situation for the reason already mentioned—only behaviors can be observed, but behaviors externally similar may rely on internally different psychological structures and vice versa. Without constraining study situations it is not possible to distinguish between different psychological structures that manifest in similar behaviors (Toomela, 2009a,b).

Sixth, theory must contain only components which existence is proved; operational definition of entities with research tools used in studies is inadequate. This requirement is often not followed in modern theories. Instead, very often it can be suspected that explanatory constructs are abstractions with no explicated connection to existing elements of mental structures. We should be aware that research methodology in many cases can lead to construction of nonexistent in studied phenomena entities. Factor analysis on group data, for instance, can create prototypical abstractions that characterize no single individual studied (Toomela, 2008b). If we find in some theory constructs, such as conscientiousness in personality psychology, we need to ask whether conscientiousness really exists in every individual. And, of course, we need to define explicitly, what it means to have conscientiousness as an entity in mind. The other side of the same requirement would be to define, what it means *not to have* such and such an entity in the mind. If there is a true entity, then it must be possible to observe situations where the entity is not included in a whole. This definition must not be operational; structure of the measurement tool cannot be theoretical justification for the existence of an entity or element as it is assumed in modern personality or intelligence psychology.

Seventh, interaction between substance and methodological parts of theories implies that theoretical substance concepts must also be explicitly defined. This problem is especially serious in psychology where we find numerous qualitatively different definitions for a notion. Among them, emotion (Kleinginna & Kleinginna, 1981a), motivation (Kleinginna & Kleinginna, 1981b), culture (Kroeber & Kluckhohn, 1952), intelligence (Jensen, 1998), and personality (Allport, 1937) to mention just some of the common concepts used in modern psychology. If, for example, a cross-country psychologist (cf. Toomela, 2003a) believes that comparison of groups of individuals from different countries reveals something about culture then results of such studies cannot be meaningfully incorporated into cultural theories in which culture is understood as a kind of environment that can vary inside countries or even inside individuals. Without explicitly showing which of the numerous definitions and why underlies studies it is not possible to build appropriate research methodology (Toomela, 2009a).

Finally, methodology that looks for “proofs” for a theory mainly by increasing the number of observations is not acceptable. Support for a theory and theoretical

generalization comes not from blind replication of study results by increasing the number of participants of a study but through testing the explicated in theory qualitative predictions in multiple qualitatively different settings, in as diverse contexts as theoretically justified (Toomela, 2009b).

## References

- Allik, J., & McCrae, R. R. (2002). A five-factor theory perspective. In R. R. McCrae & J. Allik (Eds.), *The five-factor model of personality across cultures* (pp. 303–322). New York: Kluwer Academic.
- Allport, G. W. (1937). *Personality. A psychological interpretation*. New York: Henry Holt and Company.
- Anokhin, P. K. (1975). *Ocherki po fiziologii funktsional'nykh sistem*. Moscow: Medicina.
- Anokhin, P. K. (1978a). *Izbrannyje trudy. Filosofskije aspekty teorii funktsional'noi sistemy*. In F. K. Konstantinov, B. F. Lomov, & B. V. Shvyrkov (Eds.), Moscow: Nauka.
- Anokhin, P. K. (1978b). Metodologicheskii analiz uslovykh problem uslovnogo refleksa. (Methodological analysis of central problems of the conditioned reflex). In F. V. Konstantinov, B. F. Lomov, & V. B. Shvyrkov (Eds.), *P. K. Anokhin. Izbrannyje trudy. Filosofskije aspekty teorii funktsional'noi sistemy* (pp. 152–206). Moscow: Nauka. (In Russian. Original work published 1963)
- Aristotle (1941). *Metaphysics*. In R. McKeon (Ed.), *The basic works of Aristotle* (pp. 681–926). New York: Random House.
- Atkinson, R. L., Atkinson, R. C., Smith, E. E., Bem, D. J., & Nolen-Hoeksema, S. (1993). *Introduction to psychology* (11th ed.). Fort Worth: Harcourt Brace College Publishers.
- Bem, S., & Looren de Jong, H. (1997). *Theoretical issues in psychology*. London: Sage.
- Bernstein, D. A., Roy, E. J., Srull, T. K., & Wickens, C. D. (1988). *Psychology*. Boston: Houghton Mifflin.
- Borsboom, D., Mellenbergh, G. J., & van Heerden, J. (2004). The concept of validity. *Psychological Review*, *111*, 1061–1071.
- Carlile, W. (1895a). Reality and causation. Part I. *Mind*, *4*, 82–91.
- Carlile, W. (1895b). Reality and causation. Part II. *Mind*, *4*, 213–224.
- Carlson, N. R., Buskist, W., Martin, G. N., Hogg, M., & Abrams, D. (1997). *Psychology. The science of behaviour. European adaptation*. Harlow, England: Allyn and Bacon.
- Case, R. (1992). *The mind's staircase. Exploring the conceptual underpinnings of children's thought and knowledge*. Hillsdale, NJ: Lawrence Erlbaum.
- Descartes, R. (1985a). Meditations on first philosophy. In J. Cottingham, R. Stoothoff, & D. Murdoch (Trans.), *The philosophical writings of Descartes* (Vol. 2, pp. 3–62). Cambridge, UK: Cambridge University Press. (Original work published 1641)
- Descartes, R. (1985b). Objections and replies. In J. Cottingham, R. Stoothoff, & D. Murdoch (Trans.), *The philosophical writings of Descartes* (Vol. 2, pp. 66–397). Cambridge, UK: Cambridge University Press. (Original work published 1641)
- Descartes, R. (1985c). The passions of the soul. In J. Cottingham, R. Stoothoff, & D. Murdoch (Trans.), *The philosophical writings of Descartes* (Vol. 1, pp. 326–404). Cambridge, UK: Cambridge University Press. (Original work published 1649)
- Descartes, R. (1985d). Principles of philosophy. In J. Cottingham, R. Stoothoff, & D. Murdoch (Trans.), *The philosophical writings of Descartes* (Vol. 1, pp. 179–291). Cambridge, UK: Cambridge University Press. (Original work published 1644)
- Descartes, R. (1985e). Rules for the direction of the mind. In J. Cottingham, R. Stoothoff, & D. Murdoch (Trans.), *The philosophical writings of Descartes* (Vol. 1, pp. 9–78). Cambridge, UK: Cambridge University Press. (Composed in 1628)
- Endler, N. S., & Speer, R. L. (1998). Personality psychology: Research trends for 1993–1995. *Journal of Personality*, *66*, 622–669.

- Feldman, R. S. (1993). *Understanding psychology*. (3rd ed., International edition). New York: McGraw-Hill.
- Fischer, K. W., & Bidell, T. R. (1998). Dynamic development of psychological structures in action and thought. In R. M. Lerner (Ed.), *Handbook of child psychology. Vol. 1: Theoretical models of human development* (5th ed., pp. 467–561). New York: Wiley.
- Gleitman, H., Fridlund, A. J., & Reisberg, D. (1999). *Psychology* (5th ed.). New York: Norton.
- Grusec, J. E., Lockhart, R. S., & Walters, G. C. (1990). *Foundations of psychology*. Toronto: Copp Clark Pitman.
- Hegel, G. W. H. (1969). Science of logic. In H. D. Lewis (Ed.), *Hegel's science of logic*. New York: Humanity Books. (Original work published 1831)
- Hume, D. (1999). An enquiry concerning human understanding. In T. L. Beauchamp (Ed.), *David Hume. An enquiry concerning human understanding*. Oxford: Oxford University Press. (Original work published 1748)
- Hume, D. (2000). A treatise of human nature. In D. F. Norton & M. J. Norton (Eds.), *David Hume. A treatise of human nature*. Oxford: Oxford University Press. (Original work published 1739–1740)
- James, W. (1950). *The principles of psychology. Authorized edition in two volumes*. New York: Dover Publications. (Original work published 1890)
- Jensen, A. (1998). *The g factor. The science of mental ability*. Westport: Praeger.
- Kirkpatrick, E. A. (1909). *Genetic psychology. An introduction to an objective and genetic view of intelligence*. New York: MacMillan.
- Kleinginna, P. R., & Kleinginna, A. M. (1981a). A categorized list of emotion definitions, with suggestions for a consensual definition. *Motivation and Emotion*, 5, 345–379.
- Kleinginna, P. R., & Kleinginna, A. M. (1981b). A categorized list of motivation definitions, with a suggestion for a consensual definition. *Motivation and Emotion*, 5, 263–291.
- Koffka, K. (1935). *Principles of gestalt psychology*. London: Routledge & Kegan Paul.
- Kroeber, A. L., & Kluckhohn, C. (1952). Culture: A critical review of concepts and definitions. *Papers. Peabody museum of archaeology and ethnology* (Vol. 47, pp. 1–223). Cambridge, MA: Harvard University.
- Kuhn, T. S. (1970). *The structure of scientific revolutions*. Chicago: The University of Chicago Press.
- Külpe, O. (1909). *Outlines of psychology*. London: Swan Sonnenschein.
- Köhler, W. (1940). *Dynamics in psychology*. New York: Washington Square Press.
- Köhler, W. (1959). *Gestalt psychology. An introduction to new concepts in modern psychology*. New York: Mentor Books.
- Ladd, G. T. (1894). *Psychology descriptive and explanatory*. New York: Charles Scribner's Sons.
- Lakoff, G., & Johnson, M. (1999). *Philosophy in the flesh. The embodied mind and its challenge to western thought*. New York: Basic Books.
- Lewin, K. (1935). *A dynamic theory of personality. Selected papers*. New York: McGraw-Hill.
- Luria, A. R. (1969). *Vysshije korkovyje funktsii tsheloveka i ikh narusheniya pri lokal'nykh porazhenijakh mozga. [Higher cortical functions in man and their disturbances in local brain lesions]*. Moscow: Izdatel'stvo Moskovskogo Universiteta.
- Luria, A. R. (1973). *Osnovy neiropsikhologii*. Moscow: Izdatel'stvo MGU.
- Luria, A. R. (1979). *Jazyk i soznaniye*. Moscow: Izdatel'stvo Moskovskogo Universiteta.
- Mackintosh, N. J. (1998). *IQ and human intelligence*. Oxford: Oxford University Press.
- Mallon, S. D., Kingsley, D., Affleck, G., & Tennen, H. (1998). Methodological trends in journal of personality: 1970–1995. *Journal of Personality*, 66, 672–685.
- Marsella, A. J., Dubanoski, J., Hamada, W. C., & Morse, H. (2000). The measurement of personality across cultures. *American Behavioral Scientist*, 44, 41–62.
- McCrae, R. R., & Costa, P. T. (1996). Toward a new generation of personality theories: Theoretical contexts for the five-factor model. In J. S. Wiggins (Ed.), *The five-factor model of personality*. (pp. 51–87). New York: The Guilford Press.
- McCrae, R. R., & Costa, P. T. (1999). A five-factor theory of personality. In A. Lawrence & O. P. J. Pervin (Eds.), *Handbook of personality: Theory and research* (pp. 139–153). New York: The Guilford Press.

- Molenaar, P. C. M. (2004). A manifesto on psychology as idiographic science: Bringing the person back into scientific psychology, this time forever. *Measurement*, 2, 201–218.
- Molenaar, P. C. M., & Valsiner, J. (2005). How generalization works through the single case: A simple idiographic process analysis of an individual psychotherapy. *International Journal of Idiographic Science*, Article. 1. Retrieved October 25, 2005, from <http://www.valsiner.com/articles/molenvals.htm>.
- Myers, D. G. (1995). *Psychology* (4th ed.). New York: Worth Publishers.
- Pearl, J. (2000). *Causality: Models, reasoning, and inference*. Cambridge, UK: Cambridge University Press.
- Poortinga, Y. H., & van Hemert, D. A. (2001). Personality and culture: Demarcating between the common and the unique. *Journal of Personality*, 69, 1033–1060.
- Roediger, H. L., Capaldi, E. D., Paris, S. G., Polivy, J., & Herman, C. P. (1996). *Psychology* (4th ed.). Minneapolis: West Publishing Company.
- Slooman, S. (2005). *Causal models. How people think about the world and its alternatives*. Oxford: Oxford University Press.
- Smith, E. E., Nolen-Hoeksema, S., Fredrickson, B. L., Loftus, G. R., Bem, D. J., & Maren, S. (2003). *Atkinson and Hilgard's introduction to psychology* (14th ed.) Belmont, CA: Wadsworth/Thomson Learning.
- Smith, L. B., & Thelen, E. (1993). *A dynamic systems approach to development. Applications*. Cambridge, MA: The MIT Press.
- Spirtes, P., Glymour, C., & Scheines, R. (2000). *Causation, prediction, and search*. Cambridge, MA: The MIT Press.
- Sully, J. (1892). *The human mind. A text-book of psychology. In two volumes* (Vol. 1). London: Longmans, Green and Co.
- Thelen, E. (1995). Motor development. A new synthesis. *American Psychologist*, 50, 79–95.
- Thelen, E., & Smith, L. B. (1994). *A dynamic systems approach to the development of cognition and action*. Cambridge, MA: The MIT Press.
- Titchener, E. B. (1898). Postulates of structural psychology. *Philosophical Review*, 7, 449–465.
- Titchener, E. B. (1899). Structural and functional psychology. *Philosophical Review*, 8, 290–299.
- Toomela, A. (1996). How culture transforms mind: A process of internalization. *Culture and Psychology*, 2, 285–305.
- Toomela, A. (2000a). Activity theory is a dead end for cultural-historical psychology. *Culture and Psychology*, 6, 353–364.
- Toomela, A. (2000b). Cultural-historical psychology: Three levels of analysis. *Dissertationes Psychologicae Universitatis Tartuensis*, 7, University of Tartu, Tartu.
- Toomela, A. (2000c). Stages of mental development: Where to look? *Trames: Journal of the Humanities and Social Sciences*, 4, 21–52.
- Toomela, A. (2003a). Culture as a semiosphere: On the role of culture in the culture-individual relationship. In I. E. Josephs (Ed.), *Dialogicality in development* (pp. 129–163). Westport, CT: Praeger.
- Toomela, A. (2003b). Development of symbol meaning and the emergence of the semiotically mediated mind. In A. Toomela (Ed.), *Cultural guidance in the development of the human mind*. (pp. 163–209). Westport, CT: Ablex Publishing.
- Toomela, A. (2003c). Relationships between personality structure, structure of word meaning, and cognitive ability: A study of cultural mechanisms of personality. *Journal of Personality and Social Psychology*, 85, 723–735.
- Toomela, A. (2005). Decision-making with incomplete information: Systemic and non-systemic ways of thinking in medicine. In R. Bibace, J. Laird, & J. Valsiner (Eds.), *Science and medicine in dialogue: Thinking through particulars and universals* (pp. 231–241). Westport, CT: Greenwood/Praeger.
- Toomela, A. (2007a). Culture of science: Strange history of the methodological thinking in psychology. *Integrative Psychological and Behavioral Science*, 41, 6–20.
- Toomela, A. (2007b). History of methodology in psychology: Starting point, not the goal. *Integrative Psychological and Behavioral Science*, 41, 75–82.

- Toomela, A. (2007c). Unifying psychology: Absolutely necessary, not only useful. In A. V. B. Bastos & N. M. D. Rocha (Eds.), *Psicologia: Novas direções no dialogo com outros campos de saber*. (pp. 449–464). São Paulo: Casa do Psicólogo.
- Toomela, A. (2008a). Activity theory is a dead end for methodological thinking in cultural psychology too. *Culture and Psychology*, *14*, 289–303.
- Toomela, A. (2008b). Variables in psychology: A critique of quantitative psychology. *Integrative Psychological and Behavioral Science*, *42*, 245–265.
- Toomela, A. (2008c). Vygotskian cultural-historical and sociocultural approaches represent two levels of analysis: Complementarity instead of opposition. *Culture and Psychology*, *14*, 57–69.
- Toomela, A. (2009a). Kurt Lewin's contribution to the methodology of psychology: From past to future skipping the present. In J. Clegg (Ed.), *The observation of human systems. Lessons from the history of anti-reductionistic empirical psychology* (pp. 101–116). Edison, NJ: Transaction Publisher.
- Toomela, A. (2009b). Methodology of idiographic science: Limits of single-case studies and the role of typology. In S. Salvatore, et al. (Eds.), *YIS: Yearbook of Idiographic Science, 2008*. Rome: Giorgio Fireira.
- Toomela, A. (in press). Poverty of modern mainstream psychology in autobiography. Reflections on the A History of Psychology in Autobiography, (Vol. 9) (G. Lindzey & W. M. Runyan (Eds.) (2007). Washington, DC: American Psychological Association). *Culture and Psychology*.
- Valsiner, J. (2003). Assumptions and knowledge constructions: what can science learn from primate languages and cultures? In A. Toomela (Ed.), *Cultural guidance in the development of the human mind* (pp. 39–59). Westport, CT: Ablex Publishing.
- von Bertalanffy, L. (1968). *General systems theory. Foundations, development, applications*. New York: George Braziller.
- Vygotsky, L. S. (1982a). Istoricheski smysl psikhologicheskogo krizisa. In A. R. Luria & M. G. Jaroshevskii (Eds.), *L. S. Vygotsky. Sobranije sochinenii. Tom 1. Voprosy teorii i istorii psikhologii* (pp. 291–436). Moscow: Pedagogika. (Originally written in 1927)
- Vygotsky, L. S. (1982b). Psikhologija i uchenije o lokalizacii psikhicheskikh funkctcii. In A. R. Luria & M. G. Jaroshevskii (Eds.), *L. S. Vygotsky. Sobranije sochinenii. Tom 1. Voprosy teorii i istorii psikhologii*. (pp. 168–174). Moscow: Pedagogika. (Originally written in 1934)
- Vygotsky, L. S. (1994). The problem of the cultural development of the child. In R. van der Veer & J. Valsiner (Eds.), *The Vygotsky reader*. (pp. 57–72). Oxford: Blackwell. (Original work published 1929)
- Vygotsky, L. S. (1996). *Myshlenije i rech. (Thinking and speech)*. Moscow: Labirint. (Original work published 1934)
- Vygotsky, L. S., & Luria, A. (1994). Tool and symbol in child development. In R. van der Veer & J. Valsiner (Eds.), *The Vygotsky reader* (pp. 99–174). Oxford, UK: Blackwell. (Originally written in 1930)
- Watson, G. (1934). Psychology in Germany and Austria. *Psychological Bulletin*, *31*, 755–776.
- Werner, H. (1948). *Comparative psychology of mental development*. New York: International Universities Press.
- Wertheimer, M. (1925). *Über Gestaltheorie*. Erlangen: Weltkreis-Verlag.
- Wundt, W. (1897). *Outlines of psychology*. Leipzig: Wilhelm Engelman.

# Chapter 4

## The Two Disciplines of Scientific Psychology, or: The Disunity of Psychology as a Working Hypothesis

Denny Borsboom, Rogier A. Kievit, Daniel Cervone and S. Brian Hood

Anybody who has some familiarity with the research literature in scientific psychology has probably thought, at one time or another, ‘Well, all these means and correlations are very interesting, but what do they have to do with me, as an individual person?’. The question, innocuous as it may seem, is a deep and complicated one. In contrast to the natural sciences, where researchers can safely assume that, say, all electrons are exchangeable save properties such as location and momentum, people differ from each other. Furthermore, it is not obvious that these differences can be treated as irrelevant to the structure of the organisms in question, i.e., it is not clear that they can be treated as ‘noise’ or ‘error’. The problem permeates virtually every subdiscipline of psychology, and in fact may be one of the reasons that progress in psychology has been limited. As Lykken (1991, pp. 3–4) hypothesizes:

Psychology isn’t doing very well as a scientific discipline and something seems to be wrong somewhere. This is due partly to the fact that psychology is simply harder than physics or chemistry, and for a variety of reasons. One interesting reason is that people differ structurally from each other and therefore cannot be understood in terms of the same theory since theories are guesses about structure.

Lykken’s hypothesis—that the lawfulness in human behavior, and whatever underlies it, may be person-specific—has potentially far-reaching consequences. Taken to its limit, the truth of the hypothesis would imply that scientific psychology would involve the construction of theories of human behavior on a case-by-case basis—an unmanageable task. In addition, it is not clear whether such an approach would not be contrary to scientific practice as we currently know it, which seeks to generalize theories over the objects that they apply to. It is hard, for instance, to imagine a physics that involves constructing a new theory of free fall for every piece of rock we may want to study. Nevertheless, the processes that underlie your behavior are probably more complicated than, say, the gravitational dynamics that

---

D. Borsboom (✉)  
Department of Psychology  
University of Amsterdam  
1012 ZA Amsterdam, The Netherlands  
e-mail: d.borsboom@uva.nl

underlie the movements of planets in the solar system, and hence Lykken's hypothesis has some initial plausibility.

Given the magnitude of the problems involved in constructing person-specific theories and models, let alone in testing them, it is not surprising that scholars have sought to integrate inter-individual differences and intra-individual dynamics in a systematic way. This may involve, for instance, constructing theories that apply to subgroups of people who are homogeneous at the relevant level of the processes under study. In such a case, full generalizability of theories to individuals may not be possible, but it would be possible to give a systematic account of how inter-individual differences in intra-individual processes are distributed in the general population, and how they arise in human development. This would render the task of partially homogenizing people, by allocating them to homogeneous subgroups, at least somewhat manageable.

The call for integration of research traditions dates back at least to Cronbach's (1957) lament of the disintegrated state of scientific psychology as it existed in the 1950s. In this paper, Cronbach (1957) sketched what he viewed as a solution to the problem of integrating both research on inter-individual differences (which he identified with 'correlational psychology') and intra-individual processes ('experimental psychology', in his parlance):

Correlational psychology studies only variance among organisms; experimental psychology studies only variance among treatments. A united discipline will study both of these, but it will also be concerned with the otherwise neglected interactions between organismic and treatment variables (...). Our job is to invent constructs and to form a network of laws which permits prediction. From observations we must infer a psychological description of the situation and of the present state of the organism. Our laws should permit us to predict, from this description, the behavior of organism-in-situation. (Cronbach, 1957, pp. 681–682)

One of the notable features of the scientific developments since the 1950s is that Cronbach's vision of a unified psychology has failed to materialize. Although his call for integration has been echoed by later writers who noted the gulf between the experimental and correlational styles of research and the corresponding fractionalization of scientific psychology (e.g., Sternberg & Grigorenko, 2001; Borsboom, Mellenbergh, & Van Heerden, 2003), experimental and correlational psychology have not moved much closer since 1957. Certainly, both have expanded and progressed considerably—but rarely in each other's direction; and the theories used in each of the scientific frameworks show few signs of converging into a unified system.

The fact that no integrated discipline of psychology has heretofore materialized may be related to Lykken's (1991) hypothesis of person-specific structure; for it is likely that the integration of the different schools would have been an accomplished fact, if people *were* homogeneous in the dynamic structure of their mental life and behavior. Thus, the lack of integration of research traditions invites a systematic analysis of the way that psychology treats the individual. This, then, defines the main topic of the present chapter: How does psychology treat the individual person, and which theoretical and methodological problems emerge from that treatment?

Why have research traditions on intra-individual and inter-individual differences not converged to a greater degree?

The structure of this chapter is as follows. First, we will sketch, roughly, what we perceive to be the ruling research paradigms in psychology: experimental and correlational methodology. Second, we will discuss recent methodological research into homogeneity conditions and show how their violations may affect the conclusions that researchers draw from their observations. Some particularly problematic fields are discussed in detail by focusing on the fields of intelligence and personality research. Third, we discuss possible loci of homogeneity in scientific models, and sketch the prospects for scientific psychology that may arise from these.

## **Ruling Paradigms**

Not much has changed in the basic divisions in scientific psychology since Cronbach (1957) wrote his presidential address. True, today we have mediation and moderation analyses, which attempt to integrate inter-individual differences and intra-individual process, and in addition are able to formulate random effects models that to some extent incorporate inter-individual differences in an experimental context; but by and large research designs are characterized by a primary focus on the effects of experimental manipulations or on the structure associations of inter-individual differences, just as was the case in 1957. The rough structure of these methodological orientations is as follows.

### ***Experimental Research***

In experimental research, the researcher typically hopes to demonstrate the existence of causal effects of experimental manipulations (which typically form the levels of the ‘independent variable’) on a set of properties which are treated as dependent on the manipulations (their levels form the ‘dependent variable’). As an example, Bargh, Chen, and Burrows (1996) created an experimental condition in which subjects were primed by words like ‘bingo’, ‘Florida’, ‘wrinkle’ and other words associated with the elderly, and a control condition in which they were primed with neutral words. They then measured the time it took subjects to walk from the experimental room. Bargh et al. (1996, p. 237) claim that ‘[p]articipants in the elderly priming condition ( $M = 8.28$  s) had a slower walking speed compared to participants in the neutral priming condition ( $M = 7.30$  s),  $t(28) = 2.86$ ,  $p < .01$ , as predicted.’

One interesting and very general fact about experimental research is that such claims are never literally true. The literal reading of conclusions like Bargh et al., very prevalent among untrained readers of scientific work, is that all participants in the experimental condition were slower than all those in the control condition.



But that, of course, is incorrect—otherwise there would be no need for the statistics. As Lamiell (1987) has argued, the statements that follow from the statistical analysis (assuming the validity of the experiment and dismissing the possibility of a Type 1 error or fluke) are true ‘of the average’ but not ‘in general’ (i.e., they are true of aggregate statistics, but not true for each individual). In Bargh et al.’s (1996) research, for instance, we can be certain that some people in the experimental condition were faster than some people in the control condition (unfortunately it is hard to tell how many, as the Bargh et al. (1996) paper gives no idea of shape of the distribution of walking times, not even rough descriptives like standard deviations).

Of course, this is an entirely unsurprising fact for those acquainted with experimental research. In fact, it is so unsurprising that few researchers find it significant at all. After all, the difference between the means is in the ‘right’ direction, and that, for the typical researcher, is what really matters. However, the question is: in what sense is this direction the *right* direction?

In the minds of Bargh et al. (1996)—and many other experimental psychologists—the direction appears to be ‘right’ in the sense that it gives evidence in support of a universal law or mechanism. For instance, Bargh et al. (1996, p. 242) conclude: ‘[The experiments] showed that traitlike behavior is (...) produced via automatic stereotype activation if that trait participates in the stereotype.’ This obviously is not intended to hold for, say, 56.7% of the people. This is supposed to be a universal law. In this respect, Bargh et al.’s research is paradigmatic for experimental research in psychology.

Clearly, the universal law is not very universal here—otherwise no t-tests would have been performed. So, there exist differences between individuals that are not attributable to the experimental manipulation. In the research tradition of experimental psychology, however, these differences are analyzed—both conceptually and statistically—as noise. The investigator ‘sees’ the universal mechanisms through the ‘lens’ of a statistical analysis, which is assumed to pick up such mechanisms. The underlying picture here is that each and every individual is an instantiation of a universal process that is uncovered by the experiment, much like mean differences in growth of crop are assumed to reflect the effects of different fertilizers (not coincidentally, the experimental design for which R.A. Fisher invented the analysis of variance). Hence, inter-individual differences are viewed as noise.

How does the individual person fit in this scheme of thinking? It appears that, within standard experimental research, the individual figures as an entity that is fully exchangeable with any other entity of the same type. This is true across subfields of psychology. Even in social psychology, a discipline that might have been expected historically to have attended to individuals’ distinctive personal and socio-cultural background, individuals primarily have been conceived merely as “members of hypothetical statistical populations” (Danziger, 2000, p. 344). They thus are interchangeable elements of groups defined in terms of the experimental manipulation. The mechanisms underlying any experimental effects (apart from the inevitable ‘noise’) are then assumed to be homogeneous; ‘the same type’ is the most general type available in psychological research, namely, the human being. In research designs that allow for differences between groups of people (e.g., when a

variable moderates effects) of that correct for such differences (e.g., through matching or analysis of covariance), homogeneity is required for the subgroups of people who have equivalent positions on the variables that are used for moderation analyses, matching, or analysis of covariance.

### ***Correlational Research***

One man's trash is another man's treasure. What the experimental psychologist views as error, and tries to block in all possible ways from confounding the experimental effects, is the object of study for the correlational psychologist. In correlational research, the focus is on the structure of association between variables on which people differ. Typical research findings from correlational studies are, for instance, 'people with bigger brains have higher average IQ-scores', 'extraverts do better in sales', 'there is high co-morbidity between depression and generalized anxiety', or '80% of inter-individual differences in bodily height caused by genetic differences between people'.

Such statements concern facts about inter-individual differences. It is tempting, however, to conclude that they also have meaning for a single individual. This is not generally true. To illustrate this, it is useful to use an approach to meaning in which the meaning of a statement is analyzed in terms the conditions that would render it true. As an example, the statement 'No Ravens are white' is true in all situations in which there are Ravens and none of them is white. Notice that there are various situations, e.g., involving black, blue or green ravens, which all conform to the statement above and therefore fulfill its truth conditions. Analogously, one might concoct the set of all possible situations, call it *S*, that would yield a heritability coefficient of 0.80 in the population, and say: 'this is what my statement means; to say that 80% of the observed variance is due to genetic variance is to say that one of the situations in *S* obtains'. Now, it is clear that all the situations in *S* involve a population of that consists of people who differ from each other. It is also clear that none of the situations in *S* is a situation where there are no differences between people. By extension, there is no situation in *S* in which there is only one individual, say, you. Thus, the statement is literally meaningless, in the sense that it has *no* truth conditions, when interpreted at the level of an individual person.

So, for instance, if you are two meters tall, the above statement about heritability does not entail that 1.80 m of that length are due to your genes and the rest to the environment. The heritability estimate is a function of variance (in this case the ratio of genetic to total variance) and that variance is, in your case, zero. So, should the rest of humanity suddenly decrease from a sudden epidemic, leaving you to be the only survivor, then there would no longer be a heritability of height, because there is no variance left to define it on or estimate it from. The same holds for all correlations that are defined on inter-individual differences, except when very stringent conditions are met (to be described below).

Thus, although in some cases correlational research may yield clues to suggest the presence of universal processes, in general the results cannot be interpreted in such a way. Hence, in Lamiell's (1987) terms, results from this line of research are not true 'in general' either. However, neither are they simply true 'of the average' as the facts from experimental research may be (if it is indeed the case that the underlying mechanisms are universal and all the variance unaccounted for is noise). That is, in the case of experimental research, the facts yielded may be true of the average without any inter-individual differences that exist in the working of the mechanisms studied. This is not generally the case for correlational research. For instance, in the correlational case, full homogeneity of the studied population would consistently yield null results for the study of inter-individual differences (as these are pure noise). Thus, rather than being 'true of the average', conclusions drawn from correlational research are 'true of the inter-individual differences', and without such inter-individual differences, they have no meaning.

What does this mean for the conceptualization of the individual in correlational designs? As was argued above, in much experimental research a person is seen as the instantiation of a universal process (plus or minus error), which is varied by the experimental manipulation. In correlational research, the person functions as the instantiation of a class of people with a given position of an inter-individual differences variable (say, 'all people who are two meters tall'). Thus, the function of the individual in experimental and correlational studies is almost orthogonal. Experimental studies assume, typically, that a person does not differ from other people in relevant ways, and analyze any remaining variance as noise. Correlational studies assume, typically, that a person does differ from other people and work exactly on these differences.

### ***Relations Between the Approaches***

In general, facts from correlational research do not generalize to experimental research or vice versa. For instance, if it is true that there is a universal influence (intraindividual processes) of stereotype primes on walking speed, then this does not imply that interinter-individual differences in walking speed are correlated with the extent to which people have been primed with 'Florida'. Conversely, if it is true that inter-individual differences in normal walking speed are positively correlated with bodily height, this does not mean that surgically increasing your height will make you faster, or that walking faster will make you taller. Indeed, relations between variables may be in opposite direction in experimental versus correlations studies, without any contradiction. As an example, it may be universally true that drinking coffee increases one's level of neuroticism; then it may still be the case that people who drink more coffee are less neurotic, as illustrated in Fig. 4.1.

As can be seen from the figure, the lack of correspondence between intraindividual and interindividual relations between variables is a subgroup problem; the relation between coffee consumption and neuroticism is positive in each individual,

**Fig. 4.1** Hypothetical relation between coffee consumption and neuroticism. For each individual, the correlation between these variables is positive, but in the population the correlation is negative

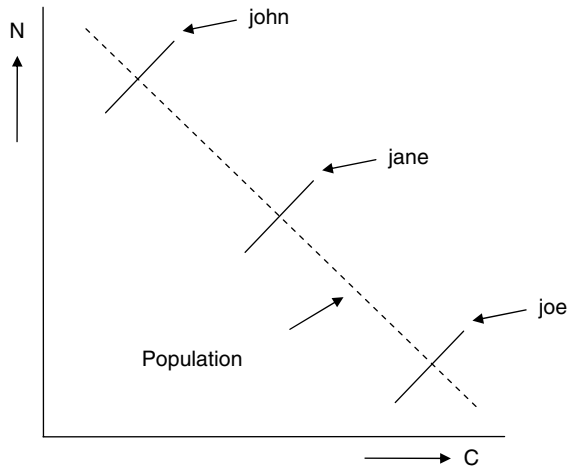

but those individuals who drink more coffee are generally less neurotic (this is, by the way, a special case of Simpson's paradox; see Simpson, 1951). As a result, the idea that correlational and experimental research can 'converge', in the sense that they render support for the *same* hypothesis—commonly viewed as a desideratum in psychological research—only makes sense in a limited set of situations—namely those in which the inter-individual differences found in correlational research are *exclusively* the result of the intraindividual processes studied in the corresponding experimental research. In situations where this is not true, it is unclear whether correlational research can 'support' the kind of hypotheses that are tested in experimental research, because these involve universal processes rather than inter-individual differences; and the set of situations in which laws concerning universal processes yield *any* predictions about the structure of inter-individual differences is highly limited.

### ***The Role of Temporal Dynamics***

The contrasting effects that may be found in correlational versus experimental designs can be disentangled if it is possible to use temporal information. For instance, intraindividual designs, that sample from the time-domain, would conceivably allow the researcher to see that something like Fig. 4.1 is indeed going on (Hamaker, Nesselroade, & Molenaar, 2007; Timmerman, Ceulemans, Lichtwarck-Aschoff, & Vansteelandt, 2009—this book). The researcher would find, in that case, that all intra-individual relations are negative, while all inter-individual relations are positive. Using within-subject experimental designs allows one to extend such analyses to experimental manipulations, thereby getting a handle on the relations that exist between intra-individual processes and inter-individual differences.

In order to gauge the possible outcomes of such research, without actually doing it, one can also use theoretical analyses of how temporal dynamics may relate to

inter-individual differences and responses to experimental manipulations. This is useful because it allows for a general assessment of the structure of these relations, for instance, it allows one to assess under which circumstances results from a given research designs may be unproblematically generalized to other domains. Below we will execute such a theoretical analysis with respect to the measurement problem, by assessing the relations between person-specific measurement structures and models for inter-individual differences.

## **The Psychometric View: Measurement Models and Local Homogeneity**

In the overwhelming majority of cases in psychology, the intended interpretations of research data go beyond the actual observations. So, for instance, researchers study IQ-scores, but want to draw conclusions about intelligence; they get observations on the reported frequency of alcohol abuse, but want say something about addiction; they get data from diagnostic interviews, but want to make inferences regarding depression. The tradition of scientific psychology is to view such observed scores as ‘indicators’ of an underlying structure (called a ‘psychological attribute’ or, somewhat misleadingly, a ‘construct’) that is measured through the indicators. Naturally, in order to gauge whether bridging the gap between intra-individual process research and interindividual research is at all possible, one requires some understanding of the relation between the measurement structures that may arise in each of these domains.

Measurement models, as they are currently used in psychology, conceptualize measurement in keeping with the idea that there exists a causal relation between the attribute measured (say, general intelligence) and the measurement outcomes (IQ-scores), in such a way that the scores causally depend on the attribute measured (Borsboom, 2005, 2008). This is most obvious in situations where models with multiple indicators are used (e.g., factor models or item response theory models). In these situations, the measurement model is formally indistinguishable from a common cause model; the latent variable (a formal stand-in for the attribute measured) functions as the common cause of the indicators. Thus, for instance, the measurement model says that the probability of developing a given depression symptom (lack of sleep, depressed mood, suicidal ideation) is a monotonically increasing function of the level of depression. Moreover, most measurement models require that, given a position on the latent variable, there are no correlations between the indicators. Thus, in this example, the level of depression ‘screens off’ these correlations. The ‘screening off’ relation is one of the defining features of a common cause model (Pearl, 2000; in the latent variable modeling literature, this property is called ‘local independence’).

One can set up measurement models both for intra-individual differences as they extend over time, and for inter-individual differences as they extend over persons. In the first situation, one typically studies one person (or a small group) by obtain-

ing a large set of repeated measures; in the second situation, one studies a large set of people who have been measured once (or a few times). In a measurement model for intra-individual processes, one considers a person-specific measurement model that relates differences in the observed variables (as they occur over time) to a person-specific attribute structure (which varies over time). In a measurement model for inter-individual differences, one considers a model that relates differences in the observed variables (as they occur across people) to an inter-individual differences structure (which describes variation among people).

What does it take for inter- and intra-individual measurement structures to ‘converge’, in the sense that they arrive on the same conclusions with respect to the measurement model and latent structure? Clearly, this can happen only if the intra-individual differences structure does not differ markedly across persons, for otherwise we need person-specific measurement theories. In addition, it would be beneficial if the intra-individual measurement model and the inter-individual measurement model were isomorphic, so that the measurement model for, say, extraversion, would also obtain within each individual. Hamaker, Molenaar, and Dolan (2005) call this condition *homology*. In that case, for instance, one could say that extraversion is a ‘human universal’ in the strong sense that everybody’s behavior (insofar as it relevant to extraversion) is a function of the same latent structure, much like everybody’s length measurements are a function of the same latent structure (i.e., bodily height).

It is sometimes thought that this inference is automatic, so that there is no problem here. The idea underlying this assumption is that evidence for a given factor structure, as derived from inter-individual differences data, is *by itself* evidence for an isomorphic structure ‘in the head’ of the individual people that make up the population. Examples of this line of thinking are Krueger (1999), who thinks that factors defined in an inter-individual differences context represent ‘core psychological processes’ that underlie various mental disorders; Kanazawa (2004), who thinks that evidence for general intelligence (the *g*-factor) is also evidence for an adaptation in the form of a single ‘psychological mechanism’ designed by evolution to solve a particular type of problems; and McCrae and Costa (2008, p. 288), who think that evidence for the Big Five, as derived from the inter-individual differences in personality test data, is also evidence for intra-individual statements like ‘E[xtraversion] causes party-going in individuals’.

Such inferences, however, make sense only if there is a logical connection between hypotheses that concern intra-individual and inter-individual levels; i.e., it requires the kind of theoretical system that Cronbach (1957) imagined and Lykken (1991) doubted. In the past 10 years, the idea that such a connection exists as a matter of logical necessity has been refuted by Molenaar and his colleagues. In short, Molenaar and others have conducted simulation studies aimed at showing that standard factor analyses of variation in populations are insensitive to within-subject heterogeneity.

For instance, Molenaar, Huizenga, and Nesselroade (2003) simulate *N* persons, each of whose behavior is specified by a different factor structure (up to 4 factors). One person may obey a 1-factor structure, another a 2-factor structure, and each per-

son is associated with different factor loadings and error covariance matrix. Thus, with respect to within-subject variability, there is radical heterogeneity. The question, then, is whether there is a between-subject factor model that adequately describes the between-subject variability. If so, then local homogeneity is violated because not every member of the population could exemplify the between-subject model. Molenaar found that a 1-factor structure was sufficient to fit the between-subject variability.

This is, at first sight, surprising because most subjects' time-series data were (by construction) not fit by a 1-factor model and for those whose behavior was specified by a 1-factor model, the factor loadings and measurement-error variances of the between-subject analysis did not match those associated with the time-series data. On a more thorough analysis, however, it is clear that such results may arise, because the between-subjects covariance matrix is partly a function of differences in mean levels of subjects on the observed variables (e.g., this is a variant of Simpson's paradox as displayed in Fig. 4.1; see also Hamaker et al., 2007; Muthén, 1989). In another simulation, Molenaar (1999) determined the factor scores for each subject on the basis of the between-subject model and correlated those scores with the factor scores derived from the time-series data. The correlations were low and in some cases negative. This is also a variant of Simpson's paradox; if the majority of the people with a high mean level on the observed scores are, at a given time point, mostly below their personal means, the relevant correlations become negative.

These simulations show that even the most impressive fit of a between-subjects model to inter-individual differences data does not have implications for the structure of psychological attributes or processes that operate at the level of the individual. Theories concerning that structure are therefore grossly underdetermined by evidence taken from the structure of inter-individual differences. In general, the converse also holds.

Many psychometricians and psychologists, for instance, would guess that if everybody *did* have the same factor structure governing the time series development, then we should find that structure in the inter-individual differences data. That is, if everybody's data come from a person-specific single factor model, then we should find that factor model in the inter-individual differences analysis. Even this, however, is not generally the case. Hamaker et al. (2007) show that arbitrarily complex between-subjects structures can be generated by appropriate manipulations of the averages (over time) around which the time series revolve.

Thus, there is no simple inference ticket from inter-individual differences to intra-individual processes, just as the converse inference ticket does not exist. The accuracy of intra-individual claims on the basis of inter-individual differences research depends on an issue not commonly addressed: whether the measurement models used in the data analysis apply both to differences between people and to differences within people, i.e., are these measurement models homologous?

The conditions for homology to hold are strict. First, it requires local homogeneity, that is, the measurement structure that describes test score covariation for the individual over time must invariant over people. In item response theory, this issue has been addressed by Ellis and Van den Wollenberg (1993), who show that local homogeneity is not implied by standard measurement models for inter-individual differences. In the context of factor analysis, Molenaar, Huizenga, and Nesselroade (2003; see also Molenaar, 1999) have shown the same conclusion to hold.

Local homogeneity refers to the invariance of measurement structures over individuals. Even if such invariance holds, this does not automatically guarantee that the results of an intra-individual analysis will resemble those of an inter-individual differences analysis. That is, if every individual person is adequately described by, say, a single factor model, then one may still find a very different model when analyzing inter-individual differences (Hamaker et al., 2007). The reason for this is that intra-individual time series analyses usually apply to deviations from a person-specific mean, but the covariance matrix of inter-individual differences data is a function of differences between person-specific means as well. The structure of the latter differences is not necessarily constrained by the intra-individual model. Thus, in order to have homology between the inter-individual differences structure, and the results from intra-individual analyses, one needs further conditions to obtain.

First, it appears that to have convergence of the time series structure and the inter-individual differences structure in terms of the dimensionality of the model and the measurement parameters (e.g., factor loadings), one needs not only invariant factor models (which apply to the covariance structure of the data) but also that the data exhibit strict measurement invariance across individuals (which concerns the mean structure; Borsboom & Dolan, 2007; see also Meredith, 1993; Muthén, 1989). This requires that differences in observed mean levels between individuals are exclusively due to differences in latent means. If this is so, then Simpson's paradox cannot occur as it does in Fig. 4.1 or in Hamaker et al. (2007).

We conjecture that these conditions will lead to the same values of the measurement parameters in the measurement model (e.g., factor loadings and error variances in the context of factor analysis), whether it is considered over individuals or over time (Borsboom & Dolan, 2007; Meredith, 1993; Muthén, 1989). However, it need not lead to equivalent values of parameters that describe the latent structure (e.g., means and (co-)variances of latent variables; Muthén, 1989). For a full convergence of the model structures (i.e., including parameters that describe latent variables and relations between them) further conditions are required beyond local homogeneity and measurement invariance. In this case, one needs a condition known as ergodicity (Molenaar, 2004): that is, the results of the analysis as  $n$  (the number of persons) approaches infinity must be the same as the results of the analysis as  $t$  (the number of time points) approaches infinity. This in turn requires two subconditions. The first condition is *stationarity*: each member of the population ('ensemble') must have stable statistical characteristics, such as a constant mean levels. The second condition is *homogeneity of the ensemble*. If the ensemble is homogeneous, the trajectories of each individual fall under the same dynamical laws. Thus, in this case individuals are fully exchangeable.

As Van Rijn (2008) notes, this is extremely unlikely to describe any situation where inter-individual differences research makes sense. It would imply, for instance, that if 20% of the people have an IQ-score over 115, then every single individual should obtain a score over 115 for 20% of the time. This is clearly nonsensical. In fact, ergodicity cannot hold in cases where stable inter-individual differences exist. This means that whenever there are stable inter-individual differences, the model that describes them will not in its entirety apply to individual. Also, ergodicity will be violated for developmental processes, since they by definition have



statistical characteristics that vary over time (e.g., person-specific mean levels are not constant over time). We take this to imply that ergodicity should be viewed as an esoteric condition, that is, we should normally work from the hypothesis that ergodicity does not hold.

The pattern of results that emerges is the following. If ergodicity is violated, but local homogeneity and measurement invariance over individuals hold, then one would expect the dimensionality and measurement model to generalize to the individual, but not the parameters that refer to the latent variables in the model (e.g., means and (co-)variances). If measurement invariance does not hold either, then in addition neither the dimensionality nor the parameters of the measurement model will ordinarily generalize to the individual, although it is still conceptually possible that they will do so by accident (this is a remote possibility). If ergodicity, measurement invariance, and local homogeneity are all violated, then it is impossible in principle for any of the model results to apply at the level of the individual, because the measurement models at the level of the individual and of the population do not match. In this case there is a full disconnect between the proper description of the person and of the population.

## **The Substantive View: Processes and Inter-Individual Differences**

The methodological studies discussed above show that that person-specific measurement models need not be invariant when a between-subjects factor analysis yields a clear pattern. Thus, the various replications of the Big Five personality factors yield some evidence for a between-subject structure, but that evidence is consistent with virtually any hypothesis on person-specific dynamics. It is important to note that the above conclusion concerns the strength of the evidence for person-specific structures as derived from the analysis of inter-individual differences (the strength of this evidence is nil), but that this does not rule out the possibility that ergodicity, measurement invariance, or local homogeneity obtain as a matter of empirical fact. Rather it shows that this is a hypothesis that can only be tested on a case by case basis, by carrying out the relevant research; however, we think that positive results are not to be expected in such research. This becomes clear when one stops to consider the subject matter for areas where these issues are relevant. We will now turn to a discussion of the situation as it obtains in two such areas, namely the study of intelligence and of personality.

## **The Case of Intelligence**

There is no shortage of competing theories of intelligence, but all mainstream theories—and even some of those outside the mainstream such as Howard Gardner's (1993) theory of multiple intelligences—posit mental ability (or “intelligence”) as

a property of individuals. Also, we say things like “John did so well on the test because he’s so intelligent” or “Look at how well little Jaime did on her math test; she’s so intelligent.” Of course, these folk psychological claims are typically completely divorced from substantive psychological theory, but nevertheless, they indicate a commitment to intelligence as some causally efficacious property of individuals. Moreover, these folk psychological claims are not that different from what one finds in a clinical report of one’s performance on an IQ test. Therefore, intelligence is plausibly construed as a psychological attribute that applies to the individual. However, psychometric theories of mental ability are based exclusively on between-subject analyses of test performance. They have focused on (differences in) intelligence as a source of inter-individual differences, i.e., differences in intelligence are posited to explain differential performance on tests of mental ability. The obvious and well-worn way to get to the individual from the population is *via* the assumption of local homogeneity, otherwise the tests may be measuring different traits in individuals than in the population. However, given the noted problems in generalizing population structure to the individual, intelligence dimensions like the *g*-factor *cannot* be understood on the basis of between-subject data as denoting mental ability *qua* within-subject attribute.

Psychological practice seems to indicate that psychologists do assume local homogeneity, if only tacitly. The concept of intelligence on which the most popular intelligence tests are based has general intelligence as a central theoretical posit, and general intelligence has its provenance in standard factor analysis of population-level data, not time series analyses of within-subject variability. The commitments of psychometricians are difficult to discern. Famously, Spearman hypothesized that *g* was mental energy, a within-subject attribute. However, he also cautioned his readers that the *g*-factor was only a statistical construct expressing between-subject variability. Jensen, too, does not seem consistent enough to attribute to him a commitment to local homogeneity. Consider the following quote from Jensen (1998, p. 95):

It is important to understand that *g* is *not* a mental or cognitive process or one of the operating principles of the mind, such as perception, learning, or memory. Every kind of cognitive performance depends upon the operation of some integrated set of processes in the brain. These can be called cognitive processes, information processes, or neural processes. Presumably their operation involves many complex design features of the brain and its neural processes. But these features are not what *g* (or any other psychometric factor) is about. Rather, *g* only reflects some part of the *inter-individual differences* in mental abilities...that undoubtedly depend on the operation of neural processes in the brain.

However in a series of interviews with Frank Miele (2002, pp. 58–59) on the *g*-factor and intelligence, Jensen refers to an individual’s *g* as being causally relevant to determining that person future occupational success. Mike Anderson (1992, p. 2) indicates that he assumes local homogeneity when he writes that

[s]ince differences in tests scores are the target of explanation, whether these represent differences between 2 adults or longitudinal changes within the same individual seems irrelevant. It is taken to be a parsimonious assumption that these differences in scores are to be explained with reference to the *same mechanism*. Thus, for example, higher synaptic efficiency makes on individual more intelligent than another, and increasing synaptic efficiency with age makes us more intelligent as we develop.

Kanazawa (2004) also assumes local homogeneity when he hypothesizes that  $g$  is a species-typical information processing mechanism (see Borsboom & Dolan, 2006, for a criticism of this position). As indicated, for the  $g$ -factor to generalize from the population to the individual, local homogeneity is a minimum requirement.

Strictly taken, the model formulation in factor analysis, as it is applied to intelligence data, is not in keeping with the idea of local homogeneity. The problem here is that attributes like general intelligence as supposed to be relatively stable. More precisely, the assumption is that there is little (in practice) or no (in the formulation of standard measurement models) variation in scores across repeated measures for an individual; that is, the latent variable position is usually taken to be a constant for each individual. Typically, variation between testing occasions is attributed to measurement error, not variation in ability.

Psychological theory and psychometric data are often taken to imply that mental ability is stable in this sense, but if it is, then there is no within-subject variability to model, i.e., no time series analysis is available for the individual. With no variability, there is no factor to be extracted. That is, if the standard measurement model were true for intelligence data, such that deviations from person-specific means were solely due to error, then one would expect the analysis of time series data to yield a covariance matrix where all the off-diagonal elements equal zero.

At the population-level, however, we find that the  $g$ -factor models are robust. As Jensen says in the quoted passage above, “ $g$  only reflects some part of the *inter-individual differences* in mental abilities”. Jensen (2002) makes a more careful statement relevant to the issue of local homogeneity in the context of intelligence research and psychometric models of inter-individual differences:

It is important to keep in mind the distinction between intelligence and  $g$ ... The psychology of intelligence could, at least in theory, be based on the study of one person, just as Ebbinghaus discovered some of the laws of learning and memory with  $N = 1$ ... Intelligence is an open-ended category for all those mental processes we view as cognitive, such as stimulus apprehension, perception, attention, discrimination, generalization, learning and learning-set acquisition, short-term and long-term memory, inference, thinking, relational education, inductive and deductive reasoning, insight, problem solving, and language. The  $g$ -factor is something else. *It could never have been discovered with  $N = 1$* , because it reflects inter-individual differences in performance on tests or tasks that involve any one or more of the processes just referred to as intelligence (pp. 40–41, italics added).

That is,  $g$  is a between-subject statistic, and what it purportedly denotes is a between-subject attribute that “explains” the positive manifold (also a between-subjects phenomenon). The fact of heterogeneity, however, does not imply that the between-subject source of variability is not also a source of variability within subjects. Consider the attribute *height*. Height seems to be an attribute that explains both within-subject and between-subject variability on certain measures such as being able to ride a roller coaster, retrieving items from high shelves, and shoe size. With general intelligence, however, all we have are between-subject models which tell us nothing about how the attribute functions in individuals. Therefore, to make inferences about individual’s “general intelligence” being a causal factor is, arguably, unwarranted. Individuals may have some attribute that we can identify as indicative of “intelligence”, but the between-subject model does not tell us if it is

the attribute purportedly indicated by the *g*-factor. Even though those within-subject attributes may be related to general intelligence, this relationship is not implied by the model.

Apart from the evidence from between-subjects analyses, are there substantive reasons that would lead us to suspect any relevance of an attribute like general intelligence at the level of the individual? Hardly. There is fairly robust evidence that human cognitive development is characterized by stagewise transitions, for instance, which are inconsistent with an interpretation of *g* as a person-specific attribute, because they involve categorical, qualitative steps in development rather than children moving up along a smooth continuum (Jansen & Van der Maas, 2002). Similarly, analyses of various cognitive tasks suggest that mastery of qualitatively distinct rules is needed to solve, say, Raven items, which may also be viewed as a problem for the idea that performance on such tasks is determined by smooth continuum (Verguts & De Boeck, 2002). Language development may likewise be characterized by sudden jumps in understanding (Van Geert, 1991), for instance when children start mastering grammar. In addition, although various reductionist ideas have been put forward, there is no robust evidence for any simple continuous biological substrate that could fill the gap that a dimension like general intelligence leaves at the level of the individual. In fact, the only dynamic theory that has been proposed to explain the occurrence of the positive manifold of intelligence test scores (Van der Maas et al., 2006), which forms the main evidence for *g*, is based on reciprocal relations between various distinct cognitive processes and does not even contain general intelligence in its description of the data-generating process. In conclusion, there is no substantive evidence that general intelligence describes anything more than a structure of inter-individual differences; and substantive theories on human development are virtually uniformly in contradiction with the idea that cognitive development could be described as a smooth transition along a unidimensional attribute.

## The Case of Personality

If one wants a concrete case of our general point—that psychology’s research paradigms continue to divide along experimental/correlational lines—there is no better place to look than the psychology of personality. Decades after Cronbach, the seemingly singular professional field continues to harbor two disciplines (Cervone, 1991, 2004).

Even the reader who does not track developments in this field can easily grasp the nature of this divide, and its implications, through a simple thought experiment. First, think of a personality variable. Next, think of a personality theorist. Then compare the two. The personality variable you thought of likely is along the lines of extraversion, or neuroticism, or something related such as sociability, shyness, or friendliness. The theorist likely is Freud or some 20th-century thinker who was significantly influenced by Freud’s work. “Extraversion” and “Freud” are prototypic responses.

Now compare them. The “personality variables” refer to average tendencies in thought and action—to what a person does typically. They usually are called *dispositional* variables because they reference a general inclination, or disposition, to act in a certain manner. By contrast, the personality theory of Freud did not even target, as a phenomenon worthy of investigation, average-level behavioral tendencies. Freud saw variability in action rather than average tendencies as revealing of personality. In psychoanalysis one would not, for example, average together “hostility toward same-sex parent” and “hostility toward opposite-sex parent” to gauge a persons “average hostile tendencies.” Furthermore, Freud recognized that people engage in superficially similar actions for different underlying reasons; sometimes reasons are related complexly and symbolically to overt emotion and action, and sometimes “it’s just a cigar.” Average behavioral tendencies, then, are an unsure guide to personality structure.

If you had confined your thought-experiment answers to contemporary personality science (Cervone & Mischel, 2002), the divide would still be apparent. Contemporary theorists of course abandon much of the theoretical and meta-theoretical language of psychoanalysis. Yet, like Freud, many target variability in action that is apparent when one observes individuals across social context (Mischel & Shoda, 1995) and recognize that superficially similar dispositional tendencies may reflect different underlying causes (Cervone, 2004). Overt personality characteristics are seen to result from interactions among psychological systems with different functional properties (Kuhl & Koole, 2004). Nonetheless, others continue to posit that “personality structure” is best described by a system of global dispositional variables (e.g., Ashton & Lee, 2007). In these latter approaches, the core unit of analysis refers neither to behavior-in-context nor to underlying psychological systems, dynamics, or functions. The core variables merely describe what people do on average.

How is one to explain these differences? On the one hand, they are closely related to questions of methodology. Investigators who posit global trait variables tend to employ methods that are correlational in nature. Variables generally are identified via factor analysis of inter-individual differences. Those who adopt other perspectives favor other methods, such as case studies (e.g., Freud, 1900; Hermans, 2001) or experiments (e.g., Greenberg, Koole, & Pyszinski, 2004). So methodological choices may drive the differences between theoretical views.

Yet we suspect that methodological choices *sustain* differences rather than being their origin. Theoretical camps professionalize in such a way that a given method is sanctioned, findings that employ the method are publishable when reviewed by the professional in-group, and the body of published findings sustains the theoretical approach, including the careers of those who espouse it. This sociology of science, however, fails to explain how theoretical differences arose in the first place. How can it be that some investigators view global behavioral tendencies as the structure of personality, whereas others explore personality dynamics and view idiosyncratic, contextualized patterns of variability in action as the key markers of underlying personality structure? It would appear that the very meaning of “personality” and “personality structure” differs from one group of investigators to another (Cervone,

2005). In one case, the terms reference the architecture of mental systems that contribute to those aspects of experience and action that conventionally are called “personality”; this meaning has been apparent since the work of Freud (1923) and remains evident today (Cervone, et al., 2008). In the other, personality constructs serve as a “descriptive taxonomy” (John & Srivastava, 1999, p. 103), and the entity being described is variation in the population at large. How could such divergent conceptions of “personality” have arisen in the first place?

Another thought experiment may be informative. For simplicity, we will shift our focus from persons to an artifact whose properties are fully understood. Suppose that two teams of extraterrestrial investigators landed on Earth and explored what might appear to be dominant large species roaming the land: automobiles. Suppose that one team examined individual automobiles in detail, perhaps with each member of the team taking a close look at a couple of cars, examined one-at-a-time. After this data gathering, members of the group might compare notes to develop a conceptual model of cars. If the extraterrestrials have a good head on their shoulders, they might surmise from their observations that cars have a number of distinct functional systems: a system for storing fuel; a system for burning the fuel; a cooling system; a transmission system; etc. Now imagine that the other group, seeking to save some time, decides to observe the entire population of cars (or a large and presumably representative subpopulation) all at once. Here, differences among cars become apparent: they vary in color and shape; some carry a lot of people and others have just two seats; some cars break down whereas others keep running; all of them seem to travel at about the same speed when they’re on the same roadway, but in very particular circumstances some cars seem a lot faster than others; most of them seem to provide a comfortable space for people to set, but some have extra amenities like leather seats and high-quality stereos. When these investigators sit down to summarize what they have learned, they might conclude that words like “sportiness,” “reliability,” and “luxuriousness” summarize differences among the cars.

What happens when the two research teams meet up? Do the results “converge”; does one “integrate” them? This clearly depends on what the words “converge” and “integrate” are taken to mean. The results do not “diverge.” They are not inconsistent with one another, and they are related in some ways. If one were to pick a between-automobiles dimension such as “sportiness,” and then were to examine mechanical features of those cars that were particularly high and low on that dimension, the cars would differ mechanically. The sporty cars, for example, might have more cylinders and thus generate more power via the burning of fuel. They might also have fewer seats. Yet the two sets of findings do not come together at one conceptual point; they do not combine into a whole (typical meanings of “converge” and “integrate”). They have only a loose association. Terms like “sporty” and “luxurious” are very useful for the purpose of discussing differences among cars. But they do not figure in a conceptual model of what a car has, mechanically, and how the car works.

This analogy maps quite closely to both the history and the current conceptual status of alternative approaches to personality psychology. Historically, some theorists observed individual people in great detail. Freud (1900) conducted case stud-

ies. Social learning theorists observed individual children as they acquired skills via interaction with the social environment (Bandura & Walters, 1963). These close observations led them, when providing conceptual models of the person, to model structures, processes, and functions of the human mind. It commonly went without saying for these investigators that a model of “personality structure” was a model of the cognitive and affective systems possessed by the individual (Mischel & Shoda, 1995). At a functional level, they modeled human capabilities (Bandura, 1986).

Other researchers investigate large populations, with each research participant studied only at one point in time and in little depth. Perhaps the best known example of such work is the “lexical tradition” in personality psychology (Ashton & Lee, 2007; Goldberg, 1993). Investigators ask large numbers of persons to describe themselves using personality terms that one finds in the dictionary. Factor analysis is then used to identify dimensions that summarize inter-individual variation. For these investigators, it goes without saying that “personality” refers to differences between people, and “personality structure” is a set of dimensions that summarizes between-person differences in the population at large.

Many efforts in contemporary personality psychology claim to “integrate” these two perspectives. Yet, with the risks of painting with a broad brushstroke, it can be said that these efforts commonly are integrative only in the way that the study of “sportiness” and auto mechanics is integrated in our example above. There is no one-to-one mapping from one language to the other. Innumerable research findings in personality psychology document that people with different scores on between-person trait dimensions differ from one another when those persons are brought into the laboratory and their cognitive or physiological responses to stimuli are assessed (e.g., Eysenck, 1970). Yet, similarly, one could bring cars high and low on “sportiness” into the shop to have their mechanical workings assessed and find that the cars differ. There is only very limited sense in which such findings would “integrate” the two types of research on cars—or persons. And this is not a shortcoming of the research. They can’t be integrated into one converging whole. As Harré (1998) has explained with particular clarity, a psychological model of the individual needs to identify the personal powers through which persons think and act. Descriptive terms (“outgoing,” “anxiety-prone,” “conscientious,” and the like) are necessary to social discourse about persons, but one should be very careful in using such terms as cited causes in the explanation of the actions of the individual.

## **The Conceptual View: Is a Unified Psychology Possible?**

The case of personality psychology, then, illustrates the more general point we stated earlier. Many investigators in the field write as if between-person correlational findings have direct meaning for the psychology of individual. In some cases, this intellectual move from inter-individual correlational findings to intra-individual hypotheses is explicit (e.g., McCrae & Costa, 1996, 2008). In numerous other cases, it is a bit more subtle. Researchers may search for the psychological dynamics—i.e.,

a conceptual model of the individual—that is associated with the given score on a personality trait factor—where the factor summarizes intra-individual differences. For example, they may seek to uncover the psychological dynamics of “introverts” and “extraverts,” that is, people with low and high scores on an extraversion scale. This search is sensible if one can assume that the different people who get the same test score are psychologically homogenous. As we saw earlier, there commonly are no grounds for making this assumption.

It is clear from the discussion so far that the gulf that exists between research on intra-individual processes versus research on inter-individual differences is more than a matter of different methodological inclinations, or of researchers’ lack of attendance to the project of unification. There appear to be rather principled problems in connecting results from both areas of study. These problems become apparent if one stops to consider the relevant measurement structures in both fields. It is clear that these need not have anything in common. In addition, substantive theories on, say, the dynamics of behavior do not match or support theories on inter-individual differences in behavior; likewise, theories on the development of cognition have no place for such a thing as general intelligence. It is interesting to note, in this respect, that theories of inter-individual differences are not in any relevant sense *refuted* by these observations. In contrast, theory and research on intra-individual processes appears to be largely *irrelevant* to the study of inter-individual differences, and vice versa. The reason is that, barring perhaps the most basic laboratory tasks for which assumptions like ergodicity or measurement invariance over individuals might be taken to hold true, *any* theory on intra-individual processes is compatible with *any* theory of inter-individual differences.

Many people find this to be perplexing. Obviously, the item responses on which inter-individual differences researchers execute their analyses are necessarily generated by some dynamic process in the individual. Also, it is evident that some of the inter-individual differences that researchers find are extremely robust. Furthermore, any set of inter-individual differences is parasitic on the dynamic processes that generated the basic behavior that people exhibit. If John shows up at every other party, while Jane never leaves the house, then clearly there is a dynamic process that differs between them: John does not mysteriously appear at a party without some antecedent dynamic process that, obviously, Jane does not follow. Similarly, if Jane can solve a polynomial equation while John cannot, there must be a process that she carries out but he does not. So how could we have stable inter-individual differences if there were no systematic differences in whatever dynamics describe the actions of the individual?

We think that the answer to this question may be that, instead of there being *no* connection between these levels of analysis, there may actually be *too many*. To see that this may be the case, note that all that is required for a between-subjects measurement model to hold is that (a) there be some set of differences between them that is accurately described by the latent structure, and (b) these differences connect to the observables in the right way, which means that differences in the attribute structure systematically lead to differences in the observables.



Thus, for the hypothesis of general intelligence to be true in the context of the factor model, what is required is that people can be ordered on a line, and that where they are on the line determines their probability distribution over the item responses in the way the model says it does. The model has nothing to say, however, on (a) why or how people come to occupy different positions on this line, or (b) how they produce the answers to IQ-items. That is, John and Jane may have an equal standing on the latent structure called the *g*-factor, but for different reasons. Jane may, for instance, have a smaller brain volume but compensate by having a higher level of neural plasticity, to name but two biological substrates that have been suggested for the *g*-factor (Garlick, 2002; Posthuma et al., 2002). Similarly, both may have a higher probability of answering Raven items correctly than, say, Pete, who has a small brain with low plasticity; nevertheless, they may follow different strategies in answering these items, shaped by different previous experiences and maturation processes. In fact, it is entirely possible that Pete follows the same strategy as John, but is less efficient in his use of memory resources, so that he fails an item where John succeeds. Jane, on the other hand, may follow a strategy different from both John and Pete, and succeed. As long as the processes in play do not affect different items differently (or do so to a sufficiently small degree), there is nothing in the above situation that would falsify a measurement model for inter-individual differences, for the simple reason that such a model makes no claims with respect to the substantive nature of the latent variables it posits or the relations they bear to the observations. It only says that *if* differences arise (in whatever way), *then* these differences must affect the items people take in keeping with the model structure. And this can often happen in an infinity of ways.

It is useful to illustrate how this may work by returning to the automobile metaphor used in the previous section, and exploring it in some more detail. Consider a set of vehicles—say, cars, bicycles, and horse carriages. We may attach to these vehicles an abstract latent structure that refers to a dispositional attribute that determines their performance in races—we call this ‘power’ or ‘maximum performance’, or ‘racing ability’. We may measure this latent structure, for instance by letting the vehicles race on various tracks, using the times needed to complete the tracks as indicators. It is easy to imagine a set of tracks that would show positive intercorrelations analogous to those observed on intelligence test scores: on average, vehicles that perform better on one track will also perform better on other tracks. It is also reasonable to interpret racing ability as a dimension that is real, in the sense that, say, a Ferrari F60 really does have a higher racing ability than a horse carriage with respect to a given set of race tracks (naturally, this does not apply to small mountain paths). One may furthermore suppose that these differences determine differences between the vehicles’ performance, so that the race performances are valid measures of racing ability.

However, if a researcher should set out to determine what ‘racing ability’ consists of, or where it is ‘located’ in the cars and horses under consideration, she would find nothing. Similarly, research into the processes that give rise to differences in performance would probably reveal a bewildering complexity of findings, as these processes differ across vehicles in a myriad of ways. And, should the researcher

set out to investigate which physical determinants ‘underlie’ differences in racing ability, the project would strand hopelessly, because the different vehicles have little—in anything—in common when it comes to the propulsion mechanisms that realize their racing ability.

The interesting thing is that all this would not happen because there is *no* relation between the physical processes involved in propulsion and the dispositional attribute of racing ability (there obviously are such relations), but because these relations are themselves dependent on the object under study. The relations involved do not possess sufficient systematicity, generality, and are too complex to allow for a parsimonious explanation of differences in racing ability in terms of the processes that underlie it. Thus, even though there must, by necessity, be processes that underlie differences in racing ability, models that describe inter-individual differences in racing ability and models that describe mechanisms of propulsion for any given vehicle would cover surprisingly little common ground. Moreover, it is very hard to see a way in which a theory on the propulsion mechanism of individual vehicles would place significant restrictions on the model structure that applies to the measurement of racing ability as an inter-individual differences dimension. In fact, one could imagine that any set of propulsion mechanisms, or of time series models describing them, would be consistent with any structure of inter-individual differences.

It is thus likely, should there be car scientists that consider such questions, that they should develop intra-individual and inter-individual research traditions as psychologists have. And it is questionable, as in the case of psychology, whether the intra-individual and inter-individual twains would ever meet. To us, the situation sketched in the car example thus appears to be quite similar to the situation as it exists in the fields that show the greatest tension between intra-individual and inter-individual levels of analysis, such as personality and intelligence research. General intelligence, for instance, is extremely similar to racing ability. Personality traits like extraversion are similar as well, although they are not maximum performance concepts but typical performance concepts; thus, such traits would bear more similarity to notions such as ‘reliability’, as explained in the previous paragraph.

### ***Why are Inter-Individual Differences Intractable?***

The question that arises is: what properties of such inter-individual attributes lead them to separate themselves so clearly from the intra-individual analysis? We think that three properties are important in this respect: their dispositional character, the fact that they are multiply realizable, and the fact that they are multiply determined.

First, almost all inter-individual differences concepts are essentially dispositional. That is, their meaning relies heavily on an ‘if...then...’ structure. The typical example of a dispositional concept, for instance, is ‘fragility’. To say that a vase is fragile is to say that it has a physical structure that leads it to break if it is dropped. Whatever physical structure precisely realizes the property of fragility is not rel-

evant to the truth-value of the sentence ‘this vase is fragile’. For intelligence, such ‘if...then...’ relations are filled in like ‘John is highly intelligent: if he is presented with a difficult problem, he will solve it’. For personality traits, they are filled in like ‘John is extraverted: if he were given the choice between staying at home with a book or going to a party, he would choose the latter’. It does not matter for the truth-value of such conditionals precisely *how* John solves items or gets to parties. Also, it does not matter *what* allows or forces him to exhibit such behaviors. In fact, these concepts are amenable to a functionalist analysis, in the sense that it may be upheld that, at the level of the individual, *whatever* allows him or her to solve an item in an IQ test *is* intelligence. Thus, in this sense concepts like intelligence, extraversion, and racing ability are essentially open; that is, they can be (physically) realized in infinitely many ways.

This points to a second important property of inter-individual differences dimensions, which is that their levels can be often expected to be multiply realizable. Just like a given level of racing ability can be realized by different vehicles in different ways, a given level of intelligence may be realized in different people in different ways. To see this, it is illustrative to note that, should we tomorrow be visited by little green men from outer space who, instead of a brain, have a hydraulic system located in their left big toe that does the thinking, they might still be located on the dimension of general intelligence as long as their levels of intelligence can be placed on the same line as ours and behave in the same way, even though the item response processes, at a physical level, may have few elements in common with our own. This thought experiment, naturally, represents an extreme case, but it is in our view highly likely that in the human population general intelligence (if it exists) is realized differently in different people as well; this appears to be almost guaranteed by the sheer complexity of the human brain and the existence of inter-individual differences in cognitive and emotional development. Such different realizations of the levels of inter-individual differences dimensions can be expected to involve ‘physical’ differences (e.g., in the context of intelligence, brain size, neural plasticity, neural connectivity, etc.) as well as ‘psychological’ ones (e.g., differences in strategy, the use of cognitive rules and heuristics, etc.).

A related but distinct property of inter-individual differences dimensions is that they are not just multiply realizable (the same level of intelligence may be realized by different constitutions) but also multiply determined: the causal pathways that lead to any given level of an inter-individual differences dimension are likely to differ among people. There is ample reason to expect this to be so. For instance, the combination of (a) high heritability estimates for almost all inter-individual differences dimensions (Boomsma, Busjahn, & Peltonen, 2002) and (b) the limited success in finding any genetic markers that explain more than, say, 1.5% of the variance in such dimensions, suggests that inter-individual differences may be strongly polygenic. This is evidence for multiple determination as far as it concerns the part of development that is under genetic control, because it means that distinct pathways underlie inter-individual differences for (almost) any distinct combination of individuals. Another source of evidence for multiple determination comes from the study of epigenetic effects (Jaenisch & Bird, 2003; Molenaar, Boomsma, & Dolan,

1993), which is an autonomously operating process that creates inter-individual differences that are not uniformly tractable to any set of genes or environmental conditions. Finally, at the environmental side of development, the differential pathways that lead to equivalent levels of ability are completely obvious. To give an example, John and Jane may have the same level of intelligence at a given time point, because Jane may have had a virus of accident that impaired her intelligence to equal the initially lower level of John, whose intelligence has undergone no major impairments. Any such external influences, insofar as they do not distort the measurement model for a given test, must be counted as part of the causes that give rise to the inter-individual differences dimensions under study; and it is clear that their number is infinite. Taken together, the evidence suggests that our working assumption should be that inter-individual differences stand under the influence of a large number of disparate causal factors.

We think that it is plausible to assume that most inter-individual differences variables are dispositional, multiply realizable, and multiply determined. The implication of this is that, even though each and every difference between two people depends for its existence on *some* differences in intra-individual processes, the systematic explication of the relation between these domains is likely to be an extremely complicated matter; in fact, in many cases, this relation may be intractable. This observation is consistent with the psychometric analysis discussed earlier in this chapter, which established the lack of correspondence between inter-individual differences structures and the structure of intra-individual processes. Thus, although causally dependent on intra-individual processes, inter-individual differences may not lend themselves to an explanation in terms of these intra-individual processes. This, in our view, may be one of the reasons that the two disciplines of scientific psychology, as discussed by Cronbach 1957, have not appreciably moved closer. In fact, we suspect that the character of the relation between intraindividual processes and inter-individual differences may serve to isolate these branches of study from each other in a structural way.

## *Supervenience*

The reason for this is that the relation between intraindividual differences and inter-individual processes, as explicated in this chapter, is most aptly characterized as a *supervenience* relation. A property X supervenes on a (set of) properties Y if and only if it is true that, given a fixed Y, there cannot be differences in X. A typical supervenience relation in psychometrics, for instance, is that of the relation of a total score (X) to the item scores (Y) of which it is composed: there cannot be differences in the total score if there are no differences in the item scores. The supervenience relation is asymmetric, as can be easily seen from the same example: if there are no differences in the value of the total score (X), there may nevertheless be differences in the item scores (Y). This is because the total scores are multiply realizable, as for  $n$  items, a total score  $k$  can be realized in  $n!/\{k!(n-k)!\}$  ways.

Together with multiple realizability, the supervenience relation has been used often in the literature on the mind-body problem to give a nonreductive physicalist account of the relation between mental states and brain states. Roughly, physicalism holds that all mental phenomena *are* ultimately physical phenomena. Reductionism holds that, in addition, psychological laws and regularities can ultimately be *reduced* to (or systematically explained in terms of) physical theories, for instance to those concerning the human brain. Thus, physicalism is an ontological thesis and reductionism is an epistemological one. Nonreductive physicalism roughly holds that psychological states (like, for instance, ‘believing that  $\pi$  is not a rational number’) can be realized in an infinite number of ways in the human brain. Thus, although there cannot be differences in psychological states if there are no differences in the physical structures that realize them (supervenience and materialism), there may be differences in the physical structures that serve to realize the same psychological state (multiple realizability). The primary argument against reductionism that follows from this (explicated by Fodor, 1974) is that the physical category of states that realize a psychological state will be arbitrary from the perspective of the reducing theory (say, neuroscience) and therefore cannot figure in its laws.

We submit that the relation between intra- and inter-individual differences is exactly the same as that between mental and physical processes. That is, every inter-individual difference depends, for its existence, on a difference in intra-individual processes (supervenience). However, these differences are multiply realizable, which means that the intra-individual processes that ‘realize’ a given level of intelligence only do so from the perspective of the higher level science (inter-individual differences research). They do not form a homogeneous category from the perspective of the lower-level science (intra-individual processes). Therefore, the collection of intra-individual processes that is contained in the correlational psychologist’s ‘has intelligence level  $x$ ’ is not a consistent category from the perspective of the experimental psychologist: from the perspective of the experimental psychologist, it corresponds to a disjunctive ‘either follows process  $a$ , or  $b$ , or  $c$ , or...’, and this disjunction is arbitrary from an intra-individual processes perspective. Therefore, it will not be a ‘kind’ of intra-individual research, and cannot figure in its laws.

### ***Illustration: The Case of Chess Expertise***

The related issues of multiple realizability, multiple determination and the dispositional character of intra-individual cognitive abilities are present in a wide range of psychologically interesting concepts. An almost archetypical example of a cognitive process, playing chess, illustrates how these three elements interact to make intra-individual inferences from interindividual data improbable, if not impossible.

Chess playing is a psychologically interesting skill that encompasses a variety of cognitive skills and processes, much in the same way as IQ can be seen as combination of skills that yields an individual score with predictive qualities. The equivalent of chess IQ is the international rating system called the Elo-rating, after the

American physicist Arpad Elo. Although the distribution of scores is logistic rather than normal, the overall nature of the Elo-rating is very similar to the IQ score. An individual has a score that is a rank on a unidimensional ability scale, which reflects the probability of beating lower or higher ranked individuals, and the likelihood of solving chess problems of varying complexity. A closer examination will show that all three previously discussed issues hold for chess playing.

First, chess playing and chess ability are essentially dispositional. In principle, there are no limits to the cognitive process, playing style or set of abilities a player uses to win games; all that matters is the ratio of wins and losses against variably skilled opponents and the probability of solving problems. Players of comparable chess playing ability may constitute their respective levels in very different manners; one player may possess a vast knowledge of common situations and by-the-book tactics, whereas another may rely more on intuition and creativity. As long as they have the same scores on the Elo-scale, there is nothing on the inter-individual level to set them apart, which allows for rather dissimilar processes to fall under the umbrella of 'chess playing at level x'.

In addition, evidence from the neurosciences suggests that chess ability is a multiply realized ability, even on the intra-individual level (over time). An example is a study by Amidzic, Riehle, Fehr, Wienbruch, and Elbert (2001), in which magneto-encephalogram recordings (MEG) were made of both expert chess players and intermediate players whilst playing a chess computer. The patterns of cortical activity for 5 s after the computer made a move were recorded and compared. Amateur chess players showed pronounced temporal lobe activity, a region commonly associated with logical reasoning skills such as 'if... then...' statements. The pattern for experts (ELO>2000) was markedly different. They showed very little temporal activity but pronounced prefrontal lobe activity, which is normally related to memory and retrieval activity while intermediate players showed mainly temporal lobe activity. This result was very robust, and showed a strong negative correlation (-0.84) between Elo-rating and activity in medial temporal lobes, the perirhinal and entorhinal cortex and related structures. It is known that expert chess players are able to memorize the patterns that often occur in chess matches up to a staggering 100,000 and 400,000 moves or situations (De Groot, 1978). This suggests that as a player becomes better, he or she relies more and more on 'pre-programmed' positions, so that deciding on the next best moves becomes much more a memory activity than a reasoning ability. This is a prime example of a cognitive ability that shows significant qualitative changes not captured by the interindividual model. It seems therefore that chess playing ability is a multiply realizable skill; there are many ways to play chess and they change markedly with increased skill. Finally, chess playing is multiply determined. There is a wide range of skills that are useful when playing chess, but the interplay between them is potentially very complex and not suitable for simple factor analytic approaches. For example, an increase in working memory capacity may only be an advantage if one's knowledge of strategy allows for the efficient use of this extra capacity.

It seems clear that the causal factors that contribute to the overall quality of a chess player are irreducible on several different levels. It must be stressed that this

is not an exotic exception to the rule, if anything, chess is exemplary for a wide variety of cognitive abilities that psychologists deem worthy of study. These issues do not preclude a coherent analysis, but awareness of measurement issues are an essential safeguard against overly ambitious intra-individual inferences drawn from any form of group level measurement.

Clearly, the dispositional character of inter-individual differences dimensions, together with multiple realizability and multiple determination, yields significant problems for attempts to sensibly connect these dimensions to intra-individual processes. This appears to grant such dimensions a certain sense of autonomy and irreducibility. For instance, it has been argued in the literature that multiple realizability is a sufficient condition to block successful reduction of the higher-level theory to the lower-level theory; Fodor (1974, 1997) famously maintains that this holds for higher-level sciences as diverse as psychology, economics, and meteorology. This conclusion has been hotly debated in the philosophical literature of the past three decades, and it is beyond the scope of this chapter to evaluate its validity. However, apart from the principled question whether reduction is at all possible, we think it is relatively obvious that the existence of supervenience and multiple realizability will seriously complicate the practical integration of fields.

## Conclusion

It has been the working assumption of many psychologists and methodologists that the integration of experimental and correlational research or, if you will, intra-individual processes and inter-individual differences research, is a matter of time; that it is a sign of the ‘immaturity’ of psychology that they have not yet converged to a single theoretical system; and that the unification of psychology is something that we should strive for. The image that arises from the present investigation, however, is a rather different one. The rift separating the traditions may be much deeper than is commonly thought and, in fact, may be structural—that is, the gap will not be closed by the passing of time or the progression of scientific psychology. It may very well be here to stay. Thus, to speak with Fodor (1974), we may want to accept not the unity, but the disunity of psychology as a working hypothesis.

The evidence for this hypothesis is quite overwhelming. First, the fact is that more than 50 years have passed since Cronbach’s call for integration, and that they have done so without widespread progress being made in this particular program. Naturally, one may consider various explanations of this situation that draw on sociological processes (e.g., the formation of research traditions) or differences in methodological orientation (as Cronbach himself did by labeling the traditions as ‘correlational’ and ‘experimental’). However, we seriously doubt whether such explanations have sufficient explanatory force. Scientists tend to relentlessly pursue lines of research that ‘work’, in the sense that they answer interesting questions or lead to the solution of practical problems, and it seems rather implausible that so few ‘working’ versions of the desired integration had been stumbled upon if

they were there for the taking. The traditions of ‘correlational’ and ‘experimental’ research may not be induced by different methodological inclinations, but by a different subject matter.

Moreover, psychometric considerations suggest that few restrictions on one side of the divide can be deduced from theories that apply to the other side: a particular dimension of inter-individual differences can be generated by many systems of intra-individual processes, and conversely a theory of intra-individual processes does not lead to restrictions on the possible spaces of inter-individual differences unless unreasonably strong restrictions are met. For instance, Hamaker et al. (2007) and Timmerman et al. (2009—this book) show how far little intra-individual and inter-individual structures can diverge. The only restriction that is universally in place is that intra-individual and inter-individual theories should be *consistent* with each other—in the sense of not being contradictory—and the psychometric work of the past few decades strongly suggests that this restriction is extremely easy to meet. However, mere consistency of theories is far to little to fuel an integration of fields, or to drive an explanation of inter-individual differences in terms of intra-individual processes. Psychology is entirely consistent with, say, non-Euclidean geometry, but that does not imply that there are any interesting explanatory connections between these areas of research.

To have a real connection between the fields under consideration here, one should be able to infer what an inter-individual differences structure should like from a theory of intra-individual processes—more specifically, one should be able to place refutable restrictions on the inter-individual model structure. This is certainly not impossible in general, but for many sub-disciplines in psychology the task at hand appears to be extremely difficult to carry out. More specifically, the sort of attributes that inter-individual differences research has brought into play appear to be of the wrong kind to figure in such explanatory schemes. One may of course counter that this just means that the inter-individual differences attributes should be done away with, and replaced by process-oriented theories. This, however, requires one to actually show that such replacements will work adequately, and this need not be possible. Returning to the intelligence example, for instance, there have been several proposals to fill the gap of things like *g* by substituting sets of cognitive processes at the level of the individual (e.g., Sternberg, 1985), but the empirical success of such approaches has been limited (Deary, 2000) and it is not clear that such process theories are at all in the same explanatory league as inter-individual differences dimensions, in the sense that they may not apply to the same phenomena (e.g., the positive manifold; Borsboom, Mellenbergh, & Van Heerden, 2003). The similarity to the mind-body debate is quite strong in this case as well; for instance, we find similar calls for ‘brain-based’ constructs instead of ‘psychological’ ones among the fiercest reductionists (e.g., Churchland, 1981). Such calls, however, are promises; and a general law that applies to promises is that the proof of the pudding is in the eating. Clearly, so far there has been little pudding to eat.

Scientific progress comes in many forms. The textbook example is the successful explanation of a phenomenon in terms of a theory, but sometimes science progresses by showing that a dreamed route of progress is blocked. Famous examples include



Gödel's (1931) incompleteness theorem, which destroyed the work presented in Russell and Whitehead's (1910) *Principia Mathematica* by showing that the desired reduction of mathematics to logic was impossible, and the theory of complex systems, which for instance explains why we cannot predict the weather more than a few days in advance. Our suggestion in the present work is that the integration of intra-individual and inter-individual research programs may be exactly such a case: a dreamed route of progress that is really a dead end street.

This may sound like a gloomy conclusion. However, we think that there is little reason for optimism on the 'integration' of the two disciplines of psychology in the sense Cronbach (1957) had in mind, and wishful thinking is not bound to change that. Moreover, there are two important implications that follow from the analysis, if it is correct, that may serve to further our understanding of how the disciplines could be related. The first implication is that we need further understanding on the conceptual and empirical relationships between attributes as they are used in the two disciplines. We have established, reasonably firmly, that equating the concepts of intra-individual processes research and inter-individual differences research is not an option that we should expect to work. At the same time, it would seem that the experimental psychologists 'working memory' and the differential psychologists 'working memory' are related, and how they may be is a important issue. Clearly, we have only scratched the surface with respect to this interesting question. Second, the present analysis cautions against interpreting results from inter-individual differences research as descriptive of the individual person; similar caution should go out to most experimental studies, which are descriptive of means, not individuals. Thus, the analysis of the individual in its own right is a project that, despite a century of psychology, still awaits a proper methodology. It is our hope that methodological techniques suitable to this purpose will be developed to maturity in the coming years.

**Acknowledgments** Denny Borsboom's work was supported by NWO innovational research grant no. 452-07-005.

## References

- Amidzic, O., Riehle, H. J., Fehr, T., Wienbruch, C., & Elbert, T. (2001). Pattern of focal  $\gamma$ -bursts in chess players. *Nature* 412, 603.
- Anderson, M. (1992). *Intelligence and development*. Cambridge: Blackwell.
- Ashton, M. C., & Lee, K. (2007). The HEXACO model of personality structure and the importance of the H factor. *Social and Personality Psychology Compass*, 2, 1952–1962.
- Bandura, A. (1986). *Social foundations of thought and action*. Englewood Cliffs, NJ: Prentice Hall.
- Bandura, A., & Walters, R. H. (1963). *Social learning and personality development*. New York: Holt, Rinehart, & Winston.
- Bargh, J. A., Chen, M., & Burrows, L. (1996). Automaticity of social behavior: Direct effects of trait construct and stereotype activation on action. *Journal of Personality and Social Psychology*, 71, 230–244.

- Boomsma, D. I., Busjahn, A., & Peltonen, L. (2002). Classical twin studies and beyond. *Nature Reviews Genetics*, *3*, 872–882.
- Borsboom, D. (2005). *Measuring the mind: Conceptual issues in contemporary psychometrics*. Cambridge: Cambridge University Press.
- Borsboom, D. (2008). Psychometric perspectives on diagnostic systems. *Journal of Clinical Psychology*, *64*, 1089–1108.
- Borsboom, D., & Dolan, C. V. (2006). Why g is not an adaptation: A comment on Kanazawa. *Psychological Review*, *113*, 433–437.
- Borsboom, D., & Dolan, C. V. (2007). Theoretical equivalence, measurement, invariance, and the idiographic filter. *Measurement*, *5*, 236–263.
- Borsboom, D., Mellenbergh, G. J., & Van Heerden, J. (2003). The theoretical status of latent variables. *Psychological Review*, *110*, 203–219.
- Cervone, D. (1991). The two disciplines of personality psychology. *Psychological Science*, *2*, 371–377.
- Cervone, D. (2004). The architecture of personality. *Psychological Review*, *111*, 183–204.
- Cervone, D. (2005). Personality architecture: Within-person structures and processes. *Annual Review of Psychology*, *56*, 423–452.
- Cervone, D., Caldwell, T. L., Fiori, M., Orom, H., Shadel, W. G., & Kassel, J., et al. (2008). What underlies appraisals?: Experimentally testing a knowledge-and-appraisal model of personality architecture among smokers contemplating high-risk situations. *Journal of Personality*, *76*, 929–967.
- Cervone, D., & Mischel, W. (Eds.). (2002). *Advances in personality science*. New York: Guilford Press.
- Churchland, P. (1981). Eliminative materialism and the propositional attitudes. *Journal of Philosophy*, *78*, 67–90.
- Cronbach, L. J. (1957). The two disciplines of scientific psychology. *American Psychologist*, *12*, 612–684.
- Danziger, K. (2000). Making social psychology experimental: A conceptual history, 1920–1970. *Journal of the History of the Behavioral Sciences*, *36*, 329–347.
- Deary, I. J. (2000). *Looking down on human intelligence: From psychometrics to the brain*. Oxford: Oxford University Press.
- De Groot, A. D. (1978). *Thought and choice in chess*. Den Haag, Mouton.
- Ellis, J. L., & Wollenberg, A. L. v. d. (1993). Local homogeneity in latent trait models: A characterization of the homogeneous monotone IRT model. *Psychometrika*, *58*, 417–429.
- Eysenck, H. J. (1970). *The structure of personality*. (3rd ed.). London: Methuen.
- Fodor, J. (1974). The special sciences, or: The disunity of psychology as a working hypothesis. *Synthese*, *28*, 97–115.
- Fodor, J. (1997). Special sciences: Still autonomous after all these years. *Nous*, *31*, 149–163.
- Freud, S. (1900/1953). *The interpretation of dreams*. *Standard Edition* (Vol. 4, pp. 1–338; Vol. 5, pp. 339–621). London: Hogarth Press.
- Freud, S. (1923/1961). *The ego and the id*. *Standard Edition* (Vol. 18, pp. 12–66). London: Hogarth Press.
- Gardner, H. (1993). *Frames of mind*. New York: Basic books.
- Garlick, D. (2002). Understanding the nature of the general factor of intelligence: The role of inter-individual differences in neural plasticity as an explanatory mechanism. *Psychological Review*, *109*, 116–136.
- Greenberg, J., Koole, S. L., & Pyszczynski, T. (Eds.). (2004). *Handbook of experimental existential psychology*. New York: Guilford Press.
- Gödel, K. (1931). Über formal unentscheidbare Sätze der Principia Mathematica und verwandter Systeme I. In Feferman, S. (1986). *Kurt Gödel: Collected Works*, (Vol. 1, pp. 144–195). Oxford: Oxford University Press.
- Goldberg, L. R. (1993). The structure of phenotypic personality traits. *American Psychologist*, *48*, 26–34.

- Hamaker, E. L., Dolan, C. V., & Molenaar, P. C. M. (2005). Statistical modeling of the individual: Rationale and application of multivariate time series analysis. *Multivariate Behavior Research*, *40*, 207–233.
- Hamaker, E. L., Nesselroade, J. R., & Molenaar, P. C. M. (2007). The integrated trait-state model. *Journal of Research in Personality*, *41*, 295–315.
- Harré, R. (1998). *The singular self: An introduction to the psychology of personhood*. London: Sage.
- Hermans, H. J. M. (2001). The construction of a personal position repertoire: Method and practice. *Culture and Psychology*, *7*, 323–365.
- Jaenisch, R., & Bird, A. (2003). Epigenetic regulation of gene expression: How the genome integrates intrinsic and environmental signals. *Nature Genetics*, *35*, 245–254.
- Jansen, B. R. J., & Van der Maas, H. L. J. (2002). The development of children's rule use on the balance scale task. *Journal of Experimental Child Psychology*, *81*, 383–416.
- Jensen, A. (1998). *The g factor*. Westport: Praeger.
- Jensen, A. (2002). Psychometric g: Definition and substantiation. In R. J. Sternberg & E. L. Grigorenko (Eds.), *The general factor of intelligence: How general is it?* (pp. 39–54). Mahwah: Erlbaum.
- John, O. P., & Srivastava, S. (1999). The big-five factor taxonomy: History, measurement, and theoretical perspectives. In L. A. Pervin & O. P. John (Eds.), *Handbook of personality: Theory and research* (2nd ed., pp. 102–138). New York: Guilford Press.
- Kanazawa, S. (2004). General intelligence as a domain-specific adaptation. *Psychological Review*, *111*, 512–523.
- Krueger, R. F. (1999). The structure of common mental disorders. *Archives of General Psychiatry*, *56*, 921–926.
- Kuhl, J., & Koole, S. L. (2004). Workings of the will: A functional approach. In J. Greenberg, S. L. Koole, & T. Pyszczynski (Eds.), *Handbook of experimental existential psychology* (pp. 411–430). New York: Guilford.
- Lamiell, J. T. (1987). *The psychology of personality: An epistemological inquiry*. New York: Columbia University Press.
- Lykken, D. T. (1991). What's wrong with psychology anyway? In D. Cicchetti & W. M. Grove (Eds.), *Thinking clearly about psychology. Vol. 1: Matters of public interest* (pp. 3–39). Minneapolis, MN: University of Minnesota Press.
- McCrae, R. R., & Costa, P. T., Jr. (1996). Toward a new generation of personality theories: Theoretical contexts for the five-factor model. In J. S. Wiggins (Ed.), *The five-factor model of personality: Theoretical perspectives* (pp. 51–87). New York: Guilford.
- McCrae, R. R., & Costa, P. T., Jr. (2008). Empirical and theoretical status of the five-factor model of personality traits. In G. Boyle, G. Matthews, & D. Saklofske (Eds.), *Sage handbook of personality theory and assessment* (Vol. 1, pp. 273–294). Los Angeles: Sage.
- Meredith, W. (1993). Measurement invariance, factor analysis, and factorial invariance. *Psychometrika*, *58*, 525–543.
- Miele, F. (2002). *Intelligence, race, and genetics: Conversations with Arthur Jensen*. Boulder, CO: Westview Press.
- Mischel, W., & Shoda, Y. (1995). A cognitive-affective system theory of personality: Reconceptualizing situations, dispositions, dynamics, and invariance in personality structure. *Psychological Review*, *102*, 246–286.
- Molenaar, P. C. M. (1999). Longitudinal analysis. In H. J. Ader & G. J. Mellenbergh (Eds.), *Research methodology in the social, behavioural, and life sciences* (pp. 143–167). London: Sage.
- Molenaar, P. C. M. (2004). A manifesto on psychology as ideographic science: Bringing the person back into scientific psychology, this time forever. *Measurement*, *2*, 201–218.
- Molenaar, P. C. M., Boomsma D. I., & Dolan, C. V. (1993). A third source of developmental differences. *Behavior Genetics*, *23*, 519–524.
- Molenaar, P. C. M., Huizenga, H. M., & Nesselroade, J. R. (2003). The relationship between the structure of interindividual and intraindividual variability: A theoretical and empirical vindication of developmental systems theory. In U. M. Staudinger & U. Lindenberger (Eds.), *Under-*

- standing human development: Dialogues with lifespan psychology* (pp. 339–360). Dordrecht: Kluwer Academic Publishers.
- Muthén, B. O. (1989). Latent variable modeling in heterogeneous populations. *Psychometrika*, *54*, 557–585.
- Pearl, J. (2000). *Causality: Models, reasoning, and inference*. Cambridge, England: Cambridge University Press.
- Posthuma, D., de Geus, E. J. C., Baaré, W. F. C., Hulshoff Pol, H. E., Kahn, R. S., & Boomsma, D. I. (2002). The association between brain volume and intelligence is of genetic origin. *Nature Neuroscience*, *5*, 83–84.
- Simpson, E. H. (1951). The interpretation of interaction in contingency tables. *Journal of the Royal Statistical Society*, *13*, 238–241.
- Sternberg, R. J. (1985). *Beyond IQ: A triarchic theory of human intelligence*. Cambridge: Cambridge University Press.
- Sternberg, R. J., & Grigorenko, E. L. (2001). Unified psychology. *American Psychologist*, *56*, 1069–1079.
- Timmerman, M. E., Ceulemans, E., Lichtwarck-Aschoff, A., & Vansteeland, K. (2009). Multilevel simultaneous component analysis for studying intra-individual variability and inter-individual differences. In J. Valsiner & P. C. M. Molenaar (Eds.), *Developmental process methodology in the social and developmental sciences* (pp. 291–318). New York: Springer.
- Van der Maas, H. L. J., Dolan, C. V., Grasman, R. P. P. P., Wicherts, J. M., Huizenga, H. M., & Raijmakers, M. E. J. (2006). A dynamical model of general intelligence: The positive manifold of intelligence by mutualism. *Psychological Review*, *113*, 842–861.
- Van Geert, P. (1991). A dynamic systems model of cognitive and language growth. *Psychological Review*, *98*, 3–53.
- Van Rijn, P. (2008). *Categorical time series in psychological measurement*. University of Amsterdam, Unpublished doctoral dissertation.
- Verguts, T., & De Boeck, P. (2002). The induction of solution rules in Raven's Progressive Matrices test. *European Journal of Cognitive Psychology*, *14*, 521–547.
- Whitehead, A. N., & Russell, B. (1910). *Principia mathematica*. Cambridge: Cambridge University Press.

# Chapter 5

## The Experimental Methodology of Constructive Microgenesis

Brady Wagoner

*(T)he search for method becomes one of the most important problems of the entire enterprise of understanding the uniquely human forms of psychological activity. In this case, the method is simultaneously prerequisite and product, the tool and the result of the study.*

Vygotsky (1987, p. 27)

Psychologists congratulate themselves in telling their discipline's history as a linear progression to its present state, as if psychology was purely rational and free from all historical contingency. In so doing we close ourselves to past ideas that were unjustly left behind and which can make a significant contribution to psychology today. The word 'experiment', for example, has taken on a very narrow meaning in contemporary psychology. We are told that for something to be an experiment there must be an independent and dependent variable, a large random sample of participants, and a statistical analysis of scores. These requirements were foreign to psychology in the first half of this last century and only became social norms through influences *outside* of psychology, such as the military and education (Danziger, 1990).

Let us travel back to the pre-WWII era of psychology, where associations to 'experiment' were quite different (Danziger & Ballantyne, 1997). The word was used broadly, at this time, to describe, for example, research that was both qualitative and idiographic, as illustrated by the work of Bartlett, Luria, Piaget, Vygotsky, and Werner, to name but a few eminent psychologists. These early pioneers invented their own methods of experimentation to best explore their particular research interests and did so systematically, transparently and with analytic rigor. Here I adopt the older, more inclusive meaning of 'experiment,' used by these methodologists, as a *purposeful distortion of ordinary reality* carried out to systematically provoke, access, and analyze some generic aspect(s) of reality

---

B. Wagoner (✉)  
Department of Social and Development Psychology  
University of Cambridge  
Cambridge CB2 3RQ, UK  
e-mail: bw249@cam.ac.uk

(Valsiner, 1998, p. 317).<sup>1</sup> By (re)opening the definition I hope to also open new pathways to innovation in *experimental* methodology.

I concentrate in this chapter on exploring and developing one particular pre-WWII methodology, which has come to be called “the microgenetic method”. My aim is to use this method as a starting point in developing a methodology that is sensitive to complex individual functioning, constructive and imaginative processes, systemic and qualitative changes, inter- and intra-individual variation, and the analysis of deviance. My focus will be on using the method to study remembering but it can just as well be applied to other higher psychological functions. I will review some of the longstanding methodological questions in psychology, such as “what sources of data are valid?”, “how should experimenters relate to their participants?”, “how do we generalize from the data?”, offering reasoned answers to them, in order to re-evaluate, re-invigorate and re-invent experimental methodology.

## The Microgenetic Method: Three Case Studies

The microgenetic method is “any empirical strategy that triggers, records and analyses the immediate process of emergence of new phenomena” (Valsiner, 2000, p. 78). A wide range of experimental strategies fit this definition. In this section, we will compare and contrast the work of three classic examples, each quite different from the others, to show concretely the method’s principles, power and versatility.<sup>2</sup> They are: (1) Heinz Werner’s simulation of aphasic processes, (2) Vygotsky’s method of double stimulation in his study of memory and (3) Frederic Bartlett’s method of repeated reproduction.<sup>3</sup>

### *Heinz Werner’s Microgenetic Method*

The word “microgenesis” was first introduced, in English, in a 1956 article by Werner, titled “Microgenesis and aphasia”. His method was a further development of *Aktualgenese* used by the second Leipzig school to study perception (see Diriwächter, 2009). Perception is a seemingly instantaneous process. To access it

<sup>1</sup> One could also call this approach an “Einsteinian” experimental methodology (see Holton, 1988).

<sup>2</sup> A general history of the microgenetic method is not our focus here. It can be found in Catán (1986) and Valsiner and van der Veer (2000, Chapter 7).

<sup>3</sup> I chose these three because they are classic studies in the microgenetic tradition which are different enough to allow for broad comparisons. Additionally, Vygotsky and Bartlett’s experiments are milestones in the socio-cultural study of remembering, while Werner’s helps us to conceptualize the process by which we struggle to articulate a memory that we are feeling but cannot yet precisely describe (i.e. the ‘tip-of-the-tongue’ phenomenon).

one has to find ways of slowing it down in order to catch its intermediate stages. The technique innovated for this task was *Aktualgenese*, in which participants were presented with a series of stimuli beginning in suboptimal conditions (blurry, small, at a distance, for a short time, at the edge of one's peripheral field, etc.) and progressively moving toward greater stimulus clarity, recording participants' percepts at each step. Thus, the researcher had both a rich record of the process through its various stages and of the participant's creative adaptations to perceptual ambiguity.

Werner's innovation was to adapt the method to simulate more complex social processes, such as the development of word meaning in ontogeny (Werner & Kaplan, 1954), the development of language syntax in sociogenesis (Werner & Kaplan, 1957) and to model aphasic speech comprehension (Werner, 1956). Here we will limit our focus to this last experiment on aphasia, in which a tachistoscope was used to flash phrases in front of participants at short intervals. Participants had to report what they saw and their accompanying thoughts and feelings at each stimulus exposure. Consider the following example of a participant who read the tachistoscopically presented phrase "*sanfter Wind*" (gentle wind):

1. "—? Wind." What stood before "wind" feels like an adjective specifying something similar. Definitely not a word defining direction.
2. "—ter Wind." Know now that the word is "heavier" than "warm"... somehow more abstract.
3. "—cher Wind." Now it looks more like an adjective-of-direction.
4. "—ter Wind." Now again somehow more concrete, it faces me and looks somewhat like "*weicher Wind*" (soft Wind), but "*ter*" is in my way.
5. Now very clearly: "sanfter Wind." Not at all surprised. I had this actually before in the characteristic feel of the word and the looks of it.

(Werner, 1956, p. 348)

Through this series we can make inferences about the relationship between fully articulated meanings of words (on the left in quotation marks) and "spherical cognition" (on the right). The participant seems to get a feeling of the word—i.e. an "inner experience of the semantic sphere of the linguistic forms" (p. 348)—before they can articulate precisely what it is. This can be seen by reading *between* one step in the series and the next, comparing what is articulated to what the participant felt at an earlier stage. Werner concludes from this analysis that spherical cognition is developmentally earlier than articulation of discrete words (we have a sense of this when something is on "the tip-of-our-tongue", such as a vague memory).

It should also be noted that these earlier phases in the process can be much richer than the final product (i.e., the fully articulated phrase); they are full of tension, in a state of becoming. At these early points the participant must imaginatively overcome the ambiguity presented by the experimenter, and do so full of intense emotional involvement (Rosenthal, 2004). This *constructive* aspect of the methodology is lost in contemporary commentaries on it, which tend to emphasize the aim of displaying the different fixed *steps* in a process (see Valsiner & van der Veer, 2000, pp. 312–320).

A comparison is made with aphasic patients on the assumption that "the functions underlying abnormal behavior are in their essence not different from those

underlying normal behavior” (p. 347). In other words, aphasics go through the same process as normally functioning individuals in speech comprehension but for them this process is cut short so that they are left with a feeling of a word but are unable to articulate it in its discrete form; the final product of the process is for them unfinished. The method could thus *model* speech comprehension of aphasics in normally functioning individuals.

In sum, Werner modified the method of *Aktualgenese* to capture constructive steps in the process of speech comprehension and then pieced the series of steps together again in his analysis to develop a model of the process applicable to both normally functioning individuals and aphasics. The analysis was entirely idiographic and qualitative—only as such was he able to adequately show *transformations* from spherical cognition to discrete articulation in the process of speech comprehension.

### ***Vygotsky’s Method of Double Stimulation***<sup>4</sup>

Vygotsky posits the existence of two interdependent lines of development in ontogeny, the natural and the cultural. The cultural line develops as the child participates with others in their social world. Vygotsky (1978) famously said that all higher psychological functions begin externally with others (inter-mentally) and are only gradually internalized so as to function for-one-self (intra-mentally).<sup>5</sup> Development proceeds dialectically as the cultural line feeds into the natural and the natural feeds back into the cultural: For example, Vygotsky (1986) shows the step-by-step changes that ensue when thought and speech intersect.

The methods developed by Vygotsky were attempts to capture the *structure* of the relationship between the two lines at various stages in child development. To do this he created an experimental situation in which the child could use some “external mediator” (e.g., an image, a card, a rope, an abacus, etc.) to help them complete a task, which represented the development of the cultural line. Results of this mediated task were often compared with child’s performance on a task without the external mediator (approximating the natural line), so as to separate and compare the two lines of development—cultural, mediated; and the natural, unmediated (Vygotsky & Luria, 1994).

One of Vygotsky’s favorite examples to illustrate his theory and method was his studies on memory. In an experiment conducted by Leontiev, under Vygotsky’s guidance, they adopted the standard memory procedure in which a child had to remember a list of words but with a major innovation. Children were given picture

<sup>4</sup> Vygotsky also refers to his method as the “experimental genetic method,” “instrumental method” and “historical-genetic method” (Engeström, 2007).

<sup>5</sup> Not everything on the inter-mental plan is internalized, only that for which there is dramatic conflict, i.e. a problem that creates inner tension. Similarly, when the child later encounters a problem intra-mentally he or she will utilize means borrowed from an inter-mental drama to overcome it (see Veresov, 2008).



cards (in other words, external mediators) to aid them in recall. They created three experimental conditions for remembering a list of words: (1) standard memory task, (2) task with picture card already conventionally paired with word by the experimenter, and (3) the child is allowed to make their own combinations between words and picture cards. At first they simply compared the scores of children at different ages for mediated (conditions 2 and 3) and unmediated (condition 1) memory, in order to validate Vygotsky's theory of the developing relationship between the two lines.

However, it was Vygotsky's careful look at the *microgenetic process* by which children used the picture cards in remembering that led him to alter his theory of mediation (Bakhurst, 1990). This process is experimentally triggered by the experimenter by giving the child a task beyond their capacity and providing them with neutral objects that the child can give significance to (i.e., transform them into external mediators) in order to help them solve the task. It must be noted that the resultant process is produced by the child's own agency, not the experimenter's; the experimenter may *guide* the child toward a particular "means" but cannot *determine* how the child will use them if they do at all (van der Veer & Valsiner, 1991). Unlike the maximum control of contemporary experiments, which must create easily quantifiable data for statistical comparison, the method of double stimulation profits from the participant's construction of novelty, the active creation of new means to solve a problem.

One might expect children to make links between picture card and target word through strong associations between them, for example using the picture of a 'horse' to remember 'sled'. But children often also made non-obvious links between picture and word. For example, one child used a picture of a crab at the beach to remember 'theatre', explaining "The crab is looking at the stones on the bottom, it is beautiful, it is a theatre" (Vygotsky, 1987, p. 181). Structures, such as these, were created for the first time by the child and could not be explained within the framework of associative psychology—they were more narrative than associative bond. A more complex explanation would have to be sought that captured the nuances of child's reasoning.

Vygotsky (1987) experimentally isolated the components of the process by which children successfully or unsuccessfully arrived at the target word. The first component resembles Vygotsky's original theory of mediation, whereby the child uses a sign in the act of remembering. The child does use the picture card to help them remember but the process is not yet integrated with the operations of imagining, thinking, abstracting, etc. With only this component functioning children sometimes create absurd structures, such as "I remember this like a *fish* at a *funeral*" (p. 183, my emphasis). Experimenters can facilitate the child's creation of new structures by simply drawing their attention away from the target word to related words or a part of the object itself, and thus providing the scaffolding required for the child to successfully complete the task by opening up meaningful elaboration of the stimulus.

The second component is the child's (unaided) ability to create their own novel structure, as we saw with the child's narrative connecting "crab" to "theatre". This component may be present while the first is not. In that case the child is unable to

use the structure for remembering. The child does not realize that one item can be used to bring to mind the other.

The third component is the child's ability to select and direct the mass of emerging images toward the target word, which is placed at the center of the child's attention, as if marked by an X. One child, for example, selected a picture of a lion to remember the verb "to shoot," saying "they shot the lion". However, when the child recalled the word he remembered instead the word "gun" (p. 182). Children without this component could often reproduce the entire structure without arriving at the target word.

In these three components the different psychological functions involved in remembering—interpreted from children's errors—have been experimentally isolated. Each can exist without the others. Furthermore, this analysis provides evidence for Vygotsky's claim that psychological functions gradually become integrated in development, transforming each other in the process. Here we see the gradual integration of instrumental action (component 1), imagination (component 2), and attention (component 3).

In sum, it was Vygotsky's interest and analysis of the *means* and *process* of remembering that lead him to revise his theory of mediation. Through this analysis he was able to explain the various *outcomes*, including both accurate recall and different kinds of errors, as well as experimentally isolating different components active in remembering. He was successful in working between the analysis of individual cases and general developmental trends across an enormous sample by using idiographic qualitative data to understand the structure of the process at various stages of development.

### ***Bartlett's Method of Repeated Reproduction***

Bartlett developed his method for studying remembering in contradistinction to Ebbinghaus' method of non-sense syllables. Ebbinghaus understood memories to be like imprints left on the mind; he explicitly uses the metaphor of inscription (dating back to Plato's *Theaetetus*). As such Ebbinghaus felt justified using meaningless material that would remain isolated from other material (i.e., not combine into wholes) and could be analyzed by the number of non-sense syllables remembered under a variety of conditions (time between exposure and recall, order in a series, amount of exposure, etc.). Bartlett rejected these assumptions arguing that remembering studied by Ebbinghaus had little to do with the remembering in everyday life, and as such he developed methods that could capture and analyze remembering as a holistic, dynamic and meaningful process.

One of the first methods he used to study remembering was the method of repeated reproduction. Bartlett was not the first to use the method [both Philippe (1897) and Henderson (1903) had used it earlier] although he used it more productively than those who came before and after (Wagoner, 2007). The procedure was simple: participants were presented with a stimulus (e.g., a folk-story, newspaper

article, or image) and later asked to reproduce it at a number of intervals (e.g., after 20 minutes, a week, several months). In this way, a *series* of reproductions was produced, which could then be analyzed for what was *added*, *deleted*, and *transformed* from the original to the first reproduction and from a reproduction to the next. The following is an example of a portion of data produced using the method of repeated reproduction for the Native American story *War of the Ghosts* (Bartlett includes the full reproductions):

*The original*

He told it all, and then he became quiet. When the sun rose he fell down. **Something black** came out of his mouth. His face became contorted. The people jumped up and cried.

He was dead.

*First Reproduction (time after reading story not given)*

It was nearly dawn when the man became very ill; and at sunrise a **black substance** rushed out of his mouth, and the natives said one to another: "He is dead".

*Second Reproduction (nearly 4 months later)*

Then, I think it is, the natives describe what happened, and they seem to have imagined seeing a **ghost** coming out of his mouth. Really it was a kind of **materialization of his breath**. I know this phrase was not in the story, but that is the idea that I have. Ultimately the man died at dawn the next day.

(Bartlett, 1932, pp. 70–71, added emphases in boldface)

To take just one example of Bartlett's analysis, of reading *between* the reproductions, look at what happens to the mysterious "something black" in the original through the two reproductions. First, it is transformed into a 'black substance' already attributing volition to the entity that '*rushed out* of his mouth'. In the second reproduction the 'black substance' becomes 'a ghost' and 'a materialization of his breath'—the former being from the native's perspective, whereas the latter is from his own. Bartlett (1932) found this 'double meaning' would frequently be transformed into a single rationalized meaning in the participant's next reproduction. It was also common, across his sample, to see participants rationalize out the supernatural portions of the story, either by simply omitting them or explaining them away, as this participant did.

This analytic strategy of attending to qualitative transformations in single cases is radically different from contemporary 'reproductions' of Bartlett's experiment (Gauld & Stephenson, 1967; Roediger, Bergman, & Meade, 2000), which create 'average participants' by meaning the number of distortions, omissions and accurate units recalled for all participants in each time condition. This later approach completely misses Bartlett's interest in the *systemic* functioning of specific individuals. By analyzing reproductions only at the level of aggregates contemporary researchers have lost sight of the constructive qualitative changes occurring within a single participant and their relationship to the participant's personal history (Wagoner, 2007). Deviations from the original experience are simply quantified as "distortions" without attending to the nature of the change. In the place of "distortion", Bartlett uses the functional terminology of "elaboration," "construction," "conventionalization," etc., thus emphasizing the mechanisms constraining and driving the holistic and creative *process* of remembering over its static *products*.

Bartlett's (1932) analytic strategy began with single cases and their transformations through time, but did not end there. He proceeds to analyze the general trends found across his entire sample (e.g., 'canoes' become 'boats' in over half his participants by the second reproduction) and compares the results to that of other experiments he has conducted in perceiving, imagining and remembering.<sup>6</sup> Similarly, when only one participant out of twenty remembers the two proper names in the story *War of the Ghosts* he does not ignore it but instead devotes considerable space, in a later chapter, towards integrating it into his general theory of remembering (see pp. 208–209). Thus his methodological movement to develop theory is from single case to general model, and back to single case.

In sum, only by using rich cultural material and analyzing *individual cases* and their *qualitative transformations* through time (e.g., 'something black' changing into 'breath') did Bartlett access the *constructive, imaginative and active* processes of remembering, as we use it in everyday life.

## Comparison of the Methods

### *Common Origins: A Brief Sketch of the Würzburg School*

All three methodologists developed their approach out of early continental psychology with its emphasis on holism, development and the creative side of human life. A particularly clear example of the early continental *Zeitgeist* is the Würzburg School, active in the first decade of the last century, which Vygotsky,<sup>7</sup> Bartlett,<sup>8</sup> and Werner<sup>9</sup> all borrow from. It will therefore be helpful to sketch out some general methodological features of this school to create a background in which to assess similarities and differences among the three.

The Würzburg School was the first movement to experimentally investigate the mechanisms of thinking. Breaking with Wundt's doctrine that higher psychological functions could not be studied through experimental methods, they invented a new methodology of *guided introspection* (Wagoner, 2008b) or *retrospective self-observation* (Kusch, 1999). Participants were given questions, such as "do you understand x?" They were to work out an answer silently and then give their answer aloud. This was immediately followed by their description of the process through which they arrived at the answer, which was believed to persist in memory for this short interval of time. The following is an example:

---

<sup>6</sup> Bartlett, as well as Werner and Vygotsky, clearly believed in "the unity of mentality" (Edwards & Middleton, 1987): Any demarcation between the mind's processes will be arbitrary because the mind is a systemically functioning totality.

<sup>7</sup> See van der Veer and Valsiner (1991).

<sup>8</sup> This influence is particularly evident in Bartlett's *St. Johns fellowship dissertation* (1916). Later in his life he is more dismissive of the Würzburg School's accomplishments (see Bartlett, 1951).

<sup>9</sup> See Diriwätcher (this volume) for the Würzburger's influence on the second Leipzig school.

Experimenter (Karl Bühler): “Do you understand: *when the minds begin to moralize, the devils are set loose*”?

Observer (Ernst Dürr): <9 s> “Yes”—“...comprehension came with the word: Nietzsche. This stood for the thought: Nietzsche is an example that one wants both to be witty and treat of ethics, one is shadow-boxing”.

(From Diriwächter & Valsiner, 2005, p. 20)

Through the analysis of retrospective reports, guided by their reading of the philosopher Brentano, the Würzburgers elaborated a theory of consciousness that emphasized its *intentional* character, in opposition to Wundt’s passive theory of images and sensations. Above and beyond Wundt’s contents of consciousness they added characteristics relating to purpose and motivation.<sup>10</sup> Participants often reported consciousness of task orientation, directedness toward a goal, monitoring of progress, and related feelings. These were often unconscious but would become conscious under specifiable conditions, such as spontaneously asking for introspective reports *before* the task had begun.

In brief, this methodology emphasizes (1) attending to the active *process* of thinking over the *product* (in the above case, the “yes”), (2) the analysis of rich qualitative data containing components irreducible to simply sensation and imagery, and (3) a close interdependent relationship between experimenter and participant. In what follows I will expand on each one of these points, showing how they were developed by Werner, Vygotsky and Bartlett.

### Process and Product

A process approach is concerned with “becoming” (i.e., unfolding events, transformation, and synthesis), whereas a product approach is concerned with “being” (i.e., comparing and contrasting static objects; Wagoner, 2008a). Table 5.1 contrasts the two in logical form:

**Table 5.1** A contrast between product and process approaches (Wagoner, 2008a, a modification of Valsiner, 2003)

Product approach	Process approach
X = [is] = X	X —[remains]→ X
or	or
X ≠ [is not] ≠ Y	X —[becomes]→ Y

<sup>10</sup> It should be noted that Bartlett’s own concept of ‘attitude’ is extremely close to the Würzburger’s early concept of *Bewusstseinslage*, literally “position of consciousness”. It was first mistranslated by Titchener (1909) as “attitude” and later by Boring (1950) as ‘conscious attitude’ (see Danziger, 1997, Chapter 8). Kusch’s (1999) recent translation as ‘situation of consciousness’ comes closer to the original though perhaps misses its *directed* character. The concept encompassed a whole range of phenomena from feelings of surprise, excitement and familiarity to expectation, coercion, contrast and agreement (see Larsen & Bernsten, 2000, for comparison with Bartlett).

In all the methodologies mentioned above we find a process approach, i.e. a focus on capturing processes and the general analytic strategy of reading *between* moments in their evolution; however, there are important differences between them.

First, there is the question of a process's *direction*. Werner (1957, p. 126) famously defined development as "proceed(ing) from a state of relative globality and lack of differentiation to a state of increasing *differentiation, articulation, and hierarchical integration*". For example, an embryo develops from a bundle of *undifferentiated* cells to *articulated* cell types of *differentiated* cell systems (organs), which are in turn *hierarchically integrated*, such that one organ regulates the functioning of another. This explicitly biological metaphor captures the dynamics of some processes (e.g., basic perceptual processes—see Rosenthal, 2004) or Vygotsky's focus on remembering a target word, but misses some important aspects of others. Bartlett's experiments, by contrast, show how we increasingly remember the *gist* of an event rather than the particular details: Events blend together with other events in the process of generalizing out of specific encounters toward conventional schema. This tendency of remembering is highly functional for the organism and should not be treated as a kind of 'distortion,' as contemporary memory theorists often do. Luria's (1987) portrayal of the mnemonist Schereshevskii provides evidence that exceptional memory for details can be highly problematic to overall functioning (see below). As such, we could consider this type of generalization—into forms that are *less* easily articulated—a developmental advance rather than a regression (see Valsiner, 2007, Chapter 7). For example, most of Bartlett's participants failed to reproduce the phrase "a calm and foggy night" but retained a *feeling* of "sympathetic weather". One participant commented, "I formed some sort of association, I do not know what, in connection with the *thick, still evening* on the river..." (Bartlett, 1932, p. 80, italics added).

Second, we need to make a distinction between two different kinds of micro-genetic methods: one in which the end product is fixed (e.g. "sanfter wind" in Werner's experiment) and another in which something novel emerges at the end of the process. Bartlett's method of repeated reproduction clearly fits into the second category. Werner increased the constraints on novelty in the course of the experiment (the full articulation of the phrase is the same for all participants), while in Bartlett's experiment the stimulus moves toward increasing *unclarity*, such that the constructive (imaginative) side of remembering takes a greater role over instantaneous remembering. For example, the above participant transforms "black substance" into "a ghost"—the participant was clearly mediating their remembering through their (dis)beliefs about the supernatural. Vygotsky's method is similar to Werner in its focus on the movement from diffuse to articulate, however like Bartlett it was possible for the end product to be a novel structure, particularly in his third condition in which the child paired word with image—for example, the child who remembered 'theatre' through a picture card of a crab at the beach. Following our aim to create a 'constructive' method it is important to keep in mind the need to allow a degree of openness in the participant's constructions.

Third, in regards to *timescale*, Werner deals with a process that happens so quickly it must be experimentally slowed down (see parallels with *Aktualgenese*, Diriwächter, 2009; Rosenthal, 2004); Vygotsky observes remembering *in vivo* within

a single experimental session; while Bartlett analyzed remembering as a process occurring over weeks, months and years. The fact that Bartlett did not systematically capture the moment-to-moment experiencing of his research participants, as did Werner and Vygotsky, is a weakness of his methodology. Bartlett makes claims about this micro-level process but only systematically accesses its outcomes.<sup>11</sup> He relies on observations and participants' introspective reports rather than accessing the micro-level process directly. In the next section we will explore Vygotsky and Werner's strategy for capturing micro-level processes *in vivo*.

### ***What Counts as Data?***

Perhaps, the most widely known debate in the history of psychology was that between the Würzburgers and Wundt over the interpretation of introspective data, and more superficially the contents of consciousness (see Humphery, 1951; Kusch, 1999). Wundt had claimed that only lower psychological processes (e.g. those in psychophysics) could be studied experimentally. In his laboratory the introspective report occurred immediately after stimulus presentation, which gave participants less space for memory distortions and alternative constructions of the task.<sup>12</sup> In contrast, the Würzburg School explicitly set out to study higher psychological processes through a *retrospective* report on their process of thinking. They found contents (i.e. imageless thought) that contradicted Wundt's theory of consciousness. Wundt unsurprisingly attacked them on the basis of their methodology, while Titchener (one of Wundt's students and misunderstanding followers) used Würzburg methods to defend Wundt's theory.

How then can we experimentally access mind? Or is the task hopeless? Are we confined to a study of its cultural products—such as art, language, folk-lore—i.e. to indirectly observe mind, as Wundt believed? Or would it be advantageous to replace 'mind' with the 'directly observable,' i.e. behavior or a brain scan? Fortunately, the methodologies of Werner and Vygotsky offer us an innovative alternative to 'observe mind'. For them *mind is mediation*, i.e. the embodiment of thoughts and experience within a *cultural medium*. It is not tenable to talk of unmediated verses mediated thought; all thinking must be viewed as "coming-into-being and formed in terms of different material media, such as verbal code, gesture language, linear expressions, etc" (Werner & Kaplan, 1957, p. 4). For example, Catán (1989) shows how children's experience of musical melodies is transformed in dialectical fashion as they develop more sophisticated notational systems to record the music. More

<sup>11</sup> Edwards and Middleton (1987) point out that Bartlett conversed with his participants during his experiments and used this data to interpret their reproductions. This, however, is not "systematic" access to their moment-to-moment remembering.

<sup>12</sup> The role of interpretation was not even eliminated in Wundt's strict experimental setup. For example, concerning the two-point threshold, Binet (1903) showed participant's interpretation of "two-points" differed depending on their interpretation of the task. Some participants interpreted "two-points" from a broader heavier single point or a bell shaped point. In short, describing in more detail the qualitative character of the sensation changed the results of Wundt's experiment (Danziger, 1990).

complex media for representing the melodies allowed for more complex experience of the music, which in turn feedback into the development of their notation.

Thus, we have direct access to mind when some external media is used to solve a task, e.g. a notational system, knots on a rope, pictures, writing, external speech, etc. The genius of Vygotsky's method of double stimulation was to provide participants with an *external mediator* (i.e. a picture card) to help them solve the task, so that their thinking would "come-into-being" through this visible medium, thus *objectifying* psychological operations: By slightly altering the memory task he shifted the boundary between what psychological processes were visible and which were invisible. In short, the *demands of the task* and *availability of tools* determine whether thinking processes are observable to the researcher.

But the picture card is still only one component of thought in Vygotsky's experiment (the instrumental component). To complete the task successfully the child must also create a meaningful *narration* that links the picture card to the target word; the child must form a *structure* (with the imaginative component) and navigate it (with attention component). For this, thinking must pass through the medium of speech. We saw how Werner (1956) used this shaping power of speech to access participant's imposition of order onto the unclear (diffuse) phrase.<sup>13</sup> The participant was giving meaning to the word-image in speech and at the same time elaborating its form (like reporting images in an inkblot). With this method we overcome the Würzburg School's problem of separating out *description* of what happened from a *representation, expression or announcement (Kundgabe)* of it. Speech is not taken as describing a process of thought (as in the Würzburg School) but is a form of thinking itself, whose temporal unfolding is directly accessible to the researcher. It can thus function in analysis as both process and product of some experimental manipulation.

Before closing this section I should say that we need not completely avoid using complex retrospective data—not even Wundt went that far in his criticisms and experimental work. Rather we must simply limit its use in our analysis: It cannot be treated as the primary source of data when dealing with higher psychological functions as in the Würzburg School, but might be used as a secondary data source to reveal something interesting about the primary data, as Bartlett uses it to comment on his primary data of story reproductions, visual reconstructions of images, etc. Also, retrospective data can give us an accurate account of the *general impressions* of doing a task or of the stimuli involved, but cannot be used as evidence for the details.

### ***The Relationship Between Experimenter and Participant***

Another major topic of controversy in the early years of psychology was how the experimenter and participant were to be related (see Danziger, 1990; Kusch, 1999). For the Würzburgers the relationship could best be described as a 'dialogue' or even an 'interrogation', whereas Wundt emphasized a need to isolate the experimental

---

<sup>13</sup> For another example of this 'think-aloud' research strategy see Diriwächter, this volume.



participant, recommending that where possible the experimenter and participant be in separate rooms. All three methodologists were probably closer to the Würzburgers in that the experimenter was an essential part of the experimental situation (as a *guide* to thinking and as an interlocutor for the communication of complex subjective experiences) and also that they focused on ‘higher psychological processes,’ which Wundt would have preferred to relegate to his non-experimental *Völkerpsychologie*. Let us briefly consider the relationship between experimenter and participant for each methodologist.

Werner retained aspects of Wundt’s approach: For example, his participants’ constructions occurred in relationship to a fixed objective stimulus, like in Wundt’s approach but not the Würzburgers’. Secondly, he accesses their constructions as they occur in speech, not after there is a delay. What brings Werner closer to the Würzburgers is his active role as experimenter *guiding* participants from one sub-trail to the next, although not within the sub-trail as we saw in the Würzburg example, and as an interlocutor for his participants’ feelings and thoughts.

As in the Würzburgers’ experiments, many of Bartlett’s research participants were friends—thus, he knew their interests and backgrounds. Bartlett saw this as a potential source of insight into their responses, not an interpretive bias or confounding variable—he saw Ebbinghaus’ attempt to exorcise personal history from the laboratory as a failure. He comments,

If the experimentalist in psychology once recognizes that he remains to a great extent a clinician, he is forced to realize that the study of any well developed psychological function is possible only in the light of consideration of its history

(Bartlett, 1932, p. 15).

In the course of the experiment we have the sense that Bartlett sits near to his participants, taking notes on their responses, even discussing with them at various points about their experience (Edwards & Middleton, 1987). He attends to his participants’ psychological realities—e.g. how they understand and approach the task—just as much as the ‘objective’ features of the situation.

Vygotsky would occasionally change roles slightly within the experiment, using the closeness between child and researcher to further investigate the abilities of individual children. He tested his interpretation of children’s functioning by providing support to the child who was missing one component of the remembering process. In scaffolding the missing component Vygotsky’s theory would predict the child would be able to complete the task. Thus, like the Würzburgers and Bartlett, his method was not completely standardized, making for a flexible situation to both generate and test hypotheses.

This technique of experimentation was further developed by Luria (1970) in his idiographic studies of brain damaged patients: If his diagnosis of psychic malfunctioning was correct, a particular kind of intervention would prove successful (see also Wagoner, 2007). Piaget’s clinical interview method fits this conception of hypothesis equally well. The experimenter asks questions to the child in order to ask further questions. There is no fixed set or sequence of questions: the experiment evolves as a *conversation* between experimenter and child, in which the experimenter frames hypotheses about the child in the course of the experiment and tests them against the child’s responses (Duveen, 2000).

In sum, the experimenter and the research participant do not necessarily have to have fixed roles and rigidly controlled procedures. Nor does an experiment have to be purely deductive (i.e., about proving or disproving a hypothesis). Such approaches often cut out the most interesting characteristics of the phenomena, such as participant's unique personal history and novel constructions. Instead, experiments can be conceived as situations to generate hypotheses and "explore" the complexities of some phenomena through the participant's constructive responses to the experimenter's manipulations. This is particularly true in the study of processes and development.

## Two Pathways to Generalization and Their Synthesis

To broadly compare different microgenetic methods, we have reviewed some of the procedural controversies of early experimental psychology—mainly process versus product orientated methods, retrospective versus visible access to thinking, familiarity versus anonymity between experimenter and participant, and standardized versus non-standardized procedures. In this section, we will broaden our focus still further to explore *different interpretive strategies by which researches arrive at general knowledge of some phenomena*. Our general comparison shifts at this point from different Continental methodologies, e.g. between the Würzburgers and Wundt, to a broader contrast between American and Continental research styles.<sup>14</sup>

Our goal in this section is to work toward a strategy of generalization that (1) produces complex theory by way of a rigorous interpretive approach, that (2) takes account of multiple sources of data and (3) explains cases deviant to the norm (e.g., in a standard distribution of scores). Of the two strategies of generalization, aggregate and single case analysis, neither alone can accomplish these aims. But if used together in a certain fashion they can complement each other and work toward our goal. It will be helpful to sketch out the general features of both, to bring to light what each can and cannot do, first in separation and then together. In the last portion of this section we will synthesis the two to incorporate the advantages of each, while best avoiding their limitations.

### *Aggregate Analysis*

Aggregate analysis was invented as a means to analyze questionnaire data aimed at uncovering the distribution of inter-individual difference variables within a large population. During this same period experimental research was highly idiographic, to the extent that individual participants were commonly referred to by name (Danziger, 1990). At the time only the latter approach was a conventionally

---

<sup>14</sup> For a general outline of this contrast see Toomela (2007 and in this book).

accepted scientific practice. Early aggregates studies were forced to establish the value of their knowledge by pointing to its “social relevance” (e.g., in grading individuals in the newly rationalized institutions, such as education) *not* its scientific merit, and by appealing to the lay public *not* expert scientists. European statisticians argued against the attribution of any isomorphism between collective and individual, between the ‘average subject’ and the ‘specific subject’.<sup>15</sup> For the inference from collectives to individual members to be made it would have to be assumed that “not only individual members were freely composable into aggregates [...] but, conversely, group attributions were to be regarded as nothing but summations of individual attributions” (p. 77). If this assumption is accepted one must then deny that individuals are in any way integrated (systemically functioning) wholes.

But how then, given these theoretical and institutional difficulties, did aggregate analysis find its way into the laboratory? Danziger (1990) argues that experimental psychology was increasingly pressured to provide knowledge serviceable for ‘large scale social control’ (p. 129) by way of statistically significant predictions of aggregates. Assessing the complexities of individual psychological systems was seen to offer very little toward these goals. One did not need to understand single cases but to find variables that would have effects on the level of whole populations. It is interesting to note that this convergence between applied and experimental psychology was much less pronounced in Germany than in America. Two factors account for this difference: First, it was the result of different social role structures in the two countries. German psychologists collaborated directly with teachers; in contrast, American psychologists tended to be involved with school administrators. Teachers were much more interested in psychological processes in the minds of individual children than school administrators, who oriented toward institutional rationalization and bureaucratic efficiency. Second, German academics continued their pursuit of philosophical questions even if they were also involved in applied research, while American psychologists had a “single-minded devotion to the ideal of calculated efficiency and rationalized performance” (p. 133).

I do not want to suggest by this historical analysis that aggregate analysis is unreliable as a scientific instrument but simply to limit its scope. What I am against is what Danziger (1990) calls “methodolatry,” the mechanical and automatic use of *one* single method without careful interpretation and observation. Aggregate analysis can be powerful in revealing certain *general trends* evident across participants but can tell us very little about individual psychological functioning on its own. Let us now consider what the skillful use of aggregate analysis can reveal by way of Vygotsky and Leontiev’s experiment reviewed above.

In their first analysis, they compare the scores (number of words remembered) of children at different ages in the mediated and unmediated conditions. Plotting the relationship between age and number of words remembered for the two conditions onto a graph (see Fig. 5.1<sup>16</sup>) we see the mediated remembering improving much more quickly over unmediated. At 10–14 years of age the difference begins to decrease

<sup>15</sup> Recently, Molenaar (2004a,b) has forcefully made the same argument.

<sup>16</sup> These results have been recently reproduced with minor modifications (Meshcheryakov, 2008).

**Fig. 5.1** Showing the relationship between unmediated (B) and mediated memory in condition where cards are pre-paired with words (C). From van der Veer and Valsiner (1991), p. 232

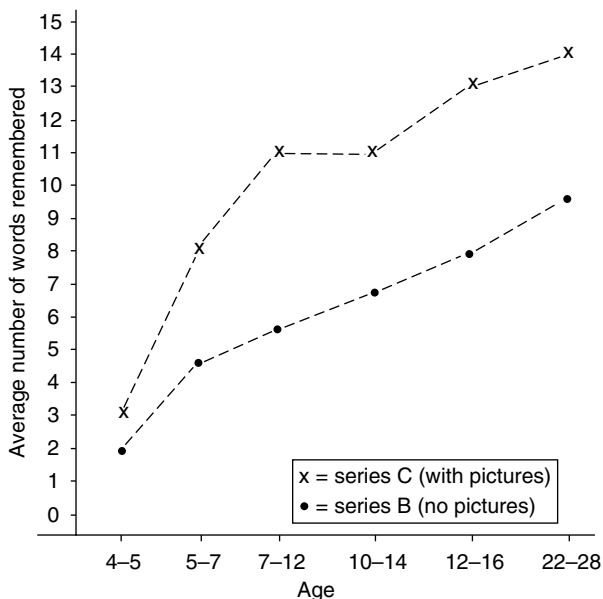

once again. Vygotsky explained this as the child’s increasing ability to use external mediated means. The narrowing of the gap between unmediated and mediated again at a later age was understood within his famous law of development in which external means became internal, making their external counterpart redundant.

Nowhere in this analysis do we see a single child’s performance improve through time—this would have taken many years to complete and is unnecessary for answering Vygotsky’s general question here. He was simply looking for *general trends* across these age groups for the two conditions; he was not claiming that *any* 3-year-old remembers *x* amount and any 5-year-old *y* for either mediated or unmediated conditions, nor simply that 3- and 5-year-olds are different. His interpretation of the data tells a general theoretical story about the intertwining of natural (no external means) and cultural (external means) developmental lines, but does not reveal how they are coordinated within the individual child’s holistic functioning.

In summary, aggregate analysis can be a powerful tool in uncovering general trends within a sample, although it also comes with a number of limitations:

(1) We cannot treat variations occurring within a population as if they applied to individuals (Molenaar, 2004a,b; Molenaar & Valsiner, 2005). An average score does not apply to *any* individual within the sample, and the distribution of scores for the two conditions might overlap to a high degree. Therefore, it is unjustified to say that all those in condition a are *x*, because some may in fact tend toward *y* and thus be closer to the general trend in condition b. Lewin (1933, p. 559) comments, “The laws of falling bodies in physics cannot be discovered by taking the average of actual falling movements, say of leaves, stones, and other objects, but only by proceeding from so-called ‘pure’ cases”.

(2) In homogenizing each condition, we ignore cases that might contradict our general analysis. Furthermore, this constrains the possibilities for innovation by restricting analysis to confirmation or disconfirmation of one's hypothesis. Alternatively, by looking at deviance we see that the situation is often more complicated than our model allows, like when multiple variables are operating together. Vygotsky, for example, found when exploring the qualitative structures of individual children that three components must be simultaneously present if the child is to master the memory task.

(3) This brings us to the often acknowledged, but seldom applied (to methods), truism that *individuals are not just the sum of their parts/variables*. Variables combine into wholes which change the meaning of each variable in relation to the others—as with Vygotsky's three components. To see how variables are *systemically* related we must look at how they are functioning together in particular individuals. It is only through the analysis of wholes and their variations in time that we access *qualitative transformations*, which is the focus of the microgenetic method. It is to single case analysis we must go if we are to understand these systemic relationships and their development through time.

### ***Single Case Analysis***

As already mentioned, earlier experimental psychology (into the 20s) was highly idiographic. In Ebbinghaus' (1885/1913) studies, for example, there was only one participant and it was himself! A typical experiment could involve between one and twelve participants, all of which would be accounted for in the analysis—when quantitative data was used scores were given for *all* participants. Multiple participants were only needed to reproduce the results obtained with the first participant. Thus, here generalization moves from single cases to general models and back to single cases; rather than from group averages to individuals, as is the case in aggregate analysis. Bartlett's presentation of several whole reproductions produced by a single participant and their analysis in terms of holistic qualitative transformation is a good example of a single case analysis; while his attention to how many of his participants changed boat to canoe (over half by the second reproduction) is a form of aggregate analysis intended to reveal *general trends*. Similarly, Werner makes his argument entirely from the qualitative description and analysis of single participants; at the aggregate level he merely mentions how many participants did *not* produce an analyzable series. In this section, I will first consider Bartlett in relation to single case analysis; then compare and extend his findings with Luria's (1987) idiographic study of the famous mnemonist Schereshevskii.

In Bartlett's book *Remembering* (1932) there is no sophisticated statistical analysis and his sample sizes are relatively small by today's norms. The current social norm for sample sizes was established in the 1950s (Danziger, 1987), long after Bartlett conducted his experiments. Instead, the book draws us in by its closeness to the phenomena, through its simple and rich material, which we can try out for ourselves,

and his holistic analysis, which integrates participants' reproductions, comments, affects, behavior, etc., for the development of complex theory. His criteria of what counts as good evidence is rather different from today's criteria but not necessarily less rigorous. Contemporary experiments legitimize themselves by having large samples, highly standardized procedures and statistically significant differences between scores. Bartlett, on the other hand, might offer us several whole unprocessed reproductions of a single participant, which allow us to transparently compare our own interpretation with his as a means of quality control (whereas with most contemporary experiments we lose this ability). As a second strategy of quality control he attends to cases deviant from the norm that do not quite fit his theory and works them into it (whereas for most contemporary experiments deviant cases are ignored as mere noise—what matters is statistical significance). Thus, when only one out of twenty of participants remembers the two bizarre proper names in the story *War of the Ghosts* he devotes two pages (pp. 208–209) to working through this case.

This deviant case seems to contradict Bartlett's theory of *constructive* remembering in that the participant immediately remembers two details (the proper names *egulac* and *kamala* which no one else remembers) but cannot recall the rest of the story. With time the participant is able to reconstruct the general story but only slowly. Bartlett uses this example to elaborate his concept of *image* in his general theory of remembering: Images function to restrict the generalizing character of schemas by picking out details in a schema—schemas *generalize* while images counterbalance this tendency by *particularizing*.<sup>17</sup> It should be noted that images here are not like *traces* left on the mind; instead they are actively formed and maintained by a participant with particular interests and a history. Thus, the participant's memory of *egulac* and *kamala* can be understood as a case of the skillful use of imagery to select and maintain these elements.

We can further test the limits of Bartlett's theory by seeking out cases in which *no* reconstructive remembering seems to be taking place. The famous mnemonist Schereshevskii, for example, could remember lines of Dante in Italian (though he did not speak Italian) 15 years after he was exposed to them, without intermittent rehearsal or forewarning (Luria, 1987, p. 45). We might ask, "What could this bizarre and extraordinary mind teach us about our own? How can we work toward a general model of mind from such abnormal cases?" From a single case analysis it is precisely deviance from the norm that can be most useful in developing a theory. Schereshevskii's exceptional memory abilities were largely the result of his powerful mental imagery and synesthesia (Luria, 1987). We all use imagery and have some degree of synesthesia (e.g. we understand cross-modal expressions like "the cheese is *sharp*") but they are rather weaker for us and do not have the overwhelming influence over our life that they did for Schereshevskii.

From Luria's (1987) analysis of Schereshevskii's total functioning<sup>18</sup> we see that his abilities are also handicaps: What allows him to remember concrete details with

<sup>17</sup> Bartlett's third major concept is *attitude* which has already been mentioned in connection with the Würzburgers in Section 3.1.

<sup>18</sup> Single case analysis allows one to explore functioning on particular tasks in light of more general functioning. A participant's history can be used in the analysis.

incredible precision, constrains him from moving beyond particulars to generalizations, i.e. schematizations. His world is a flood of instances and details, not a coherent account of them. Thus, we can infer the *particularizing* character of imagery, which is normally counterbalanced with the *generalizing* character of social schemas that assimilate any particular object to a framework of meaning—Bartlett’s participants would, for example, get a *gist* of the story, as similar to a kind of story they were familiar with, but would forget many of the details. The reconstructive processes that Bartlett highlights in his theory are minimized for Schereshevskii—there are no gaps in his memory in need of filling in because imagery and feeling work so flawlessly. Thus, a pathological case that seems to contradict Bartlett’s theory actually compliments it and might be useful in developing it in powerful directions: for example, by looking at the role played by *mnemotechnics*—such as “the method of loci” (Yates, 1966)—to extend the possibilities of his visual imagery.

In sum, a single case analysis is the only option to explore the systemic functioning of participants because the system works within the individual case. It is more inclusive of a broad array of data, including observations, knowledge of a participant’s biography, his or her comments, etc. and proceeds to integrate them through an interpretive approach—thus, it is open to novelty. In contrast to aggregate analysis its means of quality control are (1) the presentation of full unprocessed cases, and (2) attending to *all* participants in the sample, especially deviant cases. One might argue, at this point, however, that deviance is not always as apparent as was Schereshevskii—we need a way of moving between aggregate and single case data. It is to this question that we now turn.

## **Synthesis**

In the above, an argument for the strength and potential benefits of single case analysis has been developed. Focusing on single cases is the only way to access systemic psychological functioning. It is the only strategy compatible with the microgenetic method for it is at the single case that we can see qualitative transformations, i.e. systemic re-organization in time. There is, however, still an important place for aggregate analysis within our methodological framework. A way of conceptualizing the sample as a whole is needed. Aggregate analysis can be productively employed to identify both average and out layer cases; it provides a mechanism for outlining the diversity of a sample along specified parameters and situating individual cases in it. Bartlett uses it effectively when he recognizes and then analyzes the one participant out of twenty that remembered the bizarre proper names *Egulac* and *Kamala*. Although this (unusual) case would not be a good case to begin to construct his theory of remembering from, it is still essential for developing it, since it reveals a very different organization based on the similar mechanisms. To take a more extreme example, one’s theory of remembering would be quite strange if it was built on an unusual case such as that of Schereshevski.

Also, recognizing *general trends* can be helpful in interpreting individual cases. In Bartlett’s experiments some changes to the story occurred in the majority of his

participants—for example, ‘canoes’ become ‘boats’ in over half the participants by the second reproduction—while others were more idiosyncratic. Remembering can thus be conceptualized as involving both social frameworks and personal interests. In teasing these two factors apart we can begin to look for their interrelation: For example, it was common for participants to leave out the supernatural elements of the story; however, this could be accomplished in idiosyncratic ways, such as interpreting what comes out of the Indian’s mouth as merely “a materialization of his breath”. In this case, conventionalization is accomplished through personal imagery.

In sum, working between single cases and the aggregates can provide invaluable resources for both interpreting single cases and understanding the nature of the variation found at the aggregate level. In doing this we overcome the weaknesses of aggregate analysis—i.e. their inability to explore deviance, and make claims about individual cases and their systemic functioning—and situate single cases within the sample, so as to treat them as ‘normal’ or ‘outlayer’ cases on specified dimensions.<sup>19</sup>

## Conclusion: Microgenesis in the Making

In this chapter, I have *not* advocated turning back the clock to an earlier era of experimentation but rather for an open dialogue with it in order to deepen our present methodological resources. For my purposes I have attempted to develop an experimental methodology that can access and analyze *constructive processes*, which must be approached through *individuals as wholes and their qualitative transformations in time* (though this analysis can be strengthened with an aggregate analysis). These are features which contemporary methodology is rather weak on but for which the microgenetic method (which belongs to this earlier tradition) was designed for. In short, I have explored the history of methodology and offered a direction in which different approaches can be integrated to create an *experimental methodology of constructive microgenesis*.

**Acknowledgments** I want to thank the Gates Cambridge Trust for generously funding me through my PhD at the University of Cambridge. I would also like to recognize Nicole Kronberger, Hala Mahmoud, Jaan Valsiner, and Tania Zittoun for their comments on earlier drafts of this paper.

## References

- Bakhurst, D. (1990). Social memory in soviet thought. In D. Middleton & D. Edwards (Eds.), *Collective remembering* (pp. 203–226). London: Sage.
- Bartlett, F. C. (1916). *Transformations arising from repeated representation: A contribution towards an experimental study of the process of conventionalisation*, Fellowship Dissertation, St. John’s College, Cambridge.

<sup>19</sup> For a recent empirical example of the proposed methodological synthesis (see Wagoner, in press).



- Bartlett, F. C. (1932). *Remembering: A study in experimental and social psychology*. Cambridge, Cambridge University Press.
- Bartlett, F. C. (1951). Review of thinking: An introduction to its experimental psychology by George Humphrey (1951). *Quarterly Journal of Experimental Psychology*, 4(1), 87–90.
- Binet, A. (1903). *L'étude expérimentale de l'intelligence*. Paris: Schleicher.
- Boring, E. G. (1950). *A history of experimental psychology*. New York: Appleton-Century-Crofts.
- Catán, L. (1986). The dynamic display of process: Historical development and contemporary uses of the microgenetic method. *Human Development*, 29, 252–263.
- Catán, L. (1989). Musical literacy and the development of rhythm representation: Cognitive change and material media. In A. Gellatly, D. Rogers, & J. Sloboda (Eds.), *Cognition and social worlds* (pp. 144–167). Oxford, Clarendon Press.
- Danziger, K. (1987). Statistical method and the historical development of research practice in American psychology. In G. Gigerenzer, M. Morgan, L. Kruger (Eds.), *The probabilistic revolution: Ideas in modern science, Vol. 2*. Cambridge, MA: MIT Press.
- Danziger, K. (1990). *Constructing the subject: Historical origins of psychological research*. New York: Cambridge University Press.
- Danziger, K. (1997). *Naming the mind: How psychology found its language*. London: Sage.
- Danziger, K., & Ballantyne, P. F. (1997). Psychological experiments. In W. Bringmann, et al. (Eds.), *Pictorial history of psychology* (pp. 233–239). New York: Oxford University Press.
- Diriwächter, R. (2009). Idiographic microgenesis: Re-visiting the experimental tradition of Aktualgenese. In J. Valsiner, P. C. M. Molenaar, M. C. D. P. Lyra, & N. Chaudhary (Eds.), *Dynamic process methodology in the social and developmental sciences* (pp. 319–352). New York: Springer.
- Diriwächter, R., & Valsiner, J. (2005, December). Qualitative developmental research methods in their historical and epistemological contexts [53 paragraphs]. *Forum Qualitative Sozialforschung/Forum: Qualitative Social Research* [On-line Journal], 7(1), Art 8. Available at: <http://www.qualitative-research.net/fqs-texte/1-06/06-1-8-e.htm>. Accessed 25 Feb, 2008.
- Duveen, G. (2000). Piaget as ethnographer. *Social Science Information*, 39, 79–97.
- Ebbinghaus, H. (1885/1913). *Memory: A contribution to experimental psychology*. New York: Dover.
- Edwards, D., & Middleton, D. (1987). Conversation and remembering: Bartlett revisited. *Applied Cognitive Psychology*, 1, 77–92.
- Engeström, Y. (2007). Putting Vygotsky to work: The change laboratory as an application of double stimulation. In H. Daniels, M. Cole, & J. V. Wertsch (Eds.), *The Cambridge companion to Vygotsky*. Cambridge: Cambridge University Press.
- Gauld, A., & Stephenson, G. M. (1967). Some experiments related to Bartlett's theory of remembering. *British Journal of Psychology*, 58, 39–49.
- Henderson, E. N. (1903). A study of remembering and connected trains of thought. *Psychological Review Monograph Supplements*, 5 (Whole No. 23), 1–94.
- Holton, G. (1988). *Thematic origins of scientific thought: Kepler to Einstein*. Cambridge, MA: Harvard University Press.
- Humphrey, G. (1951). *Thinking: An introduction to its experimental psychology*. London: Methuen.
- Kusch, M. (1999). *Psychological knowledge: A social history and philosophy*. London: Routledge.
- Larsen, S., & Berntsen, D. (2000). Bartlett's trilogy of memory: Reconstructing the concept of attitude. In A. Saito (Ed.), *Bartlett, culture and cognition* (pp. 115–134). UK: Psychology Press.
- Lewin, K. (1933). Environmental forces in child behavior and development. In C. Murchinson (Ed.), *A handbook of child psychology* (pp. 590–625). Worcester: Clark University Press.
- Luria, A. R. (1970). *Traumatic aphasia: Its syndromes, psychology and treatment*. Paris: Mouton.
- Luria, A. R. (1987). *The mind of a mnemonist: A little book about a vast memory*. Cambridge, MA: Harvard University Press.

- Meshcheryakov, B. (2008). *The parallelogram of memory development: Not a myth, but requires specification*. Paper presented at the International Society for Culture and Activity Research, San Diego, USA.
- Molenaar, P. (2004a). A manifesto on psychology as idiographic science: Bringing the person back into scientific psychology, this time forever. *Measurement*, 2(4), 201–218.
- Molenaar, P. (2004b). Forum discussion of the manifesto's aggregation act. *Measurement*, 2(4), 248–254.
- Molenaar, P., & Valsiner, J. (2005). How generalization works through the single case: A simple idiographic process analysis of an individual psychotherapy. *International Journal of Idiographic Science*, 1(1) [92 paragraphs]. (Reprinted in S. Salvatore et al. (2009). *Yearbook of idiographic science 2008* (Vol. 1). Rome: G Fireira Group)
- Philippe, J. (1897). Sur les transformations de nos images mentales. *Revue de Philoquoque*, 43, 481–493.
- Roediger, H. L., Bergman, E. T., & Meade, M. L. (2000). Repeated reproduction from memory. In A. Saito (Ed.), *Bartlett, culture and cognition* (pp. 115–134). London: Psychology Press.
- Rosenthal, V. (2004). Microgenesis, immediate experience and visual processes in reading. In A. Carsetti (Ed.), *Seeing, thinking and knowing: Meaning and self-organization in visual cognition and thought*. Rome: Kluwer Academic Publishers.
- Titchener, E. B. (1909). *Lectures on the experimental psychology of the thought-processes*. New York: Macmillan.
- Toomela, A. (2007). Culture of science: Strange history of the methodological thinking in psychology. *Integrative Psychological and Behavioral Science*, 41, 6–20.
- van der Veer, R., & Valsiner, J. (1991). *Understanding Vygotsky: A quest for synthesis*. Oxford: Blackwell.
- Valsiner, J. (1998). *The guided mind*. Cambridge, MA: Harvard University Press.
- Valsiner, J. (2000). *Culture and human development*. London: Sage.
- Valsiner, J. (2003). Culture and its transfer: Ways of creating general knowledge through the study of cultural particulars. In W. J. Lonner, D. L. Dinnel, S. A. Hayes, & D. N. Sattler (Eds.), *Online readings in psychology and culture* <http://www.wvu.edu/~culture>. Accessed 15 June, 2006.
- Valsiner, J. (2007). *Culture in minds and societies: Foundations of cultural psychology*. New Delhi: Sage.
- Valsiner, J., & van der Veer, R. (2000). *The social mind: Construction of the idea*. Cambridge: Cambridge University Press.
- Veresov, N. (2008). *CHAT in retrospective: Bridging the gap or fixing the hole?* Paper presented at the International Society for Culture and Activity Research, San Diego, USA.
- Vygotsky, L. (1978). *Mind in society*. Cambridge, MA: Harvard.
- Vygotsky, L. (1986). *Thought and language*. Cambridge, MA: MIT.
- Vygotsky, L. (1987). *The collected works of L.S. Vygotsky. Vol. 4: The history of the development of higher mental functions*. New York: Plenum Press.
- Vygotsky, L., & Luria, A. (1994). Tool and symbol in child development. In J. Valsiner & R. van der Veer (Eds.), *The Vygotsky reader* (pp. 99–172). Oxford: Blackwell.
- Wagoner, B. (2007). Overcoming psychology's methodology: Finding synthesis beyond the American and German-Austrian division. *Integrative Psychological and Behavioral Science*, 41(1), 6–74.
- Wagoner, B. (2008a). Developing “development” in theory and method: Commentary on Kleine-Horst. In E. Abbey & R. Diriwätcher (Eds.), *Innovating genesis* (pp. 39–61). Charlotte, NC: Information Age Publishers.
- Wagoner, B. (2008b). The microgenetic method: A history of transformations. *BPS: History and philosophy of psychology section conference*. March 25–27, Oxford.
- Wagoner, B. (in press). Narrative in the recall of apparent behavior. In S. Salvatore & T. Zittoun (Eds.), *Cultural psychology and psychoanalysis in dialogue*. Charlotte, NC: Information Age Publishers.
- Werner, H. (1956). Microgenesis and aphasia. *Journal of Abnormal Social Psychology*, 52, 347–353.

- Werner, H. (1957). The concept of development from a comparative and organismic view. In D. B. Harris (Ed.), *The concept of development*. Minneapolis: University of Minnesota Press.
- Werner, H., & Kaplan, B. (1957). Symbolic mediation and organization of thought: An experimental approach by means of the line schematization technique. *The Journal of Psychology*, *43*, 3–25.
- Werner, H., & Kaplan, B. (1963). *Symbol formation*. Hillsdale: Lancer Erlbaum Associates.
- Werner, H., & Kaplan, E. (1954). Change of meaning: A study of semantic processes through the experimental method. *Journal of General Psychology*, *50*, 181–208.
- Yates, F. (1966). *The art of memory*. Chicago: University of Chicago.

# Chapter 6

## The Schema Approach: A Dynamic View on Remembering

Naohisa Mori

In this chapter, we will propose a new approach to remembering and memory. This is called the ‘schema approach’ (Ohashi, Mori, Takagi, & Matsushima, 2002). This name—and its underlying idea, of course—come from Frederic Bartlett’s schema theory (Bartlett, 1932). Our approach has four features. First, it attempts to explore the veracity of a rememberer’s experience under the assumption that it is not possible to access the original event that the rememberer actually experienced. Second, this approach aims to find out the veracity through communication between a speaker and a recipient on the topic of the event to be recollected. Third, we point out that the veracity of an experience should be evaluated on the basis of the particular narrative style of recall, and not based on its contents. Finally, the veracity is examined case by case; that is, the situated remembering of an individual person is considered.

### Novelty of the New Perspective

The four features of our approach are new yet well situated within the traditions of memory research. The first feature guarantees that our schema approach is different from the traditional approaches. The traditional memory research beginning from Ebbinghaus (1885) assumes that an experimenter knows the existence and the contents of an original event being remembered. This situation, however, rarely occurs in everyday life. It is not able for us to judge whether a rememberer is telling a story based on his/her real experience or is fabricating a story by comparing the story with its original event. We have to find hints of his/her past experience only through his/her narratives.

---

N. Mori (✉)  
Department of Clinical Psychology  
Sapporo Gakuin University  
Ebetsu-shi, Hokkaido 069-8555, Japan  
e-mail: morichan@sgu.ac.jp

The second characteristic also has a marked difference from the traditional approaches. Although participants in the traditional research are assured their monologue in recall, a recipient in everyday situation often interrupts, asks questions to get information she/he wants, or even casts doubts on the factuality of remembering. Such interaction is excluded because it is considered as an interference factor in the traditional research as much as feasible. However, there is no experimental control like this in an everyday situation. Moreover, introducing such control in our experiments would prevent us from approaching natural remembering. The third characteristic would overcome difficulties inherent in the traditional research orientation. Learning materials in the traditional research are often fragmented and well structured to easily identify lacks and changes in the recall performance. This methodology has reinforced the implicit premise of the traditional research that an experience and a remembering have the same contents. In reality, however, they are never identical; our everyday remembering is a quite different activity from experiencing something. Most parts of our experience are not well structured or not ready to verbalize. It is possible to describe the experience with words but it can be expressed in various ways. Such cross-modal nature of everyday remembering (Edwards & Middleton, 1986) makes it very difficult to examine the veracity of an experience according to its contents. Besides, an imagination or a conjecture as well as the secondary information enable people to construct a story and talk about it with no real experience.

The fourth feature introduces the individually unique nature of the act of remembering. The traditional research has established many general laws by controlling independent variables, analyzing averages among groups statistically, and comparing them. But it should be noted that these general laws must have exceptions. Think of the weapon focus effect, one of the famous laws in a research field of eyewitness testimony (Loftus, 1979). This law says that witness memorizes a criminal's face very badly when he/she has a weapon. According to this law, an expert testimony would say that the credibility of a witness's memory should be discounted because a criminal possessed a weapon. However, some participants in the 'weapon' condition correctly recognized the criminal's face in the experiment; therefore, we may not be able to properly evaluate the veracity of an experience based on general laws. In addition, because an experiment is conducted under the condition that many variables are controlled, applying general laws to a real situation is sometimes questionable. There are many questions—such as if a general law derived from an experiment using university students as a participant is able to apply to a witness who met a criminal under the highly stressful condition or to children. We attempt to examine the veracity of an experience on the basis not of de-contextualized laws but of steadily observed phenomena in a given situation.

The schema approach has developed through our long-term struggle with evaluating the credibility of confession and testimony in Japanese criminal courts. In the next section, our history about the development of this approach will be discussed.

## Unexpected Findings from a Hopeless Situation

### *The Ashikaga Case—Agent Alteration and Agent Succession*

The Ashikaga case happened in Ashikaga city located about several dozens kilometers away from Tokyo in 1990. A 4-year-old girl was raped and killed. A middle-aged man, called S, was arrested and prosecuted as a suspect. One of the aspects of the crucial evidence was his confession. Although S kept admitting his guilt since the police interrogation, he shifted over into denying his guilt in the middle of the 6th trial of the District Court. The judges of the District Court convicted the suspect, and S appealed the conviction to the High Court. Because S's defense counsel had doubts about the credibility of S's confession, they asked us to examine the confession.

While a confession is considered as one of the acts of remembering, we found that it was quite different from those explored in the traditional research accounts. First of all, when we examine the credibility of a confession, we cannot access the original event referred in the confession; therefore, the comparison between the confession at issue and the original event is impossible. In addition, it is difficult to apply things found in the previous researches because some assumptions underlying those experiments are not appropriate in an examination of a confession.

Experimenters know that all participants in a memory experiment have some experience, whereas a defendant's commitment is under examination. Are findings of the false memory studies (e.g., Loftus, 1997; Loftus & Ketcham, 1992; Shobe & Schooler, 2001) applicable? They suggested the possibility that false memories can be generated due to influences of several factors even without a real experience. It should be noted, however, that such factors always exist in those experiments. Because police interrogation is not available in Japan, we cannot confirm the existence of such factors in the interrogation at issue. It should be also noted that the false memory researches are conducted on the presumption that experimenters are sure that participants have no specific experience in the experiment. This assumption is not satisfied in our judicial practice.

Secondly, a confession is generated during the process of an interrogative communication in court. In the traditional research, an interruption by recipients is one of the disrupting variables to be controlled. On the contrary, recipients of the in-court confession—lawyers and judges—actively intervene in defendant's confession by 'framing' and 'orientation' (Edwards & Middleton, 1986). They also evaluate the validity of the confession and often induce the defendant to modify or to take back his/her utterances based on hypothesis they are holding about a case based on evidence. We have to examine defendant's remembering by using such 'contaminated' data.

Third, it is difficult to validate a confession from the standpoint of its content. We cannot basically judge whether the contents of the confession describes the event

at issue because of the inaccessibility to its original event. Even if a confession corresponds to other evidence, we cannot reject the possibility of influences by the secondary information. Interrogators often give suspects questions including information about the incident. If such communication happened in the police interrogation, the corresponding confession to other evidence can be constructed in court.

Do studies of reality monitoring (e.g., Johnson & Raye, 1981) offer us any useful findings to evaluate the credibility of a confession based on its contents? They show us that there are some qualitative differences between memories resulted from an external stimulus and those from an internal imagination. However, traditional research has established laws through the comparison between averages by using a statistical test. Such general laws have room for exceptions. We can only probabilistically judge whether the case is typical or exceptional to the law.

Judges in Japan sometimes decide that the defendant is an exception to the law. Although such expert witnesses as Elizabeth Loftus often participate in court to offer expert opinions derived from the traditional researches, it is only to cast doubt on the credibility of a confession and of an eyewitness testimony. The defense counsel of the Ashikaga case requested us to make a specific judgment to S's confession rather than a judgment based on general laws.

Moreover, the counsel did not allow us to refer to any other evidence but the defendant's confession to evaluate its credibility. One day, we went on an investigation to the riverside where the murder was supposed to happen. We found that grass had thickly grown and was about 2 m tall, and covered a field a few hundred meters long, and several meters wide. If the defendant had committed the crime referred in his confession, he did break through this 'wall' of the grass with the victim. Strangely enough, however, his struggle with this 'wall' did never appear in his confession. We suggested to the counsel that his confession be considered not credible on the strength of the absence of a statement about the 'wall' in his confession. But they criticized our effort as a 'detective play.' They insisted that our profession as a psychologist was to evaluate the credibility of a confession only based on the confession itself because such effort should be done by lawyers and was not what psychologists should engage in.

We found some particular narrative styles of S when intensively examining the communication between S and the interrogators in court. He incidentally had a chance to talk about his experiences that other people also knew (i.e., a domiciliary search of his house, his participation to his nephew's sport festival). S strongly tended to alternately mention his own actions and such counteractions as other people's actions or changes of an environment. His report of the domiciliary search is cited below:

Well, the policeman said, "Are you Mr. S?" and I responded, "Yes, I am." Then he said, "Can we come in and see your room?" So I let them come in, and he said "Will you show us the inside of the closet?" then I opened the closet and a small box appeared. The policeman said, "Can I see it?" and I took it to him, then he said, "What is this inside of this box?" and I said..... (Ohashi et al., 2002, pp. 48–49)

Such trend as seen above was weak in his confession to the crime because S tended to talk about his actions successively (e.g. "I changed my mind, so when I

went to the park by bicycle, I walked to the dry riverbed on the way.” “I parked my bike maybe by the dry riverbed and then descended from there.”). We concluded the contrast between the alteration of an agent in remembering of his experiences and the succession of an agent in his confession showed that his confession might not be based on the real experience.

The word ‘schema’ in the schema approach refers to something repeated in remembering. The schema approach is a methodology to evaluate the veracity of an experience by using the repetition as a clue. In the analysis of S’s confession, we pointed out two schemata, the ‘alteration of an agent’ and the ‘succession of an agent’, in his different reconstructions and examined the veracity of S’s experience according to their qualitative peculiarities. You can see how the schema approach overcame difficulties of the traditional research efforts. We succeeded in evaluating the veracity of an experience by the schema approach on the basis of the *style* of remembering without referring to an original event or depending on its contents.

### ***The Kabutoyama Case—Statement Generation Schema***

The Kabutoyama case is another criminal case we were involved after the Ashikaga case. This ‘murder’ case happened at facilities for the mentally disabled in Hyogo Prefecture in 1974 (The defense counsel seemed to think of this case as an ‘accident.’). It is called the Kabutoyama case after the name of the facilities. A female nursery teacher, Y was arrested and prosecuted on a charge of murdering a boy kindergarten teacher, S. One of the critical evidences was an eyewitness testimony of another kindergarten teacher, F. He belonged to the same facilities and was 12 years old when the case occurred. He told the police that he had seen a suspicious behavior of Y and S.

The credibility of F’s eyewitness testimony was rejected according to the psychological examination done by the defendant’s side. The District Court agreed with it and found Y was not guilty. Professor Hamada conducted the examination. He is one of the pioneers in the Japanese forensic psychology and introduced us into the judicial work practices. He concluded that the credibility of F’s testimony was low on the basis of many transitions seen in F’s statements under the police’s investigation. The prosecutors appealed to High Court. Judges in the High Court decided to send the case back to the District Court for retrial. A defense counsel in the retrial requested us to examine the F’s testimony in a different way from Hamada’s. They expected us to analyze communication between F and the interrogators in court. We gave up analyzing the examination-in-chief because we doubted there may be some practices in advance between the prosecutors and F. Instead, we decided to analyze the cross-examination. The general review of the analysis was presented here because the detailed analysis has already been published in Ohashi et al. (2002), Ohashi and Mori (2002). In the cross-examination, F mentioned what was consistent with the examination-in-chief at times, but made contradicting statements at other times. When F stated differently from what he had said in the preceding examination-in-chief, the counsel often wondered his utterances and asked closed questions



(sometimes the identical questions were repeated) including the same contents as he talked in the examination-in-chief. Responding to such questions, F often took back what he said previously in the cross-examination and agreed with his statements in the examination even though those statements were contradicted to his preceding answers. Even in such cases, however, when the counsel gave closed questions only to confirm what F answered, he often responded to the questions affirmatively. The interrogators sometimes accepted, confirm, or requested to correct somewhat confusing answers of F by using closed questions. At the end, the interrogation on a topic at issue was closed by F's affirmative responses to the CQs, followed by the start of the next topic. We presented the repetitive patterns of communication between the interrogators and F in the cross-examination as the statement generation schema (see Fig. 6.1). Although this flow chart appears to summarize the communication, we are attempting to point out their 'positioning' in the communication through this figure. Following the terminology of Gunji (2004), we call F's characteristics shown in his confusing answers the 'indefiniteness' meaning an inability to decide what kind of narrative activity an utterance belongs to. Additionally we call the nature of the interrogators' interpretation judging if F's utterances were an action of recall or an action of non-recall the 'vagueness.' This means the uncertainty on deciding whether an utterance belongs to a particular action category or not. The very nature of the communication about F's eyewitness testimony reflected on the statement generation schema is the repetitive reproduction of their 'positioning' meaning the 'indefiniteness' is translated by the 'vagueness' (see Fig. 6.2) This schema suggests the possibility that F's statements may be directed to a hypothesis of the recipients. When the interrogators investigated him with a strong hypothesis, contents of the communication may be gradually taking the form of a construction that supports the hypothesis.

On the contrary, if the communication between them were not conducted in the hypothetically-driven way, this schema would not generate a single story (sufficient to be a fact) but various stories. In the fact, a story negating the existence of F's eyewitness experience was constructed in the cross-examination. Because of this schema, F did not function as an eyewitness that should construct a single story sufficient to be a fact. He seems to be either an "eyewitness" or a "fabricator"—depending on an attitude of the interrogators. We judged that F's testimony had low credibility and showed little veracity of his eyewitness experience.

As we identified a schema shown its repetitive nature in S's utterances in the Ashikaga case, we found a repetitive pattern between F and the interrogators, a schema as a 'positioning' based on the communication unit by two participants in the Kabutoyama case. A schema seems to be found at various levels of activities.

### ***The Amagasaki Case—Gestalt Switch of Analysis Unit***

A fight between gangsters occurred in Hyogo Prefecture in 1985. It is called the Amagasaki case after the city name where it happened. The gang leader Y was

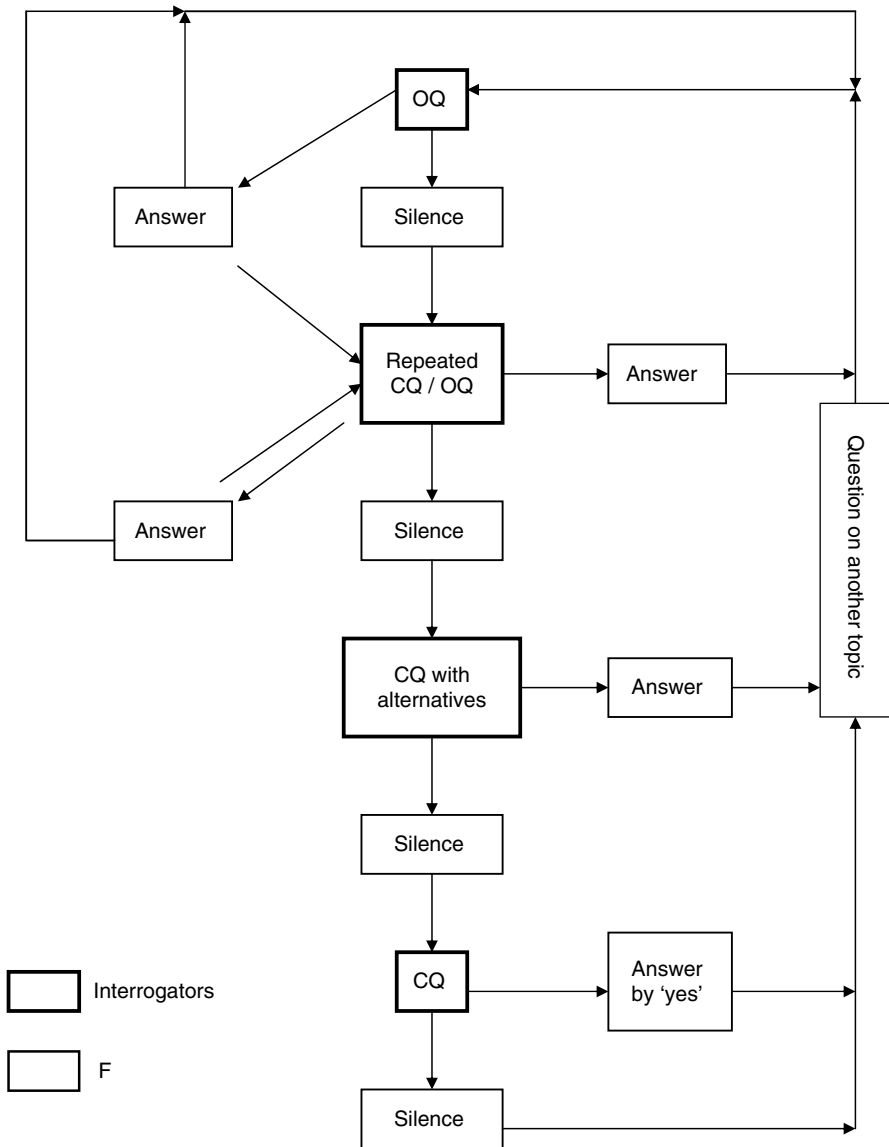
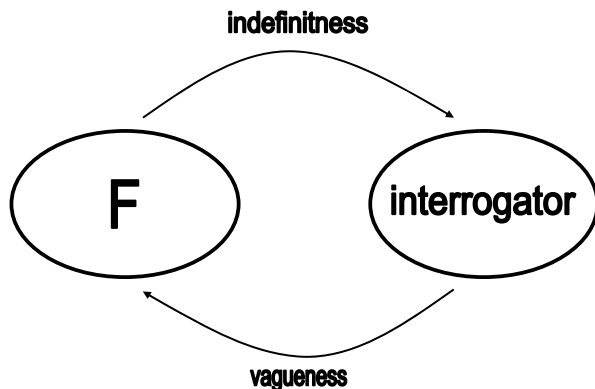

Fig. 6.1 Statement generation schema

arrested and prosecuted on charge of his directing one of his henchmen O to shoot members belonging to the opponent organization. O showed up as a prosecution witness in the trials of District Court and testified Y's commitment to the crime. O testified in a characteristic manner. Although he seldom kept silent in the interrogation and answered something, he looked an insincere witness dodging the point of interrogation.

**Fig. 6.2** Positioning  
between F and interrogator



Because the judges of the District Court had considered O's testimony had the 'consistency', 'little contradiction', and 'little fluctuation', however, the judges positively evaluated its credibility and sentenced Y as if he was guilty. High Court made a similar evaluation about O's testimony. Thus, Y decided to appeal to the Supreme Court, and the defendant's counsel asked us to examine O's testimony.

A 'question-answer' pair is considered as an elementary unit of an interrogation, in which interrogators are assumed to control a witness by questioning. Defendants and witnesses are presumed to have limited degree of freedom by answering to the interrogators' questions. Therefore, it seems natural to analyze interrogative communication on the basis of this unit. When we read O's interrogation according to this basic unit, he seemed to achieve a 'consistent', 'less contradictory', and 'less fluctuating' remembering of the fact, though he sometimes responded uncertainly or clearly during it. The judgment of the District and the High Court may be valid.

However, we could not wipe out some doubt on the credibility of O's testimony due to the impression we had to him as an insincere witness dodging the point of the interrogation, rather than converging to the fact. We tried to reexamine his interrogation according to another analytic unit of an 'answer-question' pair. We paid attention not to the way how O responded to the preceding question asked by the interrogators but to the way how the interrogators asked a question after O's preceding answer. This reexamination let us find out his particularities in the interrogative communication. Although O was expected to play a role to be controlled by the interrogators in court, in the fact, he did control the interrogators by his specific responding.

A set of O's response-interrogators' question-O's response could be classified into three types as follows; (1) response indicating loss of memories-question-ambiguous response, (2) response indicating loss of memories-question-question to make sure the records of interrogation by the prosecutors, and (3) ambiguous response-question-response indicating loss of memories. The former two are particularly interesting on the construction of O's testimony. A typical example of Type 1 is cited below (P refers to a prosecutor as an interrogator):

1. P: Don't you remember its name?
2. O: No, I didn't
3. P: The 'Yellow cap' Eastern S Branch
4. O: Well, I suppose it was.  
(Ohashi et al., 2002, p. 142)

Here, O was asked about the restaurant where Y was supposed to order O to shoot the members. It is noted that the prosecutor in deed presented the name of the restaurant and that O only responded ambiguously to the CQs. O drew out its name from the interrogator without giving any information about the incident. In line 4, he looked not only to recognize the name but also to try to avoid his responsibility as a witness by preparing his escape in case of later possible arguments about his memories. In this way, O seemed to attempt to make his utterances open to the recipients' interpretation by making his position as a rememberer vague. He did the same thing in Type 2 set. One example is cited below:

1. P: You said Imada had given it to you, didn't you?
2. O: I don't remember it well.
3. P: It is written in the investigation records by the prosecutor that you recognized it, so was it basically true?
4. O: I think so.  
(Ohashi et al., 2002, p. 144)

In Japan, investigation records are often cited as evidence when a discrepancy between testimonies in court and under investigation is apparent. O showed his loss of memories (line 2) and let the prosecutor to refer to the records (line 3). He pretended to remember but in actuality avoided the responsibility as a rememberer by accepting the preceding CQ ambiguously. One variation of Type 2 happened in the communication cited below:

1. P: Did you talk with Imada after returning back to the car?
2. O: No, I didn't.
3. P: According to the prosecutor records, you said, "He hasn't come yet" and cheated.
4. O: I said that.  
(Ohashi et al., 2002, p. 147)

O clearly negatively responded to the prosecutor's question in line 1 (line 2). When the discrepancy between his response and the content in the records (line 3) was pointed out to him, he answered positively only about the specific point of "that" (line 4). Again, it looked as if he made a consistent story with neutralizing the discrepancy. It is O's 'positioning' in the communication that gave us the impression that he was avoiding the point of the interrogation. His 'positioning' in the communication made him a vague rememberer, and interpretation about his story was open to the recipients. Thus, it is possible for recipients to see the 'consistency', 'little contradiction', and 'little fluctuation' in O's statements as the judges of the District and the High Court paid attention selectively only to O's utterances. His 'positioning' also functioned as a trigger of the interrogator's presentation of information.

Of course, it was possible for the interrogator to blame O's ambiguous responses and to require him to make clearer answers. However, we are sure that because the interrogators were unaware of being controlled by O in the interrogative communication in court, they did not pointed out O's 'positioning'. This may be the case in the prosecutor's investigation of O. If so, we are not sure whether O's testimony acquired during the prosecutor's investigation originated from his experience or from the prosecutors' hypothesis regarding the incident. Through those analyses, we denied the credibility of O's testimony.

What was a schema in O's testimony? It was 'positioning' between O and the interrogators in the interrogative communication. It is a little different 'positioning' from one found in the Kabutoyama case. A schema in this case was functioning based on an unusual unit of an 'answer-question' pair, while a schema in the Kabutoyama case was operating based on a usual unit of a 'question-answer' pair. Ohashi et al. (2002) named it 'Gestalt switch' of the operation unit. We knew a schema identified in communication between two participants could be found within a different unit of an interrogation (more generally, a conversation) from usual ones.

### ***A Navigation Experiment—Developmental Process of Remembering***

This is not a practical report of a criminal case. Inspired by the analysis of the Ashikaga case, the author felt the necessity to gain empirical support to the validity of our approach by comparing various rememberings under controlled conditions. The author conducted an experiment to compare rememberings about different experiences. A female participant Y and a male participant O individually took part in a navigation task. They were required to find out seven targets in either University A or University B. Y was assigned to navigation at University A and O was to one at University B. About a month later after the navigation task, they were unexpectedly called for on coming to University C and were asked to talk about their experiences about the navigation each other. They were instructed to exchange information about the university they went to because an 'interrogator' would ask questions about the both universities in the next Interrogation phase. About two weeks later after the former phase, Y and O were 'interrogated' individually. 'Interrogators' were graduate students majoring in psychology. They were told that the participants had the navigation experience at the two universities and were instructed to ask them about what happened during the two navigation experiments. Because double blind method applied for the interrogators, they did not know the participants had two different experiences; one was their direct experience contacted to the environment and the other was indirect experience heard from another participant. The 'interrogation' occurred in every two weeks and three times in total. Mori (2008a) analyzed the communication between Y and an 'interrogator' P and found several differences between the two different rememberings. The first difference appeared in narrative styles during Y's recalling about events in each university. Her utterances about

events during the navigation were classified into four categories, her movement, her recognition, her cognition, and objects she encountered. Two successive utterances were labeled as ‘alteration’ when an utterance was followed by the different kind of an utterance, or as ‘succession’ when an utterance was followed by the same kind of an utterance. In Remembering of University A, the ‘alteration’ constantly dominated through all sessions (seven parts to three). In contrast, the ‘succession’ dominated in the early stage of Remembering of University B (six parts to four), though this tendency quickly disappeared and its ‘alteration/succession’ proportion became close to that of Remembering of University A.

The second difference was found in her description of objects. When Y mentioned objects seen during the navigation at University A, she variously described them in regard to their appearance and sometimes unstably named the objects. On the other hand, she described the appearances of objects in University B poorly and named them stably. Although this contrast was clear until the second session of remembering, it became less clear in the third session.

The third difference was shown when she mentioned a motive for her behaviors. During Remembering of University A, incidental encounters with the objects in the environment often induced her behaviors. Her discovery of the targets was described as an incident, such as “I went, then I encountered it.” During Remembering of University B, internal motives and knowledge often triggered her actions, (“I thought .... and went, then I found it”). This contrast was quite salient in the first session. Although the difference was getting less clear over the sessions, it was still found in the third session.

The last difference appeared in her difficulty of drawing only in the first session. When the ‘interrogator’ asked Y to draw at the beginning of Remembering of University A, she froze with holding a pen and was silent for about one minute. Y did not show such difficulty during Remembering of University B. (This last result was deleted in the published paper.) There appeared such particularities discriminating the two different experiences as dominant ‘alteration’/dominant ‘succession’, multiplicity of the object appearance, the stability/instability of object naming, and the difficulty of drawing. These contrasts were gradually disappeared and the two rememberings got close to the similar condition each other. Even though the differences between the two different experiences became difficult to see, we could still discriminate them according to the developmental processes of the schemata. The two different rememberings developed in a different way. In this experiment, we found it possible to approach to the veracity of an experience by examining the development of its schemata.

## **The Schema Approach**

We established a methodology to find a schema—through what is repeated in remembering. A schema is shown not only on the level of an individual’s utterances but also on the level of communication between two participants. Moreover, the

veracity of an experience was found in the microgenetic process of a schema. We (Ohashi et al., 2002) called this methodology the ‘schema approach’ because we thought the similar idea germinated in Bartlett’s theory of a schema. (Bartlett, 1932) Bartlett’s works have been interpreted in various ways in the fields of the traditional memory research, social construction, or discursive psychology. The traditional memory researchers (e.g., Roediger, Bergman, & Meade, 2000) often emphasize the constructive nature of remembering on the assumption that memories identical to copy of an experience are stored. The social constructionists and the discursive psychologists (e.g., Edwards & Middleton, 1987; Edwards & Potter, 1992; Gergen, 1994; Middleton & Edwards, 1990), in contrast, stress the socio-cultural and discursive nature of remembering. Although we agree with the latter ideas, we differ from them because of their lack of the veracity of an individual’s experience. Bartlett emphasized the point, and that is the very source of the schema approach. Next, we will specify it.

### ***Bartlett’s Theory of Remembering***

Consider the data of the experiments reported in the fifth chapter of ‘Experiments on remembering; (b) The method of repeated reproduction’ (Bartlett, 1932). The participants’ recollections gradually changed into the specific directions during repeating remembering. The story of War of the ghosts, folklore unfamiliar to the English participants, converged toward a familiar story to them. For example, a ‘canoe’ was substituted for a ‘boat’, and the story became more rational. Many researchers consider these changes as evidence supporting the idea that a schema is a socio-cultural template shared by people. This interpretation may result from mixing this result with one of the experiments applying the serial reproduction method reported in Chapter 7 and 8 in the Bartlett’s book. What should be noted in the experiments of Chapter 5 is that the changes also reflected personal characteristics. For example, participant H omitted proper nouns and changed words toward more modern phraseology. On the other hand, participant N showed the struggle with, the sticking to, and the rationalization of a ghost. These changes depend on personal interests rather than on shared socio-cultural templates. Bartlett had consistently an interest in the relation between the socio-cultural things and the personal things. He recognized the individuals’ particularities irreducible to the former, while emphasized the collective nature of a society and a culture irreducible to aggregation of individuals (e.g., Bartlett, 1920, 1923). This is the first Bartlett’s idea that we agree with.

We attempted to approach the veracity of an experience in remembering through its styles not through contents. Bartlett’s description cited below inspired us:

It is, accordingly, apt to take on a peculiarity of some kind which, in any given case, express the temperament, or the character, of the person who effects the recall. This may be why, in almost all psychological descriptions of memory processes, memory is said to have a characteristically personal flavour. If this view is correct, however, memory is personal, not because of some intangible and hypothetical persisting ‘self’, which receives and maintains innumerable traces, re-stimulating them whenever it needs; but because the mechanism of

adult human memory demands an organisation of 'schemata' depending upon an interplay of appetites, instincts, interests, and ideas peculiar to any given subject. Thus if, as in some pathological cases, these active sources of the 'schemata' get cut off from one another, the peculiar personal attributes of what is remembered fail to appear. (Bartlett, 1932, p. 213)

He rejected the notion of hypothetical self and memory traces and told the particularity as an individual and the veracity of remembering appear in the organization of a schema. This hypothesis is what we tried to clarify through our analyses of the criminal cases we examined and the navigation experiment.

## A New Approach to Remembering and Memory

Because the schema approach was derived from the analyses of the credibility of confession and testimony, it should be beneficial to the judicial practice. Besides its practical contribution, the schema approach has also some theoretical contributions to the research field of remembering and memory. By following Bartlett's legacy, we will go on beyond the traditional research and social constructionism and discursive psychology to form a better theory.

We agree with the social constructionism and discursive psychology as far as they criticize a concept of engram and emphasize the socio-cultural nature of remembering. For example, Gergen (1994) calls the traditional research since Ebbinghaus as the 'psychological essentialism' and criticized it. He criticizes that it considers memory as the storage of the experience, identifies retrieval of memory as remembering, and disregards the use of socio-cultural mediation. Such his criticisms are common with us. He also argues that the 'textual essentialism', an alternative position to the psychological essentialism, is not appropriate because it reduces remembering to a narrative, that is a self-contained text. He reasons that because a text is not completed by itself, reference to the socio-cultural context to which the text is belonging is indispensable to determine its meaning. The third approach he proposes is social constructionism. He positions remembering as pragmatic practice performed in the socio-cultural context, avoiding the wrong notions of the psychological essentialism. In deed, some people see Bartlett's theory of remembering as one of the social constructionisms due to its share of the same perspectives with Gergen.

Gergen's approach, however, ignores some important implications in Bartlett's theory. First of all, Gergen's approach lacks the idea of the particularity of a rememberer. In his theory, people are identified as a rememberer only when the socio-cultural context admits it. Such rememberers are one of the members belonging to a particular socio-cultural group and have no particularity as a rememberer (Mori, 2005; Takagi, 2002). The traditional research criticized in this chapter so far consider the particularity as a deviation from the average and explore an abstracted person who exists nowhere. The social constructionism also explores an abstracted person as a member of a group, not a concrete individual. The schema approach and Bartlett (1920, 1932) attempt to access to a specific human as well as emphasize its socio-cultural nature.



Second, Gergen's approach lacks a microgenetic view. Thus, it ignores signs of an individual rememberer's experience shown in the microgenesis of remembering as discussed in the sections above. In his theoretical perspective, repetition of words, hesitation in speech, the instability, and the variation of expression would be considered as pragmatic mnemonic signs that an individual showed another person during communication or be ignored with no discussion about them. Third, although Gergen's approach stresses the emergence of remembering, it lacks discussion about its historicity. It is a whole body of experiences of a particular individual. The historicity is essential to distinguish the activity of remembering and memory from other human activities. Therefore, his approach doesn't deal with remembering and memory well in their very nature. This is the most serious failure of social constructionism and discursive psychology. Humans are always changing.

A life is fundamentally an emerging process with producing the novelty (Valsiner, 2000). Remembering is not only an activity of generating the novelty but also is restricted by the flow of the historicity. This temporal nature of remembering is irreducible to the socio-cultural narratives about the past. Remembering is the contradictory unity of opposites, the present as a context and the past as the historicity. We identified some results of the unity as schemata or as the development of a schema. Bartlett's recognition of this unity appears in the citation below:

When I make a stroke I do not, as a matter of fact, produce something absolutely new, and I never merely repeat something old. The stroke is literally manufactured out of the living visual and postural 'schemata' of the moment and their interrelations. I may say, I may think that I reproduce exactly a series of text-book movements, but demonstrably I do not; just as, under other circumstances, I may say and think that I reproduce exactly some isolated event which I want to remember, and again demonstrably I do not. (Bartlett, 1932, p. 202)

Every generation of a stroke is the unity of striker's past experiences as a whole and the present situation surrounding him. Similarly, remembering is the unity of rememberer's historicity and the present context in which they talk about their past. Due to the unity of the opposites, the activity of remembering is not reproduction of the past. On the other hand, the veracity of our experience is secured. The assumption of the identical contents between an experience and a remembering supports the concept of engram. The abandonment of the temporal nature of remembering leads to reduction of the past into the narrative pragmatics at the present. Both of them should be denied.

A phenomenologist E. S. Casey has published a book (Casey, 1983) whose title is interestingly the same as one of Bartlett's works (Bartlett, 1932). Strangely enough, he does not mention about Bartlett in his work. However, Casey also has a right insight that a remembering is the unity of opposites and describes its realization as follows:

In remembering we do not repeat the past as self-identical, as strictly unchanging and invariant. We regain the past as different each time. Or more exactly, we regain it as different in its very sameness. Sameness... is not to be confused with strict self-identity. Where the self-identical excludes the different altogether, the same allows for the different... it is precisely memory's thick autonomy that makes this possible. In and through the dense operations of autonomous remembering, I recall the same past differently on successive occasions... (Casey, 1983, p. 286)

The schema approach appropriately deals with the various forms of the actualization of experience by paying attention to the styles of remembering and successfully secures the historicity reflected in narratives of the past through specifying schemata. It should be noted that a new trend recently appeared in discursive psychology. Middleton and Brown (2005) describes the origin of their attempt.

Some social anthropologist pointed out that their studies lacked some notion of interiority. As they avoided retrogressing to cognitivistic view they had already denied, they reached a concept of a continuity of being. They decided to use the word 'experience' to denote the form of this continuity. They launched 'social psychology of experience' to explore remembering appropriately.

We think, we also get on the same track as them by overtaking the traditional memory research, social constructionism, and the former type of discursive psychology. We have pursued an 'experience' in a practical field, court. Middleton and Brown (2005) seem to be searching for a 'conscious experience' of a rememberer as Bergson they heavily rely on did so. We would ask them a question. What does make such a conscious experience possible? They may answer it is duration with citing some Bergson's work (e.g., Bergson, 1889, 1896). But we think their theory should be transformed to being realism in order to secure the roots of conscious experience. Then, we focus on the affordance theory of an ecological psychologist J. J. Gibson (e.g., Gibson, 1979; Reed, 1994, 1996).

Although Middleton and Brown (2005) reject his theory as a naive realist, they misunderstand—the real Gibson is a 'process philosopher' they admire. According to his theory, when we perceive, we pick up information via our action from the continuous flow of the world, the environment. This process can be called 'actualization' in Bergsonian terms. 'The virtual' also exists in the environment potential. Although the environment is a continuous flow, it is structured. The environment is a duration hierarchically structured by multiple durations. Think of a tree. A tree has branches and these branches have leaves. A leaf may fall out from a branch and another may still cling to it. The branch holds its identity even though these leaves may change. Duration of each leaf is included in duration of a branch. Similarly, a branch may be broken off from the trunk and another may remain. The tree holds its identity, however. Duration of each branch is included in duration of the tree. Moreover, duration of each tree is included in duration of a forest. The same relation may be established in the linguistic environment when we substitute a leaf for a word, a branch for sentence, a tree for a paragraph, and a forest for a book.

It is this nested structure of multiple durations in the environment that makes remembering possible. Sasaki (1996), a pioneer of our theory of remembering, mentions remembering as a different mode of exploration of the environment from perception; "When our contact to the environment turns not enough, we start exploring the environment. It is not exploration in a relatively short duration called 'the present', but one in a larger duration which contains the short duration." (p. 56) "A duration we call 'the present' can be nested by any larger durations. Their nested structure brings us the distinction between 'the present' and 'the past'. Remembering as exploration is an activity to find 'something' in the larger duration."

(pp. 56–57) Imagine a scene of a class seminar on one day. In the middle of the class, a professor criticized a student for the inconsistency of his logic by saying, “You say something contradictory to what you said at the beginning of this class.” The student argued against the professor and said, “I didn’t mean what you say.” And the professor responded to him, saying “You certainly said so.” Their contact to the environment became weaker and they began remembering. The exploration occurs in a larger duration as ‘the activity of a class on the day’ including a shorter one as ‘the immediate discussion.’ It should be noted that we does not mean the environment stores memory. Each human has a unique historicity and tries to find out ‘something’ particular to their historicity through contacting to the environment surrounding them. The process of this finding is, of course, ‘actualization’ as the emerging process. But the range of novelty is restricted by the historicity. This is the very nature of remembering that Bartlett (1932) points out through the stroke metaphor cited above.

We brought the ideas of Bartlett and Gibson together to develop the schema approach (Mori, 2008b; Takagi, 2006). Contrasting to Middleton and Brown (2005) who name their position ‘social psychology of experience’, we call ours ‘ecological psychology of experience.’ We are also looking for more proper approach to ‘experience.’ Both currents seem to be running in different directions. It is uncertain whether they will flow into the same ocean or not. We think, however, discussion between the both would be useful for further development in research fields of remembering and memory.

## General Conclusion

We have reached a new approach to remembering—the schema approach—after the long struggle with judicial practices where we had to examine the veracity of a specific rememberer’s experience. The traditional memory research as well as the socio-cultural approach to remembering (social constructionism and discursive psychology) seem not to have yet dealt with this task successfully. They had four difficulties in this task. First, we had to abandon the accessibility to the original event. In everyday situation, the ‘privilege’ (Mori, 1995) who knows what happened to a rememberer does not exist. Second, a rememberer is not always allowed to relate monologically. We had to deal with communicative remembering among people and under the institutional restrictions. Third, because the identity between the contents of an experience and that of a remembering is not secured, we could not rely on the content analysis of a remembering. Finally, we had to pursue the particularity of a rememberer as an individual. The schema approach introduced in the present chapter has, partially at least, overcome those four difficulties.

The schema approach also has some theoretical implications as well as practical benefits. Although it shares important premises with the socio-cultural approach, it also emphasizes the rememberers’ particularities as individuals that have been overlooked in the socio-cultural researches.

Each rememberer has his/her own historicity, a whole body of experience. When rememberers' historicity encounters the present context in which the reference to their past is needed, an emergent activity of remembering occurs as suggested in Bartlett's (1932) metaphor of a stroke. Although we try to secure rememberers' own past, we resist regressing into an old conception of memory trace. Fusing Bartlett's theory of remembering with James Gibson's ecological theory, remembering is considered as exploration of the gaps among multiple durations in the environment, and historicity as what restricts rememberers' exploration. Our approach is, of course, on the way to the full development, but we believe this becomes one of promising approaches to remembering in the real world.

**Acknowledgements** Part of the present study was done with the support of the 2004 Sapporo Gakuin University Research Support Grant.

## References

- Bartlett, F. C. (1920). Psychology in relation to the popular story. *Folk-Lore*, 31, 264–293.
- Bartlett, F. C. (1923). *Psychology and primitive culture*. New York: Macmillan.
- Bartlett, F. C. (1932). *Remembering: A study in experimental and social psychology*. Cambridge: Cambridge University Press.
- Bergson, H. (1990). *Jikan tojiyuu* [Essai sur les donn\_ es imm\_ diates de la conscience.] (H. Hirai, Trans.). Tokyo: Hakusui-Shya. (Original work published 1889)
- Bergson, H. (1995). *Bussitsuto kioku* [Mati\_ re et m\_ moire: Essai sur la relation du corps a l'esprit] (S. Okabe, Trans.). Tokyo: Surugadai-Shuppansya. (Original work published 1896)
- Casey, E. S. (1983). *Remembering: A phenomenological study*. Bloomington: Indiana University Press.
- Ebbinghaus, H. (1983). *Kioku ni tsuite* [Memory] (T. Utsugi, Trans.). Tokyo: Seishin-Shobo. (Original work published 1885)
- Edwards, D., & Middleton, D. (1986). Joint remembering: Constructing an account of shared experience through conversational discourse. *Discourse Processes*, 9, 423–459.
- Edwards, D., & Middleton, D. (1987). Conversation and remembering: Bartlett revisited. *Applied Cognitive Psychology*, 1, 77–92.
- Edwards, D., & Potter, J. (1992). *Discursive psychology*. London: Sage.
- Gergen, K. J. (1994). Mind, text, and society: Self-memory in social context. In U. Neisser & R. Fivush (Eds.), *The remembering self: Construction and accuracy in the self-narrative* (pp. 78–104). Cambridge: Cambridge University Press.
- Gibson, J. J. (1979). *The ecological approach to visual perception*. Boston: Houghton Mifflin.
- Gunji, Y.-P. (2004). *Emergent computation and ontological measurement* [Genseikeisan to sonzai-rontekikansoku]. Tokyo: Tokyo Daigaku Shuppankai. (in Japanese)
- Johnson, M. K., & Raye, C. L. (1981). Reality monitoring. *Psychological Review*, 88, 67–85.
- Loftus, E. (1979). *Eyewitness testimony*. London: Harverd University Press.
- Loftus, E. (1997, September). Creating false memory. *Scientific American*, 277(3), 50–55.
- Loftus, E., & Ketcham, K. (1992). *The myth of repressed memory*. New York: St. Martin's Press.
- Middleton, D., & Brown, S. D. (2005). *The social psychology of experience*. London: Sage.
- Middleton, D., & Edwards, D. (1990). *Collective remembering*. London: Sage.
- Mori, N. (1995). The function of remembering and the nature of a group in joint remembering. *Japanese Psychological Review*, 38, 107–136. (in Japanese with an English abstract)
- Mori, N. (2005). Approaching to experiences behind statements [Kyojutsu no haigo ni aru taiken eno sekkin]. In Y. Katagiri & K. Kataoka (Eds.), *Readings of sociolinguistics 5: The social*

- and behavioural systems* [Kouza Syakaigengokagaku 5: Syakai koudou sisutemu] (pp. 31–67). Tokyo: Hitsuji-Syobo. (in Japanese)
- Mori, N. (2008a). Styles of remembering and types of experience: An experimental investigation of reconstructive memory. *Integrative Psychological and Behavioral Science*, 42, 291–314.
- Mori, N. (2008b). Detecting a remembering self [Souki suru watashi wo hakken suru]. In M. Naka (Ed.), *Psychology of self: A cognitive psychological view* [Jiko shinrigaku: Ninchi shinrigaku no kanten] (pp. 200–216). Tokyo: Kaneko-Syobo. (in Japanese)
- Ohashi, Y., & Mori, N. (2002). Joint construction of ‘facts’ in court: A casestudy of microscopic communication. *International Journal of Police Science & Management*, 4, 73–86.
- Ohashi, Y., Mori, N., Takagi, K., & Matsushima, K. (2002). *A psychologist meets a trial* [Shinrigakusha, saiban to deau]. Kyoto: Kitaooji Shobo. (in Japanese)
- Reed, E. S. (1994). Perception is to self as memory is to selves. In U. Neisser & R. Fivush (Eds.), *The remembering self: Construction and accuracy in the self-narrative* (pp. 278–292). Cambridge: Cambridge University Press.
- Reed, E. S. (1996). *Encountering the world: Toward an ecological psychology*. New York: Oxford University Press.
- Roediger, H. L., III, Bergman, E. T., & Meade, M. L. (2000). Repeated reproduction from memory. In A. Saito (Ed.), *Bartlett, culture and cognition* (pp. 115–134). Hove: Psychology Press.
- Sasaki, M. (1996). A note on the ‘nature’ of remembering [Souki no ‘shizen’ ni tsuite no oboegaki]. In M. Sasaki (Ed.), *Fields of remembering* [Souki no field] (pp. 31–67). Tokyo: Shinyou-Sha. (in Japanese)
- Shobe, K. K., & Schooler, J. W. (2001). Discovering fact and fiction: Case-based analyses of authentic and fabricated discovered memories of abuse. In G. M. Davis & T. Dalgleish (Eds.), *Recovered memories: Seeking the middle ground* (pp. 95–151). Chichester: Wiley.
- Takagi, K. (2002). An essay on the developmental course of remembering [Souki no hattatsushi]. In S. Tanabe & M. Matsuda (Eds.), *Ethnographies on everyday practices [Nichijouteki jissen no ethnography]* (pp. 40–60). Kyoto: Sekaishisou-Sha. (in Japanese)
- Takagi, K. (2006). An essay on ‘memory space’ [‘Kioku kuukan’ Shiron]. In R. Nishii & S. Tanabe (Eds.), *An anthropology of social space* [Syakai kuukan no jinruigaku] (pp. 48–64). Kyoto: Sekaishisou-Sha. (in Japanese)
- Valsiner, J. (2000). *Culture and human development*. London: Sage.

# Chapter 7

## Against Reification! Praxeological Methodology and its Benefits

Aglaja Przyborski and Thomas Slunecko

As early as the 1920s, Mannheim (1980, p. 84) criticized the way natural-scientific psychology had anchored in logic of empirical research. Unlike many others, however, he was able to successfully work out his own theories. His work co-founded a research tradition, which is currently of great interest to the social sciences; psychology, however, has remained largely unaffected. For Mannheim, the essential one-sidedness of nomothetic, natural-scientifically oriented methodology lies in its hypostatizing “one type of knowledge”—i.e., theoretical knowledge, abstracted from existential relations and exclusively geared towards universal validity, as it is—“as knowledge per se” and “one type of concepts—the so-called exact concepts, which have their origin [...] in definitions” (Mannheim, 1982, p. 217)—as the only type of concept suitable for scientific endeavour.

In our view, the meta-theoretical and meta-methodological considerations and approaches that were spawned by Mannheim’s seminal writings, are an important corrective for contemporary psychology’s mainstream. They open up empirical pathways to a practical, collectively created sense, a field completely ignored by classic research logic, especially as long as it deals with its phenomena in the modus of pure reification (see below). We consider such reification one of the cardinal foes to any dynamic process methodology. In this chapter, we attempt to develop a theoretical foundation for a praxeological, non-reifying, and, in this sense, process-logical methodology; a methodology, which we will ultimately elucidate using practical research examples.

### What Psychology Fails to Do?

Mainstream psychology habitually ignores to reflect upon the methodological foundation and orientation for empirical research, i.e., basic concepts and a meta-theory. Its theoretical activity almost exclusively deals with what we call ‘objects theories’,

---

A. Przyborski (✉)  
Department of Psychology  
Sigmund Freud University  
1030 Vienna, Austria  
e-mail: aglaja.przyborski@univie.ac.at

i.e., with theories about those objects toward which the scientific investigation is directed at any one time. Moreover, psychological research generally does not explicitly deliberate the *conditio humana*, but rather implicitly establishes this condition. Certain preconceptions of being human-specific views of the human being are constantly being inscribed into its research logic—for example that psychological research self-evidently proceeds from the isolated individual. It is remarkable that in social psychology, where the object of inquiry allegedly reaches out beyond the individual, the research logic concentrates on the individual as if it were to be squeezed through the eye of an individual-centric needle. Next to a pervasive tendency to reify, this is the other core epistemological prejudice that praxeological methodology stands out against.

When we here talk about the formulation of a theoretical basis, we do not only have in mind to legitimize certain research practices or research methods—an endeavour that we typically come across in final papers, research proposals, and reports. We rather want to find a common frame, or a common language, for comparing the research programs of mainstream, experimental psychology (the so-called ‘quantitative methods’<sup>1</sup>), with a very different, almost diametrically opposite research tradition that originated from European phenomenology. When this research tradition was adopted by American scientists, it had a profound influence on sociological and, later, linguistic research. The ‘qualitative methods’ that have recently been spawned by this research tradition in Europe, however, have hardly been received in England or the United States. We thus attempt to perform a double exercise in translation: from a German/French context into an Anglo-American context, and from a world of numeric measurement to a world that aims at reconstructing process structures.

By orienting this chapter along the ‘classic’, well-established performance criteria of psychological research—reliability, validity, and objectivity—we contradict a widely spread reasoning, according to which qualitative research is nothing more than a counter program, a supplement, or an accessory to hypothesis testing. It is this very negotiating qualitative *and* quantitative research within a common conceptual frame (i.e., of reliability, validity, and objectivity), that allows us to explicate some of the key differences between praxeological, qualitative methods and methods which adhere to reification and hypothesis testing. Discussing the standards of empiric research, thus, is not an end in itself but rather an attempt to develop (1) the basic, meta-theoretical concepts for a praxeological methodology; and (2) to provide a ground for critical and creative encounter between the two research communities—a foundation for conflict, as Welsch (1988) has aptly put it.<sup>2</sup>

We begin by developing the notions of *knowledge* and *practice*—pivotal as they are for praxeological methodology—and the difference between everyday and

<sup>1</sup> See the General Introduction to this book on the inadequacy of the “quantitative” versus “qualitative” contrasting of methods.

<sup>2</sup> Praxeological methodology is an umbrella term for a number of concrete, well-established research approaches: narration analysis, objective hermeneutics, conversation analysis, discourse analysis, grounded theory in its new variants, and the documentary method. Each of these has its own history and includes a teachable and learnable research practice.

scientific knowledge. We then describe the access to empirical data as a kind of methodical controlled understanding the other (“*Fremdverstehen*” in the sense of Schütz, 1967), in which the focus of analysis moves back and forth between the levels of (a) subjective sense and (b) principles of fabricating social practices. On this basis we apply the classic performance criteria of validity, reliability and objectivity to a specific branch of praxeological methodology, i.e., to reconstructive research. On this basis, will then discuss other, more current quality standards: the meta-theoretical foundation of methods, the methodologically-founded generalizability of results, a praxeological orientation, the potential for transdisciplinarity and for re-connecting basic and applied science.

To counterbalance this admittedly theoretical endeavour, another chapter of this book (Chapter 23) is exclusively devoted to research examples that follow the method(ological) lines outlined here. There the reader finds ample evidence for the potential of our approach, especially in the developmental field.

## Our Starting Point: Common Sense-Constructions

How can we understand everyday practice and everyday knowledge, as we employ it immediately and intuitively in our life world? This initial question for a theory of everyday practice and knowledge will naturally lead us, in this sub-chapter, first to a theory of knowledge, and ultimately to a philosophy of science.

All daily actions—whether one is travelling to work, cooking a meal, or taking an exam—imply the ongoing use of background knowledge, i.e., of implicit schemes or orientations within specific contexts (see further: Schütz, 1967)—a knowledge of how to get from A to B, of which ingredients combine to make a nice family dish and how exams are generally taken. It, thus, does not suffice to just observe a woman in a lecture auditorium, in a kitchen, or in a tram to know what she is doing. We must rather find out about her implicit constructions, i.e., about the orientations, into which her concrete action or situation is embedded,<sup>3</sup> even if such orientations and embeddings are not entirely—or not at all!—available to the subject.<sup>4</sup>

---

<sup>3</sup> All this, proceeds from the assumption that human practice is fundamentally structured by a superordinate—though usually implicit—horizon of sense. We refer to these structures of sense as ‘constructions’, ‘orientations’, and ‘plans of action’. We are aware of the fact that these terms are taken from different, more or less related traditions. At this point, it is of no great importance for our argument to designate how such structures are anchored, or to decide the degree to which subjects are conscious of them. We negotiate these questions in some detail in later sections of this chapter.

<sup>4</sup> Attempts to create artificial intelligence must explicate this implicit knowledge, i.e., translate it into a program code. This has proven difficult even for very simplest practical tasks (e.g., in order to transport a glass of water, a robot has to be programmed to ‘know’ that the concavity of the glass has to be constantly pointing upwards—something which goes without saying in our daily routines). Even the simplest cognitive functions or actions require “an almost infinite amount of knowledge; which we take for granted (it is so obvious as to be invisible) but which must be spoon-fed to the computer” (Varela, Thompson, & Rosch, 1992, p. 148).



Social scientific constructions, categories, and typologies must fasten on to such constructions and orientations of everyday life. If so, they can be regarded as (secondary) constructions of these implicit constructions that are executed or performed in the life world practice. Consequently, their relation to their objects of investigation has to be characterized as per se *reconstructive*.

This particular connection of the scientific interpretation to the constructions of the research field represents a common line of different traditions within the social sciences—traditions, which have decisively helped to form what is now known as qualitative methods. For example, ethno-methodology (Garfinkel, 2007), conversation analysis (cf. Sacks, Schegloff, & Jefferson, 1974; Sacks, 1995), and ethnography of speech (cf. Gumperz, 1982a, 1982b; Gumperz & Cook-Gumperz, 1981; Labov, 1964, 1966, 1968) observed interactions or conversations, i.e., everyday occurrences, from a particular point of view: All of them are interested in something ‘beyond’ the level of manifest conversation or interaction, i.e., in the system or in the hidden rules which enable us e.g., to recognize a story as a story, to understand that a question about one’s health is simply a courteous formulation, or to follow the script of paying for goods at the cashier without giving the procedure any further thought. All these methodologies want to unfold an implicit life world understanding into explicit rules of (establishing) understanding (cf. Bergmann, 2000).

The tradition of the Chicago School (e.g., Glaser & Strauss, 1967; Goffman, 1981) and sociology of knowledge (Mannheim, 1964), too, want to open an access to such everyday observations,<sup>5</sup> i.e., to a type of knowledge which is not available to us in a lexical, or conceptual form, but as an implicit shared knowledge that is intrinsically embedded in our immediate, everyday practice.

In a similar vein, the important phenomenologist Schütz (1962, 1967) explained that the constructions used by social scientists are in fact “second degree constructions”, i.e., constructions of those constructions that are formed by the actors within a social field. If we take into consideration that actors in a social field bring about interpretations themselves, we must *reconstruct* their interpretations within our research. The interpretation of the persons involved—as *first degree constructions*—are to be examined and understood in an initial research step. Only in a second step, researchers develop *scientific* types and theories—*second degree constructions* in Schütz’s sense. The common differentiation between qualitative and quantitative methods does not well grasp this differentiation between first degree (i.e., the subjects’) and second degree (i.e., the researchers’) constructions; therefore we shall rather speak of ‘reconstructive’ instead of ‘qualitative’ methods.

Whenever they operate with representative surveys, or with questionnaires of any kind, quantitative methods avoid the subjects’ constructions and interpretations. This is meant to attain an “objective”, undistorted approach to the subjects’ behaviour, attitudes, etc. At best, subjective constructions play a role in the run-up to such research, i.e., when explorative qualitative studies are meant to somehow find and formulate the right items to cover the scope of the subjects’ constructions. In the

---

<sup>5</sup> Goffmann (1981, p. 20), who achieved groundbreaking results, though he did little to explain his method, calls them “naturalistic observations”.

‘real’ research then, however, each of these items is meant to express a particular proposition without leaving room for further interpretation. The task of empirical methods then lies in nothing but the testing of hypotheses, i.e., of researchers’ theories, by virtue of which the analysis of the phenomenon has already accomplished and operationalized. Research efforts which do not start out with reconstructing the subjects’ implicit constructions generally adhere to a quantitative logic—even if open forms of investigation are employed. In contrast, a genuinely qualitative research logic, as we understand it, is anchored in a *reconstruction* in the above sense.

But how can the structures of meaning, implicitly given in any field of research as they are, be reconstructed in a methodologically consistent perspective?

## **Our Approach: Methodical Controlled Understanding the Other**

Such research process has to take its starting point at everyday practice and everyday knowledge. They have to be understood first. This first step of understanding may at first seem simple and self-evident, particularly when both—researchers and researched subjects—speak the same language (in both a literal and a figurative sense). However, phenomenology, symbolic interactionism, and ethno sciences have, in different variations, questioned the obviousness of such a pre-given understanding between researchers and researched. For example, Garfinkel<sup>6</sup> showed that the seemingly natural, smooth functioning of everyday communication and understanding actually depends on numerous preconditions. In his so-called “crisis experiments, he asked his students to speak to persons they knew—friends, relatives, colleagues—as if they were complete strangers with whom they would not share the self-evident preconditions of everyday communication. The following citation is an example of such an interaction:

The victim waved his hand cheerily.

(S) How are you?

(E) How am I in regard to what? My health, my finances, my school work, my peace of mind, my ...?

(S) (Red in the face and suddenly out of control) Look! I was just trying to be polite. Frankly, I don’t give a damn how you are”. (Garfinkel, 2007, p. 44)

The cultural alienation that the subjects (S) were unexpectedly confronted with, i.e., the deliberate refusal of the experimenters (E) to adhere to self-evident rules that implicitly structure each and every communication, generally led to—as in the example cited above—a more or less dramatic failure or even discontinuation of communication. By revealing conditions for the non-functioning of communication, such crisis experiments indirectly refer back to the preconditions for successful communication. If verbal statements are reduced to their merely linguistic and logical content without taking into account all the layers of meaning that position these statements within a

---

<sup>6</sup> Garfinkel’s writings are based on Schütz’s phenomenological sociology, especially on his later writings (see Schütz, 1967/1932).

specific practical (time) context, within specific social circumstances under which they are made, within a specific biographical and actual situation of the speaker etc., everyday interaction collapses. In the above cited example, the circumstances (friendly waving of the hand) sufficiently characterized the first statement as a friendly greeting. Due to the experimentally induced, deliberate non-understanding of the statement's character—i.e., due to the experimenter's insistence on the abstract, logical layer of the statements, his blocking out of the situational context—the natural flow of the conversation is disrupted and the subject is 'forced' to switch to a meta-communicative level. In his second statement, he actually explains the implicit, underlying rule which determines the meaning of his first statement. In Garfinkel's crisis experiments, there are only a few such cases in which the underlying rule is made explicit. Mostly, there is no effort to meta-communicate but the conversation is simply terminated with the question whether the experimenter is out of his/her senses.

In another study, Garfinkel (2007, p. 25) asked students to record conversations and afterwards write down both the words that were spoken (left column) and what they and the speakers understood to be the topics that were in fact discussed and negotiated through these conversations (right column):

---

<p>“HUSBAND: Dana succeeded in putting a penny in a parking meter today without being picked up</p>	<p>This afternoon as I was bringing Dana, our four-year-old son, home from nursery school, he succeeded in reaching high enough to put a penny in a parking meter when we parked in a meter zone, whereas before he had always had to be picked up to reach that high</p>
<p>WIFE: Did you take him to the record store?</p>	<p>Since he put a penny in the meter that means that you stopped while he was with you. I know that you stopped at the record store either on the way to get him or on the way back. Was it on the way back, so that he was with you or did you stop there on the way to get him and somewhere else on the way back?</p>
<p>HUSBAND: No, to the shoe repair shop</p>	<p>No, I stopped at the record store on the way to get him and stopped at the shoe repair shop on the way home when he was with me”</p>

---

This juxtapositioning of the factual course of the conversation and its reconstructed meaning makes it clear that an abundance of meaning was communicated between husband and wife—meaning not immediately clear to an outsider. The meaning of what is said, i.e., “what they are really talking about” (Garfinkel, 2007, p. 41) does not immediately follow from the statements uttered. Rather, it is to be deduced from the specific meaning of these statements for the persons interacting. In this context, Garfinkel and Sacks (1970), Garfinkel (1961), Garfinkel (2007) and Sacks (1995) speak of “indexicality” or of “indexical expression” (cf. also ten Have, 2007). This means that verbal statements merely allude to their meaning and are always part of a reference context. The less conversation partners are united by

common experiences and the less they share a cultural background, the less they are able to accurately interpret each others statements on the level of first degree constructions. Garfinkel also refers to this phenomenon as “irremediable vagueness” (Garfinkel, 1986, p. 181) of everyday speech.

“Irremediable vagueness”, thus, is a constitutive element of communication. At the same time, an abundance of rules inherent to communication—rules which are constantly adhered to, albeit unconsciously—permit speakers to cope with this vagueness. To give an example, we always understand or interpret statements as parts of an overall context, i.e., as parts of a story or of a *process* that we will be further informed about in the course of the conversation.<sup>7</sup> Moreover, a vast array of everyday knowledge allows for a (pre-) understanding of the overall context of the story or conversation. To sum up, every form of communication is “understanding the other” (Schütz, 1967)—an understanding which can, however, easily be mastered with intuitive means. Certain communication rules<sup>8</sup> as well as the overall, everyday knowledge of the persons communicating are effectively permitting such an intuitive process.

Immediate understanding is all the more difficult, if the life experiences and cultural backgrounds of the communication partners are further apart, i.e., if they are not or if they are only loosely familiar with each others experiences and interaction backgrounds. Conversely, however, the *explication* of this intuitive understanding, necessary as it is to a research practice, is all the more difficult for researchers whose background is similar to that of their subjects. In this case, both researchers and researched share bodies of processual knowledge, which they can resort to when communicating with each other—without the need to explain much. Schütze, Meinefeld, Springer, and Weymann (1973, p. 442) therefore remark: “There is no other way: sociological methodology has to proceed from the implications of understanding the other...”.<sup>9</sup>

Empirical social researchers must in some way establish a communicative relationship with their subjects or must observe their communication. These are the only ways to collect empirical data. One way of dealing with the “irremediable vagueness” of communication is to strip off the indexicality, i.e., the specific reference context, of the subjects’ statements. In other words, the researcher here strives to standardize the meaning conveyed in a communication. Such communication loses its embeddedness in particular and always milieu-specific practices. Questions or stimuli are to be understood by *all* subjects in an identical manner, and the irremediable vagueness inherent to any understanding the other is to be eliminated. Likewise and consequently, subjects’ reactions to such streamlined stimuli are then interpreted within in a similar standardized frame. In this case we are referring to a *standardized* investigation procedure. Standardization here serves as the foundation of intersubjective verifiability—one of the pillars of empirical research.

The other, opposite empirical access lies in a “controlled method of understanding the other”—a research approach that was first conceptualized by Schütze et al.

<sup>7</sup> This principle can also be observed in the last example cited above.

<sup>8</sup> The following sections will give further detail on these rules.

<sup>9</sup> The concept of ‘understanding of the other’ (“Fremdverstehen”) was first formulated by Alfred Schütz (1967, p. 87ff., 95, 146, 219ff., 244ff., 259, 268ff., 304, 317, 399ff.). Methodological writings by Schütz as well as those by Garfinkel refer back to Schütz’s earlier writings.

(1973). In this approach, the indexicality of everyday communication is systematically considered so as to guarantee the intersubjective verifiability of the translation from everyday knowledge to scientific knowledge. Compared with the above cited scenario, the strategy is reversed: Communication is “captured” to as great an extent as possible in its specific reference context. The element of indexicality—constitutive to communication as it is—is, thus, not ignored, but rather consciously and systematically taken into consideration. This also implicates to accept the aliveness of language and to consider the socio-historic embeddedness of meaning structures (cf. Przyborski, 2004, p. 22ff.; Slunecko & Hengl, 2007; Slunecko, 2008, p. 135ff.).

For research practice this means to allow subjects to present their situations, problems, life stories etc. within their own system of relevance and in their own language. This is the only way to obtain material that allows us to then elaborate the indexicality of the statements *within their context* in a step by step procedure. The subjects’ presentations are either recorded on sound storage media or video or they are already available in reproducible form (family photos and other pictures, written documents, films, etc.). Particular statements or documents can thus be examined within contexts that the subjects themselves have created. For example, depending on what has been said immediately before and immediately after, a particular statement may appear as an instruction<sup>10</sup> in the context of a family dinner table talk (Kepler, 1994).<sup>11</sup>

The term ‘methodical controlled’ in the title of this subchapter refers to the control of the differences between the subjects’ and the researchers’ presentation forms, systems of relevance, and frames of interpretation. These differences are systematically taken into account and the transfer from one frame into the other is guided step by step and, thus, controlled. In the empirical part of the research this is ensured by creating the conditions for communication in such a way that subjects are free to find and follow their own form of presentation. And the analysis starts out from the subjects’ contextualizations and frames instead—as in the standardized procedures—from those pre-fabricated by the researchers. This means that a subject’s particular statement is, for example, interpreted within its *own* context and not within the context of a test or questionnaire in which certain interpretations are a given.

## Collecting Subjective Theories versus Elaborating Process Structures of Practice

A frequent misunderstanding of qualitative methods lies in the assumption that one simply has to collect and systematize the subjects’ knowledge pertaining to the object of investigation. This is one of the tasks of social reporting, but it is in principle not characteristic of the type of methodology we are here aiming to define.

<sup>10</sup> Luckmann treats instructions as a “communicative category” (cf. Luckmann, 1986; Günthner & Knoblauch, 1997).

<sup>11</sup> In a systems theoretical perspective, this means to take into account the particular logic (“Eigenlogik”), i.e., the self-referentiality of the selected entity—be they autobiographic recounts, table talk or photos—and to analyze the entity in accordance with this particular logic.

On the contrary: many phenomena of interest to the social and human sciences *cannot* be directly accessed. The reason for this lies in the fact that human action would be seriously inhibited, if everything we do were to be thought out and made conscious.<sup>12</sup> This insight is all but new; standardized methods sometimes deliberate it in the context of the dubiousness of self-report data. In some of the standardized methods this problem is encountered (and warded off) by way of test constructions, or constructions of experiments, which are based on highly complex and concrete assumptions about the genesis and sustainment of certain forms of practice, i.e., based on so-called psychological constructs. But here it is not the subjects themselves who describe and explain their actions in their own logic (and if this were the case, they would be forced to produce an own *theoretical* account of their practice). Rather, certain highly restricted forms of practice are provoked, which investigators then use as empirical evidence for their, i.e., the researchers', constructs.

Moreover, our daily practice expresses a great deal more than our personal intentions or our individual personality. Simultaneous to what may be our conscious intentions, we act as a woman or as a man, as a member of a social class, as an inhabitant of a country, as the child of certain parents with certain cultural and biographical experiences. Because social meaning unfolds 'through us',—i.e., beyond our intentions, rather taking us as vehicles (cf. Slunecko & Hengl, 2007)—an individual cannot simply give, in a direct sense, information about the full meaning and genesis of his/her practice. The matter is actually highly complex: the meaning of a certain practice as well as the emotionality which motivates and keeps up this practice is not an individual, but a social and often collective issue.

How do qualitative methods approach this complex of problems? Roughly speaking, two analytical directions, or observer positions, can be differentiated (also cf. Bohnsack, 2001b). We consider only the latter of these praxeological, i.e., process-oriented.

The second degree constructions of science, as discussed in the first section of this chapter, have to somehow fasten on to the subjects' constructions, i.e., to their theories of everyday life, and to how these theories are made up. Accessing, collecting, documenting, and systematizing these theories and assigning them to certain groups or classes is *one* form of observation and analysis. In Luhmann's (2002) terminology, however, all such activity still belongs to the logical class of first order observations; because it is assumed that subjects in principle observe their own practice in a manner very similar to that of scientific observers. The only difference between them is that scientific observers know how to collect, document and to put material into a certain order according to topics, subject areas, etc.

This type of qualitative research is especially prevalent in psychology. It seems to articulate a certain counter movement to the incapacitation of subjects that goes along with standardized test and experimental procedures—at least, subjects here

---

<sup>12</sup> If the meaning of some self-evident everyday (inter)action—such as flirting—is made explicit, the situation usually changes in a fundamental way. This may, for example, be the case if one of two persons flirting says to the other, 'We're flirting so much we'll miss the green light'. This remark abolishes flirting as the primary frame, i.e., as the frame which determines the interaction. Once the flirting is suspended, the attention of the driver or of the couple may refocus on the traffic, at least momentarily.

are allowed to speak, and what they speak is taken up by science. Studies which employ ‘open interviews’, ‘guided interviews’ or ‘open, written interviews’ are typical for this research approach. Along its lines, e.g., subjective theories on health or illness have often been developed (Slunecko, Fischer-Kern, Zimmerleiter, & Ponocny-Seliger, 2007; Frommer, 1999; Frommer, Reissner, Tress, & Langenbach, 1996; Flick, 2000b, 2006, p. 158f.).

Qualitative approaches that are part of this research tradition are thus directed to the same object as is common sense. They focus on systematically collecting or understanding subjective interpretations, attitudes and everyday theories (cf. Helsper, Herwatz-Emden, & Terhart, 2001, p. 256). This perspective is very much oriented on ‘descriptions’, as has, for example, been pointed out by Hitzler (2003, p. 50).

The *second* analytical direction or is characteristic of the methods this chapter primarily addresses. Garfinkel’s crisis experiment described above is a variety of this analytical attitude. We would like to use this incident, i.e., the above cited example by Garfinkel, for a more thorough exemplification of our praxeological, process-oriented analytical attitude: A student hastily asks his fellow student how he is doing. The fellow student (and experimenter) asks back the student to specify his question. The student becomes angry, saying that he was simply trying to be polite. Through this expression of subjective meaning (i.e., anger) we, above all, find out what it is *not*: it is no real interest in his fellow student’s well-being. At the same time, however, the fellow student’s ‘derailment’ helps us learn about a rule of establishing (this) interaction: It is about a form of politeness by which contact is made. In this case, by using a question about another person’s well-being as a greeting formula. At this point, also the rule of interaction the student orients himself by becomes clear: A greeting—this we know intuitively—expects a greeting in return. By closely examining this case beyond the layer of subjective meaning, thus, we have specified a rule of establishing social interaction. Sacks (1995, p. 521ff.) has elaborated and abstracted these rules of establishing conversation. He has identified a series of verbal forms, which are to be followed by very specific other verbal forms—as a question, for example, is to be followed by an answer. These “adjacency pairs” determine the development and the course of conversations; in this sense they are a process structure.<sup>13</sup>

In the above case, the interest in the rule of establishing interaction was limited to the *formal* structure of the interaction—a limit which is typical for *conversation analysis*.<sup>14</sup> However, rules can also pertain to the *meaning* of a particular behaviour or a particular communication within a specific context. Taking this layer of meaning into account leads us to the social rules (cf. Oevermann, 2000); which underlie and ‘bring forth’ the phenomenon we wish to analyze.

Let us approach this type of analysis with the help of another example (which is detailed in Bohnsack, Loos, & Przyborski, 2001, p. 189ff.; Przyborski, 2004, p. 184ff.): Two young men of Turkish origin who are living in Berlin discuss about how to find a partner for life. One of them most decidedly pleads to solve the

<sup>13</sup> For a critical examination and elaboration compare Przyborski, (2004, p. 19ff).

<sup>14</sup> The rules of ‘turn-taking’ are here of particular interest (Sacks, Schegloff, & Jefferson, 1974, also compare with Kallmeyer & Schütze, 1976; Streeck, 1983).

problem himself, independent of his family. The other young man considers his family of origin to play an important role in this area of his life and thinks it better to yield to their advice and decisions. If only the manifest statements—i.e., the level of opinions and attitudes—were taken into consideration, we would be confronted with two opposing and static positions. A more thorough analysis along the lines outlined above, however, reveals that their disagreement only represents the two poles of one single dilemma in their action orientations out of which two different process structures can be reconstructed:

Firstly, the choice of a partner and the establishment of a lifetime partnership on the basis of a *corresponding social habitus*. Because the parents are familiar with their own familial habitus, they are in a good (or maybe: in the best) position to transform this principle into the practice of finding a partner for their children. Parents are therefore the ones to determine the choice of a partner, to arrange the wedding, and to further the socialization of the new partner. The other principle concerns partner-choice and marriage on the basis of romantic love, i.e., on the basis of individuality, the *uniqueness which characterizes a particular person* (to the average Euro-American mindset, this later principle is a lot more familiar). The young men were incapable of habitualizing either one of the two forms; their accounts reveal that although they know about these forms, they are fundamentally unfamiliar with them in praxis. Therefore, despite all the differences in their strategies and attitudes, both their approaches share a common orientational dilemma: the alienation from their origin of culture which left a praxeological gap in terms of factually managing to find a partner and incapacitates both young men at an important stage of their development.<sup>15</sup>

Contrary to what we are used to do in everyday life, this analytical approach does not focus on what someone says or means to say, but rather on the structure of meaning that is underlying his or her action—the very structure which brings forth action in the sense of social genesis, i.e., process structure. Following Luhmann, thus, one could say that this approach is all about “second order observations” (Luhmann, 1990, p. 86ff.), insofar it is observing how subjects observe and then explicates these observations, i.e., explicates the specific way in which they create their reality. Its aim is to reconstruct the differentiations, i.e., the perspective taken by the subjects; it is not aiming at statements on how the world really is, but about how the world is constructed by the (observed) observer. Luhmann (2002, p. 157) refers to this form of observation as an observation which pays for a gain in complexity with a loss in ontological certainty.

### ***A Return to Mannheim***

Along these lines, Mannheim speaks of a bracketing of validity claims (Mannheim, 1980, p. 88). It is by this bracketing the ontological validity that we can examine, how something has emerged, how a particular social behaviour has come into being

---

<sup>15</sup> Compare Bohnsack, Loos, and Przyborski, (2001) and Nohl, (2001).



(Mannheim, 1980, p. 91). Mannheim refers to this perspective as a “socio-genetic” or “genetic” one; it explains the social structures as the results of a socio-psychological context of experience (“Erlebniszusammenhang”, Mannheim, 1980, p. 89); and it is exactly this “context of experience” that has to be reconstructed.

Such reconstruction demands a differentiation between (at least) two levels of meaning. The first level of meaning corresponds to the first analytic attitude. It is focussed on the reconstruction of common sense theories, i.e., on what competent communicators could instantaneously interpret if they took the time necessary for a systematic reconstruction. The second level of meaning largely corresponds to the second analytic attitude, i.e., to the approach described above. It is about habitual practice as well as about the ‘objective meaning’ or ‘document meaning’ (in Mannheim’s sense) of particular statements.

Habitual practice action is so utterly natural that to become conscious of it would interrupt this practice. In this context Bourdieu (1984) speaks of the habitus as a ‘modus operandi’, i.e., a structuring structure, which brings forth social practice and other social matters.<sup>16</sup>

This means that interpretation and analysis require a differentiation between these two levels of meaning; moreover, the relation between the two levels needs to be defined. Narration analysis, e.g., within the scope of biography research, carefully differentiates between the intended ambitions and theories on one’s own self on the one hand, and the actual practice (often in the sense of an unintended being processed by institutional, historic, etc. forces) as it documents itself ‘in the shadow’ of such theories on the other hand. More often than not the ‘knowledge’ which is really guiding a subject’s practice cannot be accessed via his or her explicit theories and explanations, but is otherwise embedded in descriptions and accounts of his/her everyday practices. For this reason, narration analysis focuses on the relation between accounts and argumentations. Documentary interpretation of, for example, group discussions employs a similar differentiation between the immanent, literal meaning and the documentary meaning, in which collective (practical) orientations document themselves. In a similar vein, objective hermeneutics considers the differentiation between subjective (i.e., manifest) and objective (i.e., latent) meaning of great importance. Conversation analysis also aims to differentiate between levels of meaning; it differentiates between the literal meaning and the formal principles governing the structure of conversation.

## Common Standards for Qualitative and Quantitative Research

One of the key challenges for the discourse between the quantitative and the qualitative camp in the human and social sciences is to agree upon shared *value criteria*, i.e., to formulate common standards. In this chapter, we want to take up and

<sup>16</sup> Also, art historian Panofsky differentiates between these levels of meaning within the context of the depictive arts. He, too, understands habitus—or, the historically generated totality of ‘Weltanschauung’—as a vehicle of the second level of meaning (cf. Panofsky, 1939, 1955).

advance this challenge, given the relatively little attention it has received up to now.<sup>17</sup> In our view, this very agreement on common standards—in a terminology accessible for both sides—carries the potential to adequately appropriate the relation between different forms of empirical social research. Therefore, we will structure the debate along the classic value criteria of nomothetic psychology. As any monopolization of one side by the other would threaten this endeavour, however (Steinke, 2004), we start with acknowledging two important differences between the two approaches (thereby taking the commonalities of qualitative methods, as we have discussed them, as our starting point): their different way of referring to empirical data and their different communication with subjects. With quantitative methods, this communication is standardized, i.e., before or after data collection the possible or allowed units of observation have to be clearly defined. With qualitative methods this is not the case. Contrary to what is often heard, however, the decisive difference does not simply lie in the ‘openness’ of the communication with the subjects. The key difference is rather that qualitative methods—at least of the reconstructive type—account for the different systems of relevance of researchers and subjects in a systematic and controlled manner. As we have pointed out, this is done through reconstructing common-sense-constructions and by considering the subjects’ own contextualizations.

### *The Question of Validity*

The validity of an empirical method can be defined in the following way: validity indicates whether and to what extent the conceptual-theoretical scientific construction underlying this method is suitable for the research phenomenon in question. *Reconstructive methods* proceed—as has already been expounded—from the assumption that all practice is fundamentally structured by meaning. This meaning, however, is generally not—or only to some rather small extent—accessible for the subjects in the form of conceptual, theoretical knowledge. Nevertheless, this meaning reveals or documents itself in all the subjects’ practice and artefacts. The central task of the researcher is to reconstruct this meaning, i.e., to transfer it to a conceptual-theoretical form. *Quantitative procedures*, on the other hand, carry out their constructions in advance. Here, theories and constructs—though they may sometimes be partly owed to pre-tests or ‘explorative’ preliminary studies—are developed *before* entering the empirical field. These theories guide the construction of (test) instruments—instruments which are considered valid if they strongly correlate with some external criteria (e.g., performance in school) that is associated with the phenomenon (e.g., intelligence), but can reasonably be considered independent of test results.

By contrast, qualitative methods either focus on the phenomenon itself—be it by way of participant observations, or by an analysis of cultural products like

---

<sup>17</sup> Seale (2000); Silverman (2006) and Bohnsack (2004) are notable exceptions.

pictures and conversations—or on the subjects' everyday reconstructions of these phenomena in accounts and descriptions. Due to their raw data they are therefore closer to the phenomenon.<sup>18</sup> This may be the reason why the validity of qualitative research has rarely been explicitly discussed, but rather has implicitly been taken as a given.

Such proximity to the objects of investigation, however, is still insufficient to determine the validity of qualitative results. But how can qualitative methods make sure they have adequately reconstructed and understood their data? They cannot resort to an 'external criterion' (to express this strategy in the language of quantitative methodology), because for the most part an everyday phenomenon—an 'external criterion'—is the very starting point of research. This is unlike the quantitative approach—where this starting point is smallest units which are measured independently of their context and are analyzed as indicators for social scientific constructs (cf. Slunecko, 2008, p. 219). For qualitative methodology, however, it makes no sense to test whether an indicator or a construct has any meaning for everyday phenomena.

Above all, scientific constructions in qualitative methodology have to be adequate to the observed practice by their way of collecting empirical data. If one wants, for example, to investigate the specifics of the interaction between physicians and patients during bio-psychosocial anamneses, but only interviews patients on their view of this interaction, one falls short of the alleged research interest, as only one side of the interaction is examined. To meet this interest, it would be essential to proceed from the interaction itself; therefore the actual conversations have to be available in the form of highly detailed transcripts.

Moreover, the common sense constructions that are employed in this interaction (i.e., what competent members of the interaction community can identify as its topics) have to be adequately reconstructed (Schütz, 1962). More comprehensive from a methodological point of view, the adequacy of *scientific* understanding can be determined on the basis of a *reconstruction of the everyday methods of understanding*. If we understand and are able to explicate the (implicit) foundations on which everyday understanding is based—following Habermas (1981, p. 176 ff.): its formal pragmatics—then we can substantiate our scientific reconstructions on this basis (cf. Przyborski, 2004, 38ff.; Soeffner, 1989).

Ethno-methodologists (e.g., Garfinkel, 2007; Atkinson, 1988) have opened the perspective for these 'methods' of everyday life, these "ethno-methods" (cf. Bohnsack, 2004). Inspired by ethno-methodology, conversation analysis—and ethnology of speech have led to first important insights in this area. A very simple form of such establishing of an everyday understanding are the adjacency pairs described above (Sacks, 1995): It is only when we have correctly understood the semantic content of the first sentence of such pair that we are able to formulate a suitably corresponding second sentence. If a person, however, responds to an invitation with a greeting we know that he/she has not understood.

---

<sup>18</sup> Sometimes, this close exposure to the phenomenon may lead researchers to abandon questions which had directed their endeavours in an initial stage in order to follow more promising paths that better suite the phenomenon.

A further, and meanwhile ‘classical’ example for this is the reconstruction of another important method of everyday understanding, namely that of a ‘narrative’. The formal structure of narratives was reconstructed in the 1970s (cf. among others with Labov, 1964, 1966, 1968; Sacks, 1995). Since this groundbreaking work, we are able to differentiate, by formal criteria, between narratives and other types of texts. Moreover, we know that narratives serve in everyday life to share and pass on what is going to be considered ‘valid ‘facts’.

A further example taken from current research pertains to forms of establishing everyday understanding which do not proceed from individuals as entities of interaction: Groups of people produce particular conversation *modi* only when their members share a layering of experiences—an experience space—that is identical in structure. Only when people have certain experiences in common, their group discussions or narrations display successions of experiences, anecdotes or occurrences, which all focus on the same structural problem, dilemma or resource—but without ever explicitly formulating the point. Groups, whose members differ in their layerings of experience, in their experience spaces, show other, different *modi* of conversations, five of which have already been identified (cf. Przyborski, 2004; Bohnsack & Przyborski, 2006). If we understand milieu and culture as the far-reaching concurrence of layers of experience and of orientations for practice, the knowledge of such formal principles of communication can help to define the nuclei and boundaries of milieus and cultures; and most importantly, from a methodological point of view, these principles of communication can be elaborated on an empirical basis and need not be defined in advance.

Formal principles of everyday practices, thus, play an essential role in the process of establishing understanding. Such formal principles are not only present in conversations and texts, but also in pictures and gestures. Their reconstruction, i.e., the conceptual unfolding of these everyday methods of understanding, is a precondition for the explication and formalization of scientific methods of interpretation. We must therefore reconstruct *how* societal facts are created by way of communication. Only then, our conceptual-theoretical constructions will be adequate and will thus carry the potential for well-grounded social scientific theories.

The explicit demand for this step in the further development of empirical methods was becoming more visible in the 1980s.<sup>19</sup> Speaking with Habermas (1981, p. 176), the very structures which enable understanding provide the means for a reflexive self-control of the understanding process. Soeffner (1989, p. 60) focuses the argument even more strongly on methods:

Non-standardized methods relate to natural standards and routines of communication; these standards and routines have to be known and their function has to be understood, before any data that are based upon them can be interpreted in a controlled way (translation T.S.).

The implicit rules which enable everyday communication and which secure immediate understanding in our life world, thus, are the basis for the validity of reconstructive methods. By making these forms of tacit knowledge (Polyani, 1966)

---

<sup>19</sup> Mannheim took this step (Mannheim, 1980, 1964, compared with Bohnsack, 2001a; Przyborski & Wohlrab-Sahr, 2008, p. 271ff.) already at the beginning of the 20th century.

explicit, we can demonstrate that our reconstructions represent an adequate understanding—and by this secure the validity of our interpretations.

### *Understanding Reliability*

In the context of standardized methods the reliability of a given set of measures or a measuring instrument is the extent to which an experiment and its results can be reproduced. It indicates the precision of a given measurement or the reproducibility of test results (Diekmann, 2004, p. 217). For ensuring reliability operationalization plays a central role. Operationalization entails a maximally precise description of how empirical data and theoretical concepts are linked to each other. It furthermore requires a precise definition of the indicators to be observed and measured. Note that the recording of observations by means of operationalizing and generating indicators is per se already an act of interpretation.

By contrast, the recording of observations in the context of qualitative methods entails little to hardly any interpretation at all, thus rendering quantitative reliability tests like repeating or splitting measurements unnecessary. Splitting measurements is one of the most common means to determine the reliability of quantitative methods. A test or a battery of items is split into halves. The resulting briefer batteries of items are supposed to measure the same phenomenon. If they actually produce the same results the test or battery is considered reliable. The extent of consistency between parts of a battery allows for a reliability estimation,<sup>20</sup> which in turn indicates that the relation of concepts and observations is exact enough. Reconstructive methods, however, only relate empirical facts with ‘object-theories’ at a later stage of the research process (see below). Reconstructive research, too, is far from being void of theories. However, observations are not regarded as indicators of a priori defined constructs but as documents, i.e., as meaningful social products. The theoretical potential of observations only unfolds in the process of interpretation after the initial recording of data. The question to be asked is not: ‘Can a given measurement be reproduced?’, but: ‘Are scientific studies reproducible in the first place?’

Qualitative methods are confronted with these questions for good reasons: Can the results of a study be reproduced or do qualitative researchers analyze valid but singular cases? This difficulty also concerns the study itself. Are the initial data comparable? Did we collect data about completely different phenomena during each and every interview or group discussion? How can we compare data that have been collected ‘openly’ and thus appear in various forms?

For both quantitative and qualitative methods reproducibility and the possibility of comparing data are indispensable for the development or validation of theories. As a key to the solution of this problem, quantitative methods propose the standardization and operationalization of measurements and their interpretation. Reconstructive methods, by contrast, draw on the following two principles:

---

<sup>20</sup> See Diekmann (2004, p. 217ff.) in more detail.

1. Reconstructing *everyday* standards of communication and interaction.<sup>21</sup>
2. Accessing a particular discourse's logic of reproduction and/or accessing homologies within and across cases.

Reconstructing everyday standards of communication and interaction allows us to compare data across various subject-matters. The axis of comparison might, for example, be the relation of narrative and argumentative strands of an interview when comparing autobiographic impromptu narratives. It is only against this backdrop that the thematic development of different interviews can be interpreted and compared. Even more, the reconstruction of everyday standards of communication and interaction allows us to control the interventions of the researcher: Did the researcher formulate the question in a way allowing interviewees to unfold their experiences and priorities? Was the prompt for the narrative really adequate for provoking a narrative (see Schütze, 1987; Przyborski & Wohlrab-Sahr, 2008, p. 92ff)? A third advantage of reconstructing everyday standards is the formalization of various steps of interpretation. In the case of the narrative interview this formalization amounts to the separation of narrative and argumentative strands within the text as a crucial step of the interpretation process. Standardizing the steps of interpretation ensures reproducibility, comparability, and inter-subjective accessibility.

How the identified pattern reproduce themselves—their logic of reproduction (Oevermann, Allert, Konau, & Krambeck, 1979; Oevermann, 2000, p. 124ff.)—has to be verified within single cases (be they interviews or group discussions, images, or films) as well as across the various cases. The objective is to show that certain structural elements—e.g., a distinct divide between two spheres within one and the same milieu (see the example of the Turkish migrants below<sup>22</sup>)—are not arbitrary but systematic for the single case and for other cases.

Both principles untie the interpretation from the often seemingly arbitrary *thematic* structure of single cases. Accordingly, the interpretation does not aim at summarizing themes but at reconstructing these themes and the recurring structures they express. A theme in a group discussion might be consumption of alcohol, music making, or dancing. The three themes might, however, be manifestations of an overall actionistic orientation, i.e., an orientation characterized by actions that are not instrumental-rational but seek out to get enmeshed in unforeseeable entanglements.

In the interpretation of biographical material the researcher will often encounter strategies of problem-solving (or -avoiding) that recur at different times and places. This mode of problem-solving or -avoiding becomes a characteristic for this biography which also allows for the reconstruction of commonalities with other cases, even if they differ considerably in content (cf. Wohlrab-Sahr, 1994).

The interpretation thus consists in the search for recurring identical structures—*homologies* (Mannheim, 1964)—within a single case, across different cases, and regardless of thematic incommensurabilities. The interpretation is

<sup>21</sup> Reconstructive methods also have standards, but these are natural standards. Consequently, the whole logic of standardization is to be based on these natural standards of communication and interaction.

<sup>22</sup> Compare for this example Bohnsack (2001c) and Przyborski (2004, p. 198).

finished as soon as the same structure is identified in different passages (Oevermann, 2000). In the terminology of quality criteria typical for standardized methods we could say: the interpretation is then considered reliable. Interpreting a biographical interview we may see, e.g., that whether the interviewee recounts one or the other example does not really matter. What matters is that all his examples express the *same structure*. We may also find that the interviewee's reaction to a sudden interruption of the interview manifests the same structures as the narrated episodes, or that an image composition has the same underlying structure as the depicted gestures.

### ***The Perennial Problem of Objectivity***

An empirical method is considered objective if its results do not depend on the subject employing the method. Compared to the other two quality criteria—validity and reliability—objectivity is a relatively weak criterion. A poor instrument or method does not produce better results only by producing the same results no matter who is using it (cf. Diekmann, 2004, p. 217). Beyond the differences between qualitative and quantitative methodologies there is a mutual consent concerning the necessity of an inter-subjective accessibility of data. However, debates about objectivity tend to get bogged down in the aporia of subjective arbitrariness versus temporally and spatially unbound (nomothetic) propositions (supposedly) disconnected from the subjects uttering them. To avoid both this fruitless dichotomy and the often concomitant accusation of arbitrariness, respectively, we have to turn to Mannheim's key insight that all knowledge is bound up with a concrete (socio-historical) position—the so-called rootedness (*Standortgebundenheit*) of knowledge in a specific experiential space (Mannheim, 1982, p. 219f.)—and integrate this insight into our methodological considerations. As with the two other quality criteria, reliability and validity, observing the ways in which objectivity is ensured within the logic of hypothesis testing opens the perspective for a comparable method(ological) foundation of reconstructive methods.

The objectivity—i.e., the inter-subjective accessibility—of quantitative methods depends upon the standardization of a given procedure. Standardization is supposed to ensure that the given procedure can be reconstructed, controlled, and/or reproduced by others. Whenever social scientists collect observational data they enter a communication process with their subjects—a process which is, however, substantially indeterminate. Hypothesis testing tries to predetermine the structure of this process on the basis of theories. The communication between researcher and participant is thus standardized in advance. Only elements of communication that have been subject to an *ex ante* definition enter the research process.<sup>23</sup> Hypothesis tests, thus, employ standardization

---

<sup>23</sup> This also holds for content analysis, at least to some extent: The coding of categories found in openly collected material must be finished before the final interpretation of the material. Different coders are then expected to attain sufficiently identical results by applying the same system of categories to the same material. Utterances not anticipated in the coding rules have to be neglected or to be dumped in a rest category. From the point of view that we are developing here, content analysis (cf. Mayring, 2000) therefore rather belongs to the hypothesis testing side.

in order to ensure the inter-subjective accessibility of results. The ideal of communication within such research logic is untouched by historical and social conditions, and by the presence of the researcher. The influence of the researcher is controlled by standards set on the basis of theories. The ways in which objectivity is aimed for in hypothesis testing assigns the researcher a position *outside* the social world he or she is investigating. Reconstructive methods, however, include the researcher's position *within* the social world in their methodological considerations. In that regard, they do not presuppose an epistemological difference between researcher and participant.

How do reconstructive methods handle the indeterminacy of communication with regard to a possible inter-subjective accessibility of results? In effect, they take the exact opposite route. It is neither assumed that the variation of meaning will be averaged by random distribution nor that it can be controlled in the above described manner. The aim is rather to capture communication and its carriers—be they verbal, pictorial, scenic, mental or material objects—as completely as possible. The researcher does not predetermine response categories allegedly understood by all participants in the same way. She/he rather creates a setting allowing participants to unfold their respective narrative form. Stimuli, questions, or reactions of the researcher are considered part of the material. Images are not interpreted according to predefined content categories but according to their own pictorial logic (see Ruck & Slunecko, 2008).

In order to get hold of variations in meaning, reconstructive methods take advantage of specific structures that ensure understanding—even the communication of not-understanding—in everyday life. These everyday standards of communication fulfil a function for reconstructive methods that is comparable to standardization in the context of hypothesis testing. In order to ensure inter-subjective accessibility, these standards must not be applied intuitively.

The reconstruction or explication of communicative rules, i.e., of everyday standards of communication, sheds light on how the process of understanding takes place between researchers and participants, but also amongst participants (Schütze et al., 1973, p. 446). Reconstructive social research thus ensures inter-subjective accessibility by explicating underlying rules of communication rather than following them intuitively as in everyday life. Verbal standards of communication have been thoroughly studied over the past years. Moreover, there are already very elaborate methods of text interpretation at hand. Image and video interpretation and the interpretation of material artefacts, however, necessitate further research efforts. They constitute a notable challenge for the empirical methods of the social sciences (cf. Bohnsack, 2008; Przyborski, *in press*).

## **Further Quality Criteria: Meta-Theoretical Foundation and Generalizability**

### ***Meta-Theoretical Foundations***

A common prejudice against qualitative methods accords them a complete abandonment of theoretical (prior) knowledge, at least at the beginning stages of a study.



Some rather early qualitative methods (e.g., Glaser & Strauss, 1967) do indeed conform to this estimation. However, to the extent that former frontlines have lost their meaning, these—often polemical—positions have been put into perspective or have been paraphrased as an only temporary, strategic bracketing of prior knowledge. The theoretical anchoring of reconstructive methods nevertheless differs substantially from quantitative methods or hypothesis testing. We can juxtapose the respective research processes as follows:

---

A quantitative study begins with the elaboration of a *research question* on the basis of an *object-theory*.<sup>a,b</sup> Incentives can be manifold: the researcher has discovered a gap in a theory concerning a social scientific subject (e.g., “information processing and coping with anxiety”- Vitouch, 2007) and the study is intended to close this gap; two competing theories call for verification; a classical theory’s empirical applicability to a recent phenomenon is scrutinized. Pre-existing object-theories constitute both the initial point and the final point of all empirical effort. They *dictate every further step*:

Object-theories provide hypotheses. These are operationalized, i.e., it is explicated how they can be validated by means of measurement and quantification. At this point methods and instruments are selected. Statistical results must be *interpreted* within the confines of the object-theory.

Alongside a specific *research interest* and an *empirical approach* to the phenomenon, the decision for a formal theory or *meta-theory* constitutes the beginning of a qualitative research process. A meta-theory elaborates terminological-theoretical foundations which do not directly address the object of the respective research interest: e.g., What is meant by collectivity, identity, action, motive, orientation or orientation pattern? Research interest, phenomenon, and meta-theory need to be matched.<sup>c</sup> Meta-theoretical considerations structure the choice of methods and of techniques of data collection, analysis, and interpretation. Object-theories are the results of any research process. Meta-theories, however, can also experience re-formulations and elaborations through empirical research (e.g., Glaser & Strauss, 1967; Mannheim, 1952b, pp. 246–248; Bohnsack, 1989; Przyborski, 2004). Only in the closing stages of the process are these object-theories embedded in or discussed against the backdrop of pre-existing object-theories.

---

<sup>a</sup> The phase of developing a theory, the context of discovery, or the phase of exploration are largely backgrounded within a quantitative research logic.

<sup>b</sup> Under “object-theory” we comprise both substantive and formal theories in the sense of Grounded Theory. We contrast both these terms with “meta-theory”—A difference which Grounded Theory does not know of.

<sup>c</sup> If we are interested in ‘masculinity in our current accelerated media-scape,’ we first have to determine whether our unit of analysis is masculinity on a universal, collective, or individual scale, and where to encounter the phenomenon of interest. Ultimately, the research interest already addresses masculinities as it places masculinity in the context of social, in this case medial, developments. The universal scale is thus excluded. Neither is the individual appropriate as unit of analysis since medial developments more convincingly differ from one age-group or generation to another. The research interest thus already spawns masculinity as a collective phenomenon. Consequently, the very idea of collectivity needs to be defined and explicated before we select a method and elaborate our access to the field.

Within a quantitative research logic, the above mentioned value criteria are only to be realised, if the empirical results are interpreted against the background of the very object-theory that has structured the research design, the measuring instruments, and the measurement procedure. Quantitative methods are not touched by

meta-theories and do not affect the later vice versa. They move within the circle that is spawned by their respective object-theories. It is only consequent that quantitative methodologies most often side with a philosophy of science that is—on the level of formal theories (e.g., those defining notions like ‘collectivity’) *and* on an epistemological level—immune to empirical results: Popper’s (1959/1935) “critical rationalism”.

That quantitative research practically never focuses on the meta-theoretical scaffold of the object-theories which it employs is maybe most striking in social psychology: Even in studies with collective rather than individual hypotheses (e.g., Diekmann, 2004, p. 116f.), the feature values of a collective are calculated by summing up the measures of individuals. In other words: it is taken for granted that collectivity appears as a phenomenon of sums—a conception that is meta-theoretical in nature, but usually only implicitly so.<sup>24</sup>

Abdicating nomological hypotheses<sup>25</sup> does not amount to an abandonment of theoretical knowledge or abstraction. However, hypothesis testing and reconstructive methodology are anchored in different layers of theoretical knowledge indispensable for conducting an empirical study, respectively. The theoretical knowledge involved in hypothesis testing refers directly to the object of investigation; reconstructive methodologies, on the contrary, are grounded in meta-theories that provide analytical fundamental terms for the research practice. We do not imply that object-theories should be neglected in the first place. They sharpen the research interest and must be related to the results in order to allow any general progress in knowledge. Object-theories should, however, be bracketed in the process of interpreting empirical material in order to avoid the temptation of merely subsuming the material under prior existing categories. Theorizing is an integral part of reconstructive methods right from the beginning: e.g., in trying to approach the phenomenon of interest with an analytical stance, in systematically inquiring into its conditions and consequences, in drawing systematic distinctions to comparable phenomena by roughly sketched categories. Grounded theory and objective hermeneutics in particular launch heuristic hypotheses that allow a tentative analytical grasp on the phenomenon. They are not to be mistaken with the nomological hypotheses of standardized methods, though.

Meta-theories and their fundamental terms provide both a framework and a toolkit for qualitative analyses. They are anchored in traditions of theory construction spawned by the social sciences and the humanities. For example, the methodology of the narrative interview is rooted in fundamental terms of biographical theory (cf. Schütze, 1981) and narrative theory (cf. Schütze, 1987). Biographical theory is

<sup>24</sup> For a critique of meta-theoretical premises of mainstream psychology see Slunecko (2008).

<sup>25</sup> A nomological hypothesis is a universal statement about facts and chains of events occurring within defined conditions. It is a statement about the relation between features which (if they ought to be or already have been operationalized) are also called variables (cf. Diekmann, 2004, p. 107ff.). Relations can take various forms: if-then, the more-the less, etc. Deterministic and probabilistic nomological hypotheses must be distinguished. Deterministic hypotheses formulate their validity without exceptions, while probabilistic hypotheses determine a certain statistical established probability for exceptions. The latter are more common within the social sciences.

based on premises of identity theory insofar it asks how people construct personal coherence across different contexts and contradicting experiences, and thus experience or constitute themselves as consistent (cf. Linde, 1993; Wohlrab-Sahr, 1994). Narrative theory is predicated on insights of applied linguistics (cf. Labov, 1964, 1966, 1968; Sacks, 1995) which is in turn inspired and influenced by ethnomethodology (see Garfinkel, 2007/1967) and phenomenological sociology (cf. Schütz, 1967). The meta-theoretical framework of the documentary method is spanned by such terms as ‘documentary meaning’ versus ‘immanent meaning,’ ‘the collective’ and ‘conjunctive experiential space,’ and ‘discourse organization.’ This frame of analysis is based on the works of Mannheim (1964, 1982) and on phenomenology, ethnomethodology, and applied linguistics. The theory of objective hermeneutics draws on works of Mead, Piaget, Freud, and Chomsky, among others, constituting a theory of education processes in the guise of a theory of the social constitution of the subject (Oevermann et al., 1979, p. 396).

That meta-theoretical frameworks depend on specific theoretical traditions or paradigms makes cogent that empirical research in general is bound to paradigms, i.e., that knowledge and cognition display what Mannheim has called an “aspect structure” (Mannheim, 1952b, p. 232; cf. Bohnsack, 2003, 173ff.). Fundamental theoretical assumptions determine which aspects of the social world become visible in scientific research. A research design based on a meta-theory that assumes the primordially of collective structures of meaning, i.e., that the basis of any social—also individual—meaning is always some shared collective meaning, is going to carry this collective meaning in its results. If the distribution of power is considered to constitute both the essence and the development of social processes all results are going to refer to these power structures. These theoretical assumptions are the blind spots of the respective methodological approaches. Results contradicting these implicit fundamental assumptions are often systematically ignored. There is no quick and certain remedy for this problem, but often a methodological triangulation yields a better understanding—of the field and of the empirical material—than a mono-paradigmatic standpoint.

Only a sound proficiency with the tools and frames of qualitative analysis allows for the precise development of object-related, already empirically validated theories. However, the research process is not structured by object-theories in the first place. Rather, it is essential to both flexibly and precisely apply the research principles deduced from meta-theoretical foundations. In order to adequately employ qualitative methods it is indispensable to be familiar with meta-theories.

## ***Generalizability***

Qualitative methodology increasingly addresses challenges pertaining to the generalizability of results (cf. Mitchell, 1983; Oevermann, 1991; Hammersley, 1992; Seale, 2000, pp. 106–118; Flick, 2000a, p. 259; Merken, 2000, p. 291; Bohnsack, 2005). The generalization process determines many significant steps of the research

design: Clarifying how to infer more general relations, patterns, and structures from the analysed cases, for example, necessitates thorough considerations about the composition of the sample. Generalizing such relations, patterns, and structures in a mode that is relevant for the development of theories can only proceed by way of *systematic comparison*. Qualitative and quantitative methods agree on this matter. Qualitative methods do not aim at giving estimations about the distribution of features or about the strength of (linear) relations in a given population. In other words, qualitative methods more or less explicitly refrain from claiming their results to be representative. Does this gamble away the prospect of generalizability?

The answer is no, as soon as we admit that generalisation can have different forms, different validity claims—e.g., nomologic or ‘existentially attached’ ones. Between the quantitative and qualitative camp, there is a difference in the ways in which theories are abstracted: Quantitative methods ideally aim at proposing universal, i.e., spatiotemporally unbound principles whereas qualitative methods elaborate theories that specify their own limits. This amounts to a different way of generalizing.<sup>26</sup>

There is another key difference: In all cases of inferential statistics—in which the confirmation of correlations and hence the induction of theories (or theoretical relations) is at stake—arithmetically *averaged types* (e.g., means) are compared. Qualitative methods, on the contrast, compare *ideal types*. Max Weber, the first to make this distinction, understands an ‘ideal type’ as a, by means of language, conceptualized pure type (cf. Schütz, 1967; Wohlrab-Sahr, 1994). With ideal types, social meaning is captured in an abstract manner—something which is constitutive for everyday life, too. In one of his most pivotal books, *Economy and Society* (1978), Weber developed his well-known (ideal) types of social action, thereby differentiating instrumental-rational action (“zweckrationales Handeln”) from value-rational action (“wertrationales Handeln”), from affective, and from traditional orientation.

Bohnsack et al. put the differences between qualitative and quantitative methods in a nutshell: Ideal types aim at the *representation* of social meaning rather than at representativeness (2001, p. 99ff.). In Strübing’s (2004, p. 31; referring to Corbin & Strauss, 1990, p. 421) terms, qualitative methods are oriented towards developing theories rather than testing them, and accordingly their sampling is not guided by the principle of representativeness for a general population. Instead, what they aim at is *conceptual representativeness*: The sample is expected to provide all the cases and data necessary for a complete analytic unfolding of all the features and dimensions of the significant concepts and categories pertaining to the respective object-theory.

Methodological reflections on the construction of types within qualitative methods are already considerably elaborate (e.g., Kelle & Kluge, 1999; Kluge, 1999; Gerhardt, 2001). One cannot but concede that qualitative social research has spawned an abundance of successful type constructions which prove their worth both in theory and in practice. When we now sketch one form of type constructions in some detail, this selection is thus necessarily contingent. It is owed both to our own

<sup>26</sup> See for more detail: Przyborski and Wohlrab-Sahr (2008, p. 311ff).

methodological focus and to the fact of its being characteristic for a praxeological approach.<sup>27</sup>

This particular form of type construction extracts various typifications (“Typiken” in the sense of Bohnsack, 2001b; Nentwig-Gesemann, 2001)—like developmental, generational, cultural, gender-specific, or migrational typification—from the case material. Each concrete case can be seen as an intersection of such typifications. Depending on the research question, one such typification will be the starting point for analysis. Bohnsack et al. (2001), for example, describe a migrational typification that consists of a division of inner and outer social sphere. This division marked both an orientation problem and an orientation frame for adolescent migrants, but not for a group without migrational background with which it was compared.<sup>28</sup>

From this point, the analysis proceeds, for example, by specifying how the migration-typical division of spheres documents itself in various developmental phases. Such analysis shows that this difference increasingly manifests itself as a practical problem in a late phase of adolescence—an insight which not only suggests how the migrational typification is intertwined with the developmental typification but also how it would be located in an unfolded typology.

A further comparison with adolescents of higher education then allows for the further inclusion of an educational typification. The concrete orientation and the respective solution of tension between the spheres may differ from one (educational) milieu to the other. Bohnsack et al. (2001) distinguish four milieu types: (1) exclusiveness of one’s own sphere, (2) primordiality of the inner sphere while tolerating the outer sphere, (3) (dif)fusion of spheres, and (4) search for a third sphere. From their study it is evident that, more than in a less educated group, ‘educated’ adolescents form a ‘third sphere’ that allows them to distinguish themselves both from the inner sphere (of their parents, their ethnic community) *and* the outer sphere of the host culture.

Such constant comparing and contrasting is rooted in the research logic of Glaser and Strauss (1967). The process of comparing is to be continued as long as the conditions and variants of the basic typification (i.e., the typification that is spawned by the initial research focus—here: the migrational typification) are sufficiently explored. Step by step, the explanatory power of the basic typification is thereby augmented. Moreover, as we have already hinted at, it can be elaborated towards a socio-genetic interpretation (i.e., an interpretation that focuses on the social genesis of the structure found in the material). To do so, one has to trace differences in orientations back to psycho-social differences. This is done by way of comparative analyses which, for example, vary the researched groups’ milieu whilst keeping their age and gender relations constant, e.g., by comparing migrants with non-migrants. In our example, the ensuing typification firmly rests on the hypothesis that the difference in spheres is a result of a migration milieu and not of anything else. The

<sup>27</sup> What is here treated in a predominantly theoretical way will be empirically charged—through concrete research examples—in our other contribution to this volume.

<sup>28</sup> With Weber we could say that this division of spheres—also found in other studies focusing on life-worlds in Turkey and on Turkish immigrants in Germany (Schiffauer, 1983, 1987, 1991)—is ideal-typical.

comparison with other typifications allows to test this ‘hypothesis’ while at the same time opening it to a *process logic*, e.g., by connecting it with a generational or developmental typification. It is through identifying such interaction and integration of several dimensions that a typology unfolds. A natural limit of this procedure is of course and necessarily the available material. It is unlikely that for every such typification the original case material will be as convincing and comprehensive as it is for the basic typification. Hence, some specifications will initially come across as implicit inferences (e.g., when past phases of an assumed developmental typology have to be inferred from biographic interviews instead of analyzing case material from individuals or groups that actually represent this phase). Other typifications will explicitly call for different contrast groups in order to allow for the necessary comparisons.

At this point, we might sum up the key difference between the research logic of ideal types and the research logic of quantitative mainstream psychology from a slightly different angle: The later would be forced to place the ‘division of spheres’ back into the subject and search for appropriate indicators to measure it as a (n intra-)psychological attitude. Praxeologic/reconstructive methodology, however, insists that this ‘division of spheres’ is nothing but an abstract description of social meaning and does not project it back—as something reified as a variable—into the subjects.

In this scenario, doing research consequently does not mean just to ask for (the strength or distribution of) types which one already knows, but to further unfold the typology. In other words, the objects of qualitative type constructions are not averaged types of statistical feature values but most often process structures—i.e., abstract descriptions of processes—and their genesis.

## Development and Acquisition of Praxeological Methods

A central commonality of qualitative methods is their development out of research practice. Here, common methodologies and standards are rooted in the reconstruction of successful research. Reconstructive methodology is thus affected and transformed by concrete results. In this sense, it is not only a methodology *for* (reconstructing) dynamic processes but part of a dynamic process itself. Qualitative methods not only reconstruct their objects but are themselves based on a constant reconstruction of a concrete research practice and, thus, of a reconstruction of scientific action. Herein lies a fundamental distinction to hypothesis testing which is solely based on *methodo-logic* and cannot be affected by research practice.

Up to this point we have discussed the implicit or a-theoretical knowledge of researchers as a kind of knowledge that needs to be controlled, in order not to disrupt the research process. There is a long tradition to the apprehension that the researcher’s specific social and historical position might contaminate and distort scientific results. Mannheim (1952b) has argued that these reproaches are only directed against knowledge that is to be discredited as ‘false.’ Knowledge considered as ‘true’ and

‘correct’ is never questioned as to its social anchoring. Hence, attributions of scientific results to a certain local or social position are themselves subject to a particular *zeitgeist* or *weltanschauung*. Besides that, however, this research logic ignores another—and perhaps *the*—essential element of our dynamic understanding of scientific methodology. This element pertains to what Mannheim, the founder of the sociology of knowledge, has circumscribed as the irreducible existential attachedness of knowledge (“*Seinsverbundenheit des Wissens*”). Knowledge is actually *not* restricted by this its arising from pre-theoretical experience, but made possible in the first place. That knowledge is rooted in social space and social action must in no respect be regarded as a source of error; quite the contrary, it is exactly the social embeddedness of a certain perspective that enhances the power of its grasp on certain realms of being (Mannheim, 1952a, p. 73; Schülein, 2002). *All* scientific knowledge is related to social practice—to a certain research *tradition*. It is in need of creative ‘minds’ who are children of their time. Implicit or a-theoretical knowledge as we have developed it in the previous section is an indispensable condition for this kind of creativity, and thus for successful research.

Reconstructive methods have their origins between the late 1920s and early 1930s in the context of a strong integration of research and teaching. Two essential sources of reconstructive methods are the Chicago School and the research context of Mannheim and his assistant Elias in Frankfurt/Main. Typical for both research contexts were research workshops and project seminars directly relating research practice to epistemological and methodological reflection. In a similar vein, Strauss has developed the specific research style of the Chicago School since the 1960s. Today, the proponents of contemporary reconstructive methods are the key agents of such close relationship between research practice and methodical reflection in teaching. In German-speaking countries, the tradition of research workshops is continued in Frankfurt/Main, Magdeburg, Berlin, Göttingen, Leipzig, Vienna, and other University towns. These workshops are usually characterized by a strong involvement of the participants (who are always taking part in empirical projects). This involvement might be due to the fact that life-world and research are not experienced as separate. Many of the skills necessary for interpretation are already intuitively available.

Research workshops have the further advantage that relative beginners can learn from those who already have a more profound experience and methodical expertise. The methodical elaborateness of one’s own research action is thus a *process* unfolding within discussions with others. Just as methodologies cannot be deduced from logic, a concrete research practice cannot be deduced from methodology. Acquiring a method is not a matter of internalizing methodical principles, but of being involved in research practice—of acquiring a *modus operandi* or habitus.

## Conclusion

As we have shown, reconstructive methods start out, on a rather elementary dimension, with reconstructing first degree constructions. These reconstructions of the research object are not or hardly super-shaped by (object-related) theories that could

be attributed to a single discipline. They lie beneath disciplinary theory constructions. A consequence of these elementary reconstructions of objects is the possibility of criticizing object-theories on the basis of empirical results (Oevermann, 1979). Praxeological methods thus have the task of revitalizing and innovating rigid theories (Bohnsack & Marotzki, 1998, p. 7). Finally, there is one further implication and task of explicating everyday, action-guiding orientation patterns or general *modi operandi*: It can overcome the often-lamented hiatus between practice and theory in psychology and between fundamental and applied research.

## References

- Atkinson, P. (1988). Ethnomethodology: A critical review. *Annual Review of Sociology*, 14, 441–465.
- Bergmann, J. R. (2000). Ethnomethodologie. In U. Flick, E. v. Kardorff, & I. Steinke (Eds.), *Qualitative Forschung. Ein Handbuch* (pp. 118–135). Reinbek, Germany: Rowohlt.
- Bohnsack, R. (1989). *Generation, Milieu und Geschlecht—Ergebnisse aus Gruppendiskussionen mit Jugendlichen*. Opladen, Germany: Leske u. Budrich.
- Bohnsack, R. (2001a). Dokumentarische Methode. Theorie und Praxis wissenssoziologischer Interpretation. In T. Hug (Hrsg.), *Wie kommt Wissenschaft zu Wissen, Vol. 3: Einführung in die Methodologie der Sozial- und Kulturwissenschaften* (S. 326–345). Baltmannsweiler: Schneider.
- Bohnsack, R. (2001b). Dokumentarische Methode. In T. Hug, (Ed.), *Wie kommt Wissenschaft zu ihrem Wissen? – Band 2: Einführung in die Methodologie der Sozial- und Kulturwissenschaften* (pp. 326–345). Baltmannsweiler: Schneider.
- Bohnsack, R. (2001c). Typenbildung, Generalisierung und komparative Analyse. Grundprinzipien der dokumentarischen Methode. In R. Bohnsack, I. Nentwig-Gesemann, & A. M. Nohl (Eds.), *Die dokumentarische Methode und ihre Forschungspraxis. Grundlagen qualitativer Sozialforschung* (pp. 225–252). Opladen: Leske+Budrich.
- Bohnsack, R. (2003). *Rekonstruktive Sozialforschung. Einführung in die Methodologie und Praxis qualitativer Forschung. 5. Auflage*. Opladen: UTB/Leske+Budrich.
- Bohnsack, R. (2004). Standards nicht-standardisierter Forschung in den Erziehungs- und Sozialwissenschaften. *Zeitschrift für Erziehungswissenschaft*, 7(4), 65–83.
- Bohnsack, R. (2005). „Social Worlds“ und „Natural Histories“. Zum Forschungsstil der Chicagoer Schule anhand zweier klassischer Studien. *ZBBS*, 6(1), 105–127.
- Bohnsack, R. (2008). *Qualitative Bild- und Videointerpretation. Die dokumentarische Methode*. Verlag Barbara Budrich/UTB: Opladen & Farmington Hills.
- Bohnsack, R., Loos, P., & Przyborski, A. (2001). „Male honor“. Towards an understanding of the construction of gender relations among youths of Turkish origin. In H. Kotthoff & B. Baron (Eds.), *Gender in interaction* (pp. 175–207). Amsterdam: John Benjamins Publishing.
- Bohnsack, R., & Marotzki, W. (Eds.). (1998). *Biographieforschung und Kulturanalyse. Transdisziplinäre Zugänge qualitativer Forschung*. Opladen: Leske+Budrich.
- Bohnsack, R., & Przyborski, A. (2006). Diskursorganisation, Gesprächsanalyse und die Methode der Gruppendiskussion. In R. Bohnsack, A. Przyborski, & B. Schäffer (Eds.), *Das Gruppendiskussionsverfahren in der Forschungspraxis* (pp. 233–248). Opladen: Verlag Barbara Budrich.
- Bourdieu, P. (1984). *Distinction: A social critique of the judgement of taste*. London: Routledge.
- Corbin, J., & Strauss, A. (1990). Grounded theory research: Procedures, canons and evaluative criteria. *Zeitschrift für Soziologie* 19(6), 418–427.
- Diekmann, A. (2004). *Empirische Sozialforschung. Grundlagen, Methoden, Anwendungen*. Reinbek: Rowohlt.
- Flick, U. (2000a). Design und Prozess qualitativer Forschung. In U. Flick, E. v. Kardorff, & I. Steinke (Eds.), *Qualitative Forschung. Ein Handbuch* (pp. 252–265). Reinbek: Rowohlt.



- Flick, U. (2000b). Qualitative Inquiries into social representations of health. *Journal of Health Psychology*, 5(3), 315–324.
- Flick, U. (2006). *An introduction to qualitative research*. London: Sage.
- Frommer, J. (1999). Qualitative research in diagnostic processes. *Psychopathology*, 32, 121–126.
- Frommer, J., Reissner, V., Tress, W., & Langenbach, M. (1996). Subjective theories of illness in patients with personality disorders: Qualitative comparison of twelve diagnostic interviews. *Psychotherapy Research*, 6(1), 56–69.
- Garfinkel, H. (1961). Aspects of common-sense knowledge of social structures. In *Transactions of the Fourth World Congress of Sociology. Milan and Stresa (1959)*, Vol. IV: *Sociology of Knowledge*. Louvain: International Sociological Association.
- Garfinkel, H. (1986). *Ethnomethodological studies of work*. London: Routledge.
- Garfinkel, H. (2007). *Studies in ethnomethodology*. Cambridge: Polity Press. (Original work published 1967)
- Garfinkel, H., & Sacks, H. (1970). On formal structures of practical action. In J. C. McKinney & E. A. Tiryakian (Eds.), *Theoretical sociology: Perspectives and developments* (pp. 338–366). New York: Appleton-Century-Crofts.
- Gerhardt, U. (2001). *Idealtypus. Zur methodischen Begründung der modernen Soziologie*. Frankfurt/M.: Suhrkamp.
- Glaser, B., & Strauss, A. (1967). *The discovery of grounded theory. Strategies for qualitative research*. New York: Aldine.
- Goffman, E. (1981). *Forms of talk*. Oxford: Blackwell.
- Gumperz, J. J. (1982a). *Discourse strategies. Studies in interactional sociolinguistics*. Cambridge: Cambridge University Press.
- Gumperz, J. J. (1982b). *Language and social identity*. Cambridge: Cambridge University Press.
- Gumperz, J. J., & Cook-Gumperz, J. (1981). Ethnic differences in communicative style. In C. A. Ferguson & S. H. Heath (Eds.), *Language in the USA* (pp. 430–445). Cambridge: Cambridge University Press.
- Günthner, S., & Knoblauch, H. A. (1997). Gattungsanalyse. In R. Hitzler & A. Honer (Eds.), *Sozialwissenschaftliche Hermeneutik* (pp. 281–308). Opladen: Leske+Budrich.
- Habermas, J. (1981). *Theorie des kommunikativen Handelns. Band 1. Handlungsrationalität und gesellschaftliche Rationalisierung*. Frankfurt a. M.: Suhrkamp.
- Hammersley, M. (1992). *What's wrong with ethnography? Methodological explorations*. London: Taylor & Francis.
- Helsper, W., Herwartz-Emden, L., & Terhart, E. (2001). Qualität qualitativer Forschung in der Erziehungswissenschaft. *Zeitschrift für Pädagogik*, 14, 251–269.
- Hitzler, R. (2003). Ethnographie. In R. Bohnsack, W. Marotzki, & M. I. Meuser (Eds.), *Hauptbegriffe Qualitativer Sozialforschung* (pp. 50–53). Opladen: Leske+Budrich.
- Kallmeyer, W., & Schütze, F. (1976). Konversationsanalyse. *Studium Linguistik I*, 1–28.
- Kelle, U., & Kluge, S. (1999). *Vom Einzelfall zum Typus*. Opladen: Leske+Budrich.
- Keppeler, A. (1994). *Tischgespräche. Über Formen kommunikativer Vergemeinschaftung am Beispiel der Konversation in Familien*. Frankfurt/M.: Suhrkamp.
- Kluge, S. (1999). *Empirisch begründete Typenbildung. Zur Konstruktion von Typen und Typologien in der qualitativen Sozialforschung*. Opladen: Leske+Budrich.
- Labov, W. (1964). Phonological correlates of social stratification. *American Anthropologist*, 66(6), 164–176.
- Labov, W. (1966). *The social stratification of English in New York city*. New York: Center for Applied Linguistics.
- Labov, W. (1968). The reflection of social processes in linguistic structures. In J. Fishman (Ed.), *Readings in the sociology of language*. Mouton: The Hague.
- Linde, C. (1993). *Life stories: The creation of coherence*. New York: Oxford University Press.
- Luckmann, T. (1986). Grundformen der gesellschaftlichen Vermittlung des Wissens: Kommunikative Gattungen. *Kölner Zeitschrift für Soziologie und Sozialpsychologie*, 27, 191–221.
- Luhmann, N. (1990). *Die Wissenschaft der Gesellschaft*. Frankfurt/M.: Suhrkamp.
- Luhmann, N. (2002). *Einführung in die Systemtheorie*. Heidelberg: Carl-Auer.

- Mannheim, K. (1952a). *Ideologie und Utopie*. Frankfurt a.M.: Schulte-Bulmke. (Original work published 1929)
- Mannheim, K. (1952b). Wissenssoziologie. In K. Mannheim (Ed.), *Ideologie und Utopie* (pp. 227–267). Frankfurt a.M.: Schulte-Bulmke. (Original work published 1931)
- Mannheim, K. (1964). *Wissenssoziologie*. Neuwied: Luchterhand (Original work published 1921–1928).
- Mannheim, K. (1980). *Strukturen des Denkens*. Frankfurt a. M.: Suhrkamp. (Original work published 1922–1925)
- Mannheim, K. (1982). *Structures of thinking*. London: Routledge. (Original work published 1922–1925)
- Mayring, P. (2000). *Qualitative Inhaltsanalyse*. Weinheim: Deutscher Studien Verlag.
- Merkens, H. (2000). Auswahlverfahren, Sampling, Fallkonstruktion. In U. Flick, E. v. Kardorff, & I. Steinke (Eds.), *Qualitative Forschung. Ein Handbuch* (pp. 286–299). Reinbek: Rowohlt.
- Mitchell, J. C. (1983). Case and situation analysis. *The Sociological Review*, 31(2), 187–211.
- Nentwig-Gesemann, I. (2001). Die Typenbildung der dokumentarischen Methode. In R. Bohnsack, I. Nentwig-Gesemann, & A. M. Nohl (Eds.), *Die dokumentarische Methode und ihre Forschungspraxis. Grundlagen qualitativer Sozialforschung* (pp. 275–300). Opladen: Leske+Budrich.
- Nohl, A.-M. (2001). *Migration und Differenzenerfahrung. Junge Einheimische und Migranten im rekonstruktiven Milieuvvergleich*. Opladen: Leske & Budrich.
- Oevermann, U. (1979). Sozialisationstheorie. Ansätze zu einer soziologischen Sozialisationstheorie und ihre Konsequenzen für die allgemeine soziologische Analyse. KZfSS, Sonderheft 21: Deutsche Soziologie seit 1945. *Entwicklungsrichtungen und Praxisbezug*, 143–168.
- Oevermann, U. (1991). Genetischer Strukturalismus und das sozialwissenschaftliche Problem der Erklärung der Entstehung des Neuen. In St. Müller-Doohm (Ed.), *Jenseits der Utopie. Theoriekritik der Gegenwart* (pp. 267–336). Frankfurt a. M.: Suhrkamp.
- Oevermann, U. (2000). Die Methode der Fallrekonstruktion in der Grundlagenforschung sowie in der klinischen und pädagogischen Praxis. In K. Kraimer (Ed.), *Die Fallrekonstruktion* (pp. 58–153). Frankfurt: Suhrkamp.
- Oevermann, U., Allert, T., Konau, E., & Krambeck, J. (1979). Die Methodologie einer „objektiven Hermeneutik“ und ihre allgemeine forschungslogische Bedeutung in den Sozialwissenschaften. In H.-G. Soeffner (Ed.), *Interpretative Verfahren in den Sozial- und Textwissenschaften* (pp. 352–433). Stuttgart: Metzler.
- Panofsky, E. (1939). *Studies in iconology: Humanistic themes in the art of the Renaissance*. New York: Oxford University Press.
- Panofsky, E. (1955). *Meaning in the visual arts*. Garden City, NY: Doubleday.
- Polanyi, M. (1966). *The tacit dimension*. New York: Doubleday.
- Popper, K. (1959/1935). *The logic of scientific discovery*. New York: Basic Books.
- Przyborski, A. (2004). *Gesprächsanalyse und dokumentarische Methode. Qualitative Auswertung von Gesprächen, Gruppendiskussionen und anderen Diskursen*. Wiesbaden: VS-Verlag.
- Przyborski, A. (in press). Biographische Muster in der Konfrontation mit medialen Kriegs- und Krisenberichten – Erste Ergebnisse einer rekonstruktiven Studie. In J. Grimm & P. Vitouch (Eds.), *Internationaler Kriegs- und Krisenjournalismus. Empirische Befunde – Politische Bewertungen – Handlungsperspektiven*. Wiesbaden: Verlag für Sozialwissenschaft.
- Przyborski, A., & Wohlrab-Sahr, M. (2008). *Qualitative Sozialforschung. Ein Arbeitsbuch*. München: Oldenbourg.
- Ruck, N., & Sluneccko, T. (2008). Portrait of a dialogical self: Image science and the dialogical self. *International Journal for Dialogical Science*, 3, 1.
- Sacks, H. (1995). *Lectures on conversation*. Oxford: Blackwell Publishing. (Original work published 1964–1972)
- Sacks, H., Schegloff, E., & Jefferson, G. (1974). A simplest systematics for the organization of turn-taking for conversations. *Language*, 50, 696–735.
- Schiffauer, W. (1983). *Die Gewalt der Ehre*. Frankfurt/M.: Suhrkamp.
- Schiffauer, W. (1987). *Die Bauern von Subay. Das Leben in einem türkischen Dorf*. Stuttgart: Klett-Cotta.

- Schiffauer, W. (1991). *Die Migranten aus Subay. Türken in Deutschland: Eine Ethnographie*. Stuttgart: Klett-Cotta.
- Schülein, J. A. (2002). *Autopoietische Realität und konnotative Theorie. Über Balanceprobleme sozialwissenschaftlichen Erkennens*. Weilerswist: Velbrück.
- Schütz, A. (1962). *Collected papers Vol. I. The problem of social reality*. The Hague: Martinus Nijhoff.
- Schütz, A. (1967). *The phenomenology of the social world*. Evanston, IL: Northwestern University Press. (Original work published 1932, *Der sinnhafte Aufbau der sozialen Welt. Eine Einleitung in die verstehende Soziologie*. Wien: Springer)
- Schütze, F. (1981). Prozessstrukturen des Lebensablaufs. In J. Matthes, A. Pfeifenberger, & M. Stosberg (Eds.), *Biographie in handlungswissenschaftlicher Perspektive* (pp. 67–156). Nürnberg: Verlag der Nürnberger Forschungsvereinigung e.V.
- Schütze, F. (1987). Das narrative Interview in Interaktionsfeldstudien: erzähltheoretische Grundlagen Teil I. Hagen: Studienbrief der Fernuniversität Hagen.
- Schütze, F., Meinefeld, W., Springer, W., & Weymann, A. (1973). Grundlagentheoretische Voraussetzungen methodisch kontrollierten Fremdverstehens. In Arbeitsgruppe Bielefelder Soziologen (Ed.), *Alltagswissen, Interaktion und gesellschaftliche Wirklichkeit. Bd. 2* (pp. 433–495). Reinbek: Rowohlt.
- Seale, C. (2000). *The quality of qualitative research*. London: Sage.
- Silverman, D. (2006). *Interpreting qualitative data: Methods for analyzing talk, text and interaction*. London: Sage.
- Slunecko, T. (2008). Von der Konstruktion zur dynamischen Konstitution. Beobachtungen auf der eigenen Spur. Wien: WUV.
- Slunecko, T., Fischer-Kern, M., Zimmerleiter, O., & Ponocny-Seliger, E. (2007). Initiale Therapiemotivation und institutionelles Schicksal von ambulanten Psychotherapiepatienten. *Journal für Psychologie, 15*, 3.
- Slunecko, T., & Hengl, S. (2006). Culture and media. A dynamic constitution. *Culture and Psychology, 12*(1), 69–85.
- Slunecko, T., & Hengl, S. (2007). Language, cognition, subjectivity—A dynamic constitution. In J. Valsiner & A. Rosa (Eds.), *The Cambridge handbook of social-cultural psychology* (pp. 40–61). Cambridge: Cambridge University Press.
- Soeffner, H.-G. (1989). Anmerkungen zu gemeinsamen Standards standardisierter und nicht-standardisierter Verfahren in der Sozialforschung. In H.-G. Soeffner (Ed.), *Auslegung des Alltags – Alltag der Auslegung. Zur wissenssoziologischen Konzeption einer sozialwissenschaftlichen Hermeneutik* (pp. 51–65). Frankfurt a. M.: Suhrkamp.
- Steinke, I. (2004). Quality criteria in qualitative research. In U. Flick, E. v. Kardorff, & I. Steinke (Eds.), *A companion to qualitative research* (pp. 184–190). London: Sage.
- Streeck, J. (1983). Konversationsanalyse. Ein Reparaturversuch. *Zeitschrift für Sprachwissenschaft, 2*, 72–104.
- Strübing, J. (2004). Grounded Theory. Zur sozialtheoretischen und epistemologischen Fundierung des Verfahrens der empirisch begründeten Theoriebildung. Wiesbaden: VS Verlag.
- ten Have, P. (2007). Ethnomethodology. In C. Seale, G. Gobo, J. F. Gubrium, & D. Silverman (Eds.), *Qualitative research practice* (pp. 139–152). London: Sage.
- Varela, F. J., Thompson, E., & Rosch, E. (1992). *The embodied mind. Cognitive science and human experience*. Cambridge, MA: MIT Press.
- Vitouch, P. (2007). *Fernsehen und Angstbewältigung. Zur Typologie des Zuschauerhaltens*. Wiesbaden: VS-Verlag.
- Weber, M. (1978/1914). *Economy and society. An outline of interpretive sociology*. Berkeley: University of California Press. (Original work published 1914)
- Welsch, W. (1988). *Wege aus der Moderne. Schlüsseltexte der Postmoderne-Diskussion*. Weinheim: VCH.
- Wohlrab-Sahr, M. (1994). Vom Fall zum Typus: Die Sehnsucht nach dem ‚Ganzen‘ und dem ‚Eigentlichen‘ – ‚Idealisierung‘ als biographische Konstruktion. In A. Diezinger et al. (Eds.), *Erfahrung mit Methode – Wege sozialwissenschaftlicher Frauenforschung* (pp. 269–299). Freiburg: Kore Edition.

## Chapter 8

# Grasping the Dynamic Nature of Intersubjectivity

Sergio Salvatore, Rosapia Lauro-Grotto, Alessandro Gennaro and Omar Gelo

The acknowledgement of the dynamicity of psychological phenomena has been progressively gaining acceptance in various branches of psychology. In some of these areas (first of all the neurosciences, psycholinguistic, but also cognitive psychology, and social psychology) the theory has greatly benefited from the adoption of conceptual models and methods of investigation provided by the Dynamic Systems theory (*inter alia*, Salvatore, Tebaldi, & Poti, 2008). However, in other fields of psychology, authors refer to the dynamic systems in metaphorical terms, using it as a striking image to describe the irreversibility and intrinsic creativity/autonomy of the psychological phenomena under investigation. As a result of this rhetorical strategy, in various areas related to the study of intersubjectivity (work psychology, clinical, and psychodynamic psychology as well as cultural psychology and at least partially developmental psychology) there is an evident gap between the conceptualisation of the phenomena as dynamic and the empirical investigation of it as a “static” process (Lauro-Grotto, Salvatore, Gennaro, & Gelo, 2009—Chapter 1 in this book).

In our opinion, a psychological methodology assuming a static vision of its object is not a problem in itself. The really critical issue is the incoherence between theory and methodology within the same scientific field. On the one hand, such inconsistency makes a mockery of theoretical construction and transforms it into a mere rhetorical game and, on the other hand, leads empirical investigation into the self-referential application of technical procedure.

The discussion that follows takes as its basic premise the understanding of psychological phenomena as dynamic processes. Readers can refer to the other chapter of this volume (Lauro-Grotto et al., 2009—Chapter 1) in order to find systematic conceptualisations of the characteristics (starting from irreversibility/dependence on time) that make psychological process dynamic, as well as of the different forms

---

S. Salvatore (✉)

Department of Educational, Psychological and Teaching Science

University of Salento

Lecce 73100, Italy

e-mail: sergio.salvatore@ateneo.unile.it

of dynamicity that have to be taken into account (non linearity, periodicity, chaos, self-organization).

The chapter is divided into two parts. The former is devoted to highlighting some general methodological cautions that one has to draw from the acknowledgement of the dynamic and non linear nature of the psychological process. In the second part we present some possible research strategies useful to take into account the dynamism of the psychological phenomena under investigation. The following discussion is confined to the methodological level. We will focus on the way of analyzing the psychological process, underlining some issues and presenting some technical devices to address them. However, we will not examine the epistemological implications entailed in such a methodological discussion in depth.

We are aware that modelling the psychological phenomena as a dynamic process is more than defining a toolbox (Toomela, 2009—Chapter 3 in this book) providing the means for achieving the aim of the investigation. Rather, it means making epistemological and theoretical claims that shape the content and the goal itself of the investigation—the definition of *what* one has to assume as the significant object of the analysis. Self-organization, bifurcation, dynamics of emergence, strange attractors, and the like are not only criteria according to which the researcher defines his methodology and procedures of analysis; they also entail more basic statements on what the phenomenon—and therefore the goal of the scientific enterprise—is.

Nevertheless, it has to be taken into account that epistemological statements can be brought into the practices of empirical investigation insofar as research has criteria, devices and procedures available for this aim. Therefore, one has to recognize the circularity between the epistemological and methodological levels of the discourse on the dynamicity of psychological processes. On the one hand the assertion of the dynamicity of psychological processes is an epistemological super-ordered assumption grounding and guiding the methodology. On the other hand, however, the methodology must develop if epistemological discourse is to become a useful, feasible and efficacious reflection on the status of scientific knowledge.

In view of this premise, in this work we have tried to carry on the methodological discussion without asking the reader to share forced epistemological assumptions on psychological processes. In doing so we wish to contribute to the development of a method capable of contributing to epistemological reflection.

## Cautions

### *The Questionable Assumption of the Independence of the Observations*

In many longitudinal studies researchers use procedures of data analysis (ANOVA, parametric correlations—e.g. Raudenbusch & Bryk, 2002; Schaie et al., 2005) entailing the assumption of independence of the observations. In some other cases, the

data are adjusted by means of the transformation in z-point or the like (i.e., effect score, percentiles), procedures that still entail the reference to a normal distribution (e.g., Mergenthaler, 1996). Nevertheless, the sequence of values of a dynamic process unfolding through time is by definition dependent on the time. This means that the sequential observations of a temporal trajectory can hardly be considered as belonging to a single distribution of a single population of observations.

Here the point at stake is not the fitness of the data to the assumption of the normality of distribution. The issue is indeed more radical, and it concerns the notion of distribution. Let us briefly examine this issue. The statistical concept of distribution by definition means that the distributed observations are equivalent, which means that they are considered to belong to or be extracted from a single population. It is only on this condition that variability between observations can be considered the effect of random fluctuation and consequently any high difference between observations with a low probability of occurring can be assumed as being due to the intervention of a cause rather than being an expression of chance (Maruyama, 1999)<sup>1</sup>.

Yet, in the case of a dynamic process, by definition any subsequent observation is the product of the previous history of the system—this is equivalent to saying that the process is time-dependent. Consequently, every observation has, as its own object, an event that is produced according to conditions—the previous chains of events—that are very specific—which is a different way of saying that dynamic phenomena concern the irreversibility of time. In other words, in the case of a dynamic system, event *a* depicted by the observation  $x_a$  in time  $t_a$  works as the immediate environment of the following event ( $b, x_b, t_b$ ) that in its turn works as the immediate environment for the following event ( $c, x_c, t_c$ ). Now, affirming the dependence on time means that the three events in the case of a dynamic system are by definition different. Therefore, in the case of a dynamic system every event is the product of a different immediate environment, “incorporating” the previous history of the system. That is to say that in the case of a dynamic system events are not equivalent, each of them being the population of itself.

### *Uselessness of the Pre/Post Difference*

When dealing with a dynamic process, the mere analysis of the post-pre difference is quite useless. In fact this pattern is meaningful only when the evolution of the dimension under investigation is assumed to be linear and constant. Therefore

---

<sup>1</sup> The assumption of the singleness of the population is more than an implicit assumption grounding the inferential statistic: it is an explicit central concept of it, directly expressed by the null hypothesis that the study has to decide whether or not to accept. In fact, the null hypothesis statement that the two (sets of) observations compared are equivalent corresponds to the claim that they belong to the same population—since their difference is due to the casual variability within the population. On the other hand, the alternative hypothesis statement of a significant difference between the observations compared corresponds to the claim that they belong to different populations—that is the population not affected by the effect of the independent variable and the population affected by it.

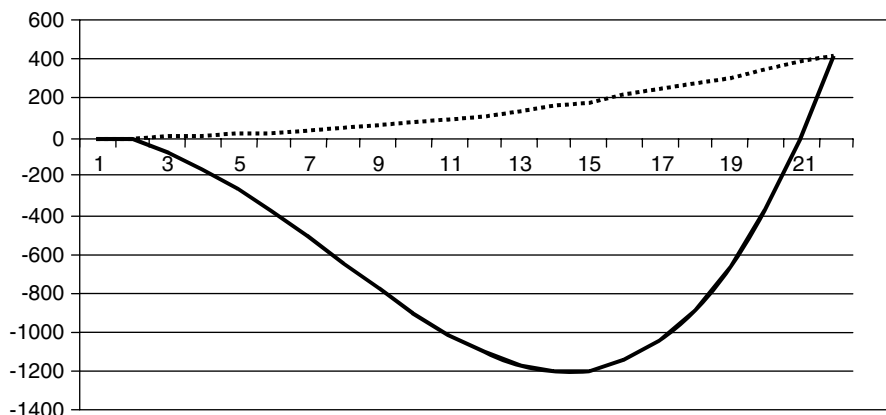

**Fig. 8.1** Very different trends with identical pre/post differences

the post-pre difference is unsuitable for studying dynamic processes (Laurenceau, Hayes, & Feldman, 2007).

Figure 8.1 shows how two very different trends can have the same post-pre difference. Consequently, focusing on the difference means losing the most interesting aspects of the phenomenon. At the same time, one can easily imagine processes having very similar shapes, yet presenting very different post-pre difference. More in general, conditions like quasi-periodical trends, dissipative trajectories, sensitive dependence on the initial conditions, phenomena of order emergence (see Lauro-Grotto et al., 2009), and the like, clearly make the pre/post difference a very misleading device.

### ***Weakness of the Assumption of the Invariance of the Process***

In most cases, the analyses assume that the phenomenon under investigation always follows the same way of working throughout the temporal window of the study. According to this assumption, the researchers strive to identify the law depicting the functioning of the phenomenon. This is what we mean with the invariance of the process.

That assumption is acceptable insofar as one has to deal with stationary dynamics (i.e., periodic trends). However, if the process under investigation shows a non stationary trajectory—because of the presence of phase transitions and/or the emergence of patterns of self-organization—the assumption of invariance becomes highly confusing. For example, let us consider a psychotherapy process in which the researcher wants to study the relationship between the patient’s symptomatology and the patient’s commitment to clinical work.

From a clinical point of view this relationship may actually change, moving from the first phase of the therapy to the second. In fact, in the first phase symptomatology

and commitment can be proportional to each other (see Mahoney, 1991): the more the symptoms, the more the patient hopes the therapy will bring an improvement and the greater the potentiality for improvement (Lambert, 2004) therefore the greater the commitment. In a complementary way, the greater the commitment, the more willing the patient will be to deal with his/her problems, therefore the more conflict she/he is willing to tolerate, and the more the symptoms are mobilised. In a subsequent phase, the relationship may be dramatically reversed: the more the symptoms, the less the patient hopes for improvement, therefore the less the commitment. At the same time, the less the commitment, the less the therapeutic work can support the patient deal with her/his consolidated strategy of adjustment, therefore the greater the defensive recourse to the symptomatology. In a case like this, if one does not consider the first and the second phases separately, what may happen is that no relationship is found between commitment and symptomatology.

A subcategory of the issue at stake is the assumption that the variables are symmetrical. Researchers generally assume that the incidence of a given variable is invariant (in absolute terms) regardless of its direction. Referring to the previous example, the assumption of symmetry leads one to think that an increase in symptomatology produces the same kind of consequences on commitment—even if in inverse terms—than a decrease. Yet this assumption is often clearly an oversimplification. In fact, the increasing level/presence and the decreasing level/absence of a certain dimension can be two different phenomena rather than two states of the same linear variable. For instance, organizational psychology highlights that there is not a single relationship between the so called “hygienic factors” (work load, safety conditions, quality of air, and lighting....) and motivation on the job: the absence or the low level of these factors is associated with low motivation, yet the presence or the high level of these factors is not associated with high motivation (Herzberg, Mausner, & Snyderman, 1959).

### ***Eventual Paradoxicality of Treating Variables Singly***

Psychological research usually regards each variable as being significant in itself, therefore usable as a basic unit of calculation. For example, in the study of the therapeutic alliance, the researcher measures the values of some parameters of the alliance between the therapist and the patient alongside the course of the treatment, assuming that such values are significant in themselves. According to this assumption, one can compare and/or use each of them and their (linear) combination in order to regress on a dependent variable (i.e., an outcome variable). Yet, in a dynamic process, especially when a self-organizational mechanism is involved, one can easily expect that it is not the single variables that are significant, but any local combination of their values.

Toomela (2008) shows some paradoxes in which statistical analysis fails when it does not take into account the local interaction among variables. For example, it refers to the relationship between the levels of activation of the two hemispheres



(say: independent variables A and B) and depression (dependent variable C). Taken singly, neither A nor B correlates with C. On the contrary, the absolute value of the difference between the two levels of activation (i.e., the variable  $[A-B]$ ) is a very powerful predictor of the depressive state, being very highly associated with C. This is because what seems to have relevance in eliciting a depressive affective state is the asymmetry between the two hemispheres. This example is quite instructive because it helps us to understand how the possible forms of combinations among the variables are quite a lot wider than the linear combination performed by the traditional statistical procedures.

## Strategies

The strategies of empirical investigation we present here are just some of those one could possibly adopt. On the other hand, the aim of our work is to highlight the need to develop the use of the dynamic system theory in psychology, rather than to propose specific technical guidelines for empirical research. For this reason, the reader has to consider the following methodological indications as having essentially an exemplificative value aimed at making the theoretical statements proposed above clearer as well as at highlighting the feasibility in translated them into operative procedures of investigation.

### *Analysing Non-Independent Data*

In a previous session we have underlined the issue of the non-independence of the observation, as being the norm rather than the exception in the case of within-subject data, depicting temporal trajectories. A way of dealing with this kind of data set is provided by procedures based on bootstrapping methodology—which one can compare to Monte Carlo analysis. The rationale of this approach is well illustrated by a recent paper (Borckardt et al., 2008) dealing with the issue of the way of measuring individual psychotherapeutic change.

Our starting point is the emphasis on the non-independence of the data retrieved from the same subject through time. This recognition is obvious from a clinical (and also from a naïve) point of view. Let us imagine a patient whose level on a clinically significant index is measured  $n$  times in the course of the psychotherapy, say, the level of severity of symptomatology at the end of every session through the course of a 30-session psychotherapy treatment. Now, let us imagine that at the end of a certain session  $x$  the patient feels very depressed and anxious. It is evident that this state will tend somehow to persist, therefore to affect the further trajectory. And if the level of severity at the time  $x$  affects the level of the severity at time  $x+1$  (and even decreasingly also at the level  $x+2$ ,  $x+3$ ...), this means that the observations are associated to each other. In the final analysis, non-independence

is involved when the knowledge of the state of the variable at time  $x+1$  makes the probability of foreseeing the state of the variable at the following temporal moment different from zero. In statistical terms this phenomenon is defined in terms of autocorrelation: a variable correlated with itself (i.e., with its state at a given temporal lag).

Conventional parametric and nonparametric statistics assume that observations are independent. For instance, the result of a coin toss on Trial 1 does not influence the result on Trials 2 and 3, and so on. No matter how many times in a row “tails” is obtained, the probability that the next toss will be “heads” is unimpeachably still 50%. Hence, each observation (i.e., result of a coin toss) is independent. Similarly, in group designs, Subject 1’s height is independent of Subject 2’s height. Whether coin toss or height, one observation does not influence another. However, singlecase time-series observations, (...), are in principle not independent. (...). These data are in fact autocorrelated.

Simply put, a series of observations (...) is said to be autocorrelated if the value of one observation depends (at least in part) on the value of one or more of the immediately preceding observations. Later observations are explained by earlier ones. Weather is autocorrelated. What the noon temperature will be on Wednesday is predicted by what the noon temperature was on Tuesday, and to a lesser extent what the noon temperature was on Monday or Sunday. Although the weather is certainly variable, how it changes from hour to hour, day to day, and season to season is to a degree lawful and structured, in a way that is *not* true when moving from one coin toss to the next. (...).

Indeed, autocorrelation is an inevitable aspect of the periodicity, trending, and gradualism that one encounters regularly when tracking change over time in a single individual (weight loss, heart rate, tissue, or psychological repair) or system (corporate earnings, birth rate). (Borckardt et al., 2008, p. 82)

As Borckardt and colleagues underline, autocorrelation is the norm rather than the exception in clinical research (and we can add, in psychological research dealing with dynamic trajectories). Moreover, the authors highlight that calculating the difference of the scores and/or monitoring the slope of the index through time, without taking into account the autocorrelation of the values leads to overestimating the effect size (i.e., the difference through time). And this happens whether the autocorrelation is significant or not. For instance, a calculated autocorrelation of 0.10 can inflate the statistical values of the effect size by more than 100%. Affection gets 200% when autocorrelation is at 0.6.

In accordance with these considerations, Borckardt et al. (2008) present a procedure of analysis SMA (Simulation Model Analysis) which, unlike the conventional statistical tools, is able to take into account the autocorrelational effect. Here we do not provide details about the procedure. Rather we expose the general logic informing other similar strategies of analysis. To put it simply, the procedure entails the following rationale.

Firstly, a huge number of casual data sets are randomly generated, with some parameter of the real data set assumed as constraints. For instance—the authors use as example a data set obtained by measuring the blood pressure 28 times—14 before the treatment (as baseline) and 14 during the treatment. This data set is defined according to four parameters: the number of observations comprised in each phase as well as the rates of autocorrelation for each phase. Then they randomly produced 1.000 virtual data sets, all of them sharing these four parameters.

Secondly, for each virtual data set the statistical indicator depicting the relevant information is calculated. In the case used by the authors as an example, they calculate the effect size of the treatment in terms of the correlation between the clinical indicator (blood pressure) and the phase of the treatment. It is worth noticing that because of the random generation of the population of data sets, the distribution of the chosen statistical indicator is null. In other words, for each of the 1.000 data sets the effect size of the treatment is calculated. And the mean of the 1.000 effect size is 0.

Thirdly, the latter operation allows the statistical meaning of the real value of the statistical indicator (i.e., in the example the effect size) to be calculated in terms of the probability associated to it in the distribution of virtual data sets.

In sum, these kinds of methods adopt the strategies of randomly generating a population of virtual data sets comparable with the real data set and then calculate the probability that from such a random distribution one can extract a data set showing an effect equivalent or higher than the real data set's. Obviously, if this probability is lower than the  $\alpha$  value, then the effect can be considered statistically significant.

## **Modelling**

The Dynamic System theory (DS) leads a central meaning to be attributed to the description of the temporal trajectory characterising the processes. This means that in studying a phenomenon, the shape of the process is relevant, rather/more than the measure/comparison of specific states in given instants.

This is evident in some phenomena where the relevant aspect is not the mere variability of the values through time, but the structure of the trend involved, as one can grasp by considering the process as a whole. One could speak in this case of *meta-trend*. An example of this kind of phenomena, conceptually consistent with the psychodynamic model, is the trend one can expect to characterise insight. As a matter of fact, in a psychoanalytically oriented therapy insight does not have a constant linear development. This is because as the theory conceptualises the construct, insight is a sudden recombination of meaning and creation of new connections among the cognitive and affective elements of the mental scenario (it being individual or intersubjective depending on the theoretical preference of the authors) (Langs, 1974; Hoffman, 1998). This means that insight makes an incursion only seldom, as a discrete and circumscribed moment of rupture of the normal process of sensemaking. This does not necessarily mean that the strength of insight—that is, its power to recombine and create semiotic novelty—is constant. On the contrary, one is justified in thinking that during a clinically efficacious psychotherapy treatment, the strength of insight increases. This is what various studies on the psychotherapy process show (Gennaro, Salvatore, Lis, & Salcuni, 2008; Salvatore, Gelo, Gennaro, Manzo & Al Radaideh, *in press*).

In Fig. 8.2 the trend of Activity during a 124-session psychotherapy treatment is plotted. Activity is one of the parameters of the DFA (Discursive Flow Analysis). DFA is a method describing the psychotherapy process in terms of the structure and the dynamics of the discursive exchange between patient and therapist (Salvatore et al., *in press*). In the first approximation, Activity can be seen as a marker of insight. It depicts the semiopoietic power of the discourse, that is the capability of increasing its meaning variability through time. It is calculated as the ratio between the role in the dialog of two types of meaning: *generative meaning*—meaning that is followed by a wide range of other meanings in the flow of communication—and *absorbing meaning*—whose occurrence in the flow of communication narrows the semiotic variability of the subsequent dialog.

Figure 8.2 shows how Activity proceeds by fits and starts, with sharp peaks coming out of an almost flat basic trend. What is interesting to note here is that the level of the Activity's peaks follows a rather clear reversed U-shaped trend. It increases almost constantly throughout the first two out of three parts of the psychotherapy, to then decrease in the third (last) phase. This is quite consistent with the model of insight we have referred to before. According to this model, the psychotherapy discussed here seems to have led to increasing “bursts” of insight. This has happened in at least two out of three parts of its progress. The beginning of the downward phase would introduce the conclusive phase of the clinical work. However, regardless of the interpretation one gives to the figure, here it is worth noticing that what is meaningful is not (only) the first order trend, that of Activity, but the second order trend—the meta-trend, to use the terms above proposed), concerning the temporal trajectory of the intensity of the peaks.

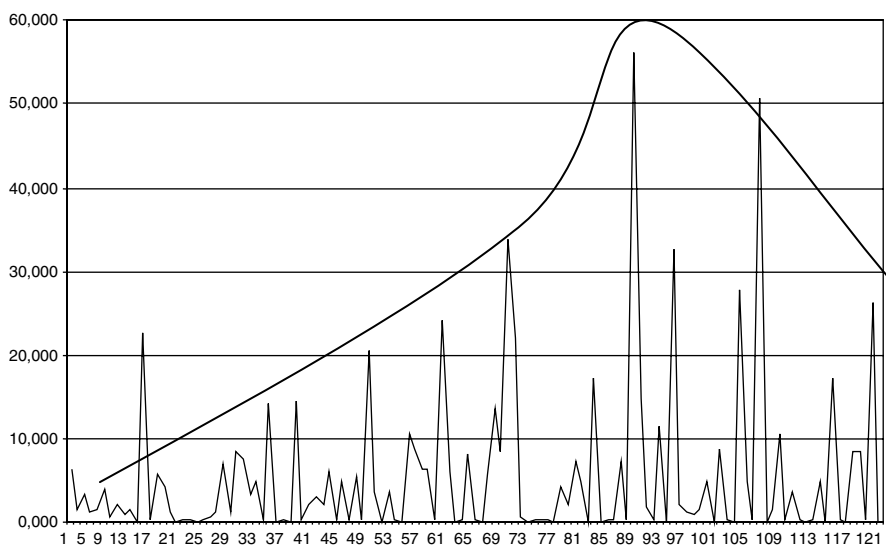

**Fig. 8.2** The meta-trend in the semiopoietic power (Activity) of the clinical exchange

## *Trajectory in the Phase Space*

The dynamics of a system can be depicted in terms of its trajectory in the phase space (Lauro-Grotto et al., 2009). In this way, the focus is on the shape of the trajectory and its behaviour though time rather than on the study of individual points. However, only in a minority of cases can the trajectories be described in an analytic way. More often the dynamic is too complicated to be analytically studied by means of a formal representation. In this case a qualitative inspection is performed, aimed at identifying the genre of dynamic phenomenon (i.e., the presence and the nature of peaks and attractors, types of trends...) characterising the trajectory.

This qualitative approach is consistent with the psychodynamic attitude. In fact, in many cases the interest of a psychodynamic observer is not the amount of the state of a given variable or of the relationship among variables (which can be contingent to the context), but the way the phenomenon as a whole develops. One can find an example of this attitude by referring to Barkham, Stiles, and Shapiro (1993). In this study, the authors do not deal with the measurement of their main variables—in this case: the relevance of the clinical problems brought into psychotherapy. Rather, they focus on the modelling of the trajectory shaping the trend of the variable under investigation through the psychotherapy process. It is worth noticing that they test the fitness of a specific model formally defined by means of a second order equation. In this way they are able to test the hypothesis of the U-shaped trend in the psychotherapy process.

Similarly, Salvatore et al. (in press) conceptualise the psychotherapy process according to their Two Stage Semiotic Model (TSSM) (see Lauro-Grotto et al., 2009), asserting, among other statements, the U-shaped trend of the super-order meanings active in clinically efficacious psychotherapy. Like Barkham, Stiles, and Shapiro (1993), their attention is not on the absolute value of the variables, but on the global shape of the trajectory depicting the course of psychotherapy.

In order to subject the U-shapes hypothesis to empirical scrutiny, the authors analyse a 15-session good outcome psychotherapy treatment. For each session an index of the super-order meaning (Super-order Knots) was calculated, using the method adopted in psychotherapy process analysis (DFA, see previous paragraph; Salvatore et al., in press). Then the authors estimated the probability that the observed trend fits a quadratic curve over the sessions. To this end they calculated the fitted curve's confidence interval, in order to see if the average absolute value of the residuals lay within it. Because the mean of the absolute residual value was lower than the confidence interval (at 95%), the authors were able to conclude that the Super-ordered-Knots trend presents a course close to a U shape at a significant level between lower than  $\alpha = 5\%$  (cf. Fig. 8.3). In sum, they tested the similarity of the observed curve with the theoretical one (a quadratic curve mapping a U trend) by verifying if the average differences among the observed and the theoretical values were lower than a given threshold (confidence interval) corresponding to a certain probability (95%).

It is to be underlined that the interest in the global form of the trend is not a second choice due to the difficulty of a more analytic investigation. Rather, it concerns and

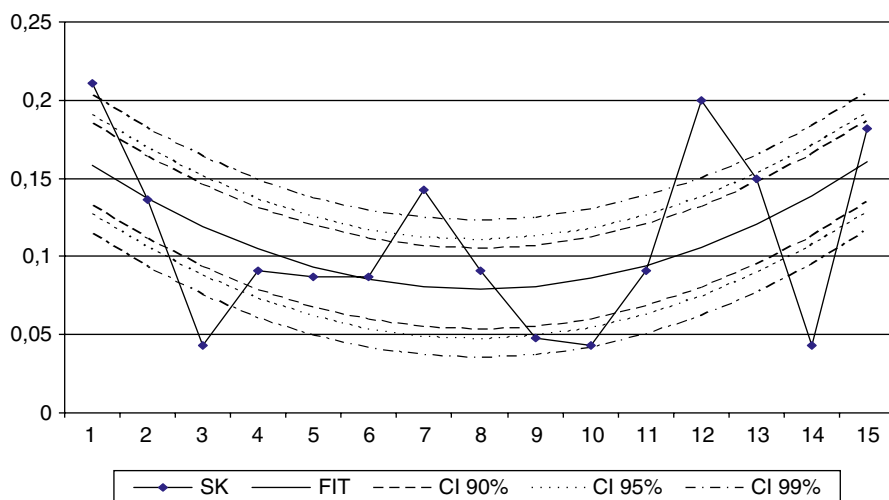

**Fig. 8.3** Quadratic fitted curve of Super-order Knots (SK) with confidence interval

is aimed at developing the clinical theory of psychotherapy. In the case in question, the U-shapes trend of the super-order meanings exchanged within the therapist-patient communication has important theoretical implications. In particular: (a) it means underlining the role played by this kind of semiotic device in psychotherapy; (b) it helps to go beyond a technical and a-contextual approach to the clinic practice, grounded on the assumption that a given kind of intervention—for example, psychoanalytic interpretation—is always useful and always in the same way, always having the same effects. On the contrary, the alternation of deconstructive and constructive phases in the psychotherapy process means that cogent clinic interventions can vary according to the history of the process: such interventions can also have different effects, whose clinical significance depends on the time too. From a more general point of view, it is evident that focusing on the shape of the trajectory decisively helps to collect the knowledge produced by intensive studies of single cases, thus reflecting the idea of an idiographic science as a process of accumulation of knowledge while at the same time being the product of the systematic empirical investigation of single, unique phenomena (Molenaar & Valsiner, 2005; Valsiner, Salvatore, Strout, & Clegg, 2009).

Before concluding, it is worth noticing that in the past year some statistical devices consistent with the aim of modelling the processes have been developed. In particular, the Growth Mixture Model (Laurenceau et al., 2007; see also Krause, Howard, & Lutz, 1998) is aimed at formalising the temporal evolution of single cases, in order to use the identified parameter of the formalisation as the criteria for comparing the cases to one another. Thus, the interest of this statistical technique lies in its aim of integrating the within-subject and between-subject levels of analysis, without confusing them. However, while on the one hand this type of data analysis procedure is able to take time into account, on the other hand it maintains the general assumption of linearity, typical of traditional data analysis models. In

other words, this technique takes the dynamicity of the phenomena into account, but it cannot fit with the class of non linear processes characterised by phenomena of dissipative dynamics and/or emergence of order (Laurenceau et al., 2007; Lauro-Grotto et al., 2009). The use of a dynamic model based on systems of differential equations and the study of the dimensionality of the phase space represent a welcome developmental “leap forward” for clinical and more in general psychological research.

### *The Constructive Role of Time*

Dynamic phenomena are time dependent (Lauro-Grotto et al., 2009). According to the DS, this characteristic informs the way of depicting and formalising the processes. Yet time dependence has some methodological implications that go further than formalisation. Here we point out two aspects.

*Time as a factor of production of sensemaking.* First of all, time has a constructive role in psychological phenomena. Think of the psychoanalytic principle of free association. This hermeneutic principle is grounded on the tenet that the associative chain created by the temporal contiguity among signs is a major vector carrying a specific unconscious affective meaning, (Salvatore & Venuleo, 2009). On the other hand, the tenet that the association between signs linked by temporal contiguity is in turn a sign of a more global pattern of sensemaking is not confined in the field of psychoanalytic theory. As a matter of fact, it is based on the Semantic Differential (Osgood, Suci, & Tannenbaum, 1957) that interprets the patterns of association between the connotations of different objects on various bi-polarized scales as indicative of the salience of latent dimensions of affective meaning. More in general, the acknowledgement of the pragmatic level of sensemaking leads to the conclusion that the meaning of a system of signs depends not only on their content, but also on the temporal sequence in which the signs are placed. In other words, the sequential combination of the signs a, b, c does not have necessarily the same meaning as the sequential combination b, a, c (Salvatore et al., *in press*). All these considerations lead to seeing the temporal organization of discursive practices as something more than an epiphenomenon. Time, rather than being the mere container in which the sensemaking unfolds, is a fundamental device used by sensemaking to shape the semiotic environment. Time is a “factor of production” of sensemaking.

The constitutive role of time can be explored and depicted by means of procedures of sequential analysis (Bakeman & Gottman, 1997; for application of sequential analysis to textual analysis, see Lancia, 2010). The DFA—the method of analysis of the psychotherapy process mentioned above (Salvatore et al., *in press*)—is based on a Markovian procedure of sequential analysis. The procedure is applied to the sequence of themes produced by the thematic coding of a verbatim transcript of the psychotherapy dialogue (i.e., each sentence is coded in terms of its thematic content). The probability that every theme present in the discourse follows all the

themes (including itself) is computed. The matrix of the probabilities so defined enables the discourse to be described in terms of a dynamic network, where the knots represent the themes/meanings active in the communication, and the line between two knots represents the association of temporal contiguity between the two themes/meanings corresponding to the two knots. The qualitative and quantitative study of the network's structure and dynamics gives information on the sense-making produced by the discourse. The structural analysis concerns the number of knots, the density of the active connections among knots, the distribution of the connections among them. As far as the dynamic analysis is concerned, one has to take into account that each knot has connections on entry—by which it is activated—and on exit—with the knots that it activates. The dynamic analysis concerns the ratio between exit/entry connections. It allows the capability of the discourse to produce semiotic variability through the time to be identified. In this way, it is possible to observe that some knots work as attractors, that is they work as the meaning to which many other meanings arrive. Instead, some other meanings work as generative signs, because they are able to activate—that is have contiguity links on exit with—many other meanings.

For instance, one could find that in the first part of a course of psychotherapy the meaning “I am impotent” is an attractor, because many other meanings activate it. In this case, therefore, regardless from where the discourse starts, it often ends up connoting the patient as impotent. In the final part of the psychotherapy, one could find the meaning “my desire/plans” as a generative knot. This would mean that such a theme is able to work as a source of sensemaking, activating many other meanings. In this way one can interpret it as a marker of a developed sense of agency. In sum, the application of the sequential analysis to the discourse can allow to deeper understand of how sensemaking shapes the discourse and how the semiotic organization develops through time.

*Relative versus absolute states of the variable.* Another way time shows its constitutive function concerns the role played by the level of a variable at a given moment in determining the meaning of the value of the variable in the following instant. In other words, the point at stake here is the fact that in some cases what one can expect to find relevant is the deviation (in terms of ratio of change or of difference) between the level observed and the level associated to the previous observation—rather than (or in addition to) the level in itself.

These cases represent systems that are very flexible and plastic in their ability to stabilise themselves, and that are therefore oriented to quickly assume their present state as a reference point. For example, generally when one drives car one quickly adjusts one's sense of speed. In these cases what is subjectively relevant is not the speed in itself, but the deviation from the cruise rate. (Incidentally, this statement is another reason for pointing out the unsuitableness of assuming that variables are independent).

Gennaro et al. (2008) report the application of the DFA method to the analysis of a single case of psychotherapy. This study takes into account the issue of the possible meaningfulness of the deviation between contiguous observations. One of the analyses reported in the study concerned the convergent validity of the DFA,



studied in terms of the capability of the DFA indexes to discriminate between clinically significant and non significant sessions of psychotherapy (as defined by an external criterion, based on the Therapeutic cycle model, Mergenthaler, 1996; for a brief description of the method see Lauro-Grotto et al., 2009). Authors inserted each index in two formats of calculation: both as absolute values, and as the difference compared to the previous session (they call the latter format: Mobile Difference with period = 1; henceforth: MD1). Interestingly, the DFA's indexes proved able to discriminate between the two *subsets* of sessions (clinically significant versus clinically non significant) with a 100% success rate, but only if both the formats of calculation were taken into account.

Similar results were also found in a preliminary study (Salvatore et al., 2006). In that study the authors found that by using the MD1 parameter, two of the main DFA indexes (Connectivity and Activity) were jointly able to identify most of the sessions identified by TCM as clinically relevant.

### ***Focus on the Structure***

We dealt with this issue, from the negative point of view, when we underlined the limitation of considering the variables singly. Here we look further into this aspect, from a constructive point of view. In general terms, the issue of the relevance of a structural approach is at stake. Here we use “structural” to denote a strategy of analysis focusing on the (synchronic) pattern of relationship between—and within—the variables.

The assertions made above based on Toomela's (2008) considerations are an example of the acknowledgement of the relevance of the synchronic relationship between the main dimensions of a phenomenon. Generally speaking, one could refer to a large number of examples in order to highlight how, in the case of psychological phenomena, the meaning of a value is contingent to the values of other linked variables. This is very clear in textual analysis.

Despite of the researchers' habit of considering the frequencies of the lexical variables meaningful in themselves, it should be obvious that according to the indexicality of the language (Nightingale & Cromby, 1999), the significance of using certain words does not come from the mere frequency of their occurrence. Rather it depends on how they are associated with certain other words (Lancia, 2010). In other words, what is significant is not the collection of the most (or least) frequent words in the text, but the pattern of association among them occurring within the text.

### ***Examples of Structural Approaches in Textual Analysis***

The latter statement makes explicit the assumption on which Venuleo and Salvatore (2006) ground their analysis of the debates among the Italian politicians broadcast

by the Italian public TV network during the 2006 general election. The study is based on the transcripts of the electoral debate subjected to a computer aided analysis supported by the software T-Lab, (T\_LAB; see Lancia, 2002). More specifically, it focuses on the co-occurrence of words within the same utterances. The matrix utterance x word has been subjected to a Lexical Multiple Correspondence Analysis and a Cluster Analysis. In this way: (a) the two most pregnant latent dimensions of sense organising the discursive exchange have been extracted; (b) five different aggregations of words—each of them depicting a symbolic/thematic area of the discourse have been identified.

The most important issue that the psychodynamic interpretation of these findings highlighted was the following. Most incidence of the latent dimension of sense concern the oppositional representation of the *here* of the pragmatic regulation of the communicative exchange (utterances concerning the time available for speaking and/or the regulation of turn-taking) versus the *there* of the reference of the political program (the goals and the method proposed by the different political parties, as well the social, economic and institutional problems to be dealt with). As the authors point out, this result is a clear and understandable consequence of the political climate in which the elections were carried out, characterised by great concern for the respect for equal opportunities among the political competitors. Yet the study has shown how the strong salience of these concerns shaped the symbolic field of the political discourse making the issue of the regulation of communication among the speakers absolutely central and leaving the contents and the plans the speakers were talking about, in the background. As a result of this phenomenon, the various speakers were unable to semiotically differentiate each other as far as the political projects of their political platform were concerned—which should be, in the final analysis, the aim of the TV debate.

Another example of structural approach to the text is provided by Semerari et al. (2003). They analyse a psychotherapy process by means of a thematic grid they have elaborated (Problematic State Grid). They do not confine themselves to computing the occurrence of the themes in terms of their frequencies. Rather, they cluster the themes in a way that allows to recognise how in different moments of the psychotherapy there are different salient patterns of associations among themes (i.e., the first part of the therapy is characterised by the salience of the association among the themes A, B, D, while the association among the themes A, B, F is typical of the second part of the therapy). It is worth noticing that in their interpretation the meaning of the patterns is not given by the additive sum of the theme in association, but by the interactive sense produced by their combinations.

Another way of depicting the synchronic linkages shaping clinic processes is that used by Grassi (2008). His study aims at interpreting the narrative dynamics shaping the course of a case of psychotherapy. He coded the verbatim transcript of the psychotherapy according to different levels of analysis: content analysis of the themes, syntactic forms, cognitive operations entailed in the verbal activity, speaker's position on the statement made (e.g., dubitative, assertive...). The central hypothesis of the study is that the sensemaking that psychotherapy consists of

comes from (and therefore is expressed by) the creation of specific configurations within and between the levels of meaning (lexical, semantic, syntactic).

In order to depict such configurations, the author coded the segments of text corresponding to the utterance of the patient for each of the variables taken into account (i.e., theme, syntactic forms, lexical markers, positioning markers) and then subjected the matrix obtained to cluster analysis (preceded by a Multiple correspondence analysis, aimed at transforming the nominal data into continuous variables). He performed three analyses, one for each of three temporal segments of the psychotherapy (i.e., initial phase, middle phase, and final phase). In so doing, he was able to find that the patterns of association among the indexes used change across the phases, in a clinically meaningful way. For instance, in the first part of the therapy the patient tends to produce *self-description* (theme) in association with *explanation of her inner state* (cognitive operation). This pattern can be interpreted as a marker of auto-referential attitude. In the last part of the psychotherapy a pattern of agency appears, characterised by the connection between *self-description* and *strategic plans of action*.

As one can see, this analysis shows that the mere occurrence of the theme of self-description is not significant in itself, because its clinical value depends on the other elements that are associated with it: being associated with *explanation of her inner state* makes the case different from being associated with *strategic plans of action*.

### ***Depicting the Dynamics of Emergence***

The methodological discussion presented so far concerns some ways of taking into account the dynamicity and non linearity of psychological phenomena. Yet such ways are not sufficiently suitable for treating the subset of dynamic processes characterised by self-organization and emergence of order.

Some indications about how to deal with this kind of phenomena are proposed by Tschacher, Schiepek, and Brummer (1992), in their application of the synergetic to clinical psychology. Here we will simply recall some further general issues. Firstly, one has to distinguish the theoretical definition of self-organization and the defining criteria according to which one can speak of self-organization and emergence on the operational level. A theoretical definition of self-organization can be found in Lauro-Grotto et al. (2009). Here we wish to focus on the operational definition. In our opinion, one can speak of self-organization insofar as emergence of order is involved. Therefore the methodological issue is to have an operational definition of emergence of order. For this purpose, we will give the following definition, based on three criteria: emergence is:

- A) a decided change in the state of the system consisting of a significant reduction in the variability of the system,
- B) occurring suddenly, and
- C) carried out in a limited period of time.

According to the tenet of the self-organizational nature of the psychotherapy process, the authors have hypothesised that one will find that some strong relationship between important aspects of the process has to be established in the course of the psychotherapy. Moreover, to be seen as a phenomenon of emergence, such a change has to be: (a) sudden, (b) rapid, and (c) lasting (not to vanish after a short while).

In order to deal with this hypothesis the authors analysed the relationship between two of the major DFA indexes (Activity and Super-order meanings) over time. This is because they assumed that these two parameters depict two very different aspects of the discursive exchange: the former is an index concerning the dynamics of the discursive network; the latter an index concerning the structure and the content of the network.

In order to analyse the relationship between the two parameters they applied an adapted version of the univariate method of trend analysis proposed by Molenaar and Valsiner (2005). They defined a set of 5-session blocks—having as starting session =  $n$  and ending session =  $n+4$ —obtained by varying stepwise the cut-off point  $n$  between  $n = 1$  and  $n = 11$ . (They chose a 5-session range in order to obtain the highest number of blocks to be compared, yet without compromising the calculation of the correlations within each block). The coefficients of correlation between activity and Super order meaning obtained for each window were compared.

As Fig. 8.4 shows, after the first window, the correlation dramatically increases and then remains almost constant till the second-last window. The authors underline that this result is quite consistent with their hypothesis stating that in the case of a clinically efficacious psychotherapy process the discourse between patient and therapist has to be thought of as a self-organizational system, characterised by an early non linear emergence of structure of order.

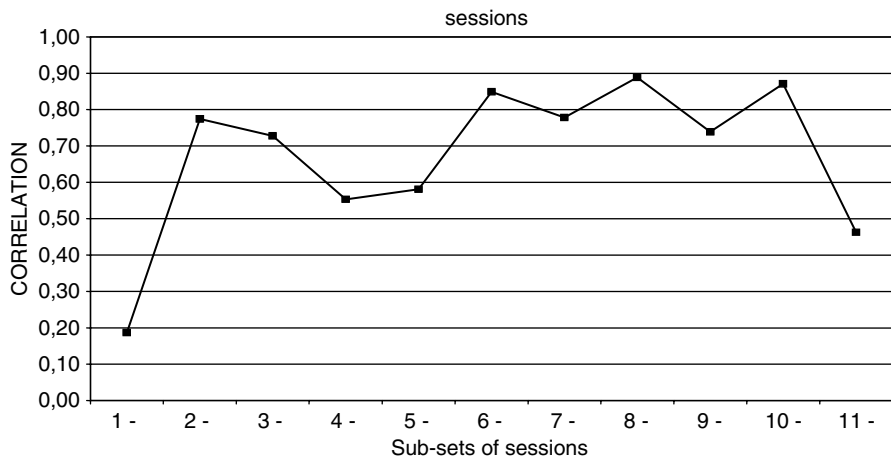

Fig. 8.4 Correlations between activity and super order meanings within a sub-set of 5 sessions

## Conclusion

In this chapter we have tried to highlight how the acknowledgement of the dynamicity of psychological phenomena—and in particular of intersubjectivity—entails methodological implications that while on the one hand challenge the conventional strategies of analysis, on the other hand open up new opportunities in the development of the theory. What in the final analysis is at the stake is the possibility of psychological theory taking into account the complexity of its object without for this reason having to give up methodological rigor and shareable knowledge—the latter being the cost usually associated with the traditional hermeneutic and idiographic approaches.

It is worth underlining that the dynamicity of the psychological field can be acknowledged merely in an analogical way, with no production of methodological innovation. This may have its uses, yet in our opinion it is not sufficient. What we need is to reduce, not increase the gap between theory and methodology. Moreover, the empirical investigation of the psychological process in dynamic terms would allow phenomena to be studied in their specificity/singularity and at the same time would mean that analyses could be made comparable and communicable to each other. This would contribute to the development of an idiographic science (Valsiner et al., 2009), that is a science of contingency, localness, irreversibility and singularity yet—as science—able to produce progressive and objective (in the sense of subjected to consensual validation) knowledge.

We are aware of the difficulty of such an endeavour. It is not coincidental that one can count very few examples of empirical investigation informed by the dynamic system paradigm (DS). Various reasons can make this situation understandable: the application of DS models often entails large sets of data that may not be available in the case of psychological research into sensemaking processes. Moreover, it requires mathematical competencies that are hard to find in the psychological field. Yet we do not think that these are the most critical issues. As a matter of fact, not all the DS models require large databases and, moreover, in some cases large databases are available—for instance, we have seen that this is so for some kinds of textual analysis. Besides, in the psychological field a lot of sophisticated procedures of data analysis are already currently in use.

In our opinion the major reason associated with the (so far) failed encounter between psychological theory and DS has to be sought elsewhere: in the fact that DS challenges the basic epistemic attitude shaping the paradigms and the praxis of research in the psychological field. Psychological research is essentially inductive. Even if researchers have to use constructs, they tend to believe that the variables they use are fundamentally free from major theoretical implications. This assumption is the grounds of the belief that research seeks facts—with the interpretative work operating after data collection.

The DS challenges this assumption: it proposes to model the phenomena. This means a turnaround in the relationship between theory and data, with the former being dominant. Obviously, the formal modelization of a phenomenon uses data too. Yet in this case the data is part of, and is used according to, a theory-driven

framework that exists before the empirical collection and defines the conditions of data validity.

With this consideration in mind, it is evident that the development of the DS in the psychological analysis of sensemaking phenomena would mean a Copernican change in the a-theoretical approach that is typical of most of the empirical investigation in the field.

This is then another good reason for working within this perspective.

**Acknowledgement** We wish to thank the participants in the session of the Clark University's Kitchen Seminar (10th of September, 2008) devoted to the discussion of a first draft of this text. The discussion that developed there provided meaningful feedback, helping us to bring the implications of our proposal into focus.

## References

- Bakeman, R., & Gottman, J. M. (1997). *Observing interaction. An introduction to sequential analysis* (2nd ed.). Cambridge: Cambridge University Press.
- Barkham, M., Stiles, W. B., & Shapiro, D. A. (1993). The shape of change in psychotherapy: Longitudinal assessment of personal problems. *Journal of Consulting and Clinical Psychology, 61*, 667–677.
- Borckardt, J. J., et al. (2008). Clinical practice as natural laboratory for psychotherapy research. A guide to case based time-series analysis. *American Psychologist, 63*(2), 77–95.
- Gennaro, A., Salvatore, S., Lis, A., & Salcuni, S. (2008, June 18–22). *Looking at the psychotherapy process as an intersubjective dynamic of sensemaking*. Paper presented at the 39th Annual Meeting of the Society of Psychotherapy Research Barcelona, Spain.
- Grassi, R. (2008). *Validazione di un modello di analisi delle narrazioni attraverso uno studio idiografico. L'Analisi Frastica Multidimensionale (AFM)* [Validation of a model of narrative analysis. An idiographic study with the Multidimensional Utterance Analysis]. Ph.D dissertation, University of Salento—Lecce.
- Herzberg, F., Mausner, B., & Snyderman, B. B. (1959). *The motivation to work* (2nd ed.). New York: Wiley.
- Hoffman, I. Z. (1998). *Ritual and spontaneity in the psychoanalytic process*. Hillsdale, NJ: The Analytic Press Inc.
- Krause, M. S., Howard, K. I., & Lutz, W. (1998). Exploring individual change. *Journal of Consulting and Clinical Psychology, 66*, 838–845.
- Lambert, M. J. (Ed.). (2004). *Bergin and Garfield's handbook of psychotherapy and behavior change* (5th ed.). New York: Wiley.
- Lancia, F. (2002). *The logic of a textscope*. Retrieved August 18, 2007, from <http://www.tlab.it/en/bibliography.php>
- Lancia, F. (2010 forthcoming). Word co-occurrence and similarity in meaning. In S. Salvatore & J. Valsiner (Eds.), *Mind as infinite dimensionality*. Roma: Firera Publishing Group.
- Langs, R. (1974). *The technique of psychoanalytic psychotherapy*. New York: Jason Aronson, Inc.
- Laurenceau, J. P., Hayes, A. M., & Feldman, G. C. (2007). Statistical and methodological issues in the study of change in psychotherapy. *Clinical Psychology Review, 27*, 715–723.
- Lauro-Grotto, R. P., Salvatore, S., Gennaro, A., & Gelo O. (2009). The unbearable dynamicity of psychological processes: Highlights of the psychodynamic theories. In J. Valsiner, P. Molenaar, M. Lyra, & N. Chaudhary (Eds.), *Dynamics process methodology in the social and developmental sciences* (pp. 1–30). New York: Springer.
- Mahoney, M. J. (1991). *Human change processes. The scientific foundations of psychotherapy*. New York: Basic Books.

- Maruyama, M. (1999). Heterogram analysis: Where the assumption of normal distribution is illogical. *Human Systems Management*, 18, 53–60.
- Mergenthaler, E. (1996). Emotion abstraction patterns in verbatim protocols: A new way of describing therapeutic processes. *Journal of Consulting and Clinical Psychology*, 64, 1306–1318.
- Molenaar, P. C. M., & Valsiner, J. (2005). How generalization works through the single case. A simple idiographic process analysis of an individual psychotherapy. *International Journal of Idiographic Science*. (Reprinted in S. Salvatore et al. (2009). *Yearbook of idiographic science 2008*. (Vol. 1). Rome: G Fireira Group)
- Nightingale, D. J., & Cromby, J. (Eds.). (1999). *Social constructionist psychology. A critical analysis of theory and practice*. Buckingham: Open University Press.
- Osgood, C. E., Suci, G. J., & Tannenbaum, T. H. (1957). *The measurement of meaning*. Urbana, IL: University of Illinois Press.
- Raudenbusch, S. W., & Bryk, A. S. (2002). *Hierarchical linear models. Applications and data analysis methods* (2nd ed.). Thousand Oakes: Sage
- Salvatore, S., Gelo, O., Gennaro, A., Manzo, S., Al-Radaideh, A. (in press). *Looking at the psychotherapy process as an intersubjective dynamics of meaning making. A case study with discourse flow analyzer*.
- Salvatore, S., Lis, A., Salcuni, S., Serio, A. V., Gennaro, A., Mossi, P. et al. (2006, September 28–October 1). *Confronto tra studio delle difese e della dinamica discorsiva nell'analisi del processo terapeutico. Studio di un caso [Comparison of defense mechanisms and discursive dynamics in the therapeutic process. A case study]*. Paper presented at the 6th Annual Meeting of the Italian Chapter of the Society of Psychotherapy Research. Reggio Calabria, Italy.
- Salvatore, S., Tebaldi, C., & Poti, S. (2008). The discursive dynamic of sensemaking. In S. Salvatore, J. Valsiner, S. Strout, & J. Clegg (Eds.), *Yearbook of idiographic science 2008* (pp. 39–72). Rome: Firera Publishing Group.
- Salvatore, S., & Venuleo, C. (2009) The unconscious as source of sense: A psychodynamic approach to meaning. In B. Wagoner (Ed.), *Symbolic transformations: The mind in movement through culture and society*. London: Routledge.
- Schaie, K. W., Willis, S. L., & Pennak, S. (2005). A historical framework for cohort differences in intelligence. *Research in Human Development*, 2, 43–67.
- Semerari, A., Carcione, A., Dimaggio, G., Falcone, M., Nicolo, G., Procacci, M., et al. (2003). Assessing problematic states inside patient's narratives. The grid of problematic conditions. *Psychotherapy Research*, 13(3), 337–353.
- TLAB—Tools for text analysis. By T-LAB® di Lancia Franco. Retrieved August 10, 2007, from <http://tlab.it>
- Toomela, A. (2008). Variables in psychology: A critique of quantitative psychology. *Integrative Psychological and Behavioral Science*, 42(3), 245–265.
- Toomela, A. (2009). How methodology became a toolbox—and how it escapes from that box. In J. Valsiner, P. C. M. Moolenaar, M. C. D. P. Lyra, & N. Chaudhary (Eds.), *Dynamic process methodology in the social and developmental sciences* (pp. 45–66). New York: Springer.
- Tschacher, W., Schiepek, G., & Brummer, E. J. (Eds.). (1992). *Self-organization and clinical psychology. Empirical approaches to synergetics in psychology*. Berlin: Springer Verlag.
- Valsiner, J., Salvatore, S., Strout, S., & Clegg, J. (Eds.). (2009). *Yearbook of idiographic science 2008*. (Vol. 1). Rome: Firera Publishing Group.
- Venuleo, C., & Salvatore, S. (2006). Linguaggi e dispositivi comunicativi. I *Faccia a Faccia* televisivi [Languages and communication devices. Face to face television debates]. In S. Cristante, & P. Mele (Eds.), *Da Vendola a Prodi. I media nelle campagne elettorali 2005–2006* (pp. 151–189). Nardò, LE: Besa Editrice.

# Chapter 9

## Idiographic Data Analysis: Quantitative Methods—From Simple to Advanced

Ellen L. Hamaker and Conor V. Dolan

Time series analysis is a technique by which a large number of repeated measures taken from a single case can be modeled. As it requires observations from only one case, this is a useful technique for researchers interested in idiographic data analysis. The most basic time series technique is the well-known autoregressive moving average (ARMA) model (Box & Jenkins, 1970; Chatfield, 2004; Hamilton, 1994). It combines the AR model and the MA model, both of which were separately invented in 1927 to handle the autocorrelation typically observed in time series data (Tong, 2001). Characteristic of the AR model is that the current observation is predicted from previous observations (Box & Jenkins, 1970; Granger & Morris, 1976). The part of an observation that cannot be predicted based on previous observations is called the random shock, residual, or innovation. In contrast, the MA model consists of predicting the current observation from a weighted sum of previous random shocks (Box & Jenkins, 1970; Granger & Morris, 1976). Combining these two models resulted in the ARMA model, which gained widespread popularity through the 1970 book *Time series analysis: Forecasting and control* by Box and Jenkins.

This chapter provides a brief tour of the original ARMA model and some of its most popular extensions, which were developed in econometrics and other fields that rely heavily on time series analysis. To emphasize the potential of ARMA-based modeling for the social sciences, we include references to applications within psychology, sociology and criminology that illustrate the use and interpretation of these models. We do not focus on how to implement these models, nor will we discuss issues related to model estimation and evaluation, but the interested reader is referred to standard introductory texts such as Hamilton (1994), Chatfield (2004), Durbin and Koopman (2001), Harvey (1989), and Fan and Yao (2003).

In the following four sections we present the basic ARMA model and its extensions: Section “ARIMA Models” is on the building blocks of the integrated ARMA

---

E. L. Hamaker (✉)  
Department of Methods and Statistics  
Faculty of Social Sciences  
Utrecht University  
PO Box 80140  
3508 TC Utrecht, The Netherlands  
e-mail: e.l.hamaker@uu.nl



(ARIMA) model; Section “Univariate Extensions of the ARIMA model” includes, ARMA models with deterministic trends and cycles, seasonal ARIMA models, fractionally integrated ARMA models, and impact ARIMA models; Section “Multivariate Extensions of ARMA model” includes the vector ARMA (VARMA) model, VARMA models with exogenous variables, latent VARMA models, and the cointegrated model; and Section “Nonlinear Extensions of the ARMA model” includes the bilinear model, the conditional heteroscedastic model, the threshold AR model, and the Markov-switching AR model. Each section ends with a discussion of applications of these techniques in the social sciences.

For all models discussed in this chapter it is assumed that the data are measured at interval or ratio level, and that observations are made at equal time intervals. However, at the end of this chapter we briefly mention some alternative techniques that are not based on these assumptions. Another important assumption for some of the models discussed in this chapter is stationarity. Assuming Gaussian data, stationarity implies that the mean, variance and autocovariances<sup>1</sup> of the series are independent of time. The basic ARMA model is based on the assumption that the data are stationary, but many of its extensions are nonstationary (e.g., the ARIMA model). In what follows we consistently indicate whether certain processes are stationary or not.

## ARIMA Models

In this section we introduce the building blocks of the general ARIMA model, that is: (a) the AR model; (b) the MA model; (c) the mixed ARMA model; and finally (d) the full ARIMA model.

### *Autoregressive (AR) Model*

Let  $y_t$  be a univariate observation at occasion  $t$ . In the most simple version of the AR model, the AR (1), the observation  $y_t$  can be predicted from the previous observation  $y_{t-1}$ . This can be represented as

$$y_t = \phi_0 + \phi_1 y_{t-1} + u_t, \quad (1)$$

where  $\phi_0$  is a constant,  $\phi_1$  is the AR parameter, that is, it is the regression coefficient in the regression of  $y_t$  on  $y_{t-1}$ , and  $u_t$  is the part of  $y_t$  that could not be predicted from  $y_{t-1}$ , and which is referred to as the innovation, residual, prediction error, or random shock. As the innovation at occasion  $t$  is the part of  $y_t$  that is independent of the

<sup>1</sup> The autocovariance is the covariance between  $y_t$  and  $y_{t+k}$ , that is,  $E[(y_t - \mu)(y_{t+k} - \mu)]$ , where  $\mu$  is the mean of the series. The lag  $k$  is the distance in time. When  $k = 0$ , we obtain the variance of the series. The autocorrelation at lag  $k$  can be obtained by dividing the autocovariance at lag  $k$  by the variance of the series.

observations before occasion  $t$ , it is also independent of the innovations  $u$  prior to and after occasion  $t$ . Such a sequence is referred to as a white noise sequence. The mean of this sequence is zero and its variance is denoted as  $\sigma_u^2$ . To ensure that the AR model in Eq. (1) is stationary, the parameter  $\phi_1$  has to lie between  $-1$  and  $1$ . If this restriction is violated, the variance of the process will increase over time. It can be shown that if  $|\phi_1| < 1$ , the mean of the observed series is  $\mu_y = \phi_0 / (1 - \phi_1)$ , and its variance is  $\sigma_y^2 = \sigma_u^2 / (1 - \phi_1^2)$  (Chatfield, 2004).

A general expression of the AR model of order  $p$  (i.e., AR ( $p$ )) is

$$y_t = \phi_0 + \phi_1 y_{t-1} + \phi_2 y_{t-2} + \dots + \phi_p y_{t-p} + u_t, \quad (2)$$

where  $\phi_0$  is a constant,  $\phi_1$  to  $\phi_p$  are the AR parameters in the regression of  $y_t$  on  $y_{t-1}$  to  $y_{t-p}$ , and  $u_t$  is the innovation. For such higher order AR processes the stationarity restrictions are quite complicated (see Hamilton, 1989, pp. 27–33). If the process is stationary, the mean can be shown to equal  $\mu_y = \phi_0 / (1 - \phi_1 - \dots - \phi_p)$ . The expression for the variance of a pure AR process in terms of the variance of the innovations and the AR parameters is given in Hamilton (1994, p. 59).

Granger and Morris (1976) indicated that an AR process can be interpreted as a momentum effect in a random variable. To illustrate this, suppose we are driving down the freeway at a speed of 70 miles/h. If we measure the exact speed at different occasions, we will find that the speed is not exactly 70 miles/h every time, but it actually fluctuates around this value. If we measure our speed once every minute, we will probably find no sequential relationship between successive observations. However, if we measure speed every five seconds, there probably will be some sequential dependency, simply because the variable speed needs *time* to change. If the interval between measurement occasions grows smaller, we will find a stronger sequential relationship between successive observations. In general we can state that the sequential dependency of a variable that is continuous over time (such as our speed), depends on the intervals between observations.

### ***Moving Average (MA) Model***

If an observation  $y_t$  can be predicted by the unpredictable parts at previous occasions, we have an MA process. It implies that the observation  $y_t$  is a weighted sum of two or more innovations. An MA process of order one, denoted as an MA (1), can be expressed as

$$y_t = \mu_y + u_t - \theta_1 u_{t-1}, \quad (3)$$

where  $u_t$  is a white noise sequence,  $\mu_y$  is the mean of the observed series, and  $-\theta_1$  is the MA parameter by which the innovation of the previous occasion is weighted.<sup>2</sup>

<sup>2</sup> In some texts  $-\theta_1$  is replaced by  $\Psi_1$ , such that the minus sign is omitted. However, the above notation is more conventional, as it has some important advantages for the expression of particular characteristics of an MA process.

We can also say that  $-\theta_1$  is the parameter that is used to regress the observation  $y_t$  upon the unpredictable part of the previous observation, that is,  $u_{t-1}$ . The variance of the observed series can be shown to equal  $\sigma_y^2 = (1 + \theta_1^2)\sigma_u^2$  (Chatfield, 2004).

The general expression for an MA process of order  $q$  is

$$y_t = \mu_y + u_t - \theta_1 u_{t-1} - \theta_2 u_{t-2} - \cdots - \theta_q u_{t-q}, \quad (4)$$

where  $\mu_y$  is the mean of the observed series,  $-\theta_1$  to  $-\theta_q$  are the parameters by which the previous innovations  $u_{t-1}$  to  $u_{t-q}$  are weighted. The variance of this process is equal to  $(1 + \theta_1^2 + \cdots + \theta_q^2)\sigma_u^2$  (Chatfield, 2004).

Pure MA processes are by definition stationary. However, there are restrictions necessary to ensure the model is invertible, which implies that it can be rewritten as an AR model (we elaborate on this below). These restriction are analogous to the restriction on the AR parameters to ensure stationarity. For an MA (1), this implies that  $Q_x$  must lie between  $-1$  and  $1$  (see Hamilton, 1994, p. 67, for invertibility restrictions for higher order MA processes).

Granger and Morris (1976) described an MA process as involving a variable in equilibrium, which is buffeted by a sequence of unpredictable events with a delayed or discounted effect. Hence, the innovation  $u_t$  is interpreted as being due to events or circumstances that influence the variable under investigation  $y_t$ . To illustrate this, suppose we ask an individual repeatedly to answer the question how good (s)he feels today. The score  $y_t$  at a certain day is influenced by the circumstances that day  $u_t$  (e.g., attending a party, getting some good news, having a disagreement with a good friend), but it may also depend on the events that took place in the recent past, i.e.,  $u_{t-1}$  to  $u_{t-q}$ .

### ***Mixed Autoregressive Moving Average (ARMA) Models***

The two processes described above can also be combined, resulting in an ARMA ( $p, q$ ) process. The general expression for such a process is

$$\begin{aligned} y_t &= \phi_0 + \phi_1 y_{t-1} + \cdots + \phi_p y_{t-p} + u_t - \theta_1 u_{t-1} - \cdots - \theta_q u_{t-q} \\ &= \phi_0 + \sum_{j=1}^p \phi_j y_{t-j} + u_t - \sum_{j=1}^q \theta_j u_{t-j}, \end{aligned} \quad (5)$$

where the innovation  $u_t$  is a white noise sequence. Hence,  $y_t$  is a weighted sum of previous observations, going back to  $y_{t-p}$ , and previous innovations, going back to  $u_{t-q}$ . To ensure stationarity, the same restrictions apply to the AR parameters as in the pure AR model. Similarly, to ensure invertibility, the same restriction apply to the MA parameters as in the pure MA model. The expression of the mean of the observed series is the same as for a pure AR model, but the expression for the variance is more complicated (see Hamilton, 1994, pp. 61–63).

A mixed ARMA process is difficult to interpret in substantive terms. However, each AR process of finite order can be rewritten as an MA process of infinite order,

i.e., an MA ( $\infty$ ). Conversely, each invertible MA process of finite order can be represented as an AR process of infinite order. Moreover, each mixed ARMA process of finite orders  $p$  and  $q$ , can be rewritten as either a pure AR process of infinite order, or a pure MA process of infinite order. This implies that the differences between pure AR, pure MA, and mixed ARMA models are not absolute, which in turn gives rise to the question how to choose between these different representations.<sup>3</sup>

In the Box and Jenkins approach the aim is forecasting and control, and the interpretation of the parameters is mainly in terms of predictive relations (Box & Jenkins, 1970). Hence, in this context it makes sense to find the model with the minimum number of parameters. For the social scientist often the substantive interpretation is more important than forecasting, and from this perspective pure AR and pure MA models may be preferable over mixed ARMA models.

Yet another interesting relationship between ARMA models was published by Granger and Morris (1976), who showed that mixed ARMA processes can arise from summing independent, stationary processes. For instance, summing two AR (1) processes results in an ARMA (2, 1) process, and adding a white noise sequence to an AR ( $p$ ) process results in an ARMA ( $p, p$ ). Although it is not possible to disentangle the original processes that have given rise to a mixed ARMA processes, mixed processes may be interpreted in terms of a summation of pure processes. Specifically, models in which white noise is added to a pure AR process are compatible with the idea of noisy measurements: It would imply that there is both measurement error (i.e., the white noise sequence), and prediction error (i.e., the unpredictable part in the AR process), which are two separate sources of variation.

### ***Integrated Autoregressive Moving Average (ARIMA) Model***

All the models discussed above are stationary, meaning that the mean, variance and autocovariances are invariant over time. A special class of nonstationary models is formed by the integrated models. Characteristic of an integrated process is that it becomes stationary after differencing it, meaning the previous observation is subtracted from the current observation. Thus, while  $y_t$  is nonstationary,  $\Delta y_t = y_t - y_{t-1}$  is stationary. Sometimes, differencing needs to be carried out multiple times to obtain a stationary series. If differencing the data once results in stationarity, the process is said to have a unit root (cf., Hamilton, 1994), and it may be referred to as an I (1) process.

A simple example of an integrated process is an ARIMA (0, 1, 0) model, which is also referred to as a random walk, that is

$$y_t = y_{t-1} + u_t. \tag{6}$$

<sup>3</sup> In practice, a process of infinite order is not appealing, as there will be more parameters to estimate than observations. However, in finite samples, the parameters beyond a certain lag will be insignificant and can be omitted from the model. The important issue is that there are no fundamental differences between these processes.

While  $y_t$  is nonstationary, differencing it results in  $\Delta y_t = y_t - y_{t-1} = u_t$ , which is a stationary process. What is typical for a random walk is that while the mean is independent of time (i.e.,  $E[y_t] = 0$  for all  $t$ ), the variance is ever increasing over time (i.e.,  $\text{Var}[y_t] \rightarrow \infty$  as  $t \rightarrow \infty$ ).

A unit root process for which the differenced series obeys a stationary ARMA model is denoted as an ARIMA ( $p, 1, q$ ), that is

$$y_t = y_{t-1} + z_t \quad (7a)$$

$$z_t = \phi_1 z_{t-1} + \dots + \phi_p z_{t-p} + u_t - \theta_1 u_{t-1} - \dots - \theta_q z_{t-q}, \quad (7b)$$

where  $z_t$  is the differenced series  $\Delta y_t = y_t - y_{t-1}$ , and is a stationary ARMA process. Another unit root process which is applied frequently in econometrics is the random walk with drift. This model can be represented as

$$y_t = \delta + y_{t-1} + u_t, \quad (8)$$

where  $\delta$  is referred to as the drift, or the stochastic trend (as opposed to a deterministic trend which is discussed in the following section). If  $\delta > 0$ ,  $y_t$  tends to increase over time, while if  $\delta < 0$ ,  $y_t$  tends to decrease.

The interpretation of unit root processes focuses on the difference scores  $\Delta y_t$ , which can be modeled as an ARMA ( $p, q$ ) process. For instance, if a researcher finds that an ARIMA (1, 1, 0) fits the data, this can be interpreted as meaning that the change from the previous occasion to the current occasion (i.e.,  $\Delta y_t$ ), can be predicted from the change that took place right before that ( $\Delta y_{t-1}$ ).

## *Applications in the Social Sciences*

Many applications of ARMA and ARIMA modeling in the social sciences serve the purpose of prewhitening the data, which implies the data are transformed into a white noise series. The goal of prewhitening in these applications is to determine whether there are indications for causal relationships between two or more series, while controlling for autocorrelation due to AR-, I-, and MA-components. It is well known that failing to account for such autocorrelation in the univariate series may result in spurious relationships between the series. While this procedure is still used today, there are multivariate extensions of the ARMA model which allow for the simultaneous modeling of the ARMA relations, and the mutual effects. Moreover, differencing may remove important information about the long run relationship between two or more series (e.g., in the case of cointegration, see below).

Applications of ARIMA modeling as a prewhitening technique in the social sciences have been used relatively often to establish a relationship between aggregate time series, such as the alcohol consumption per capita and suicide or criminal violence rates (e.g., Bye, 2007; Razvodovsky, 2007). Bye (2007) for instance, concluded that there was evidence for a causal effect of alcohol consumption on violence. An example of prewhitening in psychological research is the study done by

Andersson and Yardley (2000), who investigated the relationship between the pre-whitened measures of dizziness and physical, mental, and emotional stress. They found evidence for concurrent relations mainly, although two of the ten participants were characterized by an increase in stress (either mental or emotional) prior to increases in dizziness. In another study, Andersson, Hågnebo, and Yardley (1997) used prewhitening to study the relationship between stress and symptoms associated with Meniere disease.

There are some studies in which ARIMA modeling was not used merely as a prewhitening device, but rather as a procedure to unveil the dynamics underlying the observed series. In particular, Fortes, Delintnières, and Ninot (2004) used the ARIMA (0, 1, 1) model as a means to understand the balance between two opposite forces: preservation and adaption. Let  $\hat{y}_t = y_t - u_t$  be the expectation (i.e., the predictable part) of  $y_t$ . Since  $y_t = y_{t-1} + u_t - \theta_1 u_{t-1}$ , we can also write

$$\begin{aligned}\hat{y}_t &= y_{t-1} - \theta_1 u_{t-1} \\ &= \hat{y}_{t-1} + u_{t-1} - \theta_1 u_{t-1}.\end{aligned}$$

From the latter expression it becomes clear that if the MA coefficient  $\theta_1$  is close to 1, this serves as a restoring mechanism, in which the expectation at occasion  $t$  is close to the expectation at occasion  $t - 1$ . Such a process may be interpreted as a form of preservation, meaning there is resistance to the influence of temporal effects (Fortes et al., 2004). In contrast, an MA coefficient further away from 1 implies the expectation changes, as the expectation at  $t$  is inflected by the innovation. The latter is more indicative of adaption to change, in which temporal disturbances tend to leave a persistent trace in the data (Fortes et al., 2004).

Fortes et al. (2004) apply ARIMA modeling to the data obtained from seven individuals on six variables related to self-esteem and physical self, and concluded that for 35 of the 42 series an ARIMA (0, 1, 1) model was the most appropriate model. ARIMA (0, 1, 1) models were also used by Peterson and Leckman (1998), who measured inter-tic interval in patients with Gilles de la Tourette syndrome, and investigated the temporal patterning of tics. They concluded that the tics intervals are nonstationary. In addition, the change in tic intervals oscillates rapidly, with large changes followed by small ones and vice versa. Note however that this application differs from usual ARIMA applications, which are based on observations made at equal intervals.

## Univariate Extensions of the ARIMA Model

In this section we discuss several univariate extensions of the ARIMA model, that is: (a) the ARMA model with trends, which are applicable if there is some kind of smooth development over time; (b) the seasonal ARIMA model, referred to as SARIMA model, which can be used if the process has a cyclic component to it; (c) the fractionally integrated ARMA model (denoted as ARFIMA or FARIMA

model), which can be used if a process exhibits long-range dependency; and (d) the impact ARIMA model, which can be used if there is a sudden impact of an intervention or another sudden change.

### ***ARMA Model with Trends***

A logical extension of the ARMA model is to add a deterministic trend, such that the ARMA model describes the variability around this deterministic trend. The trend may have various functional forms, for instance, linear, quadratic, or cyclic. An ARMA model with a linear trend can be represented as

$$y_t = b_0 + b_1 t + \tilde{y}_t \quad (9a)$$

$$\tilde{y}_t = \phi_1 \tilde{y}_{t-1} + \cdots + \phi_p \tilde{y}_{t-p} + u_t - \theta_1 u_{t-1} - \cdots - \theta_q u_{t-q}, \quad (9b)$$

where  $b_0$  is the intercept and  $b_1$  is the slope by which the observed series are regressed on time. The residual  $\tilde{y}_t = y_t - (b_0 + b_1 t)$  is then modeled as an ARMA  $(p, q)$  process. Alternatively, the model in (9a) and (9b) may be represented in a single equation as

$$y_t = b_0^* + b_1^* t + \phi_1 y_{t-1} + \cdots + \phi_p y_{t-p} + u_t - \theta_1 u_{t-1} - \cdots - \theta_q u_{t-q}. \quad (10)$$

Note however that in this presentation the parameters  $b_0^*$  and  $b_1^*$  no longer have the easy interpretation of intercept and slope, which the parameters  $b_0$  and  $b_1$  have in Eq. (9a) (Hamaker, 2005).

Processes which consist of a deterministic trend with ARMA residuals are referred to as trend-stationary (Hamilton, 1994): Although these processes are not stationary themselves, they become stationary once the trend is removed. A trend-stationary process may be difficult to distinguish from an integrated process with drift, as described in the previous section. However, if the process is an integrated process with drift, subtracting a linear trend would remove the time-dependency of the mean, but not of the variance. Thus, the resulting series would be mean-stationary, but not variance-stationary (Hamilton, 1994). Determining whether to subtract a linear trend or to difference the data can be done based on the results of a unit root test (see Hamilton, 1994, pp. 444–447).

### ***Seasonal ARIMA Model***

Box and Jenkins (1970) extended the ARIMA model to deal with seasonal effects. The basic idea of adding this seasonal component is to accommodate a cyclic effect. For instance, if we consider monthly data, the observation  $y_t$  may depend to some extent on  $y_{t-12}$ , which represents a annual effect. Similarly, for daily data the observation  $y_t$  may depend on  $y_{t-7}$ , representing a weekly effect. To deal with

these dependencies, the data may be differenced to remove this seasonality, but one can also specify AR or MA relationships at this seasonal interval. This results in the SARIMA  $(p, d, q) \times (P, D, Q)$  model, where  $p, d,$  and  $q$  refer to the ARIMA effects discussed before, and  $P, D,$  and  $Q$  refer to the ARIMA effects at a seasonal lag.

To represent a SARIMA model, we introduce another series  $z_t$  which is obtained from  $y_t$  by differencing both seasonally and in the way used for ARIMA models (Chatfield, 2004). Then this differenced series is modeled as a SARMA model, in which ARMA relationships can occur directly, or seasonally. For instance, if we consider a simple SARIMA model with only  $D = 1$  for a weekly effect (i.e., SARIMA  $(0, 0, 0) (0, 1, 0)$ ),  $z_t$  can be written as

$$z_t = \Delta^{(7)}y_t = y_t - y_{t-7}. \quad (11)$$

Assuming that  $d=D=1$ , and that we are dealing with daily measurements for which we want to consider a weekly effect,  $z_t$  becomes

$$\begin{aligned} z_t &= \Delta \Delta^{(7)}y_t = \Delta^{(7)}y_t - \Delta^{(7)}y_{t-1} \\ &= y_t - y_{t-7} - y_{t-1} + y_{t-8}. \end{aligned} \quad (12)$$

Finally, if a SARIMA  $(1, 0, 0) \times (0, 1, 0)$  model is considered with a weekly effect, this can be written as

$$\begin{aligned} z_t &= \Delta^{(7)}y_t \\ &= \phi_1 \Delta^{(7)}y_{t-1} + u_t \\ &= \phi_1(y_{t-1} - y_{t-8}) + u_t \end{aligned} \quad (13)$$

such that  $y_t = y_{t-7} + \phi_1(y_{t-1} - y_{t-8}) + u_t$ .

Clearly, this approach allows for many possibilities. However, the interpretation in substantive terms may be difficult. For instance, it is conceivable that a person's emotional state is subject to a weekly effect pattern, which may be captured with the model in (13). This would mean that the difference between today's score and last week's score can be predicted from the difference between yesterday's score and the score on the same day last week using  $\phi_1$ . It is doubtful whether applied researchers will find such explanations plausible. Alternatively, one may choose to model a seasonal effect as a deterministic cyclic trend (as discussed above), such as a sine wave. Other options for handling seasonal effects are discussed at the end of this section.

### ***Fractionally Integrated ARMA (ARFIMA) Model***

The ARFIMA model is a generalization of the ARIMA  $(p, d, q)$  model in which the integration parameter  $d$  can take on noninteger values. Integrated processes are nonstationary, but become stationary after differencing the data. When  $d$  is an integer, it is easy to write down the expression of the stationary series in terms of the original series: For instance, when  $d = 1$ , the stationary series is  $\Delta y_t = y_t - y_{t-1}$ , and for



$d = 2$  we can write  $\Delta^2 y_t = \Delta y_t - \Delta y_{t-1} = y_t - 2y_{t-1} + y_{t-2}$ . But when  $d = 0.5$ , differencing is fractionally, and cannot be expressed in a simple difference equation (Granger, 1980). However, it implies that  $\Delta^{0.5} y_t$  is a stationary series. Such fractional integration can be combined with the usual AR and MA relationships, resulting in the ARFIMA model.

Characteristic of ARFIMA processes is that they exhibit long-term dependencies which becomes clear from a very slowly decaying autocorrelation function. This implies that an innovation at occasion  $t$  continues to influence future observations for a long time. For this reason such processes are also referred to as long-memory processes. However, Granger and Ding (1996) point out that many other processes may exhibit long-term memory and that this is not a unique feature of fractionally integrated processes.

When  $0 < d < 0.5$ , the variance of  $y_t$  is finite, while  $0.5 \leq d < 1$  results in infinite variance (Granger, 1980). Hamilton showed that for  $d < 1$ , a fractionally integrated process can be rewritten to a pure MA process of infinite order, in which the MA parameters decay slowly, that is

$$y_t = h_0 u_t + h_1 u_{t-1} + h_2 u_{t-2} + \dots \tag{14}$$

where  $h_j \cong (j + 1)^{d-1}$  (Hamilton, 1994, pp. 448–449). Hence, if  $d = 0.5$ , the MA coefficients would be:  $h_0 = 1$ ,  $h_1 = 0.71$ ,  $h_2 = 0.58$ ,  $h_3 = 0.50$ ,  $h_4 = 0.43$ , etc. As  $d \rightarrow -\infty$ , the process becomes a white noise sequence.

Granger (1980) also showed that ARFIMA models may arise from aggregating other processes. This implies that, as with mixed ARMA processes, an ARFIMA process can be interpreted as the sum of different processes.

### ***Impact ARIMA Models***

McCleary, Hay, Meidinger, McDowall, and Land (1980) present the impact or interrupted ARIMA model which can be used to study the effect of an intervention (or event), while assuming that both before and after the intervention an ARIMA model is appropriate. To model the intervention effect they make use of a transfer function. The simplest version of this is the zero-order transfer function, which results in an abrupt, permanent change. Let  $I_t$  be a step function, such that  $I_t = 0$  before the intervention, and  $I_t = 1$  afterward. Then, the observed series can be represented as

$$y_t = \lambda I_t + \omega_t, \tag{15}$$

where  $\omega_t$  is an ARIMA ( $p, d, q$ ) model, or potentially a SARIMA model. The parameter  $\lambda$  represents the effect of the intervention.

To allow for a more gradual impact of the intervention, we can use a first-order transfer function. To this end we define the intervention component as  $y_t^* = y_t + \omega_t$ , such that  $y_t = y_t^* + \omega_t$ , where  $\omega_t$  is as defined above. Then,

$$y_t^* = \psi y_{t-1}^* + \lambda I_t. \tag{16}$$

This implies that prior to the intervention, the intervention component  $y_t^* = 0$  so that  $y_t = \omega_t$ . After the intervention takes place at  $t = \tau$ , the intervention component can be expressed as

$$y_{\tau+n}^* = \sum_{i=1}^n \psi^{i-1} \lambda. \quad (17)$$

From this it follows that if  $\psi = 0$ , we have the zero-order transfer function such as discussed above, with an immediate and abrupt effect of the intervention; if  $\psi = 1$  the intervention component  $y_t^*$  continues to grow in a linear fashion with slope  $\lambda$ ; and if  $0 < \psi < 1$ , the intervention has a gradual effect which levels off some time after  $\tau$ .

While interrupted time series models, such as discussed here, have proved valuable in studying the effects of community interventions (e.g., the effect of safety warnings on antidepressants used among youths, see Olfson, Marcus, & Druss, 2008), these models may be less appropriate for studying interventions in the form of psychotherapy, because there the changes are likely to take place more slowly, typically across the entire course of therapy. Moreover, a patient in psychotherapy may display various degrees of relapse, which may require repeated or revised therapeutic intervention. Another potential limitation of these interrupted ARIMA models is that it is assumed that only the level changes, while the ARIMA process  $\omega_t$  is unaffected by the intervention. To overcome these limitations, one could decide to model separate trends and ARIMA processes before and after the intervention, and determine whether certain parameters may be constrained across these two phases (e.g., Hamaker, Dolan, & Molenaar, 2003).

Rather than using the step function as represented by  $I_t$ , one may consider a pulse function  $P_t$ , which is defined as  $P_t = 1$  at the time of the intervention, and  $P_t = 0$  before and after the intervention. Such an intervention model can be valuable if the effect of the intervention is reversible, for instance, the effect of medication on the hyperactivity behavior of a child diagnosed with attention deficit hyperactivity disorder. Such an intervention model has parallels with what is known as ABA-designs (cf., Hersen & Barlow, 1976).

### *Applications in the Social Sciences*

Hamaker et al. (2003) illustrated ARIMA modeling with deterministic trends using three data sets: concentration of luteinizing hormone in blood samples from a healthy female measured at 10 min intervals during the late follicular phase; annual employment percentages of different populations between 1972 and 1998; and the perceptual speed scores of a patient diagnosed with schizophrenia before and after intervention with medication.

Buck and Morley (2006) used SARIMA modeling to study attentional pain control strategies. Because they obtained three measurements per day, they used sea-

sonal differencing to model the time-of-day effect. However, it seems that the actual SARIMA modeling procedure has not seen many applications in the social sciences, and often an alternative way to account for seasonal effects is employed. An example of this can be found in Ichii (1991), who studied the effect of suicide news on monthly suicide rates in Japan. In order to control for a possible seasonal effect, the current suicidal rate is not only regressed upon last month's suicidal rate (and of the month before that in some models), but also on the suicidal rate 12 months ago. Although this may seem like a SARIMA (2, 0, 0) (0, 1, 0) model, it is not: The latter would result in  $y_t = y_{t-12} + \phi_1(y_{t-1} - y_{t-13}) + \phi_2(y_{t-2} - y_{t-14}) + u_t$ , while the model used by Ichii is  $y_t = \phi_1 y_{t-1} + \phi_2 y_{t-2} + \phi_{12} y_{t-12} + u_t$  (Ichii, 1991).

Fractionally integrated processes have enjoyed an increasing interest in the area of reaction time data, where it has been stated by some that long-range memory processes are omnipresent. However, Wagenmakers, Farrell, and Ratcliff (2004) have shown that about half of the empirical time series they considered could be described better with a stationary ARMA (1, 1) process, than with an ARFIMA (1,  $d$ , 1) process. Delignières, Fortes, and Ninot (2004) applied fractional models to the repeated measurements of self-esteem and physical self of four participants. They conclude that there is not only a balance between preservation and adaption in the short run (as can be shown with an ARIMA (0, 1, 1) model), but that this balance occurs at multiple time scales in a self-similar way. They indicate that a fractionally integrated process is a compromise between the absolute preservation of the expectation (i.e.,  $\hat{y}_t = y_t - u_t$ ), as in a white noise process where the expectation is equal to zero for all occasions, and the absolute adaption to change as in the (non-fractionally) integrated process where the expectation is equal to the last observation.

An example of interrupted time series on aggregate time series can be found in Haker, Lauber, Malti, and Rössler (2004), who studied the effect of the 9/11 attacks and the 9/27 amok in Zug in Switzerland (i.e., there are two interventions), on weekly psychiatric patient admissions. They concluded that, contrary to ordinary belief, external psychosocial factors do not influence the need for hospitalization of patients with severe mental disorders. Another example is the study by Cohan and Cole (2002), who investigated the effect of a natural disaster on major family transitions. Their data consist of annual marriage, birth and divorce rates in South Carolina. They also used a pulse function, i.e., a variable with value zero for the years 1975–1989, value one for the year 1990 to model the effect of Hurricane Hugo in 1989, and value zero for the years 1991–1997. They found that (after controlling for the general changes over the 24 year span), birth, marriage, and divorce rates were elevated in 1990, indicating that natural disasters mobilizes people to take action in their personal lives.

## Multivariate Extensions of ARMA Model

The multivariate extensions of the ARMA model can be divided into four classes: (a) extensions in which the AR and MA relationships are modeled between the observed variables; (b) an ARMA model in which exogenous variables are included;

(c) extensions which are based on introducing latent variables that are measured by multiple indicators, with an ARMA process at the latent level; and (d) cointegrated models in which the combination of two nonstationary processes is stationary.

### Vector ARMA Model

The vector ARMA or VARMA model is a straightforward extension of the univariate ARMA model, which was discussed above. Let  $\mathbf{y}_t$  be an  $M$ -variate observation at occasion  $t$ , which may be predicted from previous observations, and from unpredictable parts of previous observations. The VARMA ( $p, q$ ) model is denoted as

$$\begin{aligned} \mathbf{y}_t &= \phi_0 + \Phi_1 \mathbf{y}_{t-1} + \dots + \Phi_p \mathbf{y}_{t-p} + \mathbf{u}_t - \Theta_1 \mathbf{u}_{t-1} - \dots - \Theta_q \mathbf{u}_{t-q} \\ &= \phi_0 + \sum_{j=1}^p \Phi_j \mathbf{y}_{t-j} + \mathbf{u}_t - \sum_{j=1}^q \Theta_j \mathbf{u}_{t-j} \end{aligned} \tag{18}$$

where  $\phi_0$  is an  $M$ -variate vector with constants, and  $\mathbf{u}_t$  is an  $M$ -variate vector with innovations. Although not strictly necessary, the elements of  $\mathbf{u}_t$  are often assumed to be uncorrelated with each other.

The  $M \times M$  matrices  $\Phi$  contain the AR parameters on the main diagonal (i.e., the parameters that are used to regress the series upon itself at an earlier occasion), while the off-diagonal elements represent the cross-regression parameters. Thus, element  $\phi_{ij,k}$  is used to regress the series  $i$  at occasion  $t$  on the series  $j$  at  $t - k$ . These matrices are not necessarily symmetric. For instance, series  $i$  may be regressed upon series  $j$  at previous occasions ( $\phi_{ij,k} \neq 0$ ), whereas series  $j$  is not regressed on series  $i$  ( $\phi_{ji,k} = 0$ ). The  $M \times M$  matrices  $\Theta$  contain the MA coefficients on the main diagonal. The off-diagonal elements are the parameters by which the unpredictable part of one series at a particular occasion may be predictive of the observation of another series at a later occasion. The model in Eq. (18) may be further simplified to a VAR model, in which case all  $\Theta$  matrices are zero matrices (e.g., Hamilton, 1994, p. 291). Such models may be used to determine whether there are indications of causal relationships between two or more variables that were measured repeatedly. Hence, it is a more sophisticated alternative to investigating reciprocal influences than by means of prewhitened series.

At first sight the VAR model may seem useful for modeling all kinds of data for which we assume one of the variables has a causal effect on the other (and possible vice versa). However, a VARMA model represents a stationary model and thus it requires the data to be stationary or to be rendered stationary by a suitable transformation. Suppose a researcher is interested in the effect of the empathy of a therapist on the depressive symptoms of a client. If the latter actually show a decline over time, the raw observations can not be modeled directly according to a VAR process. Rather, the researcher will have to make the series stationary, either by detrending the data or by differencing the data. Both approaches have disadvantages.

On the one hand, detrending the data through subtracting a linear (or another) trend implies that if one uses the therapist's data to predict the detrended client's data, one is merely predicting the deviations to the deterministic trend.<sup>4</sup> However, a beneficial effect of the therapy is represented by a decrease over time in symptomatology, which has been taken out when the data are detrended. Thus, one is not really modeling the part one is interested in when applying the VARMA model to the detrended data.

On the other hand, differencing the data is based on the assumption that the process has properties related to a random walk. Recall that a random walk has an expectation of zero, which would imply that the client could just as well improve as worsen over time, with no structural change in the long run. To ensure a positive change in the long run, we would have to find a negative drift (which indicates a decrease in symptomatology). However, this drift is a constant, and is not modeled as a function of the therapist's behavior. In sum, neither solution allows for modeling the structural change as a function of the therapist's behavior. An alternative that may be more appropriate is the cointegration technique discussed later in this section.

### ***VARMAX Model***

A VARMAX model is simply a VARMA model with  $J$  observed exogenous variables, denoted as  $\mathbf{x}_t$ . The VARMAX model can be written as

$$\mathbf{y}_t = \phi_0 + \sum_{j=1}^p \Phi_j \mathbf{y}_{t-j} + \mathbf{u}_t - \sum_{j=1}^q \Theta_j \mathbf{u}_{t-j} + \sum_{j=0}^r \Gamma_j \mathbf{x}_{t-j}, \quad (19)$$

where  $\Gamma_j$  is an  $M \times J$  matrix with regression coefficients by which we predict  $\mathbf{y}_t$  from  $\mathbf{x}_{t-j}$ . Such models are particularly suited if we are interested in modeling  $\mathbf{y}_t$  and we know or expect it to depend on the  $x$ -variables, and we are not interested in how the  $y$ -variables influence  $\mathbf{x}_t$ , either because this is not our focus, or because it is theoretically impossible for  $\mathbf{x}_t$  to be affected by the  $y$ -variables. An example of the latter would be the effect of weather (e.g., temperature, amount of sunshine, amount of rain) on mood variables (e.g., positive and negative affect): Then the mood variables are modeled as a VARMA process with exogenous variables in the form of weather aspects. Note that if we have reason to believe the exogenous variables are in fact influenced by the other variables, we should turn to a VARMA model which contains all variables as  $y$ -variables.

A special case of the VARMAX model is formed by having  $M = 1$ , such that the outcome  $y_t$  is univariate. Such a model is referred to as an ARMAX model. Moreover, when time  $t$  (and/or polynomials of  $t$ ) are used as the exogenous variable (with  $r = 0$ ), this model becomes a multivariate extensions of the ARMA model with a

<sup>4</sup> One can model the trend and the VARMA relations at the same time using a VARMAX model discussed below, but the point made here remains the same: One is modelling the deviations from the deterministic trend (rather than the trend itself) as a function of another variable.

deterministic trend. Note however that the current presentation of the model corresponds to the representation in (10) rather than that in (9a) and (9b), which makes it difficult to interpret the regression coefficient(s) in  $\Gamma_0$ .

### *Latent VARMA Model*

The VARMA model can be extended to a model with multiple indicators measuring a reduced number of latent variables, which follow a VARMA process. Suppose we have a  $K$ -factor model with  $M$  observed variables. The factor loadings are restricted to be equal over time, such that the model can be represented as

$$\mathbf{y}_t = \boldsymbol{\mu} + \boldsymbol{\Lambda} \boldsymbol{\eta}_t + \mathbf{e}_t \tag{20}$$

where  $\boldsymbol{\mu}$  is an  $M$ -variate vector with means,  $\boldsymbol{\Lambda}$  is an  $M \times K$  matrix with factor loadings which do not depend on time,  $\boldsymbol{\eta}_t$  is a  $K$ -variate vector with latent variables at occasion  $t$ , and  $\mathbf{e}_t$  is an  $M$ -variate vector with measurement errors at occasion  $t$ . At the latent level, a VARMA model is specified, such that

$$\boldsymbol{\eta}_t = \boldsymbol{\Phi}_1 \boldsymbol{\eta}_{t-1} + \dots + \boldsymbol{\Phi}_p \boldsymbol{\eta}_{t-p} + \mathbf{u}_t - \boldsymbol{\Theta}_1 \mathbf{u}_{t-1} - \dots - \boldsymbol{\Theta}_q \mathbf{u}_{t-q} \tag{21}$$

where  $\boldsymbol{\Phi}$  and  $\boldsymbol{\Theta}$  are now  $K \times K$  matrices, and  $\mathbf{u}_t$  is a  $K$ -variate vector with innovations of this latent VARMA process. This model can be recognized as a special version of the more general dynamic factor model as discussed by Molenaar (1985). Moreover, when all the  $\boldsymbol{\Phi}$  and  $\boldsymbol{\Theta}$  matrices are zero matrices, this model becomes the P-technique model discussed by Cattell, Cattell, and Rhymer (1947). If  $q = 0$ , the model in Eqs. (20) and (21) reduces to a latent VAR ( $p$ ) model, which is also known as the direct autoregressive factor score model (Nesselroade, McArdle, Aggen, & Meyers, 2002). This model has been compared to the white noise factor score model (Nesselroade et al., 2002), which is also a special version of the more general dynamic factor model discussed by Molenaar (1985). Although the white noise factor score model can not be conceived of as an extension of the ARMA model (because the lagged relationships are not modeled in an ARMA manner, but by use of lagged factor loadings instead), there are situation in which the the white noise factor score model can be rotated into a direct autoregressive factor score model (Molenaar & Nesselroade, 2001). Moreover the latent VMA ( $q$ ) can be shown to be a special case of the white noise factor score model.

### *Cointegrated Model*

Cointegration (Engle & Granger, 1987) has proved one of the most successful discoveries in econometrics, and has earned its discoverers Robert Engle and Clive Granger the Noble Memorial Prize in 2003. A process is said to be cointegrated if

each of the univariate series are nonstationary (but is rendered stationary by differencing), while there is a linear combination of the series, which is stationary (Hamilton, 1994). If a process is cointegrated this implies that even though many developments can cause permanent changes in the univariate elements of  $\mathbf{y}_t$ , there is some long-run equilibrium which ties the individual components of  $\mathbf{y}_t$  together. This long-run equilibrium is represented by  $z_t = \mathbf{a}'\mathbf{y}_t$ , where  $z_t$  is a stationary, univariate process. The  $M$ -variate vector  $\mathbf{a}$  is referred to as the cointegrating vector. Since there is no unique vector that results in a stationary process (because multiplying all elements of the cointegrating vector with the same constant results in another cointegrating vector), some arbitrary normalization is chosen, such as fixing the first element of  $\mathbf{a}$  to one.

An example of a bivariate cointegrated process is given by

$$\begin{aligned}y_{1,t} &= \gamma y_{2,t} + u_{1,t} \\ y_{2,t} &= y_{2,t-1} + u_{2,t}.\end{aligned}$$

Note that  $y_{1,t} - \gamma y_{2,t} = u_{1,t}$ , which is by definition white noise. Thus, the cointegrating vector for this model is  $\mathbf{a}' = [1 - \gamma]$ .

In general it can be stated that if there are  $h$  series, there are at most  $h - 1$  cointegrating vectors. The more cointegrating vectors a system actually has, the more constrained its long term behavior is. An illuminating way to think about cointegration is to consider it from a geometric perspective (Dickey, Jansen, & Thornton, 1991). Suppose our system consists of three variables: The behavior of this system can be thought of as the movement of a point in three dimensional space  $R^3$ . If all three processes are stationary, the variability is bounded in all three directions, and the observations center around a point. This point can be thought of as the systems equilibrium, from which it never wanders too far. If all three variables are I (1) processes, but they are not cointegrated, this implies there is no restriction on the variability in any direction. Such a system is not characterized by any kind of equilibrium. If there is one cointegrating vector, then the plane that is perpendicular to this vector forms the equilibrium of the system. This implies that the variance in the plane is infinite (i.e., unbounded in two directions), but the variance around the plane is finite (i.e., bounded in one direction). This plane can be thought of as the system's equilibrium. If there are two cointegrating vectors, there are two perpendicular planes. The equilibrium of the system is formed by the line which forms the intersection of the two planes. Again, variance on this line is infinite (now unbounded in one direction), while the variance around the line is finite (now bounded in two directions). This shows that more cointegrating vectors imply more constrained behavior of the system in the long run. An illustration in  $R^2$  is given in Fig. 9.1.

Estimating and interpreting cointegrated models is not an easy task. This may give rise to the question: Why not difference the series (or detrend them by subtracting a deterministic trend), and determine whether there are relations between the residual parts? However, if the process is truly cointegrated, differencing the data would overlook the long-term dependencies (Hamilton, 1994).

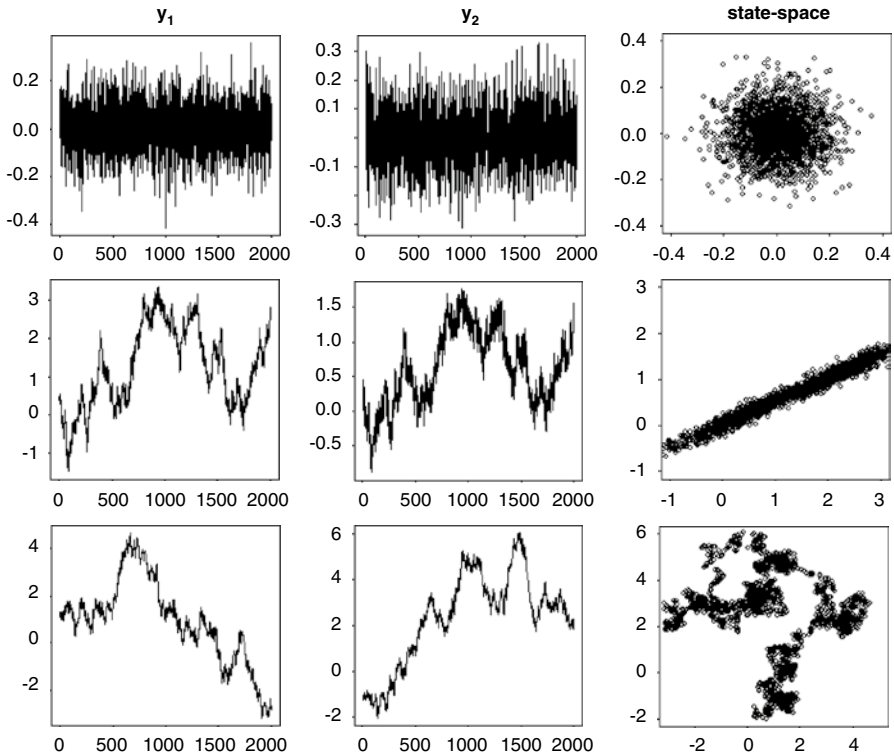

**Fig. 9.1** Plots of three bivariate time series: top panel contains two unrelated white noise processes; middle panel contains a cointegrated process; and bottom panel contains two integrated processes which are unrelated to each other. Last column contains the behavior of the bivariate series in  $R^2$ , where the axes are formed by the two variables. From this it is clear that the first process (which is stationary) has an equilibrium at  $\{0, 0\}$ . The cointegrated process has an equilibrium formed by the line in the plot on the right. The unrelated nonstationary process has no equilibrium

### *Applications in the Social Sciences*

An illustrative application of the VAR (1) model on psychological data can be found in Schmitz and Skinner (1993). They obtained time series data from five children on their effort, performance, subjective evaluation, and control regarding academic tasks in the class room. The authors concluded that the children differed greatly with respect to the relationships between these aspects. For instance, in one child there was no link between effort and performance, while in others this relation was quite strong. Similarly, some children were characterized by a strong link between subjective evaluation on one task and effort on the next, meaning that if they believed they had not performed well, they would try harder the next time (and vice versa), while in other children there was no such relationship.

An application of an ARMAX model (i.e., a VARMAX model with a univariate  $y_t$ ) can be found in Bollen and Philips (1982), who investigated whether highly



publicized suicide stories have an increasing effect on daily suicides. Exogenous variables included dummies for whether a highly publicized suicide had appeared on a particular day (i.e., that day, previous day, and so on up to ten days ago), day of the week, month, year, and certain holidays. Note that, with the exception of the first dummy, these dummies are an alternative way of controlling for seasonal effects. Bollen and Philips (1982) concluded that there were two peaks in suicides: at the same day and the next day, and again after six and seven days.

Applications of latent VAR (1) models can be found in Ferrer and Nesselroade (2003), Hamaker, Dolan, and Molenaar (2005), and Hamaker, Nesselroade, and Molenaar (2007). In Hamaker et al. (2005) daily affect measures based on the Five Factor Model (FFM) of personality are analyzed in an exploratory manner. That is, rather than to assume the FFM holds for the variability within individuals as well, it is investigated how many factors are needed for each individual separately. In addition, it is investigated whether there are lagged auto- and/or cross-regressive relationships between the latent variables. It was concluded that individuals differed in both the number and the nature of their intraindividual factors. In addition, some individuals were characterized by lagged relationships at the latent level, while others were not.

Ferrer and Nesselroade (2003) used daily measures of the positive and negative affect from married couple to investigate the reciprocal influences they had on each other. Using a latent VAR (2), they concluded that the wife was influenced by her own affect the preceding day, while the husband was influenced by his own affect the preceding two days. In addition, the wife's affect was influenced by the husband's negative affect at the preceding day, while the husband's positive affect had no effect. The husband was not affected by his wife's affect.

Although cointegration has had many applications in econometrics, only few applications in the social sciences exist. Lin and Brannigan (2003) used cointegration to investigate the relationship between crime and immigration between 1896 and 1940 in Canada. The authors concluded that there was no evidence for a long-term relationship between immigration and crime, with the exception of vagrancy and drunkenness. Stroe-Kunold and Werner (2008) used cointegration to model the interaction between activity, aggressiveness, and depression of a married couple on a day-to-day basis. In addition, the husband's skin symptoms were measured, and the wife's bulimic symptoms. They found some evidence for cointegration of a person's aggressiveness and the spouse's symptoms.

## **Nonlinear Extensions of the ARMA Model**

In this section several nonlinear extensions of the ARMA model are discussed, that is: (a) the bilinear (BL) model; (b) the heteroscedastic autoregressive (ARCH) model. (c) the threshold autoregressive (TAR) model; and (d) the Markov-switching autoregressive (MSAR) model.

### ***Bilinear (BL) Models***

The BL model was introduced by Granger and Andersen (1978), and consists of extending the ARMA ( $p, q$ ) model with product terms between previous observations and previous innovations. Such models are linear in  $y_t$  and in  $u_t$ , which explains the term bilinear. The BL ( $p, q, P, Q$ ) model is defined as

$$y_t = \sum_{j=1}^p \phi_j y_{t-j} + u_t - \sum_{j=1}^q \theta_j u_{t-j} + \sum_{j=1}^P \sum_{i=1}^Q v_{ji} y_{t-j} u_{t-i}. \tag{22}$$

As with many of the models discussed in this chapter, the BL model was suggested mainly to improve forecasting. Hence, applying this technique in the social sciences, where substantive interpretations may be of greater interest than prediction per se, may result in difficulties as it is not clear how the interactions should be interpreted from a substantive point of view. Moreover, Fan and Yao (2003) state that successful applications (in any field) of the BL model are rare, and they point out diverse unresolved issues regarding estimation and evaluation of the BL model. These issues taken together make it a less attractive candidate for social sciences researchers.

### ***Conditional Heteroscedastic Autoregressive (ARCH) Models***

ARCH models were proposed by Engle (1982) to handle volatility, a feature that is often associated with financial data. In contrast to the linear AR model, in which the focus is on predicting the observation  $y_t$  based on previous observations, ARCH modeling consists of predicting the variance of  $y_t$  (i.e., the variance in the prediction error  $u_t$ ), based on previous observations. Thus the term conditional heteroscedasticity refers to the varying variance which is conditional on previous observations.

Let  $\sigma_t$  be the variance of  $y_t$  at occasion  $t$ , and let  $z_t$  be a white noise sequence with mean zero and variance one. The ARCH ( $p$ ) model can be defined as

$$y_t = u_t = \sigma_t z_t \tag{23}$$

$$\sigma_t^2 = \phi_0 + \phi_1 y_{t-1}^2 + \dots + \phi_p y_{t-p}^2. \tag{24}$$

From this it is clear that the uncertainty in predicting  $y_t$  depends on  $y_{t-1}$  to  $y_{t-p}$ . This corresponds well with data characteristics in econometric practice, in which the ability to predict future observations often varies. Another interpretation of this model is that the heteroscedasticity is due to an omitted (i.e., unobserved) variable, in which case the ARCH model is a better approximation of reality than a linear ARMA model (Engle, 1982).

Although the predictive variance  $\sigma_t^2$  of an ARCH process varies over time, the variance itself is not a function of  $t$ . Hence, an ARCH process is stationary.

The ARCH model has been extended with moving average parts to the generalized ARCH (GARCH) model, for which it can be shown that  $y_t^2$  follows an ARMA process (Fan & Yao, 2003, p. 150). GARCH (1, 1) models have shown to be widely applicable in economics, while the ARCH models often require a very large  $p$  in order to fit well to empirical data.

These models could be useful in psychological research if for certain data it is known that there is heteroscedasticity over time. For instance, in the study of tics in Gilles de la Tourette discussed earlier (Peterson & Leckman, 1998), instead of measuring the time between the tics, one could also measure the amount of tics per interval: Because of the burst nature of such data, this is likely to result in heteroscedasticity, which could be modeled with a GARCH model.

### ***Threshold Autoregressive (TAR) Models***

Threshold models were introduced by Tong and Lim (1980). A TAR process consists of two or more AR processes, which can be thought of as representing separate regimes. The system switches between these regimes when the threshold variable passes a threshold. Suppose there are  $k$  regimes, and let  $z_{t-d}$  be the threshold variable with delay  $d$ , then a TAR( $k, p$ ) process is defined as

$$y_t = \sum_{j=1}^k \left\{ \phi_0^{(j)} + \phi_1^{(j)} y_{t-1} + \dots + \phi_p^{(j)} y_{t-p} + \sigma^{(j)} e_t \right\} I(z_{t-d} \in A_j), \quad (25)$$

where  $I(\cdot)$  is the indicator function (i.e., it equals one if  $z_{t-d}$  falls in  $A_j$  and it is zero otherwise), and the superscript ( $j$ ) identifies the regimes ( $j=1, \dots, k$ ). Typically  $A_j = (\tau_{j-1}, \tau_j]$ , with  $-\infty = \tau_0 < \tau_1 < \dots < \tau_k = \infty$ , where  $\tau$  to  $\tau_{k-1}$  are the thresholds of interest. Hence, if  $z_{t-d} \leq \tau_1$ ,  $y_t$  falls in regime 1, if  $\tau_1 < z_{t-d} \leq \tau_2$ ,  $y_t$  falls in regime 2, and so on. Since the regime-switching is independent of time, the process is stationary.

If  $y_t$  serves as its own threshold variable  $z_t$ , the model is referred to as a self-exciting TAR (SETAR) model. Such models imply a feedback loop, in which the system corrects itself when its behavior becomes too extreme. If another variable is used as the threshold variable, the model is referred to as an open-loop TAR system (TARSO; Tong & Lim, 1980). This implies that another variable controls the system. If two variables are generated by a TAR model, and each variable serves as the other's threshold parameter, this is referred to as a closed-loop TAR system (TARSC; Tong & Lim, 1980). Such TARSCs were used to model predator-prey data, in which an increase in prey population leads to an increase in predator population until some threshold is reached after which the prey population decreases which in turn leads to a decrease in prey population until another threshold is reached and there is an increase in predator population again (Fan & Yao, 2003).

Extensions of the basic model in Eq. (25) consist of including other (lagged) variables as predictors in the equation, and incorporating moving average terms

(De Gooijer, 1998; Tong, 2003). In addition, multivariate (vector) extensions of the TAR model have been developed (Koop, Pesaran, & Potter, 1996; Tsay, 1998). Further extensions consist of allowing for different orders of the AR processes in each regimes (De Gooijer, 2001).

### Markov Switching Autoregressive (MSAR) Models

Hamilton (1989) suggested a nonlinear extension of the AR model that is based on a hidden discrete Markov process. As with the TAR model, it is assumed the system switches between two or more regimes, and each regime is characterized by a different AR process. However, the process that triggers the switching differs between these two models. In TAR modeling the switching occurs when the threshold variable passes a threshold. In contrast, switching in MSAR models is triggered by a hidden discrete Markov process.

Suppose we have  $k$  distinct processes, or regimes between which our system switches. Let  $p_{ij}$  be the probability of switching to regime  $j$ , given that the system is in regime  $i$ , that is,  $p_{ij} = P[s_t = j | s_{t-1} = i]$ , where  $i = 1, \dots, k$  and  $j = 1, \dots, k$ . These transition probabilities can be gathered in a matrix,

$$p = \begin{bmatrix} p_{11} & p_{21} & \cdots & p_{k1} \\ p_{12} & p_{22} & \cdots & p_{k2} \\ \cdots & \cdots & \cdots & \cdots \\ p_{1k} & p_{2k} & \cdots & p_{kk} \end{bmatrix}. \tag{26}$$

Note that since  $\sum_{j=1}^k p_{ij} = 1$ , there are only  $k \times (k - 1)$  non-redundant parameters in this matrix. This matrix governs the Markov switching process  $s_t$ , which in turns underlies the regime switching in the MSAR process. The MSAR ( $k, p$ ) model can be expressed as

$$y_t = \sum_{j=1}^k \left\{ \phi_0^{(j)} + \phi_1^{(j)} y_{t-1} + \cdots + \phi_p^{(j)} y_{t-p} + \sigma^{(j)} e_t \right\} I(s_t = j), \tag{27}$$

where  $I(s_t = j)$  equals 1 if the system is in regime  $j$  at occasion  $t$ , and is 0 otherwise. Note that since the parameters in Eq. (26) are independent of time, the MSAR process is stationary.

Kim (1994) extended the work of Hamilton (1989) to the state-space model, such that it can be used for a wide range of time series models. Another useful extension was proposed by Durland and McCurdy (1994), which allows the transition from one regime to another to be duration-dependent. This means that the transition probabilities are not only conditional on the regime the system is in, but also on the amount of time already spent in that regime.

Another model that is related to the MSAR model is the mixture AR (MAR) (Frühwirth-Schnatter, 2006). In this model the observation is supposed to come from a mixture of AR processes. The MAR model can be thought of as a special case of the MSAR model, in which the transition probabilities are equal to the mixing proportions. That is, if  $\pi_j$  is the long-run probability of being in regime  $j$ , then  $P(s_t = j | s_{t-1} = i) = \pi_j$  for all  $j = 1, \dots, k$ . Hence, the probability of switching to regime  $j$  does not depend on the regime the system was in at the previous occasion, but only depends on the long-run probability of making an observation in regime  $j$ , such that it can be interpreted as the mixing proportion.

### *Applications in the Social Sciences*

The techniques discussed in this section have seen few—if any—applications in the social sciences. To our knowledge, neither the BL nor the ARCH model have been applied in the social sciences. TAR models have been used by Warren (2002; Warren, Hawkins, & Sprott, 2003) to model the behavior of sex offenders and alcohol abusers. They concluded that they could distinguish between periods of recovery versus periods of relapse. Recently, Hamaker, Zhang, and Van der Maas (in press) have shown that the models used by Gottman, Murray, Swanson, Tyson, and Swanson (2002) to model dyadic interaction are in fact TAR-based models. Regarding the MSAR model we are aware of just one application in the social sciences<sup>5</sup>, which consists of modeling the daily mood swings in a manic-depressive patient as a two-regime MSAR model (Hamaker, Grasman, & Kamphuis, in press).

### **Discussion**

The majority of studies in the social sciences qualify as nomothetic research, in which a large number of cases were measured on one or a few occasions, and the goal is to find relationships that can be generalized to the population from which the cases were sampled. Exceptions are found in sociology and criminology, where a substantial part of research deals with population aggregates, for instance, unemployment or crime rates, as discussed in this chapter. One could state that in these studies the population itself is dealt with as the single case, and the goal is to understand the process that unfolds at the level of the population.

Despite the dominance of the nomothetic approach in most branches of social science, there is a growing interest in idiographic techniques, as psychologists and

---

<sup>5</sup> A related technique, which is popular in speech recognition for instance, is the Hidden Markov model (HMM). The difference between the HMM and the MSAR model is that the former requires categorical observations, while the latter requires continuous observations. Moreover, while the MSAR model allows for autoregressive relationships between observations, the sequential dependency in the HMM is modelled exclusively by the hidden Markov process.

other researchers are coming to understand that the standard nomothetic approach presents only one side of the story (e.g., Borsboom, Mellenbergh, & Van Heerden, 2003; Hamaker et al., 2005; Molenaar, 2004; Nesselroade, 2001). The techniques and applications discussed in this chapter illustrate the potential of time series analysis for obtaining a more complete picture of processes that are studied in the social sciences. But even if one is not interested in embracing a fully idiographic approach to the matter, the models presented in this chapter can still be of use: There have been several extensions of ARMA-based models to handle multiple cases, making it compatible with the nomothetic approach. Roughly, we can distinguish between two ways in which the single-case models discussed in this chapter can be extended to handle multiple cases.

First, a straightforward extension consists of fixing the parameters across individuals. We refer to this as the fixed effect approach. Examples of this are the panel version of the VARMA model discussed by Du Toit and Browne (2001), the MI VARMA model discussed by Sivo (2001), and the MSAR model developed by Schmittmann, Dolan, and Van der Maas (2005). Second, a more sophisticated way of extending these models to include multiple cases are the multilevel extensions. For instance, Rovine and Walls (2006) extended the regular AR model in such a way that the AR parameter is random.

As indicated in the introduction, the focus in this chapter was on models for data measured at interval or ratio level, and at regular intervals. Clearly, many measurements in social sciences do not meet these criteria. Recently, Van Rijn (2008) proposed a technique for modeling AR models using ordinal data. Moreover, to model the sequential dependency in both ordinal and nominal data, one can make use of hidden Markov models.

To model measurements obtained at irregular time intervals, one can make use of models based on differential equations. In many diary studies for instance, the intervals between measurements are varied on purpose, to avoid the subject anticipating the next measurement. To model such data of multiple subjects, Oravecz, Tuerlinckx, and Vandekerckhove (in press) developed a multilevel model based on the Ohrnstein-Uhlenbeck process, which is the continuous-time variant of an AR (1) process. Besides having observations at irregular intervals, there are two other reasons for preferring differential equations rather than difference equations. First, Van der Maas and Raijmakers (2000) stressed the fact that while some processes may be understood best in discrete time, others take place in continuous time, warranting a differential equation approach. Second, using differential equations instead of difference equations has the advantage that, while difference equations lead to different results when the intervals change (e.g., daily versus weekly measurements), such arbitrarily evoked differences do not arise when differential equations are used (Oud, 2007). The latter exemplifies that the ARMA-based time series techniques discussed in this chapter form but one approach within idiographic analysis. That is, ARMA-based techniques are a specific branch within time series analysis, which in turn is just one of the possibilities for idiographic research. The aim of the present chapter was to provide an overview of ARMA-based models, and to demonstrate their potential for the social sciences.

**Acknowledgements** This work was supported by the Netherlands Organization for Scientific Research (NWO), VENI grant 451–05–012 awarded to Ellen L. Hamaker.

## References

- Andersson, G., Hågnebo, C., & Yardley, L. (1997). Stress and symptoms of Meniere's disease: A time-series analysis. *Journal of Psychosomatic Research*, *43*, 595–603.
- Andersson, G., & Yardley, L. (2000). Time-series analysis of the relationship between dizziness and stress. *Scandinavian Journal of Psychology*, *41*, 49–54.
- Bollen, K. A., & Philips, D. P. (1982). Imitative suicides: A national study of the effects of television news stories. *American Sociological Review*, *47*, 802–809.
- Borsboom, D., Mellenbergh, G. J., & Van Heerden, J. (2003). The theoretical status of latent variables. *Psychological Review*, *110*, 203–219.
- Box, G. E. P., & Jenkins, G. M. (1970). *Time series analysis: Forecasting and control*. San Francisco, CA: Holden-Day.
- Buck, R., & Morley, S. (2006). A daily process design of attention pain control strategies in the self-management of cancer pain. *European Journal of Pain*, *10*, 385–398.
- Bye, E. K. (2007). Alcohol and violence: Use of possible confounders in a time-series analysis. *Addiction*, *102*, 369–376.
- Cattell, R. B., Cattell, A. K. S., & Rhymer, R. D. (1947). P-technique demonstrated in determining psycho-physiological source traits in a normal individual. *Psychometrika*, *12*(4), 267–288.
- Chatfield, C. (2004). *The analysis of time series: An introduction* (6th ed.). London: Chapman and Hall.
- Cohan, C. L., & Cole, S. W. (2002). Life course transitions and natural disaster: Marriages, birth, and divorce following Hurricane Hugo. *Journal of Family Psychology*, *16*, 16–25.
- De Gooijer, J. G. (1998). On threshold moving-average models. *Journal of Time Series Analysis*, *19*, 1–18.
- De Gooijer, J. G. (2001). Cross-validation criteria for SETAR model selection. *Journal of Time Series Analysis*, *22*, 267–281.
- Delignières, D., Fortes, M., & Ninot, G. (2004). The fractal dynamics of self-esteem and physical self. *Nonlinear Dynamics in Psychology and Life Sciences*, *8*, 479–510.
- Dickey, D. A., Jansen, D. W., & Thornton, D. L. (1991). A primer on cointegration with an application to money and income. *Review: Federal Reserve Bank of St. Louis*, 58–78.
- Durbin, J., & Koopman, S. J. (2001). *Time series analysis by state space methods*. New York: Oxford University Press.
- Durland, J. M., & McCurdy, T. H. (1994). Duration-dependent transitions in a Markov model of U.S. GPN growth. *Journal of Business and Economic Statistics*, *12*, 279–288.
- Du Toit, S. H. C., & Browne, M. W. (2001). The covariance structure of a vector ARMA time series. In R. Cudeck, S. Du Toit, & D. Sörbom (Eds.), *Structural equation modeling: Present and future. A festschrift in honor of Karl Jöreskog* (pp. 279–314). Scientific Software International.
- Engle, R. F. (1982). Autoregressive conditional heteroskedasticity with estimates of the variance of the United Kingdom inflation. *Econometrica*, *50*, 987–1007.
- Engle, R. F., & Granger, C. W. J. (1987). Co-integration and error correction: Representation, estimation, and testing. *Econometrica*, *55*, 251–276.
- Fan, J., & Yao, Q. (2003). *Nonlinear time series: Nonparametric and parametric methods*. New York, NY: Springer-Verlag.
- Ferrer, E., & Nesselroade, J. (2003). Modeling affective processes in dyadic relations via dynamic factor analysis. *Emotion*, *3*, 344–360.
- Fortes, M., Delintnières, D., & Ninot, G. (2004). The dynamics of self-esteem and physical self: Between preservation and adaption. *Quality and Quantity*, *38*, 735–751.

- Frühwirth-Schnatter, S. (2006). *Finite mixture and Markov switching models*. New York, NY: Springer.
- Gottman, J. M., Murray, J. D., Swanson, C. C., Tyson, R., & Swanson, K. R. (2002). *The mathematics of marriage: Dynamic nonlinear models*. Cambridge, MA: MIT Press.
- Granger, C. W. J. (1980). Long memory relationships and the aggregation of dynamic models. *Journal of Econometrics*, *14*, 227–238.
- Granger, C. W. J., & Andersen, A. P. (1978). *An introduction to bilinear time series models*. Göttingen: Vandenhoeck und Ruprecht.
- Granger, C. W. J., & Ding, Z. (1996). Varieties of long memory models. *Journal of Econometrics*, *73*, 61–77.
- Granger, C. W. J., & Morris, M. J. (1976). Time series modelling and interpretation. *Journal of the Royal Statistical Society*, *139*, 246–257.
- Haker, H., Lauber, C., Malti, T., & Rössler, W. (2004). Is there an impact of global and local disasters on psychiatric inpatient admissions? *European Archive of Psychiatry and Clinical Neuroscience*, *254*, 330–334.
- Hamaker, E. L. (2005). Conditions for the equivalence of the autoregressive latent trajectory model and a latent growth curve model with autoregressive disturbances. *Sociological Methods and Research*, *33*, 404–418.
- Hamaker, E. L., Dolan, C. V., & Molenaar, P. C. M. (2003). ARMA-based SEM when the number of time points T exceeds the number of cases N: Raw data maximum likelihood. *Structural Equation Modeling*, *10*, 352–379.
- Hamaker, E. L., Dolan, C. V., & Molenaar, P. C. M. (2005). Statistical modeling of the individual: Rationale and application of multivariate time series analysis. *Multivariate Behavioral Research*, *40*, 207–233.
- Hamaker, E. L., Grasman, R. P. P., & Kamphuis, J.-H. (in press). Regime-switching models to study psychological processes. In P. C. M. Molenaar & K. Newell (Eds.). *Learning and development: Individual pathways of change*. Washington, DC: American Psychological Association.
- Hamaker, E. L., Nesselroade, J. R., & Molenaar, P. C. M. (2007). The integrated trait-state model. *Journal of Research in Personality*, *41*, 295–315.
- Hamaker, E. L., Zhang, Z., & Van der Maas, H. L. J. (in press). Using threshold autoregressive models to study dyadic interactions. *Psychometrika*.
- Hamilton, J. D. (1989). A new approach to the economic analysis of nonstationary time series and the business cycle. *Econometrica*, *57*, 357–384.
- Hamilton, J. D. (1994). *Time series analysis*. Princeton, NJ: Princeton University Press.
- Harvey, A. C. (1989). *Forecasting, structural time series models and the Kalman filter*. Cambridge: University Press.
- Hersen, M., & Barlow, D. H. (1976). *Single-case experimental designs: Strategies for studying behavior change*. New York, NY: Pergamon Press.
- Ichii, K. (1991). Measuring mutual causation: Effects of suicide news on suicides in Japan. *Social Science Research*, *20*, 188–195.
- Kim, C.-J. (1994). Dynamic linear models with Markov-switching. *Journal of Econometrics*, *60*, 1–22.
- Koop, G., Pesaran, M. H., & Potter, S. N. (1996). Impulse response analysis in nonlinear multivariate models. *Journal of Econometrics*, *74*, 119–147.
- Lin, Z., & Brannigan, A. (2003). Advances in the analysis of non-stationary time series: An illustration of cointegration and error correction methods in research on crime and immigration. *Quality and Quantity*, *37*, 151–168.
- McCleary, R., Hay, R. A., Meidinger, E. E., McDowall, D., & Land, K. C. (1980). *Applied time series analysis for the social sciences*. Beverly Hills, CA: Sage Publications.
- Molenaar, P. C. M. (1985). A dynamic factor model for the analysis of multivariate time series. *Psychometrika*, *50*, 181–202.
- Molenaar, P. C. M. (2004). A manifesto on psychology as idiographic science: Bringing the person back into scientific psychology—This time forever. *Measurement: Interdisciplinary Research and Perspectives*, *2*, 201–218.



- Molenaar, P. C. M., & Nesselroade, J. R. (2001). Rotation in the dynamic factor modeling of multivariate stationary time series. *Psychometrika*, *66*, 99–107.
- Nesselroade, J. R. (2001). Intraindividual variability in development within and between individuals. *European Psychologist*, *6*, 187–193.
- Nesselroade, J. R., McArdle, J. J., Aggen, S. H., & Meyers, J. M. (2002). Dynamic factor analysis models for representing process in multivariate time-series. In D. M. Moskowitz & S. L. Hershberger (Eds.), *Modeling intraindividual variability with repeated measures data: Methods and applications*. Mahwah, NJ: Lawrence Erlbaum Associations.
- Olfson, M., Marcus, S. C., & Druss, B. (2008). Effects of food and drug administration warnings on antidepressant use in a national sample. *Archives of General Psychiatry*, *65*, 94–101.
- Oravecz, Z., Tuerlinckx, F., & Vandekerckhove, J. (in press). A hierarchical Ornstein-Uhlenbeck model for continuous repeated measurement data. *Psychometrika*.
- Oud, J. H. L. (2007). Continuous time modeling of reciprocal relationships in the cross-lagged panel design. In S. M. Boker & M. J. Wenger (Eds.), *Data analytic techniques for dynamic systems in the social and behavioral sciences* (pp. 87–129). Mahwah, NJ: Lawrence Erlbaum Associates.
- Peterson, B. S., & Leckman, J. F. (1998). The temporal dynamics of tics in Gilles de la Tourette syndrome. *Biological Psychiatry*, *44*, 1337–1348.
- Razvodovsky, Y. E. (2007). Suicide and alcohol psychosis in Belarus 1970–2005. *Crisis: The Journal of Crisis Intervention and Suicide Prevention*, *28*, 61–66.
- Rovine, M. J., & Walls, T. A. (2006). Multilevel autoregressive modeling of interindividual differences in the stability of a process. In T. A. Walls & J. L. Schafer (Eds.), *Models for intensive longitudinal data*. New York, NY: Oxford University Press.
- Schmittmann, V. D., Dolan, C. V., & Van der Maas, H. L. J. (2005). Discrete latent Markov models for normally distributed response data. *Multivariate Behavioral Research*, *40*, 461–488.
- Schmitz, B., & Skinner, E. (1993). Perceived control, effort, and academic performance: Interindividual, intraindividual, and multivariate time-series analyses. *Journal of Personality and Social Psychology*, *64*, 1010–1028.
- Sivo, S. A. (2001). Multiple indicator stationary time series models. *Structural Equation Modeling*, *8*, 599–612.
- Stroe-Kunold, E., & Werner, J. (2008). Modeling human dynamics by means of cointegration methodology. *Methodology*, *4*, 113–131.
- Tong, H. (2001). A personal journey through time series in Biometrika. *Biometrika*, *88*, 195–218.
- Tong, H. (2003). *Non-linear time series: A dynamic system approach*. Oxford: Oxford Science Publications.
- Tong, H., & Lim, K. S. (1980). Threshold autoregression, limit cycles and cyclical data. *Journal of the Royal Statistical Society*, *B*, *42*, 245–292.
- Tsay, R. S. (1998). Testing and modeling multivariate threshold models. *Journal of the American Statistical Association*, *93*, 1188–1202.
- Van der Maas, H. L. J., & Raijmakers, M. E. J. (2000). A phase transition model for mother-child interaction: Comment on Olthof et al., 2000. *Infant and Child Development*, *9*, 75–83.
- Van Rijn, P. W. (2008). *Categorical time series in psychological measurement*. Ph.D. thesis, University of Amsterdam.
- Wagenmakers, E.-J., Farrell, S., & Ratcliff, R. (2004). Estimation and interpretation of  $1/f^a$  noise in human cognition. *Psychonomic Bulletin and Review*, *11*, 579–615.
- Warren, K. (2002). Thresholds and the abstinence violation effect: A nonlinear dynamic model of the behaviors of intellectually disabled sex offenders. *Journal of Interpersonal Violence*, *17* (1198–1217), 369–374.
- Warren, K., Hawkins, R. C., & Sprott, J. C. (2003). Substance abuse as a dynamical disease: Evidence and clinical implications of nonlinearity in a time series of daily alcohol consumption. *Addictive Behaviors*, *28*, 369–374.

# Chapter 10

## Depicting the Dynamics of Living the Life: The Trajectory Equifinality Model

Tatsuya Sato, Tomo Hidaka and Mari Fukuda

*The history of the organism is the organism. (Murray, 1938, p. 39)*

*The flow of the river never stops and yet the water never stays the same.*

*From “Hojoki: Written from a small square hut” (KAMO no Chomei, 1212)*

“Hojoki” is an essay written by and is famous in Japanese literature as an expression of mujō (無常), the transience of the world. The author—Kamo-no-Chomei (1155–1216)—was a monk who renounced the ordinary life in the then-capital Kyoto and lived his last years in simple huts in the countryside. He was one of the great critics and poets at that era. The notion of the flow of river that he evoked is suitable for considering the dynamic aspect of life. A river is a natural stream of water. Even though a river consists of water; the water within a river is never a river itself. And if the time were to stop—we would not be able to distinguish the water and the river.

The notion of the river is not at all simple. The boundary of river and land is vague and changeable. The status of river is vague—nothing would ever be forever. Nevertheless, this complication is a comfortable as a metaphor of life. If we take the systemic view in psychology and we regard human being as the open system, the subject of study is not a discrete individual, but a relationship with the environment. And the boundary of the subject and environment is not so clear. The time flow never goes back with in life—yet the representation of time has many variations (see Yamada & Kato, 2006). In this chapter, we try to show the new notion and methodology for depicting the dynamics of the living and to detect obstacles of depicting the dynamics. We re-consider the life stage theory, the life course paradigm, and the methodology of rating scale, because these seems to be the obstacles to pursue understanding the dynamics of the living.

---

T. Sato (✉)  
Department of Psychology  
Ritsumeikan University  
Kyoto 6038577, Japan  
e-mail: satotster@gmail.com

The study of a life course cannot exist without the notion of time. But psychologists and sociologists don't take the notion of time seriously. One of the reasons why they tend to disregard time is that their desire is to seek a depiction that focuses on stability. Actually many of them might "find" the stable structure of personality and stable trail of life course as they construct it through data analyses that are blind to variability and dynamicity. This aspiration leads to the correlational studies. For example, psychologists often like to do research to find the correlation between some biological factors and personality—while ignoring the factors of culture. This is a very attractive seduction for personality psychologists because they have an inferiority complex in their relation with what they construe as "the truly natural" sciences. In fact to do appropriate science, both stability and/or structure are very important for psychologists and sociologists.

Changes are not too complicated. If psychologists abandoned their dreams of revealing a time-free "true state" of affairs and started considering time seriously, we would easily find another possibility. The Trajectory Equifinality Model (TEM) which we describe in this chapter is a new methodological device for psychology. It is based on the systemic view and takes the notion of irreversible time seriously.

## Obstacles in Treating the Dynamics of the Living in Psychology and Sociology

Differently from Kamo's Heraclitan idea as expressed in the beginning of this chapter, the historiography in the European tradition—especially the usual focus on Ancient Greece—seems to adjust its mode of thinking to the stable ways where thoughts treated as analogs to the classical Greek architecture. Such stability leads psychologists to build stage models of life course development. In contrast, historiography in Japan seems to assimilate the notion of the flow of the river—nothing would ever be forever.

Stage theories entail the idea that when we develop, we go through a number of states that can be described as temporarily homogeneous. This is similar to constructing the building in the main view of history in Western culture. There are many eminent stage theories in psychology. Among them, Freud's Psychosexual stage theory, Piaget's stage theory of a child's thinking, Kohlberg's stage theory of moral values, Winnicott's development stages, Erikson's developmental stage theory of learning self-esteem and trust. For example, Freud took seriously the psycho-sexual energy and hypothesized psychosexual stage theory (Table 10.1).

**Table 10.1** Freud's psychosexual stage theory

Oral stage	from birth to 18 months
Anal stage	from about 18 months to 3 years
Phallic stage	from 3 to 6 years
A period of latency	from 6 to 12 years
Genital phase	from 12 years onwards

**Table 10.2** Erikson’s eight stages and its tasks

Infancy	Trust vs. Mistrust
Toddler	Autonomy vs. Shame and doubt
Preschool	Initiative vs. Guilt
School age	Industry vs. Inferiority
Adolescence	Identity vs. Role confusion
Young adult	Intimacy vs. Isolation
Midlife	Generativity vs. Stagnation
Old age	Ego integrity vs. Despair

After observation of children in many times and places, Piaget posited that 4 stages of cognitive development. Sensorimotor Period (birth to 2 years); Pre-operational Thought (2 to 6 or 7 years); Concrete Operations (6/7 to 11/12) and Formal Operations (11/12 to adult). In a similar vein, Erikson posited his stage account (Table 10.2).

Kohlberg developed a three-level six-stage model of moral development, where each level is broken down into with two stages (Table 10.3).

Even though stage models theorists might insist that they treat the time with in their models, the time within the stage model seems to be discrete. Stage models depend on chronological age—which means the superiority of biological factors is implied.

Maslow’s (1943) ‘hierarchy of needs’ model seems to avoid such tendency. Differently from the usual way of psychologists to study mentally ill or neurotic people, Maslow looked at exceptional people such as Albert Einstein and Eleanor Roosevelt. But, Maslow’s model carries with it an ideal value system and retains in a linear progressive model. Both stage model and hierarchy model do not regard the flow and continuity of life as important.

### *Life Course Studies and the Notion of Life Trajectory*

In life course studies we can find a contextual view of trajectories:

The life course is age-graded through institutions and social structures, and it is embedded in relationships that constrain and support behavior—Both the individual life course and a person’s developmental trajectory are interconnected with the lives and development of others. (Elder, 1998, pp. 951–952).

**Table 10.3** Kohlberg’s six-stage model of moral development

Level 1	Pre-conventional
Stage 1	PUNISHMENT AND OBEDIENCE Heteronomous morality
Stage 2	INSTRUMENTAL EXCHANGE Individualism/instrumentalism
Level 2	Conventional
Stage 3	INTERPERSONAL CONFORMITY Mutual interpersonal
Stage 4	Social system and conscience
Level 3	Post-conventional
Stage 5	PRIOR RIGHTS AND SOCIAL CONTRACT
Stage 6	UNIVERSAL ETHICAL PRINCIPLES

All of the core principles of life course theory have special application to this transition to lifelong development and aging, the role of human agency in making life choices, the constraints and opportunities of the historical time and place, the timing of events and transitions, and the forming and dissolution of linked lives (Elder, 1985; Daaleman & Elder, 2007). Five core principles define the life course as a paradigmatic framework:

1. human development and aging as lifelong processes,
2. human agency,
3. historical time and place,
4. the timing of events in a life, and
5. linked lives.

However, when we look at the empirical uses of the “trajectory” in life course studies we discover that it means just a “pathway”. It describes a path of the life lived—but not the dynamics of moving towards the future. Macmillan and Eliason (2003) pointed out that trajectories often referred to long-term involvement in or connection to social institutions and corresponding role. For example, McQuellon et al. (1998) tried to “measure” the trajectory of psychosocial recovery over the first year after bone marrow transplantation (BMT). BMT patients were assessed by many scales—including physical functioning, mood etc—at four times, namely, baseline (n = 86), hospital discharge (n = 74), 100 days (n = 64) and at 1-year (n = 45). And authors found that the recovery trajectory in this patient population showed three distinct trends. These were, (1) linear and improved over time, (2) the trend for overall quality of life was parabolic (worsening at discharge, then improving), (3) the trend for patient concerns over time was linear and worsening.

A trajectory is considered to be the stable component of a direction toward a life destination and is characterized by a given probability of occurrence. A trajectory refers to the tendency to persist in life course patterns (Wheaton & Gotlib, 1997, p. 2). The notion of a life trajectory might be likened to that of a canal. And though the notion of life trajectory allow to change or shift from the established trajectory, it might lead to the feeling of ‘life on concrete (non-fragile) track’. Even though Lerner and Busch-Rossnagel (1981) emphasized the individuals’ subjective aspect—in their words, individuals are producers of their development, the researches in sociology of life course tends to prefer to the statistics-based longitudinal analyses in which the dynamism of life course is only assessed the point researchers set, so dynamics of living tends to be easily eliminated.

### ***Can Structural Equation Models (SEM) Reflect the Dynamism of Development?***

The life course studies tend to use the correlational efficient. Even they use more complicated technique like the structural equation models (SEM), the basic nature of such models has not changed. Because SEM fully depends on the correlation

coefficients as input data—and such dependence conceals both the dynamic and qualitative aspects of the phenomena. Historically speaking, the notion of the correlation was invented to measure the *degree* to which the two variables are *linearly* related. Sir Francis Galton developed the idea that Karl Pearson further elaborated mathematically and invented the formula on the calculation of the correlation coefficient now named after him. Because these two eminent statisticians intended to verify the power of heredity, that coefficient was designed to grasp only the stability, not variability, of the relationship between two variables. Even as the result of calculation of correlation coefficient is based on each variable's variability, the result is interpreted as if it pertains to the essential relations between the qualities implicated by the “variables.”

### ***Assigning Numbers—Creating Static Properties—And Scale Types***

The problems begin even earlier than the calculations of correlational relations. Already at the moment of psychologists' quantification of qualitative phenomena—an act of signification in semiotic terms—the question of what kind of scales are implied is crucial. Scale properties are important. In his seminal paper, Stevens (1946) proposed four levels—scale types—of measurement: nominal (or categorical); ordinal; interval; and ratio. The latter two are combined as continuous variables. He proposed the hierarchy of measurement scales for psychophysics. Although this idea has been criticized by statisticians, it still remains a core organizational framework for quantification in today's psychology. Importantly, the four levels measurement are not convertible in a symmetric way. A number created at the ratio scale level can be converted “down” to interval level and to the ordinal level. But the reverse is not possible—an ordinal level number cannot be converted “up” to the ratio scale level. Five years later, Stevens (1951) proposed the “permissible” mathematical operations for each type of scale—nominal, ordinal, interval and ratio. However, Stevens's proposal has been watered down—the scale types are regularly treated as if they were upwardly convertible—ordinal scale data are analyzed like ratio scale data.

Once a number becomes assigned to a phenomenon, psychologists move to operate with numbers as if these were meaningful. All numbers in psychology calculated in any imaginable way—usually on the basis of convenience of statistical analyses packages rather than honoring their representative meanings. This fits the master narrative of measurement in psychology—psychology tends to use statistics to disguise its discipline as scientific. To continue this disguise, substantiation of “mind” is inevitably needed. And the construct of psychology such as self, personality and many other characteristics are a priori regarded as substantive and stable. As Peter Callero has pointed out:

... There is a tendency [in mainstream psychology] to focus on stability, unity, and conformity and de-emphasize the sociological principles of social construction. The self that is socially constructed may congeal around a relatively stable set of cultural meanings, but these meanings can never be permanent or unchanging. (Callero, 2003, p. 127)

The easy way of number assignment in empirical studies of psychology and sociology entails the politics of rating scale. It profoundly dominates the act of creating stable constructs through methods created to “measure” them. While focusing on such static constructs, efforts to reconstruct underlying processes which are involved in the rating scale has fragile foundations.

Even research on life trajectory study addicting the correlational coefficient might be unknowingly embedded in creating unrealistic knowledge. On one hand there is a pre-set theory-driven explanation (e.g., a stage theory) that is treated as a given. On the other hand there is the empirical correlational paradigm which turns variability into stability displays. Both theory-driven nature and using the rating scale strategy lead it to a scientific-like but fragmented view of human beings. It is a reductionist view. It’s high time to overcome reductionist perspectives—hence a new vision of trajectory is needed. We need another way to access the dynamism of life trajectory and such new methodology needs to grasp the change (not stability) and emphasize the cultural meanings as Callero (2003) insisted.

We propose the new notion of trajectory as a combination of vectors that represent co-existing directions of psychological orientations. A vector is described both by size and direction—so that vectors might express different tendencies and their relationship, and the combination of vectors might be suitable to depict the movements along the life trajectory. But before we step forward, let’s look back one of major dispute on the credibility of quantitative studies.

### ***The Person-Situation Debate, and Beyond***

Personality psychology is inherently embedded in the closed systemic view. And the personality theory is the fuel tank of non-dynamic view using correlational coefficient method. Once personality psychology had a chance to transform, but it didn’t. Here we take a brief look at the debate in personality psychology. A diagnostic measurement system is a lens that actually obscures the dynamics of living one’s life.

Personality psychology, developmental psychology and clinical psychology have failed to develop in the direction of the dynamic and idiographic psychology. In psychology, both time-conscious and dynamic (not psychodynamic) view of life are rare. Personality psychology, developmental psychology and clinical psychology would be in a position to treat human life as a whole and depict dynamic transformation within time. But all projects have been

... as soon as a psychologist reject the idea of closed-systems of psychological phenomena and accepts an open-systems viewpoint, his treatment of the time dimension in psychological research would change. (Valsiner, 1986, p. 352)

Walter Mischel (1968)’s *Personality and Assessment* changed the quality of discussion on personality studies. As Hermans and Bonarius (1991) pointed out, this publication is of particular historical significance in personality psychology. Mischel (1968) transformed discussion on the personality and the debate between personality psychologists and Mischel has been called “person-situation debate”.

Mischel's perspective was influenced by social behaviorism of his time—as he insisted on the role of situation, claiming that situational determinants accounted for more of the behavioral variance than individual differences did. So “situationism” is the best label of his position. The illusion of cross-situational consistency might be revealed as myth. Over-time stability is supported by the similarity of situation. Person tends to select the preferable situations. During the debate, typology, trait theory and psycho dynamism found the situationism as their common enemy. Not surprisingly many objections to Mischel's claim emerged from various points of view. Idiographic approaches and the focus on the life story analyses were among them. Yet these were not direct objection to Mischel's claim—in their core they actually accepted the central core of it.

After the debate, a new frame of personality theory has emerged. Ironically speaking, situationism fosters the integration of psychodynamic theory, trait theory and typology which were all attacked by Mischel (1968). New type of personality theories have eclectically created in the personality related area. New theoretical frame fully depends on a multivariate statistical methodology. One of such a new trend is called the “Big Five” (Goldberg, 1990). One of the representative models of “Big Five” is the OCEAN Model (McCrae & Costa, 1996) which propose five factors including O: Openness to experience, C: Conscientiousness, E: Extraversion, A: Agreeableness and N: Neuroticism. Another theoretical frame is a personality disorder diagnostic system included within the DSM-system. Many personality disorders appear and vanish with hundreds of multidimensional studies.

Even Mischel's claim might directly attack the cross situational consistency and over time stability of personality studies, his claims were supposed to doubt the way of method which are based on correlational coefficients. So relying on the new statistical technique also based on the correlational coefficient (that means SEM) in personality study is no other than the return which longs for cross situational consistency. Furthermore, trajectory focused study in life course study is also based on the correlational coefficient so this is no other than the reversion which blindly take seriously the over time stability.

Recently, McAdams and Pals (2006) tried to release the definition of personality from the old-fashioned “personality as an entity”. They defined personality as an individual's unique variation on

1. the general evolutionary design for human nature, expressed as a developing pattern of
2. dispositional traits (the person as actor),
3. characteristic adaptations (the person as agent), and
4. integrative life stories (the person as author) complexly and differentially situated in
5. culture.

From the perspective of cultural psychology, the latter three are enough.

The new look at personality gets rid of the trait concept. Traits—as well as linear and bipolar dimensions—never grasp the transformation of personality. In the “new Big Five” of McAdams and Pals (2006), they didn't refer to the over time stability



of personality based on the rating scale. If they stuck to the notion of over time stability, they were obliged to treat the life course study and it became ruined. Here we find it’s time to seek the new type of both theoretical and practical scheme for “dynamics of the living”.

### Rethinking the Rating Scale: Toward the New Views of Trajectory

Common language terms are usually represented as point-like. A word—“a bird”—despite its various nuances of sense, ranging from anatomical referencing to poetic overgeneralization—is still represented in our speaking or writing by the same form “bird” in a point-like fashion (Abbey & Valsiner, 2004). In case of a point, there is no direction. Vectors have direction and size. But vectors do not cross each other. Vectors are just orientations in some direction. They are not depicting the actual course of development of trajectories, which are essentially combinations of vectors. They depict the development. Vectors are time-free (Table 10.4).

Psychologists who want to measure mental state use the point-scale measurement. It, point-scale, is located within the realm of point. In personality tests, intelligence tests, all questionnaires where you quantify some of the data, time-less and direction-less score is produced. Calculated number has serial order. Increasing and decreasing on the uni-dimensional static scale can be expressed. So point scale orientated research couldn’t express the transformation.

Vector models are hybrids of point models and trajectory models. Point models are quantifiable. Vector models can use quantification in estimating vector size. But at the same time they are richer because they use direction which is not quantifiable. You can say how big or how long this vector is but you cannot quantify which way it is oriented. Kurt Lewin wanted to construe field psychology which included vector psychology. But the title of Lewin (1943) paper *Defining the “Field at a Given Time”* well reflects his interest is mainly in the field—and not time. It was after the publication of Frank’s (1939) cultural–philosophical article on ‘time perspectives’, Lewin adopted the term (Nuttin & Lens, 1985). He defined it as “the totality of the individual’s views of his psychological future and his psychological past existing at a given time” (Lewin, 1952, p. 75). He pointed out the children’s narrowness of time-perspective in here and now life space. We can learn from Lewin that vector is suitable for applying the study of space and/or field not for time. So we adopt the different concept of *trajectory* to go step further. The notion of trajectory has been used in life course research—based on correlational relations across time.

**Table 10.4** Point, vector and trajectory on psychological depiction

	Size	Direction	Time
Point	No	No	No
Vector	Yes	Yes	No
Trajectory	Yes	Yes	Yes

Here we change the meaning of it by comparing with the notion of point and vector. How can one reach the trajectory model from the point model? Imagine someone is asked to rate the life satisfaction on the 7-point rating scale.

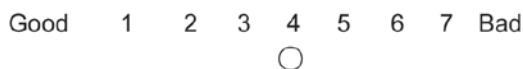

The circle on 4 reflects “so-so satisfaction” of the rater. If we are allowed to superimpose (add) the arrow of vector around the score, that makes us understand a little clear.

Someone might depict a trajectory including circle and vectors like this.



The number rated “4” is reached through different directions. This is the simplest trajectory model. Another might depict a trajectory including circle and vectors like this.

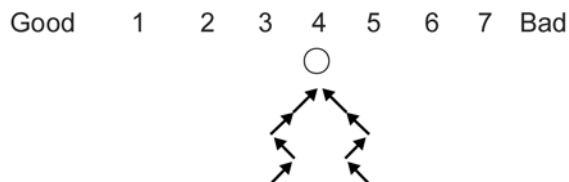

This is just the model of trajectory and we can find an equifinality point; to which real and possible trajectory would reach.

Returning to the problem of longitudinal life course studies using psychological scales, the repeated administration of scales only interpret the number on the uni-dimensional scale. The score might be compared on the dimension of number. But comparison such as this ignores the uniqueness of each person’s trajectory (history). Not a score but a trajectory should be recognized if a person is considered as an active, goals-oriented agent. The number observed in a scale is depiction of outcome—while the trajectory is depiction of the process.

Knowing the process make you see what outcome is/can be generated—and not the other way round—from the outcome you cannot reconstruct the process. The point model asks direct questions about phenomena that underlie the “measures”—such as—“what is the ‘*true state*’ of life satisfaction?” This question is impossible in case the vector model is assumed—it would create a method where you are put into some ambivalent situation about being satisfied and observe the *direction of further movement* from that situation. However, the vector model does not provide a developmental and/or historical look on the life satisfaction—since the vector consists of time-based unfolding of sequence of outcomes. A vector is detected by at least two points in some sequence in a space of coordinates.

Developmental and/or historical look need the trajectory model. And trajectory model gives us an enhanced opportunity to explore the complex life history. Surely we agree that trajectories are considered in life-course sociology—yet there they are treated as vectors discovered after the fact, in a retrospect on the life course past. Yet human lives are lived from the known onwards to the not yet known. The methodology of TEM allows us to look at potential and/or unrealized trajectories of both the past and of the possible future. Furthermore, it allows a conceptualization of how the trajectories are in the process of construction.

## Considering Trajectories-in-the-Making

### *TEM: Making the Past, Creating the Future*

The Trajectory Equifinality Model (TEM) grows out of the theoretical need of contemporary science to maintain two central features in its analytic scheme—time, and (linked with it)—the transformation of potentialities into actualities (realization). We should start from deductive viewpoint. Of course each person's life trajectory is idiosyncratic. Here is the place where the notion of “abduction” is truly needed. Charles S. Peirce (1908) advocated the importance of abduction as a method of inference in addition to the traditional ones, i.e., deduction and induction. He emphasized that neither Deduction nor Induction contribute the smallest positive item to the final conclusion of the inquiry—all that is done by abduction. TEM depends on systemic view and the view has a greater affinity for the Oriental “inclusive separation”—it is an example of anti-dichotomy logic. It's not a uni-linear process but multi-linear process. TEM can easily depict the variation of trajectories.

Dynamism is expressed by the depicting the social power. Even if there were many alternative options, person wouldn't choose some options. TEM is the hypothetical model of trajectories to a similar experience of equifinality which researchers focused on. TEM depicted from the empirical data might reflect a real abductive inference. TEM is neither the result of inference and nor the result of empirical testing. Such attitude may resonate with the efficiency of model notion by Bruner (1986). He stressed that schema and mental models provide meaning and organization to experiences and allows the individual to “go beyond the information given”.

The term *equifinality* is widely known due to Ludwig von Bertalanffy who is the founder of General Systems Theory (Bertalanffy, 1968). We have created a new method on the basis of this notion (Sato, Yasuda, & Kido, 2004; Valsiner & Sato, 2006; Sato, 2007; Sato, Yasuda et al. 2007; Sato, 2009). Sato, Yasuda et al. (2007) emphasized that equifinality does not imply sameness—which is an impossible condition in any historical system. Rather, it entails a region of similarity in the temporal courses of *different trajectories*. The notions of equifinality and trajectory are highly *trans*-related. Simply speaking, TEM is the method to describe persons' life courses within irreversible time after researchers' focusing important events as EFPs. After establishing the equifinality point, trajectories should be traced.

**Fig. 10.1** Multilinearity of trajectories (modified after Valsiner, 2001, p. 62)

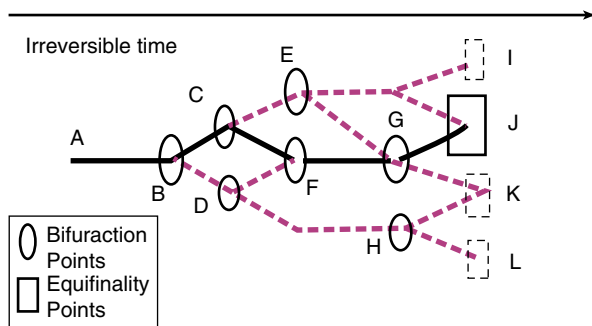

Depicting the TEM makes it possible to grasp the trajectory with irreversible time (Fig. 10.1).

The rectangle J is the supposed equifinality point (EFP) on what researchers focus on in their researches. For this EFP, there are many pathways to pass. Seven ellipses, indicated alphabetically as “B through H”, are passage points and many of them have options to go. We call the passage point which has an option as “bifurcation point (BFP)” in this TEM, and have proposed some notions for practicing TEM to construct model (Valsiner, 2001; Valsiner & Sato, 2006; Sato et al., 2007).

### ***Basic Notions of TEM***

*TEM and HSS.* The history of TEM is inter-dependent on the sampling methodology named the *Historically Structured Sampling* (HSS). It is developed in contrast to random sampling—which is highly recommended in psychology because of its apparent “fairness” (randomness). There is a paradox in the use of “random sampling”—it is needed because individual human beings are not homogeneous. As a famous statistician of his day, McNemar (1940, p. 331) insisted that “a large amount of psychological research must depend upon sampling for the simple reason that human variation exists”. McNemar regarded the human variation as an “error”—a deviance from the “true value”. His view had a lack of historical thinking. He really ignored the historicity of human lives. Human variation is the result of life course of each person and it is not timeless phenomena but time-dependent phenomena.

How should we consider the problem of sampling? If the theoretical implications of TEM are taken as the starting point, then HSS is the necessary sampling tactic to use for the study (Valsiner, 2009). We introduced that concept as a counterpoint to the non-systemic practice of “random sampling” and its less random analogs (Valsiner & Sato, 2006; Sato et al., 2007). This methodology of “random sampling” focuses on persons just because they are assumed to consist of a selected variety of features labeled “variables” (Sato, Watanabe, & Omi, 2007). HSS focuses on the lived experience of any person within the irreversible time. Here, the lived experience should be regarded as true open-systemic phenomena. And all lived experi-

ence is embedded in specific time and place, namely culture. Personality is not a “dependent variable” for the lived experience, but an open-systemic phenomenon.

Thus, the new sampling method should reflect both real life courses and researchers’ research questions. We call this new methodology as historically structured sampling (HSS). The notion of HSS entails a radical move from other accepted methods of sampling—random sampling being the most glorified—to a version of non-random sampling of individual cases (Sato, 2007). From the viewpoint of sampling philosophy and technique, the procedure of HSS consists of “equifinality sampling” i.e., the equifinality point which researchers have an interest is the experience to focus on.

*Equifinality and Trajectories.* Equifinality is the principle that in open systems a given end state can be reached by many potential means. It emphasizes that the same end state may be achieved through many different means, paths and trajectories. Variability of trajectories means richness of life. So the very first place of the conceptual adventure, equifinality and trajectories are highly intertwined with each other.

Bertalanffy preferred *equifinality* better than “goal”, equifinality isn’t the dead-end like goal point. When the EFP has reached, EFP transforms to a new point to newly emerged finality. Actually, from the view point of research methodology, EFP is the focus point of focus (Y) that allows the different trajectories (1,2,3) to be charted out (Fig. 10.2).

*Polarized EFP.* Since EFP depends on the researchers focus and/or research questions, EFP only shows one aspect of phenomena. We need to show some kind of complement set of EFP. So we set up polarized EFP (PEFP) for neutralizing implicit value system of researchers. Excerpt from Yasuda (2005)’s study, she approached the infertile experiences of married women in Japan looking at their reconstructed histories of moving between the PFEPs containing “having children” and “not having children” as the two opposites within the same whole. Both having children and having no children should be considered as equivalent equifinality points.

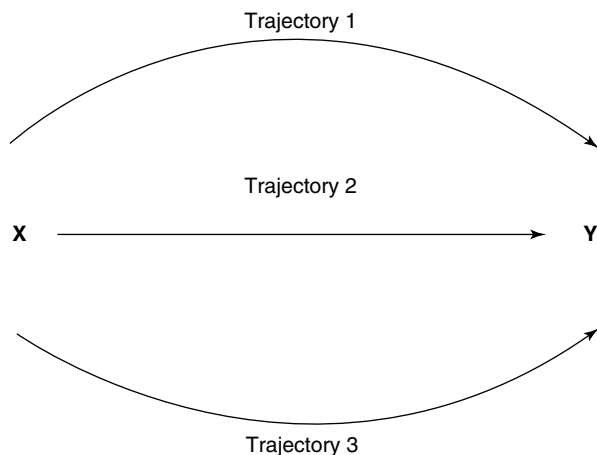
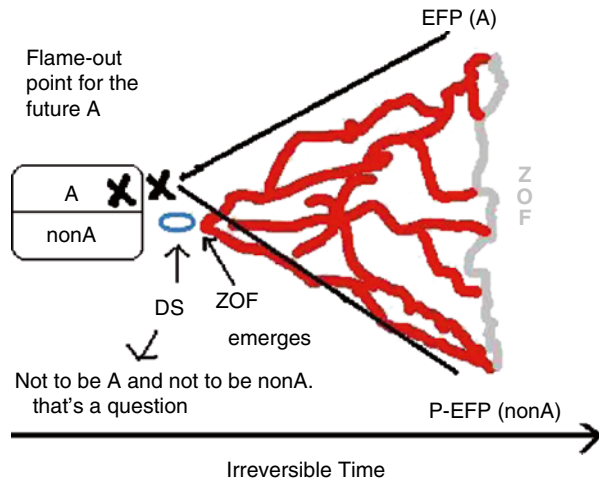

**Fig. 10.2** Equifinality point as a result of three trajectories

*Irreversible Time.* Under the influence of Bergson’s philosophy, Valsiner (1999) insisted that the irreversibility of time is an absolute given for the study of all living phenomena. Irreversible time is the characteristic of real time never to repeat any happening of the previous time period. Time flows from an infinite past towards an infinite future. We don’t intend to refer the representation of time. We try to put the basic feature of time into our model. Even if we felt we do same things, time might pass. There is no timeless repetition, we pose.

*BFP and OPP.* Bifurcation point (BFP) is a point which has alternative options to go. Obligatory passage point (OPP) is a concept originally emerged in the context of the geopolitical term (Latour, 1987). For example, the Strait of Gibraltar is the strait that connects the Atlantic Ocean to the Mediterranean Sea. So we can say that the Strait of Gibraltar is the OPP from the Atlantic Ocean to the Mediterranean Sea, and vice versa. Converting it in the context of TEM, OPP means a phase and/or event persons inevitably experience through initial condition to EFP.

*Multifinality and ZoF.* Multifinality simply implies the multiple-ness of finality. But in the meaning sphere of TEM. It is used for finality after EFP. This means that multifinality refers to various pathways and finality from the same beginning point. In the context of TEM, multifinality implies the diversity after the points of EFP or polarized-EFP. And the different view point, EFP is set by researchers. Even researchers might focus on the EFP from their own research interest, each participant has their own life and finality (aim and/or goal). In their paper on the prevention of HIV/AIDS, Mitchell, Kaufman, and Beals (2004) showed the utility of focusing the variation, they examined multifinality (looking prospectively) and equifinality (looking retrospectively) to identify both normative and less common combinations of risk/protective configurations. We use the *multifinality point* when the finality after EFP is clear. But if not, we use the term *Zone of Finality* (ZoF- Fig. 10.3). Zone of Finality (ZoF) is the finality of participants after the EFP. EFP derives from the researchers’ insight rather than participants’ landscape of the aim and/or goal. ZoF might compensate the complacency of researchers. The reason



**Fig. 10.3** Zone of Finality (ZoF)

we use the ZoF in place of multifinality is that the future perspective might be ambiguous itself.

*Social Direction and Social Guidance.* The focus on social direction derives the notion of directed social cultural power. It might be said that the “common sense” provides tradition, social norm and social pressure. On the other hand SG is the power of defense against the social direction. SG is the power supplied from the intimate persons such as a family, friends, teacher and others. Simply speaking, SD is defined as the power of inhibition to go to EFP, and SG is defined as the power of promotion to go to EFP.

*Transformation of an Open System.* TEM is a tool for depicting both real and imaginary trajectories to equifinality points and it doesn’t include the tool of depicting the state of each person as an open system on a trajectory. An open system sometimes transforms and almost maintains it. We consider that maintaining is the form of transforming. To trans-form implies changing of form, i.e., some form of the previous kind turns into a new form (Fig. 10.4). So the number generated by quantitative measures cannot depict the whole process of transformation.

Transformation involves something becoming something else. That is one aspect of development. Whatever is there before becomes transformed into something else. Secondly, whatever is there before maintains itself. So also that maintenance, the steady state of developing organism is also developmental phenomenon. This will be particularly crucial in autism. Autism is a domain of very slow development. You have to wait for a long time and for very good circumstances when the autistic child would break out of the cycle of autism.

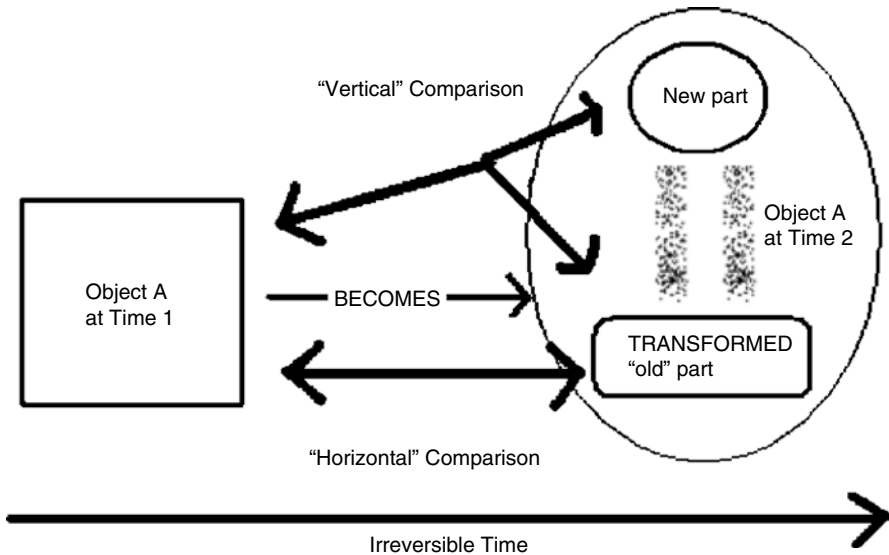

Fig. 10.4 Transformation of form (modified after Valsiner, 2001)

## *Empirical Studies for Depicting Dynamics with TEM*

Because the methodology of TEM has only a brief history, there are not so many studies using TEM till today. But we can show a list of leading TEM studies.

Life events studied with using TEM are neither abstract experience nor abstract psychological process. These are the lived experience embedded in culture within irreversible time (Table 10.5). For example, abortion is a highly cultural-historically values-laden event. Some cultures never allow the abortion today. In Japan the abortion operation is restricted before 22-week gestation today but was allowed 8-month before. Similarly, becoming psychologists in Estonia in 2000s (Kullasepp, 2006) may be different from becoming one in other country. And again, aiming to get married in Japan in 1980s (Tanimura, Sato, & Tsuchida, 2008) are desperately different experiences of Japanese women in 21st century. All these are dramatic real-life experiences. Yet nothing can be more misleading in science than abandoning the general view on the quality of the whole as it relates with its parts (Valsiner, 2009).

Here we show an example of the TEM study on the dropping out from the higher education.

Following Sato et al. (2007), Cortés (2008) reviewed the steps in using TEM (Fig. 10.5). These are: (1) defining relevant equifinality regions (EFR) and Obligatory Passage Points (OPP) in the map of trajectories of the process, (2) empirical mapping out all cases moving through these points, and (3) comparison of actual trajectories as these approaches to the equifinality region. Extending the original focus, Cortés (2008) proposed the equifinality “regions” instead of equifinality “point”, because the notion of regions hints the geography and/or place. So a region goes together I-“positions” of Dialogical Self (DS; Hermans, 2001). Cortés tried to integrate TEM and Dialogical Self. He defined two polarized equifinality regions—“I as an educated (higher education) person in X field” and its opposite polarized I position, “I as a non-educated (higher education) person”.

The strategy for construction of the TEM presents two related levels of organization of the dropout phenomena: an ontogenetic level to depict different possible trajectories with dropout events in the aim to construct the web of historical trajectories of individuals and a “quasi-microgenetic” inquiring level by focusing the previous moments of dropout events that lead the dropout decision and the consequent decisions and what happened after the decision.

**Table 10.5** Studies using TEM

Reference	Topic
Yasuda (2005)	Giving up the infertility treatment
Kullasepp (2006)	Becoming psychologists
Kido (in press)	Wearing makeup habitually
Cortés (2008)	Dropping out from higher education
Yasuda et al. (2008)	Adolescent abortion
Tanimura et al. (2008)	Japanese women aiming to get married before 26-year-old



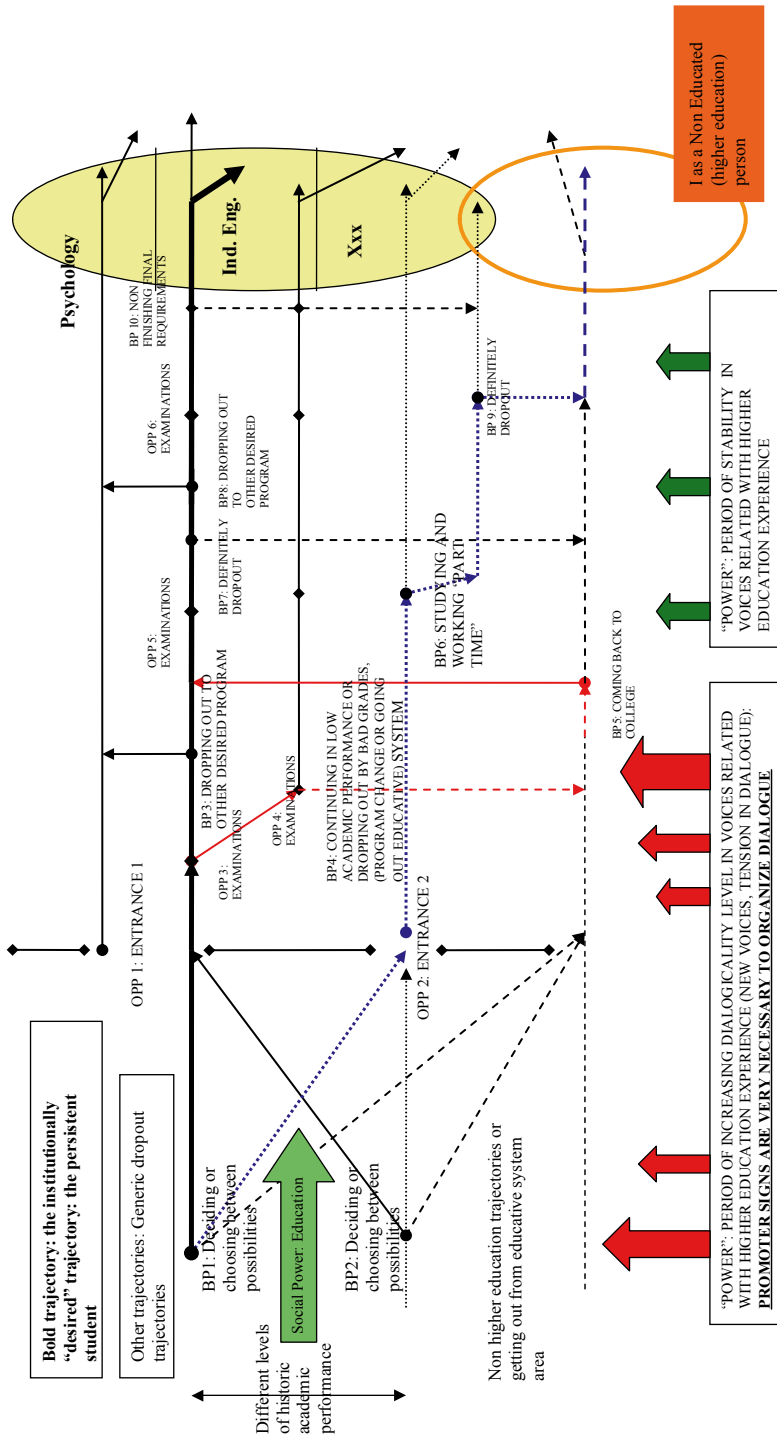

Fig. 10.5 Cortés (2008)'s TEM

The act of using the HSS and TEM involves the following steps (Valsiner & Sato, 2006; Sato et al., 2007):

- (A) locating the relevant equifinality point (EFP)—as well as all relevant OPPs—in the generic map of trajectories necessarily present for the generic system of the processes under investigation (theoretically based activity),
- (B) empirical mapping out all particular cases—systems open to study that move through these points, and
- (C) comparison of different actual trajectories as these approach to the equifinality point by superimposing onto each trajectory a pattern of theoretically meaningful “range measure”—derived from (A)—that specifies whether the given trajectory fits into the realm of selectable cases.

Since EFP depends on the researchers focus and/or research questions, we have proposed to set up polarized equifinality points (PEFP) for neutralizing implicit value system of researchers. PEFP makes researchers notice the possibility of invisible trajectories. Preparing the questions is an important procedure to do qualitative study including TEM. For example, AyAe Kido focused the experience of “Wearing makeup habitually” and interviewed 5 females. Questions made are 7 items in three categories.

The participant’s immediately close female person such as mother, sister and the others were asked about the way of makeup style that they use them, the attitude for makeup they take, and whether the participant long for a way of makeup of them or not.

The participants were asked about when and how were they passively worn makeup first time, hen did they wear makeup spontaneously first time, And when hen did they were makeup habitually in life? General questions includes items like what does the makeup mean for them at that time?

All contents of the interviews were recorded with permission. The records of all interviews were divided meaningful sentences units for further analysis. One unit might consist of a sentence or sentences. Japanese scholars sometime use the KJ method. KJ method developed by a Japanese ethnologist, Jiro Kawakita in the 1960s (Kawakita, 1986). The KJ method was developed as a result of having difficulties in interpreting ethnographic data in Nepal. The KJ method builds upon Charles S. Peirce’s notions of abduction and relies upon intuitive non-logical thinking processes (Scupin, 1997). Each unit (sentence) written on card is to be categorized step by step. First, exact same expressions in units are compiled. Almost other units are left. Second, similar expressions in units are compiled and are given some abstract label that characterizes gathered units (i.e., new unit emerges). Some units originally and new units emerged in second step are now materials for next step of compiling. Compiling and labeling procedure is conducted repeatedly (usually 4 or 5 times) so that abstract and/or aggregated categories might appear. These repeated compiling procedure results in getting different level of abstract labels. In Kido’s case, all relevant events and facts of cosmetic experiences are written on individual cards and collated. Kido ended up with four categories from her interview data. For TEM, the highest level of categories is not needed. Moderate level of labels is needed to depict trajectories (Kido, *in press*; See also Sato et al., 2007).

## *Focusing on the Dynamics in the Personal Decision Making*

We need a further step to describe the dynamics in human development. The theoretical issue to consider is like this. Mori (2009) expresses the concern that TEM expresses just the superficial sequence of events, not the dynamics of human experience. What happens at the specific decision making point to determine which way she/he take? To explain the mechanism around the BFP (Bifurcation Point) appears to be necessary for understanding the dynamics of the livings within irreversible time. After reaching BFP, for example, circle c in this figure, if there are two or more concrete finalities, these are called as multifinality. And if not so concrete and only the ambiguous image is seen, such a situation may be better to be called as the Zone of finality. Each person on the own trajectory has his/her orientation which has developed through the life course. We call this orientation as “Synthesized Personal Orientation (SPO)”. SPO takes forms of goal, adoration and dream.

As usual, SPO automatically leads to next finality. But sometimes, objections and/or barriers might happen. This is the point of severe decision making. We can assume here two powers are simultaneously at work at the point. These are social direction (SD) and social guidance (SG). Both SD and SG are conveyed through everyday social exchanges at home, school and other social situations. And relative gravity (direction and power) of SD and SG determine the selection.

Significant others may play different roles in this scheme. They sometimes stand with a person as an agency of SD (for example, a social norm) and sometimes guide a person from the power of SD to reach solution (making decision). Because, there are many significant others around one person—like a convoy attempting to persuade him/her in one or another direction. From the theoretical view point, there are many bifurcation points to make decisions about moving along one or another of the trajectories. Seeking the decision-making points doesn’t inevitably need the EFP. Instead, analyzing powers around the decision making points allows TEM research broader perspective than before.

Then we look closely the transition process between c and a in Fig. 10.6. As we say later, we can conceive this transition process by using three layers model of genesis (TLMG).

What would happen at the one trajectory from a point (see in Fig. 10.7) to another point a? In the figure before (i.e., not this one), the lines between points are straight and direct but if looking at closely, we can see the two opposite powers which conflicts between social direction and social guidance. So the Synthesized Personal Orientation (SPO) reflects the fluctuated orientation and open-systemic nature of human being within irreversible time. A person proceeds with one’s orientation as an open system (which means orientation is not internal derived) and struggle to realize own orientation against the social directions (SD) with support of social guidance (SG) supplied by the intimate social relationships.

For example, before World War II, Japanese university did not open their doors to women. So if some women hoped to go study at university, social direction strongly suggested not to study. But of course, universities of other countries such as in the US opened the door to women around that time without restrictions. Ms. Tsuru Arai

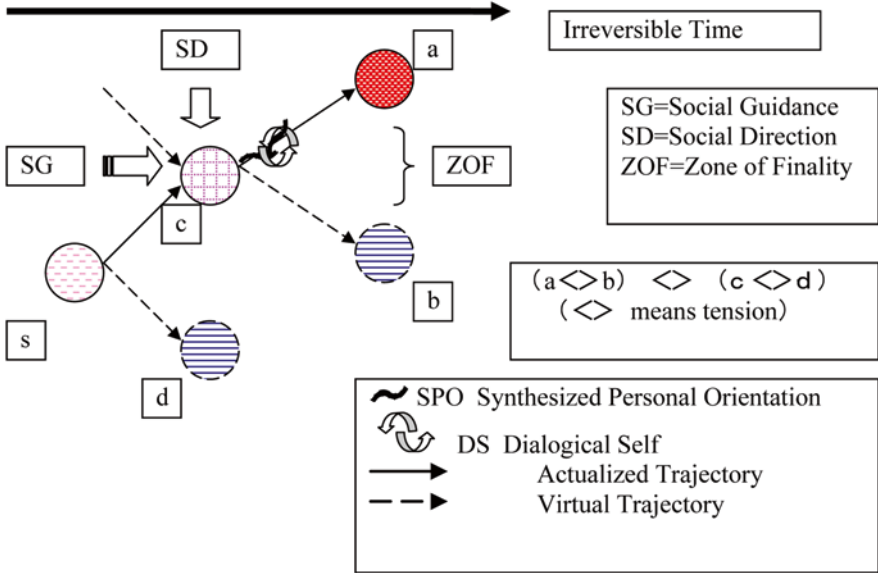

Fig. 10.6 Social guidance and social direction

(1886–1915) entered graduate school of Columbia University and was supervised by Edward L. Thorndike. She could earn Ph.D. Degree in 1912 (Sato, 2007). In her life situation her family and teachers encouraged her much to go study abroad. Thorndike in graduate school of Columbia also encouraged and supervised her.

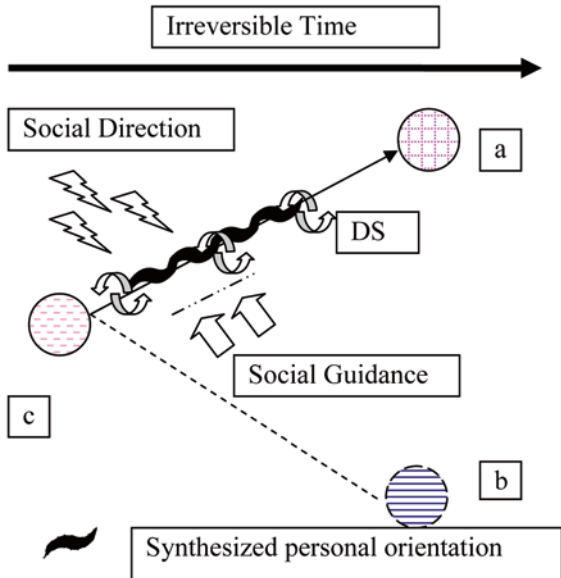

Fig. 10.7 How dialogical processes construct trajectories

Traditional psychology has easily attributed outcomes of positive development to single causal factors, such as motivation, while the term “social support” tends to be used to explain the social relationships needed to overcome the bad condition. But such explanation by motivation is not appropriate for open-systemic view—by which the achieving person is constantly relating with the environment. Dialogical self emerges when synthesized personal orientation fluctuates. Inspired by both William James’ American pragmatism and Mikhail Bakhtin’s Russian dialogical orientation, Hubert Hermans created a theory of self on a new basis—the unity of opposites involved in a dialogue. The dialogical self theory presupposes a multi-voiced person with not just one dominant I-position, but several I-positions, which are temporally and spatially structured (Hermans & van Kempen, 1993). The self is defined as a “dynamic multiplicity of relatively autonomous I positions in an imaginary landscape” (Hermans, 1999).

Temporally and spatially structured “I-positions” have different voices and “I-positions” are relatively independent each other. But in some points, they cause conflicts. Thus, “I as a” and “I as b” appears by turns and conflict occurs. Back to the Ms. Tsuru Arai of about 70 years before in Japan, Tsuru as a non-educated and Tsuru as an educated girl might cause conflict. This scheme can really represent the superficial calm but deeply dynamic process on the way from one BFP to another point (before making decision).

The Three Layer Model of Genesis (TLMG—Fig. 10.8) is useful for understanding ontogenesis through the prisms of two other time frames (Valsiner, 2007). At the lowest level, micro genetic level, the process of *Aktualgenese* (this German word was translated into English “microgenesis” by Heinz Werner) is constantly at work. But in macro genetic—that of ontogenetic—level nothing needs to change. It is in between the two levels—the mesogenetic level where changes are consolidated to be either taken as novelties to the macrogenetic level, or become regulators (“promoter signs”) of the microgenetic processes. Ontogenetic maintenance can happen through SDs (social direction), the promoter sign can be derived from a social norm, habit or any conservative tendency.

Setting equifinality points (EFPs) lead to put both potential trajectories to EFP and polarized EFP (PEFP) on the trajectory. But of course this is the demand for researchers not for participants. Sometimes people cannot do anything because selection is difficult (Hamlet or Buridan’s ass phenomena). But the other time, even after selecting one option, people bother. Here we can see that the Dialogical Self

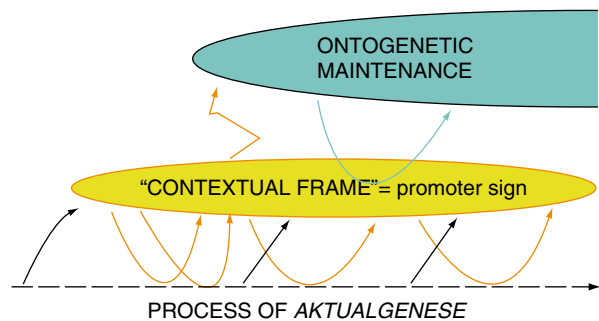

**Fig. 10.8** The scheme of three layers model of genesis (TLMG)

is useful again. That is, bothering persons have dialogue with themselves. What if I had selected another option? How I would be now? This form is easily converted into another form with dialogical self. Which is better for me now, I as one or I as another? For example, two choices of university A and B for a person, s/he self-dialogue is I as a student of A university better than I as a student of B university? There are many more severe choice situations. We move to the situation of intractable disease patient to think about more severe decision making process.

## General Conclusions

A person is not the pile of traits and a life trajectory is not a single line connecting the discrete time points which researchers arbitrary set. If we take time seriously, we should not say such things. There exist many obstacles to our efforts to take time seriously in studies of psychology and sociology. Uses of stage theories and reliance on correlation coefficients, as well as an implication that trajectory is merely a unitary path (rather than a range of options) within the life course paradigm that we outlined in the beginning of this chapter are some examples. Taking the equifinality principle into account is one of the breakthrough in describing the dynamics. Accepting the premise that different initial conditions produce different trajectories to arrive at a similar final state is the reality of open systems.

The Trajectory Equifinality Model (TEM) hopefully overcomes such obstacles. The dynamics of living in real context should be understood by using the notion of signs as organizers of the future—hence assuming a constructionist stance. Vygotsky (1978) pointed out that the developmental process is mediated by cultural tools. Human development is mediated by signs—and because of such mediation the potential for a person's moving in various directions in one's life course exists. Life stage models of development cannot conceptualize this dynamism. Of course, existing life course studies struggle to understand the continuity of life as well. But they can never depict the dynamics of the flow of the lived experience within in the irreversible time. They might cover outcomes of processed that are charted over time—creating a trajectory *post factum*—but never accessing the real processes embedded in time. Actually, the practice of life course research sets up longitudinal “contact points” at fixed intervals—yet relevant transitions can happen at any moment in between these points. To use an analogy—model of life course studies look like fixed net fishing. In contrast, TEM is one of the ways to understand the flow and the continuity of life from the view point of the agent whose life course is under study.

Last but not least, we consider the notion of transform within our discussion. We need the transforming mechanism model which leads to depict the dynamic process of life trajectories. Depicting the maintenance of a similar state is also dynamic. Superficial maintenance never implies static state of covert system. Sometimes covert dynamism might result in the overt static state. Looking at the trajectories as they are being constructed can be used for creating the new way to depict the coherence, dynamism and variation of idiosyncratic life within irreversible time.

## References

- Abbey, E., & Valsiner, J. (2004). Emergence of meanings through ambivalence [58 paragraphs]. *FQS: Forum Qualitative Sozialforschung/Forum: Qualitative Social Research*, 6(1), Article 23, from <http://nbn-resolving.de/urn:nbn:de:0114-fqs0501231>
- Bertalanffy, von L. (1968). *General systems theory*. New York: Braziller.
- Bruner, J. (1986). *Actual minds, possible worlds*. Cambridge, MA: Harvard University Press.
- Callero, P. L. (2003). The sociology of the self. *Annual Review of Sociology*, 29, 115–133.
- Cortés, M. (2008, August). *A dialogical self—Trajectory equifinality model for higher education first year persistence/abandon study*. Paper presented at the 5th International Conference of Dialogical Self. Cambridge, UK.
- Daaleman, T. P., & Elder, G. H. (2007). Family medicine and the life course paradigm. *Journal of the American Board of Family Medicine*, 20(1), 85–92. From <http://www.jabfm.org/cgi/content/full/20/1/85>
- Elder, G. H. (1985). *Life course dynamics: Trajectories and transitions*. Ithaca, NY: Cornell University Press.
- Elder, G. H. (1998). The life course and human development. In R. Lerner (Ed.), *Handbook of child psychology. Vol. 1. Theoretical models of human development* (5th ed., pp. 939–991). New York: Wiley.
- Frank, L. K. (1939). Time perspective. *Journal of Philosophy*, 4, 293–312.
- Goldberg, L. R. (1990). An alternative “Description of personality”: The Big-Five factor structure. *Journal of Personality and Social Psychology*, 59, 1216–1229.
- Hermans, H. J. M. (1999). Self-narratives as meaning construction: The dynamics of self-investigation. *Journal of Clinical Psychology*, 55, 1193–1211.
- Hermans, H. J. M. (2001). The dialogical self: Toward a theory of personal and cultural positioning. *Culture & Psychology*, 7, 243–281.
- Hermans, H. J. M., & Bonarius H. (1991). The person as co-investigator in personality research. *European Journal of Personality*, 5, 199–216.
- Hermans, H. J. M., & Kempen, H. J. G. (1993). *The dialogical self: Meaning as movement*. San Diego: Academic Press.
- Kawakita, J. (1986). *The KJ method: Seeking order out of chaos*. Tokyo: Chuokoron-sha. (in Japanese)
- Kido, A. (in press). Makeup behavior of the use by adolescent female students in the females in different cultural situation settings—Qualitative analysis of subjects in Japan and the USA—Qualitative analysis of interview Japan and U.S.
- Kullasepp, K. (2006). Identity construction of psychology students: professional role in the making. *European Journal of School Psychology*, 4(2), 249–280.
- Latour, B. (1987). *Science in action: How to follow scientists and engineers through society*. Cambridge, MA: Harvard University Press.
- Lerner, R., & Busch-Rossnagel, N. (Eds.). (1981). *Individuals as producers of their development: A life-span perspective*. New York: Academic Press.
- Lewin, K. (1943). Defining the “Field at a Given Time”. *Psychological Review*, 50, 292–310. (Republished in *Resolving social conflicts & field theory in social science*, Washington, DC: American Psychological Association, 1997)
- Lewin, K. (1952). *Field theory in social sciences*. London: Tavistock.
- Macmillan, R., & Eliason, S. (2003). Characterizing the life course as role configurations and pathways: A latent structure approach. In J. T. Mortimer & M. J. Shanahan (Eds.), *Handbook of the life course*. New York: Kluwer Academic/Plenum Publishers.
- Maslow, A. H. (1943). A theory of human motivation. *Psychological Review*, 50, 370–396.
- McAdams, D. P., & Pals, J. L. (2006). A new Big Five: Fundamental principles for an integrative science of personality. *American Psychologist*, 61, 204–217.
- McCrae, R. R., & Costa, P. T., Jr. (1996). Toward a new generation of personality theories: Theoretical contexts for the five-factor model. In J. S. Wiggins (Ed.), *The five-factor model of personality: Theoretical perspectives* (pp. 51–87). New York: Guilford.

- McNemar, Q. (1940). Sampling in psychological research. *Psychological Bulletin*, 37, 331–365.
- McQuellon, R. P., Russell, G. B., Rambo, T., Craven, B., Radford, J., Perry, J., et al. (1998). Quality of life and psychological distress of bone marrow transplant recipients: The ‘time trajectory’ to recovery over the first year. *Bone Marrow Transplantation*, 21, 477–486.
- Mitchell, C., Kaufman, C., & Beals, J. (2004). Equifinality and multifinality as guides for preventive interventions: HIV risk/protection among American Indian young adults. *Journal of Primary Prevention*, 25, 491–510.
- Mischel, W. (1968). *Personality and assessment*. New York: Wiley.
- Mori, N. (2009). Methodological issues on two types of TEM study; retrospective and prospective. In T. Sato (Ed.), *Starting qualitative study using the TEM as a new method*. Tokyo: Seishin-Shobo. (in Japanese)
- Murray, H. A. (1938). *Explorations in personality*. New York: Oxford University Press.
- Nuttin, J., & Lens, W. (1985). *Future time perspective and motivation: Theory and research method*. Mahwah: Lawrence Erlbaum Associates.
- Peirce, C. S. (1908). *Collected papers of Charles Sanders Peirce*. In C. Hartshorne, P. Weiss, & A. W. Burks (Eds.), Cambridge, MA: Harvard University Press. [1931–1958 CP 6.475; the first refers to the volum, the number after the dot to the paragraph, and the last number to the year of the text]. C VOL6 of collected paper 475 paragraph, 1908 from <http://user.uni-frankfurt.de/~wirth/texte/nubiola.html>
- Sato, T. (2007). Development, change or transformation: How can psychology conceive and depict professional identify construction? *European Journal of School Psychology*, 4, 319–332.
- Sato, T. (Ed.). (2009). *Starting qualitative study using the TEM as a new method*. Tokyo, Japan: Seishin-Shobo. (in Japanese)
- Sato, T., Watanabe, Y., & Omi, Y. (2007). Beyond dichotomy—Towards creative synthesis. *IPBS: Integrative Psychological & Behavioral Science*, 41(1), 50–59.
- Sato, T., Yasuda, Y., & Kido, A. (2004, August 12). *Historically Structured Sampling (HSS) model: A contribution from cultural psychology*. Paper presented at the 28th International Congress of Psychology, Beijing, China.
- Sato, T., Yasuda, Y., Kido, A., Arakawa, A., Mizoguchi, H., & Valsiner, J. (2007). Sampling reconsidered idiographic science and the analysis of personal life trajectories. In J. Valsiner & A. Rosa (Eds.), *The Cambridge handbook of sociocultural psychology* (pp. 82–106). New York: Cambridge University Press.
- Scupin, R. (1997). The KJ method: A technique for analyzing data derived from Japanese ethnology. *Human Organization*, 56, 233–237.
- Stevens, S. S. (1946). On the theory of scales of measurement. *Science*, 103, 677–680.
- Stevens, S. S. (1951). Mathematics, measurement and psychophysics. In S. S. Stevens (Ed.), *Handbook of experimental psychology* (pp. 1–49). New York: Wiley.
- Tanimura, S., Sato, T., & Tsuchida (2008). Gender role consciousness of the parents which let daughters aim at “The Normal Marriage (a full-time homemaker)”. *Ritsumeikan Journal of Human Sciences*, 17, 61–74. (in Japanese with English abstract)
- Valsiner, J. (1986). Sequence-structure analysis study of serial order within unique sequences of psychological phenomena. In J. Valsiner (Ed.), *The individual subject and scientific psychology*. New York: Plenum.
- Valsiner, J. (1999). *Culture and human development*. London: Sage.
- Valsiner, J. (2001). *Comparative study of human cultural development*. Madrid: Fundacion Infancia y Aprendizaje.
- Valsiner, J. (2007). *Culture in minds and societies*. New Delhi: Sage.
- Valsiner, J. (2009). Facing the future—making the past: The permanent uncertainty of living. In T. Sato (Ed.), *Starting qualitative study on the TEM as a new method*. Tokyo: Seishin-Shobo. (translated in Japanese)
- Valsiner, J., & Sato, T. (2006). Historically Structured Sampling (HSS): How can psychology’s methodology become tuned in to the reality of the historical nature of cultural psychology? In J. Straub, D. Weidemann, C. Kolbl, & B. Zielke (Eds.), *Pursuit of meaning. Advances in cultural and cross-cultural psychology* (pp. 215–251). Bielefeld: Transkript.



- Vygotsky, L. S. (1978). *Mind and society: The development of higher mental processes*. Cambridge, MA: Harvard University Press.
- Wheaton, B., & Gotlib, I. H. (1997). Trajectories and turning points over the life course: Concepts of themes. In I. H. Gotlib & B. Wheaton (Eds.), *Stress and adversity over the life course: Trajectories and turning points* (pp. 1–25). New York: Springer.
- Yamada, Y. & Kato, Y. (2006). Images of circular time and spiral repetition: The generative life cycle model. *Culture & Psychology, 12*, 143–160.
- Yasuda, Y. (2005). Self-reassessment following infertility: Branching selection by couples unable to have children after infertility treatment. *Qualitative Research in Psychology, 4*, 201–226. (in Japanese with English abstract)
- Yasuda, Y., Arakawa, A., Takada, S., Kido, A., & Sato, T. (2008). Young women's abortion experiences: The influence of social expectation and relationships with others. *Qualitative Research in Psychology, 7*, 181–203. (in Japanese with English abstract)

# Chapter 11

## Analysis of Intensive Categorical Longitudinal Data

Alexander von Eye and G. Anne Bogat

Intensive longitudinal data are defined as data that come from more than the usual three or four observation points in time yet from fewer than the 100 or more required for time series analysis (Walls & Schafer, 2006). Consider, for example, a clinical design with 20 repeated observations. Data from this design are hard to analyze. Unless the sample is very large, 20 observations are too many for structural modeling. For repeated measures ANOVA with polynomial decomposition, polynomials of up to the 19th order would have to be estimated (which is the easy part) and interpreted (which is the hard part). This applies accordingly to hierarchical linear models of this design. For longitudinal, P-technique factor analysis, 100 observations are needed. In brief, data that are *intensive* in the sense that more observations are made over time than usual pose specific analytic problems.

This situation is exacerbated when categorical data are analyzed. Crossing the data from 20 observation points is out of the question. Already, when only one dichotomous variable is analyzed, the number of cells of the cross-classification will be  $2^{20} = 1,048,576$ , that is, over a million cells. When multiple variables are analyzed, the situation becomes much more complex. Poisson regression models and marginal models are among the few options available for analysis (for overviews, see Agresti, 2002; Lawal, 2003). However, these options constrain the type of questions that can be asked.

In this chapter, we propose a method for the analysis of intensive categorical longitudinal data. This method is based on the well known *runs tests* (Stevens, 1939; Swed & Eisenhart, 1943; Wald & Wolfowitz, 1940). The method allows one to pursue both variable-oriented analysis, for example, log-linear modeling, and person-oriented analysis (Bergman & Magnusson, 1997; von Eye & Bergman, 2003), for example, Configural Frequency Analysis (Lienert, 1969; von Eye, 2002; von Eye & Gutiérrez-Peña, 2004).

---

A. von Eye (✉)  
Department of Psychology  
Michigan State University  
East Lansing, MI 48824, USA  
e-mail: voneye@msu.edu

## Runs

Consider a sequence of  $K$  scores. For this sequence, a *run* is defined as the un-interrupted sequence of  $k < K$  scores that fulfill a specified condition. *Runs tests* are used to detect non-randomness in a series of scores that can be observed (e.g., in the form of serial correlation). A large number of specific definitions of runs can be used. We give three examples. First, a run can be defined as the *uninterrupted series of scores of the same value*. Consider the series 1111335222. This series contains 4 runs, including a run of  $k = 4$  (value 1), a run of  $k = 2$  (value 3), a run of  $k = 1$  (value 5), and a run of  $k = 3$  (value 2). A run can also be defined as the *uninterrupted series of scores of increasing value*. The series 1234533234 contains 2 runs. The first contains the first five scores, and the second contains the last three scores. This applies accordingly to series of decreasing values. A variant of this definition was implemented in Wallis and Moore's (1941) *runs-up-and-down* test. A third definition of a run is an *uninterrupted series of scores within a pre-specified range*. This example is of use when the reliability of machine tools is investigated or the accuracy of basketball players.

To detect non-randomness of runs, one-sample, and two-sample tests have been proposed. These tests can be reviewed in textbooks of nonparametric statistics (e.g., Bortz, Lienert, & Boehnke, 1990; Siegel, 1956), or encyclopedias (e.g., Lunneborg, 2005) and will not be described here. For the present purposes, we are not concerned with the runs tests themselves. Instead, we discuss the type of information created for runs tests, and the use of this information for the analysis of intensive categorical longitudinal data.

## The Information Used to Test Runs

Series of measures have been studied from a large number of perspectives. For example, using GLM approaches, researchers have examined trends of series, changes in trends, and changes in these changes. This can be done using regression analysis and polynomial decomposition. Autocorrelation patterns and structures have been investigated using factor analysis, dynamic modeling, or, for long series, trigonometric decomposition.

In the context of longitudinal categorical data, patterns of terminal events and patterns or repeatable events have been investigated using survival analysis and event history analysis. Many other methods of analysis have been applied. For example, in the context of generalized linear modeling, marginal models and IRT models of longitudinal models have been devised. In the context of configural analysis, level, spread, autocorrelation, prediction patterns, change patterns, the symmetry of change patterns, sign patterns, and structures of first and higher differences have been investigated (von Eye, 2002; von Eye & Mun, 2007).

Runs tests use information of series that corresponds to their specific definition of runs. In addition, runs tests share the characteristic that they are based on *ordered*

*sequences of scores*. That is, the order of scores must be defined. When individuals or groups are compared, the order of scores must be defined for each individual or group, but the number of scores is not necessarily required to be the same.

### ***Runs of Scores of Same Value***

As was illustrated above, the series 1111335222 contains the run sequence 4 2 1 3. To establish this sequence of 4 runs, the scale level of the scores is of no importance. All that is asked is whether adjacent scores are equal or different. Therefore, runs of scores of same value use no more than nominal scale information.

### ***Runs of Increasing, Decreasing, or Up-and-Down Patterns of Scores***

The series 1234533234 contains 2 runs of increasing scores, the first involving 5 scores (12345) and the second involving 3 scores (234). This series also contains 2 runs of decreasing scores, both involving 2 scores (53 and 32). Thus, the up-and-down pattern of scores for this series is u5, d2, d2, u3. In terms of runs of scores of equal value, this series can be described as 1 1 1 1 2 1 1 1. To describe the runs of increasing, decreasing, or up-and-down series of scores, no more than ordinal information is needed.

### ***Runs of Scores within a Pre-specified Range***

Consider a machine tool that is supposed to produce parts that do not deviate from a pre-specified size by more than  $5\mu$ . Suppose, this machine has produced parts with the following deviations (in  $\mu$ ): 3 3 2 4 2 6 6 4 4. This series contains 2 runs of tools within specification. The first run involves 5 parts, and the second involves 2 parts. These two runs are separated by a run of 2 parts that are outside the admissible range. To describe these runs, ratio scale information is used. However, ranges can also be defined for ordinal or interval level data. The type of information used for this definition of runs depends on the scale level used to specify the range.

## **Runs in the Analysis of Categorical Data: Algorithmic Elements**

Based on the descriptions given above, the following variables describe the runs in any series of  $K$  scores:

1. *Number of runs,  $K_r$ , with  $K_r \leq K$ ;*
2. *Length of the  $j$ th run of equal scores,  $k_j$ , with  $1 \leq k_j \leq K$  and  $1 \leq j \leq K$ ;*  
 Depending on type of run, the following variables can also be defined:
3. *Length of  $j$ th run of ascending scores,  $k_j^a$ , with  $2k_j^a \leq K - 1$ ;*
4. *Length of  $j$ th run of descending scores,  $k_j^d$ , with  $2k_j^d \leq K - 1$ .*
5. *Length of run within a pre-specified interval,  $k_j^w$ , with  $0 \leq k_j^w \leq K$ .*

Of these five variables, the first is the most important. Standard runs tests ask whether the number of runs,  $K_r$ , is smaller or larger than expected. When  $K_r$  is smaller than expected, there may be a process that prevents scores from breaking the trend. When  $K_r$  is larger than expected, there may be a process that causes overly frequent change. Length of run information is partially dependent on the number of runs. This number sets limits to both the maximum and the minimum run length. Still, the length of runs is of importance. Consider, for example, a study on the effects of psychotherapy of anancastic behavior. After establishing a baseline run pattern, the beginning of therapy can be expected to cause a run pattern that suggests improvement. This can be indicated by a pattern of decreases in the frequency of anancastic behavior occurrences over time. Therapy success can be measured using, among other indicators, length of run information.

To determine the number of runs, the following procedure is easily implemented. Let  $x_j$  be the score that was observed at time  $j$ , and  $K$  the number of observation points. Then, the *number of runs of equal scores,  $r_{es}$* , can be calculated in two steps.

1. 
$$\delta_j = \begin{cases} 0, & \text{if } x_j = x_{j+1}, \\ 1 & \text{else} \end{cases}$$

where  $\delta_j$  compares the scores  $x_j$  and  $x_{j+1}$ , for  $j = 1, \dots, K - 1$ , and

2. 
$$r_{es} = \left( \sum_j \delta_j \right) + 1.$$

Accordingly, the *number of runs of increasing scores,  $r_{is}$* , can be calculated in the two steps

1. 
$$\delta_j = \begin{cases} 0, & \text{if } x_j < x_{j+1}, \text{ and} \\ 1 & \text{else} \end{cases}$$

2. 
$$r_{is} = \left( \sum_j \delta_j \right) + 1.$$

The *number of runs of decreasing steps,  $r_{ds}$* , can be calculated in the two steps

1. 
$$\delta_j = \begin{cases} 0, & \text{if } x_j > x_{j+1}, \text{ and} \\ 1 & \text{else} \end{cases}$$

2. 
$$r_{ds} = \left( \sum_j \delta_j \right) + 1.$$

Finally, the *number of runs within a pre-specified interval*,  $r_{in}$ , can be calculated in the two steps

1.  $\delta_j = \begin{cases} 0, & \text{if } |x_j - x| < \varepsilon \\ 1 & \text{else} \end{cases}$ , where  $x$  is the pre-specified target score and the pre-specified threshold, for  $j = 1, \dots, K$ , and

2.  $r_{in} = \left( \sum_j \delta_j \right) + 1$ .

Each of these steps can be performed using the appropriate commands in general purpose statistical software packages, for example the TRANSFORM command in SYSTAT or the COMPUTE command in SPSS. Similar operations are easily implemented in spreadsheet programs such as Lotus 1-2-3 or Excel. The result of these calculations is one runs score per case per variable. Note that runs scores can be directly compared only if the number of observation points is the same for each case. If this number varies, as is natural in training or therapy studies, the observed number of runs can be related to the maximum number of runs,  $r_{max} = K$ . The resulting *relative number of runs*,  $r_r = r/r_{max}$ , can be directly compared with other  $r_r$  scores, both intra- and inter-individually. In the following section, we illustrate the use of *number of runs*,  $r$ , in the context of categorical data analysis.

## Data Examples

The following two examples use data from a study on intimate partner violence (IPV; defined here as male violence toward his female partner; cf. Bogat, Levendosky, & von Eye, 2005). Two hundred and six women were initially assessed during their last trimesters of pregnancy and then subsequently assessed yearly at the birthdays of the children with whom they had been pregnant. During pregnancy, the women had IPV experiences ranging from none to severe. In order to enroll in the study, women had to be between 18 and 40 years of age, in a romantic relationship for at least 6 weeks during pregnancy, and English speaking. Women were, on average, 25.33 years of age at recruitment and had one child ( $\bar{x} = 1.4$ ). Respondents were 63.7% Caucasian, 25.5% African American, 4.9% Latina, and 5.9% from other ethnic/racial backgrounds. About 40% of the women were married; 50% were single, never married; and the remainder were separated, divorced, or widowed. Their median monthly income was \$1500.00.

For the examples that follow, data from 204 women were used. Two of the original 206 women were removed from the analysis because they died during the course of the study. All missing data were imputed using the hot deck method implemented in PRELIS (Jöreskog & Sörbom, 2004). At each of the 5 assessments, the Beck Depression Inventory (Beck, Ward, Mendelson, Mock, & Erbaugh, 1961), the PTSD Scale for Battered Women (Saunders, 1994), and the Severity of Violence against Women Scales (Marshall, 1992) were administered.

### ***Example 1: Log-Linear Modeling and First Order Configural Frequency Analysis (CFA) of Runs***

For the first example, we use data from the first 5 observation points (pregnancy and when the children were ages 1, 2, 3, and 4), and analyze the variables Depression (D), Posttraumatic Stress (P), and Violence Status (V). Depression was dichotomously scored as 1 = respondent exceeds cut-off for clinical-level depression, 0 = else. Posttraumatic Stress was scored as 1 = respondent exceeds cut-off for clinical-level PTSD symptoms, and 0 = else. Please note that the following analyses could have been performed using the raw scores also. Here, however, we focus on runs of clinical-level depression and posttraumatic stress symptoms. Violence Status was scored as 1 = respondent reports one or more incidents of IPV that equal or exceed threats of moderate violence in the last year, and 0 = no violence or violence below cut off.

For each of these variables, the respondent was assigned a score for runs of equal numbers. The maximum score for each variable and respondent was 5 (5 time-adjacent scores were compared for each variable; thus the maximum number of runs of scores of equal value is 5). The number of cases with 5 runs in either variable was so small that these cases were subsumed under the rubric of “4 or more” runs. The resulting three scores per respondent were crossed to form a  $4 \times 4 \times 4$  contingency table with 64 cells. This table was analyzed using standard hierarchical log-linear models and standard first order CFA. For the CFA, we used the binomial test, and the Bonferroni-protected  $\alpha^* = 0.00078$ .

To obtain an overview of the relationships among the three variables, a log-linear model was estimated first. Results indicate that there is no way to obtain a standard hierarchical model that is more parsimonious than the saturated model. These analyses were conducted using both SYSTAT and SPSS. Both programs produced the same overall LR- $X^2$ . However, SYSTAT indicated that the models would not converge, even after invoking the Delta option (in SPSS, Delta had been set to zero). From these results, we conclude that, at the level of variable-oriented analysis, the data cannot be represented more parsimoniously than by the cross-tabulation itself. To explore the possibility of local associations, we then conducted a configural analysis. Results from this analysis are summarized in Table 11.1.

The overall LR- $X^2 = 221.59$  ( $df = 54$ ;  $p < 0.01$ ) for the CFA base model suggests that this model must be rejected, and we can expect types and antitypes to emerge. Four types and one antitype were found. The first type, constituted by Configuration 111, describes women who show only one run in all three variables. Specifically, these are women who consistently are not depressed, are not experiencing posttraumatic stress symptoms, and are not victimized during any of the observation periods. Having just one run indicates extreme stability. No change took place at all. The second type is constituted by Configuration 224. This pattern describes women who had two runs each of depression and posttraumatic stress symptoms, and four or five runs of violence. The multiple runs of violence indicate that these women frequently moved in and out of situations in which there was partner violence. The

**Table 11.1** First order CFA of the Cross-classification of the Runs of Depression (D), Posttraumatic Stress Symptoms (P), and Violence Status (V)

Configuration DPV	$M$	$\hat{m}$	P	Type/ Antitype?
111	54	21.137	0.00000000	Type
112	8	8.348	0.54304618	
113	1	4.973	0.03966917	
114	1	1.776	0.46892307	
121	13	15.922	0.27109691	
122	1	6.288	0.01260124	
123	4	3.746	0.51688854	
124	1	1.338	0.61304950	
131	3	10.431	0.00649619	
132	3	4.120	0.40822801	
133	1	2.454	0.29492050	
134	0	0.877	0.41541607	
141	1	8.510	0.00165848	
142	4	3.361	0.43375764	
143	1	2.002	0.40404538	
144	0	0.715	0.48852438	
211	4	11.009	0.01314292	
212	2	4.348	0.18831743	
213	0	2.590	0.07376018	
214	0	0.925	0.39564853	
221	11	8.292	0.21036212	
222	8	3.275	0.01810888	
223	5	1.951	0.04751055	
224	7	0.697	0.00000793	Type
231	7	5.433	0.30225885	
232	2	2.146	0.63707170	
233	1	1.278	0.63419979	
234	0	0.457	0.63313803	
241	0	4.432	0.01132156	
242	2	1.751	0.52326573	
243	1	1.043	0.71995365	
244	0	0.372	0.68880758	
311	0	7.926	0.00030826	Antitype
312	2	3.131	0.39269809	
313	0	1.865	0.15356524	



**Table 11.1** (continued)

Configuration DPV	<i>M</i>		P	Type/ Antitype?
314	0	0.666	0.51315375	
321	3	5.971	0.14987523	
322	2	2.358	0.58013826	
323	2	1.405	0.41032047	
324	0	0.502	0.60510813	
331	5	3.912	0.35375670	
332	7	1.545	0.00102893	
333	6	0.920	0.00036639	Type
334	1	0.329	0.28034608	
341	8	3.191	0.01576930	
342	0	1.260	0.28243968	
343	0	0.751	0.47130478	
344	0	0.268	0.76464584	
411	2	4.844	0.13528602	
412	2	1.913	0.57119372	
413	1	1.140	0.68436033	
414	0	0.407	0.66533698	
421	1	3.649	0.11872585	
422	0	1.441	0.23546466	
423	0	0.859	0.42302351	
424	0	0.307	0.73576574	
431	1	2.391	0.30871702	
432	1	0.944	0.61184391	
433	0	0.562	0.56935403	
434	0	0.201	0.81792613	
441	6	1.950	0.01434491	
442	3	0.770	0.04291890	
443	5	0.459	0.00011131	Type
444	0	0.164	0.84878859	

two runs in the response variables suggest that these women switched from non-caseness to caseness over the course of the observations. Only 7 women showed this pattern. This number, however, is significantly above the expected number.

This applies accordingly to the 6 women who showed 3 runs in all three variables. These women moved in and out of symptom status as well as in and out of victim status. As rare as this pattern is, it was observed more often than expected. Similarly, only 5 women displayed Pattern 443, that is, the maximum number of

runs of depression and posttraumatic stress symptoms, in response to moving in and out of violent partner situations. Again, this number was small but large enough to define a type. Because the occurrence rates of the last three types were so small, replication studies are encouraged to firmly establish the existence of these types.

The sole antitype was constituted by Configuration 311. Not a single respondent showed this pattern, but about 8 had been expected to show it. Exhibiting three runs of depression in combination with stable non-caseness in posttraumatic stress and stable non-violence is less likely than one would expect for a chance event.

### ***Example 2: Log-Linear Modeling and 2-group CFA of Depression and Posttraumatic Stress Runs***

In the second data example, we examine whether experiencing IPV during pregnancy confers risk for the women's subsequent mental health. As in the first example, we first perform a log-linear analysis and, then, run a 2-group CFA in which we compare the run patterns of those women who experienced IPV above the cut-off specified above during pregnancy with those women who did not. Sixty-seven women experienced above-threshold partner violence during pregnancy, and 137 did not. As in the first example, we first attempted to identify a parsimonious log-linear model, and then to perform a 2-group CFA. The table examined for these analyses is of size  $4 \times 4 \times 2$ , and is spanned by the runs for Depression (D; 4 categories), PTSD symptoms (P; 4 categories), and Violence during pregnancy (V; 2 categories).

The log-linear analyses resulted in the model of all two-way interactions, [D, P][D, V][P, V]. For this model, the LR- $\chi^2$  was 9.63 ( $df=9$ ,  $p=0.38$ ), thus indicating impeccable model-data fit. A logistic regression model in which we predicted violence status during pregnancy from the two runs patterns fit well also (Hosmer-Lemeshow  $\chi^2=4.13$ ;  $df=7$ ;  $p=0.765$ ; Nagelkerke  $R^2=0.33$ ). Considering, however, that the overall classification percentage was no better than 70.1, and that two of the three contrasts that were estimated for posttraumatic stress were not significant (Category 4 was used as the reference), we ask, where, in particular, the action in the  $4 \times 4 \times 2$  (D  $\times$  P  $\times$  V) table can be located. To answer this question, we perform a 2-group CFA.

For this analysis, we use the  $z$ -approximation of the binomial test and the Bonferroni-protected  $\alpha^*=0.003$ . Table 11.2 displays results of the 2-group CFA.

The 2-group CFA revealed three discrimination types. The first of these is constituted by Configuration 11. These are women with just one run each of depression and posttraumatic stress symptoms. This pattern is observed significantly more often in women who did not experience above-threshold partner violence during pregnancy. The second discrimination type is constituted by Configuration 22. These women slide from non-caseness into caseness (or vice versa) and remain there, during the observation period. Significantly more women who experienced violence during pregnancy exhibit this pattern than do women who do not experience violence during pregnancy. Similarly, Configuration 24 is found more often in

**Table 11.2** 2-group CFA of the Cross-classification of Runs of Depression (D), Posttraumatic Stress Symptoms (P) with Violence During Pregnancy (V)

Configuration DPV	<i>m</i>	<i>z</i>	<i>p</i>	Type?
111	58			
112	2	5.792	0.000000	Discrimination Type
121	11			
122	3	0.942	0.173080	
131	2			
132	0	0.994	0.160160	
141	0			
142	1	-1.434	0.075847	
211	17			
212	11	-0.782	0.217140	
221	3			
222	8	-2.896	0.001889	Discrimination Type
231	7			
232	4	-0.256	0.399038	
241	1			
242	7	-3.358	0.000392	Discrimination Type
311	11			
312	5	0.141	0.443908	
321	7			
322	6	-1.056	0.145401	
331	3			
332	5	-1.822	0.034197	
341	0			
342	1	-1.434	0.075847	
411	8			
412	7	-1.185	0.118080	
421	6			
422	3	-0.032	0.487143	
431	3			
432	4	-1.393	0.081772	
441	0			
442	0	0.061	0.475623	

women who experience violence during pregnancy than in women with no violence. These are women who slide into depression and stay there, and have repeated bouts with posttraumatic stress symptoms. Overall, the negative signs in the table suggest that the mental health of women who experience violence during pregnancy is less stable in the following years than that of women with no violence. The relatively small number of discrimination types can be explained by the low frequencies of individual configurations.

## Discussion

In this article, we presented a new method for the analysis of longitudinal categorical data. This method enriches the arsenal of options of categorical data analysis in two ways. First, the method allows one to test hypotheses concerning *intensive longitudinal data*. This type of data has, thus far, been hard to analyze. In fact, even the above-mentioned marginal and regression-type models pose problems, in particular in the analysis of multivariate data. Analyzing the runs structure of longitudinal data allows for the reduction of the number of variable categories to the extent that complete cross-classifications can be examined even for samples of moderate size. Consider the first data example, above. Before extracting the runs information, we had 5 observation points for three dichotomous variables. Completely crossed, these variables would have spanned a contingency table with  $2^{15} = 32,768$  cells. Tables this large require colossal samples for proper analysis. The methods presented here enabled us to analyze all three variables for all observation points, using only the 204 cases of our sample. The only data reduction that was performed involved the aggregating of two sparsely populated variable categories. The resulting cross-tabulation had  $4^3 = 64$  cells, that is, a portion of 0.00195 of the big original table, a savings of 998 per mill.

Second, using runs information for categorical data analysis offers a new set of hypotheses that can be tested—hypotheses that have, to the best of our knowledge, not been proposed or tested in a multivariate, longitudinal categorical variable context. These hypotheses concern the number of runs or, in different words, a particular aspect of stability over time. Thus, the methods proposed here are the first to allow one to study *patterns of multivariate temporal stability and change*, and this can be done both from the variable-oriented and the person-oriented perspectives.

There can be no doubt that this reduction in size comes at a price. This price involves a change in hypotheses that can be tested. For example, hypotheses concerning the association structure of the original variables cannot be simultaneously entertained, and neither can hypotheses about individual patterns of change from one category to the next. These and other standard hypotheses are replaced by hypotheses about runs and their interactions.

The runs tests discussed in the literature are notorious for possessing low power. However, they are nonparametric, and parametric alternatives have not been proposed. Therefore, there are few alternatives to runs tests. In the context of this arti-

cle, the power of runs tests is of lesser importance. We focus on the information that is extracted from series of measures and used when testing hypotheses involving runs.

In this chapter, we demonstrated the usefulness and versatility of the runs concept for the analysis of intensive categorical longitudinal data. In the first of the above examples, we tested and explored hypotheses concerning the joint stability of three variables. In the second example, we tested and explored hypotheses concerning the differences in stability that can be found in two groups of respondents. In the first example, no parsimonious log-linear model could be specified. Therefore, CFA was the only option for analysis. In the second example, a log-linear model and a logistic regression model described the data well. Using 2-group CFA, we identified those patterns that carry these (local) variable relationships (the relationship between 2-group or prediction CFA and logistic regression is discussed in detail in von Eye & Bogat, 2005, and in von Eye, Mair, & Bogat, 2005). Thus, the runs approach offers a new way to assess stability and change in intensive categorical longitudinal data from both the variable-oriented and person-oriented perspectives.

## References

- Agresti, A. (2002). *Categorical data analysis* (2nd ed.). Hoboken, NJ: Wiley.
- Beck, A. T., Ward, C. H., Mendelson, M., Mock, J., & Erbaugh, J. (1961). An inventory for measuring depression. *Archives of General Psychiatry, 4*, 561–571.
- Bergman, L. R., & Magnusson, D. (1997). A person-oriented approach in research on developmental psychopathology. *Development and Psychopathology, 9*, 291–319.
- Bogat, G. A., Levendosky, A. A., & von Eye, A. (2005). The future of research on intimate partner violence: Person-oriented and variable-oriented perspectives. *American Journal of Community Psychology, 36*, 49–70.
- Bortz, J., Lienert, G. A., & Boehnke, K. (1990). *Verteilungsfreie Methoden in der Biostatistik*. Berlin: Springer.
- Jöreskog, K. G., & Sörbom, D. (2004). *Lisrel 8.7 for Windows [computer software]*. Lincolnwood, IL: Scientific Software International, Inc.
- Lawal, B. (2003). *Categorical data analysis with SAS and SPSS applications*. Mahwah, NJ: Lawrence Erlbaum.
- Lienert, G. A. (1969). Die Konfigurationsfrequenzanalyse als Klassifikationsmittel in der klinischen Psychologie. In M. Irle (Ed.), *Bericht über den 26. Kongreß der Deutschen Gesellschaft für Psychologie 1968 in Tübingen* (pp. 244–255). Göttingen: Hogrefe.
- Lunneborg, C. E. (2005). Runs test. In B. S. Everitt & D. C. Howell (Eds.), *Encyclopedia of statistics in behavioral science* (p. 1771). Chichester, UK: Wiley.
- Marshall, L. L. (1992). Severity of the violence against women scales. *Journal of Family Violence, 7*, 103–121.
- Saunders, D. G. (1994). Posttraumatic stress symptom profiles of battered women: A comparison of survivors in two settings. *Violence and Victims, 9*, 31–44.
- Siegel, S. (1956). *Nonparametric statistics for the behavioral sciences*. New York: McGraw-Hill.
- Stevens, W. L. (1939). Distribution of groups in a sequence of alternatives. *Annals of Eugenics, 9*, 10–17.
- Swed, F. S., & Eisenhart, C. (1943). Tables for testing randomness of grouping in a sequence of alternatives. *Annals of Mathematical Statistics, 14*, 66–87.

- von Eye, A. (2002). *Configural frequency analysis—Methods, models, and applications*. Mahwah, NJ: Lawrence Erlbaum.
- von Eye, A., & Bergman, L. R. (2003). Research strategies in developmental psychopathology: Dimensional identity and the person-oriented approach. *Development and Psychopathology*, *15*, 553–580.
- von Eye, A., & Bogat, G. A. (2005). Logistic regression and prediction configural frequency analysis—A comparison. *Psychology Science*, *47*, 407–414.
- von Eye, A., & Gutiérrez Peña, E. (2004). Configural frequency analysis—The search for extreme cells. *Journal of Applied Statistics*, *31*, 981–997.
- von Eye, A., Mair, P., & Bogat, G. A. (2005). Prediction models for configural frequency analysis. *Psychology Science*, *47*, 342–355.
- von Eye, A., & Mun, E.-Y. (2007). A note on the analysis of difference patterns—Structural zeros by design. *Psychology Science*, *49*, 14–25.
- Wald, A., & Wolfowitz, J. (1940). On a test whether two alternatives are from the same population. *Annals of Mathematical Statistics*, *11*, 147–162.
- Wallis, W. A., & Moore, G. H. (1941). A significance test for time series analysis. *Journal of the American Statistical Association*, *20*, 257–267.
- Walls, T. A., & Schafer, J. L. (2006). *Models for intensive longitudinal data*. New York: Oxford University Press.

# Chapter 12

## Advances in Dynamic Factor Analysis of Psychological Processes

Peter C.M. Molenaar and Nilam Ram

The currently dominant, myopic approach to statistical analysis in psychology is based on analysis of inter-individual variation. Differences between subjects drawn from a population of subjects provide the information to make inferences about states of affairs at the population level. For instance, the factor structure of a personality test is determined by drawing a random sample of subjects from the population of interest, estimating the item correlation matrix by pooling across the scores of sampled subjects, and generalizing the results of the ensuing factor analysis to the population of subjects.

Pooling across subjects is the hall-mark of analyses of inter-individual variation. Such pooling implies that the individuality of each subject in the population is immaterial to the statistical analysis—subjects in a homogeneous population are considered to be exchangeable like atoms in a homogeneous gas, constituting replications of each other. Accordingly, the population is conceived of as a set of statistical atoms or clones in which the variation between atoms (inter-individual variation) has the same (factor) structure as the variation of each atom in time (intra-individual variation).

This perspective underlying analyses of inter-individual variation would seem to imply that results which hold in a homogeneous population also apply to each of the individual subjects making up this population. That is, the variation between subjects at each point in time has to be qualitatively and quantitatively the same as the variation which characterizes the life trajectory of each individual subject. Therefore results obtained in analyses of inter-individual variation can be, and abundantly are, applied to assess, counsel and treat individual subjects.

It has been shown recently (Molenaar, 2004), however, that in general the inferred states of affairs at the population level, as determined in analyses of inter-individual variation, do not apply at the level of intra-individual variation characterizing the life trajectories of individual subjects making up the population. This is a direct consequence of general mathematical theorems—the so-called classical ergodic

---

P.C.M. Molenaar (✉)  
Developmental Psychology  
Pennsylvania State University  
University Park, PA 16802-1294, Pennsylvania, USA  
e-mail: pxm21@psu.edu

theorems—which have far-reaching implications for the way in which psychological processes have to be analyzed.

These theorems, which are heuristically described below, imply the necessity of using alternative approaches for the analysis of intra-individual variation, based on single-subject and replicated time series analysis. Next an overview is presented of dynamic factor models for the analysis of multivariate time series and the various ways to fit these models to the data. Some persistent misunderstandings in the recent literature on dynamic factor analysis will be addressed and an illustrative empirical application of factor analysis of mood change during pregnancy data is presented. The next topic is innovative—a new dynamic factor model for the analysis of multivariate time series having time-varying statistical characteristics is introduced and applied to simulated data. In the closing section future extensions of dynamic factor analysis are outlined.

## The Classical Ergodic Theorems

The standard approach to statistical analysis in psychology is to draw a random sample of subjects from a presumably homogeneous population of subjects, analyze the structure of inter-individual variation in this sample, and then generalize the results thus obtained to the population. Such analysis of inter-individual variation underlies all known statistical techniques, like analysis of variance, regression analysis, factor analysis, multilevel modeling, mixture modeling, etc. Consequently the standard approach to psychological data analysis aims to describe the state of affairs at the population level, not at the level of individual subjects. Accordingly, the individuality of each of the persons in the sample and population is deemed immaterial: the subjects are considered to be replications devoid of individuality. This is expressed by the assumption that subjects are homogeneous in all respects relevant to the analysis. This essential homogeneity assumption allows for the averaging (pooling) of the scores of the sampled subjects in the determination of statistics (e.g., means, variances, correlations, model parameters) to be generalized to the population.

However, the standard approach based on analysis of inter-individual variation is incorrect if a psychological process under investigation does not obey stringent conditions (Molenaar, 2004). The proof is based on the classical ergodic theorems; theorems of extreme generality which apply to all measurable processes irrespective of their content (cf. Choe, 2005, for a modern proof of the first ergodic theorem of Birkhoff). The conditions concerned are specified at the close of this section.

To appreciate the far-reaching implications of the classical ergodic theorems, it is helpful to first characterize the elementary methodological situation in psychological measurement. Instead of postulating an abstract population of subjects, consider an ensemble of actually existing human subjects whose measurable psychological processes are functions of time and place (the basic Kantian dimensions of phenomenological reality).

To simplify the following discussion, without affecting its generality, the focus will be on time as the basic dimension along which psychological processes are



evolving. The ensuing basic scientific representation of a human subject in psychology therefore is a high-dimensional dynamic system, the output of which consists of a set of time-dependent processes. The system includes important functional subsystems such as the perceptual, emotional, cognitive, and physiological systems, as well as their dynamic interrelationships. The complete set of measurable time-dependent variables characterizing the system's behavior can be represented as the coordinates of a high-dimensional space which will be referred to as the behavior space. The behavior space contains all the scientifically relevant information about a person (cf. De Groot, 1954).

Within the behavior space, inter-individual variation is defined as follows:

- (i) select a fixed subset of variables;
- (ii) select one or more fixed time points as measurement occasions,
- (iii) determine the variation of the scores on the selected variables at the selected time points by pooling across subjects.

Analysis of inter-individual variation thus defined is called R-technique by Cattell (1952).

In contrast, intra-individual variation is defined as follows:

- (i) select a fixed subset of variables;
- (ii) select a fixed subject;
- (iii) determine the variation of the scores of the single subject on the selected variables by pooling across time points.

Analysis of intra-individual variation thus defined is called P-technique by Cattell (1952).

With these preliminary specifications in place, the following heuristic description of the content of the classical ergodic theorems can be given. These theorems detail the conditions that must be met in order to generalize from analyses of inter-individual variation to analyses of intra-individual variation, and vice versa.

The conditions of the ergodic theorems are twofold. First, a process has to be stationary, meaning that the mean function must be constant in time (without trends or cycles) and the sequential dependence must be constant in time (with constant variance and sequential correlations depending only upon the relative distance between time points; cf. Hannan, 1970).

Second, each person in the population must obey the same dynamics. If a dynamic process obeys both conditions, it is called ergodic; if one or both conditions are violated, it is called non-ergodic. For ergodic processes, lawful relationships between inter- and intra-individual variation exist, but for non-ergodic processes these relationships do not exist. Put another way, if the conditions of ergodicity are violated, no a priori relationship exists between results obtained in an analysis of inter-individual variation (R-technique) and results obtained in an analogous analysis of intra-individual variation (P-technique).

The consequences of the classical ergodic theorems affect all psychological statistical methodology (e.g., Molenaar, Huizenga, & Nesselroade, 2003; Borsboom, 2005). Because "development" generally implies that some kind of growth or decline occurs, developmental processes are almost always non-stationary and are,

therefore, non-ergodic. Generally, developmental scientists consider change that occurs in average or mean levels of a process. However, change may also occur in variances or sequential dependencies over time.

## Overview of Dynamic Factor Modeling

Dynamic factor analysis is factor analysis of single-subject multivariate time series. It constitutes a generalization of Cattell's P-technique (Cattell, 1952) in that it takes account of lead-lag patterns in the dynamic relationships between latent factor series and observed series. In contrast, P-technique involves straight-forward application of standard factor analysis to multivariate time series without accommodation of lead-lag sequential dependencies; the reader is referred to Molenaar and Nesselroade (2008) for further discussion of the domain of application of P-technique.

In what follows, bold face lower case letters denote vectors; bold face upper case letters denote matrices; an apostrophe attached to vectors or matrices denotes transposition. Let  $\mathbf{y}(t) = [y_1(t), y_2(t), \dots, y_p(t)]'$  be a  $p$ -variate time series,  $p \geq 1$ , observed at equidistant time points  $t = 1, 2, \dots, T$ . The mean of  $\mathbf{y}(t)$  at each time point  $t$  is:  $E[\mathbf{y}(t)] = \boldsymbol{\mu}(t)$ . Considered as function of  $t$ ,  $\boldsymbol{\mu}(t)$  denotes the  $p$ -variate mean function (trend) of  $\mathbf{y}(t)$ . If  $\boldsymbol{\mu}(t) = \boldsymbol{\mu}$ , i.e., if the mean function is constant in time, then  $\mathbf{y}(t)$  has a stationary mean function. The sequential covariance of  $\mathbf{y}(t)$  between a given pair of time points  $t_1$  and  $t_2$  is defined as:  $\boldsymbol{\Sigma}(t_1, t_2) = \text{cov}[\mathbf{y}(t_1), \mathbf{y}(t_2)']$ . Considered as function of 2-D time,  $\boldsymbol{\Sigma}(t_1, t_2)$  denotes the  $(p,p)$ -variate covariance function of  $\mathbf{y}(t)$ . If  $\boldsymbol{\Sigma}(t_1, t_2)$  only depends upon the relative time difference  $t_1 - t_2 = u$ , i.e.,  $\boldsymbol{\Sigma}(t_1, t_2) = \boldsymbol{\Sigma}(t_1 - t_2) = \boldsymbol{\Sigma}(u)$ ,  $u = 0, \pm 1, \dots, \pm T - 1$ , then  $\mathbf{y}(t)$  has stationary covariance function depending only on lag  $u$ . If both the mean function and covariance function of  $\mathbf{y}(t)$  are stationary then  $\mathbf{y}(t)$  is called a weakly stationary  $p$ -variate time series.

In the first publication on dynamic factor analysis in psychology the following model for weakly stationary multivariate Gaussian series was considered (Molenaar, 1985):

$$\mathbf{y}(t) = \boldsymbol{\mu} + \boldsymbol{\Lambda}(0)\boldsymbol{\eta}(t) + \boldsymbol{\Lambda}(1)\boldsymbol{\eta}(t-1) + \dots + \boldsymbol{\Lambda}(s)\boldsymbol{\eta}(t-s) + \boldsymbol{\epsilon}(t) \quad (1a)$$

where  $\mathbf{y}(t)$  is an observed  $p$ -variate time series,  $\boldsymbol{\eta}(t)$  is a latent  $q$ -variate factor series and  $\boldsymbol{\epsilon}(t)$  is a  $p$ -variate measurement error series. Because our main interest is not in the constant mean function  $\boldsymbol{\mu}$ , it is conveniently assumed that  $\boldsymbol{\mu} = \mathbf{0}$ . Then all time series in (1a),  $\mathbf{y}(t)$ ,  $\boldsymbol{\eta}(t)$ , and  $\boldsymbol{\epsilon}(t)$ , are zero mean weakly stationary.

The  $\boldsymbol{\Lambda}(u)$ ,  $u = 0, 1, \dots, s$ , are  $(p,q)$ -dimensional matrices of lagged factor loadings, where  $s \geq 0$  is the maximum lag. These lagged factor loadings allow for the possibility that the realization of the latent factor series  $\boldsymbol{\eta}(t)$  at each time  $t$  not only has an instantaneous effect on  $\mathbf{y}(t)$ , but also may have delayed effects at later time points  $t+1, \dots, t+s$ . The linear combination  $\boldsymbol{\Lambda}(0)\boldsymbol{\eta}(t) + \boldsymbol{\Lambda}(1)\boldsymbol{\eta}(t-1) + \dots + \boldsymbol{\Lambda}(s)\boldsymbol{\eta}(t-s)$  is called a convolution.

For later reference the limiting case of (1a) is considered in which  $s=0$ , i.e., the case in which there are no lagged factor loadings:

$$\mathbf{y}(t) = \mathbf{\Lambda}(0)\boldsymbol{\eta}(t) + \boldsymbol{\varepsilon}(t) \quad (1b)$$

Equation (1b) is a special instance of (1a). It has been assigned several labels, including state-space model (e.g., Molenaar 1985) and process factor model (e.g., Browne & Nesselroade, 2005). In what follows (1b) will be referred to as a state-space model. As will be explained shortly, (1b) has a special property not shared by (1a).

The dynamic factor model (1a) was inspired by Brillinger's (1975) principal component analysis of multivariate weakly stationary time series. It differs from Brillinger's approach in a number of respects, perhaps the most important of which is that in (1a) the convolution of lagged factor loadings and latent factor series is finite and only depends at each time point  $t$  upon earlier realizations  $\boldsymbol{\eta}(t), \dots, \boldsymbol{\eta}(t-s)$  of the latent factor series, whereas in Brillinger's model this convolution is infinite and also depends upon future realizations  $\boldsymbol{\eta}(t+1), \boldsymbol{\eta}(t+2), \dots$ . Another important difference relates to the statistical characteristics of the measurement error series in each of the two models.

To complete the definition of the dynamic factor model under consideration, the covariance functions of the time series occurring in (1a)–(1b) have to be specified. Let  $\text{diag-}\mathbf{A}$  denote a square diagonal matrix  $\mathbf{A}$  (all off-diagonal elements being zero). Then the covariance functions associated with the right-hand side of (1a) are:

$$\begin{aligned} \text{cov}[\boldsymbol{\varepsilon}(t), \boldsymbol{\varepsilon}(t-u)'] &= \text{diag-}\boldsymbol{\Theta}(u); u = 0, \pm 1, \dots \\ \text{cov}[\boldsymbol{\eta}(t), \boldsymbol{\eta}(t-u)'] &= \boldsymbol{\Psi}(u) = 0, \pm 1, \dots \end{aligned} \quad (1c)$$

The first equation of (1c) defines the covariance function of the measurement error process. The univariate measurement error process  $\varepsilon_k(t)$  associated with the  $k$ th observed univariate series  $y_k(t)$ ,  $k \in \{1, \dots, p\}$ , is allowed to have nonzero sequential covariance:  $\text{cov}[\varepsilon_k(t), \varepsilon_k(t-u)] \neq 0$  for  $\forall u$ . However, measurement error processes  $\varepsilon_k(t)$  and  $\varepsilon_m(t)$  associated with different observed univariate series  $y_k(t)$  and  $y_m(t)$ ,  $k \neq m \in \{1, \dots, p\}$ , are assumed to be uncorrelated at all lags  $u$ :  $\text{cov}[\varepsilon_k(t), \varepsilon_m(t-u)] = 0$  for  $\forall u$ . The second equation in (1c) defines the covariance function of the latent factor series.

**Some intricacies associated with (1)** It was proven in Molenaar (1985) that under certain conditions the covariance function of the latent factor series defined in (1c) is not identifiable. That means that under certain conditions the variances and sequential covariances in  $\boldsymbol{\Psi}(u)$ ,  $u = 0, \pm 1, \dots$ , cannot be estimated, but have to be fixed a priori. The conditions concerned are twofold. Firstly, the maximum lag  $s$  of the matrices of factor loadings  $\mathbf{\Lambda}(u)$ ,  $u = 0, 1, \dots, s$ , has to be larger than zero:  $s > 0$ . Secondly, all factor loadings in  $\mathbf{\Lambda}(u)$ ,  $u = 0, 1, \dots, s$ , should be free parameters. That is, the dynamic factor model should be exploratory, having no a priori pattern of fixed factor loadings.

If both these conditions obtain then the covariance function of the latent factor series has to be fixed a priori.  $\boldsymbol{\Psi}(u)$ ,  $u=0, \pm 1, \dots$ , then can be fixed at any possible covariance function without affecting the goodness of fit of the model.

In Molenaar (1985) the simplest covariance function for  $\boldsymbol{\eta}(t)$  was chosen:  $\text{cov}[\boldsymbol{\eta}(t), \boldsymbol{\eta}(t-u)] = \delta(u)\mathbf{I}_q$ , where  $\delta(u)$  is the Kronecker delta ( $\delta(u) = 1$  if  $u = 0$ ;  $\delta(u) = 0$  if  $u \neq 0$ ) and  $\mathbf{I}_q$  is the  $(q,q)$ -dimensional identity matrix. This particular choice implies that the latent factor series lacks instantaneous as well as sequential dependencies. Accordingly,  $\boldsymbol{\eta}(t)$  can be conceived of as a sequence of random shocks, often referred to in the engineering literature as a white noise sequence. But quite other choices are possible (cf. Molenaar & Nesselrode, 2001).

If the dynamic factor model is confirmatory, i.e., if an a priori pattern of fixed factor loadings has been specified in  $\boldsymbol{\Lambda}(u)$ ,  $u=0,1,\dots,s$ , then the covariance function of the latent factor series is identifiable. Also if  $s=0$ , i.e., if the state space model (1b) applies, then the covariance function of the latent factor series is identifiable. In these cases  $\boldsymbol{\Psi}(u)$ ,  $u = 0, \pm 1, \dots$ , can be freely estimated or, alternatively, a parametric time series model for  $\boldsymbol{\eta}(t)$  (and hence for its covariance function) can be considered. For instance, the latent factor series  $\boldsymbol{\eta}(t)$  can be represented by a vector autoregression:  $\boldsymbol{\eta}(t) = \mathbf{B}\boldsymbol{\eta}(t-1) + \boldsymbol{\zeta}(t)$ , where  $\mathbf{B}$  is a  $(q,q)$ -dimensional matrix of regression coefficients and  $\boldsymbol{\zeta}(t)$  is a  $q$ -variate white noise sequence.

Given that for the state-space model (1b) the covariance function (or a parametric time series model) of the latent factor series always is identifiable, it would seem rational to restrict attention to this type of model. At least for exploratory dynamic factor analyses, this would preclude the need to have to arbitrarily fix  $\boldsymbol{\Psi}(u)$ ,  $u=0,\pm 1,\dots$ , which is necessary in such applications of (1a). However, it can be shown that for certain types of psychological time series the state-space model is too restrictive. In particular when the effect of  $\boldsymbol{\eta}(t)$  on  $\mathbf{y}(t)$  is delayed, the state space model will be inappropriate. For these time series one needs the general dynamic factor model (1a) in which  $s > 0$ . Such delays occur, for instance, in multi-lead EEG registrations of electrocortical brain fields caused by a finite set of underlying neural sources. The activity of the neural sources is represented by the latent factor series  $\boldsymbol{\eta}(t)$  and the EEG registrations by the manifest series  $\mathbf{y}(t)$ . The effects of each neural source travel with finite speed along long-range axons to their target regions. Because target regions are located at different distances from a given neural source and the effects of a volley of action potentials of a neural source on the ongoing activity of target areas take time to dissipate, the relationships between  $\boldsymbol{\eta}(t)$  and  $\mathbf{y}(t)$  will show complex patterns of delays.

But the pattern of delayed relationships between the latent factor series and the observed series does not have to be complex in order to invalidate the state space model (1b). This will be illustrated with data simulated with the following simple dynamic 1-factor model. Let  $\mathbf{y}(t)$  be a 5-variate time series and  $\boldsymbol{\eta}(t)$  a univariate latent factor series. Let  $\boldsymbol{\Lambda}(0) = [1.0, 0.9, 0.8, 0.7, 0.6]'$  and  $\boldsymbol{\Lambda}(1) = [0, -0.5, 0, 0, 0]'$ . Hence  $s=1$ . Notice that all elements of  $\boldsymbol{\Lambda}(1)$  are zero, except the lagged loading on  $y_2(t)$ :  $\lambda_2(1) = -0.5$ . Hence there only is a simple delayed effect of  $\boldsymbol{\eta}(t)$  on  $y_2(t)$ . Let all measurement errors be white noise series having variance equal to  $\theta_k(0) = 0.5$ ,  $k = 1, \dots, 5$ . The autoregressive model for the univariate latent factor series is:  $\boldsymbol{\eta}(t) = 0.7\boldsymbol{\eta}(t-1) + \boldsymbol{\zeta}(t)$ , where the variance of the white process noise is  $\text{var}[\boldsymbol{\zeta}(t)] = 1.0$ .

A 5-variate time series of length  $T=400$  has been generated. Although the simulation model almost is a state-space model (save for one delayed factor loading  $\lambda_2(1) = -0.5$ ), the state-space model (1b) with univariate state process  $\boldsymbol{\eta}(t)$  does

not fit the data. Using a window width of 5 (cf. Molenaar, 1985), chi-square=751.95, degrees of freedom=313, prob.=0.0; non-normed fit index=0.93; comparative fit index=0.93. The non-normed fit index and the comparative fit index should have values larger than 0.95 for acceptable model fits. In contrast, the general dynamic 1-factor model (1a) with  $s=5$  yields an acceptable fit: chi-square=235.78, degrees of freedom=295, prob.=1.0; non-normed fit index=1.0; comparative fit index=1.0.

**Alternative ways to fit (1)** Analysis of stationary multivariate Gaussian time series based on the dynamic factor model (1) can proceed in various ways:

- 1) Based on the sequential covariance function, arranged in a so-called block-Toeplitz matrix (see Molenaar, 1985, for a detailed description). This can be carried out by means of commercially available structural equation modeling software. Browne and Zhang (2005, 2007) provide an alternative method for fitting a dynamic factor analysis model to a sequential autocorrelation function. Their approach, implemented in the DyFA computer program, does not use a block-Toeplitz matrix in the estimation process. It fits the model directly to the autocorrelation function without duplicating the constituent autocorrelation matrices to form a block-Toeplitz matrix. The DyFa program can be downloaded from: <http://faculty.psy.ohio-state.edu/browne/software.php>
- 2) Based on Expectation-Maximization of the raw data likelihood associated with state-space models (1b), where the latent factor series is estimated by means of the recursive Kalman filter (Expectation Step) and the parameters are estimated by means of multivariate regression (Maximization Step). See Hamaker, Dolan, and Molenaar (2005); Hamaker, Nesselrode, and Molenaar (2007) for applications; the software used in these applications can be obtained from: <http://users.fmg.uva.nl/cdolan/>
- 3) In the frequency domain, after discrete Fourier transformation. This yields a set of frequency-dependent complex-valued factor models that can be subjected to standard ML factor analysis (Molenaar, 1987). The software for dynamic factor analysis in the frequency domain can be obtained from the first author. Special nonlinearly constrained variants of this approach have been developed for the purpose of neural source estimation in brain imaging (Grasman, Huizenga, Waldorp, Böcker, & Molenaar, 2005). The software concerned can be obtained from: <http://users.fmg.uva.nl/rgrasman/>
- 4) Rewriting the model as a state-space model, with extended state containing not only the latent factor series but also the unknown parameters. This results in a nonlinear state-space model for which the extended Kalman filter is used to estimate the extended state, including the parameters. This will be discussed further in a later section.

### ***Application in Replicated Time Series Design***

Dynamic factor analysis constitutes a generalization of Cattell's P-technique (Cattell, Cattell, & Rhymer, 1947). P-technique involves application of the standard factor

model to the zero-lag covariance matrix  $\Sigma(0)$  of an observed multivariate time series (cf. Jones & Nesselrode, 1990), whereas dynamic factor modeling involves analysis of the observed series' complete sequential covariance function  $\Sigma(u)$ ,  $u = 0, \pm 1, \dots$ . Excellent recent discussions and illustrations of dynamic factor analysis of psychological time series can be found in Browne and Nesselrode (2005); Browne and Zhang (2007); Ferrer and Nesselrode (2003); Ferrer (2006); Hamaker, Dolan, and Molenaar, (2005); Kim, Zhu, Chang, Bentler, and Ernst (2007); Mumma (2004); Nesselrode, McArdle, Aggen, and Meyers (2002); Sbarra and Ferrer (2006); Shiftren, Hooker, Wood, and Nesselrode (1997); and Wood and Brown (1994). Dynamic factor modeling is increasingly prominent in econometrics, see for instance Forni, Hallin, Lippi, and Reichlin (2005); Stock and Watson (2005).

In this section an innovative application of dynamic factor analysis will be presented using multivariate time series data of multiple subjects and performing new types of statistical tests to uncover nomothetic relationships underlying idiographic observations. It concerns a multi-subject dynamic factor analysis of mood change during pregnancy data is presented, using the block-Toeplitz approach introduced in Molenaar (1985). A complete description of the data is given in Lebo and Nesselrode (1978). Here only part of the data will be analyzed (we thank Dr. Michael Lebo for making the data available). Only the data of three of the five subjects will be analyzed. Moreover, only five items will be selected: Enthusiastic, Energetic, Active, Peppy, and Lively. Keeping the same numbering of subjects as in Lebo and Nesselrode (1978), the length of this 5-variate observed time series (daily measurements) is  $T=112$  for Subject 1,  $T=110$  for Subject 3, and  $T=103$  for Subject 5.

State space models (1b) with 2-variate latent factor series are fitted to the data of the three subjects, using the block-Toeplitz correlation matrix approach with window width of 2 (cf. Molenaar, 1985). A window width of 2 implies that the covariance function of the latent factor series can be estimated up to lag  $\pm 1$ :  $\text{cov}[\eta(t), \eta(t-u)'] = \Psi(u)$ ,  $u = 0, \pm 1$ . No equality constraints across subjects are imposed on the (5,2)-D matrices of factor loadings. The subject-specific patterns of free and fixed factor loadings in  $\Lambda(0)$  were determined in preliminary confirmatory oblique P-technique analyses. The measurement errors are assumed to lack sequential dependencies. No equality constraints across subjects are imposed on the zero lag covariance matrices  $\text{cov}[\epsilon(t), \epsilon(t)'] = \text{diag-}\Theta(0)$  of the measurement errors. In contrast, it is assumed that the sequential correlation function of the bivariate latent factor series,  $\text{cor}[\eta(t), \eta(t-u)'] = \Psi(u)$ ,  $u = 0, \pm 1$ , is invariant across the three subjects.

Notice that the state-space models specified above are partly subject-specific and partly invariant across subjects. No equality constraints across subjects have been imposed on the factor loadings and measurement error variances, hence  $\Lambda(0)$  and  $\text{diag-}\Theta(0)$  are subject-specific. But the sequential correlation function of the latent factor series  $\Psi(u)$ ,  $u = 0, \pm 1$ , is constrained to be invariant across the three subjects. This pattern of subject-specific factor loadings and measurement error variances in combination with invariant sequential correlation function of the latent factor series implements the new definition of measurement equivalence proposed in Nesselrode, Gerstorf, Hardy, and Ram (2007). Whereas traditional definitions of measurement equivalence require that at least the matrices of factor loadings are

invariant across subjects, it is argued by Nesselroade et al. (2007) that factor loadings should be allowed to be subject-specific while correlations among factor series should be invariant across subjects.

The overall fit of the state-space models to the replicated 5-variate time series is excellent: chi-square = 114.40, degrees of freedom = 129, prob. = 0.82; non-normed fit index = 1.0; comparative fit index = 1.0. Hence the assessments of the three subjects can be considered measurement equivalent in the sense of Nesselroade et al. (2007). For Subject 1  $\eta_1(t)$  has significant positive factor loadings on Enthusiastic, Energetic, Active, and Lively, whereas  $\eta_1(t)$  has zero loading on Peppy. For this subject  $\eta_2(t)$  has unit loading on Peppy (no measurement error) and significant loading of 0.30 on Energetic. For Subject 2  $\eta_1(t)$  has significant positive factor loadings on Enthusiastic, Energetic, Active and Lively, whereas  $\eta_1(t)$  has zero loading on Peppy. For this subject  $\eta_2(t)$  has unit loading on Peppy (no measurement error) and significant loadings of 0.26 on Enthusiastic and 0.24 on Lively. Finally, for Subject 3  $\eta_1(t)$  has significant positive factor loadings on Energetic, Active, Peppy and Lively, whereas  $\eta_1(t)$  has zero loading on Enthusiastic. For this subject  $\eta_2(t)$  has unit loading on Enthusiastic (no measurement error) and a significant loading of 0.17 on Lively.

Given that  $\eta_1(t)$  has significant positive factor loadings on four of the five items for each subject and following Lebo and Nesselroade (1978), this factor series can be interpreted as Energy. Interpretation based on the pattern of factor loadings associated with  $\eta_2(t)$  also is unambiguous for Subjects 1 and 3—this factor series has unit loading on Peppy in combination with zero measurement error variance. Hence  $\eta_2(t)$  for Subjects 1 and 3 could be interpreted as Peppy. But for Subject 5  $\eta_2(t)$  has unit loading on Enthusiastic in combination with zero measurement error variance. According to this pattern of factor loadings,  $\eta_2(t)$  for Subject 5 should be interpreted as Enthusiastic. It therefore is problematic to assign an interpretation to  $\eta_2(t)$  which is invariant across the three subjects, at least if this interpretation is based on the patterns of subject-specific factor loadings.

An alternative way of assigning interpretations to  $\eta_1(t)$  and  $\eta_2(t)$  follows from a suggestion which is more in line with the basic tenet of the new definition of measurement equivalence of Nesselroade et al. (2007). Instead of considering patterns of factors loadings, interpretations of  $\eta_1(t)$  and  $\eta_2(t)$  are based on the sequential correlation function of the latent factor series. Nesselroade (2007, p. 258) also suggests this alternative way of interpreting factor series, in that "... invariance might be sought at the process level by focusing on patterns of auto- and cross-regression of latent factors, for example, in individual level dynamic factor models". The estimated sequential correlation function  $\Psi(u)$ ,  $u = 0, \pm 1$  of the latent factor series  $\boldsymbol{\eta}(t)$ , assumed to be invariant across the three subjects, has significant zero lag correlation:  $\text{est.-cor}[\eta_1(t), \eta_2(t)] = 0.69$ . Also the autocorrelation of  $\eta_1(t)$  at lag  $\pm 1$  is significant:  $\text{est.-cor}[\eta_1(t), \eta_2(t \pm 1)] = 0.19$ . The remaining elements of  $\text{est.-}\Psi(\pm 1)$  are not significant. Consequently,  $\eta_1(t)$  has a certain degree of stability (i.e., significant autocorrelation) and can be interpreted as Stable Energy, whereas  $\eta_2(t)$  resembles a white noise sequence and can be interpreted as Unstable Energy.

In conclusion of this section, it has been shown that using the multi-group option in commercially available structural equation modeling software, in combination with the block-Toeplitz matrix approach introduced in Molenaar (1985), it is possible to test for equivalences across different subjects using data obtained in a replicated time series design. In this approach different subjects constitute different “groups”. In this way it is possible to detect nomothetic relationships based on idiographic data, or stated otherwise, to detect inter-individual relationships based on intra-individual variation. This approach has been illustrated by implementing the new definition of measurement equivalence proposed by Nesselroade et al. (2007). But it can be applied in many other situations, including testing for measurement equivalence according to the traditional definitions.

## Nonstationary Dynamic Factor Analysis

To reiterate, the two criteria for ergodicity are stationarity in time and homogeneity across subjects. In the previous application we focused on testing for homogeneity of the sequential correlations function across three subjects. Now we turn to a consideration of stationarity; the other criterion for ergodicity. A new approach is presented to test for stationarity and model nonstationary processes. The new approach is based on a state-space model with arbitrarily time-varying (nonstationary) parameters. The model concerned is:

$$\begin{aligned} \mathbf{y}(t) &= \mathbf{\Lambda}[\boldsymbol{\theta}(t)]\boldsymbol{\eta}(t) + \mathbf{v}(t) \\ \boldsymbol{\eta}(t+1) &= \mathbf{B}[\boldsymbol{\theta}(t)]\boldsymbol{\eta}(t) + \boldsymbol{\zeta}(t+1) \\ \boldsymbol{\theta}(t+1) &= \boldsymbol{\theta}(t) + \boldsymbol{\xi}(t+1) \end{aligned} \quad (2a)$$

In (2a)  $\mathbf{y}(t)$  denotes the observed  $p$ -variate time series;  $\boldsymbol{\eta}(t)$  the  $q$ -variate latent factor series (state process). The first equation of (2a) shows that factor loadings in  $\mathbf{\Lambda}[\boldsymbol{\theta}(t)]$  depend upon a time-varying parameter-vector  $\boldsymbol{\theta}(t)$ . The second equation describes the time evolution of the state process  $\boldsymbol{\eta}(t)$ ; the autoregressive weights in  $\mathbf{B}[\boldsymbol{\theta}(t)]$  depend upon  $\boldsymbol{\theta}(t)$  and therefore can be arbitrarily time-varying. The third equation in (2a) describes the time-dependent variation of the unknown parameters. The  $r$ -variate parameter vector process  $\boldsymbol{\theta}(t)$  obeys a random walk with Gaussian white noise innovations  $\boldsymbol{\xi}(t)$ . The covariance functions associated with (2a) are given in (2b):

$$\begin{aligned} \text{cov}[\mathbf{v}(t), \mathbf{v}(t-u)'] &= \delta(u)\text{diag-}\boldsymbol{\Xi} \\ \text{cov}[\boldsymbol{\zeta}(t), \boldsymbol{\zeta}(t-u)'] &= \delta(u)\text{diag-}\boldsymbol{\Psi} \\ \text{cov}[\boldsymbol{\xi}(t), \boldsymbol{\xi}(t-u)'] &= \delta(u)\text{diag-}\boldsymbol{\Phi} \end{aligned} \quad (2b)$$

To fit the state-space model with time-varying parameters to an observed multivariate time series, use is made of a combination of the second and fourth estimation techniques mentioned at the end of section “Some intricacies associated with (1)”. That is, a combination of the EM algorithm and the extended Kalman filter/



smoother. First, an extended state process is defined. The extended state process consists of the original latent factor series and the time-varying parameter process:  $\mathbf{x}(t)' = [\boldsymbol{\eta}(t)', \boldsymbol{\theta}(t)']$ . Then, using the extended state process  $\mathbf{x}(t)$ , (2a) is rewritten as the following nonlinear state-space model:

$$\begin{aligned} y(t) &= \mathbf{h}[\mathbf{x}(t), t] + \mathbf{v}(t) \\ \mathbf{x}(t + 1) &= \mathbf{f}[\mathbf{x}(t), t] + \mathbf{w}(t) \end{aligned} \tag{3}$$

The vector-valued nonlinear functions  $\mathbf{h}[\mathbf{x}(t), t]$  and  $\mathbf{f}[\mathbf{x}(t), t]$  consist of products of the entries of  $\mathbf{x}(t)$ . The  $(q+r)$ -dimensional innovations process  $\mathbf{w}(t)$  is defined as the composition of the innovation processes  $\boldsymbol{\zeta}(t)$  and  $\boldsymbol{\xi}(t)$ :  $\mathbf{w}(t)' = [\boldsymbol{\zeta}(t)', \boldsymbol{\xi}(t)']$ .

In Fig. 12.1 an illustrative result is shown of an application of this new technique to a simulated time series. A 4-variate time series has been generated by means of the state-space model with time-varying parameters. The model has a univariate latent state process ( $q=1$ ). The autoregressive coefficient  $\mathbf{B}[\boldsymbol{\theta}(t)] = b(t)$  in the true process model for the latent state [second equation in (2a)] increases linearly from 0.0 to 0.9 over the observation interval comprising  $T=100$  time points. Depicted is the esti-

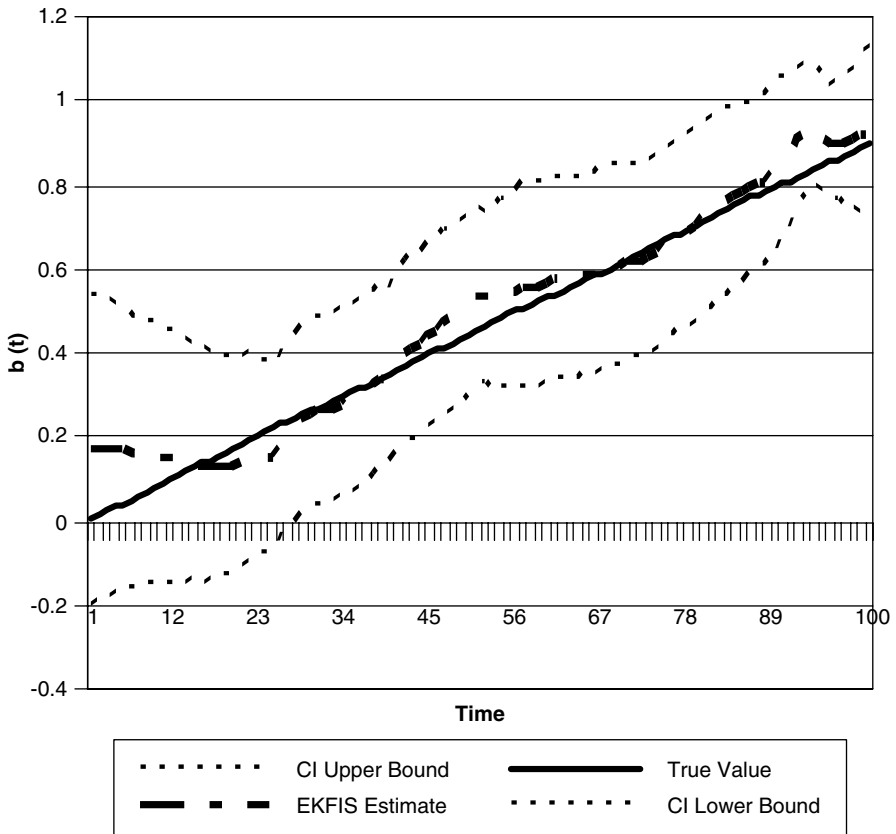

**Fig. 12.1** EKFIS estimate of time-varying coefficient  $b(t)$  in the autoregressive model for the latent factor scores

mate of this autoregressive coefficient  $b(t)$  obtained by means of (3). It is clear that the estimated trajectory closely tracks the true time-varying path of this parameter.

## Discussion and Conclusion

The future of dynamic factor analysis is challenging because of the necessity to focus on the structure on intra-individual variation in the study of nonergodic psychological processes. This necessity follows directly from the classical ergodic theorems. In case subjects are heterogeneous with respect to a particular psychological process, that is, in case person-specific dynamics describe the intra-individual variation of this process, one can only obtain valid information about such non-ergodic process by means of dedicated time series analysis. In a similar vein, in case a psychological process is nonstationary, like developmental and learning processes, but also many clinical and biomedical processes, one also can only obtain valid information about such a nonergodic process by means of dedicated time series analysis.

The implications of the classical ergodic theorems have a very broad impact, not only in psychometrics and psychology but also in the biological and medical sciences. They imply that growth processes as well as disease processes have to be analyzed in organism-specific and patient-specific ways, focusing on the intra-individual variation concerned. We presently are involved in a series of pilot studies using stochastic person-specific control of day-today intra-individual variation in disease processes such as asthma, diabetes, and daily stress. In these projects dynamic factor analysis of non-stationary time series is used to track momentary changes in a disease process as function of medication dose, environmental, emotional and contingent stressors. Then, using predictive control methods based on the fitted time-varying state-space patient models, optimal medication dose is determined at each point in time in a patient-specific way. It is known that the effects of medication, in particular for diabetes and asthma, are patient-specific. Dynamic factor analysis of nonstationary multivariate time series is excellently equipped to accommodate substantial patient-specific reactions to medication and counteract the occurrence of contingent disturbances occurring under normal daily life circumstances.

## References

- Borsboom, D. (2005). *Measuring the mind: Conceptual issues in contemporary psychometrics*. Cambridge: Cambridge University Press.
- Brillinger, D. R. (1975). *Time series: Data analysis and theory*. New York: Holt, Rinehart & Winston.
- Browne, M. W., & Nesselrode, J. R. (2005). Representing psychological processes with dynamic factor models: Some promising uses and extensions of ARMA time series models. In A. Maydeu-Olivares & J. J. McArdle (Eds.), *Psychometrics: A festschrift to Roderick P. McDonald* (pp. 415–452). Mahwah, NJ: Erlbaum.
- Browne, M. W., & Zhang, G. (2005). User's Guide: DyFa: Dynamic factor analysis of lagged correlation matrices, version 2.03. [www document and computer program], from <http://quanrm2.psy.ohio-state.edu/browne/>.

- Browne, M. W., & Zhang, G. (2007). Developments in the factor analysis of individual time series. In R. C. MacCallum & R. Cudeck (Eds.), *Factor analysis at 100: Historical developments and future directions*. Mahwah, NJ: Erlbaum.
- Cattell, R. B. (1952). The three basic factor-analytic designs—Their interrelations and derivatives. *Psychological Bulletin*, *49*, 499–520.
- Cattell, R. B., Cattell, A. K. S., & Rhymer, R. D. (1947). P-technique demonstrated in determining psychophysiological source traits in a normal individual. *Psychometrika*, *12*, 267–288.
- Choe, G. H. (2005). *Computational ergodic theory*. Berlin: Springer-Verlag.
- De Groot, A. D. (1954). Scientific personality diagnosis. *Acta Psychologica*, *10*, 220–241.
- Ferrer, E. (2006). Application of dynamic factor analysis to affective processes in dyads. In A. Ong & M. van Dulmen (Eds.), *Handbook of methods in positive psychology* (pp. 41–58). Oxford: Oxford University Press.
- Ferrer, E., & Nesselroade, J. R. (2003). Modeling affective processes in dyadic relations via dynamic factor analysis. *Emotion*, *3*, 344–360.
- Forni, M., Hallin, M., Lippi, F., & Reichlin, L. (2005). The generalized dynamic factor model: One-sided estimation and forecasting. *Journal of the American Statistical Association*, *100*, 830–840.
- Grasman, R. P. P. P., Huijzena, H. M., Waldorp, L. J., Böcker, K. B. E., & Molenaar, P. C. M. (2005). Stochastic maximum likelihood mean and cross-spectrum modeling in neuron-magnetic source estimation. *Digital Signal Processing*, *15*, 56–72.
- Hamaker, E. J., Dolan, C. V., & Molenaar, P. C. M. (2005). Statistical modeling of the individual: Rationale and application of multivariate stationary time series analysis. *Multivariate Behavioral Research*, *40*, 207–233.
- Hamaker, E. J., Nesselroade, J. R., & Molenaar, P. C. M. (2007). The integrated state-space model. *Journal of Research in Personality*, *41*, 295–315.
- Hannan, E. J. (1970). *Multiple time series*. New York: Wiley.
- Jones, C. J., & Nesselroade, J. R. (1990). Multivariate, replicated, single-subject, repeated measures design and P-technique factor analysis: A review of intra-individual change studies. *Experimental Aging Research*, *4*, 171–183.
- Kim, J., Zhu, W., Chang, L., Bentler, P. M., & Ernst, T. (2007). Unified structural equation modeling approach for the analysis of multisubject, multivariate functional MRI data. *Human Brain Mapping*, *28*, 85–93.
- Lebo, A. M., & Nesselroade, J. R. (1978). Intraindividual differences dimensions of mood change during pregnancy identified in five P-technique factor analyses. *Journal of Research in Personality*, *12*, 205–224.
- Molenaar, P. C. M. (1985). A dynamic factor model for the analysis of multivariate time series. *Psychometrika*, *50*, 181–202.
- Molenaar, P. C. M. (1987). Dynamic factor analysis in the frequency domain: Causal modeling of multivariate psychophysiological time series. *Multivariate Behavioral Research*, *22*, 329–353.
- Molenaar, P. C. M. (2004). A manifesto on psychology as idiographic science: Bringing the person back into scientific psychology, this time forever. *Measurement*, *2*, 201–218.
- Molenaar, P. C. M., Huijzena, H. M., & Nesselroade, J. R. (2003). The relationship between the structure of interindividual and intraindividual variability: A theoretical and empirical vindication of developmental systems theory. In U. M. Staudinger & U. Lindenberger (Eds.), *Understanding human development: Dialogues with lifespan psychology* (pp. 339–360). Dordrecht: Kluwer Academic Publishers.
- Molenaar, P. C. M., & Nesselroade, J. R. (2001). Rotation in the dynamic factor modeling of multivariate stationary time series. *Psychometrika*, *66*, 99–107.
- Molenaar, P. C. M., & Nesselroade, J. R. (2008). The recoverability of P-technique factor analysis (to appear in *Multivariate Behavioral Research*).
- Mumma, G. H. (2004). Validation of idiosyncratic cognitive schema in cognitive case formulations: An intraindividual idiographic approach. *Psychological Assessment*, *16*, 211–230.
- Nesselroade, J. R. (2007). Factoring at the individual level: Some matters for the second century of factor analysis. In R. Cudeck & R. C. MacCallum (Eds.), *Factor analysis at 100: Historical developments and future directions* (pp. 249–264). Mahwah, NJ: Erlbaum.

- Nesselroade, J. R., Gerstorf, D., Hardy, S. A., & Ram, N. (2007). Idiographic filters for psychological constructs. *Measurement, 5*, 217–235.
- Nesselroade, J. R., McArdle, J. J., Aggen, S. H., & Meyers, J. M. (2002). Dynamic factor analysis models for representing process in multivariate time series. In D. S. Moskowitz & S. L. Hershberger (Eds.), *Modeling intraindividual variability with repeated measures data: Methods and applications* (pp. 235–265). Mahwah, NJ: Erlbaum.
- Sbarra, D. A., & Ferrer, E. (2006). The structure and process of emotional experience following nonmarital relationship dissolution: Dynamic factor analysis of love, anger, and sadness. *Emotion, 6*, 224–238.
- Shifren, K., Hooker, K., Wood, P., & Nesselroade, J. R. (1997). Structure and variation of mood in individuals with Parkinson's disease: A dynamic factor analysis. *Psychology and Aging, 12*, 328–339.
- Stock, J. H., & Watson, M. W. (2005). *Implications of dynamic factor models for VAR analysis*. Mimeo: Princeton University.
- Wood, P., & Brwon, D. (1994). The study of intra-individual differences by means of dynamic factor models: Rationale, implementation, and interpretation. *Psychological Bulletin, 116*, 166–186.

# Chapter 13

## Hidden Markov Models for Individual Time Series

Ingmar Visser, Maartje E. J. Raijmakers and Han L. J. van der Maas

This chapter introduces hidden Markov models to study and characterize (individual) time series such as observed in psychological experiments of learning, repeated panel data, repeated observations comprising a developmental trajectory etc. Markov models form a broad and flexible class of models with many possible extensions, while at the same time allowing for relatively easy analysis and straightforward interpretation. Here we focus on hidden Markov models with a discrete underlying state space, and observations at discrete times; however, hidden Markov models are not limited to these situations and some pointers are provided to literature on possible extensions.

Markov models have a long history in the social sciences; in psychology, for example, Markov models have been applied in analyzing language (Miller, 1952; Miller & Chomsky, 1963), in describing learning processes in paired associate learning (see Wickens, 1982, for an overview of models and techniques); in sociology, applications are mainly in the analysis of repeated measures of panel data (Langeheine & Van de Pol, 1990); similarly in political science (McCutcheon, 1987). Recently, extensions of Markov models, such as the hidden Markov model, have become increasingly popular, notably in speech recognition (Rabiner, 1989); in biology, in analyzing DNA sequences (Krogh, 1998); in econometric science, in analyzing changes in stock market prices and commodities (Kim, 1994); and finally, in machine learning and data mining (Ghahramani & Jordan, 1997). This chapter focusses on time series data from a psychological experiment in which both speed, i.e., reaction times, and accuracy are modeled simultaneously.

The rest of this chapter is organized as follows: In the next Section hidden Markov models are introduced in a conceptual fashion, and its relationship with other models is described. Following that, in Section “Likelihood, Parameter Estimation, and Inference” the main characteristics of the likelihood function, parameter optimization and

---

I. Visser (✉)  
Developmental Psychology  
University of Amsterdam  
1012 ZA Amsterdam, The Netherlands  
e-mail: i.visser@uva.nl

inference are discussed, thereby introducing the hidden Markov in a more formal way. The next Section discusses analyses of two real life data sets thereby illustrating various characteristics of hidden Markov models and their potential to deal with individual time series. We end by summarizing and discussing the main results.

## Hidden Markov Models: State Space and Transition Dynamics

Hidden Markov models, henceforth HMMs, consist of two main parts: the measurement model and the transition dynamics. The measurement model characterizes the states of the model, whereas the transition dynamics characterizes the dynamics between states over time. The states hence represent the construct of interest, whereas the transition dynamics represent the changes in the construct. For example, consider observation sequences DDDRDDRDDD and RRRDDRDDD. It may be assumed that there are two underlying constructs, republican and democratic, which result in the corresponding voting behavior D and R (for Democrats and Republicans). The first observation sequence is likely to be from a democrat who voted R at only two occasions. It seems reasonable, given this particular observation sequence, to assume that this person is in the democratic state. The second observation sequence on the other hand is very different; here it seems reasonable that this person changes from the republican state to the democratic state, even though she/he has a single R preference on the seventh occasion of measurement.

This example illustrates an important aspect of HMMs, namely that there is no direct relationship between the state and the observations; in particular, a democratic person may vote R every now and then due to any number of reasons, e.g., measurement error, living in Florida, a temporary disapproval of the Democratic candidate etc. When analyzing such data, the question hence is to separate real change, i.e., change in the underlying variable, from the absence of change, in the face of measurement error (see e.g., Eid & Langeheine, 2003, for an application of this type). Below, the state space and the transition dynamics, and their relationship are discussed.

### *State Space and Measurement Model*

In above example, the underlying state of interest was political preference of persons. The number of different possible preferences in this example determines the cardinality of the state space of an HMM that is used to model such data. Here it was assumed that people can be in either of two discrete states, democratic or republican. In this chapter, HMMs with a finite and discrete state space are considered.

Characteristic of HMMs is that the state space is not directly observable; if the example data above is read with D representing dry and R representing rain as observations on consecutive days, merely observing a D or an R can not inform

us as to the state of the weather. Assuming that sunny and rainy periods are fairly stable and last for at least a number of days, observing rain on any given day is not sufficient evidence that the weather is in a rainy period; it may just happen to rain a bit during a period of otherwise stable and sunny weather (see Lystig & Hughes, 2002, for example of the analysis of rainfall data).

The relationship between the states of a hidden Markov model and the observations under consideration is governed by a measurement model. If this relationship is deterministic, i.e., if there is a one-to-one relationship between observations and states, the HMM reduces to a simple Markov model. For example, if voting behavior is taken to directly indicate overall political preference, then observing a D vote indicates someone is democratic. In social science research the relationship between observations and underlying constructs, states in this case, is not usually that straightforward. In particular, measurement error may obscure the relationship, or multiple observations are used to measure a construct, but none of them are assumed to correlate perfectly with the underlying construct. For example, if a person indicates that she/he likes going to parties, this may be taken as evidence of being extraverted, but such an item does not capture all there is to extraversion. A measurement model captures the relationship between observations and states.

### *Transition Dynamics*

The second main part of interest in HMMs is the transition dynamics, that is, the model that governs the changes occurring in the states over time. For example, participants in a categorization learning experiment (Ashby & Ell, 2001) are assumed to pass through a number of stages. At the outset of the experiment, they have no knowledge of the task, and hence their performance is expected to be at chance level. In an HMM this can be modeled by means of a guessing state, in which the probability of providing a correct answer is 0.5. At the end of learning, participants have full knowledge of the task, and hence do not make any errors. In an HMM, this can be modeled by means of a so-called learned state, in which the probability correct is 1. Depending on their learning strategy, participants may pass through a number of intermediate states, in which they have partial knowledge of the task at hand. The model that only consists of the guessing and the learned states, is called the all-or-none model. The transition dynamics of this model is fairly simple; it is assumed that at each trial of the learning experiment, a participant has a fixed probability of learning the task. This probability is hence the probability of moving from the guessing state to the learned state; in the all-or-none model, this is called the learning parameter. See Wickens (1982) for an overview of such learning models. See Schmittmann, Visser, and Raijmakers (2006), Visser, Schmittmann, and Raijmakers (2007) for applications of hidden Markov models in categorization learning.

Above discussion illustrates a number of interesting characteristics of HMM states. The learned state in the above example is called an absorbing state: once it is

entered, one cannot leave that state. This incorporates the assumption that once the task is mastered there is no unlearning. The guessing state on the other hand is a so-called transient state: the process passes through that state but eventually leaves the state and there is no probability of returning. The transition probabilities between states determine such characteristics of states.

A (hidden) Markov model is called ergodic when there are no absorbing states and each of the states can be reached from any other states. The rainy weather/sunny weather model forms an ergodic model; the process continues forever changing from rainy spells to sunny spells and back. The transition dynamics provides information about how stable each of these states is, e.g., whether sunny periods last longer than rainy periods.

In the discrete state hidden Markov models under consideration in this chapter, the transition dynamics consists of a matrix of transition probabilities between states. These transition probabilities can be made dependent on other variables. For example, in the weather case, the transition from a sunny period to a rainy period could be dependent on air pressure such that, when the air pressure drops, the probability of transitioning from a sunny period to a rainy period increases. In the Illustrations section an example of such dependence is provided.

### ***Relationships with Other Models***

HMMs are part of a larger class of stochastic process models or state-space models (Fahrmeir, Tutz, & Hennevogel, 2001). In particular, the HMMs that we consider here are state-space models with a discrete state-space and discrete equidistant measurement occasions. Hidden Markov models are formally equivalent to latent Markov models. However, in practice the literatures on each of these models are largely separated. HMMs originate from engineering applications such as speech recognition (Rabiner, 1989), whereas latent Markov models originate in sociology and political science (Langeheine & Van de Pol, 1990). HMMs are typically applied to long univariate time series, such as speech streams or stock market prices. In contrast, latent Markov models were considered as extensions of latent class models (McCutcheon, 1987) with repeated measurements. In latent class models, the goal is to classify persons into a finite number of distinct types. The latent Markov model then is applicable whenever, for example, questionnaires are administered repeatedly and the goal is to study changes in e.g., political preferences of large groups of people. Summarizing, in latent Markov models, the focus is on short multivariate time series with many cases, whereas HMMs are mostly applied to long (univariate) time series of a single process or individual. In this chapter, we consider both a univariate and a bivariate time series. The next section provides a formal definition of hidden Markov models along with likelihood function, which is used to estimate parameters and draw inferences on (relative) goodness-of-fit of competing models.



## Likelihood, Parameter Estimation, and Inference

Below, we first give a description of the parameters and distribution functions that together constitute a hidden Markov model. After that, the likelihood and parameter estimation are discussed. To be able to interpret the examples in the Illustrations section, the description of the parameters is essential. However, the full description of how to compute and optimize the likelihood may be skipped by non-technical readers.

Formally a hidden Markov model consists of the following elements (here we adopt notation by Rabiner, 1989):

1. A finite state space  $S$  with states  $S_i$ ,  $i = 1, \dots, n$ .
2. A transition model  $A$  providing transition probabilities  $a_{ij}$ .
3. A measurement model for each state in  $S$ , denoted by  $B_i$ ,  $i = 1, \dots, n$ , which relates the state to the observation  $O$ .
4. The initial state probabilities  $\pi_i$ ,  $i = 1, \dots, n$ .

Here  $n$  is the number of states of the model, i.e., the number of possible values the state variable  $S_t$  can assume.  $\pi$  denotes the initial state distribution at  $t = 1$ , which is a probability vector with  $\sum_i \pi_i = 1$ . Next,  $B_i(\cdot)$  is the distribution of the responses or observations  $O$  conditional on the current state  $S_t = i$ . For example, for a binary item  $O$  we have  $b_i(O = 1) + b_i(O = 2) = 1$ , for each  $i$ . Finally,  $a_{ij}$  is the transition probability of moving from state  $S_t = i$  to state  $S_{t+1} = j$ , which is written as a probability matrix  $A$ . That is, for each state  $S_i$  the transition probabilities sum to one,  $\sum_j a_{ij} = 1$ .

To fix ideas, consider an HMM with two states as depicted in Fig. 13.1. The data to be modeled are the observations  $O$ ; in particular, there are two observations at each measurement occasion,  $O^1$  and  $O^2$ , hence we are considering a bivariate time series. The underlying states are  $S_1$  and  $S_2$ . The transition probabilities are denoted  $a_{11}$ ,  $a_{12}$ ,  $a_{21}$ , and  $a_{22}$ , respectively. The initial state probabilities  $\pi$  are the probabilities that the process starts in a particular state  $S_i$  (not depicted in Fig. 13.1).

The model in Fig. 13.1 could be a model for the weather example discussed above. One state then corresponds to sunny weather, and the other to rainy weather. The transition probabilities are interpreted as the stability of the weather; for example, the closer  $a_{11}$  is to 1, the more stable the corresponding weather state is.

A core assumption of Markov models is that the current state only depends on the previous state, and not on the entire history of previous states. Formally this (first-order) Markov assumption is expressed as:

$$p(S_t | S_1, S_2, \dots, S_{t-1}) = p(S_t | S_{t-1}), \quad (1)$$

and hence the conditional distribution of  $S_t$  only depends on  $S_{t-1}$ , and not on  $S_{t-2}$  etc. Here  $S_i$  is short for  $S_t = i$ , meaning the process is in the  $i$ -th state of the model at time  $t$  of measurement. This Markov assumption is customarily made in many applications. If the assumption is not met, it is usually possible to increase the number of latent states in such a way that the assumption is met. This amounts to fitting so-

**Fig. 13.1** Hidden Markov model with 2 states

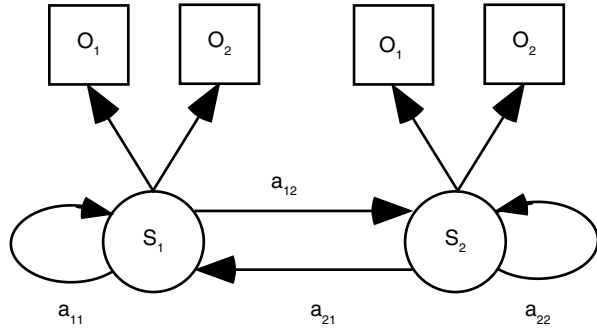

called higher-order latent Markov models (see Langeheine & Van de Pol, 2000, for discussion).

To summarize, the parameters of the hidden Markov model are the following. First, the vector  $\pi$ , the initial state probabilities. Second, the parameters that determine the transition probabilities  $a_{ij}$ , either multinomial parameters that sum to unity, i.e.,  $\sum_j a_{ij} = 1$  or other parameterizations thereof. In our second illustrative example, we specify a multinomial logistic distribution for the transition probabilities, such that covariates can be included that influence those probabilities. Third, the parameters of the observation distributions  $B_i(\cdot)$ , which specify the relationship between the unobserved states  $S_i$  and the observations  $O_t$ . For example, in a gaussian HMM, each  $B_i(\cdot)$  has two parameters, the mean and standard deviation of a gaussian or normal distribution. Below the full likelihood function of the HMM is specified along with recursive functions for efficiently computing the likelihood. It is not necessary to understand all the details of computing and optimizing the likelihood to be able to interpret the parameters in the Illustrations section. Hence, the non-technical reader may wish to skip this section and refer back to it when needed.

### Likelihood

The data we are considering here has the general form  $\mathbf{O}_1, \dots, \mathbf{O}_T$ , where  $\mathbf{O}_t = O^1, \dots, O^m$ , an  $m$ -variate observation at time  $t$ . Using above notation, the likelihood for such a time series can be expressed as follows:

$$L(\mathbf{O}_T | \lambda) = \sum_S \pi_1 B_{S_1=i}(O_1) \prod_t a_{S_{t-1}=i, S_t=j} B_{S_t=j}(O_t), \tag{2}$$

where  $\lambda$  is the parameter vector containing the parameters to model  $\pi$ ,  $A$ , and  $B$ . The sum runs over all possible sequences  $S_1, \dots, S_T$  of the latent or hidden state sequence, and the product runs from  $t = 2$  to  $T$ .

When local independence is assumed among the items, the distribution functions  $B_i(\mathbf{O})$  can be factored as follows:

$$B_i(O_t) = \prod_{j=1 \dots m} B_i(O^j). \tag{3}$$

The assumption of local independence is very common in so-called latent variable models. Some even claim that local independence is *the* defining feature of latent variable models (see Bollen, 2002, for discussion). In many applications, local independence is indeed a reasonable assumption. A particular state, e.g., a knowledge state, an economical state or an attitude, is supposedly the common cause of the observed variables. This assumption means that the underlying variable that we are interested in, the states in the case of Markov models, causes the observed variables to have the values that they have. As a consequence, when conditioning on that underlying variable, the observed variables are independent, which is expressed in the local independence assumption. Throughout the rest of the chapter, local independence is assumed for models that are fitted.

Note that so far we have not mentioned any particular assumptions about the distributions  $B_i(\cdot)$ . The state variable  $S$  is distributed multinomially by the parameter vector  $\pi$ , and so are the transition probabilities. For the observation distributions  $B_i(\cdot)$ , there is no compelling reason to make any assumptions. As a consequence, they can be any estimable density function, including the multinomial distribution for categorical responses, but also the gaussian distribution if, for example, reaction times are included. In such a case, when there is a categorical response and a continuous response, the local independence assumption proves very valuable, because there is no need to deal with the possible correlation structures among these different variables. In the second example in the Illustrations section, we use mixed variables in this way.

### ***Parameter Estimation and Inference***

To prevent underflow and to make computing the likelihood more efficient, below a recursive algorithm is described developed by Lystig and Hughes (2002). This estimation procedure differs in three ways from the standard latent Markov estimation procedures. First, scaling is used to prevent underflow problems. Second, the raw data likelihood is computed instead of likelihood based on a sufficient statistic, such as a contingency table. An advantage of this is that missing data can be easily dealt with in a similar vein as is done in for example the Mx-program (Neale, Boker, Xie, & Maes, 2003). Third, a recursive scheme is used to compute the likelihood which is known as the forward algorithm such that the number of computations is limited.

To deal with underflow problems, the joint probability of the data is first rewritten as a product of conditional probabilities as follows (Lystig & Hughes, 2002):

$$L_T = p(O_1, \dots, O_T) = \prod_{t=1 \dots T} p(O_t | O_1, \dots, O_{t-1}), \quad (4)$$

where  $p(O_1 | O_0) := p(O_1)$ . Note that rewriting the joint likelihood in this way does not depend on any particular assumption of (latent) Markov models. Therefore, the dependence on the model parameters is dropped in the above equation. The log-likelihood can now be expressed as:

$$l_T = \sum_{t=1\dots T} \log \left[ p(O_t | O_1, \dots, O_{t-1}) \right]. \quad (5)$$

This formulation of the likelihood prevents underflow to occur for long time series because the conditional probabilities  $p(O_t | O_1, \dots, O_{t-1})$  are computed, rather than the usual probabilities  $p(O_1, \dots, O_T)$ . Next we need to compute these conditional probabilities.

The so-called forward algorithm can be used to compute the likelihood (Baum & Petrie, 1966). Below version of the algorithm is due to Lystig and Hughes (2002). Define the forward recursion variables as follows:

$$\varphi_1(j) = p(O_1, S_1 = j) = \pi_j B_j(O_1). \quad (6)$$

$$\begin{aligned} \varphi_t(j) &= p(O_t, S_t = j | O_1, \dots, O_{t-1}) \\ &= [\sum_{i=1\dots n} \varphi_{t-1}(i) a_{ij} B_j(O_t)] \times (\phi_{t-1})^{-1} \end{aligned} \quad (7)$$

where  $\phi_t = \sum_{i=1\dots n} \varphi_t(i)$ . Note first that the sum over  $n$  in Eq. (7) is simply an enumeration of all the states of the model. Here  $\varphi_t(j)$  is the probability of observing  $O_t$  in state  $S_t$  conditional on having observed  $O_1, \dots, O_{t-1}$ . Hence,  $\phi_t = \sum_{i=1\dots n} \varphi_t(i)$  is the probability of observing  $O_t$  conditional on having observed  $O_1, \dots, O_{t-1}$ . The recursion includes an efficient enumeration of all possible latent state sequences. Note that computing the  $\varphi_t$  takes in the order of  $S^2$  computations, and hence computing the likelihood takes  $S^2 T$  computations. Writing out  $\varphi_t$  for  $t=3$  makes explicit its relationship with Eq. (2):

$$\phi_3 = \left\{ \sum_{i_3} \left[ \sum_{i_2} \left( \sum_{i_1} p_{i_1} B_{i_1}(O_1) a_{i_1 i_2} \right) B_{i_2}(O_2) \right] a_{i_2 i_3} B_{i_3}(O_3) \right\} (\phi_1 \times \phi_2)^{-1} \quad (8)$$

Note that the triple summation between braces is identical to Eq. (2) for the case that  $t=3$ . The multiplication of this term by  $(\phi_1 \times \phi_2)^{-1}$  takes care of the scaling at each time point to prevent underflow.

Combining  $\varphi_t = p(O_t | O_1, \dots, O_{t-1})$ , and Eq. (5) gives the following expression for the log-likelihood:

$$l_T = \sum_{t=1\dots T} \log \phi_t. \quad (9)$$

Parameters for the hidden Markov model can be estimated by optimizing the log-likelihood. Baum and Petrie (1966) provided an EM algorithm for doing so. Because Lystig and Hughes (2002) also provide gradients of the parameters for the log-likelihood, instead of using an EM algorithm, also direct optimization may be applied efficiently. The above algorithm for computing the log-likelihood and the gradients are implemented in the depmix package in the R-language for statistical computing (R Development Core Team, 2008). Depmix uses direct optimization of the log-likelihood with a Newton type algorithm using the gradients whenever they are available (Visser, 2008). An advantage of using direct optimization over the EM algorithm is that it is straightforward to deal with box constraints on parameters and general linear constraints between parameters. Depmix uses the Rdonlp2 package to handle such constraints (Tamura, 2007).

A second package `depmixS4` also implements hidden Markov models and extends these with more general measurement models. In particular, `depmixS4` fits Markov mixtures of generalized linear models (Visser & Speekenbrink, 2008). More about possible extensions of ordinary hidden Markov models in the Discussion section.

Determining goodness-of-fit of hidden Markov models is a notoriously difficult task, but see for example Altman (2004) for some recent developments. Instead of determining absolute goodness-of-fit, such as  $\chi^2$ -measures for contingency tables (Wickens, 1989), in the current chapter we use relative goodness-of-fit measures to compare various candidate models with one another. The Akaike and Bayesian Information Criteria are the most common such measures that are used (Akaike, 1973; Schwarz, 1978). These criteria provide a way of balancing a measure of the goodness-of-fit of a model, such as the log likelihood with a measure of the parsimony of the model, such as the number of parameters. In the illustrations below, these two criteria are used. Lower AICs and BICs indicate better fitting models. In addition, we use the log likelihood ratio whenever this is applicable, i.e., whenever models are nested. In comparing nested models, the log likelihood ratio between two models has a known distribution, the  $\chi^2$ -distribution with  $df$  the number of constrained parameters, and can hence be used to test models (Wald, 1943).

## Illustrative Applications

### *Perth Water Dams*

In this section we provide a brief example of a so-called left-right hidden Markov model; that is, a model with a number of transient states that can only be accessed in one direction, ending in a final absorbing state. The aim of this example is to show that there is a number of stages underlying the data which are best characterized as discrete stages with sudden transitions between them rather than a gradual, continuous change. Similar models have, for example, been used in studying development of math skills (Collins & Wugalter, 1992) and in medical applications (Reboussin, Reboussin, Liang, & Anthony, 1998); Kaplan (2008) provides an overview of such models, that are called stage-sequential models in the developmental psychology literature. The important difference between those applications and ours is that they considered only a few measurement occasions and many participants, whereas here we study a single time series.

### *Data*

The data that are used in this illustration concern the water inflow into a number of dams surrounding Perth, Western Australia. The data are depicted in Fig. 13.2. Measurements are annual yearly totals of water inflow into a number of dams in the area of Perth. The data are kindly provided by the Water Corporation of Western Australia and concern the years 1911–2005 (*Water Corporation of Western Australia*).

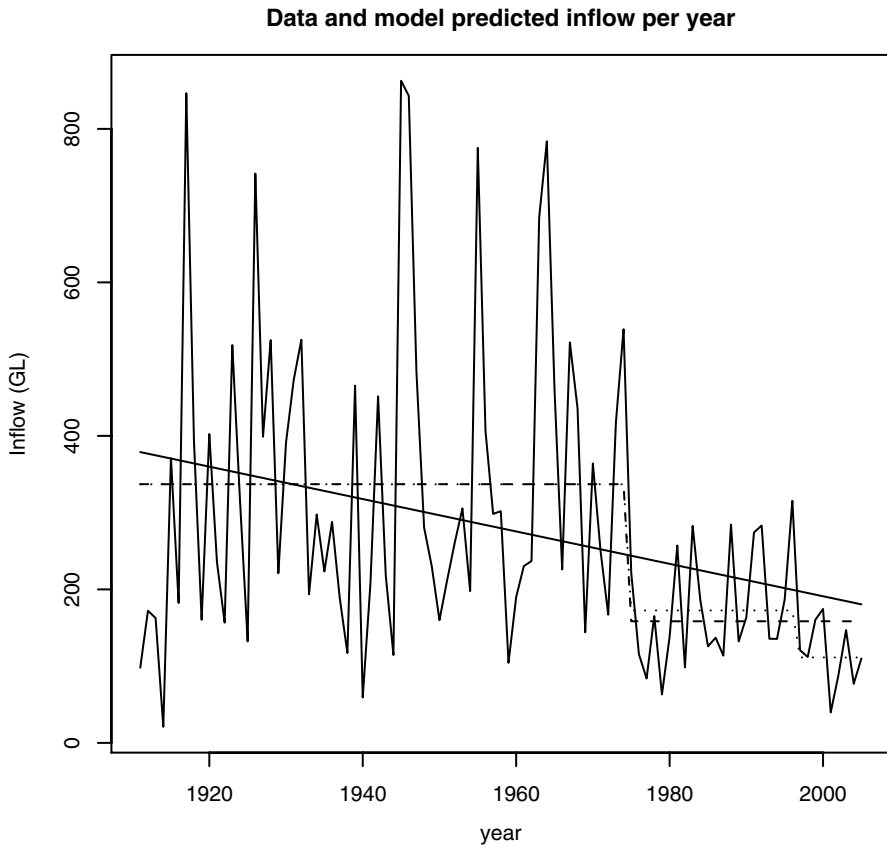

**Fig. 13.2** Perth dams water inflow data in gicaliter per year from 1911 to 2005. The solid line represents the data; the solid straight line is the prediction by a simple linear model; the dashed line represents the predicted values by a 2-state (1 switch point) hidden Markov model; the dotted line represents the predictions by a 3-state (2 switch points) hidden Markov model. The first switch of the 3-state model occurs in the same year as the switch in the 2-state model

## ***Models***

The main point of interest in these data is whether there are significant trends indicating a decrease in water inflow. We consider two possible hypotheses here: First, there is a decrease, and it is linear; second, there is a decrease, and it is stepwise, i.e., there are sudden changes rather than gradual changes. In economic science for example this is referred to as a regime change (Kim, 1994), and in psychology these sorts of changes are referred to as phase transitions or catastrophic changes (van der Maas & Molenaar, 1992).

Here we compare three models, a linear model, and hidden Markov models with either 2 or 3 states to allow for either 1 or 2 change points in the data. In terms of parameters of the earlier given example model in Fig. 13.1, this means that transi-

**Table 13.1** Goodness-of-fit measures for the Perth water data models. Lin denotes the linear model, and 2 and 3 denote the 2- and 3-state models respectively

Model	logl	AIC	BIC	nfree
Lin	634.29	1272.58	1277.69	2
2	612.34	1234.68	1247.45	5
3	611.01	1240.03	1263.01	9

Note: Model indicates the type of model that is fitted, lin for linear model, 2 and 3 for the 2- and 3-state models respectively; logl is the log likelihood, AIC and BIC are the Akaike and Bayesian information criteria respectively; nfree denotes the number of free parameters estimated in each model.

tion parameter  $a_{21}$  is equal to zero. In other words, there is a progression from state 1 to state 2 at some point in time but no possibility of going back to that earlier state. In the 3-state model, transition parameter  $a_{32}$  is equal to zero. Model goodness-of-fit statistics are provided in Table 13.1.

As can be read in Table 13.1, the 2- and 3-state models have much better goodness-of-fit statistics than the linear model, supporting the conclusion that change in water inflow is sudden rather than gradual. The difference between the 2- and 3-state models is relatively small and hence only future data can clarify whether there is a second change point or not. Both the 2- and 3-state models agree exactly on the time of the first change point in the mid-seventies. The extent to which these changes reflect effects of climate change has been an issue of debate (see *Marine and Atmospheric Research*, for various reports on this). All three fitted models' predictions are plotted in Fig. 13.2.

### *Speed-Accuracy Trade-Off*

In this section we provide an example of an HMM that is used to analyze a single time series resulting from a reaction time experiment in which the speed-accuracy trade-off (SAT) was manipulated. In this example, we extend the traditional latent Markov model in two important ways. First, the latent states can have mixed indicators, e.g., a gaussian and a binomial indicator, for the reaction time and the accuracy of a trial, respectively. In much experimental research, reaction times and accuracy of trials are analyzed separately, whereas they are known to be dependent. Using both as indicators of a single latent variable allows us to explore the relationships that exist between them. In the application that we present, the relationship between speed and accuracy is explored. Second, we use covariates on the transition parameters to test the effects of experimental manipulation. More generally, the use of covariates can help account for heterogeneity, either between cases, or within a single case over time.

Heterogeneity in time can be accommodated by specifying separate distribution functions for each measurement occasion. In this general case, the distributions depend on  $t$  and we write e.g.,  $a_{ij} = a_{ij}(t)$ . As a result, the number of parameters depends on the number of measurement occasions, which quickly becomes com-

plicated when analyzing long time series. In particular, in the application that we consider, with only a single time series this is not feasible. Therefore, none of the distributions depends on  $t$  in this general way. Instead, we deal with heterogeneity in time in a more parsimonious way by specifying parameters of distributions to be functions of time-dependent covariates  $z_t$ . When that is the case, we write e.g.,  $a_{ij}(t) = P(S_t = j | S_{t-1} = i, z_t)$ . The transition probabilities are then modeled as a multinomial logistic regression (Agresti, 2002). In particular, we use a baseline category logit model for the transition probabilities from state  $i$ :

$$\log(a_{ij}/a_{i1}) = \alpha_j + \beta_j z_t, \quad j = 2, \dots, n, \quad (10)$$

where  $a_{ij}$  is the transition probability from state  $i$  to state  $j$  and  $n$  is the number of states in the model, and  $z_t$  a vector of covariates; in this example, the baseline category is 1, and the corresponding parameters  $\alpha_1$  and  $\beta_1$  are set to zero. Note that this only works if the transition probability  $a_{i1}$  is not equal to zero; however, if this is the case, changing the baseline category can solve this problem. Recently, a latent Markov model with time-dependent covariates for the transition probabilities was presented in Chung, Walls, and Park (2007).

In this section we illustrate the use of HMMs by analyzing data from an experiment in which the speed-accuracy trade-off is manipulated by varying pay-offs for speed and accuracy in a reaction time experiment. Before presenting the data and a number of models, we briefly sketch the reasons for collecting these data.

## ***Theoretical Background***

The use of reaction times as behavioral measure in experimental psychology is pervasive. In experimental research on choice behavior it is common to analyze the reaction times only, and to consider accuracy data as a nuisance. Usually, accuracy scores are only analyzed to check whether they do not differ between conditions of an experiment. The random walk model (Laming, 1968) or diffusion model (Ratcliff, 1978) is especially suitable for simultaneously analyzing reaction times and accuracy of trials in experimental situations and it has been applied successfully in a large variety of experimental data.

The random walk model (RWM) for choice reaction times predicts a continuous trade-off between speed and accuracy; that is, it is assumed that accuracy and RT drop gradually in response to certain experimental manipulations, e.g., instructions to respond faster. An alternative to the RWM is a phase transition model (PhTM), which holds that participants switch between two modes of responding, the fast-guessing mode and the stimulus-controlled mode. In the fast-guessing mode, accuracy is at chance level and reaction times (RT) are short. In contrast, in the stimulus controlled mode, accuracy is close to 100% and RTs are relatively longer. The PhTM predicts that as pressure to respond faster and faster increases, participants switch to fast-guessing rather than respond at intermediate levels of accuracy and speed. Providing insight into the trade-off between speed and accuracy in choice reaction



time tasks is important because the use of different strategies in the trade-off may threaten the validity of comparing RTs between, say, participants or experimental conditions.

The goal in the current illustration of HMMs is to test a number of predictions that differentiate the RWM and PhTM. There are two specific predictions that are explored here. First, the RWM predicts a single response strategy, which has a single parameter for adapting the trade-off, whereas the PhTM predicts the existence of two different strategies and a switching regime between those strategies. Second, in addition to the existence of two states in the PhTM, it also makes specific predictions about the switching regime dependent on the changes in the pay-offs for speed and accuracy. In particular, it predicts a certain asymmetry in the switching process between the fast-guessing state and the stimulus-controlled state. These two hypotheses translate into specific hypotheses about hidden Markov models that are outlined below in the modeling section.

## *Data*

Figure 13.3 depicts the first 168 trials of an experiment in which the SAT was manipulated by continuously varying the pay-off for accuracy. The data at each trial consists of a reaction time (log-transformed to make the distribution normal) and whether the trial was correct or not. The data result from a lexical decision task. The third part of the Figure depicts the relative pay-off for accuracy that was manipulated experimentally. The data that are analyzed here are from a single participant (two other participants were tested with similar results). This pay-off increases and decreases over trials with the aim that the participant adapts his behavior accordingly. The depicted data in Fig. 13.3 is the first part of 168 trials; the full data of this participant has two further series of 134 and 137 trials respectively. These data form a subset of the data from Experiment 2 in van der Maas, Dutilh, Visser, Grasman, and Wagenmakers (2008).

## *Models*

The main aim is to test the hypothesis whether there are two modes rather than one in these data; that is, the hypothesis is whether a gradual decrease in the pay-off for accuracy leads to a gradual decrease in accuracy of responding (and a corresponding decrease in RTs), or alternatively, whether a decrease in the pay-off leads to a sudden switch in the mode of responding, from stimulus-controlled responding (slow and accurate) to fast-guessing (fast responding at chance level). Furthermore, if there are two or more modes, it is interesting to find out the transition dynamics between the modes and in particular if and how those depend on the covariate, i.e., the pay-off for accuracy.

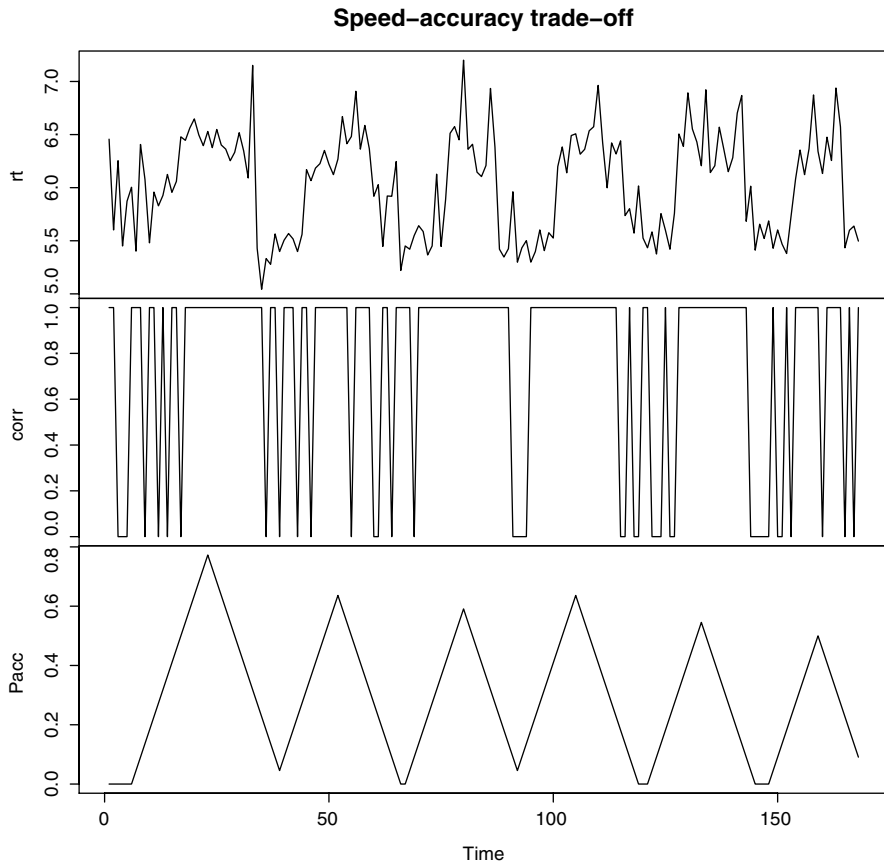

**Fig. 13.3** Speed-accuracy trade-off data. Upper panel: reaction times (note that the RTs are log-transformed); middle panel: accuracy per trial (corr); lower panel: pay-off for accuracy (Pacc)

To test the first hypothesis, i.e., that there two or more modes in the data, a number of HMMs with 1–3 states are fitted to the data. Models are fitted with and without Pacc, the pay-off for accuracy, as covariate on the RTs and corr (accuracy) variables in the data. That is, for example, in each state the RTs are modeled with a linear regression model with Pacc as predictor. Similarly, the accuracy variable corr is modeled with Pacc as a predictor in a binomial logistic regression (Agresti, 2002).

Table 13.2 presents the goodness-of-fit statistics for each of these models, with a p indicating that Pacc was included as a covariate on the RT and corr variables in each state.

The AIC and BIC are reported here. The Table also includes the likelihood ratio tests for adding the predictor Pacc to the models.

As can be seen in Table 13.2, the 2- and 3-state models have much lower AIC and BIC values than the 1-state model, both with and without Pacc as covariate on the

**Table 13.2** Goodness-of-fit measures for 1- to 3-state models with and without direct effects of Pacc on RT and corr

Model	logl	AIC	BIC	nfree	llr	df ( <i>p</i> )
1	-554.64	1115.27	1127.53	3		
1p	-417.42	844.85	865.27	5	274.4	2 (0)
2	-296.11	610.22	646.98	9		
2p	-291.93	609.86	662.96	13	8.36	4 (0.079)
3	-265.52	565.04	634.48	17		
3p	-263.00	572.01	665.95	23	5.03	6 (0.54)

Note: Model indicates the type of fitted model, see the text for details; logl denotes the log likelihood; AIC and BIC denote the Akaike and Bayesian information criteria respectively; nfree denotes the number of freely estimated parameters of the model; llr denotes the log likelihood ratio with respect to the previous model for the models that include Pacc as covariate (models with p); df denotes the degrees of freedom for the log likelihood ratio test and between parentheses the *p*-value for the test is given.

responses. It is hence safe to conclude that the process consists of multiple modes of responding.

The 2- and 3-state models both contain a state which is best described as a ‘stimulus controlled’ mode of responding with relatively slow RTs and highly accurate responding. The 2-state model additionally has a fast-guessing state with fast RTs and accuracy around chance level. In the 3-state models, there are two instead of one fast-guessing state, with one state having very fast responses, and the second state having slightly slower responses. The reason that the 3-state model is slightly better than the 2-state model could be due the fact that we modeled the reaction times using a log-normal distribution, which may not be optimal. Because of this, below we further explore the 2-state model and extensions thereof rather than the 3-state models. First, however we present the parameter values of the 2-state model without covariates.

The initial state probabilities have values  $p_1 = 0.99997$  and  $p_2 = 0.00003$ ; in other words, the process starts in state  $S_1$  with overwhelming probability. The transition matrix has values:

$$\begin{aligned} a_{11} &= 0.916a_{12} = 0.084 \\ a_{21} &= 0.101a_{22} = 0.899, \end{aligned} \tag{11}$$

from which it can be seen that both states are very stable, i.e., the probability of staying in either state,  $a_{11}$  and  $a_{22}$  is around 0.9. The measurement models for each of the states have the following parameters. State  $S_1$  has a mean reaction time of 6.36 (SD = 0.24). Note that the RTs are log-transformed, so this mean is equivalent to 595 ms. The accuracy in state  $S_1$  is equal to 0.90, which identifies this state as the stimulus-controlled state with an accuracy close to unity. State  $S_2$  has a mean RT of 5.52 (SD = 0.20) and an accuracy of 0.53, which identifies this state as the fast-guessing state with accuracy around chance level and RTs that are on average much faster than in the stimulus-controlled state. The RTs in this state are 249 ms on average.

**Table 13.3** Goodness-of-fit measures for 2-state models for the speed-accuracy data. See the text for details

Model	logl	AIC	BIC	nfree	llr	<i>df</i> ( <i>p</i> )
2	-296.11	610.22	646.98	9		
2p	-291.93	609.86	662.96	13	8.36	4 (0.079)
2ptr	-248.9	519.94	564.87	11	94.27	2 (0)
2ptr-constr	-249.21	516.43	553.19	9	0.48	2 (0.78)
2ptr-hyst	-250.51	517.03	549.71	8	2.61	1 (0.11)
2ptr-nohyst	-277.11	568.21	596.81	7	55.8	2 (0)

Note: Model denotes the type of model that is fitted, see the text for details; logl denotes the log likelihood, AIC and BIC denote the Akaike and Bayesian information criteria, respectively; nfree denotes the number of free parameters in the model; llr denotes the log likelihood ratio of the model with respect to the baseline model (i.e., model 2 for models 2p, 2ptr, and 2ptr-constr, and model 2ptr-hyst for the remaining models, also see the text); *df* denotes the degrees of freedom for the log likelihood ratio test and between parentheses is the corresponding *p*-value for the  $\chi^2$ -distribution.

The next model we fit is an extension of the above described model: it is a 2-state model in which the transition dynamics depend on the covariate Pacc, the pay-off for accuracy. In above fitted models, this pay-off was included as covariate on the responses (RT and corr) directly. As can be seen in Table 13.2 in the 2- and 3-state models, the likelihood ratio tests indicate that adding Pacc as a predictor for the responses does not significantly improve goodness-of-fit of these models. For example, in the 3-state model, the log likelihood ratio is 5.03 with *df* = 6 resulting in *p* = 0.54. According to the PhTM of the SAT, it is more plausible that Pacc influences the transitions between the fast-guessing and the stimulus-controlled mode of responding rather than influencing the responses directly. Consequently, Pacc is included as a covariate on the transition probabilities in the next set of the models that we fitted.

In Table 13.3, the goodness-of-fit statistics for this model (denoted 2ptr in the Table) are given along with the 2-state model without covariates (2) and the 2-state model with Pacc as predictor for the responses (2p). Note that these latter two models are identical to the ones presented in Table 13.2 and are presented here for purposes of comparison. The 2ptr model fits the data much better than either the 2-state model (2) without covariates or the 2-state model with a covariate on the responses (2p).

Two further constraints are tested in this model. First, the initial probability for starting in the stimulus controlled state is estimated at 0.999 and hence it is suspected that it is not significantly different from unity. Second, the probability for accuracy in the fast-guessing mode is 0.525 and it is interesting to test whether this differs significantly from 0.5, chance level in the task. The next model we fitted incorporates these two constraints; in Table 13.3, this model is indicated as '2ptr-constr'. The log likelihood ratio test (in column llr in the Table) indicates that these constraints do not lead to significant decrease in goodness-of-fit and are hence reasonable. These constraints are therefore kept in the following models.

The second hypothesis that is interesting to test concerns the phenomenon of hysteresis, i.e., whether the switching process between the states is asymmetric rather than symmetric which is a strong prediction by the phase transition model

(see van der Maas & Molenaar, 1992, for an example of this in developmental psychology). Hysteresis means that each of the states has inherent stability, which means that switching from the guessing state to the stimulus controlled state occurs at a different value of the control parameter (Pacc in this case) than when switching the other way around. In terms of hidden Markov model parameters, this means that the transition matrix is asymmetric and that the values of the intercept parameter corresponding with the influence of Pacc on the transition probabilities should be different between the two states of the model. Hence, the PhTM predicts that the intercepts [ $\alpha_i$  in Eq. (10)] of the regression models relating Pacc to the transition probabilities are different in each of the states, but not the slope parameters ( $\beta_i$ ). Consequently, two more models were fitted, one in which only the  $\beta$ 's were constrained to be equal, i.e.,  $\beta_1 = \beta_2$ . This model is called the hysteresis model, because the  $\alpha$ 's are different for each state. In the Table, this model is denoted 2ptr-hyst. In the second model, the  $\alpha$ 's are constrained to be equal, i.e.,  $\alpha_1 = \alpha_2$  to test the hypothesis of hysteresis. This final model is denoted 2ptr-nohyst in Table 13.3. Included in Table 13.3 are the log likelihood ratio tests of these models relative to the 2ptr-constr model as that was the best model so far. As can be seen from those tests, the 2ptr-hyst model is tenable but the 2ptr-nohyst model is not. Hence, the best model for these data is a model that incorporates hysteresis.

The measurement model parameters for state 1 are: a mean RT of 5.52 (SD = 0.21) and an accuracy of 0.5 (note that this parameter was constrained at that value). State 2 has a mean RT of 6.40 (SD = 0.24) and a mean accuracy of 0.91. Hence, state 1 is the fast-guessing state and state 2 the stimulus-controlled state. The transition model for state 1, the fast-guessing state, has parameters  $\alpha_2 = -5.33$  and  $\beta_2 = 12.65$  (remember that  $\alpha_1$  and  $\beta_1$  are both equal to zero as this is baseline category logistic model). When Pacc is zero, this means that the transition probability  $a_{11}$ , i.e., the probability of remaining in the fast-guessing state is equal to 0.995. The  $\alpha$  and  $\beta$  parameters for the transition model of state 2 are  $-2.42$  and  $12.65$  respectively. When Pacc is 1 (the maximum value in the experiment), this means the transition probability  $a_{22}$  is 0.9999, in other words virtually equal to one.

The transition dynamics of the model are further illustrated in Fig. 13.4. Depicted is the probability of transitioning from the fast-guessing state to the stimulus-controlled state as a function of the value of Pacc (solid smooth line). The dotted smooth line is the probability of staying in the stimulus controlled state as a function of Pacc. The probabilities are computed from model 2ptr-hyst in Table 13.3 with the parameter values that are given above. The Figure clearly shows the separation between the curves which indicates that switching from the fast guessing state to the stimulus controlled state occurs at higher values of the pay-off for accuracy than switching in the other direction.

Plotted over the model predicted transition functions are the observed RTs as function of Pacc (lines with circles and triangles). The solid line with circles indicates average RTs at different levels of Pacc during runs of trials at which Pacc is increasing (that is, when a switch is expected from the fast-guessing mode to the stimulus-controlled mode); the dotted line with triangles indicates average RTs at different levels of Pacc during runs of trials in which Pacc is decreasing, that is when

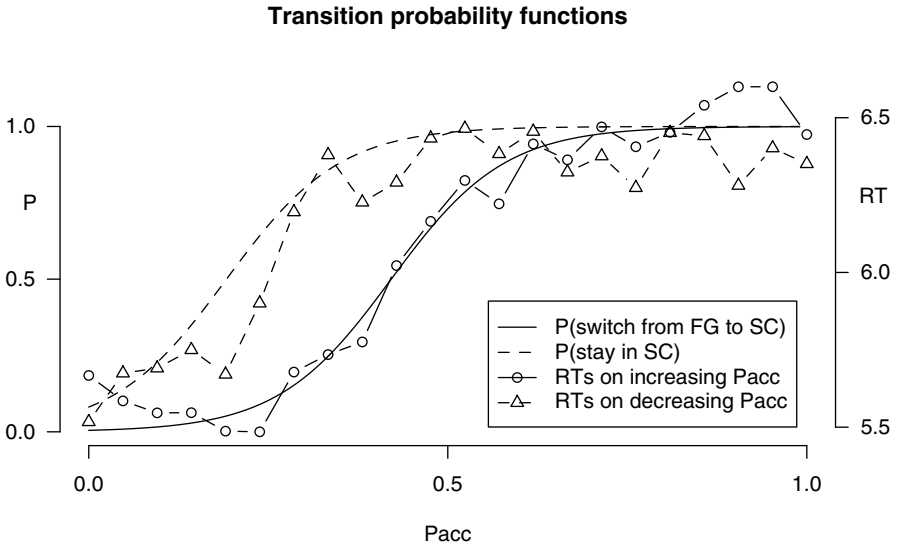

**Fig. 13.4** Hysteresis in the transition probabilities (computed from the fitted model 2ptr-hyst) between states. On the left hand side scale is the transition probability. The right hand scale is for the reaction times also showing hysteresis in the observed data. See the text for details on the model and the reaction times

a switch is expected from the stimulus controlled mode to the fast-guessing mode. Here hysteresis is evident by noting that at increasing values of Pacc, the switch to slower RTs (corresponding with more accurate responding) occurs at higher values of Pacc than the switch in the other direction, i.e., when Pacc is decreasing.

## Conclusion

The SAT is an important phenomenon in experimental research because strategic differences between participants may influence conclusions reached from such research. The experimental data that were analyzed here clearly indicate that there are multiple modes in responding to a simple choice reaction time task depending on the reward that participants get for responding fast versus accurate. This is in contradiction with a popular and often model for analyzing reaction time data, the random walk model. HMMs have been shown to be a useful tool to discriminate between these models, thereby showing that participants switch between two modes of responding depending on the pay-off for accuracy as a covariate.

## Discussion

We have introduced hidden Markov models as an important tool in studying processes of change, in particular changes that occur suddenly rather than gradual. Stepwise or stage-wise changes are an important characteristic of many theories, including theories in experimental psychology in the analysis of reaction times, as we have illustrated. Other examples that we have studied earlier concern theories of development and learning that occur stage-wise rather than gradually. In learning, HMMs were applied to show that simple discrimination learning shows all-or-none learning processes rather than gradual stimulus-response strengthening (Raijmakers, Dolan, & Molenaar, 2001; Schmittmann et al., 2006; Visser et al., 2007). In other work, development on the balance scale task was analyzed using hidden Markov models to analyze the effects of feedback on learning (Jansen, Raijmakers, & Visser, 2007).

In this chapter we have focused on models for single time series. Such models form the basis for generalizations across participants if such is applicable. In our second example we have illustrated the use of time-varying covariates to describe changes in behavior. Also, in that example, we have illustrated the use of mixed indicators, that is, a combination of a binary and a gaussian variable measured concurrently. These extensions the hidden Markov model framework to be extremely flexible in analyzing processes of change.

Many extensions of hidden Markov models have been explored by various researchers. An important one is the possibility of dealing with continuous time measurements rather than equidistant time measurements as we have done. Bureau, Shiboski, and Hughes (2003) for example, present an analysis of disease outcomes, and Böckenholt (2005) presents an example in studying the time course of changes in emotional states.

The software framework that we used to fit the models, depmixS4 (Visser & Speekenbrink, 2008), offers a wide variety of possible models: Markov mixtures of generalized linear models. Hence, this includes the use of regression models within states of the hidden Markov model. Also, a variety of other distributions are available such as Poisson responses, gamma responses etc. The transition probabilities and the initial state probabilities within depmixS4 are as multinomial logistic distributions which allows for the possibility of including time-varying covariates on the transition parameters as we have shown in our second example. Moreover, the depmixS4 framework offers easy extensibility by the possibility of adding new response distributions.

**Acknowledgement** Ingmar Visser and Maartje Raijmakers were supported by an EC Framework 6 grant, project 516542 (NEST). Thanks to the *Water Corporation of Western Australia* for providing us with the Perth water dams data.

## References

- Agresti, A. (2002). *Categorical data analysis* (2nd ed.). Hoboken, NJ: Wiley-Interscience.
- Akaike, H. (1973). Information theory and an extension of the maximum likelihood principle. In B. N. Petrov & F. Csaki (Eds.), *Second international symposium on information theory* (pp. 267–281). Budapest: Akademiai Kiado.
- Altman, R. M. (2004). Assessing the goodness-of-fit of hidden Markov models. *Biometrics*, *60*, 444–450.
- Ashby, F. G., & Ell, S. W. (2001). The neurobiology of human category learning. *TRENDS in Cognitive Sciences*, *5*, 204–210.
- Baum, L. E., & Petrie, T. (1966). Statistical inference for probabilistic functions of finite state Markov chains. *Annals of Mathematical Statistics*, *37*, 1554–1563.
- Böckenholt, U. (2005). A latent Markov model for the analysis of longitudinal data collected in continuous time: States, durations, and transitions. *Psychological Methods*, *10*(1), 65–83.
- Bollen, K. A. (2002). Latent variables in psychology and the social sciences. *Annual Review of Psychology*, *53*, 605–634.
- Bureau, A., Shiboski, S., & Hughes, J. P. (2003). Applications of continuous time hidden Markov models to the study of misclassified disease outcomes. *Statistics in Medicine*, *22*, 441–462.
- Chung, H., Walls, T. A., & Park, Y. (2007). A latent transition model with logistic regression. *Psychometrika*, *72*(3), 413–435.
- Collins, L. M., & Wugalter, S. E. (1992). Latent class models for stage-sequential dynamic latent variables. *Multivariate Behavioral Research*, *27*(1), 131–157.
- Eid, M., & Langeheine, R. (2003). Separating stable from variable individuals in longitudinal studies by mixture distribution models. *Measurement: Interdisciplinary Research and Perspectives*, *1*(3), 179–206.
- Fahrmeir, L., Tutz, G., & Hennevoig, W. (2001). *Multivariate statistical modelling based on generalized linear models*. New York: Springer.
- Ghahramani, Z., & Jordan, M. I. (1997). Factorial hidden Markov models. *Machine Learning*, *29*, 245–273.
- Jansen, B. R. J., Raijmakers, M. E. J., & Visser, I. (2007). Rule transition on the balance scale task: A case study in belief change. *Synthese*, *155*(2), 211–236.
- Kaplan, D. (2008). An overview of Markov chain methods for the study of stage-sequential developmental processes. *Developmental Psychology*, *44*(2), 457–467.
- Kim, C.-J. (1994). Dynamic linear models with Markov-switching. *Journal of Econometrics*, *60*, 1–22.
- Krogh, A. (1998). An introduction to hidden Markov models for biological sequences. In S. L. Salzberg, D. B. Searls, & S. Kasif (Eds.), *Computational methods in molecular biology* (pp. 45–63). Amsterdam: Elsevier.
- Laming, D. R. J. (1968). *Information theory of choice reaction times*. New York: Academic Press.
- Langeheine, R., & Van de Pol, F. (1990). A unifying framework for Markov modeling in discrete space and discrete time. *Sociological Methods and Research*, *18*(4), 416–441.
- Langeheine, R., & Van de Pol, F. (2000). Fitting higher order Markov chains. *Methods of Psychological Research Online*, *5*(1), 32–55.
- Lystig, T. C., & Hughes, J. P. (2002). Exact computation of the observed information matrix for hidden Markov models. *Journal of Computational and Graphical Statistics*, *11*, 678–689.
- McCutcheon, A. L. (1987). *Latent class analysis* (No. 07-064). Beverly Hills: Sage Publications.
- Miller, G. A. (1952). Finite Markov processes in psychology. *Psychometrika*, *17*, 149–167.
- Miller, G. A., & Chomsky, N. (1963). Finitary models of language users (chap. 13). In R. Luce, R. R. Bush, & E. Galanter (Eds.), *Handbook of mathematical psychology*. New York: Wiley.
- Neale, M. C., Boker, S. M., Xie, G., & Maes, H. H. (2003). *Mx: Statistical modeling*. VCU Box 900126, Richmond, VA 23298.



- R Development Core Team. (2008). *R: A language and environment for statistical computing*. Vienna, Austria (ISBN 3-900051-07-0).
- Rabiner, L. R. (1989). A tutorial on hidden Markov models and selected applications in speech recognition. *Proceedings of IEEE*, 77(2), 267–295.
- Raijmakers, M. E. J., Dolan, C. V., & Molenaar, P. C. M. (2001). Finite mixture distribution models of simple discrimination learning. *Memory & Cognition*, 29(5), 659–677.
- Ratcliff, R. (1978). A theory of memory retrieval. *Psychological Review*, 85, 59–108.
- Reboussin, B. A., Reboussin, D. M., Liang, K.-Y., & Anthony, J. C. (1998). Latent transition modeling of progression of health-risk behavior. *Multivariate Behavioral Research*, 33(4), 457–478.
- Schmittmann, V. D., Visser, I., & Raijmakers, M. E. J. (2006). Multiple learning modes in the development of rule-based category-learning task performance. *Neuropsychologia*, 44(11), 2079–2091.
- Schwarz, G. (1978). Estimating the dimension of a model. *Annals of Statistics*, 6, 461–464.
- Tamura, R. (2007). Rdonlp2: An R extension library to use Peter Spellucci's DONLP2 from R (version 0.3-1) [R package].
- van der Maas, H. L. J., Dutilh, G., Visser, I., Grasman, R. P. P. P., & Wagenmakers, E.-J. (2008). *Phase transitions in the trade-off between speed and accuracy in choice reaction time tasks*. Manuscript in preparation.
- van der Maas, H. L. J., & Molenaar, P. (1992). Stagewise cognitive development: An application of catastrophe theory. *Psychological Review*, 99, 395–417. (Marine and atmospheric research. (n.d.). <http://www.cmar.csiro.au/>)
- Visser, I. (2008). Depmix: An R-package for fitting mixtures of latent Markov models on mixed data with covariates (version 0.9.4) [R package]. Available at CRAN: <http://cran.r-project.org>
- Visser, I., Schmittmann, V. D., & Raijmakers, M. E. J. (2007). Markov process models for discrimination learning. In K. van Montfort, H. Oud, & A. Satorra (Eds.), *Longitudinal models in the behavioral and related sciences* (pp. 337–365). Mahwah, NJ: Lawrence Erlbaum Associates.
- Visser, I., & Speekenbrink, M. (2008). DepmixS4: S4 Classes for hidden Markov Models [R package latest version]. Available at CRAN: <http://cran.r-project.org>
- Wald, A. (1943). Test of statistical hypotheses concerning several parameters when the number of observations is large. *Transactions of the American Mathematical Society*, 54, 426–482.
- Water Corporation of Western Australia. <http://www.watercorporation.com.au/>
- Wickens, T. D. (1982). *Models for behavior: Stochastic processes in psychology*. San Francisco: W. H. Freeman and Company.
- Wickens, T. D. (1989). *Multway contingency tables analysis for the social sciences*. Hillsdale, NJ: Lawrence Erlbaum.

# Chapter 14

## Multilevel Simultaneous Component Analysis for Studying Intra-Individual Variability and Inter-Individual Differences

Marieke E. Timmerman, Eva Ceulemans, Anna Lichtwarck-Aschoff and Kristof Vansteelandt

In psychology, the distinction between traits and states has become commonplace for a long time: Whereas traits pertain to person features that are relatively stable and consistent, states refer to person features that fluctuate across time, for example as a result of situational influences. For instance, Allport and Odbert (1936) provided an extensive list of trait and state terms to characterize personality and personal behavior. The trait terms describe permanent, consistent dispositions and were considered to ‘symbolize most clearly “real” traits of personality’ (Allport & Odbert, 1936, p. 26). The state terms describe ‘Temporary Moods or Activities’. They were not considered to symbolize personality, and were merely included for the sake of completeness.

Also in emotion research, the differences between emotional traits and states are studied, for the broad categories of positive and negative emotions as well as for specific emotions like anxiety (Spielberger, 1972) and gratitude (Wood, Maltby, Stewart, Linley, & Joseph, 2008). Herewith, an important topic of debate is the nature of the relations between different emotions at the trait and state levels. For example, it appears to be agreed upon that positive and negative emotional traits are independent across individuals; however, at the state level, both an independency (Watson & Clark, 1994; Zevon & Tellegen, 1982) and a negative relationship between positive and negative emotional states have been reported (Vansteelandt, Van Mechelen, & Nezlek, 2005).

Research on traits and states typically involve repeated measurements of individuals on a number of variables, like personality-related characteristics or emotions. To obtain a proper understanding of traits and states aspects of these variables, there is a need for statistical methods that allow to unravel these trait and states aspects. This chapter deals with such a method, which models multivariate data that have been repeatedly gathered from more than one individual in an exploratory way. The key idea of this method is the following: the scores of each single individual on the

---

M. E. Timmerman (✉)  
Heymans Institute for Psychological Research  
University of Groningen  
Grote Kruisstraat 2/1, 9712 TS Groningen, The Netherlands  
e-mail: m.e.timmerman@rug.nl

variables will show variability over the measurements. The goal of our modeling is to identify meaningful sources of the intra-individual variability in the observed variables, and to investigate whether and how the sources of intra-individual variability differ across individuals. Additionally, we will have a look at sources of inter-individual variability.

The repeated measurements within individuals may pertain to different measurement occasions, like in a diary design, when data are daily gathered. However, the repeated measurements of an individual may also pertain to different circumstances, conditions, or target persons. Because the modeling focuses on intra-individual variability, it is not necessary to have comparable measurements across individuals, like the same conditions or target persons.

To identify the sources of intra-individual and inter-individual variability, we use multilevel simultaneous component analysis (MLSCA; Timmerman, 2006). As a start, a component model for a single individual only is presented.

Subsequently, the MLSCA approach to a simultaneous modeling of the multivariate repeated measures data of a number of individuals is introduced. The empirical value of MLSCA is compared to its counterparts in Structural Equation Modeling. The use of the MLSCA model to gain insight into intra-individual and inter-individual variability is illustrated by two empirical examples. The chapter closes by some concluding remarks.

## Principal Component Analysis of Single Subject Multivariate Data

An early approach to study the structure in a multivariate data set from a single individual is the P-technique (Cattell, 1952), which is a factor analysis of the correlations between variables, computed over repeated measurements. In various P-technique applications different factor analysis types were used (see Jones & Nesselroade, 1990), among which Principal Component Analysis (PCA). Component analysis is a data reduction technique that summarizes a number of observed variables into a smaller number of components by making linear combinations of the observed variables. PCA searches the components such that they explain as much of the variance in the data as possible. PCA is commonly applied to scores on a number of variables obtained from a number of individuals, but can be applied equally well to scores obtained from an individual at repeated measurements. Assuming that the scores of a single individual on  $J$  variables at  $K$  repeated measurements are collected in data matrix  $\mathbf{Y}$  ( $K \times J$ ), such a PCA analyzes either the covariance or the correlation structure of the variables. In the latter case, the data matrix is columnwise standardized before analysis, i.e., the variables are rescaled to have variances equal to one. As a consequence, all variables are equally weighted in the PCA. A PCA decomposes the (raw or standardized) data matrix  $\mathbf{Y}$  as

$$\mathbf{Y} = \mathbf{1}_K \mathbf{m}' + \mathbf{FB}' + \mathbf{E}, \quad (1)$$

where the apostrophe indicates the transpose operator,  $\mathbf{1}_K$  is the  $K \times 1$  vector with each element equal to one,  $\mathbf{m}$  ( $J \times 1$ ) is the vector containing the means of the  $J$  variables across measurements,  $\mathbf{F}$  ( $K \times Q$ ) denotes the matrix that contains the scores of the repeated measurements on the  $Q$  principal components,  $\mathbf{B}$  ( $J \times Q$ ) indicates the loading matrix, and  $\mathbf{E}$  ( $K \times J$ ) is the residual matrix; the principal components in  $\mathbf{F}$  are uncorrelated, and have variances equal to one. The data matrix  $\mathbf{Y}$  is decomposed in a way that maximizes the explained variance in the observed data given a fixed value of  $Q$ , which is equivalent to minimizing the sum of squared residuals.

The interpretation of a PCA solution is based on the loading matrix. The relative size of the loading of a variable on a component indicates to what extent the variable is associated to that component. A high loading is either high positive or low negative, whereas a low loading is near zero. When standardized data are decomposed, the relative size of the loadings is immediately clear, because then the loadings are correlations between variables and components. Variables with relatively high loadings on a particular component are associated strongly to that component, and hence are summarized well by this very component, whereas variables with low loadings are summarized badly. To interpret the components, the content of the well-summarized variables is examined.

To ease the interpretation of a PCA solution, it is common to rotate the loading matrix towards a more simple structure, for example using the popular Varimax rotation (Kaiser, 1958). Simple structure loadings are such that per component each loading is either high or low. Such a rotation does not alter the sum of squared residuals, provided that the rotation is compensated by counterrotating the scores on the principal components. The resulting components are orthogonal (uncorrelated) or oblique (correlated), depending on the rotation applied. A component score indicates the relative degree of the particular property that is indicated by the component concerned. To investigate the individual's behavior on the various components, the series of component scores for each component can be plotted against time. In such a plot, possible trends and outliers at certain occasions can be seen at once.

For example, the variables may pertain to emotions, like satisfied, happy, love, and affection. An individual may indicate to what extent he experienced those emotions on a large number of consecutive days. A PCA of the resulting data followed by (orthogonal) Varimax rotation may reveal two components, where the first component shows a clustering of the variables satisfied and happy, and the second component a clustering of the variables love and affection. Those components could be interpreted as General Positive Emotion (PE) and Interpersonal PE. The experience of emotions that belong to the same cluster highly covaries across time, so that at a particular measurement occasion, the relative strength of these emotions is similar. The two components General PE and Interpersonal PE are uncorrelated, implying that the relative strength of General PE at a particular measurement is unrelated to Interpersonal PE. By plotting the component scores on General or Interpersonal PE against time, one can examine how those emotions evolve over time.

## Approaches to Analyzing Multivariate Data of Multiple Subjects

For a single individual, PCA can be used to identify meaningful sources of the intra-individual variability in the observed variables. However, the primary research interest usually pertains to characterizing a group of individuals, rather than a single individual. By studying more than one individual repeatedly, the way opens to compare the sources of intra-individual variabilities across individuals.

To study the intra-individual variability in multivariate data of a number of individuals, one may adopt different modeling strategies. Firstly, one may assume that the individuals stem from a homogeneous population. This means that they do not differ on the parameters of interest that express the intra-individual variability. The linear dynamic model for multiple subjects (Bijleveld & Bijleveld, 1997) and chain P-technique are based on this very convenient, but often unrealistic, assumption. Chain P-technique simply involves a factor analysis of the aggregated repeated multivariate data sets over subjects, and is rather often applied (e.g., Hurlburt, Lech, & Saltman, 1984; Reise, Ventura, Nuechterlein, & Kim, 2005). Nesselroade and Molenaar (1999) proposed a formal test procedure to find subsample(s) of subjects for which aggregation is reasonable. Still, the approach is somewhat unsatisfactory. The individuals in the selected subsample may still have interesting intra-individual differences, which will be kept hidden using this approach. Furthermore, comparing homogeneous subsamples may be rather tedious.

A second approach to analyzing the data from more than one individual is opposite to the aggregating approach, in that the data of each individual are factor analyzed separately (see Jones & Nesselroade, 1990). Clearly, this approach offers ample opportunities to cover the intra-individual variability. However, the price to be paid is an increase in difficulty to gain insight into similarities and differences across individuals.

When judging the similarities in intra-individual structure, it is common to compare the individual's loading matrices, either by eye or using some quantitative measure, as the congruence coefficient (Tucker, 1951). When the loading matrices are about equal, the intra-individual structure is apparently stable across subjects. Moreover, because the components are defined in (about) the same way, the component scores at the repeated measurements (or characteristics thereof, like the autoregressive structure) can be compared across individuals. Serious troubles arise when the comparison fails to find evidence for equal loading matrices. The dissimilarities may result from arbitrary differences in axes orientation of the loadings. This can be solved by optimally rotating the loading matrices towards each other, using a Procrustes approach (see Gower & Dijksterhuis, 2004). A more fundamental problem than the one with orientation differences is, that dissimilarities between loading matrices can always be resolved by considering more components per individual (Ten Berge, 1986). Therefore, Ten Berge (1986) argued that one should question the amount of variance explained by comparable components over individuals, rather than the degrees of similarity between loadings.

Another disadvantage of separate factor analyses is that individual differences in variances across measurements are not expressed properly, irrespective of whether

the factor analysis is based on covariance or correlation matrices. This is unfortunate as those differences reflect the individuals' relative stability in scores across repeated assessments. When the individuals' covariance matrices are being factor analyzed separately and the factors are standardized with variance equal to one (as is commonly done), individual differences in variances show up in the relative sizes of the loadings. However, this complicates comparisons across individuals, as the differences in relative loading sizes also reflect difference in structure. When individuals' correlation matrices are being analyzed, individual differences in variances are even completely lost.

A third approach to analyzing multivariate repeated measures data from more than one individual is intermediate to the previous two, namely a simultaneous analysis of the data sets of the different individuals. This Simultaneous Component Analysis (SCA; Timmerman & Kiers, 2003) covers both the similarities and differences in intra-individual variability. The key idea of SCA is to decompose the data of each individual into a few components, and a single loading matrix, which is common to all individuals. The common loading matrix ensures comparability across individuals. The amount of variance explained per component can be compared across individuals to assess the relative importance of this component. Furthermore, the (co)variances of individual components provide a basis to compare the relative degree of intra-individual variability across individuals, as will be discussed in Section "Sources of Intra-Individual Variability in the MLSCA Model".

Because SCA is applied to unravel the sources of intra-individual variability of a number of individuals, SCA models the within-part of the data. The within-part of the data of each individual is estimated by subtracting the means of the variables across measurements from the observed data, i.e., by centering the data within each individual. This approach is also custom when a PCA on a single data set is performed (see Eq. 1), where the data reduction takes place on the within-part of the data. However, the total variability in repeated measures data of a number of individuals usually is due to both intra-individual variability, and to variability between individuals. The part of the data due to inter-individual variability will be denoted by the between-part. For each individual, the between-part of each variable is being estimated as the mean of the variable at hand across the measurements. Analogously to the within-part, the inter-individual variability of multivariate data may stem from only a few sources, which can also be explored with a component analysis. The full component analysis of both the between- and within-parts of the data is accommodated into one component analysis, which is denoted as multilevel simultaneous component analysis (MLSCA; Timmerman, 2006). The MLSCA model will be presented in some detail in the next section.

### ***MLSCA of Multivariate Data of Multiple Individuals***

Suppose that the scores of individual  $i$  on  $J$  variables at  $K_i$  repeated measurements are collected in data matrix  $\mathbf{Y}_i$  ( $K_i \times J$ ), and that data matrices are available for  $I$  individuals. As is well known from analysis of variance, the total variance of each variable can be written as the sum of the variances of the between- and within-parts. MLSCA searches between- and within-components such that they explain as

much as possible of the variance in the between- and within-part, respectively. In an MLSCA, the data matrices  $\mathbf{Y}_i$  ( $i=1, \dots, I$ ) of the  $I$  individuals are decomposed as

$$\mathbf{Y}_i = \mathbf{1}_{K_i} \mathbf{m}' + \mathbf{1}_{K_i} \mathbf{f}'_{ib} \mathbf{B}'_b + \mathbf{F}_{iw} \mathbf{B}'_w + \mathbf{E}_i, \quad (2)$$

where  $\mathbf{1}_{K_i}$  is the  $K_i \times 1$  vector with each element equal to one,  $\mathbf{m}$  ( $J \times 1$ ) is the vector containing the means of the  $J$  variables across all individuals and measurements. The between-part of the data is modeled by  $\mathbf{f}_{ib}$  ( $Q_b \times 1$ ), the vector with between-component scores of individual  $i$ , and  $\mathbf{B}_b$  ( $J \times Q_b$ ), the between-loading matrix, where  $Q_b$  denotes the number of between-components. The individuals' between-component scores  $\mathbf{f}'_{ib}$ ,  $i=1, \dots, I$ , can be conveniently arranged in the matrix  $\mathbf{F}_b$  ( $I \times Q_b$ ). The within-part of the data is modeled by  $\mathbf{F}_{iw}$  ( $K_i \times Q_w$ ), the matrix containing the within-component scores on measurements 1 to  $K_i$  of individual  $i$ , and  $\mathbf{B}_w$  ( $J \times Q_w$ ), the within-loading matrix, where  $Q_w$  denotes the number of within-components.  $\mathbf{E}_i$  ( $K_i \times J$ ) denotes the matrix of residuals of individual  $i$ . The mean between-component scores across individuals are constrained to zero (i.e.,  $\sum_{i=1}^I K_i f_{ib} = 0_{Q_b}$ ), which is sufficient to assure that the overall mean, the between-part and the within-part of the model are uniquely separated. Per individual, the mean within-component scores across measurements are zero (hence,  $\mathbf{1}'_{K_i} \mathbf{F}_{iw} = \mathbf{0}'_{Q_w}$ ,  $i=1, \dots, I$ ); the variances of between- and within component scores are fixed to one. The (co)variances of the within-component scores may be restricted, yielding four different MLSCA variants, as will be discussed in Section "Sources of Intra-Individual Variability in the MLSCA Model".

Given fixed values for the numbers of between- and within-components ( $Q_b$  and  $Q_w$ , respectively), the MLSCA model is fitted to observed data matrices by minimizing the sum of squared residuals (Timmerman, 2006). The fitting procedure boils down to two separate component analyses, namely a weighted PCA to the between-part, and an SCA to the within-part of the data.

When it is desirable that all variables equally influence the MLSCA solution, the data should be standardized prior to analysis, by rescaling the variance to one per variable over individuals and measurements. Note that standardizing per individual across measurements is not wise, as possible differences across individuals in intra-individual variability are eliminated. An advantage of standardization is that both the between- and within-loadings are correlations between components and variables. Also, for each variable, the proportion of variance explained by the between- or within-components can be immediately derived, namely as the squared between- or within-loadings, respectively.

### Sources of Intra-Individual Variability in the MLSCA Model

In MLSCA, the SCA model of the within-part expresses the intra-individual variability. The SCA model consists of a within-loading matrix, and within-component scores matrices of the individuals. The within-loading matrix expresses which

variables cluster across measurements, i.e., which variables have similar relative scores at the measurements. As gently explained by Nesselrode (2007), the intra-individual structure may differ to some extent across individuals. To have a full understanding of the intra-individual structures of different individuals, it is important to properly express their similarities and differences. This is regulated in the SCA model by imposing constraints on the (co)variances of the within-component scores, yielding four SCA variants. Ordered from the most to least constrained, the four SCA variants are: SCA-ECP, with both covariances and variances equal across individuals; SCA-IND, with zero covariances and free variances; SCA-PF2 with equal covariances and free variances, and MLSCA-P, with both covariances and variances free across individuals. The loading matrices of SCA-ECP and SCA-P solutions have transformational freedom, just like in PCA, which can be exploited to facilitate the interpretation. In contrast, SCA-IND and SCA-PF2 solutions are uniquely estimated in practice, up to permutation and reflection of the components.

What do differences in (co)variances of within-component scores across individuals tell about inter-individual differences in intra-individual structure? The *variances* express the relative degree of intra-individual variability of the corresponding components. Thus, individual differences in within-component variances imply different degrees of stability across measurements on this very component. Those differences are allowed for in the SCA-IND, SCA-PF2 and SCA-P models. In the most extreme case, such a variance may be (close to) zero for one or more individuals, implying that this within-component is of hardly any relevance at all for those individuals. When the *raw* data of the latter individuals would have been analyzed separately by a PCA, this component would not have been found. On the contrary, a PCA of the *standardized* data could possibly result in this component. However, the status of this component is questionable. After all, it is based on variables of which the variability is artificially inflated.

The *covariances* between the within-components express their mutual degree of linear dependence. Thus, differences in within-component covariances mean that the degree of linear dependence may vary across individuals; this is allowed for in the SCA-P model only. To interpret the strength of those linear dependencies, it is convenient to consider the individuals' correlations between within-components. In the most extreme case, this correlation equals one for an individual, which means that the two within-components involved are not separable for this very individual. When the data of the latter individual would be analyzed with PCA, the two within-components would end up into one component.

To sum up, when the interest is in considering the inter-individual differences in intra-individual structure, one should examine the differences across individuals in (co)variances of within-components. Whether those differences are possibly present in the model representation, depends on the SCA variant involved. If capturing any possible differences in intra-individual structure is of key importance, the least constrained SCA-P model is to be preferred.



## **Sources of Inter-Individual Variability in the MLSCA Model**

The inter-individual variability is described by the between-loadings and between-component scores. The between-loading matrix expresses which variables covary strongly across individuals, in terms of the average level across measurements. The between-loading matrix has transformational freedom, implying that it can, for instance, be rotated towards simple structure. The between-component scores reflect the relative positions of the individuals on the between-components.

## **Different Sources of Intra- and Inter-Individual Variability in the MLSCA Model**

The between- and within-loading matrices may, and in practice often will, differ from each other. For example, to assess their mood structure across time, 12 individuals diagnosed with Parkinson's disease scored a mood questionnaire on 53–71 consecutive days (Shifren, Hooker, Wood, & Nesselrode, 1997). The questionnaire used was the Positive and Negative Affect Schedule (PANAS; Watson, Clark, & Tellegen, 1988), which measures two dominant dimensions of emotional experience. Each day, the individuals rated the degree to which they experienced specific mood aspects that day. The MLSCA of the resulting scores (see Timmerman, 2006) revealed that the inter-individual differences in within-subject means across the different days could be described by two components, namely Positive and Negative affect. This structure was completely in line with the one reported by Watson et al. (1988). On the contrary, the intra-individual mood structure, which expresses the daily fluctuations about the within-subject means, was described well by two uncorrelated within-components. The latter were labeled as introversion and emotional stability. Those results are in line with findings that positive and negative emotional traits, that is the within-subject means, are independent, but that positive and negative emotional states are negatively related within subjects (Vansteelandt et al., 2005). This contrasts to suggestions that positive and negative affect form the dominant dimensions of both emotional traits and states (Watson & Clark, 1994; Zevon & Tellegen, 1982).

## ***Model Selection, Stability, and Inference***

The aim in modeling data using a component model is to separate the observed data into a systematic and a residual part, where the systematic part is described by an interpretable and preferably sparse model that would fit the population data well. The latter means that a model with relatively good fit and low complexity is favored. This idea underlies the well-known scree-test (Cattell, 1966) as well. As a measure of fit, the proportion of variance accounted for (VAF) is usually considered, because it indicates which part of the observed data is covered by the model. In MLSCA, the

model complexity is influenced both by the specific variant considered and by the number of components. In practice, a series of MLSCAs is performed, using the different model variants, with various numbers of components. Then, the models are ordered from least to most complex and the model(s) with a relatively large difference in VAF compared with the preceding model and a relatively small difference in VAF compared with the subsequent model are considered. The interpretability should play a key role in the final model selection.

Once a model has been selected for the sample data, one may wish to verify to what extent the model is reasonable for describing the population data as well. As population data is not available, one has to resort to considering the stability of the estimated models over subsamples of the data at hand. A complicating issue is that one deals with multiple populations, namely the population of measurements of each individual observed, and, possibly, the population of individuals from which the sample has been drawn. In practice, one may wish to generalize to only a part of those populations, rather than all populations. Moreover, one may be interested in only parts of the model, like the within-loadings. Then, one should consider the stability for part of the populations, or parts of the model. The stability of model parts can be assessed via split-half analysis, as described in Timmerman (2006).

Apart from the stability of the full model over samples, one may consider inferential information on the individual parameters. Confidence intervals on individual parameters can be estimated using the bootstrap (Timmerman, Kiers, Smilde, Ceulemans, & Stouten, 2009). Herewith, it is important to decide whether only a generalization to the population of measurements within the individuals is warranted, or also to the population of individuals, because this influences the resampling strategy to take. One should realize that small sample sizes yield unreliably estimated confidence intervals (Timmerman et al., 2009), that is, the estimated CIs are consistently too small.

### ***MLSCA or Multi-Group/Multilevel SEM?***

The model used in MLSCA shows much resemblance to particular Structural Equation Model (SEM) variants, which are known as multi-group and multilevel SEMs (see e.g., Jöreskog, 1971; Muthén, 1989; Du Toit & Du Toit, 2008). For a discussion of the relationships between MLSCA and multi-group and multilevel SEMs, we refer to Timmerman et al. (2009). The key difference between the approaches used with Component Models (CMs) and SEMs is in the definition of the factors. In CMs the factors (components) are based on the observed variables, and in SEMs on the common parts of the variables. This seemingly minor detail has many consequences, which has been extensively described in comparisons of special cases of the two approaches: PCA and Common Factor Analysis (CFA; e.g., Jolliffe, 2002; Widaman, 2007).

In a CFA the factors are based on those parts of the variables that at least some variables have in common, while the unique parts of the variables are set apart as

different factors. In a PCA the factors are based on the observed variables and the distinction between common and unique parts is simply being ignored. Because it is reasonable to assume that each observed variable suffers from measurement error, and thus is partly unrelated to other variables, a CFA is more complete than a PCA. This incompleteness provides the main objection to PCA.

It is well-known that when a Common Factor Model (CFM) holds perfectly, and a PCA is performed, the PCA parameter estimates consistently differ from the population parameters (Widaman, 1993, 2007). Hence, if a CFM holds exactly, a common factor analysis is to be preferred. However, as is now widely recognized, all common factor models in the social sciences are an *approximation* to reality (Browne & Cudeck, 1992). Therefore, it is important to know how close an estimated model is to 'reality', hence what the size is of the so-called model error. Because of their approximating characters, in empirical applications, the model error of an estimated PCA could be similar or even smaller than that of an estimated CFM.

Even if CFM would be superior over PCA in terms of model error, one may question whether a PCA based interpretation essentially differs from a CFM based one. If one only looks for clusters of variables to interpret the factors (components), CFM results will offer the same interpretation (unless unique variances are very high, or highly unequal across the variables associated to the same factor).

Apart from the essential difference in the definition of the factors, there are differences in tradition between CFM and PCA, respectively, like in the typical estimation procedure (maximum likelihood versus least squares), distributional assumptions (strong versus weak) and model approach (confirmatory versus exploratory). Although those properties are by no means intrinsic to either of the methods, they do affect the practical use of the models. For example, when a distributional assumption required for a particular common factor analysis (CFA) is violated, this results in an increase of model error, which reduces the headstart of CFA over PCA. Those differences in tradition become even more influential in more complicated types of analysis, like MLSCA and multi-group SEM. For example, a confirmatory approach requires strong ideas about 'the' correct model, because otherwise the risk of missing this model becomes rather large. The confirmatory nature of SEM analyses is important in the current context: when examining sources of intra-individual variability, strong theoretical guidance is usually lacking, and hence exploratory methods are called for.

A further advantage of the use of a CM over SEM is that component scores are readily obtained, whereas factor scores can only be estimated, with different methods yielding different estimates. Because in the current context both the between- and within-component scores provide information on the individual, it is advantageous to have them directly.

In empirical data analysis, identification and estimation problems trouble SEMs more than component models. That is, sample size limitations, problematic data sizes (e.g., very large number of variables) or severe violations of distributional assumptions may hinder a successful empirical use of SEM, whereas a Component Analysis is much less sensitive to those requirements.

To sum up, the model used in MLSCA is incomplete in that it does not account for unique variances. However, in empirical applications, it is questionable whether

the estimated MLSCA model suffers from a larger model error than its counterpart that does account for unique variances. Moreover, because a MLSCA solution can be obtained in nearly all applications, MLSCA may be the only option to arrive at an insightful solution.

### ***Related Models to MLSCA***

The key idea of MLSCA is to disentangle the sources of within- and between-variance in the data. This very idea underlies the integrated trait-state model (ITS model; Hamaker, Nesselroade, & Molenaar, 2007) as well. More specifically, an analysis with the ITS model aims at identifying subgroups of individuals with identical within-models. The essential difference between the two models is that MLSCA is a CM and the ITS model a SEM, implying that the latter explicitly models unique variances. As explained in the previous section, CM and SEM differ in tradition. This shows up when comparing MLSCA with the ITS model. For example, the ITS model assumes the within-factor scores to follow an auto-regressive model, which makes the ITS model more restrictive than MLSCA. Furthermore, the ITS model is confirmatory, as is for instance illustrated by the example presented by Hamaker et al., 2007. Finally, in the ITS model, the similarities between subgroups with different within-models are relatively difficult to detect. In MLSCA, those similarities and differences in within-models get ample attention, albeit possibly at the cost of less precision.

When considering related models to MLSCA, the work of Flury (1988) cannot remain unnoticed. Flury discusses a hierarchy of CMs (1988, pp. 60–62) for multi-group data that can be applied equally well to repeatedly gathered data from more than one individual. Flury's models cover the within-part of the data, and bear close resemblance to SCA (see Section "Sources of Intra-Individual Variability in the MLSCA Model"). In fact, the most constrained model of Flury equals SCA-ECP and Flury's Common Principal Component (CPC) Model equals SCA-IND. Flury also discusses the Partial CPC model, which involves both common within-loadings and individual specific loadings. The main difference is the estimation, where Flury uses maximum likelihood and MLSCA least squares optimization.

## **Empirical Applications of MLSCA**

### ***Emotions in Daily Conflicts Between Adolescent Girls and Their Mothers***

As a first illustration of the usefulness of MLSCA, we present an empirical example from a study on emotions in daily conflicts between adolescent girls and their moth-

ers. Until now, research on adolescent-parent relationships has primarily focused on the content and frequency of conflicts. The emotions involved in such conflicts remain largely understudied and if affective aspects are included, they are usually reduced to a positive–negative dichotomy. In this study we focus on the emotions *after* conflict. Based on findings from observational research on marital interactions (Gottman & Levenson, 1999) we know that the ability to rebound, implying a neutral or positive feeling after conflict, may be more important to relationship quality than the amount of “negativity” expressed during conflict.

To obtain a proper understanding of the emotional processes associated with conflict interactions, it is essential to examine various conflicts within the girls across time. Therefore, we conducted a diary study in which fifteen 15-year-old girls reported on their daily conflicts with their mothers. The diaries consisted of 6 waves across 1 year and each wave comprised a 2-week diary episode, where the girls were instructed to report on each conflict they had with their mother during this period. Because of the explorative nature of this study the emotions after conflict were assessed with an extensive list of 17 different emotions (see Table 14.1). The girls indicated to what extent they felt certain emotions on a 4 point Likert scale (ranging from 0=not at all to 3=very much). The girls completed on average nine weeks of daily diary (calculated in days: Mean (*M*)=67, Standard Deviation (*SD*)=13.8, range=26–77). In total, scores were obtained on 142 conflicts (*M*=9.47; *SD*=4.39).

**Table 14.1** Varimax rotated between-loadings (left part) and within-loadings (right part) of the emotion-after-conflict data. Loadings greater than ±0.30 are highlighted in bold face

	Between				Within			
	Positive	Negative internal	Frustration	Neutral	Positive	Negative internal	Indignant	Guilt
Hopeful	<b>0.34</b>	-0.01	0.02	-0.20	-0.26	-0.09	-0.00	<b>0.44</b>
Relieved	<b>0.48</b>	0.05	0.12	-0.12	<b>0.61</b>	-0.12	-0.07	-0.07
Happy	<b>0.41</b>	-0.01	0.09	-0.04	<b>0.76</b>	-0.05	-0.05	-0.18
Proud	<b>0.32</b>	-0.02	-0.03	-0.06	<b>0.62</b>	-0.00	0.01	<b>0.38</b>
Disappointed	-0.06	<b>0.42</b>	-0.17	-0.09	-0.08	<b>0.53</b>	0.21	0.09
Sad	0.14	<b>0.51</b>	-0.06	-0.03	-0.11	<b>0.63</b>	0.14	-0.10
Lonely	0.02	<b>0.39</b>	-0.09	0.04	-0.03	<b>0.73</b>	0.07	-0.03
Hurt	-0.09	<b>0.40</b>	-0.08	0.05	0.04	<b>0.75</b>	-0.02	-0.03
Frustrated	-0.25	-0.08	<b>0.51</b>	-0.07	-0.10	-0.10	<b>0.35</b>	0.10
Angry	-0.13	0.09	-0.27	-0.03	-0.07	0.12	<b>0.69</b>	-0.06
Not taken serious	-0.08	0.15	-0.24	-0.05	-0.05	0.21	<b>0.63</b>	-0.18
Misunderstood	-0.18	0.17	-0.29	-0.05	-0.03	0.13	<b>0.43</b>	-0.18
Neutral	-0.08	-0.09	-0.03	<b>0.41</b>	0.15	-0.10	<b>-0.48</b>	0.17
Guilty	0.06	-0.06	-0.04	-0.32	-0.06	0.12	0.01	<b>0.61</b>
Regret	0.08	0.00	-0.03	-0.28	0.12	-0.08	-0.07	<b>0.47</b>

Based on the work of authors in the field of personality and emotional development (Lewis, 1995, 2000; Magai & McFadden, 1995; Magai & Nusbaum, 1996) we expected to find differences between the girls in their “dominant” emotional pattern, i.e., their general level of emotions after conflict. Based on theories within the field of social (e.g., Frijda, 1986, 2001; Lerner & Keltner, 2000; Roseman & Evdokas, 2004) as well as clinical psychology (e.g., Guerrero & La Valley, 2006; Sanford, 2007) we expected that those differences in dominant patterns between the girls could best be described along four emotional dimensions, namely internal negative emotions, anger related emotions, guilt related emotions, and positive emotions.

Due to the lack of knowledge about the individual patterning of emotions over time we did not have any predefined hypotheses with respect to the intra-individual emotional structure. On the basis of theories about personality development (Lewis, 1995, 2000; Magai & McFadden, 1995; Magai & Nusbaum, 1996), which state that emotional development is a highly idiosyncratic process, we did expect to find inter-individual differences in the organization of emotions over time. Therefore, we wished to explore how emotions organize within the girls over time, to what extent this differs across girls, and how this relates to the girls’ dominant emotional patterns over time. In addition, based on our own empirical work and the work of others (Granic, Hollenstein, Dishion, & Patterson, 2003) we expected to find inter-individual differences in the intra-individual variability of the emotions over conflict episodes, i.e., that the girls would differ in the degree to which they vary in their emotions over time.

In order to explore the above mentioned hypotheses and questions we applied MLSCA analyses to the 142 conflicts by 17 emotions data matrix. Because we wished to express possible differences in intra-individual structure across girls as good as possible, we preferred the—least constrained—MLSCA-P model. The between- and within-scree plots did not provide a clear indication on the numbers of components. On the basis of the interpretability a MLSCA-P solution with four between-components and four within-components was chosen.

The within-variance made up the largest part of the total variance (77.72%) and the between-variance the remaining 22.28%. This implies that there is more variation within the girls over conflict episodes than between the girls on the average level. With the MLSCA-P model, the four between-components accounted for 77.66% of the between-variance (which is 17.31% of the total), and the four within-components accounted for 51.22% of the within-variance (which is 39.80% of the total). As can be seen in Table 14.2, the percentage of within-variance accounted for (VAF) per girl ranged from 25.96 to 81.42% ( $M=45.55\%$ ,  $SD=15.85\%$ ). Although the VAF per girl was generally satisfying there were also some girls whose data were not described by the model very well.

The between-part of the selected MLSCA-P solution gives insight into the inter-individual emotional structure in dominant emotional patterns over time. The four Varimax rotated between-loadings (see left part of Table 14.1) were interpreted as *Positive*, *Negative Internal*, *Frustration*, and *Neutral*. This partly supported our hypotheses concerning the between-structure of the emotions. As expected, the positive emotions and negative internal emotions formed separate clusters. We had

**Table 14.2** The left part presents the variance accounted for (VAF) per girl. The middle part displays the between-component scores for the individual girls; component scores greater than 1 are highlighted in bold face. The right part of the table gives the within-component variances, which are computed across all conflicts of a girl; variances greater than 1 are highlighted in bold face.

Girl	VAF	Between-component scores				Within component variances			
		Positive	Negative internal	Frustration	Neutral	Positive	Negative internal	Indignant	Guilt
1	62.32	-0.71	0.43	-1.10	-0.59	0.05	<b>3.19</b>	<b>1.48</b>	<b>1.25</b>
2	30.90	0.30	-0.61	-0.21	0.96	0.62	0.01	0.56	0.03
3	42.76	-0.12	-0.76	0.03	<b>1.84</b>	0.04	0.04	<b>1.18</b>	0.11
4	46.09	<b>1.46</b>	0.71	-0.23	-0.20	<b>3.13</b>	0.96	0.90	1.41
5	52.73	<b>1.35</b>	-0.20	-0.20	-2.49	<b>1.54</b>	0.64	0.17	<b>9.43</b>
6	27.47	-0.36	0.18	-0.82	-0.18	0.13	0.79	0.45	0.74
7	81.42	0.03	<b>3.67</b>	-0.06	0.74	0.46	<b>8.65</b>	<b>3.70</b>	0.09
8	42.19	-0.78	0.13	-0.09	0.08	0.14	0.53	<b>2.46</b>	0.07
9	44.00	-0.43	-0.64	-1.71	-0.98	<b>1.35</b>	0.11	<b>1.55</b>	<b>1.47</b>
10	32.71	-0.20	-0.74	-0.45	0.50	0.03	0.01	0.37	0.13
11	64.12	<b>2.87</b>	-0.60	0.20	0.77	<b>7.40</b>	0.04	0.13	<b>1.62</b>
12	31.43	0.37	-0.31	1.58	-1.66	<b>2.15</b>	0.08	0.31	<b>1.61</b>
13	39.26	-0.89	-0.58	-0.31	-0.40	0.02	0.16	<b>1.69</b>	0.57
14	59.82	<b>2.30</b>	0.18	0.51	0.40	<b>5.31</b>	0.30	0.06	0.52
15	25.96	-0.96	-0.07	<b>1.98</b>	-0.19	0.17	0.04	0.28	0.10

predicted separate clusters of guilt related and anger related emotions, which both hardly showed up. Instead of guilt related and anger related emotions, the important emotions to express differences in girls in dominant emotions across time appeared to be frustration for the third component, and the neutral emotional category for the fourth component. The latter could have been labeled also as a rebound component. That is, feeling neutral means that they have recovered from the negative emotions experienced during conflict.

Subsequently, we investigated the girls' scores on the four distinguished dimensions in dominant emotional reactions, i.e., the between-component scores (see middle part of Table 14.2). Between-component scores are standardized over girls and conflicts (i.e., scaled to have a mean of zero and variance of one across girls' conflicts and weighted according to their number of conflicts). Therefore, a between-component score indicates to what extent this girl scores above (or below) average, on this very component.

We first inspected per component the distributions of the between-component scores (see middle part of Table 14.2). The between-component Positive appeared to be rather right-skewed, with a few girls scoring high, whereas Frustration and Neutral are more symmetrically distributed. The component Negative internal appeared rather symmetrically distributed, with one clear positive outlier (Girl 7). When considering the pattern of between-component scores per girl, five girls appeared to score close to the mean on all four between-component scores (i.e., within one standard deviation). The remaining girls scored high (larger than one standard deviation from the mean) on at most two

between-components. These emotional profiles can be used for additional analyses, like studying the relationship between a predominantly negative internal reaction to conflicts and the autonomy development of the adolescent girl. A possible hypothesis is that forming a pattern of negative internal emotions to conflicts could bear the risk of withdrawing from conflicts and giving up the fight for autonomy. The within-part of the selected MLSCA-P solution offers insight into the variability of emotions within the girls over conflict episodes. That is, it provides information about the intra-individual structure and the intra-individual variability of emotions over time.

Based on the Varimax rotated within-loadings, the four within-components were labeled as Positive, Negative internal, Indignant, and Guilt (see right part of Table 14.1). We did not have any predefined hypotheses concerning the structuring of emotions within the girls over time. Inspection of Table 14.1 reveals several interesting differences and similarities in the between- and within-parts of the model.

First of all, it is interesting to note that the within-loadings were considerably higher than the between-loadings. This implies that the within-part of the model explains a larger proportion of the total variance than the between-part. This is completely in line with the fact that the within-variance was 77.72% of the total variance. For example, the within-loadings of anger are much higher than the between-loadings. The variance at the within-level makes up 84% of the total variance of anger. This means that girls do vary relatively much in their anger scores over conflict episodes, but not so much in their general level of anger, which is probably due to the fact that anger is a common emotion after conflict.

Secondly, comparing the between- and within-components revealed a salient similarity in the first two components, with almost the same clusters of emotions showing high loadings. Therefore, the same names were attached to those two components, namely Positive and Negative internal. However, the loadings on the other two between- and within-components revealed interesting differences.

The third within-component, which we have labeled Indignant, is characterized by high loadings for anger, frustration, the feeling of not taken serious and misunderstood, and not feeling neutral. This cluster of emotions can be interpreted as a typical teenage-component, i.e., feeling indignant after conflict, probably due to the fact that they didn't succeed in gaining the wanted autonomy. Thus, we found the expected cluster of anger-related emotions at the intra-individual level, which is in contrast to our findings at the inter-individual level.

The fourth within-component that we labeled Guilt is characterized by high loadings for guilt and regret. Additionally, the emotions of hope and proud had considerably high loadings on this within-component. That hope went together with feelings of guilt and regret over conflict episodes can be explained by an attempt to repair.

### **Inter-Individual Differences in Intra-Individual Structure**

Inter-individual differences in intra-individual structure find expression in the variances of and correlations between the within-components, as explained in Section "Sources of Intra-individual Variability in the MLSCA Model". To assess inter-



individual differences in the girl's emotional structure across conflict episodes, we inspected the variances of and correlations between the four within-components.

As can be seen in the right part of Table 14.2, the individual variances differed considerably across girls per within-component, implying large inter-individual differences in terms of variability of emotions over conflict episodes. Moreover, the girls' relative degrees of variability differed across within-components. For instance, Girl 11 had the highest amount of variability on the Positive component, and Girl 7 on the Negative internal component. On the other hand, there are some girls, like Girls 2, 10, and 15, who showed little variation across all four within-components. A low within-component variance means that that this within-component is of hardly any relevance for the girl involved. For instance, Girl 2 almost never reported emotions associated to the Guilt and Negative internal emotion components; hence she had almost zero variation on these two components. Consequently, her emotional structure over the conflict episodes could have been best described by means of two components (i.e., Positive and Indignant).

The individual correlations between the within-components that appeared higher than 0.75 in absolute value are displayed in Table 14.3. Note that for girls with small numbers of reported conflicts, the correlation pattern should be read with caution. As can be seen in Table 14.3, several girls showed rather high correlations between particular within-components, implying that for those girls the components involved could be combined. Girl 3 is an interesting case because she showed correlations between all four within-components larger than 0.75 (except for Positive and Negative internal that still correlated 0.49). Thus, the reported emotions of Girl 3 across conflict episodes could be described to a rather large extent using only a single component.

In sum, investigating the individual correlations of the within-components and the variances of the within-components revealed interesting additional information about differences between the girls in the way their emotions are organized across

**Table 14.3** The individual correlations between the within-component scores. Only correlations above  $\pm 0.75$  are reported here

Girl	# Conflicts	Within-component pair		Correlation
2	7	Negative internal	Indignant	-0.96
3	13	Negative internal	Indignant	-0.91
3	13	Negative internal	Guilt	0.83
3	13	Positive	Indignant	-0.77
3	13	Positive	Guilt	0.84
3	13	Indignant	Guilt	-0.88
7	8	Negative internal	Guilt	-0.83
9	8	Negative internal	Indignant	-0.78
11	5	Negative internal	Positive	-0.86
11	5	Indignant	Guilt	-0.77
14	7	Indignant	Guilt	-0.93
15	15	Indignant	Guilt	-0.90

measurement points. Based on the idiosyncratic nature of emotional development we expected to find differences in the intra-individual structure of emotions. The MLSCA-P model allowed us to explore these differences while at the same time also pointing out the similarities between the girls.

### The Course of Emotions over Conflict Episodes

To assess the course of emotions across conflict episodes, we plotted, for each girl, the within-component scores against time. Two exemplary plots are presented in Fig. 14.1. For Girl 7, the 5th and 6th conflict were predominantly characterized by high levels of positive emotions. After conflicts 7 and 8, she reported high levels of negative internal emotions. It would be interesting to relate these time plots to additional information about the conflicts, to assess whether any relationship exists between the topic, the solution of the conflicts and the reported emotions. For example, it might be that Girl 7 “won” the 5th and 6th conflict, and therefore felt happy afterwards. In addition, the time-plots can also be used to analyze trends in the emotional organization over time.

While visually comparing the graphs across the 15 girls, a salient difference between two groups of girls emerged, namely those who tended to fluctuate much in their emotions across conflicts, and those who were very stable across time. We denoted those groups as the *flexible* and *rigid* girls, of which Girls 7 and 10 are respective examples. Observational research has shown the negative consequences of emotional rigidity within conflict interactions in terms of the development of the adolescent and the parent-child relationship (Granic et al., 2003). It would be interesting to investigate whether the same effects can be found for emotional rigidity across conflict interactions.

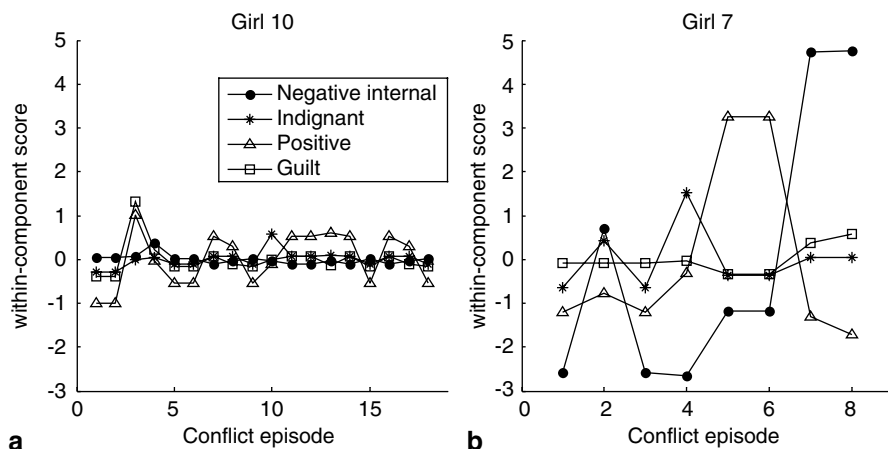

Fig. 14.1 Within-component scores plotted against conflict episodes for (a) Girl 10 and (b) Girl 7

### **Relating Differences in Dominant Emotional Pattern to Intra-Individual Variability**

As we have outlined above, the first and second between- and within-components were characterized by the same clusters of emotions. For those components, it is interesting to relate the between-component scores, i.e., the dominant emotional pattern, to the individual within-component variances, the intra-individual variability over conflict episodes (see Table 14.2). In both cases, a strong positive relationship emerged: for the Positive and the Negative internal components we found correlations of 0.92 and 0.95, respectively (and even without the outlier (Girl 7) the correlation for Negative internal is still 0.65). In sum, the high correlations imply that the higher the score on the general level of Positive and Negative internal emotions, the more they fluctuate in these emotions over time. This suggests that girls who showed a low variability on these two within-components did in fact (almost) always score zero on these emotions.

The analyses presented here revealed interesting differences with regard to the inter- and intra-individual structuring of emotions. We have shown that it is important to go beyond a positive–negative dichotomy and to distinguish between several distinct positive and negative emotions. This holds for the inter-individual as well as the intra-individual emotional structure. In both cases negative internal emotions came out as a separate emotional component. Several interesting hypotheses can be further tested on the basis of the dominant emotional reactions. The work of Strayer (2002) provides several hypotheses concerning the link between emotional profiles and the identity development of adolescents. For instance, too few anger and too much negative internal emotions could lead to impaired levels of autonomy and therefore undermines the development of a self-defined identity. In this way one can explore the link between emotional processes as expressed in the diaries and relational aspects or adolescent developmental outcomes, as measured in for instance questionnaires.

Furthermore, we also have found interesting results with regard to the intra-individual structure of emotions. The variances and correlations revealed information about the “use” of certain emotional components as well as the variability over time. In that way the girls can be distinguished on the basis of the size of their emotional repertoire (i.e., how much components do they use) and their emotional variability (i.e., flexible versus rigid girls). Also this information can then be used for further analyses. In the literature, several negative consequences of emotional rigidity have been reported, such as negative effects on the relationship and developmental outcomes (Granic et al., 2003; Hollenstein, Granic, Stoolmiller, & Snyder, 2004). A rich, complex, and balanced emotional profile on the other hand corresponds to higher personality, ego, self, and identity development (Abe & Izard, 1999; Magai & McFadden, 1995; Strayer, 2002).

### ***Drive for Thinness, Affect Regulation, and Physical Activity in Eating Disorders***

As a second illustration of the usefulness of MLSCA, we present an empirical example from eating disorder research. It has been observed that a substantial proportion

of patients with eating disorders, like anorexia nervosa or bulimia nervosa, engage in high levels of physical activity (Beumont, Arthur, Russell, & Touyz, 1994; Davis, 1997; Solenberger, 2001). To explain this observation, one often recurs to underlying psychological processes, like drive for thinness on the one hand and affect regulation on the other hand. The drive for thinness hypothesis states that eating disorder patients attach great value to weight and are actively trying to modify their body shape; physical activity and the resulting burning of calories is then just one of the ways to obtain the desired thinness ideal (Davis, 1997; Davis, Kennedy, Ravelski, & Dionne, 1994; Heatherton & Baumeister, 1991). The affect regulation hypothesis reads that physical activity is a way of coping with chronically negative affect (Davis, Katzman, & Kirsh, 1999; Holtkamp, Hebebrand, & Herpertz-Dahlmann, 2004; Thome & Espelage, 2004). To obtain an understanding of the psychological processes involved in excessive physical activity in eating disorder patients, it is important to consider these psychological processes both at the between and the within patients level. After all, the above cited findings that drive for thinness and affect regulation are related to physical activity at the between patients level, do not necessarily imply that this is also the case at the within patients level. As such, investigating whether these between patients relations between these three phenomena also show up at the within patients level, is important for the development of effective therapeutic treatments.

To study the relations between drive for thinness, affect regulation, and physical activity in eating disorders between patients and within patients across time, Vansteelandt, Rijmen, Pieters, Probst, and Vanderlinden (2007) conducted a study that included 32 female inpatients of the specialized inpatient eating disorders unit of the University Psychiatric Center in Leuven, Belgium. Nineteen of these participants suffered from anorexia nervosa and 13 from bulimia nervosa. During 1 week, these 32 patients filled out a questionnaire at nine randomly selected times a day. The patients were signaled to do so by an electronic device. The questionnaire consisted of 22 items that aimed at measuring the different processes under study. In particular, to measure affect regulation the patients rated the presence of 12 positive and negative emotions. The patients' momentary drive for thinness was tapped by means of four slightly adapted items from the Dutch version of the Eating Disorder Inventory (EDI; Garner, 1991; Van Strien, 2002). The urge to be physically active and physical activity itself were measured by three items. All 22 items were rated on a 7 point Likert-scale (ranging from 0=not applicable at all to 6=completely applicable). Sometimes the patients were not able to report. In total, scores were obtained on 1459 measurement occasions, implying that there are 557 missing measurement occasions. Whereas the mean numbers of obtained measurement occasions varies considerably across the patients ( $M=45.59$  per patient;  $SD=10.95$ ), they vary relatively little across the days of the week ( $M=208.43$  per day of the week;  $SD=9.48$ ).

A major advantage of this study over previous studies regarding physical activity, is that its design allows to simultaneously investigate both the between- and within-patient relations between affect, drive for thinness, and physical activity. At the between-patients level, we expected to find 4D namely physical activity, chronically negative affect, chronically positive affect, and dispositional drive for thinness. Furthermore, we expected to find substantial relationships between physi-

cal activity, chronically negative affect, and dispositional drive for thinness. Within patients, momentary drive for thinness and emotional states were expected to covary with physical activity over time. Furthermore, we wished to examine whether differences exist *across* patients in the *within*-patient variances of drive for thinness, emotional states, and physical activity, and in the within-patient relations between these three phenomena. For example, within-patient variances and within-patient relations between drive for thinness, affective states and physical activity may be especially strong in patients with more pronounced eating disorder pathology as indicated by, for example, a lower body mass index and more severe depression.

In the 1459 signals by 22 item data matrix, the between-variance made up 51.69% of the total variance and the within-variance the remaining 48.31%. This implies that affect, drive for thinness, and (urge for) physical activity vary substantially between patients as well as within patients. To gain insight into the between- and within-patient covariation of these processes, MLSCA analyses with 1 up to 6 between- and within-components were applied to the data.

### The Between-Part

On the basis of the between-sree plot in Fig. 14.2a and interpretability, the between-solution with 4 components was selected. This solution accounts for 84.6% of the between-variance in the 22 measured items, corresponding to 43.7% of the total variance in the data.

In an attempt to achieve simple structure, the between-loadings were first Varimax (Kaiser, 1958) rotated. As the resulting loadings still showed strong cross-

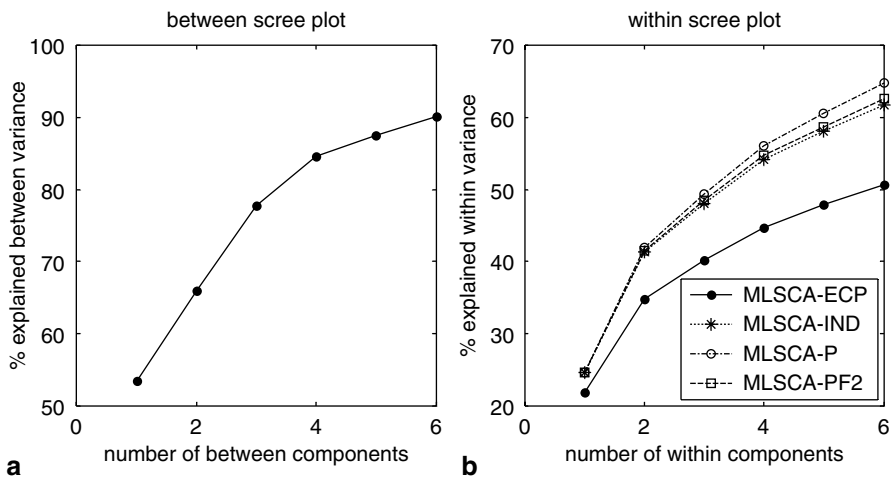

**Fig. 14.2** Percentage of (a) explained between-variance for MLSCA solutions with the number of between-components varying from 1 to 6, and (b) explained within-variance for MLSCA-ECP, MLSCA-IND, MLSCA-PF2, and MLSCA-P solutions with the number of within-components varying from 1 to 6

**Table 14.4** Promax rotated between-loadings (left part) and within-loadings (right part) of the eating-disorder data. Loadings greater than  $\pm 0.30$  are highlighted in bold face. PA vs NA is Positive versus Negative affect

	Between				Within	
	Negative affect	Positive affect	Urge to be physically active	Drive for thinness	PA vs NA	Physical activity
Pleased	-0.07	0.45	0.03	-0.05	0.61	0.04
Happy	-0.08	0.59	0.01	-0.02	0.56	0.02
Love	0.11	0.55	0.04	-0.09	0.36	0.06
Appreciated	0.13	0.65	-0.17	0.09	0.35	0.03
Sad	0.56	0.03	-0.08	0.07	-0.59	0.00
Angry	0.51	0.01	0.01	0.01	-0.58	0.07
Lonely	0.53	-0.09	-0.01	0.08	-0.41	0.01
Ashamed	0.70	0.06	0.01	0.07	-0.26	0.02
Anxious	0.79	0.09	0.14	-0.23	-0.33	0.06
Tense	0.65	-0.08	0.18	-0.16	-0.44	0.07
Guilty	0.64	0.02	0.03	0.14	-0.32	0.03
Irritated	0.36	0.07	-0.08	0.31	-0.42	0.06
Want to move	0.11	-0.03	0.75	-0.03	-0.03	0.34
Want to sport	0.12	-0.02	0.71	-0.05	-0.05	0.37
Want to be active	0.11	-0.05	0.77	-0.07	-0.02	0.33
Am active	-0.12	0.01	0.43	0.02	0.13	0.67
Am moving	-0.08	0.06	0.36	0.16	0.10	0.70
Am sporting	-0.06	0.12	0.39	0.10	0.10	0.65
Want to burn calories	0.04	-0.06	0.44	0.45	-0.08	0.21
Feel fat	0.00	0.00	-0.04	0.83	-0.20	0.08
Feel ugly	0.17	-0.05	0.05	0.69	-0.20	0.07
Want to loose weight	-0.07	0.04	0.10	0.78	-0.15	0.10

loadings, an oblique Promax rotation was conducted. On the basis of the resulting between-loadings (see left part of Table 14.4) the between-components were labeled as Negative affect, Positive affect, Urge to be physically active, and Drive for thinness.

To further interpret the between-loadings we considered the intercorrelations among the four between-components. It is interesting to note that Positive affect is unrelated to Negative affect at the between-patients level; this finding is in line with earlier results, for instance of Vansteelandt et al. (2005). Furthermore, as expected, we find that patients with a higher Urge to be physically active are characterized by chronically Negative affect (affect regulation hypothesis) and a stronger dispositional Drive for thinness (drive for thinness hypothesis). These findings may reflect the severity of the eating disorder: patients with more severe eating disorder pathology are characterized by higher levels of Physical activity, more chronically Negative affect and higher dispositions for Drive for thinness. To examine

**Table 14.5** Intercorrelations of the four between-components, and with Body Mass Index (BMI), depression measured by the Beck Depression Inventory (BDI), and the symptom severity index (SCL-90)

	Negative affect	Positive affect	Urge to be physically active	Drive for thinness
Positive affect	-0.10			
Urge to be physically active	0.38*	0.05		
Drive for thinness	0.53*	-0.25	0.47*	
BMI	-0.07	0.00	-0.57*	-0.06
BDI	0.48*	-0.43*	0.37*	0.67*
SCL-90	0.44*	-0.46*	0.55*	0.64*

\*  $P < 0.05$ 

this hypothesis, we correlated the scores of the patients on the between-components with three indicators of severity of eating disorder pathology: Body Mass Index (BMI), depression measured by the Beck Depression Inventory (BDI), and symptom distress measured by the Global Severity Index of the Dutch adaptation of the Symptom Checklist (SCL-90; Arrindell & Ettema, 1986). These correlations (see Table 14.5) showed that the patients with more severe depression scores, and stronger pathological symptoms are characterized indeed by less chronically Positive affect, and more chronically Negative affect, stronger Urge to be physically active and stronger Drive for thinness. A lower BMI appeared to be associated only to higher Urge to be physically active.

### The Within-Part

The within-scrree plot in Fig. 14.2b shows that MLSCA-IND, MLSCA-PF2, and MLSCA-P solutions describe the within-part of the data about equally well (see Fig. 14.2b), whereas the MLSCA-ECP solutions are clearly worse. This suggests the use of an MLSCA-IND solution, as for a specific number of within-component such a solution is more restrictive than MLSCA-PF2 and MLSCA-P solutions. Based on the within-scrree plot we retained a MLSCA-IND solution with two within-components. This solution accounts for 41.4% of the within-variance, corresponding to 20.0% of the total variance in the data.

The selection of a MLSCA-IND solution implies that the mutual relationships between the processes under study hardly differ across the patients. However, there seem to be considerable differences across patients in the extent to which their affects, drive for thinness and physical activity vary across the different measurement occasions. Before we discuss these differences in more detail, we will first address the interpretation of the two within-components.

The loadings of the 22 items on the two within-components are presented in the right part of Table 14.4. It can be concluded from Table 14.4 that the first within-component can be labeled Positive versus Negative affect. This single bipolar component in the within-structure is in line with previous findings

that positive and negative emotional states are negatively related within subjects (Vansteelandt et al., 2005).

The second within-component is clearly characterized by high loadings for the items that measure the actual physical activity; we label this within-component Physical activity. Here it is interesting to note that, in contrast to the between-loadings, the items that measure the Urge to be physically active have smaller within-loadings than the items that measure Physical activity itself. This implies that the largest source of the total variance of actual Physical activity is at the within-level, whereas, for Urge to be physically active, the largest source of the total variance is at the between-level. To interpret this difference in the between- and within-loadings, one first has to take into account that only a proportion of patients with an eating disorder display high levels of physical activity. Thus, only part of the patients have a strong desire to be physically active, implying a large amount of between patient variance in the urge to be physically active. Second, one has to consider that all patients were allowed to go home during the weekend; then, they were more able to engage in excessive physical activity, because on week days physical activity was partly restricted by the therapeutic program. This may explain why for actual physical activity, the largest source of variance is at the within-patient level.

To investigate whether this week/weekend difference in the therapeutic program indeed influenced degrees of Positive versus Negative affect and Physical activity, we considered the difference in means in within-component scores between week days and weekend days. Across all patients, those differences reveal that patients feel more positive during weekends (95% Confidence Interval (CI) [0.36; 0.57]) and report higher levels of physical activity (95% CI [0.06; 0.29]). More importantly, inspecting those differences in means for each patient separately, we found that, during the weekend, 15 of the 32 patients feel more positive and 8 patients engage more in physical activity. To visualize this week/weekend difference, we plotted the within-component scores of patient 28 on the Affect component (see Fig. 14.3a) against time and of patient 2 on the Physical activity component (see Fig. 14.3b), where week and weekend observations are indicated by circles and black dots, respectively.

### **Inter-Individual Differences in Intra-Individual Variances**

As stated before, the selection of the MLSCA-IND solution implies that the covariances of the within-component scores are equal to zero for all the patients. Given the interpretation of the within-components as Positive-versus-Negative-affect and Physical activity, this means that the affect regulation hypothesis did not appear to hold within patients. Furthermore, as the within-loadings of the drive for thinness items are close to zero, the MLSCA analysis reveals no clear evidence in favor of the drive for thinness hypothesis either. As such, within patients, it is not clear which psychological processes cause high levels of physical activity.

With respect to the within-patient variances, retaining a MLSCA-IND solution implies that for some patients the affective state fluctuates more than for others and that some patients show more variation in physical activity than others. Fig. 14.4



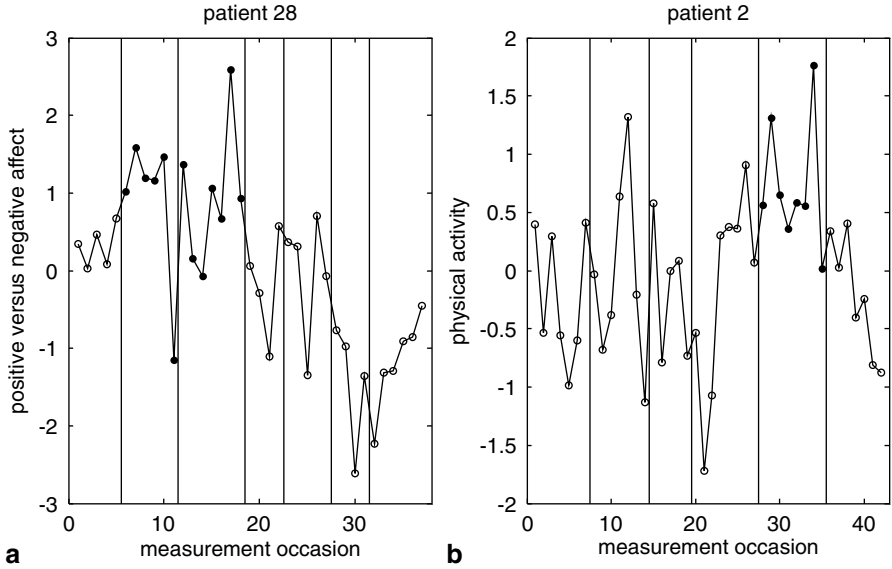

**Fig. 14.3** Within-component scores plotted against measurement occasions, for patients 28 and 2. The black dots indicate the weekend observations, the circles denote the week observations, and the vertical lines distinguish the subsequent days

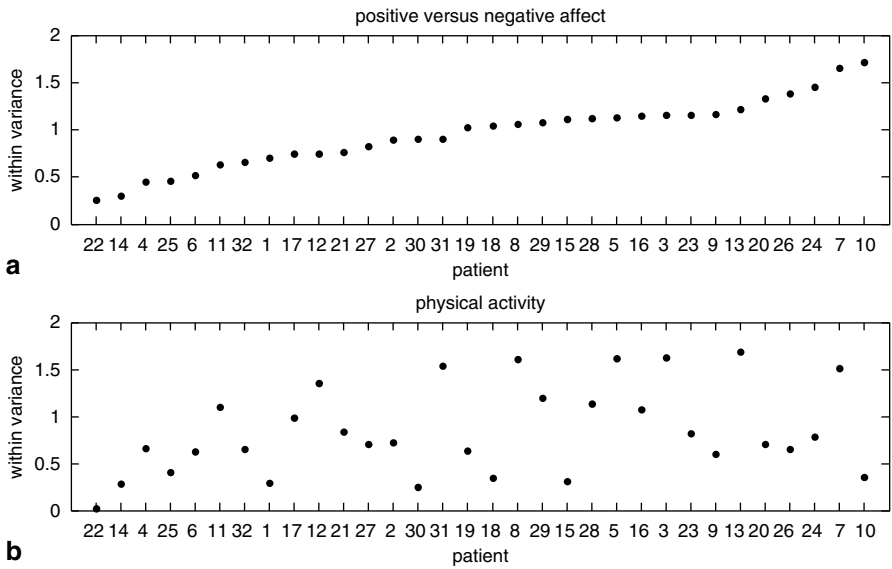

**Fig. 14.4** Variances of the within-component scores on (a) Positive-versus-negative-affect and (b) Physical activity, for all 32 patients

visualizes these differences in within-variances. For instance, whereas patient 7 varies a lot in both affect and Physical activity, patients 14 and 22 are very stable across measurement occasions. To interpret these differences across patients in within-variances, we related them to the patients' between-component scores. This revealed that patients with stronger general tendencies to feel negative show larger variability in Affect across measurement occasions ( $r = 0.37, p < 0.05$ ). As a result, patients with chronically negative affect appear to be emotionally unstable. Furthermore, the more a patient's Physical activity varies across time, the stronger her general Urge to be physically active ( $r = 0.69, p < 0.001$ ) and her general Drive for thinness ( $r = 0.39, p < 0.05$ ). Patients with strong Urges for physical activity may use every opportunity to escape from the restrictions imposed by the therapeutic program on physical activity, whereas patients without such a desire do not try to do this and therefore show less variability in Physical activity.

Summarizing, MLSCA reveals some interesting insights in physical activity in eating disorders at both the between- and within-patient level. At the between-patient level, results indicate that there are substantial differences between patients in the urge to be physically active which are moderately related to chronically negative affect and dispositional drive for thinness, but not to positive affect. In line with previous research (Vansteelandt et al., 2005), positive and negative affect proved to be unrelated at the between-patient level.

At the within-patient level, momentary emotional states and drive for thinness were not related to momentary physical activity. Furthermore, it was found that positive and negative emotional states were negatively correlated. This finding once again (e.g., Vansteelandt et al., 2005) demonstrates that between-subject relations between variables may be independent of within-subject relations between the same variables. Within-patient variability in affect and physical activity was related to week/weekend differences in the therapeutic program regarding for instance restrictions imposed on activity.

Finally, between-patient differences in within-patient variability were detected. Specifically, differences across patients in chronically Negative affect were related to the patient's degree of emotional instability over time. Additionally, differences between patients in dispositional Drive for thinness and Urge to be physically active were related to stronger within-patient variability in Physical activity.

## General Conclusion

In this chapter MLSCA is described as a method to identify sources of intra-individual and inter-individual variability in multivariate data which are repeatedly gathered from more than one individual. MLSCA provides component models for the between- and within-parts of the data, to describe the inter-individual and intra-individual variabilities, respectively. To gain a clear understanding of the intra-individual variabilities, it is important to properly express their similarities and differences across individuals. In the MLSCA model, this is regu-

lated via constraints on the covariances and variances of the within-component scores. The two empirical examples illustrated the insights MLSCA may offer. The illustrations showed that individual idiosyncracies may show up in different respects, like relationships between phenomena across time, development across time, or extremely high intensities compared to other individuals. To obtain a complete understanding of human behavior, it is essential to detect and explain those idiosyncracies.

## References

- Abe, J. A., & Izard, C. E. (1999). The developmental functions of emotions: An analysis in terms of differential emotions theory. *Cognition & Emotion, 13*, 523–549.
- Allport, G. W., & Odbert, H. S. (1936). Trait-names. A psycho-lexical study. Psychological monographs, (Vol. 47, Whole No. 211).
- Arrindell, W. A., & Ettema, J. H. M. (1986). *SCL-90: Handleiding bij een multidimensionale psychopathologie-indicator. Klachtenlijst SCL-90 (SCL-90)*. Lisse: Swets Test Services.
- Beumont, P. J. V., Arthur, B., Russell, J. D., & Touyz, S. W. (1994). Excessive physical activity in dieting disorder patients: Proposals for a supervised exercise program. *International Journal of Eating Disorders, 15*, 21–36.
- Bijleveld, C. C. J. H., & Bijleveld, F. D. (1997). A comparison of the applicability of two approaches to linear dynamic systems analysis for N subjects. *Kwantitatieve Methoden, 55*, 37–56.
- Browne, M. W., & Cudeck, R. (1992). Alternative ways of assessing model fit. *Sociological Methods and Research, 21*, 230–258.
- Cattell, R. B. (1952). The three basic factor-analytic research designs—their interrelations and derivatives. *Psychological Bulletin, 49*, 499–520.
- Cattell, R. B. (1966). The scree test for the number of factors. *Multivariate Behavioral Research, 1*, 245–276.
- Davis, C. (1997). Eating disorders and hyperactivity: A psychobiological perspective. *Canadian Journal of Psychiatry, 42*, 168–175.
- Davis, C., Katzman, D. K., & Kirsh, C. (1999). Compulsive physical activity in adolescents with anorexia nervosa: A psychobehavioral spiral of pathology. *Journal of Nervous and Mental Disease, 187*, 336–342.
- Davis, C., Kennedy, S. H., Ravelski, E., & Dionne, M. (1994). The role of physical activity in the development and maintenance of eating disorders. *Psychological Medicine, 24*, 957–967.
- Du Toit, S. H. C., & Du Toit, M. (2008). Multilevel structural equation modeling. In J. De Leeuw & E. Meijer (Eds.), *Handbook of multilevel analysis*. New York: Springer Verlag.
- Flury, B. (1988). *Common principal components & related multivariate models*. New York: Wiley.
- Frijda, N. H. (1986). *The emotions*. Cambridge: Cambridge University Press.
- Frijda, N. H. (2001). The self and emotions. In H. A. Bosma & E. S. Kunnen (Eds.), *Identity and emotion: Development through self-organization*. Cambridge: Cambridge University Press.
- Garner, D. M. (1991). *Eating disorder inventory-2 manual*. Odessa: Psychological Assessment Resources.
- Gottman, J. M., & Levenson, R. W. (1999). Rebound from marital conflict and divorce prediction. *Family Process, 38*(3), 287–292.
- Gower, J. C., & Dijksterhuis, G. B. (2004). *Procrustes problems*. New York: Oxford University Press.
- Granic, I., Hollenstein, T., Dishion, T. J., & Patterson, G. R. (2003). Longitudinal analysis of flexibility and reorganization in early adolescence: A dynamic systems study of family interactions. *Developmental Psychology, 39*, 606–617.

- Guerrero, L. K., & La Valley, A. G. (2006). Conflict, emotion, and communication. In J. G. Oetzel & S. Ting-Toomey (Eds.), *The sage handbook of conflict communication: Integrating theory, research, and practice* (pp. 69–96). Thousand Oaks: Sage.
- Hamaker, E. L., Nesselroade, J. R., & Molenaar, P. C. M. (2007). The integrated trait-state model. *Journal of Research in Personality, 41*, 295–315.
- Heatherington, T. F., & Baumeister, R. F. (1991). Binge eating as escape from self awareness. *Psychological Bulletin, 110*, 86–108.
- Hollenstein, T., Granic, I., Stoolmiller, M., & Snyder, J. (2004). Rigidity in parent–child interactions and the development of externalizing and internalizing behavior in early childhood. *Journal of Abnormal Child Psychology, 32*, 595–607.
- Holtkamp, K., Hebebrand, J., & Herpertz-Dahlmann, B. (2004). The contribution of anxiety and food restriction on physical activity levels in acute anorexia nervosa. *International Journal of Eating Disorders, 36*, 163–171.
- Hurlburt, R. T., Lech, B., & Saltman, S. (1984). Random sampling of thought and mood. *Cognitive Therapy and Research, 8*, 263–275.
- Jolliffe, I. T. (2002). *Principal component analysis*. New York: Springer-Verlag.
- Jones, C. J., & Nesselroade, J. R. (1990). Multivariate, replicated, single-subject, repeated measures designs and P-technique factor analysis: A review of intraindividual change studies. *Experimental Aging Research, 16*, 171–183.
- Jöreskog, K. G. (1971). Simultaneous factor analysis in several populations. *Psychometrika, 36*, 409–426.
- Kaiser, H. F. (1958). The varimax criterion for analytic rotation in factor analysis. *Psychometrika, 23*, 187–200.
- Lerner, J. S., & Keltner, D. (2000). Beyond valence: Toward a model of emotion-specific influences on judgment and choice. *Cognition and Emotion, 14*, 473–493.
- Lewis, M. D. (1995). Cognition-emotion feedback and the self-organization of developmental paths. *Human Development, 38*, 71–102.
- Lewis, M. D. (2000). Emotional self-organization at three time scales. In M. D. Lewis & I. Granic (Eds.), *Emotion, development, and self-organization: Dynamic systems approaches to emotional development*. Cambridge: Cambridge University Press.
- Magai, C., & McFadden, S. H. (1995). *The role of emotions in social and personality development: Hirstory, theory, and research*. New York: Plenum Press.
- Magai, C., & Nusbaum, B. (1996). Personality change in adulthood. In C. Magai & S. H. McFadden (Eds.), *Handbook of emotion, adult development, and aging* (pp. 403–420). San Diego: Academic Press.
- Muthén, B. O. (1989). Latent variable modelling in heterogeneous populations. *Psychometrika, 54*, 557–585.
- Nesselroade, J. R. (2007). Factoring at the Individual level: Some matters for the second century of factor analysis. In R. Cudeck & R. C. MacCallum (Eds.), *Factor analysis at 100: Historical developments and future directions* (pp. 249–264). Mahwah: Lawrence Erlbaum Associates.
- Nesselroade, J. R., & Molenaar, P. C. M. (1999). Pooling lagged covariance structures based on short, multivariate time series for dynamic factor analysis. In R. H. Hoyle (Ed.), *Statistical strategies for small sample research* (pp. 223–250). Thousand Oaks: Sage.
- Reise, S. P., Ventura, J., Nuechterlein, K. H., & Kim, K. H. (2005). An illustration of multilevel factor analysis. *Journal of Personality Assessment, 84*, 126–136.
- Roseman, I. J., & Evdokas, A. (2004). Appraisals cause experienced emotions: Experimental evidence. *Cognition and Emotion, 18*, 1–28.
- Sanford, K. (2007). Hard and soft emotion during conflict: Investigating married couples and other relationships. *Personal Relationships, 14*, 65–90.
- Shifren, K., Hooker, K. Wood, P., & Nesselroade, J. R. (1997). Structure and variation of mood in individuals with Parkinson's disease: A dynamic factor analysis. *Psychology and Aging, 12*, 328–339.
- Solenberger, S. E. (2001). Exercise and eating disorders: A 3-year inpatient hospital record analysis. *Eating Behaviors, 2*, 151–168.

- Spielberger, C. D. (1972). *Anxiety: Current trends in theory and research* (Vol. 1). New York, NY: Academic Press.
- Strayer, J. (2002). The dynamics of emotions and life cycle identity. *Identity, 2*, 47–79.
- Ten Berge, J. M. F. (1986). Rotation to perfect congruence and the cross-validation of component weights across populations. *Multivariate Behavioral Research, 21*, 41–64.
- Thome, J., & Espelage, D. L. (2004). Relations among exercise, coping, disordered eating, and psychological health among college students. *Eating Behavior, 5*, 337–351.
- Timmerman, M. E. (2006). Multilevel component analysis. *British Journal of Mathematical and Statistical Psychology, 59*, 301–320.
- Timmerman, M. E., & Kiers, H. A. L. (2003). Four simultaneous component models of multivariate time series from more than one subject to model intraindividual and interindividual differences. *Psychometrika, 68*, 105–122.
- Timmerman, M. E., Kiers, H. A. L., Smilde, A. K., Ceulemans, E., & Stouten, J. (2009). Bootstrap confidence intervals in multilevel simultaneous component analysis. *British Journal of Mathematical and Statistical Psychology, 62*, 299–318.
- Tucker, L. R. (1951). A method for synthesis of factor analysis studies (Personnel Research Section Report No. 984). Washington, DC: Department of the Army.
- Vansteelandt, K., Rijmen, F., Pieters, G., Probst, M., & Vanderlinden, J. (2007). Drive for thinness, affect regulation and physical activity in eating disorders: A daily life study. *Behaviour Research and Therapy, 45*, 1717–1734.
- Vansteelandt, K., Van Mechelen, I., & Nezlek, J. B. (2005). The co-occurrence of emotions in daily life: A multilevel approach. *Journal of Research in Personality, 39*, 325–335.
- Van Strien, T. (2002). *Eating disorder inventory-II Dutch version (EDI-II-NL)*. Amsterdam: Swets Test Publishers.
- Watson, D., & Clark, L. A. (1994). The PANAS-X. Manual for the positive and negative affect schedule—Expanded form. Retrieved March 26, 2008, from <http://www.psychology.uiowa.edu/Faculty/Watson/PANAS-X.pdf>
- Watson, D., Clark, L. A., & Tellegen, A. (1988). Development and validation of brief measures of positive and negative affect: The PANAS scales. *Journal of Personality and Social Psychology, 54*, 1063–1070.
- Widaman, K. F. (1993). Common factor analysis versus principal component analysis: Differential bias in representing model parameters? *Multivariate Behavioral Research, 28*, 263–311.
- Widaman, K. F. (2007). Common factors versus components: Principals and principles, errors and misconceptions. In R. Cudeck & R. C. MacCallum (Eds.), *Factor analysis at 100: Historical developments and future directions* (pp. 177–203). Mahwah: Lawrence Erlbaum Associates.
- Wood, A. M., Maltby, J., Stewart, N., Linley, P. A., & Joseph, S. (2008). A social-cognitive model of trait and state levels of gratitude. *Emotion, 8*, 281–290.
- Zevon, M. A., & Tellegen, A. (1982). The structure of mood change: An idiographic/nomothetic analysis. *Journal of Personality and Social Psychology, 43*, 111–122.

# Chapter 15

## Idiographic Microgenesis: Re-Visiting the Experimental Tradition of *Aktualgenese*

Rainer Diriwächter

*Den Inhalt der Psychologie bilden ausschliesslich  
Vorgänge, nicht dauernde Objekte.*  
(Wundt, 1922)

With the widespread introduction of psychometrics in the late 19th century, the field of psychology had seen a remarkable shift to outcome oriented analyses. The advocacy of pragmatic movements to determine how people are in order to fit them into pre-defined categories that allow for sorting and cataloguing has provided professionals with their tools of trade. Whether it be for the purposes of determining fundamental personality traits (e.g., via the NEO-PI), or for capturing desirable female and male attributes (such as through the Bem Sex-Role Inventory—the BSRI), the quantification of supposedly measurable human characteristics has somewhat abandoned the examination of the actual process of how exactly people think while filling out these questionnaires. For example, if we take Question No. 25a from Rotter’s (1966) measure of Internal–External (I–E) control—“*Many times I feel that I have little influence over the things that happen to me.*”—the precise cognitive processes through which the rater achieved his/her evaluated rating are largely left unexamined. We may wonder as to what the rater is attending to while reflecting on the meaning of “*many times*”? How does the rater construct the notion of “*influence*” and what constitutes “*little*”? And finally, what exactly is conjured up through the words “*things that happen to me*”? Julian Rotter’s reasoning for participants ratings pertains to prior reinforcement contingencies, and examining the actual thought process for each question on the questionnaire is of little importance for the purposes of the measurement. What matters is the outcome, which then can be used for establishing relationship patterns (with a keen eye on causal inferences) with other psychological measurements. Similarly, despite Sandra Bem’s (1979, p. 1048) claim that the BSRI is based on a theory of cognitive processing, the devel-

---

R. Diriwächter (✉)  
Department of Psychology  
California Lutheran University  
Thousand Oaks, CA 91360, USA  
e-mail: rdiriwae@clunet.edu

opmental progression of actual thoughts in a ‘here-and-now’ context while completing the BSRI is not examined. Instead, what is achieved through the 7-point Likert scales on her measure is the outcome of a train of thought leading up to a supposed generality of sex-typed characteristics.

However, the purpose of this present chapter is not to provide a critique on these various standardized measures, since in many cases this has already been done elsewhere (e.g., for the above mentioned cases, see Block, 1995 for a critique on NEO-PI; see Pedhazur & Tetenbaum, 1979 for a critique on the BSRI; or see Gatz & Good, 1978 for a critique on Rotter’s I-E scale). Instead, my goal is to examine psychological processes, not as static entities but rather in their experienced and developing forms within the microgenetic domain. While standardized measures certainly have their usefulness, of equal interest should be the investigation of how people think in a ‘here-and-now’ context. That is, how do thoughts progress? How do new thoughts emerge? In short, how do we achieve psychological synthesis and what components are involved in this process?

In this chapter, I try to shed light on these afore mentioned thoughts by taking a historic approach that revisits the microgenetic traditions from the standpoint of the early 20th century Leipzig circle of psychologists—thus, in the form of *Aktualgenese* (or actual genesis). Wilhelm Wundt’s work in regard to the later emerging *Aktualgenese* studies is considered as well as the methodological impact of the Würzburg school of psychology. Furthermore, a recount of the first studies for both visual (Wohlfahrt) and auditory (Werner) *Aktualgenese* is provided. Finally, in an effort to expand on the previous studies, the second half of this chapter outlines the psychological components involved during a microgenetic event. These components are examined in detail via narratives from the perspective of synthesis transformations.

## The Origins of Microgenetic Investigations

It is hard to pin-point the exact origins for the idea of Microgenesis, but they certainly pre-date (by a long shot) Heinz Werner’s (1956) first publication of the term in his paper “Microgenesis and Aphasia.” In fact, German psychologists had made the study of mental development (here not in the ontogenetic, but microgenetic sense) a key focus point since at least the days of Wilhelm Wundt (1832–1920), who’s Leipzig school of psychology (known today as the “First School of Leipzig”) became famous for its research on the fundamental processes of the mind (both lower and higher).

Wundt had two primary research programs for psychology: (1) experimental or physiological psychology and (2) *Völkerpsychologie*<sup>1</sup> (Diriwächter, 2004). The former aimed at establishing precise mental laws with regard to direct human experience (e.g., the experience of a changing tone in the environment). The latter pro-

---

<sup>1</sup> *Völkerpsychologie* can roughly be translated into social-developmental or cultural psychology. For a full discussion see Diriwächter (2004).

gram largely took a historical comparative analysis of the products of collective mental life (such as language, mythology, or customs) in order to see the workings of our higher mental processes through these objectifications.

It is hard to do Wundt's extensive research program any justices within just a few pages,<sup>2</sup> therefore I will concentrate only on those parts of Wundt's theory related to the later study of *Aktualgenese*.

First and foremost, Wundt's primary interest was in the psychological *processes*: "The content of psychology is formed exclusively through processes, not lasting objects" (Wundt, 1922, p. 26). To understand human psychological processes as we develop within an environment requires an understanding of the nature of our immediate and mediated experiences. To do so, Wundt proposed the "emotional *will*-theory" (*emotionale Willentheorie*) which stood in stark contrast with the logical intellectualized theories of the British associationist camp. It would be a mistake to see Wundt's conceptualization of *will* as standing for some independent being (in the metaphysical sense) that decides and acts upon these decisions. The *will* itself (like any other kind of psychological term) is an abstraction of a holistic (*ganzheitlicher*) complex. That is, it only highlights one particular side of the features contained in human experiences. Instead, the terminology "*will*" is used to indicate the direction of psychological development as the person acts upon the environment. There is no *will* without mental presentation (*Vorstellung*), nor is there any representation without feelings (and vice a versa for that matter). In the case of *will*, it merely directs our attention to the process of wanting something and as such it is a component of our motives and affects. Our affects, in return, consist of a progression of feelings that have a unitary character and whose development can be examined in terms of content or quality. As such, Wundt's voluntaristic<sup>3</sup> school of thought gave feelings a primary role for our willful processes.

Feelings are the very first step in human experiencing of his/her world. As our senses (our physiology) are impacted by the world, feelings such as strain, relaxation, or excitement represent the constant elements of *will* progression. They are the perceived processes and therefore parts of our immediate experiences.

## On the Issue of Causality

It may be injected here the question of cause-effect relationships between physical and the psychological realm. The problem with cause-effect relationships is that, strictly speaking, the relationship must follow the principle of equivalence (that

---

<sup>2</sup> The interested reader is directed to Passkönig (1912) who gives a good overview of Wundt's theoretical orientation, as well as to Rieber and Robinson (2001) for a more recent interpretation.

<sup>3</sup> Wundt's term "*voluntarism*" was chosen to differentiate his approach with those who saw feelings and processes of the *will* as merely the sensations of our muscles or organs; in short, to differentiate his approach from the atomism of the British and the intellectualism of Johann Friedrich Herbart (1776–1841). Wundt did not adhere to a strict form of physicalism or idealism. Instead, the term psychophysical parallelism is much more appropriate (see below).



of quantitative “sameness” or homogeneity). Within nature, the conditions for this principle is that as one form of energy disappears (cause) it must be found somewhere else—effect (= conservation of energy). Ideally, of course, it also requires that we should be able to reverse this process into its original form without the loss of energy. The problem is that while natural science has concerned itself with objects in nature, psychology (radical behaviorists not included) has focused largely on our mental processes, which completely lack the requirements for the principle of equivalence. For Wundt, the structure of consciousness is not an addition of elements (e.g., mechanical results), but rather something new; something that is qualitatively different from its parts (see Diriwächter, 2004, 2008).

For Wundt it was clear that mental life has both a physical as well as psychical side. Therefore, Wundt tried not to succumb to the physicalism of radical behaviorists or to the logical idealism of the intellectualists. Yet at the same time, Wundt was not a mind-body dualist either. Instead, he proposed the principle of psychophysical parallelism<sup>4</sup> (Wundt, 1922, p. 394). We cannot say that physical occurrences (e.g., the reception of photons by the retina) are translated one-to-one into a mental experience due to the inherent psychical nature of inner experience which abstracts the physical occurrence. Therefore, we are not able to fulfill the strict requirements of the principle of causality (which requires that only homogeneous processes can be directly causally linked—that is, physical with physical and psychical with psychical). Furthermore, from this point of view it follows—experimentally speaking—that there is no such thing as psychophysical causality as a connecting form. It is important to note that Wundt did not use the principle of psychophysical parallelism to deny any psychophysical interactions, but rather to overcome the limitations of seeing either the body or the mind as the primary substrate (causal factor) for analysis. It would therefore be wrong and misleading to give concepts like “interest”, “intelligence”, or “personality” causal inferences as they are auxiliary terms created by philosophers. Wundt referred to such kind of reasoning as “vulgar-psychology” (*Vulgärpsychologie*).

Instead, Wundt’s ideas highlight the *principle of actuality*. We must take that which is given and known to us and examine it from the vantage point of only known relationships. To this day, we can not yet explain the qualitative gap between the purely physical and the mental realm. Thus, Wundt’s psychophysical parallelism was not a metaphysical statement, but rather one that strictly followed that which is actually given: a physical *and* psychological world *as one*.<sup>5</sup> From this follows that there is just one experience (hence, his non-dualistic view), which however, as soon as it becomes the content of scientific analysis allows for two ways of scientific examination: One which looks at how the contents of our representations (*Vorstellungen*) in objective reality relate to each other (this is mediated), and one

<sup>4</sup> Wundt’s borrowing of this idea from Gottfried Wilhelm von Leibniz (1646–1716) should not go unmentioned. Indeed, Wundt (1917) pays homage to Leibniz’s influence in a specially dedicated monograph.

<sup>5</sup> Perhaps the term “double aspectism” instead of “psychophysical parallelism” would have been better suited to capture this idea. But since Wundt used the latter term, I shall continue to use it here.

which looks at how the experiencing subject (the mind *and* body), amongst all its pre-existing mental content (which are themselves based on past experiences), recognizes the characteristics of the objective world (Wundt, 1922, p. 395). In the later case we speak of investigating the immediate experiences.

Therefore, the questions of interest for psychology pertained to the processes of our immediate and mediated experiences. Wundt's strong interest in philosophy, coupled with his background as a physiologist gave him ample fuel to devise a systematic approach that gave rise to modern psychology; a new branch of philosophy called *experimental philosophy*. For this new approach, Wundt had sufficient practice while studying under Johannes Müller (1801–1858) in Berlin and while working for Hermann von Helmholtz (1821–1894) at Heidelberg.

## Wundt's Methodology

While early psychology relied on “pure” introspection, Wundt's approach stood in opposition to this and instead necessitated scientific instruments to implement what he called experimental introspection. Introspection is still very much in use today, and any questionnaire<sup>6</sup> (such as the NEO-PI, BSRI, or Rotter's I-E scale) that psychologists administer to their research participants can be seen as an alternate form of this old approach. For example, asking a person how he/she feels about something (e.g., on a 7-point Likert scale) or what he/she would do in a hypothetical scenario, or whether he/she believes something is true or false is an approach that requires the person to observe internal processes (e.g., coupling memory with a present context). The problem with this form of introspection is that the person needs to shift his/her attention (*Aufmerksamkeit*) from the external environment to the observations of the mental processes in a completely uncontrolled fashion. The more this happens, the more some internal processes become suppressed or changed entirely. Therefore, the researcher is not sure what exactly he/she is measuring<sup>7</sup> and whether the suppressed or changed internal processes will not be different in real-life scenarios. In short, the lack of scientific rigor in such approaches sheds only little insight into the developmental nature of our internal workings of the mind (for further discussions on this topic see Diriwächter & Valsiner, 2005; on NEO-PI-R in particular see Diriwächter, Valsiner, & Sauck, 2004; Valsiner, Diriwächter, & Sauck, 2004).

For Wundt, the psychological experiment was a means for getting at the psychological characteristics of an individual—in short, our immediate experiences. Wundt

---

<sup>6</sup> It should be emphasized that the modern day preference for the use of questionnaires skips entirely the actual processes of introspection and as mentioned earlier merely focuses on outcomes (e.g., what “score” did a participant achieve). As such, modern day introspection via questionnaires is a non-developmental approach.

<sup>7</sup> For example, does the measurement pertain to the boredom of the research participant who is trying to get as quickly as possible through the questions in order to finish the task, or is the participant really interpreting the question as the researcher had in mind?

believed that it was necessary to manipulate the conditions of internal perceptions so that they approximated as closely as possible the conditions for external perceptions. For this, full attention was required. In order to reduce the distortions stemming from memory, the time interval between the original act of perception and its subsequent reproduction for observation purposes could be kept to a minimum. Aside from certain apparatuses required for experimental manipulations, the psychological experiment necessitated two persons: Someone who ran the procedure and someone who acted upon a given task, whereby the latter person often included the person who designed the study. It is particularly in the case of perception studies that Wundt believed an experienced “introspectionist” was more useful than an untrained observer (Passkönig, 1912, p. 9). This was not because one needed special skills for introspection,<sup>8</sup> but rather because an inexperienced participant would devote too much attention to the procedural nature (the novelty effect) of the experiment, instead of on the actual object of study.

Experiments, for Wundt, could only be used for time-limited introspective studies that examined the character of immediate experiences as they occur. According to Wundt (1907, p. 308), four rigorous criteria needed to be met in order to call a study experimental:

1. The observer himself needed to be able to determine the occurrence of the event to be observed.
2. The observer must, as far as possible, be in a state of complete concentration towards the appearance of the stimuli as well as the stimuli’s developmental progression.
3. Each observation needed to be subjected to replication under the same experimental conditions.
4. The conditions under which a stimulus appears must also be examined under a variation of the accompanying circumstances so that the results can be properly ascertained. Thus, it is necessary to entirely eliminate certain circumstances or present them in different intensity or quality.

The time-limited nature of Wundt’s experiments and the focus on psychological processes (instead of mental objects) would set much of the stage for later *Aktualgenese* studies (see below). However, Wundt’s approach was not exclusively experimental. As mentioned earlier, Wundt saw experiments limited to investigating only the immediate experiences as they occur. Since much of what actually occurs in mental life outside the laboratory is multifaceted, it was clear that what was being dealt with via the experiments was just a limited abstraction (an elementary process) of holistic experiencing. In fact, much of Wundt’s work was actually non-experimental in nature. These studies drew upon the results of collective mental processes (such as

---

<sup>8</sup> Edward Titchener (1867–1927)—Wundt’s illegitimate intellectual offspring—on the other hand required his researchers to acquire special introspection skills. The fact that he was (and wrongly so) seen as the representative of Wilhelm Wundt in the USA, and that Titchener’s student, E. Boring (1950), wrote what became the primary source book for the history of psychology for a very long time, has done much to misrepresent Wundt’s theories and methodologies in America (see also Danziger, 1980).

language, religion, culture, mythology, and customs) in order to see how they operationally fit as structural configurations of our mental development. Furthermore, in the search for true psychogenesis, Wundt's momentous 10-volume collection of *Völkerpsychologie* (1900–1920) tried to document not only much of collective mental life as related to human psychological functioning, but also to show how the origins of mental development progressed (Diriwächter, 2004, 2006). This approach by Wundt has to be seen as a historical comparative one and not experimental.

## Apperception—The Elementary Form of *Will* Processes

In all areas of Wundt's studies one prominent feature involved in mental processes is that of apperception, a concept that can be traced to the philosophy of Gottfried Wilhelm von Leibniz<sup>9</sup> (1646–1716). Wundt (1922, p. 252) referred to *attention* (*Aufmerksamkeit*) as the condition which is characterized by unique feelings and captures mental content (*psychischen Inhalt*). The individual process which brings mental content to a clearer comprehension was called apperception (*Apperzeption*). The process of apperception finds several definitional refinements depending on its relationship to the given stimulus field. From an objective standpoint on *will*-processes, we can devote attention to numerous objects in our environment, which Wundt coined *Blickfeld des Bewusstseins* (the “looking-field” of consciousness). While this field can be perceived, it is not necessarily apperceived. Thus, that part of the field to which attention is given is called the *inneren Blickpunkt* (inner “looking-point”). Since most of the time we are not devoting our attention to just one object (or point), Wundt generally spoke of the “attention-field” (*Aufmerksamkeitsfeld*), which included several stimuli that capture our attention. If our attention is taken by an environmental stimuli (e.g., a sudden loud noise that unexpectedly occurs), Wundt called this *passive apperception*. On the other hand, when we are prepared and selectively focus on some kind of stimuli (e.g., an optical image projected via a tachistoscope) we speak of *active apperceptive* processes. It is important to note that both passive and active apperceptions are processes of the *will*; in the case of the former it was an unprepared act while the latter was prepared. Thus, with the passive apperceptions we can say that a single impression provides the deciding motive whereas with active apperceptions the willful actions may relate to a number of motives.

The actions of our *will* give the important connecting properties of our consciousness, whose relatively stable content comprises a feeling-complex that is associated with mental representations. As such, apperceptions with their connected feelings become the main carrier of self-consciousness. This in return allows for differentiation between objects. For example, our own body (the physical side of our selves) appears as a differentiated object which can now be studied. The apperceptive process related to self-consciousness is called the “*I*” (*das ich*), which is the end result of a developmental process, not the beginning as many philosophers maintain

---

<sup>9</sup> See Wundt (1917) or Ehrenstein (2008) for a discussion on Leibniz's general impact.

(Passkönig, 1912, p. 77). This also explains, according to Wundt, why children's self-consciousness is much more emotional—more feeling oriented—than in later life when the increased development of the *will* and logic takes over.

## Wundt: At the Threshold of Ganzheitspsychologie

At heart, Wundt was a holist. Any claim pertaining to Wundt being a structuralist or a person attempting to get at the atoms of the mind highlights the lack of comprehension about what Wundt was really about. Indeed, Wundt (1922) consistently speaks of the unitary whole of which his studied “elements” are merely abstractions for the purposes of studying the whole. Wundt's holistic orientation is nowhere more clearly articulated than through his principle of creative synthesis (*schöpferische Synthese*) which states that out of all his studied elements arises something new, something that is different from its parts (Diriwächter, 2008). Since the final result of the synthesis is clearly something that is different from the elementary sensations found within, it is a creative act (*schöpferische Tätigkeit*), rather than a passive one (Wundt, 1894, p. 112ff). The idea that within creative synthesis is a process of *melting* seemingly unrelated elements attests to Wundt's key interest in the whole. He uses the same concept of *melting* in all his areas of psychology, particularly within the areas of *Völkerpsychologie* where, amongst other things, he tries to examine the developmental progression of human mentality (the true psychogenesis).<sup>10</sup> The notion of *melting* (instead of the mere summation or aggregation) of elements is probably one of Wundt's most fruitful ideas, and as Hans Volkelt (1962a, p. 18) would later mention, “...it is in this idea of *melting* where associationist psychology dies, and *Ganzheitspsychologie* is born...”

The associationist camp of psychology, with their methods of summing up a series of associations that result in an aggregate of elements has never been able to account for the qualitative gap between this summing-up of elements and the novel, creative character of the whole. Wundt was in some ways even a step ahead of what are usually considered the discoverers of holistic approaches, such as the concept of Gestalt-qualities (*Gestaltqualitäten*) by Christian von Ehrenfels<sup>11</sup> (1859–1932). Contrary to von Ehrenfels who saw the sum of our sensations as the foundation for gestaltqualitative holism (*gestaltqualitativen Ganzen*), thus giving them a self-standing reality outside of human experiences, Wundt included them completely into the creative whole which emerged out of them, at least as soon as they created the whole out of themselves. In that way, Wundt incorporated into the resulting whole all the qualities out of which it emerged, whereas von Ehrenfels saw just one aspect of a holistic experience—that of Gestalt qualities (see Volkelt, 1962a, p. 19).

However, Wundt's school at Leipzig never broke through to a truly holistic approach. He was still too much part of the prevailing *Zeitgeist* of his days that took elementary approaches as the only possible starting point for psychological

<sup>10</sup> See especially Wundt (1912a) for an outline of how this may have occurred.

<sup>11</sup> See Kissinger (2008) for a discussion on the life and work of Christian von Ehrenfels.

development. It was his pupils and assistants who would transform the tenet “from the elements to the whole” into “from one whole to the next”. After Wundt retired in 1917, his successor, Felix Krueger (1874–1948), would transform Wundt’s school into what became known as the second school of Leipzig—that of *Genetic Ganzheitspsychologie* (Developmental holistic psychology).<sup>12</sup> The new direction that the Leipzig school of psychology would take should be seen as the logical next step coming out of Wundt’s prior approach: Examining the transformation of wholes. As mentioned, Wundt had long ago acknowledged that psychical elements do not have any independent psychical existence; rather they are merely products of abstraction. Thus, the question was not how isolated elements form a creatively novel whole, but rather how one whole develops into the next, or how underdeveloped (or primitive) synthesis transform into developed ones (Volkelt, 1922).<sup>13</sup> The whole is never created entirely new, rather it merely presents transformed relationships. It is clear that such a view necessitates a developmental perspective (Krueger, 1915).

In that regard, Albert Wellek (1954, p. 67) once said that we must understand Felix Krueger and the Leipzig school of psychology from a developmentally oriented standpoint, otherwise one has not understood anything. I would like to extend this statement to include Wilhelm Wundt himself. If one does not look at Wundt (as he saw things towards the end of his life) from a developmentally focused orientation, one in fact has not understood Wundt’s theory at all. The difference between the developmental focus of the first school of Leipzig and that of the second school of Leipzig is that in the former case Wundt emphasized the genetic priority of the analytically derived elementary processes for mental experiences, whereas in the latter case Krueger highlighted holistic primitive complexes that develop into new *Ganzheiten* (wholes). Yet both orientations were developmental in nature, just Wundt would not abandon the concept of psychic elements, even for his studies on higher—much more developmentally focused—mental processes that fell under the discipline of *Völkerpsychologie*.

In regards to our consciousness from the standpoint of *Völkerpsychologie*, we can say that there is no mental representation, no feeling, no affect, and no *will* without some form of mental content.<sup>14</sup> If we look to Wundt’s dealings with the higher levels of processes (beyond simple sensory perceptions) we can discover that he implicitly took the melting of components into something new as taking place on all levels of mental processing, from the lowest sensory perceptions to the highest levels of complex apperceptions. For example, in his second volume of *Völkerpsychologie*, Wundt (1912b, pp. 436–458) states that not only can we distinguish between outer (i.e., spoken) and inner (i.e., thoughts) language, but that our

---

<sup>12</sup> Due to space limitations, it is impossible to discuss in full details the world-wide impact and general theoretical implications of *Ganzheitspsychologie*. The interested reader is therefore directed to Diriwächter and Valsiner (2008) for a detailed discussion.

<sup>13</sup> See also Diriwächter (2008) for a more detailed discussion on the meaning and implications of Wundt’s notion of synthesis.

<sup>14</sup> Of course, the reverse claim, as stated earlier, can also be made: There is no mental content without mental representation, feeling, affect, and *will*.

meaning-making process must follow similar principles as other psychological events. Wundt distinguished between two main types of thought:

**1. Analytic thought**—Here the total conception, the unified idea completely dominates over the individual fragments (e.g., words) that help express this idea. The synthesis here does not relate to something that was previously sorted, rather to that which was already merged in our conceptions. For example, sentence production can begin with a unified idea that one wishes to express (*die Gesamtvorstellung* or whole mental configuration). The analytic function of apperception prepares us to express this idea by analyzing it into components and structure which retains the relationship between the components and the whole. We can consider the following sentence: “The grass is green.” The basic structure in this sentence consists of a subject and a predicate that can be represented with the following tree-diagram:

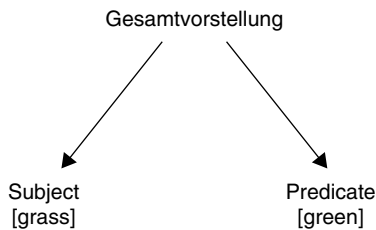

The idea of green grass has now been divided into its two fundamental ideas (grass and green) with the addition of function words (the, is) which are required in a particular language. The entire process can be described as the transformation of an inexpressible, organized whole (thought) into an expressible sequential structure of words that are organized in a sentence.

**2. Synthetic Thought**—Synthetic Thought, on the other hand, has a clearer separation of the components comprised in our conceptions. That is, synthesis on this level is believed to be more differentiated as the components of thought are not yet clearly linked. In principle, it is the reversed tree-diagram illustrated above in that the synthesis occurs through constructing a mental configuration by linking particular components (e.g., words and grammar). This is closer to the *bricolage* approach described by Holstein and Gubrium (2000), but differs in that the meaning construction must still emerge out of a previously given whole (*eine Ganzheit*).

William James (1893) has long ago noted that “the analytic method will discover in due time the elementary parts, if such exist, without danger of precipitate assumption” (p. 151). For James, as for the Ganzheitspsychologists, consciousness is in a consistent state of change. In both Analytic and Synthetic thought, the thoughts are ‘tainted’ by a particular *Gefühlston* (feeling-tone) which predisposes thoughts into a particular direction, but which itself becomes transformed as the *Gesamtvorstellung* continues to develop. Wundt’s three-dimensional theory of feelings<sup>15</sup> (see Diriwächter, 2008) is particularly helpful for articulating the dynamics of the *Gefühlston* as it continues to progress through the process of *Aktualgenese*.

<sup>15</sup> The three dimensions were: ‘pleasantness-unpleasantness’, ‘strain-relaxation’, ‘calm-excitement’.

## Adopting the Methodologies of the Würzburg School

After Wundt's retirement in 1917, the Leipzig school of psychology would see a radical shift in terms of its views on experimental approaches. A decade had passed since the famous Wundt-Bühler controversy during which Wundt had openly criticized and rejected the research methods of the Würzburg school as being merely quasi-experimental. Wundt's (1907, p. 327ff) attack was based on the grounds that none of his requirements for experimental methodology (see above) was being met by the Würzburg followers. In a reply to Wundt's attacks, Karl Bühler (1908b, p. 97ff) drew attention to the impossibility of exact replication of psychical experiences since the nature of consciousness is that it is ever-changing. Or as William James (1893, p. 154) put it, "No state once gone can recur and be identical with what it was before".<sup>16</sup> Thus, simple psychical experiments, such as those that try to determine the experience of sound associations (such as "leather-feather"), are not replicable since (a) the initial exposure contaminates the later one and (b) using similar sounding associations are strictly speaking not the same. Bühler's own critique on Wundt's approach, the division of psychological investigation into one that aims to get at the lower psychical processes (via experimentation) and the higher ones (*Völkerpsychologie*) was certainly one to which Wundt's later successors lend an open ear. According to Bühler, Wundt's assertion to study psychology via two separate domains (experimental introspection and cultural inspection) and then later combine the two, when in fact both are intimately entwined, was doomed to failure. Wundt's (1908) subsequent reply did little to rectify the situation. He reemphasized the need to examine all psychical elementary processes experimentally first and subsequently see how they fit within the totality from which they were abstracted.

While not much of the Leipzig research methodology changed while Wundt was still in charge, the Wundt-Bühler debate had sparked several lively debates within the Leipzig circle itself. Probably the most fruitful debates within the Leipzig circle were between Wundt and his later successor Felix Krueger (see Volkelt, 1934/1962b), during which Krueger called for a developmental approach that is indivisible between higher and lower psychical processes. Krueger's assertion for an investigation of what is actually given during our experiences—the primacy of the whole—set the stage for an incorporation of the Würzburg approach once Krueger took over Wundt's leadership position.

Thus, it can be said that the methodology of the Leipzig *Ganzheitspsychologie* profited from the methodology used at Würzburg (Wellek, 1947, 1954). After Oswald Külpe, a former pupil of Wilhelm Wundt, had left Leipzig to take on a position at Würzburg, the study of higher psychological functions began to take center stage. The core focus for the Würzburg circle was on the process of *realization*—where dynamic psychological processes become real (Diriwächter & Valsiner, 2005). The Külpe-group followed Wundt's primary tenet of voluntarism: "Circumstances do not rule us, but we confront circumstances,—choosing,

---

<sup>16</sup> An idea that has been echoed throughout the ages, as far back as the days of Heraclitus (ca. 540–480 B.C.).



arranging, and directing” (Külpe, 1903, p. 68). Thus, the researchers’ focused their attention on holistic integrative processes of the external and psychological world to gain an understanding of the experience of cognitive processes.

“We ask the general question: What do we experience when we think?” (Bühler, 1907, p. 303). To answer this question, research participants were given a sentence that led to a yes/no answer. This, according to Bühler (p. 304) was the most natural way to get people to think. It is important to note that the yes/no answer was only a means to alleviate the participant needing to formulate his/her immediate response. Unlike Wundt’s experiments, where the yes/no answer was indicative of an immediate experience, for the methodology at Würzburg it presented not data per se, but rather a transition point for the participant to move to immediate reporting of how this answer was achieved. To ensure that the results of the study related to active apperceptive processes (i.e., that the observed events were expected), the participants were told (through the word “*Bitte*”—please) when exactly the procedure was about to start. The initial response time to the posed questions were recorded for the purposes of roughly determining whether the participant remained in a state of tension (attention). Furthermore, the research participants were predominantly trained “thinkers”—professors and doctors of philosophy—to ensure that they were not overwhelmed by the content of the question.

The research participant typically sat at a table with the researcher close by who would (after some initial trial runs) read the relevant questions to the participant and record the time. The participant was asked not to look at the researcher while he was reading the questions (to reduce the impact of facial expressions). The following is an example of the study procedure at Würzburg (Bühler, 1907, pp. 304–305):

- Researcher:** “Can you complete the sentence: The law of association says in its most general form \_\_\_\_?” [“*Können Sie sich den Satz ergänzen: Das Gesetz der Assoziation besagt in seiner allgemeinsten Form \_\_\_\_?*”]
- Participant:** “Yes (5 seconds)—I remembered that lately I have occupied myself much with this, and that I could also formulate it. Also included in my consciousness was that I would have to avoid a lot and would have to give a formula, which has only recently become clear to me (if I would express it figuratively: that I would have to avoid many cliffs, but that I would know how to pass by them). But I did not imagine anything, nor did I engage in mental speech. Then immediately ‘yes’.” [“*Ja (5)*”—*Es kam mir die Erinnerung, dass ich mich in letzter Zeit viel damit beschäftigt habe und dass ich es auch formulieren könnte. Es war in diesem Bewusstsein eingeschlossen, dass ich vieles vermeiden müsste und dass ich eine Formel angeben müsste, die mir erst in letzter Zeit klar geworden (wenn ich es bildlich ausdrücken wollte: dass ich viele Klippen vermeiden müsste, dass ich aber einen Durchgang wüsste). Aber ich habe nichts vorgestellt dabei, auch nichts gesprochen. Dann gleich ‘ja’.*”]

Through this form of guided-introspection (see Chapter 5, this volume), Bühler was able to distinguish different types of thought which, contrary to Wundt’s views, were shown to often be imageless. Here just three examples:

1. *Consciousness of a rule (Das Regelbewusstsein)*—Here Bühler (1907, pp. 334–342) does not mean that participants were thinking about a rule when answering

the questions, but rather that participants were thinking in the form of a rule or through a rule. For Bühler this meant coming to consciousness of a method of solution or how to solve a problem in general.

2. *Consciousness of relations (Das Beziehungsbewusstsein)*—The continuation of consciousness (*Bewusstseinskontinuität*) is based on relations between thoughts. But even more, within a thought itself lays this principle and becomes especially clear during memory trials. As Bühler (p. 343) highlights: “When the only thing a participant can remember to the question *How can the worm in the dust attempt to calculate where the eagle will fly* is: the thought contained an opposition, then we can assume that this consciousness of an opposition was also contained in the first experience as a ‘moment’.”
3. *The “Aha-experience” (Das “Aha-Erlebnis”)*—Bühler (1908a, pp. 12–18) notes that when we encounter rather difficult new thoughts, participants often hesitate a moment and then suddenly, as if by enlightenment, show comprehension. For Bühler his protocols showed with complete clarity that the entry of an Aha-experience was the characteristics of comprehension between two wholes (*zwischen Ganzem und Ganzem*). From this follows that that which needs to be comprehended first needs to become a whole (Bühler, 1908a, p. 17).

What again needs to be reiterated is the focus of the Würzburg studies,<sup>17</sup> namely that of emergence and development of thought processes. The preferred method to “capturing” these thought processes was now turned into a “think aloud” approach. Karl Duncker (1945) would later state that “...the subject who is thinking aloud remains immediately directed to the problem, so to speak allowing his activity to become verbal” (p. 2). It is clear that the participants overt thoughts (i.e., spoken) do not necessarily correspond with the immediate experience of a given phenomena. What it does allow us to see, however, is the restructuring of this original phenomena—a mediated experience.

The originally experienced phenomena genetically precede the specific properties expressed; the latter are developed out of the former. Nevertheless, the process of ‘think aloud’ alone is sufficient to give us insight into the microgenetic processes. The reconstructing of actual experiences is an experience in itself. For Duncker (1945), as well as for the members of the Leipzig school, this process needed to be considered both analytically as well as synthetically.

After Wundt’s departure at Leipzig, the Würzburg methods would gradually become adopted and revised within the Leipzig circle (Wellek, 1947). The approach of the Leipzig circle went beyond the much emphasized thought psychology (*Denkpsychologie*) of the Würzburgers who often underemphasized the importance of emotionality contained in participants’ statements. For *Ganzheitspsychologie*, more attention needs to be paid to the transformations (i.e., development) of processes pertaining particularly to feeling states. Thus, the Würzburg approach would be used to center on the analysis of components and the analysis of conditions in regards to our experiences (Diriwächter, 2008).

<sup>17</sup> The many positive contributions by the Würzburg school on psychology and especially contemporary cognitive science has largely gone underappreciated (see Simon, 1999).

## Early *Aktualgenese* Studies

It is under the context of Wilhelm Wundt, coupled with the impact the Würzburg approach, as well as Felix Krueger's new leadership at Leipzig, that we can understand the emergence of *Aktualgenese* (actual genesis)—and later Microgenetic—research. Trying to further understand what became known as the Gestalt law of *Prägnanz* which emphasizes that “psychological organization will always be as ‘good’ as the prevailing conditions allow” (whereby the term “good” remains undefined—see Koffka, 1935, p. 110), early *Ganzheitspsychologie* research at Leipzig (and elsewhere) focused often on the development of Gestalt percepts. Several studies (see Sander, 1927/1962a) had shown human apperceptive processes were always subject to particular *Gefühlstöne* (feeling-tones), such as the feeling of tension, excitement, and so forth. Furthermore, it lies in the nature of apperceptive processes to proceed in a direction towards optimal clarity and regularity. In what became the first *Aktualgenese* study on visual percepts, performed in what used to be Wundt's laboratories, Erich Wohlfahrt (1925/1932)—a student of Friedrich Sander—examined the mental genesis of visual Gestalts. Through a slide projector, Wohlfahrt projected several figures (such as the one shown in Fig. 15.1 below) to the research participant who saw the figure through an opening in a specially designed tube (*Tubus*). The participant's eyesight was tested and the figure's distance (18.5 cm) and illumination was kept constant, so that all the participant was able to see was a lighted figure on a black background. During 8 trials the figure was successively increased in size (by roughly 25%), so that trial 1 showed a figure that was reduced 40 times in size, whereas in trial 8 the figure was only 8 times reduced from its original size.

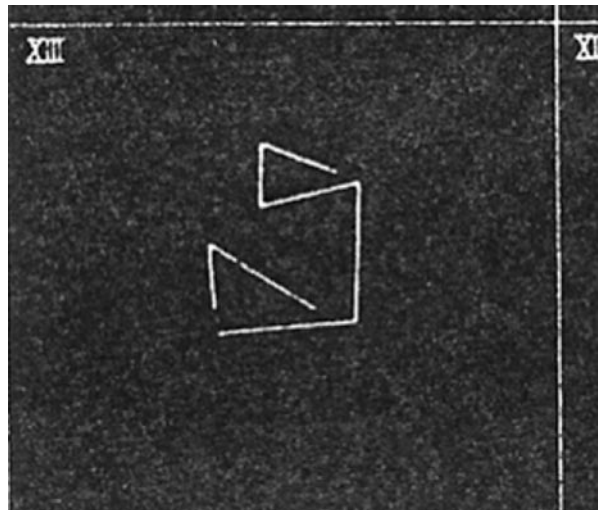
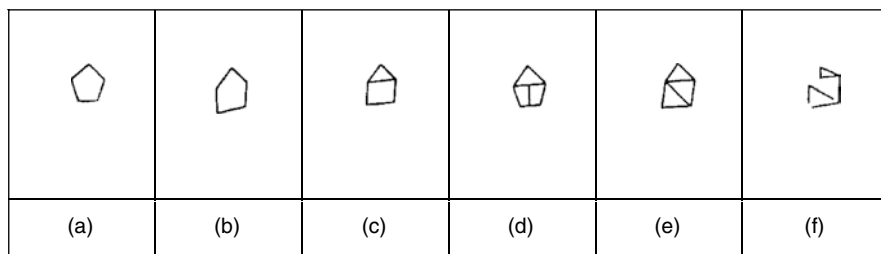

**Fig. 15.1** Figure XIII of Wohlfahrt's (1925/1932) *Aktualgenese* study

Participants<sup>18</sup> were instructed to examine the figure as long as they deemed necessary and to report the characteristics of the figure in all the ways they could, including through drawings as a means of expression. Reporting on each change of the impression during the observation was also requested.

What Wohlfahrt discovered was that during the process of *Aktualgenese*, the participant experiences the emergence of the final Gestalt via successive *Vorgestalten* (pre-*Gestalts*) that are characterized by regularity instead of veridicality. At the smallest visual display participants tended to report a small undifferentiated circular patch which was, however, not homogeneous in nature but rather one “...whose circular contours enclosed an inside characterized by flickering liveliness” (pp. 364–365). The apperceptive processes during the trials were marked by feelings of strain and nearly tormenting compulsion. From one stage to the next, Gestalt after Gestalt emerged from originally simple, regular, and closed pre-*Gestalten* to the final veridical form. Hence, perceptual development follows certain rules. Figure 15.2 displays selected drawings done by one of the participants.

The temporary contours of the pre-*Gestalts* which were characterized by enclosure led Wohlfahrt (p. 370) to refer to these stages as amnions (*Embryonalhüllen*). As can be seen in Fig. 15.2a, out of a diffuse form encapsulated by a circular contour (not displayed here) emerges a simple pentagon-*Gestalt*, characterized by 5 lines of equal length. It is thus more veridical than the previous stage, but nevertheless has not developed to adequacy (since the end-*Gestalt* is neither characterized by regularity, nor by 5 lines—see Fig. 15.1). After the size of the stimulus continues to increase, the regularity of contour starts to give way to increased differentiation of the percept. As the participant, from which the drawings in Fig. 15.2 originate, mentioned (trial-to-trial) “The Basis sinks” (2b), “There is a parallel line” (2c),



**Fig. 15.2** *Aktualgenese* series of the target (see Fig. 15.1) reported by Wohlfahrt (p. 412)

<sup>18</sup> Wohlfahrt (p. 359) provides the family names of his participants, two of them being professors [Friedrich] Sander and [?] Werner. It is unclear to me if the mentioned professor Werner could perhaps be Heinz Werner (see below) who was employed at the University of Hamburg (under the leadership of William Stern) at that time. Yet, if this should turn out to be the case it would provide a very clear and strong link between Werner’s exposure to the Leipzig *Ganzheitspsychologie* approach and his later development of *Aktualgenese* into Microgenesis while he was at Clark University.

“There is also a vertical inner line” (2d), “the inner line is diagonal and if seen independently it appears as if it’s a figure consisting out of triangles, but seen as a whole it appears like (2e)”, “Now everything changed, 3 pieces” (2f)—[“Aha-effect”]. We may note that only at the end (the breaking of the contours) does the resulting apperceptive process coincide with the stimulus, thereby leading to the veridical end-*Gestalt*. Thus, along the entire developmental path was a tendency to regularity, symmetry, and often simplicity, in short, a tendency towards *Gestaltedness*, and this NOT because of the visual stimuli (which had none of those properties).

Sander (1934/1962a, p. 102) would later highlight that the pre-*Gestalts* appear incredibly labile and are filled with inner “life” and movement. They have a tinge (*Tönung*) of non-finality (*Nichtendgültigkeit*) and enclose non-topical qualities. These dynamic qualities and endogenous movements are believed to be due to the tensions between the structural *Gestalt*-tendencies and the demands of the stimulus-constellations. It is only after the end-*Gestalt* that the dominance of the stimulus conditions transforms the lability and instability into a state of relative firmness and calmness. Furthermore, the experienced states during pre-*Gestalts* themselves are especially marked by strong feeling-tones (*Gefühlstöne*), such as tension and excitement, which are *melted* into the entire process (cf. Wundt above). It is only after the *Aha*-effect that the veridical optical image replaces the previous feelings, which then become dull, objective, and cold.

Wohlfahrt’s discovery of the micro-developmental progression during *Aktualgenese* where visual experience proceeds from a lack of differentiation to an increase in regularity, symmetry, straightness, and closedness (the *Gestalt* tendencies) as the stimulus remains weak, has also been found by several subsequent researchers (such as Butzmann, 1940; Dun, 1939; Hausmann, 1935; Mörschner,<sup>19</sup> 1940). It is not possible to discuss further here the implications of these *Aktualgenese* findings in regards to a general theory of visual perception, however, the interested reader is directed to Kleine-Horst’s (2001) “*Empiristic theory of visual Gestalt perception: Hierarchy and interactions of visual functions*” for a full and in-depth discussion.

What remains to be highlighted at this point is that the studies on *Aktualgenese* seem to show psychical development (actual genesis) as mirroring phylo—and ontogenesis (cf. recapitulation theory by G. Stanley Hall, 1923, p. 380). The key characteristic of *Gestalt* development is that it develops out of relatively diffuse and simple forms that are permeated by the qualities of a *Gefühlston* as they are melted into the totality of the experience. As Sander (1934/1962a, p. 103) further points out, these feeling-qualities are not merely accompaniments (*Begleiterscheinungen*) of the process of actualizing a *Gestalt*, but rather are functionally essential for the process of becoming. Without the necessary feeling tendencies of experiencing holistic relationships (from one whole to the next—vom *Ganzem zum Ganzem*) there is even on the higher layers of consciousness no possibility of productive *Gestalt*-formation. The structural, relative robust union of the mind-body totality

<sup>19</sup> In Mörschner’s case a set of consumer goods (e.g., a ruler, a pair of compasses, a protractor, tweezers, etc.) were used instead of meaningless visual patterns.

vis-à-vis the physical requirements of our environment represents the conditional complex for the actuality of experience (as well as for the formation of actions).

The great achievement by the Leipzig circle laid not only in demonstrating the development of initially holistically diffuse forms via a series of more differentiated pre-*Gestalts* until they reach the veridical end-*Gestalt* (a process that usually happens near-instantaneously), but also in the *Aktualgenese* methodology they designed. That is, Ganzheitspsychologists managed to slow down the developmental process so that it could be studied under controlled conditions. The slowing down of the time-continuum via the successive manipulations of the stimulation (be it visual or auditory) allowed the researchers to capture that part of the ‘moment’ which usually tends to go unnoticed. Thus, *Aktualgenese* became a reference to the development in the “here-and-now”; a development that runs parallel to the phylo—and ontogenetic development. A person’s experience transforms from the diffuse to clarity during the process of *Aktualgenese*. As mentioned, the stages of irregularity and unclarity are characterized by feelings of distress and unrestfulness.

The *Reale Ganzheit* (real whole) can be empirically shown by highlighting the experienced totality, the functionality, and structure of the whole (see Diriwächter, 2009, *in press*; for a detailed discussion about structure and hierarchies in *Ganzheitspsychologie*). The *Ideale Ganzheit* (ideal whole) is comprised of a formal (definition based) whole (that can be seen through logical evidence of content) and value orientations (*Wertganzheit*) that have apriority (in the sense of the platonic idea). These ideas follow Krueger’s (1918/1953b) system of the whole (*Systematik der Ganzheit*) and take the unfolding processes empirically full into account.

## Heinz Werner and Microgenesis

The notion of development is one of the few key *Ganzheitspsychologie* characteristics that have been exported to the United States, most notably by Heinz Werner<sup>20</sup> (1890–1964), who in 1933 was forced by the NAZI regime to leave Germany and who would eventually chair the department of psychology at Clark University in 1949 (for a discussion on the “Werner era” at Clark University, see Franklin, 1990). As early as 1919, Werner had made contributions to Genetic *Ganzheitspsychologie* in Felix Krueger’s book series *Arbeiten zur Entwicklungspsychologie* in which he examined the origins and development of metaphors within indigenous tribes.

Starting in 1924, Heinz Werner published a series of articles that investigated structural laws. Two of the publications (Werner, 1925, 1927) focused on musical properties (Micromelody, Microharmony, and the development of Tongestalts) in particular. What Werner found clearly falls under the domain of *Aktualgenese*. Werner (1925, p. 75) wanted to test Franz Brentano (1838–1917) and Carl Stumpf (1848–1936) beliefs that (a) Micro- and macromelody are nonsense and (b) that the experienced process of *melting* (*Verschmelzungserlebnisse*) (which according

---

<sup>20</sup> For a thorough review of Heinz Werner’s life and work see Valsiner (2005).

to Stumpf differentiates simultaneous and successive melodies) is dependent on the number of vibration-relationships (*Schwingungszahlverhältnissen*) as known from the normal tone-system (e.g., is the octave characterized through the ratio 1:2?). What Werner found was that indeed there are micromelodies (or microintervals), but that there are also microharmonies, which under certain circumstances provide the same impression (despite a completely changed physical basis) as the normal intervals of harmonies. Werner stated that it was possible to create within extremely small tone-sequences of just miniscule vibrations a meaningful melody.

Through a modified *Stern-Tonevariator* that produced whistling sounds and allowed for precise measurement of their vibrations, Werner was able to produce sounds with extremely small (5 vibrations) microintervals. When this was repeated a noticeable dilation occurred in which the interval appeared larger and larger. Out of this, Werner (p. 77) was able to demonstrate an important developmental law—that of increasing *Prägnanz*; of increasing differentiation of the perceptual object (in this case, the increasing differentiation of pairs of tones). But moreover, the noticeable dilation continued until it reached the interval of a semitone. What Werner found here was that it was not the tempo of the semitone, but rather the relationship between lead-tone (*Leitton*) and keynote (*Grundton*) that determined the perceived musical difference. This implied that one tone is apperceived as a keynote and the next as a transition, as a lead-tone, to the keynote. This allowed Werner (p. 78) to demonstrate his second developmental law: that the tone-difference gets drawn apart so long until the most simplistic, musically sensible relationship becomes established (an act of differentiation or *Gliederung*). For Werner, becoming conscious of the lead-tone (*Leittonbewusstsein*) had primacy over the consciousness of melodic intervals.

Werner (p. 82) further found a third developmental law which was intimately connected to the previous two: the tendency of increasing constancy (or permanency) of tones and intervals in the perceived melodic system. The tone-qualities emerge within and through the melodic structure, so that this structure represents the sounding relation as the first basis upon which the tone-qualities are built. Thus, the tones are not self-standing independent entities, but rather live within the given structure which, if changed, gives the tones their qualities.

The three above mentioned developmental laws—that of increasing *Prägnanz* and determination, that of increasing differentiation, and that of increasing constancy—could be shown in both microharmony as well as in micromelody (Werner, p. 86). (1) The harmonies develop out of diffuse impression to *prägnant* (terse) tones. (2) Harmonies appear in a very clearly ordered relationship within the microsystem. Just like for melodies, harmony entails the use of focal points (*Stützpunkte*)—such as a base-harmony—from which the observer orients him/herself towards the other sound-relations. (3) The unfolding of this microsystem is characterized by initial lability of the tonal-totality (*Tonganzen*), but transitions over to increasing constancy of perceived tones and intervals in what becomes a structured system.

In short, Werner's findings during auditory *Aktualgenese* are remarkably similar to those of Wohlfahrt for the visual domain, giving further credence to the genetic nature of human psychic experiences in the 'here-and-now' context. However,

Werner's interest in establishing general developmental laws that apply to all developmental levels (including ontogenesis and ethnogenesis) led him to substitute 'Microgenesis' for '*Aktualgenese*' (Catán, 1986). Both terms imply a slowing down of the time continuum through which the researcher can provoke developmentally early (i.e., primitive) totalities out of which then more complex wholes emerge in order to observe the whole developmental course in process. In the case of Microgenesis, the investigation further attempts to draw upon Wundt's *Völkerpsychologie* ideas to relate the unfolding processes to a historic-comparative context (the true psychogenesis).

## The Revival of Microgenetic Traditions—A Narrative Approach

While Werner was not alone in his interest of Microgenesis (his distant colleagues included Vygotsky and Luria—see Catán, 1986), the microgenetic approach found little interest amongst mainstream American psychologists. However, more recently a renewed interest among a circle of researchers has begun to emerge, covering a broad range of topics<sup>21</sup> from a microgenetic perspective (see Abbey & Diriwächter, 2008).

Furthermore, some recent efforts have been made to greatly expand upon earlier *Aktualgenese* findings by taking a descriptive look at the process of synthesis transformations under visual and auditory conditions (instead of just one or the other) in a 'here-and-now' context (Diriwächter, 2005). For example, in one such study participants were asked to look at an image that progressed (trial-by-trial) through a series of stages ranging from blurry (where it was hard to determine the nature of the picture) to optimal clarity (where the picture—e.g., a landscape—could be identified). The aim here was not so much to see the actualizing Gestalt tendencies, but rather to examine the thought processes (via the 'think-aloud' method described earlier) in making sense of the experience. This introspective method was loosely tied to the Würzburg approach. It was found that at the core of psychological synthesis transformation lie continuous apperceptive shifts that initially stand under a general impression (*Gesamteindruck*), but can also gradually leave the objective conditions (e.g., the displayed stimuli). Synthesis transformation proceeded via analytic and synthetically oriented thought processes that remained subject to the persons *Gesamtvorstellung* (whole of mental content, thus also content of past experiences that are utilized in the process). The latter seemed more the case as the trials proceeded to increased differentiations within the visual projection. Thus, several of Wundt's principles (discussed above), coupled with those of *Ganzheitspsychologie*, became very visible during this process.

The following are purely descriptive narrative excerpts taken during the first trial (where a completely blurry picture of a—at that point hard to determine—landscape was displayed; see Fig. 15.3). The excerpts are verbatim and complete in the sense

---

<sup>21</sup> Such topics include visual *Gestalt* perception, the process of meaning making about violence, symbolic self-soothing, daydreaming, and the development of subject-object relations.



**Fig. 15.3** Image of landscape during trial 1 (visual only, original is in color)



that no part has been left out from the beginning of the excerpt to the end. The excerpt is merely divided for the purpose of inserting descriptive comments. The purpose here is to highlight examples of the fundamental components involved during synthesis formation of higher mental processes as expressed by a participant. In short, it examined the microdevelopmental process of meaning-making under the conditions of the study.

At the onset, there is an evaluative result (first impression) of the immediate experience of the perceptual object:

Yes...it's kind of really busy and like, it's hard to, concentrate on it...

The diffuse state is clear, and the participant's first apperceptions center on the difficulties to see any Gestalts in the visual domain. In the strive for clarity, the apperception shifts to that which is recognizable:

...all these different colors are coming out at once...

Note the inherent apperceptive 'push' towards something that is differentiable (colors) within the uncertainty of the image. The diffuse nature of the image reportedly evokes "jittery" feelings (next apperceptive shift) as the participant continues to make sense of the matter:

...I don't know it makes me uncertain, just feel kind of like, *jittery* like, it's *like too much to handle* almost. It's kind of weird

We can here see the first instance of synthesis formation through a series of apperceptions (uncertainty, jittery, 'too much to handle'). The reported feeling-sensations (jittery) are evaluated as being "...too much to handle almost" (then expresses 'unpleasant' dimension). "It's kind of weird" signals an end to the series of apperceptions; a case of synthesis on the level of *Unterganzen* (or sub-wholes).

It should be mentioned here that these *Unterganze*, which are difficult for the participant to articulate, can be seen as *Vorgestalten* (or pre-Gestalts) that crystallize out of the totality of the experience. That is, they emerge *simultaneously* while the participant is considering the other *Gestalts* (*Sukzessivgestalten*) that emerge in the context of the experimental setting. Both Sander (1940/1962b) and Volkelt (1959/1962c) refer to this occurrence as *Simultangestalten* (simultaneous *Gestalts*) and are hypothesized to be a necessity during the process of *Einführung* (feeling-into).

The process of feeling into a situation is a voluntaristic act and in the case where the visual field is marred by uncertainty (i.e., diffuse) the participant is faced with a certain struggle to synthesize the subjective 'push' with the objective 'reality'.

What can be taken from the next part of the narrative shows that the synthesis does not have to proceed in a ‘nice’ orderly or linear fashion (from A to B). Psychological synthesis in consciousness involves a ‘struggle’ to obtain a clear, emerging property:

...I don’t know... Like, I don’t know, like inside like it just feels like, I’m like, almost like *anxious* in a way

In this case, the participant’s uncertainty transforms into something more concrete (anxious—dimension ‘unpleasant’), while still retaining the inherent vagueness of the matter she is reporting on. The clarity comes by means of an apperceptive shift (reported focus on internal feelings) which then allow for an articulation (anxious). This apperception is then looped to the greater whole of the experienced reconstruction in the following segment:

... Because it’s like so busy that, it just feels like all... jittery...

We here can see a ‘repeat’ (a form of ‘recycling’) of what was previously stated, as if to confirm the crystallized aspects (anxious, busy, jittery) from the first few segments of the narrative. Again, note that the ‘loop’ (busy, jittery) to the previous signifies the ‘push’ by the *Gesamtvorstellung* on to the subsequent reconstruction. The analytic process of this synthesis is hard to overlook, even though the participant is not able to clearly articulate her experience (it’s not a linear process).

During subsequent trials<sup>22</sup> participants not only report a more pleasant and calming feelings (as opposed to the strain expressed earlier), but also begin to let their thoughts wander more freely, that is, away from the immediate task. The following narrative excerpts<sup>23</sup> stem from the same participant as shown during trial 1 above:

## ***Trial 2***

Yes...it seems a lot more calm...

From the outset there is a new *Gesamteindruck* (or general impression) that transforms the participant’s analytic process and reported feeling-tone. The physiognomic perception of the image is no longer excited, but now is calm. Furthermore, an apperceptive shift highlights a differentiation within the image’s pattern as compared to the last picture:

...it seems like the, the shades have sort of changed...

The participant makes reference to potential *Vorgestalten* that are currently apperceived as shades. As the microgenetic development continues in the reconstructive

<sup>22</sup> During the subsequent trials an increased differentiation of displayed content—such as a house and mountains—becomes apparent. In other words, the visual image becomes clearer and thus can be more readily apperceived.

<sup>23</sup> There has again not been left out any part of the transcript (for each of the subsequent trials) from the beginning to the end of the displayed excerpts.

process, the participant not only differentiates but now also reports (articulates) the perceived difference:

...it sort of reminds me of like a mountain...

The *Vorgestalten* (or pre-figures) that crystallize in the diffuse image are, via associations to the past (memory) articulated to resemble mountains. The apperceptions continue to shift and through further associative processes [the consciousness of relations, see above] lead to more articulations:

...it just reminds me of nature...

What comes next is again a closure of a loop; a new synthesis can be detected that connects the particular with the *Gesamteindruck*:

...and being very calm... [→ explicit association →] because of the nature...  
Like just sort of, It makes me like sort of calm

The general physiognomic perception of "...it [the picture] seems a lot more calm..." transforms during the reconstruction into "...It makes me like sort of calm..." Thus, the analytic thought process itself becomes, at times, transformed into one that has synthetic components. It is important to highlight once more that the general *Gefühlston* of this segment does not significantly change, rather that it reaches through all segments of the analytic process by the participant. This analytic process, of course, is not limited to the immediate perceptual field of the participant, rather extends into other realms:

...compared to the last one it's a lot more calming...

"Reminds me of like a mountain", "...reminds me of nature...", or "...compared to the last one..." have all been drawn from different domains contained in the participants memory. These apperceptive shifts nicely illustrate the integration of the past (history) in the present by means of association (or in the Würzburg sense, through the consciousness of relations). Yet, reference to the first reported impression (i.e., calm—a feeling state) continues to persist in the details. It is the only clarity the participant (who has not yet psychologically withdrawn from the activity) can maintain.

...it just reminds me of being somewhere,  
where you are like completely calm...

The diffuse nature of the situation leads to diffuse answers (being somewhere), with frequent reference to the only certainty (calmness) apperceived. It provides the umbrella under which the participant constructs clarity:

...Like the nature [association] and there is like no-one around you.  
And it is just sort of like, just very calming to yourself...

It is interesting to note that "...and there is like no-one around you..." constitutes further exploration into 'uncharted territory'. That is, the experience extends and transforms itself into a situation of clarity (you are in nature where nobody is around you). This small feature is actually a giant leap where the synthesis proceeds, via associations, to an entirely different domain; a story so to speak. But just as quick

the dynamics shift back to the present *Gefühlston*, the synthesis has again looped to the initial feeling state reported (calm).

### **Trial 3**

From the very onset, this trial is marked by an excited *Gefühlston* that is evident through the participant's voice (vocalics) in the first part of her narrative.

[Excited tone:] This, *now I really see* the mountain and then *you see* like, *I see* like little houses with like snow on them...

In a split-instant, the tone of voice transforms into excitement [an “*Aha-Erlebnis*”] and the participants verbal expressions are regulated by concreteness (I now really see what I was not sure about before). It is a moment of insight, where the diffuse has become concrete through articulation (I see a mountain, I see little houses with snow...) and further, through associations, becomes synthetically elaborated:

...*It reminds me of* like, the like *the winter and* like *being, like all cozy inside like a cabin...*

Interestingly, as the image has become more concrete, so are the elaborations (Before: It reminds me of being *somewhere*. Now: It reminds me of *winter and being inside a cabin*). The shift to the concrete brings with it, as Sander would have predicted, pleasant feelings:

...it's a nice feeling...

The reported pleasant feeling extends throughout the participants narrative as her analytic thoughts turn synthetic and lead us to her memories and imaginary events (a form of daydreaming—see Pereira & Diriwächter, 2008):

...it just brings a lot of like, *nice memories...* because, it just seems really like *peaceful* and everything like country side... Just like being really cold and like, going inside...

It is precisely in this next part where we can see the present transform into a reconstruction of the past. A creative transformation is in full process by means of associating the former (cold outside—go inside) to the following (I used to have a cabin...):

I used to have a cabin, on like a lake and we used to go there. And it was always really nice and it was *snow* [i.e., cold] and you'd all go like *inside and* like *get warm* and stuff...

We can further break down this process to fully demonstrate the synthetic progression:

1. I used to have a cabin [apperception 1]
2. on like a lake [apperception 2]
3. we used to go there [motion—apperception 3]

The first three steps are all linked through associations (cabin—lake—motion to get there—*consciousness of relations*). Yet we must keep in mind that these three steps are not atomistic, rather comprise what Volkelt (1934/1962b) refers to as “*ein Unterganzes*” (or a subwhole), as they are inevitably embedded in the larger context of the narrative. “I used to go there” makes no sense without the “cabin” and “lake” which are inevitably linked with the participants previous accounts. This becomes particularly clear when we look at parts 4–7 of the transcript excerpt:

4. it was always really nice [evaluation—apperception 4]
5. it was snow [association to “cold”—apperceptive link]
6. and you’d all go like inside [associations to ‘inside’—apperceptive link]
7. and like get warm and stuff [apperceptive synthesis: cold → go inside → warm]

The participant indicates the completion of synthesis transformation by stating:  
 ...it just reminds me of that...

The loop touches anew the *Gesamteindruck* first expressed in the narrative, by linking image (“it”) with particular memory. The situation has become articulated and hierarchically integrated (via memory) and thus the developmental potential for this stage is deemed “completed”. That is, the basis for the next microgenetic development is reached.

Although the picture had not yet reached optimal clarity, it nevertheless sufficed for this participant to report the pleasantness of being able to clearly see that which was diffuse at first. In that sense, the traditional microgenetic process has been completed, although, as we have seen, at this point it is more a *macro-genetic process*.

The excerpts provided above shed some insight into the *voluntary* processes made explicit through the narratives. And at the core of these processes stand *apperceptions*. During the reconstruction of an experienced event, synthesis formation is set by a particular *Gesamteindruck* (the general impression) whereby the *Gefühlston* is clearly carried throughout the process. The components are not unrelated, rather proceed through a series of apperceptions that often overlap, that is, they are often *interwoven* into each other, but crystallize when examined in isolation as done above:

Apperceptions have the potential to shift the developmental trajectory into a different field (which usually still underlies the *Gesamtvorstellung* of the previous) or back to the *Gesamteindruck* of the initial state from which development began to be described (see Fig. 15.4). Thus, we can see that the progression of a sequence of dynamic Gestalts (*Verlaufsgestalten*) operate hierarchically under the principle of simultaneity, since the *Gesamteindruck* is present throughout the process of reconstruction. Thus, synthesis is never created entirely new, rather it represents transformed relationships that are anchored under a particular *Gesamteindruck*, to which they frequently refer back to (loop). There is no ‘new’ without the ‘old’. Each instance where novelty became visible on the narrative level, we see it simultaneously embedded in the layers of the *Gesamteindruck* previously expressed. Hence, we can speak of fluid *Simultangestalten* whereby one (the *Gesamtvorstellung*) incorporates the other (*Unterganzes*).

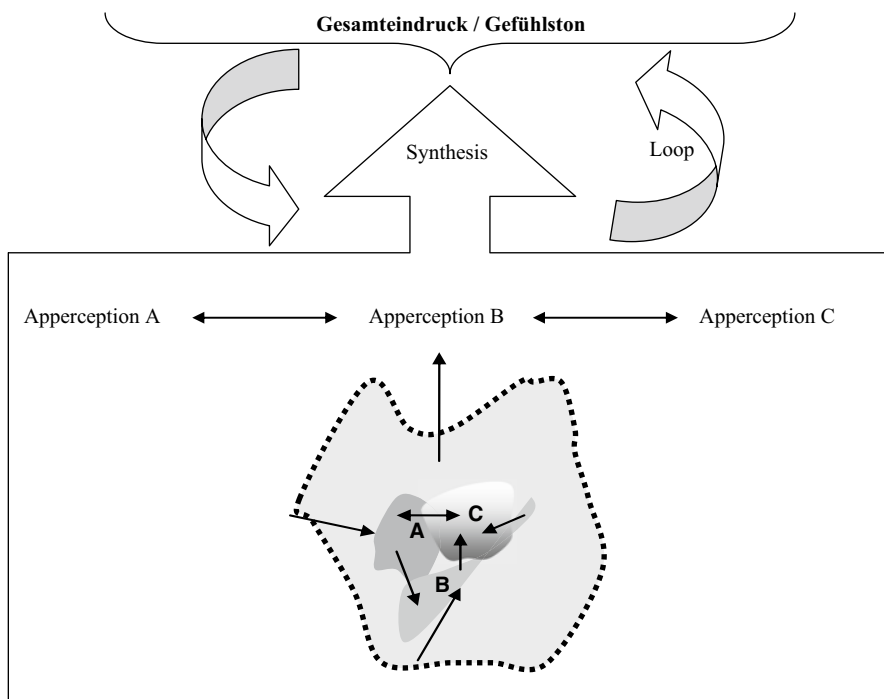

Fig. 15.4 Generic synthesis model

## The ‘Here-and-Now’ Is Not Always “Here” or “Now”

While the flow of time is irreversible (Valsiner, 2000; Diriwächter & Valsiner, 2005), the nature of the experience need not be confined to the present moment. For example, our experience can extend into the past (as well as into the future—teleology). The hypothetical possibilities of *what was* or *what could become* serve to make the present field of experience larger (i.e., by extending its components beyond the present moment in time) and thus allow for multiple microdevelopmental trajectories in the here-and-now context. These trajectories represent the ‘pathway’ along which the synthesis formations become noticeable and are colored by the feeling-tone which the person has expressed. Of course, the developmental trajectories themselves bring possible shifts of feelings expressed as the person feels into (*Einfühlen*) the new (hypothetical) situation that was set up by that person.

That a person’s thoughts during synthesis formation of a microgenetic event need not be confined to the context of the immediately given (e.g., what can be evidently heard or seen in the physical surroundings by the person), but can venture into a hypothetical realm of future directives has been proposed by Volkelt (1959/1962c) some time ago. He saw that the process of *Einführung* into an immediately given

also implies a certain degree of anticipation of future developmental directives so that our feeling into the situation is also guided by our expectation of what the future holds for us. It is important to note that we don't just 'project' our feelings into the event, nor (and that should be clear by now) do we keep our feelings and thoughts differentiated during the future oriented developmental progress. Instead, we place ourselves totally<sup>24</sup> (*Ganzheitlich*) into the anticipated trajectories in order to make them come 'alive'. Without that full integration we end up with nothing but an intellectualized experience that is often far removed from the vividness illustrated in the narratives that emerged out of the situational *Gesamteindruck* of initial experience.

The possibility for future-orientation of the present has also been demonstrated in the microgenetic progression of peoples' daydreams (Pereira & Diriwächter, 2008) and through an analysis of peoples' meaning-making of objects (Abbey & Valsiner, 2004). But naturally, the future directive should not be understood as an absolute of the developmental potential. That is, it does not mean that the future orientation in the present inevitably creates a developmental trajectory the participant then later follows. In a sense, the process of future orientation constitutes a Zone of Proximal Development (ZPD), similar to what Lev Vygotsky already proposed (see Van der Veer & Valsiner, 1991).

Since at any given moment people are faced with the immediate future, it becomes necessarily a part of the present. Hereby the developing person makes use of the psychological functions which are part of the Zone of Actual Development (ZAD), that is, that which has already developed. In our case, we can take this to be the persons dispositions and—in the case of Microgenesis—more importantly, the *Gesamteindruck*.

While the developmental trajectory into the far future will *always* be impossible to project accurately (both for the researcher as well as for the participant), the development of reconstructions through synthesis transformations is based on descriptions and analysis of the progression as it occurs.<sup>25</sup> We do not see into the future, but we see the process that transforms the present moment into the ZPD, which, by the time of our analysis, has turned into the ZAD. The descriptive approach (oriented towards psychological synthesis) analyses how this transformation from present to near future has proceeded in narrative form. After all, narratives provide a good deal of information from which we can see the higher psychological functions at work. In Vygotsky's case, the most distinctive feature for studying developmental synthesis was the semiotic mediation through cultural means.

Apperceptions expressed in narratives, even when synthetically oriented, are based upon some preconceived notion of what is happening in the immediate field (both objectively and subjectively). We use the symbolic meanings of words to translate and objectify our experience. Naturally, that process itself becomes an experience. For our purposes we could say that it *is* the experience if we consider the process extendable to the wider phenomena. While some may see the immediate construction of meaning as the primary reality, we must also realize that the semiotic construction is not singular, rather is comprised of a series of interwoven

<sup>24</sup> "Feeling into" implies attempting to become one—*Einführung ist Einfühlung!*

<sup>25</sup> See also Bamberg (2008) for a microgenetic account of identity formation through narratives.

apperceptions that emerge from the *Ganzheitskomplex* (or holistic complex) and synthesize through the fluidity of the *Gesamteindruck* (which is simultaneously present). *Die Ganzheit* supersedes a simple act of construction, which is merely one emerging aspect from the total structural configuration.

It is thus interesting and important to note that the manner in which synthesis transformations occur is observable not only in basic sensations (as highlighted through Wundt's approach, see above), or on the level of simple idea units, but rather also proceeds on the level of general impressions (*Gesamteindrücke*) out of which units (or *Unterganze*) then unfold. Hence, the multiplicity or hierarchical layers of *Ganzheit* reach systemically down to its lower components (*Unterganze*) so that all layers function simultaneously as a harmonious (or sometimes not so harmonious) whole which transforms ever so slightly (through—as was shown earlier—analytically as well as synthetically oriented apperceptions) during the course of the development (see also Diriwächter, [in press](#)).

The general synthesis model is helpful in so far as it allows us to take note of the vital components during synthesis formation and from there begin to establish their functionality. This should provide the cornerstone from which subsequent research can be undertaken in an attempt to further understand the complex qualities of a *Ganzheit*.

## Gefühlston and Gesamteindruck

It is precisely those complex qualities (*Komplexqualitäten*) involved during psychological synthesis that need to be articulated. The most prominent qualities could lead to the impression that the general synthesis model (see Fig. 15.4) highlights the cognitive processes. In a sense this is correct. However, the cognitive qualities cannot be truly separated from the general feeling dimensions, just as the process of synthesis cannot be fully segregated from the *Gesamteindruck* out of which it emerged. Whether we talk about an immediate *Gefühlston* or one that is mediated, in each case it is an intricate (and large) component of the *Gesamteindruck* out of which particular *Unterganze* emerge. In the case of *Gefühlston*, it's the feeling categories that become evident.

For example, if one introduces an additional component—such as a musical piece (e.g., Pachelbel's Canon)—the nature of the *Gefühlston* (see especially during trial 1 of the study reported above) shifts from a negatively to a positively tainted one (see Fig. 15.5).

Similarly, given a constant visual image (e.g., a woman standing with a rather expressionless face), but with different musical pieces during separate trials, where one musical piece is characterized by fast tempo and rather high-pitch (Bach's Brandenburg Concerto No. 3—Allegro = Trial 5) to music with slower tempo and lower pitch (A Nightmare on Elm Street Soundtrack: Sleep Clinic = Trial 6), the corresponding rating of the image (see Fig. 15.6) shifts from pleasant to unpleasant (feelings that the musical pieces naturally attempt to evoke).



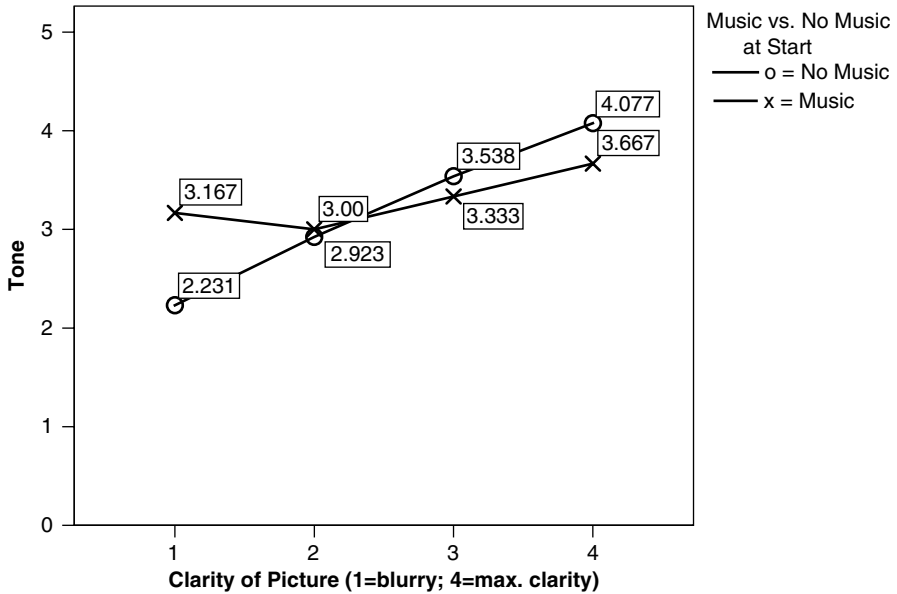

Fig. 15.5 Feeling tone (pos/neg) in participants narratives

It is evident that the illustrated directionality of feeling-tone is not all-inclusive nor does it actively show the transformational processes during synthesis formations. Instead it provides a general overview of the core dimensions of feeling states by participants through a series of trials.

From the very onset, philosophers and consequently psychologists have realized the importance of music to our emotional lives (see Bowman, 1998; Juslin & Sloboda, 2001). Unlike Meyer’s (1956) notion that certain emotions occur when listening to music as a result of what we are *expecting* to hear (e.g., tonality), the *Ganzheitspsychologie* doctrine takes the position that emotions and feelings are continuously

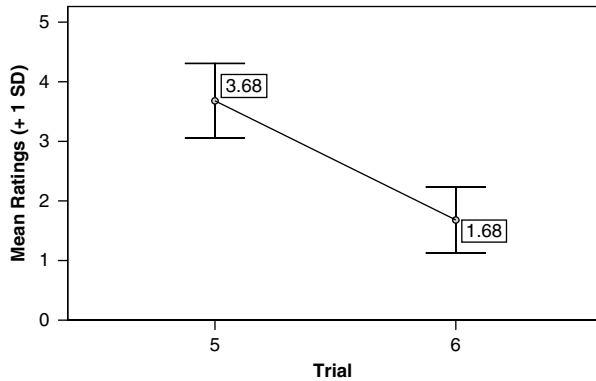
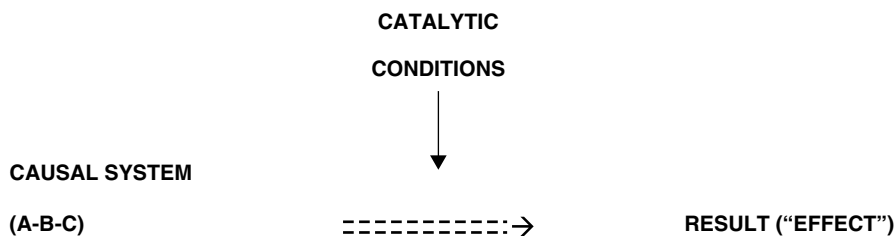

Fig. 15.6 Mean ratings for participants feeling-tones

present and that music helps *guide* these feelings into different configurations (i.e., different feeling states) as part of the complex qualities (see Krueger, 1910, 1915, 1926/1953a; Wellek, 1963). This is not to say that expectations do not play a role in how we feel music. Every melody takes on certain Gestalt configurations that can also be seen as manifestation of the musician's expressed feeling state and the listener can relive these feeling states through *Einfühlung* (empathetically feeling into the sound). Tapping into the melody is becoming *one* (again: *Einfühlung ist E<sub>in</sub>s<sub>in</sub>fühlung*) with the feelings of the creator of the music (Wellek, 1963, p. 207). Music is not treated here as a static variable that "causes" certain emotions or feelings (A causes B), rather music is seen as an aesthetic medium into which a person can tap by focusing on the successive *Gestalts* (*Sukzessivgestalt* or *Zeitgestalt*) that together transform into the experienced totality. The listener needs to actively take part in the music experience through which certain semiotic mediations contribute to the feeling states.

However, although the processes of the various levels are experienced via semiotic mediations, the experienced totality/whole (*das Wahrnehmungsganze*) of any level is immediate in its uniqueness. Krueger (1910) has long ago noted that the characteristics of the whole, which differentiates it from other perceptual-complexes (*Wahrnehmungskomplexe*) is not bound on having the person perceive the lower layers as separately given components (examining and judging them) as such a dissection would inevitably destroy the uniqueness of the whole.

It has been shown (e.g., Wellek, 1963; Sloboda, 1999) that certain properties in music (such as rhythm, tempo, and melody) can correspond to certain characteristics of our feeling states. Since we are inextricably a part of our environment (in essence, humans cannot be separated from their environment) it could be argued that certain properties of music can be transmitted to our feeling states. Whereby it needs to be reiterated that no such transmission occurs if the listener is not actively taking part in the process. If we attempt to speak of causality (e.g., the music has "caused" me to feel a certain way), then this must be done in the framework of systemic catalyzed causality (see Valsiner, 2000, pp. 74–76). This model of causality emphasizes that there needs to be certain conditions that are present for a particular causal linkage to occur:



In line with the earlier discussion about the issue of causality, the inference that music caused the entire resulting experience is flawed already because there are two forms of experiential conditions (physical and psychological). Thus, the direct causal inference can only be made in terms of the (musical) sound waves that are funneled

through the outer ear to the eardrum where the bones of the middle ear amplify and relay the eardrum's vibrations into the fluid-filled cochlea which in turn causes the basilar membrane to ripple and thereby bend the hair cells on the surface, which eventually transmit that information via the auditory nerve to the thalamus and on to the auditory cortex. The actual experience of the event, however, is both the physical and psychical together as one. Thus, to account for the entirety of the experience (physical and psychical—two qualitatively different aspects), the direct causal inference is limited to the physical side and thus presents only one particular aspect of the analysis of the given conditions.

## Some Final Thoughts

I hope to have shown that the microgenetic tradition has helped to shed much light in the process of psychological experiences, and still provides much fuel for further investigations pertaining to 'here-and-now' contexts. Wundt's work had provided the cornerstone for psychological investigations upon which his successors would later expand. It was through the flexibility of Wundt's successors that other methodologies (e.g., those stemming from Würzburg) could be incorporated to allow for a wider range of psychological studies. It was not the place here to discuss in detail the theoretical credo of *Ganzheitspsychologie*. However, such a discussion is provided by Diriwächter and Valsiner (2008), with a more detailed elaboration on the importance of structure and hierarchies for *Ganzheitspsychologie* by Diriwächter (in press), and on the nature of specific cases involving affect by Diriwächter (2009).

The microgenetic tradition still holds a wealth of potential to further research on the nature of psychological synthesis transformations as well as a number of other areas relevant to cultural and developmentally oriented sciences (Abbey & Diriwächter, 2008). Furthermore, some fairly recent work attempted to apply microgenetic methodology to the field of brain processes (Brown, 2002). Such efforts are vital in helping us establish the necessary details required for a unification of psychical with physical domains. One could assert that the recent advances in the field of neurology ultimately hold the key to providing us with a more complete picture of human mental processing. In that regard, the efforts are certainly underway. For example, in 2007 a small debate ensued on the nature of how our minds wander, and whether the activity in our cortical regions during resting periods pertains to stimulus-independent thought or to stimulus-oriented thought (in the order of publication appearance: see Mason et al., 2007a,b; Gilbert, Dumontheil, Simons, Frith, & Burgess, 2007). While, largely due to methodological problems, the issue of what kind of thought dominates during unconstrained cognitive periods remains unresolved, the debate nevertheless highlights the potentials that the field of neurology has in helping us understand microgenetic development.

The time has come to find additional methods to the convenient standardized questionnaires. It is now left to the research community to take this opportunity provided through the revisiting of 'forgotten' approaches in order to study humans

not from a static (i.e., non-developmentally focused) point of view, but rather from a view that more closely approximates the real nature of life—that of a never-ending unfolding process of *becoming*.

## References

- Abbey, E., & Diriwächter, R. (Eds.). (2008). *Innovating genesis: Microgenesis and the constructive mind in action*. Charlotte, NC: Information Age Publishing.
- Abbey, E., & Valsiner J. (2004, December). Emergence of meanings through ambivalence [58 paragraphs]. *Forum Qualitative Sozialforschung/Forum: Qualitative Social Research* [On-line Journal], 6(1), Art. 23. Available at: <http://www.qualitative-research.net/fqs-texte/1-05/05-1-23-e.htm> [Accessed 18 April, 2005].
- Bamberg, M. (2008). Selves and identities in the making: The study of microgenetic processes in interactive practices. In U. Müller, J. I. M. Carpendale, N. Budwig, & B. Sokol (Eds.), *Social life and social knowledge: Toward a process account of development* (pp. 205–224). New York: Lawrence Erlbaum Associates.
- Bem, S. L. (1979). Theory and measurement of androgyny: A reply to the Pedhazur-Tetenbaum and Locksley-Colten Critiques. *Journal of Personality and Social Psychology*, 37(6), 1047–1054.
- Block, J. (1995). A contrarian view of the five-factor approach to personality description. *Psychological Bulletin*, 117, 187–215.
- Boring, E. G. (1950). *A history of experimental psychology* (2nd ed.). New York: Appleton-Century-Crofts.
- Bowman, W. D. (1998). *Philosophical perspectives on music*. New York: Oxford University Press.
- Brown, J. W. (2002). *Self-embodying mind: Process, brain dynamics and the conscious present*. Barrytown, NY: Station Hill Press.
- Bühler, K. (1907). Tatsachen und Probleme zu einer Psychologie der Denkvorgänge: Über Gedanken. *Archiv für die gesamte Psychologie*, 9, 297–365.
- Bühler, K. (1908a). Tatsachen und Probleme zu einer Psychologie der Denkvorgänge: Über Gedankenzusammenhänge. *Archiv für die gesamte Psychologie*, 12, 1–92.
- Bühler, K. (1908b). Antwort auf die von W. Wundt erhobenen Einwände gegen die Methode der Selbstbeobachtung an experimentell erzeugten Erlebnissen. *Archiv für die gesamte Psychologie*, 12, 93–122.
- Butzmann, K. (1940). Aktualgenese im indirekten Sehen. *Archiv für die gesamte Psychologie*, 106, 137–193.
- Catán, L. (1986). The dynamic display of process: Historical development and contemporary uses of the microgenetic method. *Human Development*, 29, 252–263.
- Danziger, K. (1980). The history of introspection reconsidered. *Journal of the Behavioral Sciences*, 16, 241–262.
- Diriwächter, R. (2004). Völkerpsychologie: The synthesis that never was. *Culture & Psychology*, 10(1), 85–109.
- Diriwächter, R. (2005). Ganzheit & feelings: An investigation into the process of psychological synthesis. *Dissertation Abstracts International*, 66(10) (UMI No. 3189853).
- Diriwächter, R. (2006). The wandering soul in relation to time. *Culture & Psychology*, 12(2), 161–167.
- Diriwächter, R. (2008). Genetic Ganzheitspsychologie. In R. Diriwächter & J. Valsiner (Eds.), *Striving for the whole: Creating theoretical syntheses* (pp. 21–45). Somerset, NJ: Transaction Publishers.
- Diriwächter, R. (in press). Structure and hierarchies in Ganzheitspsychologie. In J. Valsiner & L. Rudolph (Eds.), *Mathematical models for research on cultural dynamics: Qualitative mathematics for the social sciences*. Book 1 in the Book Series: Cultural Dynamics of Social Representation (in press).

- Diriwächter, R. (2009). Heimweh or Homesickness: A nostalgic look at the Umwelt that no longer is. In R. Sokol -Chang (Ed.), *Relating to environments: A new look at Umwelt* (pp. 163–184). Charlotte, NC: Information Age Publishers.
- Diriwächter, R., & Valsiner, J. (2005, December). Qualitative developmental research methods in their historical and epistemological contexts [53 paragraphs]. *Forum Qualitative Sozialforschung/Forum: Qualitative Social Research* [On-line Journal], 7(1), Art. 8. Available at <http://www.qualitative-research.net/fqs-texte/1-06/06-1-8-e.htm> [Accessed 30 Dec 2005].
- Diriwächter, R., & Valsiner, J. (Eds.). (2008). *Striving for the whole: Creating theoretical syntheses*. Somerset, NJ: Transaction Publishers.
- Diriwächter, R., Valsiner, J., & Sauck, C. (2004, November). Microgenesis in making sense of oneself: Constructive recycling of personality inventory items [49 paragraphs]. *Forum Qualitative Sozialforschung/Forum Qualitative Social Research* [On-line Journal], 6(1), Art. 11. Available at: <http://www.qualitative-research.net/fqs-texte/1-05/05-1-11-e.htm> [Accessed 1 Dec 2004].
- Dun, F. T. (1939). Aktualgenetische Untersuchungen des Auffassungsvorgangs chinesischer Schriftzeichen. *Archiv für die gesamte Psychologie*, 104, 131–174.
- Duncker, K. (1945). *On problem-solving*. (L. S. Lees, Trans.). Washington, DC: The American Psychological Association, INC.
- Ehrenstein, W. H. (2008). Leibniz's dynamic holism. In R. Diriwächter & J. Valsiner (Eds.), *Striving for the whole: Creating theoretical syntheses* (pp. 1–11). New Brunswick, NJ: Transaction Publishers.
- Franklin, M. B. (1990). Reshaping psychology at Clark: The Werner era. *Journal of the History of the Behavioral Sciences*, 26, 176–189.
- Gatz, M., & Good, P. R. (1978). An analysis of the effects of the forced-choice format of Rotter's internal-external scale. *Journal of Clinical Psychology*, 34(2), 381–385.
- Gilbert, S. J., Dumontheil, I., Simons, J. S., Frith, C. D., & Burgess, P. (2007). Comment on “wandering minds: The default network and stimulus-independent thought”. *Science*, 317, 43b.
- Hall, G. S. (1923). *Life and confessions of a psychologist*. New York: Appleton.
- Hausmann, G. (1935). Zur Aktualgenese räumlicher Gestalten. *Archiv für die gesamte Psychologie*, 93, 289–334.
- Holstein, J. A., & Gubrium, J. F. (2000). *The self we live by: Narrative identity in a postmodern world*. New York, NY: Oxford University Press.
- James, W. (1893). *Psychology*. New York, NY: Henry Holt and Company.
- Julian, P. N., & Sloboda, J. A. (Eds.). (2001). *Music and emotion: Theory and research*. New York, NY: Oxford University Press.
- Kissinger, S. (2008). Christian von Ehrenfels. In R. Diriwächter & J. Valsiner (Eds.), *Striving for the whole: Creating theoretical syntheses* (pp. 13–20). New Brunswick, NJ: Transaction Publishers.
- Kleine-Horst, L. (2001). Empiristic theory of visual gestalt perception. Hierarchy and interactions of visual functions. Köln, Germany: Enane. (Partially available at <http://www.enane.de/content.htm> [Accessed 29 Feb 2008]).
- Koffka, K. (1935) *Principles of gestalt psychology*. New York: Harcourt, Brace and Company.
- Krueger, F. (1910). Mitbewegungen beim Singen, Sprechen und Hören. *Zeitschrift der Internationalen Musikgesellschaft*, 7, 180–186, 205–215.
- Krueger, F. (1915). Über Entwicklungspsychologie: Ihre sachliche und geschichtliche Notwendigkeit. *Arbeiten zur Entwicklungspsychologie, 1. Band—Heft 1*. Leipzig, Germany: Verlag von Wilhelm Engelmann.
- Krueger, F. (1953a). Über Psychische Ganzheit. In E. Heuss (Ed.), *Zur Philosophie und Psychologie der Ganzheit: Schriften aus den Jahren 1918–1940* (pp. 33–124). Berlin, Germany: Springer Verlag. (Reprinted from *Neue Psychologische Studien*, 1(1), 1926).
- Krueger, F. (1953b). Die Tiefendimension und die Gegensätzlichkeit des Gefühlslebens. In E. Heuss (Ed.), *Zur Philosophie und Psychologie der Ganzheit: Schriften aus den Jahren 1918–1940* (pp. 177–194). Berlin, Germany: Springer Verlag. (Reprinted from *Festschrift zu Johannes Volkelt's 70. Geburtstag*, pp. 265–286, 1918, München, Germany: Beck).
- Külpe, O. (1903). The problem of attention. *The Monist*, 13, 38–68.

- Mason, M. F., Norton, M. I., Van Horn, J. D., Wegner, D. M., Grafton, S. T., & Macrae, C. N. (2007a). Wandering minds: The default network and stimulus-independent thought. *Science*, *315*, 393–395.
- Mason, M. F., Norton, M. I., Van Horn, J., Wegner, D. M., Grafton, S. T., & Macrae, C. N. (2007b). Response to comment on “wandering minds: The default network and stimulus-independent thought”. *Science*, *317*, 43c.
- Meyer, L. B. (1956). *Emotion and meaning in music*. Chicago, IL: The University of Chicago Press.
- Mörschner, W. (1940). Zur Aktualgenese des Gegenstandserlebens. *Archiv für die gesamte Psychologie*, *104*, 125–149.
- Passköning, O. (1912). *Die Psychologie Wilhelm Wundts: Zusammenfassende Darstellung der Individual-, Tier—und Völkerpsychologie*. Leipzig, Germany: Verlag von Siegmund & Volkening.
- Pedhazur, E. J., & Tetenbaum, T. J. (1979). Bem sex role inventory: A theoretical and methodological critique. *Journal of Personality and Social Psychology*, *37*, 996–1016.
- Pereira, S., & Diriwächter, R. (2008). Morpheus awakened: Microgenesis in daydreams. In E. Abbey & R. Diriwächter (Eds.), *Innovating genesis: Microgenesis and the constructive mind in action* (pp. 157–183). Charlotte, NC: Information Age Publishing.
- Rieber, R. W., & Robinson, D. K. (2001). *Wilhelm Wundt in history: The making of a scientific psychology*. New York: Kluwer Academic/Plenum.
- Rotter, J. B. (1966). Generalized expectancies for internal versus external control of reinforcement. *Psychological Monographs: General and Applied*, *80*(1), 1–28.
- Sander, F. (1962a). Experimentelle Ergebnisse der Gestaltpsychologie. In F. Sander & H. Volkelt (Eds.), *Ganzheitspsychologie* (pp. 73–112). München, Germany: C.H. Beck’sche Verlagsbuchhandlung. (Originally presented in 1927 at the 10. Kongress der Deutschen Gesellschaft für Psychologie in Bonn).
- Sander, F. (1962b). Gestaltwerden und Gestaltzerfall. In F. Sander & H. Volkelt (Eds.), *Ganzheitspsychologie* (pp. 113–117). München, Germany: C.H. Beck’sche Verlagsbuchhandlung. (Originally presented in Athens, 1940).
- Simon, H. (1999). Karl Duncker and cognitive science. *From Past to Future*, *1*(2), 1–11.
- Sloboda, J. (1999). Music—Where cognition and emotion meet. *The Psychologist*, *12*(9), 450–455.
- Valsiner, J. (2000). *Culture and human development*. London: Sage Publications.
- Valsiner, J. (Ed.). (2005). *Heinz Werner and developmental science*. New York, NY: Kluwer Academic/Plenum Publishers.
- Valsiner, J., Diriwächter, R., & Sauck, Ch. (2004). Diversity in unity: Standard questions and non-standard interpretations. In R. Bibace, J. Laird, K. Noller, & J. Valsiner (Eds.), *Science and medicine in dialogue* (pp. 385–406). Stamford, CT: Greenwood.
- Van der Veer, R., & Valsiner, J. (1991). *Understanding Vygotsky*. Oxford: Basil Blackwell.
- Volkelt, H. (1922). Die Völkerpsychologie in Wundts Entwicklungsgang. In A. Hoffmann (Ed.), *Wilhelm Wundt—Eine Würdigung* (pp. 74–105). Erfurt, Germany: Verlag der Keyserischen Buchhandlung.
- Volkelt, H. (1962a). Wilhelm Wundt auf der Schwelle zur Ganzheitspsychologie. In F. Sander & H. Volkelt (Eds.), *Ganzheitspsychologie*, (pp. 15–30). München, Germany: C.H. Beck’sche Verlagsbuchhandlung.
- Volkelt, H. (1962b). Grundbegriffe der Ganzheitspsychologie. In F. Sander & H. Volkelt (Eds.), *Ganzheitspsychologie* (pp. 31–65). München, Germany: C.H. Beck’sche Verlagsbuchhandlung. (Reprinted from Neue Psychologische Studien, *12*, 1934).
- Volkelt, H. (1962c). Simultangestalten, Verlaufsgestalten, und „Einfühlung“. In F. Sander & H. Volkelt (Eds.), *Ganzheitspsychologie* (pp. 147–158). München, Germany: C.H. Beck’sche Verlagsbuchhandlung. (Originally presented in 1959 for the Festschrift für Friedrich Sander in Göttingen).
- Wellek, A. (1947). Das experiment in der psychologie. *Studium Generale*, *1*, 18–32.

- Wellek, A. (1954). Die Genetische Ganzheitspsychologie der Leipziger Schule und ihre Verzweigungen. *Neue Psychologische Studien*, 15(3), 1–67.
- Wellek, A. (1963). *Musikpsychologie und Musikästhetik: Grundriss der systematischen Musikwissenschaft*. Frankfurt am Main, Germany: Akademische Verlagsgesellschaft.
- Werner, H. (1919). Die Ursprünge der Metapher. *Arbeiten zur Entwicklungspsychologie*, 3.
- Werner, H. (1925). Studien über Strukturgesetze IV: Über Mikromelodik und Mikroharmonik. *Zeitschrift für Psychologie*, 98, 74–89.
- Werner, H. (1927). Studien über Strukturgesetze V: Über die Ausprägung von Tongestalten. *Zeitschrift für Psychologie*, 101, 159–181.
- Werner, H. (1956). Microgenesis and Aphasia. *Journal of Abnormal Social Psychology*, 52, 347–353.
- Wohlfahrt, E. (1932). Der Auffassungsvorgang an kleinen Gestalten. Ein Beitrag zur Psychologie des Vorgestalterlebnisses. *Neue Psychologische Studien*, 4, 347–414. [Dissertation, Leipzig, 1925].
- Wundt, W. (1894). Ueber psychische Causalität und das Princip des psychophysischen Parallelismus. *Philosophische Studien*, 10(1), 1–125.
- Wundt, W. (1907). Über Ausfrageexperimente und über Methoden zur Psychologie des Denkens. *Psychologische Studien*, 3, 301–360.
- Wundt, W. (1908). Kritische Nachlese zur Ausfragemethode. *Archiv für die gesamte Psychologie*, 11, 445–459.
- Wundt, W. (1912a). *Elemente der Völkerpsychologie—Grundlinien einer psychologischen Entwicklungsgeschichte der Menschheit*. Leipzig, Germany: Alfred Kröner Verlag.
- Wundt, W. (1912b). *Völkerpsychologie: Eine Untersuchung der Entwicklungsgesetze von Sprache, Mythos und Sitte—Zweiter Band: Die Sprache* (3rd ed.). Leipzig, Germany: Verlag von Wilhelm Engelmann.
- Wundt, W. (1917). *Leibniz*. Leipzig, Germany: Alfred Kröner Verlag.

# Chapter 16

## Dynamic Methods for Research in Education

Alexander Wettstein and Beat Thommen

Education is concerned with initiating and attending to developmental processes, a highly dynamic subject matter. Therefore, research in education faces great challenges. The *methods* used in education research, however, frequently fail to take into consideration fully the very dimension of process and development. In many cases, the methods follow a research ideal informed by the natural sciences; often they are borrowed or derived from sciences such as astronomy, agricultural research, or classical physics (see Porter, 1986). There are great discrepancies between theoretical positions, the intrinsic dynamics of the examined phenomena, and the methods used which, in the main, support a static approach.

*Methodology* refers to the interrelationship which exist between theory, method, data and phenomena. In education research, however, not enough critical attention is given to this interrelationship and the specific methodological problems generated by its dynamic subject matter. The stereotypical application of the same unquestioned methods, time and again applied to investigate very diverse issues, limits much research activity. If the aim of education research is to do justice to education's dynamic subject matter—the processes of transformation and change which go on irreversibly in time—these very processes need to be reflected in research approach and method design (see Valsiner, 1994, p. 29). The aim of this chapter is to discuss the interrelationships of education phenomena, theoretical positions and methodological approaches in scientific education research.

### The Methodology Cycle

In science, theories are formulated on the basis of what initially are mostly unsystematic observations which are critically examined through the application of research methods. Theories and methods are grounded in certain fundamental

---

A. Wettstein (✉)  
Department of Special Education  
Bern University of Applied Sciences  
Bern, Switzerland  
e-mail: alexander.wettstein@phbern.ch



assumptions about the object under investigation and its context; they are often preconceptions or inexplicit and unexplained presuppositions. Branco and Valsiner (1997) discussed these relationships between the theoretical and empirical parts of the research process as a *methodology cycle*. Methodology is defined as concerned with the extensive interrelations and interdependencies of research object, theoretical assumptions, and empirical procedures involved in the research process and in contrast to *methods* (including the analysis of methods) which refers to the more narrowly defined issues of empirical data collection and processing, and problems that may arise therein.

Many controversies in psychology and the social sciences about paradigms and research strategies have arisen because of concerns about methods rather than theories. Theoretical positions were assessed and judged not by debating their fundamental assumptions and presuppositions about the objects of investigations but whether they are compatible with the application of certain standard methods that are generally accepted to be valid. The result is “empirical hyperproductivity” (Valsiner, 2005, p. 7) matched by only modest progress in theory development. What is more, certain approaches and standards of method have become independently valid and dissociated from the theoretical and methodological contexts in which they originated so that the assumptions about research objects they implicitly entail are no longer critically taken into account or problematized in the research process. As Fassnacht (1995, p. 291) remarks:

Modern scientific psychology is conceived first and foremost as the management of what is in principle already possible. The scholarly and competent employment of techniques, methods and knowledge for the purpose of answering specific questions: to understand what in principle has already been resolved, except that in relation to a specific, concrete question, the result is not yet known.

In the next section we outline the most important *fundamental assumptions* about education and discuss them with regard to their implications for methods.

## **Basic Assumptions About Education and Implications for Methods**

*Education* can be defined as the intentional intervention into the development of persons who are growing up and includes changes in knowledge, ability and will (Krapp, Prenzel, & Weidenmann, 2006, p. 21). While *learning* refers rather to short-term changes, education is aimed at the long-term developmental processes of those being educated. The concept of socialization overlaps significantly with the concept of education. In socialization research the central question is how individuals grow up to become socially capable subjects and well adjusted members of social communities. While education research is focused on individual and interactive processes, socialization research is more concerned with social conditions and structures and examines their influence on those growing up.

Educators and the people they educate have a relationship, and one in which they are not symmetrically positioned. Educators strive to achieve positively valued change.

The determination of which educational goals are desirable is on the whole oriented toward the *normative ideas* of a particular culture, but education can easily find itself in a situation of conflicting aims. At the same time as education should accomplish the transmission of cultural achievements to children, they should also be formed into human beings who are capable of acting autonomously. Adaptation and autonomy stand in a relationship of tension, if not conflict. As Mitscherlich (1996, p. 27) points out:

Education must fulfill an intrinsically dialectical function: education must provide for those being educated to practice the ways of society and simultaneously provide immunization against society whenever it tries to enforce the performance of stereotyped thought and action instead of critical reason.

While education aiming at adaptation and adjustment involves the strong, unilateral influence of adults onto children, education aiming at autonomy involves rather more indeterminate and open ideas about human development. Education may channel thinking, feeling and acting, but it also opens up *new horizons of the possible*. For example, the acquisition of cultural technologies such as reading and writing enable a child to absorb and pass on a multitude and variety of information as the child gradually develops from the instructed use of these technologies to using them autonomously.

Education also faces a paradox with regard to past, present and future. Education is supposed to prepare for the future, but the future is always uncertain and only partially familiar. Hence, Piaget calls for an open future orientation in education:

The principle goal of education in the schools should be creating men and women who are capable of doing new things, not simply repeating what other generations have done; men and women who are creative, inventive, and discoverers, who can be critical and verify, and not accept, everything they are offered. (Piaget, 1988, Unpublished Paper)

From such programmatic position, education is not just about the transmission of a body of knowledge and of culturally based routines, but just as much about the transmission of flexible, general and generative problem solving strategies that are transferable into the future.

Although there is an asymmetric relationship between educators and those being educated, what goes on between them, education itself, is a reciprocal process and needs to be understood as such. Influence is not only exerted by educators onto those being educated, but the influence the latter have on their educators should not be underestimated. In the parental relationship, for example, babies change their parents' behavior as well as the social dynamic between them to a large extent. Parents constantly adjust their behavior to their children's new developmental stages and challenges. In general terms, the relationship between educators and those being educated is marked by a variety of *reciprocal interactions and mutual effects*.

## Education as an Open Developmental Process

Education can be defined as processes of directed change which occur in time. Therefore, the concept of transformation is central for education, as it is for all developmental processes—over a period of time, X changes to Y. A project of dynamic

pedagogy, oriented towards development, needs to deal with these transformations: How does something new come about? What general regulating principles are at work? What general regulating principles govern transformations and change? What course do transformations in open systems take on time's irreversible arrow?

To what extent is it possible to predict developmental processes deterministically? Human beings are living, information processing, open systems. In contrast to non-living systems, they are in charge of their self-dynamic and have some autonomy which allows them to retain a degree of constancy in an ever changing environment. Von Foerster (1988) coined the term "non-trivial machine" for these kinds of systems. Changes in trivial (non-living) machines can be explained by the laws of cause and effect, but because of their self-dynamic, the behavior of non-trivial systems cannot be predicted deterministically. Even when educational processes produce the same or similar results, the actual developmental processes that take place with subjects (those being educated) and lead to these results may often be quite different. This equifinality is a defining feature of education. Sato et al. (2007) developed a model that allows for the representation of equifinality.

In this sense, education is a non-deterministic, open process. Concepts of circular systemic causality have been developed in dynamic systems theory which seem to be more suitable for the description of indeterminate developmental processes than simple, linear models of causality (see Valsiner, 1997, p. 38f). But the classic research designs of experiment and control group are also frequently used in education research and mostly involve simple causal models; for instance, when specific conditional factors are being isolated in order to come to a causal explanation for changes of particular characteristics that occur in students. One example (Helmke, 2003) of this kind of reasoning is the research question: Which characteristic features in teachers lead to a high level of performance in school children? Such an approach can expand in scope and address more complexity by using a multi-factorial or multi-level analysis, but the basic model of thought driving the approach remains the same, i.e., the search for predetermined or probable causal relation between two measurable factors.

### ***The Aggregation of Data About Individuals: The Ideal of "l'homme moyen"***

In traditional statistical analysis the first step is to aggregate data about different individuals. Averages, or mean values, and their respective mean variations are ascertained. Through such averaging, however, essential information is lost:

Traditionally, the heart of statistical analysis in social psychology is averaging. (...) By averaging over time, one loses considerable information—perhaps the information that is most critical for understanding the phenomenon (Vallacher & Nowak, 1994, p. 289).

Statistical procedures that are based on estimates of true variance and error variance assume implicitly that the measured object does not naturally vary. This

assumption contradicts fundamental assumptions about education. It is precisely through educational processes that specific variations both among individuals and over time within individuals should be produced. The procedures for estimating error variance originated in astronomy (error law) where they describe the distribution of errors in repeated *measurements* of a particular object or event. Therefore, the term ‘error’ referred there not to the object being measured, but to the measurements and the procedures by which they were produced. The founder of social physics, Adolphe Quetelet, was fascinated by astronomy and transferred in 1836 the idea of the error law to *persons* by equating variance with error (see Wettstein, 2002). In Quetelet’s eyes, deviation from the average generated not only ugly bodies but also ugly morals. Hence, he coined the term *l’homme moyen* or ‘average man’. For Quetelet, this average man stood for the ideal human being:

(...) an individual who epitomized in himself, at a given time, all the qualities of the average man, would represent at once all the greatness, beauty and goodness of that being (Quetelet, 1836, quoted in Porter, 1986, p. 102).

And

(...) virtue consists in a just state of equilibrium, and all our qualities, in their greatest deviations from the mean, produce only vices. (Quetelet, 1853, quoted in Porter, 1986, p. 103).

Such view may seem like a bizarre anecdote, but a glance into many psychology journals shows that it is still a reality, even today. The individual with his/her individuality and the diversity among individuals are lost in these mean values. Especially for education, though, individuality is not some residual category, but it is “(...) a prime characteristic of human nature. To develop a science of personality we must accept this fact” (Allport, 1961, p. 21). Variability is a fundamental feature of all living things. Therefore, the examination of variability both within a system over time and between systems is critical to the understanding of developmental processes.

### ***Aggregation over Time: Timeless Human Beings***

In *cross-section studies* statements about the development of individuals cannot be made, but *longitudinal studies* allow, in principle at least, for the description of intra-individual changes, mostly across two measurement points relatively distant in time. This would, on a modest level, achieve the gathering of data on intra-individual changes. Hierarchical Linear Models (HLM) (Raudenbush & Bryk, 2002) allow for measurements of change to be combined with a multi-level analysis. Estimates can be made about the influence of variables on different levels (e.g., individual, interactional, group, institution).

In education research, such input–output designs are mainly employed in the context of *school effectiveness paradigms* research, which is currently experiencing a golden age in the US and Europe (e.g., PISA, BIQUA). On the basis of large-scale studies “data-driven” decision making in education policy and thus higher

quality and increased effectiveness in education should become possible. This kind of research is designed according to a natural science paradigm (the isolation of central variables, technical control of confounding variables). In standard research the analysis proceeds almost without exception on a level of large aggregates, such as large groups, school districts or whole countries. The technique is also suitable for a status analysis, but it does not produce information about the developmental processes and mechanisms of individual students. Hence, after 20 years of standard research, Wayman and Stringfield (2006, p. 464) come to the conclusion that “(...) school systems are demanding more testing and measuring of students than at any time in history, but our educators often live in the paradoxical situation of being both ‘data rich’ and ‘information poor’.”

In order to understand developmental processes, phenomena have to be described in the form of ‘thick descriptions’. From this perspective, the question in the foreground is no longer ‘which educational systems lead to what kinds of outputs?’, but rather ‘which processes are going on in individual students and how can students be supported in their developmental and learning processes?’. Underlying this approach is an understanding of the course of development as non-linear. Development needs to be understood as a hierarchical process that shows discontinuities, ambivalences, and ruptures.

### ***Different Temporal Resolutions***

Depending on the observer’s focus, reality can be partitioned into temporal units of different length. Likewise, educational processes can be investigated in different *temporal resolutions* and over different *periods of time*. The most common differentiations are micro-, meso-, and macrogenetic perspectives (see Valsiner & Sato, 2006).

1. *Macrogenetic time perspective*: In macrosystems, often referred to as cultural systems, transformations take place over longer periods of time. Developments within a culture or sub-culture occur as socio-historical changes over decades or centuries.
2. *Mesogenetic time perspective*: This temporal perspective describes developments of the individual life course (ontogenesis): How do developmental transitions occur in an individual? The majority of studies in developmental psychology are concerned with this temporal level.
3. *Microgenetic time perspective*: A microgenetic perspective offers an analysis of relatively short time periods by operating with finely calibrated units of observations. In intrapsychic developments as well as in interactions, patterns may change within quite short time intervals (see Siegler & Crowley, 1991; Wagoner, 2009– in this book).

Microgenetic, ontogenetic, and socio-historic perspectives can be combined and investigated in parallel. The different temporal levels are in a relationship of mutual influence to each other. Thus, individuals develop through their participation in

cultural communities and at the same time, their active participation changes the cultural dynamic of a community (see Thommen & Wettstein, 2009, accepted). Which time perspective and temporal resolution is appropriate depends on the specific research question.

The process-oriented and dynamic view we have outlined largely contradicts *naïve theories of education and personality* (*common-sense psychology*). For the most part, these theories strongly rely on the idea of stable personality traits. Their danger when it comes to questions of education is that they tend to over-generalize undesirable behavior and that, as a result, blame is attributed to one side only, targeting particular persons. The stability of personality traits, however, exists first and foremost in our heads (Mischel, 1968). But because scientific theories often have some roots in everyday assumptions, a similar tendency can be noticed in the development of scientific theories. In both science and everyday life, two crucial qualities of human experience and behavior are rather underestimated: that they are processes and specific to particular situations.

## **Education in Social Context**

Human beings do not act as isolated individuals furnished with particular personality traits or behavioral dispositions. Human beings always act in a material and social environment. Already Allport (1970, p. 172) pointed out that human behavior is dependent on context and the situation in which it occurs: “We never encounter personality apart from some situation.” The variety of material and social environments leads to a great variability of forms of personal behavior.

### ***The Ecological Perspective***

Education takes place in diverse social contexts. An ecological perspective distinguishes the fields of family, school, and neighborhood. The degree to which education is institutionalized and formalized depends on the field or context in which it takes place. The highest degrees of institutionalization and formalization can be observed in a school setting. Schools set explicit learning goals and define the roles of educators and students. They organize learning by categorizing children according to specific rules into social groups and imparting to them a prescribed curriculum. Schools perform the functions of qualification, selection and legitimacy (see Fend, 1980) and to these ends, the education system has at its disposal diverse instruments of evaluation and sanction. By contrast, education within the family happens much less formally and is less goal oriented. But children acquire crucial competences in the areas of cultural knowledge and action by being part of a family system. To a large extent, learning in the family happens casually and accidentally (Bruner, 1971). From a socio-historical perspective, human beings develop as par-

ticipants in different cultural communities. “Humans develop through their changing participation in the socio-cultural activities of their communities, which also change” (Rogoff, 2003, p. 11). If one understands such social communities as open and transforming systems, however, education can be regarded as the exchange between individual and social systems (Thommen & Wettstein, 2009, accepted).

The central question for an ecological approach is how human beings behave and develop in their exchanges with their social and material environments (Barker, 1968). *Learning and teaching are context dependent processes*. Bronfenbrenner (1979, p. 21) defines the ecology of human development as

(...) the progressive, mutual accommodation between an active growing human being and the changing properties of the immediate settings in which the developing person lives, as this process is affected by relations between these settings, and by the larger contexts in which the settings are embedded.

### *Issues of Cross-Situational Consistency*

Cross-situational consistency refers to the behavior of a person across different situations. A person’s behavior is consistent across situations (cross-situationally), if the person acts similarly in comparable situations. For example—which types of behavior for which people are dependent on what kinds of situational conditions—could be examined. In his field study on the diagnostics of aggression in school settings, Wettstein (2006, 2008) identified problematic person-environment relationships which fostered or hindered the frequency in which individuals displayed aggressive behavior. These problematic person-environment relationships can be defined as if-then-relations, bearing in mind, however, that they are not thus defined as relations of cause or implication. For example: when in school excessive demands are made on student K, he displays in most instances physical aggression, directed against his own things (e.g., breaking his color pencils). Excessive demands on student F, however, lead to her displaying verbal aggression against female but not male adults. Shoda, Mischel, and Wright (1993) investigated cross-situational consistency of behavior over five types of situation among children attending a residential summer camp. They distinguished three negative (1–3) and two positive (4–5) types of situation: (1) being teased, provoked, or threatened by other children; (2) being put on notice by adults; (3) being punished by adults; (4) being praised by adults; (5) being approached socially by children of a similar age. They identified high rates of intraindividual consistency and intraindividually stable and distinctive ‘if-then’ profiles, with stability rates for verbal aggression of  $r = 0.49$  to  $r = 0.89$ .

In sum, education, especially formal teaching in schools, consists not in the stereotypical application of specific techniques; rather, it is a complex *design profession* (Schön, 1983; Wiggins & McTighe, 1998). Teaching cannot be done by rigidly following a procedure; it demands the successful orchestration of diverse didactic and pedagogic strategies. Teachers’ professional knowledge is based on experience, oriented toward action, and organized to fit specific situations (Bromme, 1992; Leinhardt, 1993).

In this context, the practitioner is less like the bulldozer driver carving a way through the landscape to a pre conceived objective, more like a combination of canoeist shooting the rapids and creative artist exploring possibilities and waiting for inspiration (Radford, 2007, p. 275).

The consequence of such questions in cross-situational consistency for research methods is that the exchange processes among parts of a system become the central object of research. Rather than describing static traits of individuals, the aim is, then, to discover general patterns in the exchange processes among individuals or between individuals and their environment. Therefore, processes of communication and interaction move centre stage as the prime interest of scientific education research.

### ***Education as Social Construction***

Approaches in systems theory, in the sense of Cybernetics II (Glaserfeld, 1997; Maturana & Varela, 1987; von Foerster, 1984; Watzlawick, 2002), consistently set out with a process-oriented perspective. Here, operations going on in time, and not the properties of systems, are the central objects of research. The second basic presupposition of cybernetics II is the differentiation between system and environment instead of parts and whole (e.g., individual and social group) (Luhmann, 1995). According to this view, systems are structurally and functionally oriented toward an environment. Cross-border processes of energy and information exchange are going on between living, open systems (such as human beings) and their environment. It is only through the operations of a system that an environment appears as a unity, i.e., a system defines its environment and fixes its borders with it. For this reason, systems are inevitably self-referential. These premises—the distinction of system and environment and the presupposition that systems can only operate by self-referential processes—have wide ranging epistemological implications which have been the subject of intense debate and controversy, known as the *constructivism* debate (e.g., Luhmann, 2005b; Vollmer, 1995; von Foerster, 1981). The constructivist position is that a system that is capable of understanding makes a distinction between itself and its environment as it is in the process of perceiving and understanding; the distinction is a concomitant of the perception process. As a consequence, observers (and that includes the system as the observer of itself by way of self-reflection) always have to state precisely which system is operating and in the process of distinction making. An analytical differentiation of different observational levels is necessary: between a first-order observer making distinctions and a second-order observer who observes how another system makes distinctions. Scientific psychological understanding is fundamentally based on observations of the second order, because psychological research investigates objects (human beings, their minds, emotions, behaviors etc) that already act on the basis of perceptions, interpretations and reflections. In other words, investigations in psychology always deal with an already meaning processing object, i.e., human subjects or aspects of their being.



Social constructivist approaches presuppose that human beings attribute socially mediated meaning to their own as well as to others' behavior. Human beings do not primarily act as a direct response to physical stimuli, but on the grounds of social meanings that were imparted to them in the course of their socialization. Social meanings and the interpretations derived from them are more loosely defined and shared among people in smaller and larger social groups, institutions, or whole societies. Social meanings are the foundation for regular social interactions so that the behavioral expectations that those involved in interactions have of each other are more or less stable. At the same time, however, through social interactions social meanings are actualized, stabilized and handed down, as well as modified, transformed and changed (see Dykstra, 1996; Gergen, 1990, 1991, p. 241).

As a consequence, *research methods* have to include ways to record and analyze the interpretations that actors articulate when they attribute social meanings to their actions. This involves researchers approaching their research object in a hermeneutic process of understanding. As a first step, therefore, researchers have to reconstruct overt actions on the basis of understanding. This can be done from an *external position*: researchers interpret social action in a hermeneutic process against the background of explicit social knowledge (e.g., the already existing knowledge of researchers as members of social communities, or knowledge from different observations and sources such as documentation and analyses of patterns of interactions that correspond to ideal types or social norms). These interpretations form the building blocks for further analyses. At the same time, it is also possible to understand the research object through the *internal view* of those being studied when they disclose themselves to researchers. In this approach, research subjects are questioned about their general social knowledge or about their interpretations of specific situations and actions. The subjective statements that research subjects make establish a source of data for subsequent interpretations by researchers and for the development of theories.

## Conclusions for Education Research

Researchers who conceptualize education as an open, socially constructed process face several challenges regarding the design of appropriate methods:

1. The research object is developing and changing in the course of time. Therefore, the use of time-sensitive research methods is required.
2. Education takes place in the context of an exchange with highly complex material and social environments, which are themselves developing dynamically. Of particular importance here are social communication and interaction. Therefore, methods are required that enable the production of data on system-environment interactions.
3. All those involved in the process of education attribute meanings to their own behavior as well as the behavior of all those with whom they interact. Children as much as adults are active constructors of their reality. Therefore, methods are required that document the social attribution of meaning.

## Dynamic, Process-Oriented Methods

Education can be generally defined as the instigation of developmental processes that occur in time.

Development then appears as a series of (...) changes that are joined together and that are to be assigned to specific places on the temporal continuum of an individual life course (Thomae, 1959, p. 10).

How can these developmental processes and transformation, constantly going on in time, be appropriately recorded and described? It is a challenging undertaking to demand that issues in scientific education research should be approached by using dynamic methods, by doing justice to the complexities of social environments, and at the same time by taking account of the social constructs of participants in their interactions. Only rarely can justice be done to all three requirements simultaneously. In this section we introduce research methods that, so we argue, do them justice at least partially. We distinguish two ideal types: *analytical-quantitative* and *reconstructive-hermeneutic approaches*. As we will show, however, these are not mutually exclusive categories and approaches from either type may be combined for specific research designs.

In *analytical-quantitative* procedures objects and methods are conceptualized in ways that are fundamentally orientated toward the natural sciences. In the case of behavior observations, distinctions regarding the examined object are made by means of a system of categories and indexes, and an underlying theory of measurement. Whether or not there is an event, and of what kind, is ascertained by observation. The result of such measurements is described by a predicate value. Behavioral events are assigned to categories in the same or analogous way as physical events are dealt with. The system of recording and codification and its coherence across different analysts serves as a criterion for the quality of objectivity of the recorded data. The interpretive processes, however, which occur when analysts assign events to particular categories (e.g., which behavior should be codified as “aggression with intent to damage”) are not made specifically explicit and, consequently, they are also not problematized. In the case of psychological events and their codification, the scientists assigning codes inevitably fall back on their everyday knowledge and on information derived from context. The processes of categorization and of drawing final conclusions are usually not part of a methodical reflection in this research procedure. Coherence among different codifiers is deemed a sufficient device for achieving the objectivity of measurements. Each of the observed events and the codes resulting from them are regarded as independent empirical events. Subsequently, data can be further processed by statistical (mostly non-parametric) methods. If the temporal dimension is taken into consideration, the suitable mathematical-statistical methods are those based on time series analyses. Mathematical methods and models have been developed in synergetics (Haken & Schiepek, 2006) that enable the description and analysis of non-linear, dynamic processes.

*Reconstructive-hermeneutic methods* set out from a different conceptualization of what the object of research is and from different science-theoretical presuppositions. From this perspective the object of the social sciences is always and

already a socially constructed object. What human beings do or say, also in everyday life, has social sense and reflects social rules and conventions. Communicative processes and corresponding cognitive (e.g., linguistic) processes on an individual level are preconditioned by common systems of meaning, but at the same time, they serve to create, transmit and reproduce meaning and sense in social systems. According to this conceptualization, the social sciences fundamentally deal with phenomena of the origin and transmission of social sense and social meaning. In Schütz's words:

The facts, data, and events with which the natural scientist has to deal are just facts, data, and events within his observational field but this field does not 'mean' anything to the molecules, atoms, and electrons therein.

But the facts, events, and data before the social scientist are of an entirely different structure. His observational field, the social world, is not essentially structureless. It has a particular meaning and relevance structure for the human beings living, thinking, and acting therein. They have preselected and preinterpreted this world by a series of common-sense constructs of the reality of daily life, and it is these thought objects which determine their behavior, define the goal of their action, the means available for attaining them—in brief, which help them find their bearings within their natural and socio-cultural environment and to come to terms with it. The thought objects constructed by the social scientists refer to and are founded upon the thought objects constructed by the common-sense thought of man living his everyday life among his fellow-men. Thus, the constructs used by the social scientist are, so to speak, constructs of the second degree, namely constructs of the constructs made by the actors on the social scene, (...) (Schütz, 1971, p. 6).

Schütz's position corresponds with fundamental assumptions in the contemporary, constructivist systems theory. According to that theory, social science research deals essentially with second order observations, i.e., with constructs of the constructs made by ordinary people in everyday life, and at times even with third order observations, as when social scientists examine the constructs made by ordinary people about other people's constructs in everyday life (see Fleischer, 2005); for example, an investigation into the thoughts that ordinary people have about one another's cognitive constructs in every day life.

A social science methodology that ignores these fundamental anthropological assumptions will only be able to do limited justice to their research object. The consequences of presupposing a meaningful world for the conception of scientific methods are as follows:

1. The research process itself, i.e., the exchange between researchers and research subjects, needs to be understood as a communicative process. This applies also when the research is designed to keep the exchange as minimal and standardized as possible. Even when checking boxes in a questionnaire, for example, research subjects ask themselves about the researchers' expectations and what effects their responses might have; this is an instantiation of the well known phenomenon of compliance with what is socially desired (see Diriwächter, Valsiner, & Sauck, 2005). Therefore, techniques of data collection need to be regarded as social situations in which social meaning and sense are negotiated.
2. The empirical objects under study are, on principle, meaningful, be they non-verbal behavior, utterances or written statements. Researchers who want

to document and analyze them are forced to proceed through interpretation and understanding. For this reason, research in the social sciences may be regarded as the reconstruction (on the part of the researcher) of a reconstruction (made by the research subject). Expressed in systems-theoretical terms, these are observations of observations, that is observations of the second and third order (see von Foerster, 1981). For example, large amounts of data in the social sciences exist in the form of meaningful *narratives* (see Bruner, 1990). Research subjects tell or write down stories about events and experiences, about an episode or period in their lives, or their whole life history. Oral or written narratives, then, comprise the primary data material in the social science research.

Another, frequently applied method consists of researchers creating their own narratives about the phenomena under study. For example, Piaget (e.g., 1952) recorded his observations in the form of free descriptions as part of his *méthode clinique*. They served him in subsequent steps of abstraction to develop, illustrate, and empirically verify his theory of development. A problematic issue with this method is what the rules for the production of these kinds of texts are. The practice of their creation ranges from quite free narrative accounts to texts that have been constructed according to narrowly defined, precise protocols, and models.

In contrast to analytical categories, a significant feature of narratives is that a linguistic, either oral or textual, account of events can portray them in the temporal, sequential order in which they occurred. For that reason, narratives are an ideally suited (already meaningful) research material for the empirical analysis of developmental processes.

In science the aim is to reduce complexity and to search for general patterns and regularities as the basis for abstractions. This raises the question how research narratives can be further processed, whether those produced by ordinary people as research subjects or those produced by researchers. Many well known scientists (e.g., Piaget, Freud, Margaret Mead) used their narrative accounts of observations to provide case material and to develop, illustrate and verify their theories. Others strove to design methods that render a researcher's interpretation process more transparent, comprehensible, and therefore more open to critical evaluation. In the main, these researchers draw on the hermeneutic tradition. We specifically mention here the method of "objective hermeneutics" (Oevermann, 2001), the "documentary method" (Bohnsack, 2003, 2007) and methods of qualitative development of certain "types" (e.g., Kluge, 1999).

All these approaches have in common that they distance themselves from a particular position in the theory of science, as it is represented by critical rationalism (Popper, 1959), for instance. These approaches assume that scientists do not occupy a privileged epistemological position in relation to ordinary people. Scientists, too, have to follow certain rules when they devise new theoretical approaches and reinterpretations of social reality—rules which are negotiated within their 'scientific community'. This is also a position represented in the current debate on constructivism (Luhmann, 2005a,b).

## Analytical-Quantitative Approaches

Two distinctive features characterize analytical-quantitative approaches as ideal types (see Fig. 16.1). (1) In a first step of data collection, empirical phenomena (e.g., physiological features, overt behavior, utterances, or written texts) are allocated to independent, analytical categories by means of decisions that are more or less inferential. (2) Data thus categorized are processed using mathematical analytical procedures (in the case of dynamic approaches using time-series analyses) for the purpose of identifying regularities and patterns. In addition, data that are generated in this way can be compared to idealized mathematical models.

Analytical-quantitative dynamic approaches presuppose that system processes can, in principle, be formulated in mathematical form and that mathematical models are the optimal form for the representation and modeling of empirical phenomena. Dynamic systems theories, however, are not aligned with a mechanistic physical worldview, but with a physical worldview that has been developed, variously redeveloped and differentiated since the early 19th century (Kanitscheider, 1993).

## Theories of Dynamic Systems—Synergetics

Dynamic systems theories (Vallacher & Nowak, 1994), especially synergetics (Haken, 1990; Haken & Schiepek, 2006), are rooted in physics. They deal with the self-organ-

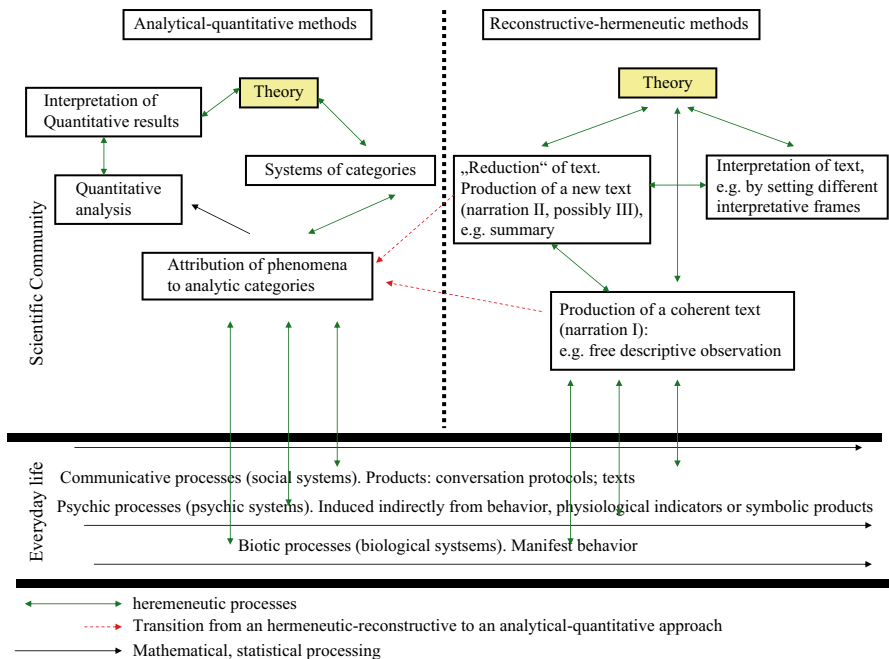

Fig. 16.1 Analytical-quantitative and reconstructive-hermeneutic methods

ization of systems and pay particular attention to the question how order develops out of disorder and chaos, but then changes and disintegrates again. Their premise is that physical systems, but particularly living systems, through continual processes of self-organization keep themselves in a dynamic state of balance in order to adapt as optimally as possible to their environment. The critical issue here is, however, how enduring and rigid such homeostatic states can be. If there is too much constancy, a system's capacity to adapt to a dynamically changing environment is lost, but if there is too much flexibility and capacity for change a system is in danger of losing its identity. Living systems usually oscillate between constancy and change in a dynamic equilibrium, a homeodynamic stability (Haken & Schiepek, 2006, p. 27). Synergetics was initially developed in relation to processes in physics and chemistry (Haken, 1990), but it is nowadays frequently applied to psychic and social systems (Haken & Schiepek, 2006; Vallacher & Nowak, 1994). Transformational and change processes do not always proceed on a continuous and linear course; rather, there is often evidence of qualitative ruptures and transitions linked to chaotic developments.

The study of self-organization has predecessors in the history of psychology, mainly in the field of studies on perception, thought and behavior. *Gestalt*-psychologists in particular, e.g., Köhler (1973) and Metzger (1986), worked on psychic processes of self-organization in the area of perception, thought and action. As a result, questions about how external influences impact on the behavior of human beings were of greater interest to psychologists. Processes of self-organization and questions about how ordered patterns form and take shape were relegated to the background. For the following reasons, however, synergetic concepts and methods are of special interest to developmental psychology:

1. Systems theory approaches have become widely accepted in psychology. As psychology is concerned with individual systems, and in the case of social psychology with social systems, emotional, cognitive, motivational, behavioral as well as communicative processes are central issues in the discipline. Synergetics provides a theoretical and methodical framework for the description of these dynamical processes.
2. When dealing with processes of learning, development and education, a critical issue is how various forms of structures are generated and changed in open, complex systems. Synergetics provides approaches for understanding how systems develop new qualities (*emergence*). In psychology development has been mostly regarded as a sequence of qualitatively distinct phases, though without there being adequate means and models of description.
3. Concepts central to the theory of dynamic systems and corresponding mathematical formulations—such as ‘circular causality’, ‘attractor’, or ‘order parameter’—promise an improvement over standard mathematical models for the description of processes and patterns in psychic and social systems (see Haken & Schiepek, 2006).

The links between synergetics and education are yet scant. An examination of contributions to a 1997 symposium on “Self-Organization in Psychology” reveals that none of them addresses issues in pedagogy or education (Tschacher, 1997, p. 15). Likewise, relevant general reference books on synergetics do not index edu-

cation, teaching, or pedagogy, and not a single study in this area is listed (Haken & Schiepek, 2006). Considering the nature of education, it is astounding that the models and approaches from dynamic systems theory have not been applied so far in research on learning processes or communication and interaction in school settings. Similarly, there are no empirical studies examining the interaction of teachers and pupils. One reason for this lack may be the sheer complexity of these interactive events: that there are more members in a school class than in a therapeutic dyad and, consequently, the processes going on in such a research setting are significantly more diverse and complex, and hence more difficult to record and document.

In Haken and Schiepek (2006) a whole chapter is devoted to processes of self-organization in social systems in which questions of communication and social coupling as well as phenomena of group dynamics are examined. Synergetic approaches have variously been adopted also in developmental psychology (van Geert, 1998), psychotherapy research (Tschacher, Scheier, & Grawe, 1998), research on interaction between spouses (Gottman, Murray, Swanson, Tyson, & Swanson, 2005) as well as research on the family (van Geert & Lichtwarck-Aschoff, 2005).

A dynamical view of social processes focuses attention on the temporal patterning of interaction instead of on a static view of social events. This point of view can only enhance interest in what actually occurs in social interaction and how this interaction is perceived (Gottman et al., 2005, p. 66).

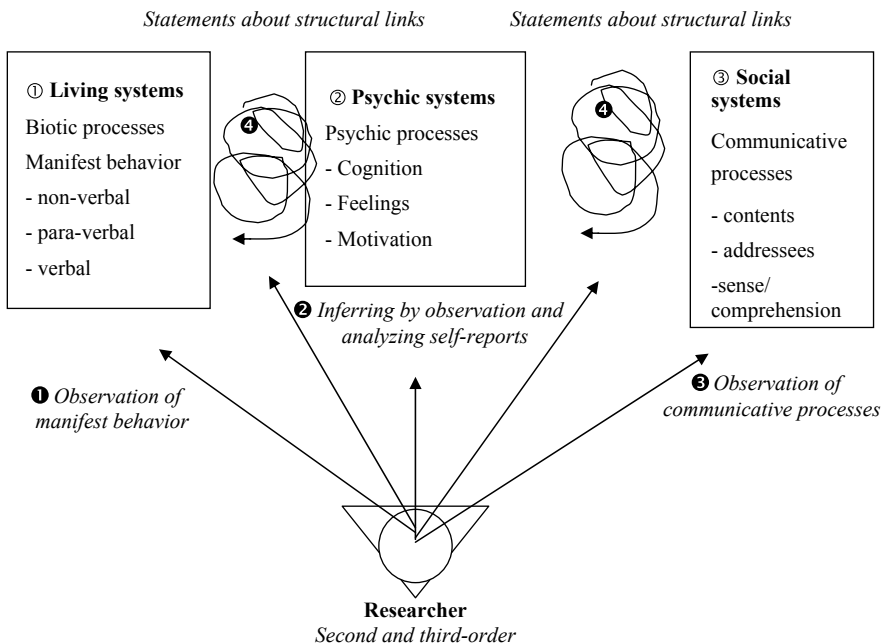

**Fig. 16.2** System processes and methodological approaches, ① bio-physiological und motor processes (especially behavior) of students and teachers. ② psychic processes of students and teachers (cognitions, feelings, motivations). ③ communicative processes in the social system of the school class, i.e., among students as well as between teachers and students

We, the authors, are currently involved in an ongoing project of empirical education research (*Projekt zur Untersuchung der Entwicklung und Veränderung von Unterrichtsstörungen in Schulklassen*—An Investigation into the Development and Transformation of Lesson Disruptions in School Class Settings) for which we adapt fundamental premises and concepts of dynamic systems theory and corresponding methodological approaches to this context (Wettstein & Thommen, 2006). A particular focus is the mutual influence that intrapsychic processes in individual pupils and social interactions have in the system of a school-class. Such a process orientated and systemic-constructivist perspective expands the more prevalent dispositional and individual-centered perspectives on teaching disruptions or disruptive behavior. In our project we conceptualize disruptions during lessons as co-evolutionary processes between bio-physiological, psychic, and communicative processes in the social system of the school class (Thommen & Wettstein, 2009, accepted). Within this systemic-constructivist framework we distinguish processes of three qualitatively different types of system (Fig. 16.2).

Formulated in the terms of systems theory, the issues investigated in our project are (see Fig. 16.2):

- ❶ What processes, especially behavior processes, are going on at the level of the *living systems* ‘teacher’ and ‘student’? What behavioral patterns can be identified?
- ❷ What cognitive, emotional, and motivational processes are going on at the level of the *psychic systems* ‘student’ and ‘teacher’? What intrapsychic patterns can be identified?
- ❸ What communicative processes are going on at the level of the social system ‘school class’? What communicative patterns can be identified?
- ❹ How do the processes at the individual and the social levels *co-evolve*? Are they structurally linked? What superordinate patterns can be identified in the ways in which processes unfold in each of the systems?

Dynamic systems theory so far has been primarily concerned with the description and simulation of linear and non-linear time series of single process variables. If classroom disruptions are conceptualized as a co-evolutionary process of intraindividual (bio-physical or psychic) and interindividual processes (social-communicative), there are methodological consequences: data of the two simultaneously running processes should be related, so that regularities and patterns of the co-evolutionary process can be investigated. We do not know any mathematical models that achieve this. There are, however, ways of representing and illustrating patterns of parallel occurring processes in analogue form, as graphic representations.

## Choreographies and Orchestral Scores

Systemic-constructivist approaches make the fundamental assumption that there are dynamic processes going on simultaneously in systems and their environments. Music and its graphic representation in sheet music or whole orchestral scores provides a fitting metaphor of this perspective. Individual instruments and their musical parts correspond to ongoing processes of individual systems. Regularities in the



orchestral score can be analyzed both vertically (as harmonies at a particular bar or beat) and horizontally (melody and themes). In temporally synchronized accords and harmonies of each melodic arch, the parts of individual instruments co-evolve to a complex, highly structured, and ordered (and in the case of Mozart, for example, certainly well-pleasing) acoustic event.

Vorsmann (1972, p. 43), prefiguring such ideas decades ago, coined the term “*Unterrichtspartitur*” (‘teaching lesson score’). As an alternative to teaching research based on input–output models and testing established hypotheses primarily from aggregated data, he suggested the analysis of single case studies. Instead of analyzing single variables, these case studies allow for the description and analysis of the complex processes that are going on during a lesson. Because his reflections were primarily aimed at practical issues in teacher training and professional development, he developed systems of observation and description that practitioners could use for evaluating and improving teaching delivery and lesson design. He succeeded in recording the simultaneously occurring behaviors of teachers and students using tables and graphics, and in them also managed to integrate the methodical and didactical arrangements of lessons which unfold at the same time. Given the technical possibilities available at the time, he did not formalize his technique any further.

In order to put the perspectives of learners and their learning processes centre stage of reflections on didactics, a group of researchers around Oser (Elsässer, 2000; Oser & Patry, 1994; Oser & Baeriswyl, 2001) developed an approach to *choreographies of learning in formal teaching settings*.

We postulate (...) the hypothesis that at the base of all learning there is a so-called choreography, or that learning should have a base in choreography, that combines both the freedom to orchestrate methods and the rigidity of absolutely necessary steps of learning. Our hypothesis is part of a comprehensive theory of learning which occurs as a process and under conditions in which chaining [of events], forms of actions and proximal interconnections are all relevant to the course this process takes. (Oser & Patry, 1990, p. 1).

Oser and Patry distinguished between manifest structures and base structures. Manifest structures refer to the observable behavior of learners and the observable interactions between teacher and learner. These various manifest structures are founded in base structures of teaching-learning processes, described as ideal types.

The base structure consists of a fixed chain of operations that is absolutely necessary for every learner and that cannot be substituted by anything else. The holistic character of each chain is determined by regularities in the psychology of learning as well as by the type of goal or the contents. (Oser & Patry, 1990, p. 3).

Oser and Patry’s theoretical reflections are primarily concerned with different learning types, but they also derived twelve basic models of learning. They used the construct of choreography to refer to the process character of what happens in teaching-learning events. But they did not generate their basic models empirically, nor did they render them useful for the analysis of visible structures. The basic models were normatively posited and initiated the following research questions, among others: Which basic models do teachers use in their teaching? Does the teaching of basic models to teachers contribute to an increase in the quality of their teaching?

By proposing the concept of choreography Oser and Patry offer an interesting construct for the description of dynamical processes involved in teaching and formal instruction. The theoretical postulates of temporality and simultaneity, however, are in their empirical work only partially fulfilled.

In teaching research the concept of *scripts* is significant, especially in the *investigation of teaching-learning processes*. The concept was originally developed in cognition research, but it shares many similarities with the constructs ‘choreography’ or ‘orchestration’. Schank and Abelson (1977, p. 41) defined script as “... a pre-determined, stereotyped sequence of actions that defines a well-known situation.” In a variety of video studies on mathematics teaching (Pauli & Reusser, 2003) and physics teaching (Seidel, 2003; Seidel et al., 2002) the concept of scripts has been closely examined, e.g., whether teachers realize certain scripts, how great the variability of scripts is, and whether scripts are linked to students’ motivational and cognitive proc-

Datiert Wien, 14. Juni 1787

Allegro

Corno I, II in Fa/F  
Violino I  
Violino II \*\*  
Violino II \*\*  
Viola  
Basso

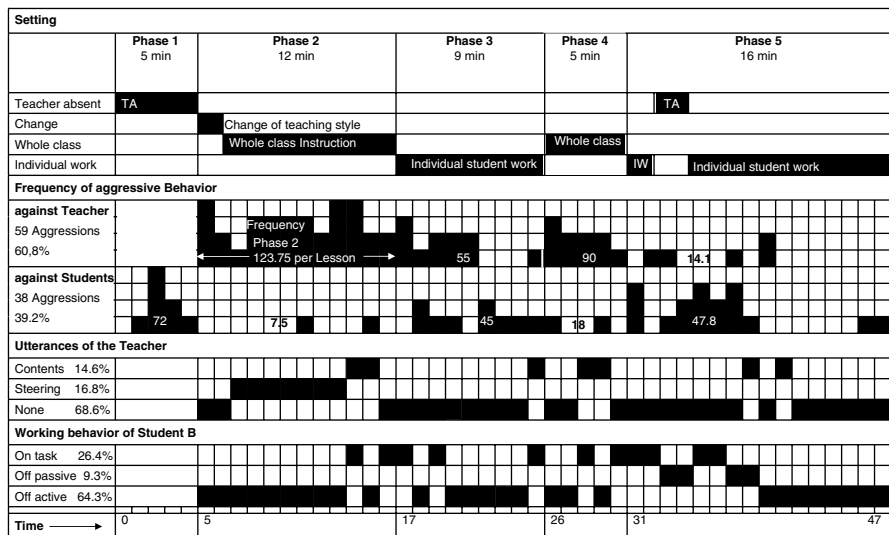

**Fig. 16.3** Excerpt from Wolfgang Amadeus Mozart (1976) *Ein musikalischer Spass* (A Musical Joke) for two horns, first violin, second violin, viola, and cello, showing his experiment in multi-tonality; and teaching lesson score showing a temporally ordered data set with four observational dimensions

esses. Lesson sequences were identified by applying mostly relatively wide-ranging, general categories (e.g., lesson phases like whole class instruction, individual quiet work, working in groups, repetition of lesson content, or learning of new content). The concept of scripts, however, calls for a specific kind of analysis of empirical data, namely a sequential analysis, and these empirical studies only partially performed such an analysis. Often, the categorical data were aggregated already in the initial stage of statistical processing, and it was these aggregates that were subsequently analyzed for correlations. Seidel (2003, p. 174) herself, then, critically remarks on her empirical analysis: “But as a consequence of the high level of aggregation in this method, the process character of the in-class observations largely gets lost.” She concludes by calling for detailed case studies about how lessons unfold and progress in time and the interactive teaching-learning processes involved.

## **Reconstructive-Hermeneutic Methods**

It is a defining feature of reconstructive-hermeneutic methods that researchers do not allocate data to analytical categories immediately as they are recorded, but that they record them in narrative form or, as it were, reconstruct them. Narratives offer a whole range of advantages in relation to our main concern, i.e., a process orientated representation of data. In a narrative account, the temporal sequence of events can be linguistically represented. It can be stated in what sequence events occurred, which event occurs before another, or what relations of past, present, and future events have with one another. Also features such as complex temporal embeddedness or encapsulation and different temporal grades of resolution can all be expressed by the means of language.

The first step of data analysis in reconstructive-hermeneutic approaches is that the researcher produces a narrative. The initial data for the construction of this narrative may be individual verbal or non-verbal behavior, or they may be narratives already created by research subjects (descriptions of and stories about experiences in the form of verbal accounts or written texts) as they are commonly elicited through questionnaires that include open questions or through narrative and semi-structured interviews. In such cases, research subjects already constructed descriptions about themselves on the basis of which researchers create their narratives. This means that researchers construct narratives about narratives, double constructions, in other words, or observations of the third order.

Narratives can be strongly subjective, or they may have been crafted under comprehensive methodical control and are thus more transparent as creations and intersubjectively comprehensible. In a hermeneutic tradition several methods have been developed to make explicit the understanding of narratives, among others objective hermeneutics (Oevermann, 2001) and the documentary method (Bohnsack, 1997, 2003, 2007; Vogd, 2005). In the American tradition, ethnomethodological approaches (Garfinkel, 1967; Spindler & Hammond, 2006) and frame analysis (Goffman, 1986) should be mentioned.

## ***The Description of Verbal and Non-Verbal Behavior in Natural Settings***

In order to find out how human beings behave in their daily lives, observations have to be made in everyday life settings, as far as this is possible. There is a vast and rich repertoire of methods in social and cultural anthropology, detailing ways in which, mainly through participant observation, thick descriptions of individual and social processes can be produced in natural cultural settings (Geertz, 2006; Mead, 1930; Whiting & Whiting, 1975). Psychologists partially draw on these models, but there are important contributions developed within psychology which rely primarily on naturalistic observations.

Piaget's *research* is largely based on his observations of children's behavior in natural settings. He supported his theory on the origin of intelligence in the child (Piaget, 1952) with observations and descriptions of his own children's behavior. He deduced his pioneering theory of cognitive development from these behavioral observations and developed two central concepts: the processes of assimilation and accommodation. At the same time, his empirical observations also underpinned the development and verification of his models of cognitive development. For all of his life, Piaget disassociated himself from narrowly defined, quantitative-experimental methods in psychology.

The good experimenter must, in fact, unite two often incompatible qualities; he must know how to observe, that is to say, to let the child talk freely, without ever checking or side-tracking his utterance, and at the same time he must constantly be alert for something definite; at every moment he must have some working hypothesis, some theory, true or false, which he is seeking to check. When students begin they either suggest to the child all they hope to find, or they suggest nothing at all, because they are not on the look-out for anything, in which case, to be sure, they will never find anything (Piaget, 1981, p. 19).

Barker and Wright (1955, p. 2), however, offered the criticism that unlike geologists, biologists, chemical engineers, and physicists who know with considerable detail the natural distribution of objects and processes that are their subject matter, psychologists know little about such things as how a mother takes care of her child or how a teacher behaves in her/his class room. In *One Boy's Day* Barker and Wright (1951) applied a natural history approach to investigate the "stream of behavior" of a boy in the natural context and over the whole course of the boy's day, from his getting up in the morning to his going to sleep at night. A team of trained observers followed and recorded all aspects of daily life of the 7-year-old child without interruption and divided the boy's stream of behavior into behavior episodes. On the basis of a subsequent study, Barker made the following observation

The characteristics of the behavior of a child often changed dramatically when he moved from one region to another"; and: "The behavior of different children within the same region was often more similar than the behavior of any of them in different regions (Barker, 1968, p. 152).

So, in a bakery, for example, children behave in ways that fulfill the conditions of being in a bakery or when sitting in school class the conditions of attending les-

sons. Lichtenberg (2003) replicated the study by making a digital video recording and analyzing the daily routine of a mother with her small child in a big city.

The research team around Krappmann (Benkmann, 1987; Krappmann & Oswald, 1995; Schrenk & Krappmann, 2005) studied *the everyday life of school children* through participant observation and recorded their observations in episodic descriptions and protocols of the course of events. Her assumption is that any problematic behavior displayed by an individual should not be regarded in isolation. Aggressive behavior, for example, must be investigated in the social context in which it occurs and in terms of its functional value. In their study among 10-year-olds about the functionality of using violence in their daily life at school, Oswald and Krappmann (2000) reach the following conclusions:

Here and everywhere and before long educational interventions are not effective, because they disregard the functionality of the use of violence in the interactive processes of the children's world. This world is a social world in which children need to try to achieve the goals that are of primary importance to them by making economical use of whatever means are at their disposal. (Oswald & Krappmann, 2000, p. 14).

Following theories of the pragmatic philosophy of language (Habermas, 2006; Searle, 1969; Wittgenstein, 1953), the events taking place in a class room can be regarded as a language game which can be examined by means of a *micro-dialogue-analysis*. Methods developed in social and cultural anthropology (e.g., Erickson, 1987; Hammond, 2006), among others, are suitable for the analysis of such processes of co-construction. The verbal contributions of communication partners are analyzed and interpreted in the temporal sequence in which they occur. Krummheuer (1997) and Krummheuer & Naujok (1999) carried out micro-sociological studies of teacher-student interactions as well as interactions among students in mathematics lessons, drawing on Bruner's (1983, p. 120f.) concept of "format". Bruner defined "format" as a "standardized, initially microcosmic interaction pattern between an adult and an infant that contains demarcated roles that eventually become reversible" (Bruner, 1983, p. 120). In addition Krummheuer refers to Erickson's (1982) "academic task structure" (ATS) and "social participation structure" (SPS) that form the basis of these interactions. The aim of this empirical research methodology is threefold: to understand the social construction of what goes on during lessons through context specific interpretations; to test the plausibility of ex-post-facto-hypotheses determined by abduction (Peirce, 1978) through empirical analysis; and to make transparent the theoretical knowledge and presuppositions, on which the analysis is based. Lüders (2003), following a comparable methodical procedure, analyzed the structuring of lessons into teaching phases and free student contributions.

The question at the core of such research is: how do teachers and students together co-construct meaning and social knowledge in the course of their communications during lessons? Maciel, Branco, and Valsiner (2004) examined conversations between teachers and students and showed how in the process of their communication and meta-communication they simultaneously built mutual trust in their relationship and reciprocally steered the teaching-learning process.

The microgenetic analysis of episodes of transitions in the teaching/learning process may prove an adequate route to highlight the differential role played by specific strategies as

well as a means to unravel the organization of the processes at both structural and dynamic levels. (Maciel et al., 2004, p. 123).

The theoretical paradigm for such micro-analyses consistently is understanding. Empirical studies show how participants in interactions generate social meaning specific to the context and which general social rules and conventions are the basis for these interactions. However, such studies rarely produce findings that are generally applicable across other contexts. For this reason, their conclusions are of limited relevance to issues in practical pedagogy.

How do schoolchildren shape the transition between recess and lesson? Which rituals are part of this transition? Wagner-Willi (2005) takes up approaches established in social and cultural anthropology, such as *ritual studies* (Turner, 1989) and theories of cultural performance (Geertz, 2006), as well as Goffman's (1986) theory of frames. She points to interesting issues about the relationship of the socially normative form of rituals and actors' actual and creative performance. Wagner-Willy made video recordings of the transitions between recesses and lessons, and analyzed these scenes by means of documentary interpretation (Bohnsack, 1997, 2003, 2007). In a documentary interpretation approach, the empirical material (here the video recordings) is processed in three steps in order to establish the formal organizational structure of interactions. In a first step, called *formulating interpretation*, a description of the recorded behavior is formulated with as little inference as possible and without attributing motives to actors. The second step, *reflecting interpretation*, aims at a theoretical-reflective explication of the observed interactions that all refer to each other. The final, third step, *comparative interpretation*, consists of comparative interpretations with reference to different theoretical systems. Because of these transparent and explicitly stated comparative interpretations a decision can be made as to which frame of reference is best suited to the reconstruction of the empirical material. The documentary method consistently addresses a main concern of reconstructive-hermeneutic methodologies which is to understand the complex reality of interactions from multiple perspectives and in terms of their intrinsic form as processes and their interconnected meaning.

### ***The Description of Narratives***

Psychology deals to a large extent with self-accounts rather than with direct observations of verbal and non-verbal behavior in natural settings. The empirical research material most often consists of narrative products of oral or written form in which research subjects provide accounts about themselves or about events and experiences of the more or less distant past. Self-accounts provide insights into the subjective processes of construction by which people subjectively represent and construe their reality (e.g., life history research). It is important, however, not to confuse subjective representations with actual actions and experiences, as they occurred at the time. Such self-accounts primarily convey how people would like to see themselves

and not what they in fact did and do. Self-accounts are based on memory, and they are therefore the result of subjective corrections and distortions.

Schrenk and Krappmann (2005) investigated whether students make use of aggressive strategies in order to reach their personal goals. They presented primary students with a fictitious case, a “vignette”, and asked them what their tactics to resolve a social problem would be, in the case below, to achieve the desired participation.

Monika (...) is sitting together with Britta (...) at a table for six. Britta is very popular, for there is always something happening around her. Everybody likes her and likes being near her. In today’s German lesson they are engaged in group work. At each table of six students should make up a story together. Monika instantly has a great idea what they could write about. But the others push the piece of paper towards Britta who immediately begins to write down a story. Monika calls out: “I know a fantastic beginning for the story!” But the others do not listen to her. (Schrenk & Krappmann, 2005, p. 26).

After reading the case story, the children produced their solutions for how they would deal with the social problem and the researchers analyzed them. Schrenk and Krappmann concluded that much of the aggressive behavior involves tactics that children develop on the basis of their social experience and that they often use quite competently. In many cases these tactics signal elaborate experiential knowledge and pragmatic calculation rather than inability.

Among educationalists and psychologists who have conducted empirical research, there is a long tradition of writing a daily journal. In such diaries—which may be written over long periods of life—developmental processes can be recorded in natural settings. For example, the textbook illustrations made by William Stern draw primarily on his journals. From 1900 to 1918 he kept a journal together with his wife Clara about the development of their three children. According to Stern’s (1967) personalistic view, a person’s personality is not a given. Rather, personality is a set task. Personality comes into being as a development. Personality comes to light as the realization of the self in a person.

It is also possible to discover and understand the internal views of research subjects through their diaries. In her book *Attempt at a Holistic Portrayal of the Inner Life of Young Persons* Charlotte Bühler (1975) studied the transition from childhood to adulthood in the lives of adolescents by analyzing 52 daily journals. She followed an interpretive-hermeneutic approach:

Anybody who wants to describe adolescent inner life needs to know and understand young people, needs to love them and be near them, needs to be able to feel their happiness and their aches as if their own. Moreover, beyond general knowledge and empathy, it is necessary to have detailed and factual knowledge about adolescent development. General observations or experiments alone cannot convey this kind of comprehensive overall picture of a whole period of development. (Bühler, 1975, p. 43).

Bühler described the daily journal as a book of development: “In addition to the directly described details it shows facts of development and a developmental direction” (Bühler, 1975, p. 51). Transitions from one developmental stage to the next can be identified and traced in detail in the journals. Many journal passages reflect adolescents’ feelings of inhabiting an in-between world.

His dealings with adults and his preparation and orientation towards life as an adult and, on the other hand, his still vivid interest in childlike play with his friends of the same age make K.V distinctly feels his being oddly betwixt and between. (Bühler, 1975, p. 191).

## Summary and Outlook

Research processes are dependent on a variety of fundamental assumptions and pre-suppositions: assumptions about the object of the investigation, theoretical concepts and positions, decisions about the methods that are used to generate, process, and analyze data (see methodology cycle by Valsiner, 1997). Education should be conceived as an open, non-deterministic developmental process that in essence unfolds in the interactions between an educator and a person being educated. Education is a social and cultural event in which meaning is being constructed, imparted and partially constituted as tradition. If this, our, understanding of the research object 'education' finds agreement, there are wide ranging requirements that the research methodology governing the research process has to fulfill as a consequence. Methods must have the following features:

- enable the representation of changes as they occur in time.
- record the exchange processes between the subject who is being educated and his or her material, social and cultural environment.
- enable the conceptualization of the processes by which research subjects as well as researchers construct meaning.

Traditional education research was only able partially to realize these requirements. Many research projects are still based on designs that presuppose simple relations of cause and effect and that treat data as if they were physical facts rather than as the social facts that they are, i.e., as socially constructed and socially meaningful. In many cases data on individuals or different points in time may be aggregated and subsequently processed by statistical methods based on mean values. As a result of such methodological approaches and methods, the research subject appears timeless, void of individuality and socially decontextualised—a subject, in other words, that stands in stark contradiction to our fundamental assumptions about what education is and how it happens.

We discussed various already practiced methodological approaches that avoid this kind of reductionism. They can be roughly divided into two families of methods, *analytical-quantitative* and *reconstructive-hermeneutic*:

A special analytical focus of analytic-quantitative approaches is the process characteristic of educational phenomena. Theories of dynamic systems and the related methods of synergetics enable, by using mathematical models, not only the description of processes that are happening in time but also the investigation of regularities and patterns in these processes and their representation in models. If one conceives of education as a co-evolutionary process between psychic and social systems (see Thommen & Wettstein, 2009, accepted) the challenge is to reveal and analyze the relationship between patterned processes that go on in parallel, i.e.,



that are simultaneous and inter-connected. So far the solutions for this problem are mainly approaches using graphic representations. Any mathematical techniques would still need to be developed, and close collaboration between mathematicians and social scientists would be imperative for achieving this aim.

A special analytical focus of reconstructive-hermeneutic approaches is the always already socially constructed reality of all education processes. The research material analyzed by these methods are, in the main, actors' own meaningful narratives. In addition to, and from these, researchers produce their own, new narratives in a methodically controlled way. Given the linguistic form of this research material—oral or written narratives—researchers are forced in their analyses to take account of the social contexts in which their research subjects are situated and in which the narratives were produced. What is more, narratives also lend themselves to the expression of temporal relations by inevitably articulating references to the past, present, and future.

So far, these two strands of methods have been developed if not in isolation from each other then without much intersection. Given their different roots in the history and theory of science, this is not surprising. We have shown, however, how critical it would be to interlink and combine them. The qualities of both sets of methods could be put to use in a complementary way, with the aim to do methodological justice to the dynamic object of education research.

## References

- Allport, G. W. (1961). *Pattern and growth in personality*. New York: Holt, Rinehart and Winston.
- Allport, G. W. (1970). *Gestalt und Wachstum in der Persönlichkeit*. Meisenheim am Glan: Verlag Anton Hain.
- Barker, R. G. (1968). *Ecological psychology. Concepts and methods for studying the environment of human behavior*. Stanford, CA: Stanford University Press.
- Barker, R. G., & Wright, H. (1951). *One Boy's day. A specimen record of behavior*. New York: Harper & Row. (Reprint 1966).
- Barker, R. G., & Wright, H. (1955). *Midwest and its children. The psychological ecology of an American town*. New York: Harper & Row.
- Benkmann, R. (1987). *Sanktion und Streit unter Kindern*. Dissertation, Freie Universität, Berlin.
- Bohnsack, R. (1997). Dokumentarische Methode. In R. Hitzler & A. Honer (Eds.), *Sozialwissenschaftliche Hermeneutik* (pp. 191–212). Opladen: Leske + Budrich.
- Bohnsack, R. (2003). Dokumentarische Methode und sozialwissenschaftliche Hermeneutik. *Zeitschrift für Erziehungswissenschaft*, 6(4), 550–570.
- Bohnsack, R. (2007). *Rekonstruktive Sozialforschung. Einführung in qualitative Methoden* (6th ed.). Opladen, Farmington Hill: Barbara Budrich.
- Branco, A. U., & Valsiner, J. (1997). Changing methodologies: A co-constructivist study of goal orientations in social interactions. *Psychology and Developing Societies*, 9(1), 35–64.
- Bromme, R. (1992). *Der Lehrer als Experte: Zur Psychologie des professionellen Wissens*. Bern: Huber.
- Bronfenbrenner, U. (1979). *The ecology of human development. Experiments by nature and design* (Vol. 2). Cambridge: Harvard University Press.
- Bruner, J. (1983). *Child's talk. Learning to use language*. Oxford: Oxford University Press.
- Bruner, J. (1990). *Acts of meaning*. Cambridge, MA, London: Harvard University Press.
- Bruner, J. S. (1971). *The relevance of education*. New York: W. W. Norton & Co.

- Bühler, C. (1975). *Das Seelenleben des Jugendlichen. Versuch einer Analyse und Theorie der psychischen Pubertät* (6th ed.). Frankfurt a/Main: Fischer.
- Diriwächter, R., Valsiner, J., & Sauck, C. (2005). Microgenesis in making sense of oneself: Constructive recycling of personality inventory items. *Forum Qualitative Social Research*. Retrieved from <http://www.qualitative-research.net/fqs-texte/1-05/05-1-11-e.htm>
- Dykstra, D. (1996). Teaching introductory physics to college students. In C. Fosnot (Ed.), *Constructivism. Theory, perspectives, and practice*. New York: Teachers College Press.
- Elsässer, T. (2000). *Choreografien unterrichtlichen Lernens als Konzeptionsansatz für eine Berufsfelddidaktik*. Zollikofen: Schweizerisches Institut für Berufspädagogik (SIBP).
- Erickson, F. (1982). Classroom discourse as improvisation. In L. C. Wilkinson (Ed.), *Communicating in the classroom*. New York: Academic Press.
- Erickson, F. (1987). Transformation and school success: The politics and culture of educational achievement. *Anthropology and Education Quarterly*, 18(4), 335–356.
- Fassnacht, G. (1995). *Systematische Verhaltensbeobachtung. Eine Einführung in die Methodologie und Praxis* (3rd ed.). München: Ernst Reinhardt.
- Fend, H. (1980). *Theorie der Schule*. München: Urban und Schwarzenberg.
- Fleischer, M. (2005). *Der Beobachter dritter Ordnung: Über einen vernünftigen Konstruktivismus*. Oberhausen: ATHENA-Verlag.
- Garfinkel, H. (1967). *Studies in ethnomethodology*. Englewood Cliffs, NJ: Prentice Hall.
- Geertz, C. (2006). *The interpretation of cultures*. New York: Basic Books.
- Gergen, K. J. (1990). Die Konstruktion des Selbst im Zeitalter der Postmoderne. *Psychologische Rundschau*, 41, 191–199.
- Gergen, K. J. (1991). *The saturated self*. New York: Basic Books.
- Glaserfeld, E. v. (1997). Einführung in den radikalen Konstruktivismus. In P. Watzlawick (Ed.), *Die erfundene Wirklichkeit* (9th ed., pp. 16–38). München: Piper.
- Goffman, E. (1986). *Frame analysis: An essay on the organization of experience*. Boston: Northeastern University Press.
- Gottman, J. M., Murray, J. D., Swanson, C., Tyson, R., & Swanson, K. R. (2005). *The mathematics of marriage: Dynamic nonlinear models*. Cambridge: MIT Press.
- Habermas, J. (2006). *The theory of communicative action* (Vol. 2). Cambridge: Polity Press.
- Haken, H. (1990). *Synergetics. An introduction. Nonequilibrium phase transitions in physics, chemistry, and biology* (1st ed. 1977). Berlin: Springer.
- Haken, H., & Schiepek, G. (2006). *Synergetik in der Psychologie. Selbstorganisation verstehen und gestalten*. Göttingen: Hogrefe.
- Hammond, L. (2006). Digging deeper. Using reflective dialogue to illuminate the cultural processes inherent in science education. In L. Hammond & G. Spindler (Eds.), *Innovations in educational ethnography. Theory, methods, and results* (pp. 287–320). Mahwah, New York: Lawrence Erlbaum Associates Publishers.
- Helmke, A. (2003). *Unterrichtsqualität erfassen, bewerten, verbessern* (2nd ed.). Seelze: Kallmeyer.
- Kanitscheider, B. (1993). *Von der mechanistischen Welt zum kreativen Universum*. Darmstadt: Wissenschaftliche Buchgesellschaft.
- Kluge, S. (1999). *Empirisch begründete Typenbildung: Zur Konstruktion von Typen und Typologien in der qualitativen Sozialforschung*. Opladen: Leske und Budrich.
- Krapp, A., Prenzel, M., & Weidenmann, B. (2006). Geschichte, Gegenstandsbereich und Aufgaben der pädagogischen Psychologie. In A. Krapp & B. Weidenmann (Eds.), *Pädagogische Psychologie. Ein Lehrbuch* (Vol. 5, pp. 1–32). Weinheim: Beltz.
- Krappmann, L., & Oswald, H. (1995). *Alltag der Schulkinder. Beobachtungen und Analysen von Interaktionen und Sozialbeziehungen*. Weinheim: Juventa Verlag.
- Krummheuer, G. (1997). *Narrativität und Lernen: Mikrosoziologische Studien zur sozialen Konstitution schulischen Lernens*. Weinheim: Deutscher Studien Verlag.
- Krummheuer, G., & Naujok, N. (1999). *Grundlagen und Beispiele interpretativer Unterrichtsforschung*. Opladen: Leske + Budrich.
- Köhler, W. (1973). *The intelligence of Apes*. London: Routledge & Kegan Paul. (Original work published in German: Intelligenzprüfungen an Menschenaffen. 1921)

- Leinhardt, G. (1993). *On teaching. Advances in instructional psychology* (Vol. 4). Hillsdale: Erlbaum.
- Lichtenberg, U. (2003). *Mutter mit Kleinkind. Analyse eines Tagesverlaufs. Unveröff. Diplomarbeit*. Berlin: Technische Universität Berlin.
- Luhmann, N. (1995). *Social systems* (J. Bednarz, Trans.). Stanford, CA: Stanford University Press. (Original work published: *Soziale Systeme, Grundriss einer allgemeinen Theorie*. 1984)
- Luhmann, N. (2005a). *Einführung in die Theorie der Gesellschaft*. Heidelberg: Carl-Auer-Systeme.
- Luhmann, N. (2005b). *Konstruktivistische Perspektiven* (3rd ed.). Opladen: Westdeutscher Verlag.
- Lüders, M. (2003). *Unterricht als Sprachspiel. Eine systematische und empirische Studie zum Unterrichtsbegriff und zur Unterrichtssprache*. Bad Heilbrunn: Klinkhardt.
- Maciel, D., Branco, A. U., & Valsiner, J. (2004). Bidirectional process of knowledge construction in teacher-student transaction. In A. U. Branco & J. Valsiner (Eds.), *Communication and metacommunication in human development* (pp. 109–25). Greenwich, CT: Information Age Publishing.
- Maturana, H., & Varela, F. (1987). *The tree of knowledge: The biological roots of human understanding*. Boston: Random House.
- Mead, M. (1930). *Growing up in New Guinea: A comparative study of primitive education*. New York: W. Morrow Co.
- Metzger, W. (1986). *Gestalt-Psychologie: Ausgewählte Werke aus den Jahren 1950 bis 1982*. Frankfurt a.M.: Kramer.
- Mischel, W. (1968). *Personality and assessment*. New York: John Wiley.
- Mitscherlich, A. (1996). *Auf dem Weg zur vaterlosen Gesellschaft: Ideen zur Sozialpsychologie* (10th ed.). München: Piper.
- Mozart, W. A. (1976). *Ein Musikalischer Spass. KV 522*. Kassel: Bärenreiter-Verlag. (Original: Wien 1787)
- Oevermann, U. (2001). Zur Analyse der Struktur von sozialen Deutungsmustern. *Sozialer Sinn*, 2, 3–33.
- Oser, F., & Patry, J.-L. (1990). *Choreographien unterrichtlichen Lernens. Basismodelle des Unterrichts*. Freiburg (CH): Pädagogisches Institut der Universität Freiburg (CH).
- Oser, F., & Patry, J.-L. (1994). Choreographien unterrichtlichen Lernens. Sichtstrukturen und Basismodelle des Unterrichts: Über den Zusammenhang von Lehren und Lernen unter dem Gesichtspunkt psychologischer Lernverläufe. In R. Olechowski & B. Rollett (Eds.), *Theorie und Praxis. Aspekte empirisch-pädagogischer Forschung—quantitative und qualitative Methoden. Bericht über die 49. Tagung der Arbeitsgruppe für empirisch-pädagogische Forschung*. Frankfurt: Peter Lang.
- Oser, F. K., & Baeriswyl, F. J. (2001). Choreographies of teaching: Bridging instruction to learning. In V. Richardson (Ed.), *Aera handbook of research on teaching* (4th ed., pp. 1031–1065). Washington: American Educational Research Association.
- Oswald, H., & Krappmann, L. (2000). Phänomenologische und funktionale Vielfalt von Gewalt unter Kindern. *Praxis der Kinderpsychologie und Kinderpsychiatrie*, 49(1), 3–15.
- Pauli, C., & Reusser, K. (2003). Unterrichtsskripts im schweizerischen und im deutschen Mathematikunterricht. *Unterrichtswissenschaft*, 31(3), 238–272.
- Peirce, C. S. (1978). *Collected papers of Charles Sanders peirce* (4th ed., Vol. 1). Cambridge, MA: Harvard University Press.
- Piaget, J. (1952). *The origin of intelligence in the child* (M. Cook, Trans.). New York: International Universities Press. (Original work published in French: *Naissance de l'intelligence chez l'enfant*)
- Piaget, J. (1981). *Das Weltbild des Kindes*. Frankfurt a/M: Ullstein. (Original work published in French: *La représentation du monde chez l'enfant*. 1926)
- Piaget, J. (1988). *Education for democracy*. Paper presented at the Conference on Progressive Education, Cambridge.
- Popper, K. R. (1959). *The logic of scientific discovery*. London: Hutchinson.
- Porter, T. M. (1986). *The rise of statistical thinking 1820–1900*. Princeton, NJ: Princeton University Press.
- Quetelet, L. A. J. (1836). *Sur l'homme et le développement de ses facultés, ou essai de physique sociale*. 10th lecture (Vol. 2). Paris: Bachelier.

- Quetelet, L. A. J. (1853). *Théorie des probabilités*. Brussels: A. Jamar.
- Radford, M. (2007). Action research and the challenge of complexity. *Cambridge Journal of Education*, 37(2), 263–278.
- Raudenbush, S. W., & Bryk, A. S. (2002). *Hierarchical linear models. Applications and data analysis methods* (Vol. 2). Thousand Oaks: Sage.
- Rogoff, B. (2003). *The cultural nature of human development*. New York: Oxford University Press.
- Sato, T., Yasuda, Y., Kido, A., Arakawa, A., Mizoguchi, H., & Valsiner, J. (2007). Sampling reconsidered: Idiographic science and the analyses of personal life trajectories. In J. Valsiner & A. Rosa (Eds.), *Cambridge handbook of socio-cultural psychology* (pp. 82–106). New York: Cambridge University Press.
- Schank, R. C., & Abelson, R. P. (1977). *Scripts, plans, goals and understanding. An inquiry into human knowledge structures*. New York, Toronto, London, Sydney: John Wiley & Sons.
- Schrenk, J., & Krappmann, L. (2005). Aggressive Taktiken bei der Verfolgung eines Anerkennungswerten Ziels. Grundschulkind beschreiben ihr Vorgehen in einem Konflikt im Klassenzimmer. In I. Seiffge-Krenke (Ed.), *Aggressionsentwicklung zwischen Normalität und Pathologie* (pp. 20–40). Göttingen: Vaendehoeck & Ruprecht.
- Schön, D. (1983). *The reflective practitioner. How professionals think in action*. London: Temple Smith.
- Schütz, A. (1971). *Gesammelte Aufsätze* (German original: Das Problem der sozialen Wirklichkeit). Den Haag: Martinus Nijhoff. (Original work published 1962: Collected papers, vol. 1, The Problem of Social Reality)
- Searle, J. R. (1969). *Speech acts: An essay in the philosophy of language*. London: Cambridge University Press.
- Seidel, T. (2003). *Lehr-Lernskripts im Unterricht. Freiräume und Einschränkungen für kognitive und motivationale Lernprozesse—eine Videostudie*. Münster: Waxmann.
- Seidel, T., Prenzel, M., Duit, R., Euler, M., Geiser, H., Hoffmann, L. (2002). “Jetzt bitte alle nach vorne schauen!”—Lehr-Lernskripts im Physikunterricht und damit verbundene Bedingungen für individuelle Lernprozesse. *Unterrichtswissenschaft*, 30(1), 52–77.
- Shoda, Y., Mischel, W., & Wright, J. C. (1993). The role of situational demands and cognitive competencies in behavior organization and personality coherence. *Journal of Personality and Social Psychology*, 65(5), 1023–1035.
- Siegler, R. S., & Crowley, K. (1991). The microgenetic method. *American Psychologist*, 6(46), 606–620.
- Spindler, G., & Hammond, L. (Eds.). (2006). *Innovations in educational ethnography. Theory, methods, and results*. London: Lawrence Erlbaum.
- Stern, W. (1967). *Psychologie der frühen Kindheit: Bis zum sechsten Lebensjahr* (9th ed.). Heidelberg: Quelle und Meyer.
- Thomae, H. (1959). *Entwicklungspsychologie*. Göttingen: Hogrefe.
- Thommen, B., & Wettstein, A. (2009, accepted). Culture as the co-evolution of psychic and social systems: New perspectives on the person-environment relationship. *Culture and Psychology*.
- Tschacher, W. (1997). *Prozessgestalten*. Göttingen, Bern: Hogrefe.
- Tschacher, W., Scheier, C., & Grawe, K. (1998). Order and pattern formation in psychotherapy. *Nonlinear Dynamics, Psychology, and Life Sciences*, 2(3), 195–215.
- Turner, V. (1989). *The ritual process: Structure and anti-structure*. London: Routledge and Kegan Paul.
- Vallacher, R. R., & Nowak, A. (Eds.). (1994). The chaos in social psychology. In R. R. Vallacher & A. Nowak (Eds.), *Dynamical systems in social psychology*. San Diego, New York, Boston: Academic Press.
- Valsiner, J. (1994). Irreversibility of time and the construction of historical developmental psychology. *Mind, Culture and Activity*, 1(1–2), 25–42.
- Valsiner, J. (1997). *Culture and the development of children's action* (2nd ed.). New York: Wiley.
- Valsiner, J. (2005). General introduction: Developmental science in the making: The role of heinz werner. In J. Valsiner (Ed.), *Heinz Werner and developmental science* (pp. 1–18). New York: Kluwer Academic.

- Valsiner, J., & Sato, T. (2006). Historically structured sampling (HSS). How can psychology's methodology become turned into the reality of the historical nature of cultural psychology? In J. Straub, C. Kolbl, D. Weidemann, & B. Zielke (Eds.), *Pursuit of meaning. Advances in cultural and cross-cultural psychology* (pp. 215–252). Bielefeld: Transcript Verlag.
- van Geert, P. (1998). A dynamic systems model of basic development mechanisms: Piaget, Vygotsky, and beyond. *Psychological Review*, *105*(4), 634–677.
- van Geert, P. L. C., & Lichtwarck-Aschoff, A. (2005). A dynamic systems approach to family assessment. *European Journal of Psychological Assessment*, *21*(4), 240–248.
- Vogd, W. (2005). *Systemtheorie und rekonstruktive Sozialforschung. Eine empirische Versöhnung unterschiedlicher theoretischer Perspektiven*. Opladen: Budrich.
- Vollmer, G. (1995). *Auf der Suche nach Ordnung*. Stuttgart: Hirzel.
- von Foerster, H. (1981). Das Konstruieren einer Wirklichkeit. In P. Watzlawick (Ed.), *Die erfundene Wirklichkeit* (pp. 39–60). München: Piper.
- von Foerster, H. (1984). The construction of reality. In P. Watzlawick (Ed.), *Invented reality*. New York: Norton.
- von Foerster, H. (1988). Abbau und Aufbau. In F. B. Simon (Ed.), *Unterschiede, die Unterschiede machen* (pp. 19–33). Berlin/Heidelberg: Springer.
- Vorsmann, N. (1972). *Wege zur Unterrichtsbeobachtung und Unterrichtsforschung*. Ratingen: Henn Verlag.
- Wagner-Willi, M. (2005). *Kinder-Rituale zwischen Vorder- und Hinterbühne. Der Übergang von der Pause zum Unterricht*. Wiesbaden: VS Verlag für Sozialwissenschaften.
- Watzlawick, P. (Ed.). (2002). *Die erfundene Wirklichkeit: Wie wissen wir, was wir zu wissen glauben? Beiträge zum Konstruktivismus* (15th ed.). München: Piper.
- Wayman, J., & Stringfield, S. (2006). Data use for school improvement: School practices and research perspectives. *American Journal of Education*, *112*(4), 463–468.
- Wettstein, A. (2002). *Die Entwicklung des Messfehlerkonzeptes. Eine Begriffsgeschichte von 1830 bis zur Gegenwart*. Lizentiatsarbeit. Bern: Institut für Psychologie.
- Wettstein, A. (2006). *Aggressionsdiagnostik in schulischen Settings. Die Entwicklung eines Beobachtungssystems zur Identifikation individueller problematischer Person-Umwelt-Bezüge*. Dissertation. Bern: Institut für Psychologie.
- Wettstein, A. (2008). *Beobachtungssystem zur Analyse aggressiven Verhaltens in schulischen Settings (BASYS)*. Bern: Huber.
- Wettstein, A., & Thommen, B. (2006). *Die Entwicklung eines pädagogisch-didaktischen Coachings zur Prävention von Unterrichtsstörungen*. Unpublished manuscript.
- Whiting, B. B., & Whiting, J. W. M. (1975). *Children of six cultures: A psycho-cultural analysis*. Cambridge, MA: Harvard University Press.
- Wiggins, G., & McTighe, J. (1998). *Understanding by design*. Alexandria, VA: Association for supervision and curriculum development.
- Wittgenstein, L. (1953). *Philosophical investigations* (dt. Philosophische Untersuchungen). New York: Macmillan.

## Chapter 17

# Social Dynamics in Complex Family Contexts and its Study

Nandita Chaudhary

In cultures where life-long intimate affiliations with and closeness towards the family are highly valued and actively encouraged, family relationships can be assumed as consequential, or even central, to the psychology of individuals. These orientations have (somewhat simply) been labelled as *inter-dependent*, *collectivistic* or *dependent* as opposed to the ideology of individualism and autonomy. The term ‘dependence’ here seems pejorative, as has been the case with academic views of the reliance on others in psychology (Bowlby, 1988/1997). Dependence is visualised as a facet of early childhood, something that we need to ‘outgrow’ in order to becoming optimally adaptive adults. The objective of accomplishing individuation-separation leading to differentiation (Mahler, and other ego psychologists) is argued as a critical milestone in the personal development of any individual towards maturity. The emergence of a child from the symbiotic relationship with the caregiver is believed to be decisive for healthy psychological development. This position is inextricably linked with cultural beliefs, since developmental readiness for emergence from symbiotic relationships and the persistence of sociality can be understood in many different ways and growing out of dependence is meaningless from a systemic standpoint. Every organism needs to have a dynamic arrangement between opposing forces, in this case of dependence and independence.

Every culture has its own unique explanations and recommendations for personal autonomy and social affiliations. Perhaps the theory of separation-individuation emerges from an ideology where the separate self seems to have teleological validity—as thinkers since Goethe have noted. From this perspective, practices where inter-dependence persists for longer durations (sleeping in the same bed as the mother and father, for example) can be argued as pathological. In the study of co-sleeping for instance, it was found that normative practices across cultures vary widely; and the customs of another society can be considered as harsh or pathological from an ethnocentric point of view (Shweder, Jensen, & Goldstein, 1995). These

---

N. Chaudhary (✉)  
Department of Human Development and Childhood Studies  
Lady Irwin College, University of Delhi  
New Delhi 110001, India  
e-mail: nandita.chaudhary@gmail.com

evaluations exist despite the fact that we have not had any conclusive evidence for the universal favour for any one or other way of living, at least with reference to sleeping behaviour. Given the fact that reasonably adaptive adults develop in every system, preferring any one over and above another is unrealistic. Perhaps the closest one can come to an appraisal of sleeping patterns is to say that a particular practice may be disadvantageous for the family if it opposes the moral codes of that particular culture. For example, in American homes, the sacred status of co-sleeping for a married couple, and the earliest separation from their own children after birth, is an important moral code, which, when violated, generates much negative evaluation (Shweder et al., 1995). This contrasts with the normative sleeping patterns in other countries. In Japan for instance, a majority of children continue to co-sleep with parents well into maturity, even when space constraints were not there (Caudill & Plath, 1966).

There exist deeply divergent social orientations towards personal positions and interpersonal distance in different societies, whether it is with reference to sleeping patterns or interpersonal conversations. Since research settings are also instances of social interface, such features of cultural life are likely to impact the temporary inter-subjectivity created for the purpose of research. Mostly the researcher takes the role of questioning, observing, assessing or intervening at the site, and the participants are expected to cooperate with the procedure. How indeed are these dynamics played out on location? How does the researcher gain the confidence and cooperation of participants? Given the different orientations, perhaps the strategies that are effective in one place, may not be so in another.

Taking instances from Indian communities, both rural and urban, I shall draw from experiences with several research studies that I have witnessed and participated in, to suggest ways in which researchers have gained entry into and effectively handled encounters in the field. Most of these ideas are not new. Astute and effective strategies have been advanced in many research studies, but there have been as many (if not more) instances of indifference towards cultural detail. I see this more as a revisiting of ideas than a novel presentation.

With this objective, the chapter will focus on specific theoretical and methodological considerations needed to accommodate cultural patterns and their study. By taking specific instances from research projects I have encountered, I hope to instantiate the critical place that everyday culture has in the study of human behaviour, and how illusory it is to minimise its presence in research.

## **Ontology of the Research Encounter**

The field of cultural psychology has attempted to integrate culture as a central phenomenon in the organisation of individual and group psychology. There remains, however, much debate about the orientation, method and movement in the field. Ratner (2008) argues that cultural psychology functions at two distinct levels, with

little agreement between scientists with separate affiliations: macro-cultural psychology and micro-cultural psychology. Macro-cultural psychology accepts the larger structures of cultural experience as formative and dominant in the psychology of individuals. On the other hand, micro-cultural approaches search for dynamic orientations in interpersonal interactions rather than accepting the hegemony of larger cultural-historic structures (Ratner, 2008). It is however possible to see that there is an inevitable connection between these two levels of activity, without necessarily aligning oneself with one or other approach, since the organisation of micro-cultural processes like speech, agency and behaviour can be attributed to large cultural factors (Wetherell & Potter, 1992).

The important issue is the ontological status of social phenomena in psychology. More specifically, since research is just another instance of a social phenomenon, like medical consultations, or teacher–student interface or parent–child relationships; what is the ontological construction of the research encounter? How is research understood? How are researchers and participants aligned with each other and with the larger community? An attempt will be made to address some of the questions raised here.

### *Persistent Patterns of Self-Orientation*

In philosophical discourse, Levinas (1969) indicated that the preference granted to the individual case (as opposed to ethics, or ethical relationships with the ‘other’) was a limitation of Western thought, thereby himself granting a special significance on the quality of “otherness of things and men” (p. 78) or alterity. For a species where relationships with others facilitate survival, sustenance and well-being, the overemphasis on individuality is rather tendentious. Several cultural traditions have accord disapproval and discouragement of expressions of autonomy, and amplifying the regard for others and alterity is a fundamental learning in such settings. As many research studies have argued, these ideologies will have specific consequences for the appraisal, evaluation and promotion of specific ways of being, or pathways for developmental outcomes (Keller, 2007).

The positive valuation for autonomy and independence has found meaning in specific cultural traditions and assuming that these (importance of autonomy and independence) are universal and eternal smacks of academic parochialism (Danziger, 1997). Academic terms derive meaning from within specific world-views; in this instance of valuing individual autonomy and separation over and above otherness. Individualism as opposed to relationships with others, is fundamental and favoured only in certain cultural traditions arising from cultural historic ideologies as in the case of Puritanism and its impact on American individualism (Mead, 2001). However, otherness can also have different manifestations in different parts of the world as has been adequately demonstrated in recent research. Taking the example of Japan and India, both cultures emphasise relatedness albeit in fundamentally



different ways (Roland, 1988). Since much psychological research proceeds at the level of the individual, perhaps the cultural organisation of and orientations towards self processes has potential impact on the progress of research with any given group of people. The psychological orientation towards other people in the environment and correspondingly towards the self is not simply an outcome to be studied; this will also determine at least the extent to which self-reflection and/or inclusion of others will impinge upon the research situation and individual reactions. After all research is also an instance of a social association between two or more people (Beckstead & Valsiner, 2008). The way in which the interface is constructed, both by the researcher and the participant is thus important to reflect upon. When research is assumed to advance in circumstances independent of environmental 'noise', it is possible to arrive at conclusions that may not best reflect ground reality. This is especially critical to consider in studies where different social environments are being investigated.

Regarding autonomy and relatedness, it is not necessary for there to be an either/or manifestation, since dichotomies are created more for heuristic purpose than for practical application. The emphasis on the ideology of individualism can itself be seen as a form of collectivism since the acceptance is pan-cultural. Further, the labelling of communities as one or other has been argued as a conflation (Sinha, 2002) or as Kagitcibasi (1996) has demonstrated, autonomy can and does coexist with an orientation towards close relationships with others, and considering the issue of autonomy in situations of isolation from others, for instance, carries little meaning. Also, there can be different orientations depending upon contextual demands, and the same person can be independent and individualistic in some settings and collectivistic in others (Chaudhary, 2004).

## **Cultures and Psychology**

Cultural process and group orientations are arguably decisive for the construction of individual identity and personal conduct. There is thus sufficient ground for the inclusion of cultural processes in psychological investigations (Cole, 1996; Mistry & Saraswathi, 2003). The separation of culture and psychology has been detrimental to the comprehensive and consummate study of human conduct. Culture has proved to be an elusive quality for psychological research primarily because of the treatment of cultural processes as stimuli for the mind, which is considered as the response (Cole, 1996). A majority of methods in psychology depend on standardised procedures, experimental tasks, randomised assignments and quantification of data. As a contrast anthropological research was transacted through ethnographic study, characterised by flexibility, participation and socially acceptable techniques of study. In many ways, these two traditions were opposed. It is quite evident from recent considerations about methods, that a fruitful combination of different approaches, a strategic use of methods, and the dissolution of disciplinary boundaries and integrating multiple perspectives, borrowing from

other traditions to search for effective techniques, is the best way forward for the discipline (Cole, 1996; Jahoda, 2002; Valsiner & Rudolph, 2008; Yoshikawa, Weisner, Kalil, & Way, 2008).

### ***Cultural Organisation of Interpersonal Relationships***

From the moment the idea of a child takes birth in any society, several critical processes are set in motion. These phenomena may be personal, interpersonal and/or collective in character. In societies where individuality is idealised, a child is seen predominantly as a symbol and product of the love between two adults, or a product of love of each parent towards the child. In socially dense cultures, the processes set in motion are framed by a reality that extends well beyond individual lives and choices. The place of an individual in society is deeply foundational for the development of the sense of self. Contrasting the notion of self in Western thought, Marriott (1989) comments that “individuals are seen as indivisible, integrated, self-developing units, not normally subject to disjunction or reconstitution” (p. 17). These same characteristics that denote positive features are likely to be interpreted as arrogant, alienating and aggressive from the stance of an ideology of an interdependent or indexical self (Mistry & Saraswathi, 2003). As contrasted by Sudhir Kakar:

To members of socio-centric organic cultures, the concept of the autonomous individual, free to choose and mind his or her own business, must feel alien, a bizarre idea cutting the self off from the interdependent whole, dooming it to a life of isolation and loneliness (Kakar, 1981, p. 86).

For persons developing in cultures which value independence and referential selfways, the interdependent self is likely to be evaluated as passive, weak and unstable. Cultural process dynamically set-up contrasting perspectives, like individualism-collectivism to generate the positioning of individuals and groups towards each other, as in the instance of socially created groups like ‘us’ and ‘them’ (Berreby, 2005). These contrasting orientations have been repeatedly supported by research evidence and scholarly literature in cross-cultural psychology (Greenfield, Keller, Fulgini, & Maynard, 2003). The consequences for methodological procedures have been somewhat sparse in comparison. What are the adjustments in choice of methods or more specifically, tools and techniques of study that would be meaningful for different populations? The trouble is that if one creates a method that is applicable in different settings, it is likely to be differently understood. These differences can result from consequence of “semantic intuitions” (Shweder, 1984, p. 34), personal orientations, meaning-making and familiarity with the procedure. On the other hand if one assumes a culturally appropriate way of investigating phenomena, then comparisons may become elusive.

Children’s developmental expressions are often the object of study in order to explore the manifestation of cultural differences and their antecedents. After much effort, researchers assemble methods that appear to be plausible in the different settings. Some domains of study are far more prioritised than others. For instance, the

times ‘When did the child start walking independently’ would be encountered far more frequently than an item on ‘When did the child start recognising an uncle in the family’. As an example, whether a behaviour will be labelled as ‘compliance’ or ‘conformity’ or ‘obedience’ demonstrates subtle (and not so subtle) shifts in the framing of everyday conduct of children (Tomar, 2009<sup>1</sup>). It is important to keep a watch on the research dynamics in order to assure the fair transfer of methods, analysis and interpretation. Persistent attention needs to be given to constraints and conditions to facilitate justified interpretations, since the framing of phenomena by the local meaning systems (D’Andrade, 1984).

### ***Transacting Research Tasks in the Field in India***

In my experience there are some critical features of the research process with Indian participants that can impinge upon the study in significant ways. I will attempt to present examples of these and also demonstrate how these may even interfere with the phenomenon under investigation.

- The local understanding of the ‘purpose’ of any study, ‘what are you doing here, and what do you want from us?’
- The attention and engagement of the local community and their involvement in the procedure: clustering and prompting by others and the inability to understand the requirement for private and individual opinion
- The construction of assessment procedures for children’s development, ‘how will they know unless we tell them?’
- The social dynamics of children’s conduct, laughter, play and teasing during testing
- Why mine and why not the neighbour’s child? The local perplexity with sampling procedures
- Standard play materials and their unfamiliarity, mirrors, dolls and other examples
- Challenges of rating opinion: ‘You write what you like, you know better than I do’
- Modifications of instructions to children

‘What are you doing here and what do you want from us?’

Having conducted research with Indian families and communities for the last three decades, I have found that one of the most challenging tasks is to establish an acceptable understanding of what we are doing. Usually researchers are faced with questions about their personal lives, like marital status, number of children, or salary (“You are getting money for roaming around like this?” was a frequent query). Once having established a reasonable description of social status, the researcher is

---

<sup>1</sup> In this Masters dissertation, the author debated on the use of the term ‘compliance’ in the study of Indian children’s ability to follow instructions and arrived at ‘conformity’ as a more culturally appropriate label than the more prevalent notion of ‘compliance’ borrowed from Western studies.

then faced with explaining the purpose of the study. I feel strongly that the participants need to have a reasonable idea of what you are doing with them or their child. Translating the objectives of the study can be trying, especially when the notion of research is not already known, where levels of education are low and the community does not have an idea about the purpose of research.

This challenge is obviously greater in rural communities where access to schooling is lower and also very different from urban schooling. Here, the sight of women carrying equipment, going from home to home or to the local school, is not usual. Children of all ages usually form a procession behind the team, passing comments, teasing and requesting to be photographed (Fig. 17.1 around here).

Such encounters are to be handled delicately since it can become unmanageable on occasion. There is usually so much excitement in the village as groups of young children gather at a self-conscious distance to take a look at the team. The family usually begins to feel that an exceptional social visit is in progress for which one has to perhaps act accordingly. In such settings, it is essential to place a particular attention to the procedure of providing adequate and comprehensible overview of the work and its purpose. We need to highlight the ethical requirements of any research in the terminology that the local community can grasp. Our experience has been that this is a challenging, but not impossible task.

It is still likely that the entry can ‘interfere’ with ‘play as you do’ with the child, or ‘please go on with what you were doing, we just want to watch what is going on’.



Fig. 17.1 Curious children, eager to be photographed!

Such instructions are strange, and participants handle them in different ways, but I can say with reasonable confidence, that they DO NOT 'play with the child as they usually do' or carry on with their tasks as they would on an ordinary day, because this day is NOT ordinary! Just as a researcher would not conduct questioning in an interview as she would in a 'natural' setting. Any research encounter is an example of a dramatised encounter between the participant and the researcher, and needs to be recognised as such. The arrival of a research team, armed with video cameras and other equipment to ensure standard procedure, can actually be quite a special occasion, and this fact is likely to impinge upon the conduct or performance of the person, however young. Further, it is likely to impede ongoing interactions if that is the target of the study and also impact a person's responses to questions, if that is the method being used. In any case, how different the research setting is from the usual goings on the family must be recognised as a critical factor in influencing the degree of comfort of the participants. We cannot assume that these do not make a difference. Perhaps, the greater the distance between the 'culture of origin' and the 'culture of application' of any method, the more profound its interference or intrusiveness. Of course this distance can also be used productively in research since it results in greater sensitivity to the practices and views on account of the fact that they are unfamiliar. The essential thing is thus to be aware of these divergences and open them for discussion. There is also the factor of social desirability as being an important feature since there is an urge to present oneself in a culturally favoured manner, and that in and of itself is a reflection of cultural priorities.

Clustering and prompting by others, the puzzlement about individual opinion or performance.

In social settings that are guided by connectedness with other people and sociality, attempts to gather exclusively individual reaction or opinion is somewhat puzzling for the participants in research. The naive understanding of questions asked of others is to find answers that one does not know, particularly among people who have not been to school. In this case, it is clearly not the case (that the researcher is believed to ask something that they do not know), since the researchers are almost always better educated than the participants. Why else? The other option seems to be to 'test' the person's knowledge, as is done in school testing. The fact that a study attempts to arrive at one person's opinion in order to obtain an understanding of the views of a 'community' or population (in the statistical sense) does not itself carry meaning for many research participants. This is in dissonance with local social dynamics, and a person can feel rather embarrassed to be isolated for questioning while others watch and listen to what they have to say, especially if this is proceeding in the presence of older people.

If a person asks a question, usually the belief is that you want to know the answer. Asking for the sake of accessing one individual's knowledge of a certain phenomenon is rather unusual and unfamiliar, especially in rural communities. In the presentation of syllogisms to Uzbek peasants, for instance, Luria (1976) found that syllogisms were not comprehended and the respondents were unable to apply the condition "There are no camels in Germany" (p. 121) to the questions about whether there were camels in one particular city. The presentation of a theoretical

situation was unfamiliar to the peasants whose experiences were based primarily in practical observations rather than classroom dialogue. Usually persons are not alone when they are being interviewed or assessed, and even if they are, potential responses can also be silenced by fear of offending the memory or social standing of another. In such an event, the person will look for social support or affirmation from others around. This social referencing is commonly unacceptable or at least unfamiliar in psychological study that derives from the ideology of individualism. Additionally, in gatherings where there are socially senior persons (older or better educated), a person will hesitate to articulate personal opinion.

Interview responses are not simply explorations of a priori knowledge about phenomena, but are usually interactive reconstructions of opinion on the spot even for individuals, as we found during interviews of the concept of '*Mamta*', a Hindi term meaning 'mother's love' for a child in common usage (Chaudhary & Bhargava, 2006). In this case, requesting or asserting singular opinion can lead to feelings of discomfort and distaste for the research requirements. I have watched such transactions, and found that many researchers simply note down responses in the questionnaire even if this comes from others. Sometimes, personal opinion is adjudged from the mumblings of a respondent by giving several options to the question and seeing what the person somewhat agrees with. In the Social Axioms Scale, for example, we discovered a very high frequency of 'no opinion' in the pilot testing of the scale with Indian college students. Soon we discovered, the 'no opinion' was a safe category for respondents to enter all kinds of opinions that were later investigated through interviews. 'No opinion' was not just no declared direction of opinion, but a host of possible options: I am not sure, sometimes yes and sometimes no, or some people are and some not, or I really don't understand this item very well'! (Chaudhary, 2005). At other times, similar appearing responses can be markedly different in orientation. For instance, when Kaura (2008) first tried the FES (Moos & Moos, 1994) with her respondents, she placed the item 'We have very little privacy in our home' before adolescents and then their parents, she found both generations agreed with the item (Yes or No options). At this point, she marked the response, but sensed that there was something worth exploring here. She then introduced this as an interview question and found an opposing orientation of the answer 'Yes' that was the same for both parents and adolescents. 'Yes', the adolescents said with consternation and discussed how uncomfortable they sometimes felt. The parents communicated with pride, 'Of course! We do not have any privacy in our home, we all get along very well, and do things together'. In case Kaura had not entered further into the dialogue, this rather precious entry into the understanding of generational differences among these urban families would have been lost, and the results of the questionnaire would have shown an agreement between the two generations of respective parents and their children, indicating a higher consonance. However, these details do not usually enter into the data since there is no way of entering multiple opinions in single forms, or to go beyond the category of yes/no to investigate further.

The individual interview or questionnaire is fundamentally unfamiliar tools except in settings where it is possible to arrange private meetings without hesitation,

and where the participant is familiar with the notion of research and the purpose of gathering individual opinion. The rural family setting with several members is not the best place for such a task. In such settings, group discussions have proved to be an effective supplement to other techniques of data collection.

In the case where a child's conduct has to be assessed, similar 'interjections' by others is a regular feature. When separation is requested, the members take it to imply some sort of examination. We have sometimes falsely asserted that we are not 'testing' the child, and just let the child do what he or she wants; but I now wondered if that was a justified description of a task. Even if the mother accedes to the procedure by keeping a studied distance in such settings, you will have a grandmother or other member enter at some point and make a blatant intervention that may be unacceptable to the procedure. Insistence on private, uninterrupted and individual responses can lead to diffidence and suspicion of the intentions of the researcher. It is thus very difficult (if not impossible) to attain similar conditions for conducting such procedures in Indian homes, and comparisons made on the basis of such studies must attempt to integrate these observations into the analysis, interpretation and reporting.

'How will he know unless we tell him?'

In a recent study of mirror self recognition among Indian children,<sup>2</sup> we followed a cross-sequential design to investigate the emergence of mirror self recognition using the rouge task for 6 weeks in a row (1-day in the week). The equipment was carried to each family in rural and urban homes (N=80). One of the important instructions to the family members was not to 'practice' the task with the child over the week before the next recording. I particularly remember one grandmother's response in this regard. She looked rather disconcerted at this instruction and said to us simply, 'How will he know if we don't tell him?'

Similar problems are also confronted when adults sit with children during assessments. As far back as 1978, when I used the Bayley's tasks for infant developmental assessment, mothers were often annoyed by the insistence on not intervening in the child's successful completion of simple tasks. They could just not understand why we were insisting that they should not help the child. After all, that is the most natural reaction that they have, namely to assist the child with a difficult task.<sup>3</sup> There are many occasions when the standard procedure was violated and the task was omitted from the analysis, even when it is likely that the child could perform the same on his or her own (Sindhu, 1978). How do such social dynamics play out in the representation of ground reality? Perhaps it could work either way depending on the researchers' positioning, openness and perspective. This position of a child's performance in testing is at odds with the child's learning in reality. In any case, perhaps what is clear is that it is not without impact, and if assessments are being done, specific attention to these eventualities must be accorded.

<sup>2</sup> This research was conducted with funds from the German Research Council in collaboration with Prof. Heidi Keller and Joscha Kaertner, University of Osnabrueck, Germany.

<sup>3</sup> This is a process so well understood in Vygotsky's notion of the Zone of Proximal Development, but does not find space in standardised testing.

## Talk, Play and Teasing of the Target Child

In studies where children are involved especially, the local construction of childhood is another feature to consider. As in rural Indian (and also to some extent in urban homes) families, the child is believed to belong to the family and community. Anyone can interact with, play with or carry the child around. Homes are not the bounded spaces that urban neighbourhoods are familiar with. Oftentimes, even young children are found to be playing on the street or with another family. Requests to bring the child or target person into the home for a 'special' personal interaction is an imposition on the free-flowing spaces in villages. Thus even when we are in a child's home, the restriction of the child to a given space would amount to an alteration of the clause of 'naturalistic conditions'. There is no denying that dyadic interactions exclusive of social supervision and intervention are hard to structure and difficult to explain. It is effective in such environments to conduct observations in open spaces where children are much more likely to be comfortable and free to move around as they usually do, despite the fact that data collection would take longer.

In the study of mirror self recognition mentioned earlier, we found that there were some households in which the child's initial reactions to the mirror caused a lot of response from others. For instance, when the child peered behind the mirror to search for the elusive playmate, the audience (otherwise requested not to intervene) would break into laughter, sometimes commenting on the child teasingly. Children were to a lesser or greater extent conscious of these dynamics (Gupta, Shukla, & Chaudhary, 2008). Here, we found it useful to wait until the family was reasonably comfortable with the equipment before starting the procedure, to ensure an appropriate assessment of the child's reactions to the mirror.

## The Local Perplexity with Sampling Procedures

Sample and population are preliminary concepts in research and statistical analysis. The research participants are most often only the limited group whom we access in order to speak about a larger reality, the population. The notion of the average is central (and sacred) to the process of quantification (Valsiner & Rudolph, 2008). Sampling strategies are critical to this endeavour, and researchers struggle hard to find ways of accessing reasonably representative or 'illustrative' participants (Chaudhary, 2004). However, even with our best intentions, sampling is an unfathomable phenomenon for the community, and sometimes even for academic study, as has been demonstrated by Valsiner and Sato (2006) since procedures of random sampling from a population overlooks the dimension of person-environment interface critical to the study of a cultural psychology. 'Why did you pick my child'? Parents and family members want to know about the reasons why such a choice was made over another family in the neighbourhood. Answering them with a reply saying that it is 'incidental' or random does not go down well. In such matters, it has worked to sample people for the objective of socio-cultural similar-



ity. We attempted also to proceed through sampling using the strategy of ‘contact sampling’ (Tuli & Chaudhary, 2008), where entry into and confirmation about the research and the researchers can be provided through a contact person, known by the community (a teacher, respected member, or doctor), provides the researcher with a legitimate entry and authenticity in communities where informal social verification is more effective than identity cards which can be forged, or cannot be read by many. This is perhaps better than giving the participants extenuate reasons for the selection, since they can mislead their understanding of the objectives of the research. Another strategy that has worked well in cultural research is conducting the procedures with all children who are keen to participate, with communities in Cameroon for instance (H. Keller, personal communication, September 12, 2008). In this manner, the research procedure is seen as a friendly game for children rather than a testing of a selected few.

### **‘Standard’ Materials**

The use of standard play or testing materials for assessing children’s orientation, performance or development is common in research, especially with children. Much effort is invested in making these materials familiar and friendly to the cultural environment. I wish to suggest here, that however familiar a toy may be, the appearance of a material for manipulation, task completion or spontaneous play, can never mean the same thing in different environments, especially when economic status is considered. For a child who has little access to play material outside of household objects, the entry of a doll to play with and talk about and to do things with, will have an element of novelty that must have consequences on the child’s manifested reactions, whether it makes the child reticent or exuberant is a matter of individual reaction, and hard to determine a priori. It can work either way. It is outside of the scope of research to ensure that children have equal or even comparable access to play material. However, attempt can be made to ensure that children are comfortable with the material chosen.

In the mirror self recognition study in rural Indian communities, the researchers would carry the standard-sized mirror on their person through the narrow streets from home to home. Placing the mirror on the ground at the child’s home was often seen to be the child’s first encounter with a mirror of this size. The curiosity value of this encounter can certainly be argued as important if not decisive in determining a child’s reactions to images of the self. In the analysis of data, we found that familiarity with the mirror did not have an effect on performance within the study since there was so specific rise in children’s performance over the 6 weeks over and above expected age changes (Gupta et al., 2008). Such clarifications are important to make through the process of data analysis to ensure that the element of unfamiliarity has been evaluated appropriately. In the data analysis does not proceed in a manner that is sensitive to the cultural reality and situational details, the research findings can be somewhat superficial. In this study, for instance, care was taken to ensure that the element of familiarity with the mirror was analysed by looking at the performance

of the children who had no mirrors in their homes to see if repeated exposure to the mirror significantly improved their performance in an unexpected direction.

Similarly, the experiences with a stuffed toy in another study<sup>4</sup> where a child's empathic reactions were being observed when the arm of the toy the researcher was playing with came off (staged) to generate empathy and its manifestation in young children, provided an interesting challenge. During pre-testing the material, it was found that several children reacted with fear to stuffed toys as well as dolls. This was especially true of the eyes of the selected toys. Even after many trials, the material did generate fearful reactions among children in the pre-testing phase. We had to abandon many choices of locally available toys and dolls before we could arrive at one that did not seem scary for the children. How does research recover from these divergences in social settings? One important point is an extended and repeated pre-testing procedure, as in the above study, where many toys (despite having been purchased from the local markets, another important clause) were rejected since the children were afraid of them. Only those equipment that do not cause discomfort to the child should be included, and there is no way of knowing this unless these are thoroughly tried out in the pre-testing phase.

In an urban home, even within India, toys are common, and sometimes even plentiful. This familiarity with the idea of playing with something outside of real life objects is special and different in different cultures (see Edwards, 2005) where it has even been linked to the presence or absence of those particular activities in the real lives of children. For instance, the appearance of dolls to care for is more frequently among societies where care of younger children is not a routine expectation for older ones.

This brings me to the point about familiarity with material and its likely impact on assessments of children. It is important that we conduct research, analyse data and publish findings with the clause explaining the different orientations of communities and their children towards play materials, since otherwise we would (always) place the less familiar communities at a disadvantage.

## **Challenges of Rating One's Opinion**

I have written about the challenges of rating scales in several other places as well (Chaudhary, 2004, 2005), however, some points are important to repeat to complete the ideas introduced here. Techniques that are smoothly transacted in literate cultures where answering questions to gather opinion is commonplace are fiercely inappropriate among unschooled communities. Some difficulties I have encountered over the years include meanings of words, and translations of culturally embedded concepts, and rating one's opinion on a scale. I have also begun to realise that the asking of questions in the field are also not fully understood. The participant usually

---

<sup>4</sup> This study was funded by the German Research Council in collaboration with Prof. Heidi Keller, University of Osnabrueck, Germany.

fails to grasp the sense of eliciting ‘individual’ opinion as mentioned earlier. Mothers are often happy to abjure the responsibility for the final opinion on something. Further, if the task is a bit more challenging, namely to locate the appropriate point on the scaling of opinion, for example, ‘Old people are stubborn and biased’, from disagree to agree, the task becomes even more unfamiliar, and we have repeatedly struggled with the scaling of opinion. Many mothers try to avoid the task, some others have said to the researcher, ‘you know better, why don’t you fill up the answer?’ Others have simply asked a child or other adult to answer the question. Often a question needs to be reworded and explained to such an extent that the task itself is perhaps transformed.

## **Modifications of Instructions to Children**

As part of a longitudinal study of parenting beliefs and children’s development, 40 Delhi families were part of a cross-cultural study.<sup>5</sup> The cultural settings were set up to the comparisons of cultures with different socialisation strategies in order to establish links between beliefs, early experiences and children’s development. The purpose was to investigate selected child outcomes at 19 months, 3 years and 4 years by following up the same group of 40 children who had been selected at 3 months of age. In the first round of field work, the children were visited to gather data about socio-demographic information, socialisation goals and maternal-child interactions. The families were then followed up at each of the given ages and studied for different dimensions of their development (like language, empathy, theory of mind, deception, inhibitory control and autobiographical memory) with the purpose of linking these with the socialisation goals and also making cross-cultural comparisons. One of the dimensions of children’s behaviour at 19 months included the study of compliance in children. This task required the mother, as instructed by the researcher) to ask the child to perform three tasks, namely to hand over a familiar object to her, to do the same with the researcher, and to take a familiar object from the present location to another room. Mothers in all the settings were given the same guidelines for instructing the child with simple requests. The responses in this report refer to the findings from the third task (to take an object from one room to another) for 14 German and 16 Indian families (Bhargava & Chaudhary, 2006).

The idea for this analysis came to us when we were viewing the videos. In the Indian families, it was noticed that the mothers consistently made subtle (and not so subtle) modifications in the instructions despite repeated reminders to keep it simple. The mothers and other adults in the room treated the compliance task with seriousness and were eager for the children to ‘obey’ in the presence of the researcher, since it is considered an important social learning. Perhaps one could also argue, that there was a greater cultural value placed on compliance in the Indian family in comparison with the German.

---

<sup>5</sup> Research study conducted in collaboration with Prof. Heidi Keller, University of Osnabrück, funded by the German Research Council.

Using the transcripts from the observations, we divided the instructions of the adults into four categories, namely, standard (as described in the task presentation, take familiar object O to another room), Modification-person (take O to a person sitting in another room), Modification-object (take O and put it next to X, a known object in another room), and Mixed (combination of the two modifications). We found similar results regarding the number of instructions given by adults in both settings, a total of 180 instructions (Mean=11.3) in Indian families and 167 (Mean=11.9) in German families. Figure 17.2 demonstrates the clear difference that we found regarding the strategies used by adults to get children to complete a given task. Perhaps the presence of many adults in the home as well as the importance placed on other people in the home (whether these were grandparents, siblings or helpers) was clearly demonstrated in this data set.

The findings were unambiguous, German mothers used standard instructions and object related modifications (go put this object on the table in the other room) significantly more frequently than Indian mothers (and adults) who tended to modify the instructions by referring to people in order to encourage task completion (Chi square =137.25,  $p < .001$ ). Another interesting detail that emerged from the transcripts was the mean number of encouragements provided to the child. In Germany there were a total of 132 encouragements (Mean=9.4) and in India, the same was 306 (Mean=19.1). In the quality of encouragements, it was found that there are clear differences between German and Indian adults. Whereas Indians tend to prompt the child more often, Germans frequently make it into a game or request the child to complete the task.

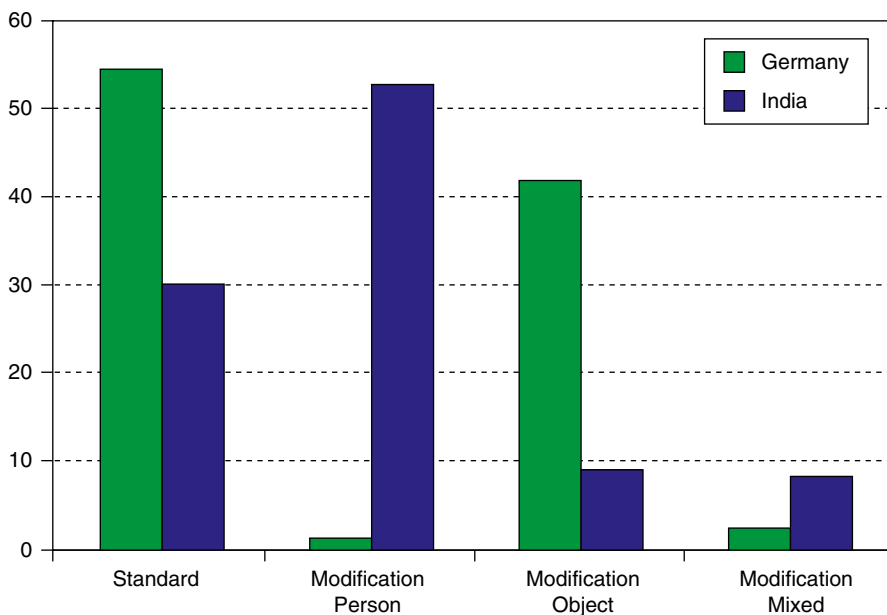

**Fig. 17.2** Data of percentages of adult instructions to children on compliance task in India and Germany

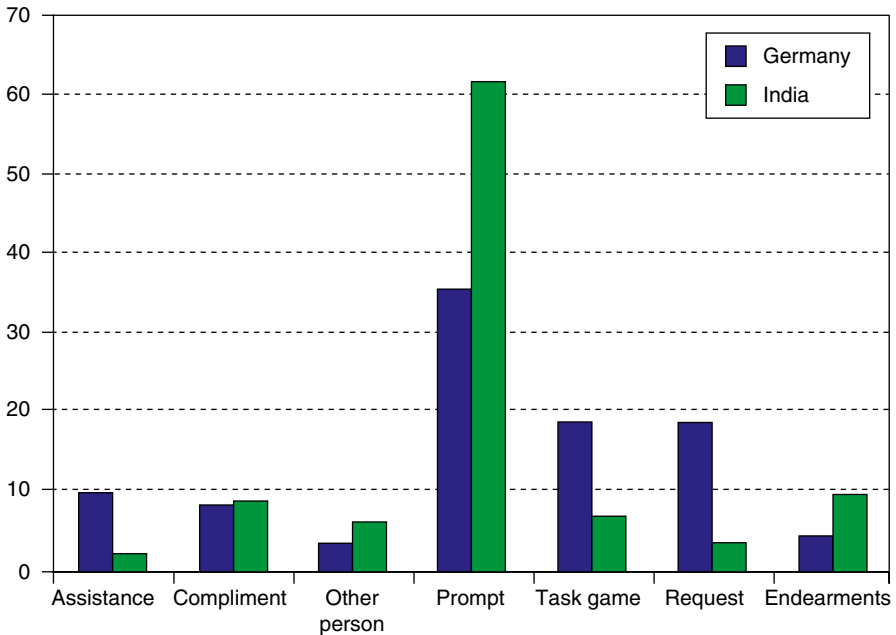

**Fig. 17.3** Types of encouragements (percentages) provided by Indian and German adults to children during the compliance task

Another dramatic difference in the two settings had to do with the number of ‘others’ that were present during the data collection. A head count of the number of people around indicated the following contrast. In the Indian sample, there were a total of 55 ‘others’ who interacted with the child during the sessions in all the families. Of these, there were 32 fathers, 5 grandmothers, 4 grandfathers, 12 helpers and 2 siblings. Not surprisingly, in German homes, there were only 2 fathers who intervened with suggestions or instructions to the child. This difference is profound and perhaps not without impact on the research situation. Interestingly, the findings of the study indicate towards a significantly higher rate of compliance in Indian children in comparison with the German.

Again this reflects differences between cultures in the conditions under which a task is completed. It is true that the modifications are an integral part of the context and children’s socialisation. The moot point is that research investigations need to be alert to the process of data collection and not just the outcome to have a comprehensive understanding of the social dynamics.

### ***Approaches to the Research: Experiments, Ethnography and Observation***

Experiments for investigating cultural differences in cognition have had discrepant conclusions from different disciplines. For instance, Psychology experiments

have found that adults in pre-literate societies fail to perform at expected levels, whereas anthropologists have discovered many advanced methods of reasoning among pre-technological societies. These differences appear primarily on account of the methodological divergence between the two disciplines, and the specific difficulties related to the use of the experiment in cultures where carrying experimental tools to maintain 'identical' testing materials is in fact a misplaced exercise since it is comparability and not sameness that needs to proceed (Scribner, 1976). The response of an individual to any experimental situation is determined not simply by the task set up by the researcher, but also by the respondent's appraisal of the task. Glick (cited in Scribner, 1976) has proved that the subject's appraisal and evaluation of the 'purpose' of a task is critical to their performance.

Isn't all experimental instantiation of human behaviour illustrative of a 'supplement' in the Derridean sense? That it is always secondary to, a substitute for, or a reconstruction of a natural or original phenomenon, and NOT the phenomenon itself (Derrida & Spivak, 1976). If it is, then we need to recognise that experimental and to some extent even observational study is at best a substitute for the real thing and not the real thing itself. When an attempt is made to go beyond the experiment and continue to ask questions from everyday experiences of respondents to investigate practical understanding, intercultural differences in remembering items were greatly reduced when the task involved strategies for recall that were 'normal' for the given population (Cole, 1996). For instance, remembering randomly arranged objects versus recalling objects with some culturally bound connectivity. After reviewing a range of studies in Psychology and Anthropology, Scribner (1976) argues for a range of research strategies to investigate phenomena in cultural contexts ranging from ethnographic study to quasi experimental studies since in her opinion, "Field work gives the research access to the natural phenomenon" (p. 321).

When studies are conducted in different cultures, many local decisions need to be taken. One important step is to have culturally familiar equipment, preferably purchased from local markets. Another strategy that we have found to be very productive is to have local research teams scrutinise the materials and methods, and also participate in the analysis and interpretation and dissemination of data so that one can arrive at representative and reasonable conclusions from the study of children, families and communities.

### ***The Second Person Approach to Research***

I want to introduce the notion of first person, second person and third person approaches to the study of human beings to explore the possible ways in which intersubjectivity in research (between the researcher and participant) can be addressed (Rao, 2008). By and large, Psychological research in the past has progressed from a third person stance, that the researcher maintains neutrality, objectivity and distance from the subject, respondent or participant in a study. However, in other traditions, in more recent innovations in Psychology (Hermans's self-confrontation method, 2001, Dialogical self theory, for instance) and in specific traditions even in the West

(Psychoanalysis, for example), the recognition of the study of the self (first person approach) is recognised and even recommended as a procedure in clinical study (as is the analysis of one's own dreams in Psychoanalytic study). I shall focus on the use of second person methodology as a possible strategy for integrating the peculiarity of the human condition, namely, the feature of being a subject to oneself, and the inevitability of being 'human' as a researcher.

The second person approach has certain important features (Reddy, 2008) that need discussion. This approach does not accept the 'gap' in the understanding of another person's mind, allowing the researcher to utilise the interactive resources that are invoked in everyday conduct. The assumption is that through "active, engaged perception" (p. 27), we are able to access a reasonable understanding about other people, here, the participants in research. Traditionally, researchers are trained to minimise these perspectives. Further, this approach acknowledges the emotional engagement of people in research (as in other social settings), not constructing the research experience simply as an opportunity to 'gather' information from another person. Research is seen as a social interaction, with procedures and rules and objectives, but a social situation, first and foremost. This way the transformations in the researcher are also possible to address without violating any fundamental principle. The second person approach, in my understanding, acknowledges the 'human' element in the researcher and the participant.



**Fig. 17.4** A typical scene, the clustering of onlookers during field work

## Conclusions

The attempt in research to minimise contextual influences and to create methods that are assumed to be applicable in all settings is a frequent objective in studies of cultural differences. Standard research studies attempt to eliminate contextual influences to arrive at an assessment of behaviour independent of “familial, cultural and societal” bias (Beckstead & Valsiner, 2008, p. 1). However, people generally rely on familiar cues in situations that are unusual. This disparity produces an interesting problem in research, and one that may be argued as profoundly influencing the outcome of a study. Rather than dismissing such encounters, it becomes essential for researchers to inform themselves about local realities and culturally familiar patterns of behaviour so that meaningful research can be initiated. The discipline of cultural psychology has acknowledged the definition of culture as meaning systems, symbols and interactions that mediate the interpretation of experiences (D’Andrade, 1984); and human psyche as “social in its ontogeny and constructive in its microgenesis” (Valsiner & Sato, 2006, p. 216). Much recent research in cultural psychology has moved beyond traditional limitations to look into the lives of real people from a wide-angle lens, thereby reaching forward into newer ways of understanding people’s lives.

Regarding the positioning of a researcher, it is fascinating to read the distinct avoidance of personal experiences in official accounts of any research study, this is not usually done. This is despite the fact that such versions provide researchers and audience with deep insights about the progress of research on the ground (Gunther, 1998). These stories are not usually told to others, despite the fact that they may be deeply impacting the individual researcher (Anandalakshmy, Chaudhary, & Sharma, 2008). Why is there a resistance or reticence among researchers to write about their subjective experiences? Is it not true that we have to rely on the honesty of a researcher even when a mathematical finding is being reported? Why is the feeling of inadequacy intensified where qualitative procedures and personal experiences are concerned? In one conference (here the names are not being disclosed to protect the identity of the concerned individuals) where we were presenting a paper on ‘motherhood’ in India using qualitative methodology and women’s narratives, the adjective ‘seductive’ was used to comment on the presentation. Since the person was an invited expert, with obvious affiliations to quantitative traditions in research, we maintained our silence.<sup>6</sup> But I recall that the young researcher was deeply shaken by the comment. For her, the implication was that she had somehow made a fallacious or unsound presentation of what she had spent months to unravel. Clearly the suggestion is that qualitative research study is attractive, enticing, but also potentially misleading! Perhaps there may have been some scope for improvement in the paper, but I am certain that there were no false claims there. This is the sort of reaction that clearly destabilises young researchers presenting

---

<sup>6</sup> I am hoping that the readers take my word for this account since I am not providing a scientific third person reference, but a first person account!



months and years of hard work with a conviction of purpose, attempting to integrate cultural phenomena with academic study. We also need to recognise that qualitative approaches also need consolidation and rigour; but the adjective of ‘seductive’ implied something very different from what could have been a legitimate criticism. I just consoled the presenter by saying that it meant that her presentation was very effective (which I thought it was)! In such comments, there is a clear indication that research that takes this sort of descriptive stance with a closer perspective, is second rate, and thus not worthy of scholarly attention. First person accounts of researchers are clearly considered to be ‘unscientific’ by the majority. Regarding second person approaches and the use of empathic engagement with the participant (Reddy, 2008), the research encounter is treated as a social event, thereby allowing the entry of empathic and interpersonal inter-subjectivity to arrive at assessments and meaning of events. This shift in position, the closing on the research event, would necessarily entail becoming involved with ideas and people in a manner that would inform rather than bias a researcher. Additionally, using techniques like data triangulation (Weisner, 2005), multiple methods for study (Yoshikawa et al., 2008), using different strategies (see Gould, 2003, for an excellent essay), being open to inter-disciplinary dialogue (Spivak, 2004) and relying actively on field work and quasi-experimental studies (Scribner, 1976), are some of the ways to bring research efforts closer to the lives of people they wish to speak about.

Thus, some of the simple ways of engaging with people and ideas can be achieved by keeping intuitive reactions intact and engaging with participants as partners in and not objects of research. Creating and following mythical rituals (like random sampling, or standardised testing) over and above the personal reality that is critical to meaningful social experiences, provides research with a sacred status; but it also distances science from everyday life, consequently defeating the very purpose for which the efforts have been undertaken!

**Acknowledgements** I would like to acknowledge the contributions made by Prof. Heidi Keller (University of Osnabrueck, Germany) and Prof. Jaan Valsiner (Clark University Worcester, USA) for their perceptive and pertinent reactions to earlier versions of this chapter. These comments helped me to become self-conscious of my occasional imprudence in discussing issues of theory and method.

## References

- Anandalakshmy, A., Sharma, N., & Chaudhary, N. (Eds.). (2008). *Constructing research methods: Insights from the field*. New Delhi: Sage.
- Beckstead, Z., & Valsiner, J. (2008, August 28). *The dialogical self of the researcher-as-person who enters into a dialogue with the dialogical self of the research participant-as-person*. Paper presented at the 5th International Conference on Dialogical Self, Symposium titled, Dialogical selves in developmental research practice, Queens College, Cambridge, UK.
- Berreby, D. (2005). *Us and them: Understanding our tribal minds*. New York: Little, Brown and Company.
- Bhargava P., & Chaudhary, N. (2006, July 11–15). *Cultural reconstruction of methods in Indian families*. Paper presented at the International conference of the IACCP, Spetses, Greece.

- Bowlby, J. (1988/1997). *A secure base: Clinical applications of attachment theory*. New York: Routledge.
- Caudill, W., & Plath, D. W. (1966). Who sleeps by whom? Parent-child involvement in urban Japanese families. *Psychiatry*, 29(2), 344–366.
- Chaudhary, N. (2004). *Listening to culture: Constructing reality from everyday talk*. New Delhi: Sage.
- Chaudhary, N. (2005). Researching communities: Travails of working with Indian communities. *Cross-cultural Psychology Bulletin. International Association for Cross-cultural Psychology*, 43(4), 5–13.
- Chaudhary, N., & Bhargava, P. (2006). Mamta: The transformation of meaning in everyday usage. *Contributions to Indian Sociology*, 40(3), 343–375.
- Cole, M. (1996). *Cultural psychology: A once and future discipline*. Cambridge, MA: Belknap/Harvard.
- D'Andrade, R. G. (1984). Cultural meaning systems. In R. A. Shweder & R. A. LeVine (Eds.), *Culture theory: Essays on mind, self and emotion* (pp 88–122). Cambridge, MA: Cambridge University Press.
- Danziger, K. (1997). *Naming the mind: How psychology found its language*. London: Sage.
- Derrida, J., & Spivak, G. C. (1976). *Grammatology* (G. C. Spivak, Trans.). Baltimore: Johns Hopkins University Press.
- Edwards, C. P. (2005). *Children's play in cross-cultural perspective: A new look at the six cultures study*. Faculty publications, Department of Family and Consumer Sciences, University of Nebraska.
- Gould, S. J. (2003). *The fox, the hedgehog and the magister's pox*. New York: Three rivers press.
- Greenfield, P. M., Keller, H., Fulgini, A., & Maynard, A. (2003). Cultural pathways through universal development. *Annual Review of Psychology*, 54, 461–490.
- Gunther, I. A. (1998). Contacting subjects: The untold story. *Culture and Psychology*, 4(1), 65–74.
- Gupta, D., Shukla, S., & Chaudhary, N. (2008, July). *Intra-cultural variation in mirror-self-recognition among young Indian children*. Paper presented at International conference of the International Association for Cross-cultural Psychology, Bremen, Germany.
- Hermans, H. H. (2001). The dialogical self: Towards a theory of cultural and personal positioning. *Culture and Psychology*, 7(3), 243–281.
- Jahoda, G. (2002). The shifting sands of 'culture'. In P. Boski, F. J. R. Van der Vijver, & A. M. Chodynicka (Eds.), *New directions in cross-cultural psychology* (pp. 91–106). Warsaw: Polish Psychological Association.
- Kagitcibasi, C. (1996). The autonomous—relational self: A new synthesis. *European Psychologist*, 1(3), 180–186.
- Kakar, S. (1981). *The inner world: A psycho-analytic study of childhood and society in India*. Delhi, India: Oxford University Press.
- Kaura, I. (2008). Making sense of what they say. In S. Anandalakshmy, N. Chaudhary, & N. Sharma (Eds.), *Researching families and children: Culturally appropriate methods* (pp. 156–163). New Delhi: Sage.
- Keller, H. (2007). *Cultures of infancy*. Mahwah, NJ: Lawrence Erlbaum.
- Levinas, E. (1969). *Totality and infinity: An essay on exteriority* (A. Lingis, Trans.). Pittsburgh: Duquesne University Press.
- Luria, A. R. (1976). *Cognitive development: Its cultural and social foundations*. Cambridge: Harvard University Press.
- Marriott, M. (1989). Constructing an Indian ethnosociology. In M. Marriott (Ed.), *India through Hindu categories*. Thousand Oaks, CA: Sage.
- Mead, G. H. (2001). The philosophies of Royce, James and Dewey in their American setting. *Culture and Psychology*, 7(1), 49–54.
- Mistry, J., & Saraswathi, T. S. (2003). Culture and child development. In I. Siegel (Series Ed.) & R. L. Lerner, A. Easterbrooks, & J. Mistry (Vol. Eds.), *Handbook of psychology: Vol.6. Developmental Psychology*. New York, NY: Wiley.

- Moos, R. H., & Moos, B. S. (1994). *Family environment scale manual* (3rd ed). Palo Alto, CA: Consulting Psychologists Press.
- Rao, K. R. (2008). Prologue: Introducing Indian psychology. In K. R. Rao, A. C. Paranjpe, & A. K. Dalal (Eds.), *Handbook of Indian psychology* (pp. 1–19). New Delhi: Cambridge University Press.
- Ratner, C. (2008). Cultural psychology and qualitative methodology. Scientific and political considerations. *Culture and Psychology, 14*(3), 259–288.
- Reddy, V. (2008). *How infants know minds*. Cambridge, MA: Cambridge University Press.
- Roland, A. (1988). *In search of self in India and Japan: Towards a cross-cultural psychology*. Princeton: Princeton University Press.
- Sinha, D. (2002). Culture and psychology: Perspective of cross-cultural psychology. *Psychology and Developing Societies, 14*, 11–26.
- Scribner, S. (1976). Situating the experiment in cross-cultural research. In K. E. Reigel & J. A. Meancham (Eds.), *The developing individual in a changing world* (Vol. 1, pp. 310–321). Montana: Hague.
- Shweder, R. A. (1984). Anthropology's romantic rebellion against enlightenment, or there's more to thinking than reason and evidence. In R. A. Shweder & R. A. LeVine (Eds.), *Culture theory: Essays on mind, self and emotion* (pp. 27–66). Cambridge, MA: Cambridge University Press.
- Shweder, R. A., Jensen, L. A., & Goldstein, W. M. (1995). Who sleeps by whom revisited: A method for extracting the moral goods implicit in practice. In J. J. Goodnow, P. J. Miller, & F. Kessel (Eds.), *Cultural practices as contexts for development. New directions for child development, 76*. San Francisco: Jossey-Bass Inc.
- Sindhu, N. (1978). *Cognitive development in infancy: Maternal and nutritional correlates*. Unpublished masters dissertation. Department of Child Development, Lady Irwin College. University of Delhi—New Delhi.
- Spivak, G. C. (2004). *Death of a discipline*. Calcutta: Seagull Books.
- Tomar, R. (2009). *Pre-school children's conformity and its relation to selected factors: Authority, reciprocity, reasoning and majority opinion*. Ongoing masters dissertation. Department of Human Development and Childhood Studies. Lady Irwin College. University of Delhi—New Delhi.
- Tuli, M., & Chaudhary, N. (2008). Cultural networks, social research and contact sampling. In S. Anandalakshmy, N. Chaudhary, & N. Sharma (Eds.), *Researching families and children: Culturally appropriate methods* (pp. 53–66). New Delhi: Sage.
- Valsiner, J., & Rudolph, L. (2008, July 21). *Who will survive? Psychology that replaces quantification with qualitative mathematics*. Paper presented at the symposium entitled 'Why psychology moves towards qualitative epistemological foundations?' International Congress of Psychology, Berlin, Germany.
- Valsiner, J., & Sato, T. (2006). Historically structured sampling (HSS): How can Psychology's methodology become tuned into the reality and the historical nature of cultural psychology. In J. Straub, D. Weidemenn, C. Koelbl, & B. Zeilke (Eds.), *Pursuit of meaning: Advances in cultural and cross-cultural Psychology* (pp. 215–251). Bielefeld: Verlag.
- Weisner, T. S. (2005). *Discovering successful pathways in children's development*. Chicago: University of Chicago Press.
- Wetherell, M., & Potter, J. (1992). *Mapping the language of racism: Discourse and the legitimisation of exploitation*. New York: Columbia University Press.
- Yoshikawa, H., Weisner, T. S., Kalil, A., & Way, N. (2008). Mixing qualitative and quantitative research in developmental science: Uses and methodological choices. *Developmental Psychology, 44*(2), 344–354.

## Chapter 18

# Dynamics of Life-Course Transitions: A Methodological Reflection

Tania Zittoun

The French movie “Life Is a Long Quiet River” (« La vie est un long fleuve tranquille », Chatiliez, 1988) compares the fates of two children, born in contrasting social classes and exchanged at birth, and plays with the unpredictable curves and bends of their developmental histories, which eventually bring them to acquire the skills and knowledge that they might have acquired in their original milieu. The ironic title strongly suggests that life is *not* a long quiet river, and illustrates two long-time known principles of development. It shows that the development of a child or a person is not linear, and cannot be predicted; it also shows that many different ways can lead a person to develop a given skill or understanding (Vygotsky, 1929/1993). Admitting these principles has consequences for the study of human development: life-courses appear characterized not only by the regular and progressive establishment of regularities and continuities, but also, and mainly, by the moments in which these continuities are interrupted, reoriented, or challenged.

Such moments are interesting for several reasons. Firstly, at a theoretical level, it is at points of bifurcation that the person or the organism has to develop new conduct. Secondly, at an empirical level, lives in contemporary societies are exposing people to interruptions to what appears continuous to them—for example through job reassignments, demands to engage in continuous education, changes in family composition, the introduction of new technologies at home or in the workplace, and so on and so forth. Thirdly, at a methodological level, these points constitute “natural change laboratories” in people’s lives. In effect, experimental settings usually create tasks or strange situations to which people have to answer; in these situations, researchers examine people’s answers or the processes that lead them to these. Ruptures in life produce equivalent tasks, or strange situations, calling for an answer—and thus processes whereby these answers, or adjustment are produced, can be observed; I call them here *transitions*.

---

T. Zittoun (✉)  
Institute of Psychology & Education  
University of Neuchâtel  
Neuchâtel 2000, Switzerland  
e-mail: tania.zittoun@unine.ch

My main proposition is that the couple of notions “rupture” and “transition” offers a powerful methodological unit of analysis for the study of development in life trajectories. I emphasize the heuristic power and the relevance of such unit of analysis, the difficulties it raises, and some strategies to circumvent these. I finally suggest how the notions might be used to develop a rich understanding of changes in life-trajectories.

## Studying Development

The reflection on the study of life-trajectory proposed here belongs to a certain orientation within developmental psychology; I present here four of its assumptions, for they raise some methodological difficulties that will have to be addressed.

Firstly, the study of development is the study of processes whereby change occurs. This might seem obvious; however, many studies which might appear developmental do not examine processes. For example, measuring a person’s ability to answer to a test at time  $X$ , and measuring the same person’s ability a time  $X+n$ , enables to compare two results at two points in time. One might see that this enables to identify some developmental change of the person’s abilities between  $X$  and  $X+n$ . However, such comparison does not say anything about the process by which the person producing a result at time  $X$  has become the person producing a result at time  $X+n$ . A comparison of  $X$  and  $X+n$  is a comparison of outcomes, not of processes. In contrast the process of changes can be examined (Valsiner, 2007). This does not mean that the person has to be totally changing all the time. Describing development requires to account both for the continuity and the changes in which a developing organism, person or system is necessarily engaged (Erikson, 1968; James, 1890).

Secondly, the development of a person is a complex phenomenon, involving biological, psychological, but also interpersonal and social processes. The approach chosen here considers as central the “social” or “cultural” nature of human conduct. The social or cultural component of psychological processes can be observed at different levels of analysis. It can be observed at the level of intrapersonal phenomena (e.g., analyzing a person’s internal dialogues, as echoes of other social situations, Bakhtin, 1982; Marková, 2003). It is obviously visible at the level of interpersonal processes (e.g., interactive dialogues, Grossen & Salazar Orvig, 2006), and at the level of intra-group or inter-groups dynamics. Finally, the social nature of human conduct can be observed when people deal with ideological phenomena at a societal level (e.g., the emergence of social representations in face of a new societal event) (Doise, 1982; Perret-Clermont, 2004). Although these levels of analysis are often separated due to methodological and conceptual reasons, in reality, changes identified at one level have actually consequences for phenomena observed at another level (Fogel, 2006; Fogel, King, & Shanker, 2008; Vasiner, 2007). Hence, a young man’s development can be observed at the level of the change his perception of himself (intrapersonal level of analysis) or at the level of his changing relationships with girls (interpersonal); however there are good reasons to believe that both events are related. Or a country’s new policy against foreigners (societal level of

analysis) can bring people to deal very differently with their neighbors in everyday life (interpersonal level). Some authors thus speak of the interdependency between ontogenetic processes (the person's development), micro-genesis (changes occurring as interactions between the person and her social environment unfolds) and socio-genesis (changes in the social environment, whereby social representations develop) (Duveen & Lloyd, 1990). In the case of the study of life-trajectories—which are always unfolding in diverse contexts, and experience by a person through a longer period of time—change can only be explained by taking in account at least intra and interpersonal changes and their interactions (see e.g., Gillespie, 2005, on Malcolm X, or Zittoun, 2003, on Carl Rogers).

Thirdly, the perspective chosen here considers that the person, constantly interacting with others and her environment, is also engaged in negotiating the meaning of these situations (Bruner, 1990). These processes of meaning making are rendered possible through diverse forms of semiotic mediation (Vygotsky, 1930). Processes of internalization, by which shared meanings become internalized, that is intra-psychological, and externalization, when the latter find a sharable form in interpersonal situations, play a major role in such processes (see e.g., Valsiner & Rosa, 2007). Meaning making can only be observed via these processes. One cannot know what a person thinks about A; one can know in which circumstances the person has been exposed to A (i.e., the conditions of a possible internalization), and what she says or does about A (what she externalizes)—and it is only on this basis that the person's thinking about A can be inferred.

Fourth, as any other science, developmental psychology aims at proposing general understandings of some phenomena. It is obvious that describing the development of one person in one circumstance is not enough. Yet there are different ways to construct general knowledge; I will here consider case studies. Case studies enable to account for the complexity of phenomena as identified above. How then to link and bring together different case studies? It is impossible to construct an "average" case; one would thus lose what makes the interest of a case. Rather, one can use a more formal language, and thus sketch a model of processes. This model can then be applied on another situation, and modified so as to account for its specificities, and to a third, and so on. A model hence developed enables to highlight relationships between significant components of situations. In turn, case-studies can be analyzed as exemplifying some variations of these relations (e.g., Branco, 2007; Flyvbjerg, 2006). In this paper, I clarify a set of notions which enable to identify some relationships occurring in great variety of cases. These notions can then be used to work towards generalized knowledge.

## Methodological Difficulties

The history of psychology repeatedly shows how difficult these principles are to follow when it comes down to empirical research. The major difficulty is to capture the time-dimension, that is, the processual nature of the phenomenon under study. Indeed, any form of description of a phenomenon requires stepping out of time. Data

collection always requires decomposing the flow of time into units so as to keep a semiotic trace of a given phenomenon, through different techniques: pictures, films, paper–pen, etc. This is even stronger when the persons' perspectives are questioned in real-time: they then have to comment on their actions or to write some notes about their current state of mind—and doing so they definitely take distance from the flow of time and experience. Also, change can take place in time-scales that are difficult to observe continuously (as a life-time) or with accuracy (as an emergent idea). Even analyzing data is a way of distancing from the flow of time: creating categories of events occurred in a classroom interaction looses their location in duration. Finally, it is very difficult to engage in a real-time enquiry without affecting the phenomena itself. The second difficulty is that it is very difficult to observe more than one level of change in one single operation, such as micro-genesis and ontogenesis; usually, research chooses to focus on one level, and then misses important aspects of change. Thirdly, it is easier to observe externalization than to capture internalization; and it is simpler to capture it, when it is verbal. Consequently, many studies focus exclusively on verbal interactions when interested in psychological change, hence loosing the perspective of the person. Fourthly, simplifications in view of generalisation often intervene early in the study; as richness of the data is lost, further theorization and identification of theoretical equivalences with other cases is often prevented (Overton, 2002; Wagoner, 2007, 2009).

The methodological reflection presented in this chapter is based on the four developmental assumptions presented above, and addresses these methodological difficulties. It examines how the notions of rupture and transition can be used to study life-trajectories. It thus pursues a reflection undertaken by me and groups of researchers in which I have been collaborating over the past 10 years. As we have been exploring a wide range of methodological strategies for the study of transitions, empirical examples are primarily taken from our work. Other studies are also mentioned to expand or contrast our choices. In no sense this is a review of the literature on transitions.

## **Transitions to Approach Development**

A powerful meta-theoretical frame for understanding life-trajectories is currently given by complex system theory. In rough lines, in such meta-theoretical frame, the development of an organism can be described as a constantly changing adjustment between the organism and its environment, going through a series of relatively stable periods, alternating with more important changes due to brutal ruptures within the adjustment process (van Geert, 2003; von Bertalanffy, 1993). These moments of ruptures, which can be facilitated or provoked by internal factors as well as by external ones, can be described as points of bifurcation, from which the organism can develop in one, or the other direction. This analysis can be applied to micro-processes of change, such as the development of a cell, or at the ontogenetic level, such as the trajectory of an individual in his context. For example, the life of Jack

London, as described in his autobiographical novel *John Barleycorn* published in 1913 (London, 1998), is filled with such moments of bifurcation. As he was a child, his parents moved frequently; born in a farm, he arrived in town and was asked to sell newspapers in the street, aged ten. On the one hand, the autonomy he thus gained enabled him to explore the library and to read his first books—a revelation, which appears decisive for his future life (Sutherland, 1998, p. 214); on the other hand, being in the street and delivering newspapers, he also discovered the life of pubs. The rupture (of changing habitat) opened new pathways (commitment with books, relationship to alcohol), which have different consequences. London early engages in drinking, and risks to remain in that path; yet later incidents bring him to change pathway—such as for example, the love for an educated woman, which seems to have encouraged him to start adult education and to be accepted at college. Another example of significant bifurcation is reported by him: at a period in which he tried to live from his writing without succeeding, he was offered a stable position in the local post-office; he refused because the postmaster who offered him the job upset him (London, 1998, p. 145); forced to pursue writing, he started to be abundantly published soon after. Would he have accepted the stable job, it seems, he would not have become the author we know. Jack London thus faces many bifurcation points, and following one way will have unpredictable consequences. However, although a given option never comes back twice, alternative routes lead to equivalent points.

In an open system, two contrasting types of changes can be identified. A first type participates to the continuous, regular evolution of the system. These are part of transitive dynamics, or circular phenomena. For example, during the period in which Jack London is able to live from his writing, he sells a story, earns money, can pay his bills, and thus can spend all his mornings writing—and so can he write quality stories and sell them. In contrast, an intransitive change breaks such a circle: for example, at the end of this writing period, Jack London is challenged by a group of young men to participate to a drinking contest—unable to refuse, he drinks, and next day, is unable to write, and later, he fails to give a planned talk (London, 1998, pp. 151–153). Accepting the drinking contest constitutes a rupture in London's forced sobriety at this time. This event constitutes a rupture of the “virtuous circle” of a given suite of phenomena; it necessary calls for a new arrangement in the system; such a change can be called intransitive.

A rupture signs the end of a mode of adjustment; after such an event, the routine changes are invalidated; new dynamics have to be established. Trivially, think about book arrangements: for a while, every new book bought by a person finds a place in her bookshelf; at some point, one book comes, and the bookshelf is full. At this point, as the normal course of things is interrupted, the person might start to imagine what new furniture she will buy or build. Hence, a rupture is a call for new ideas, new solutions, or new ways of acting or thinking. If life always requires regular change, as in transitive processes, a rupture calls for more, deeper, more substantive changes; in that sense a rupture is a *catalyst* for intransitive change.

From a developmental perspective, such intransitive changes following ruptures are of greatest interest; this is where newness is called for, and can emerge. This



observation has to be translated in notions that have some heuristic power, that is, that enable us to account for actual observations, and that permit such observations and analysis to be connected to the existing developmental and learning literature.

The notion of *transition* offers an actionable notion to study these changes. At a theoretical level, it can be quite easily connected to these of rupture, or bifurcation. At an empirical level, there is a growing literature on transitions in the life-course (see Levy, Ghisletta, Le Goff, Spini, & Widmer, 2005, for a recent overview), which can then be discussed on this basis and integrated in a wider reflection on development.

### ***The Notion of Transition***

*Transitions* can be defined as processes of catalysed change due to a rupture, and aiming at a new sustainable fit between the person and her current environment. The notion of transition can be easily connected to other constructs in developmental psychology. This notion thus requires, as in any systemic approach, an initial *rupture* in the system constituted by the person and her environment, system that can be defined in different manners according to the chosen level of analysis. The notion of *rupture* designates the processes called *irritation* (Peirce, 1878), *crisis* (Vygotsky, 2004, 1930; Erikson, 1950/1995, 1968; James, 1890), *desequilibration* (Piaget, 1966/2003), *challenge* (Smelser, 1980), *critical event* (Wapner & Demick, 2005) or *turning point* (Rutter, 1994) in psychology. The notion of *transition* designates the processes captured by these of *re-equilibration* subsequent to ruptures, of *restoration* of one's sense of continuity and integrity (Carugati, 2004; Erikson, 1968; James, 1892; Palmonari, 1993; for reviews see Elcheroth et al., 2003; van Geert, 1988; Wapner & Craig-Bray, 1992).

The notion of transition is preferred to competing notions for a few theoretical reasons. The powerful *equilibration* (Piaget, 1964/1967) notion has been developed to account for the development of intra-psychological, mental structures. In contrast, ruptures-transitions can more directly account for the adjustment between the person and her socio-cultural environment. The notion of *crises* and its resolution was proposed by Erikson to discuss key-points in life trajectories: a crisis would for him designate "a necessary turn, a crucial moment in development, when it has to choose between ways in which are distributed the further resources of growth recovery and differentiation" (Erikson 1968/1972, p. 11, m.t.). However the notion was developed in a theoretical frame which considered a certain number of normative crises in a life-trajectory and strongly suggested which of their outcomes would be preferable. Also, it is now strongly associated to Erikson's work on adolescence identity-crises. In contrast, processes of *transitions* can more easily be heard as leading to undetermined outcomes, are less specifically associated to a given period of the life-course, and are not limited to identity processes.

## *From Static to Dynamic Understandings of Transitions*

The notion of transition is useful only if it can account for transformations. The term transition of course suggests that something is being changed from one state to another, or from A to B. In the major part of the contemporary literature on transitions, the authors start by defining the two contexts, stages or phases A and B. The term transition then designates the fact that B replaces A.

Having to account for phenomena that have a great social or educational relevance, many authors have used the notion of transition as its common sense usefully designates the idea of the passage from A to B. There is thus a wide literature on the school-to-work transition, the transition from secondary school to university, the transition between work places, and so forth. Another family of studies is related to the study of the life-course. Here as well, the notion is often used to designate the move from one stage or one social role to another one, such as the transition to adulthood, parenthood, retirement, and so forth. The notion of transition is very appealing to designate these changes; however, its seductive appearance is rarely questioned. Yet it raises some issues: firstly, used in this way, it assumes that A and B are clearly identified. Secondly, if one does not question the processes involved in what bring A to transit towards B, the notion of designates the magical replacement of one state by another—*B rather than A*.

Three main criticisms can be addressed to approaches that use unreflectively the notion of transition. First, because of their focus on endpoints, they tend to leave the processes of change out of their investigation (among them, especially the studies that compare some data produced in B with some data produced in A). Second, identifying *B-rather-than-A* issues often brings to enquire about normative changes in a given social space or life-trajectory. Normative changes require some stability of the environment. However, at a social level, contemporary social spaces and trajectories are in rapid evolution; at the individual level, individual trajectories tend to be non linear, individualized and going through frequent changes. In contemporary liberal societies, starting a job or studying, raising children or mating, can happen many times in a life trajectory, due to changes of the economical world, the technological environment, transformations of values and cultural exchanges (Perret-Clermont, Resnick, Pontecorvo, Zittoun, & Burge, 2004). An empirical priority is thus not to study stability and norms, but rather to examine changes and bifurcations in life trajectories. Thirdly, identifying and labeling one transition (e.g., school-to-work, to adulthood, etc.) easily hides the fact that, in a complex system, a change is usually accompanied by a whole series of related adjustments.

A contrasting approach to transitions considers that it is precisely the processes whereby A becomes B that are relevant. The focus is on A *becoming* B, on the merge of A into B, or on the emergence of B out of A. Of course, this can be done at various level of analysis—the micro-processes of interpersonal adjustment, wider identity transformation, or more complex configuration of interactions between

people and their social and material environment. The following paragraphs explore various aspects of dynamic transitions.

### ***Perceived Ruptures***

In the developmental perspective proposed here, meaning processes—whereby people confer sense to the situation, to their experience, or to times to come, are central. If changes occur, they require some sense-making; reversely, sense-making dynamics often follow experiences perceived as ruptures by people.

Methodologically, studies on transitions need to identify the rupture point that justifies their enquiry. Ruptures are often identified on the basis of an external criteria, for example on the basis of unquestioned social representations (e.g., the transition to adulthood is mostly expected to be problematic), on the basis of observable facts (e.g., difficulties of adjustment during the school-to-work transition), or on the basis of other criteria defined by the researcher. Of course, sometimes, these periods or events are also perceived as significant by the person.

The study of ruptures and transition is a theoretical construct; yet it attempts to capture some phenomenological reality. If an event is studied as a rupture that is likely to bring a person or an organism to engage in changes, then the organism or the person under study must perceive the event as a rupture, in some respect. In other words, with other developmental psychologists, I consider that transitions to be studied have to follow ruptures perceived by persons (see also, van Geert, 1988; Wapner & Craig-Bray, 1992; Wapner & Demick, 2005).

### ***Locating Ruptures***

Whether a rupture is identified by a researcher or by the persons under study, it is often difficult to identify its actual, factual, objective causes. On the one hand, some actual causes can be very remote from the experience of the person, and what is actually perceived as a rupture is often a far and unpredictable repercussion of the initial change (e.g., as a result of war, a young woman might be exposed to forms of courtship that are experienced as a rupture in her identity as a woman, Zittoun, Aveling, Gillespie, & Cornish, *in press*). On the other hand, some ruptures are induced by processes of transitions in which the person is already engaged (e.g., a person might be proposed a better professional position, which generates a rupture, as a result of the skills acquired during a previous transition). Additionally, if the researcher has often good reasons to believe that an event is a potential rupture, the study of individual cases reveals numerous surprises. For example, starting university in a foreign town is often perceived as rupture, but not so much for children of diplomats who have changed schools and life settings regularly every few years during their childhood (Gyger Gaspoz, *in preparation*; Zittoun, 2006a). Experiences

of rupture do not need to be caused by a single cut event; they can also progressively emerge as a result of transformations of the field, such as for example when people have the experience of a growing ambivalence or uncertainty in their life (see e.g., Zittoun et al., [in press](#)).

One possible distinction among ruptures that can be perceived by a person can be proposed as follows. If ruptures have to do with a person's adjustment with her environment, then they can be either due to a perceived mismatch between the person's ability to act or modes of thinking and the actual social, material, and symbolic environment, or to a perceived mismatch in her own system of understanding. In the first case, a person's intending to pursue his professional activities might thus be confronted to the fact that he is made redundant. In the second case, a person's non-violent values might be contradicted to the fact that she acted violently in a confrontation with a member of her family. Of course, a distant event can be the objective "cause" of the rupture; yet this event has to find a translation in one or more aspects of the person's daily life. For example, the outbreak of a World War II could become a rupture for a person, not in itself, but once it caused a shortage of petrol and thus rendered impossible her daily activity in the family garage, and also, because it questioned the belief that World War I had been "a war to ends of war," transmitted through the parent's narrative (Zittoun, Cornish, Gillespie, & Aveling, 2008).

### ***Inter- and Intra-Psychological Processes***

In the light of what precedes, in order to account for psychological development, it is necessary to account both for intra-psychological changes and for interpersonal changes. Intra and interpersonal changes are usually related. It is admitted that Vygotsky's work has shown how interpersonal dynamics can lead to intrapersonal changes (e.g., the mastery of communicative language changes modes of thinking). Yet the process is bidirectional: changing one's way of thinking also changes one's action in the world (Vygotsky, 1934/1997). These bidirectional changes are often non-linear and not strictly predictable. For example, it is not because a person takes German classes (interpersonal phenomenon) that she will immediately start to think in German (intrapersonal process); she might have to wait until she lives in a German speaking environment, that circumstances requires from her to take an active role, etc., before she starts to realize that she speaks and dreams in German. The notions of rupture and transition thus aim at capturing both intra and interpersonal processes of change and their dynamic interrelations.

### ***Processes of Transitions***

In our work, we have proposed to examine systematically three interrelated transition processes: these connected with *identity definition*, perception or positioning,

these connected to *learning*, or also to defining new ways of acting or skills, and these more related to *sense*, values and emotions (Perret-Clermont & Zittoun, 2002; Zittoun, Duveen, Gillespie, Ivinson, & Psaltis, 2003; Zittoun, 2005, 2006a; Zittoun et al., 2008). Doing so, we mainly want to emphasize the interrelations of dynamics captured by different theoretical constructs, due to different research traditions studying changes. Identity dynamics have been the object of studies inspired by Erikson (1968), and have been approached as part of the processes of becoming a member in approaches primarily interested in socialization and affiliation (Lave & Wenger, 1991). *Learning* of knowledge, skills and competences is the main focus of studies in transitions implying moves from one formal institution to another. Issues of sense making in life-transitions are approached in terms of *narratives* (Bruner, 1990; McAdams & Logan, 2006) or of *representations* of a problem or of the future (Masdonati, 2007). Studies of meaning are still a minority.

Note however that meaning issues have been the main interests of approaches studying transitions in traditional societies. These are described as relatively homogeneous, and as usually providing people with symbolic means to canalize changes and transitions: rituals and collective narrative are there to confer meaning to childbirth, weddings or death. In our occidental liberal societies, the abundance of available symbolic means paradoxically prevents people to find any ready made symbolic formulation of life events. This means that rendering changes and transitions meaningful becomes a more personal matter. This does not mean that people's need to confer sense to events has diminished. At the contrary, as a heavier demand is put on people who have to construct a symbolic understanding of more frequent life transitions, sense making processes become a key component of transitions processes.

A close attention to the three dynamics and their interrelations appears of great importance. On the one hand, it is heuristically powerful for analyzing and accounting for empirical facts. Hence, recent studies in vocational training show that one cannot understand learning and resistance to learning without a close attention to the identity dynamics involved (Billett, 2003). Other studies show how much these resistances are due to how much people can confer sense to the objects of knowledge (Rochex, 1998). Even more, the three aspects are constantly interrelated: knowing something new, questions who one is, and in turn, the meaning of the fact of being engaged in such learning (Hundeide, 2004; Zittoun, 2006a, 2008).

### ***Rupture-Transitions as an Unit of Analysis: Methodological Challenges***

The notion of transition, or more exactly, the pair rupture-transitions, is proposed as unit of analysis to study life trajectories, enabling to capture processes of change, and the person's perspective (Zittoun et al., 2003). Transitions can thus be seen as processes of reorganization of a system in which people's interpretation of a perceived rupture plays a major role in their subsequent thoughts and actions.

Perceived ruptures are not the only reasons for change and development to occur. Development can also occur through micro-adjustments between the person and her environment, as life unfolds. However, ruptures, which create sudden mismatch in these adjustments, appear as catalyst of processes otherwise usual. The proposed unit of analysis gives us a methodological tool to identify sequences of catalyzed change. Once this said in theoretical term, what methodological strategies enable to capture transitions?

In what follows, different methodological choices are presented and discussed. Because the main methodological challenge is to preserve the time dimension of psychological processes, I classify these examples on their basis of their relations to time. In each case, I discuss how data collection is located in relations to actual events; what externalization is treated as data; whether such data can be treated as factual information vs. reflective interpretation; and what the role of the researcher is. My analysis of the notion of transition in development underlines the particular importance of identifying ruptures perceived as such by the person. This particular point raises a specific technical issue: how to be sure that the transition under study is actually attached to a rupture perceived as such by a person? In each case, I will make a certain number of technical suggestions.

## **Reconstructive Approaches to Transition**

The apparently simplest and most frequent way to document transitions is to describe transitions that have taken place in the past. Data are produced in the present, and attempts to capture some phenomenon that has already been the case—the phenomenon is thus reconstructed. Reconstruction is always based on forms of externalizations that have to be read in their link to some past events.

### ***Reconstructive Interviews***

One way to approach transitions in developmental trajectories is to question a person, at a certain point in time, about processes and changes that have occurred in her past. The externalization is discourse, and it is produced in the present of the research. The advantage of this technique is that it offers access to the person's present evaluation of past events which have appeared as ruptures. From point C, the person identifies events that she has personally experienced as ruptures and that are linked to A–B transition processes in her past. The weakness of this approach is that processes of change are reconstructed from the perspective of C. Consequently, it is not the richness of uncertain futures which are considered from the present, but rather the certainty from the past (Valsiner, 2008). For example, some young people experience moving town to start university studies as a rupture (Zittoun, 2006a). If they are interviewed during the transition, as they are still exploring possible

futures, options that could be, they evoke anxieties, might be self-contradictory, and express hesitations; if the transition has been experienced some time ago, their narration tends to emphasise the pathway that has been followed and the events that lead to the achieved endpoint, leaving out try-and-fail efforts leading to alternative routes—which, by being considered even if not followed, might have played an important role in the transition processes.

These reconstructions can be organized around a specific type of rupture identified either by the researcher or by the participant. For example, Mahmoud (2005) questioned Sudanese refugees in Egypt, the move to Egypt being expected to be perceived as a rupture. Other reconstructions rather offer participants to identify rupture or “turning points” (Leonard & Burns, 2006) in their life courses, and then explores these events. For my research on youth transitions, I adopted a mixed procedure: I questioned young people about a specific event likely to be experienced as rupture; yet I carefully identified events *actually* experienced as such. Thus, a young woman interviewed on the (supposed) rupture of coming to university preferred to describe a major rupture she experienced earlier, the death of her grandmother (Zittoun, 2007b).

How much can such reconstructions capture the transition as they really occurred? It expects to identify on the one hand, the actual rupture-like biographical event, and on the other hand, the way in which the person has experienced it (Kohler, 1993). Yet both facts and meanings are reconstructed on the basis of memory, and as such, are mostly transformative reproductions of the past (Bartlett, 1920). To facilitate these reconstructions, externalizations made at the time of the transition might be useful. For example, to capture the way in which students dealt with the transitions due to their move to a new town, I questioned them about the objects they had taken with them and placed in their university room. As objects can be crystallization of thoughts and emotions, talking about the objects offered an indirect access to the thoughts and emotions characterizing the period at which the objects were chosen (Fuhrer, 2003; Habermas, 2001; Tisseron, 1999; Zittoun, 2006a). Similarly, when I interviewed adults about their transition to parenthood, I questioned them on their externalization during the pregnancy: the lists of first names they wrote for their children to come, the home-made simile of birth announcement cards, and so forth; on the basis of these past traces of their explorations, they could formulate some of their past thoughts and interpretations of events (Zittoun, 2003, 2005). On the other hand, the person’s interpretation of the meaning of her experience is a dynamic process, likely to be reconstructed through time, and transformed every time the person thinks back about that transition, or about any related event (unless the event is traumatic, in which case the meaning of the experience might be much more fixed, for example Abraham & Torok, 1987). The more one is interested in the accuracy of the actual facts, the closer these reconstructions should probably be in time. The memory otherwise soon becomes transformed by the interpretation (which is however not a problem for the researcher interested in people’s meaning making).

In such reconstructive discursive techniques, how to identify ruptures actually perceived by the person? Various verbal and non-verbal markers can signify a person’s experience of an event as a rupture. Firstly, a person can explicitly label an

event as having been “eye-opening,” a “radical change,” a catastrophe, a shift—or any verbal expression of equivalent meaning. This is of course the simplest case: the person reflectively identifies in her experience such a shift with the mediation of a relevant semiotic mean. Second, the person might be less explicit, but might express or comment on a subjective past state which might be due to such rupture: following a specific event, she had felt depressed, lost, or anxious about the future, or in a cloudy zone... Thirdly, the person might report past actions and externalizations that might have been induced by a rupture: at this time, she had been looking for information, asking for help, seeing friends in order to discuss the situation, or alternatively, starting to use psychoactive substance. Fourth, the modalities of the discourse itself might be modified when approaching specific issues during the course of the research interview: the person’s debit of discourse can become slower (as when re-experiencing) or faster, lower in tone (as when sad) or more excited, less fluid, or less structured (Zittoun, 2005, 2006a). A special attention to the modality of discourse and its flow requires a more “clinical” ear but can be developed on the basis of research on clinical interactions (Ammaniti & Stern, 1991; Green, 1973; Vermersch, 2006). Additionally, people can use para-verbal means to suggest change, such as hand gestures or bodily postures. An examination of such paraverbal or non-verbal cues might require specific technical choices (e.g., video-recording interviews).

Within such range of means to identify perceived ruptures, only the first one is associated to the research participant’s clear reflective awareness of a past rupture-event, in such way that it can be expressed in a linguistic form. This reflective awareness might be due to many factors—the person might be generally self-reflective, she might have had the occasion to discuss the events with others or to symbolize them through other means than discourse (such as graphic or gestural means, Tisseron, 2000), or she might just articulate her experience as the research interview unfolds. When the person is less reflective, the researcher relies more on non verbal or paraverbal cues, and on his or her theoretical and empirical knowledge of the consequences of rupture in experience and discourse. He or she then might want to check his or her inferences with the person. For example, when a person, who usually speaks in a moderate tone, reports with great excitement the preparation of a trip, the researcher might question about the subjective importance of that trip. Of course, such an interpretative intervention usually brings the person to more reflectivity. To engage, or not, in such interpretation is a matter of the researcher’s methodological and ethical choices.

### **Guided Reconstructive Autobiography**

The problem of reconstruction of memory becomes even more accurate when people are questioned about a longer time span, such as in life-narrative interviews. Additionally to issues of memory, the very fact of turning a life experience into a narrative creates a very specific sort of data.

As experience is verbalised, it is deployed in time and thus becomes a narrative. One can construct a narrative based on events which might have appeared as disconnected



as they occurred. Also, narration enables the emergence of a fact which was not necessarily pre-existing that narration. For example, Hasse (2002, 2008) shows how adults narrate their becoming the physicists they are. They mention a series of events, randomly distributed in their childhood and their youth, which probably appeared as isolated as they occurred. From the perspective of the present, these appear as connected and part of one same “transition to being a physicist”. Narration is also submission to canonical genres, of which the most elementary structure is that of an accident, being then resolved (Bruner, 1991; McAdams, 1993; Propp, 1928/1968)—narrative genres invite the narration of ruptures and transitions (Gillespie, 2005). In addition, narratives in interviews are co-constructed, and the active role of the researcher should never be underestimated in the production of a transition-like narrative. Finally, reconstructive autobiographical narrative techniques, based on language use, privilege people who have an easy access to verbal language as mode of symbolisation.

There are different technical tricks to circumvent these issues. As in most approaches in qualitative research, demultiplication of perspectives plays a key-role (Flick, 1992). One technique consists in taking seriously in account the role of the interviewer, who can become a real partner in the construction of the narrative. For example, in adult education, guided autobiography through group discussion is a common technique to identify life transitions (Dominicé, 2007; West, 2006). In a more classical research setting, an analysis of transitions in the life-trajectory of a man in his seventies was produced using the following technique: the research project and the idea of rupture were discussed at length with that person. He was firstly narrating events and memories from different periods of its life. Through further oral questioning, other memories were proposed. Then, the man was asked to produce a written account of these various events. Interpretations of these as ruptures were then discussed with him (Zittoun, 2007a). Another type of demultiplication of perspective can be obtained through techniques of collaborative research (Cornish, Zittoun, & Gillespie, 2007). In their interesting project called “Samisebe”, a group of Czech sociologists of different generations wrote each their autobiography through the recent history of the country (Konopásek, 2000); they then discussed in group their perspectives on specific events, experienced by some of them as young people, by other as mature adults or already elderly people—and certain events being ruptures for some, and not for the others. Here, the collective memory confers some objectivity—or at least, some distance—to the facts; while the confrontation of perspectives brings to specify (if not polarize) personal interpretations. Finally, in autobiographical research as well, externalizations issued at the time of the experience might facilitate the experience. In a recent autobiographic text, Grass (2007) thus deplores having lost his wartime notebooks, past sketchbooks, diaries and collections of poems—having these, he believes, would give him a more trustworthy access to the mind of the person he once was. However, a visit to his childhood home town enabled him to revivify memories of the past.

In these examples, events considered as ruptures are identified reflectively. This identification is doubly guided. Firstly, it is always the interaction between the person and others—the researcher, the group of co-researchers, the students also engaged in a life trajectory analysis, that facilitates that process of identifying

ruptures: different perspectives, but also, perspectives exchanges between people engaged in a common project, can lead to this reflection. Indeed, these procedures are quite likely to bring participants to see their life stories from the perspectives of the other, or to apply other's analysis on their own trajectory (Gillespie, 2007). Second, such projects are also mediated by semiotic resources: people analyzing their lives are usually explicitly looking for bifurcation, critical points, ruptures, etc.—and on such case the notion of bifurcation, or rupture might become semiotic mediators guiding the attention. More generally, culturally shared modes of narrating experience might canalize a person's narration and shape it into a canonical form in which transition play an important role (Bruner, 1990; Gillespie, 2005; McAdams & Logan, 2006).

### **Mediated Reconstruction**

To overcome the fact that narrative reconstruction privileges people who have an easy access to verbal narration, these reconstructions can be mediated by alternative modes of externalisation—based on different semiotic modes—at the time of the research process.

The mastery of language might particularly be an obstacle for children. To overcome this problem, Hviid (2002, 2008) asks children to draw a map of the places in which they live and have lived. The first mediation of their experience is thus graphic. For a while, it escapes to the convention and limitation of verbal language. Children are then asked to comment on those drawings. Verbal language completes or nuances the graphic reconstruction of the past. Thus, the first person perspective is preserved, and the complementarity of modes of externalisation (graphic, verbal) might enable to reconstruct the processes at stake.

Ruptures are then usually identified under specific forms, dependent on the semiotic codes due to different modes of externalisations. For example, when research participants are asked to draw their life trajectories, they often draw lines on which are indicated curves or sudden change of directions; in that case, these bifurcations can be questioned, and often do correspond to the participants' perception of change. Metaphors of change have thus a spatial form which might be rooted in a more embodied perception, as often metaphors have (Lakoff & Johnson, 1980).

### **Real-Time Transitions**

The alternative to reconstructive technique for documenting transitions is real-time data production—or at least, attempts to do so. Here, the idea is to put in place a procedure that enables to follow the process of change as it unfolds. The main options for this are longitudinal, synchronic data collection, and diachronic—repeated data collection. One of the limits of synchronic data collection is that it might be difficult to ask an observer to gather data over the extended period of time that a transition

process might last (e.g., the 9 months of a pregnancy). Researchers therefore tend to effectuate repeated data collections over a certain period (see e.g., Fogel, King, & Shanker, 2008). One of the ways to study naturally occurring transitions consists in asking research participants to repeatedly report on their transitions from their own perspective. This then raises a second issue: doing so, a person always steps out of the flow of time, and thus the procedure is not synchronic anymore. The two methodological strategies presented below take these points in account.

### ***Real-Time Data Production—First Person***

A first series of techniques is based on people's explication of their experience, as these actually unfold (or as close as this is possible). For example, one longitudinal technique is to question repeatedly the same individual over a period considered as being rich in transitions—for example the two first university years (Bell, Wieling, & Watson, 2005) or the ten years of youth (Henderson, Holland, McGrellis, Sharpe, & Thompson, 2007). This can be also combined with the collection of various externalisations—for example, asking the subjects to describe their environment, daily activities, or current communications (Wapner & Demick, 2005, p. 297). Within our theoretical framework, which admits the importance of interactions, people's ability to confer meaning, the role of semiotic mediation in the acquisition of a reflective distance, and the constant dynamic of changes accelerated by these mediated interaction, such longitudinal research enterprise necessarily participates to the actual changes of the person. This fact can be seen as a theoretical issue (how to study "real" change?) as much as an ethical one (can a researcher influence a life-trajectory?). However, this can also be seen less as one of the constituents of the stuff about which psychological research is made—human interactions. Therefore, to be consistent with our theoretical assumptions, researchers should take this fact in account when producing and analysing data.

Accounting for the change induced by the research procedure in real-time data collection can be with different degrees. It can just be stated. It can also be deliberately used, hence turning the research procedure into a research-action or a didactic strategy. Studying the transitions that bring people to become students in a French University, Coulon (2004) asked his students to write a diary of their daily difficulties and understanding about their "métier" (profession) of students. Here, reflectivity was both seen as a research tool (to document the process) and a pedagogical tool (both to facilitate the transition taking place, and to familiarize students with ethno-methodology).

Of course, in some cases, the necessary accrued reflectivity might be seen as risking to transform too deeply the course of changes and thus the strategy has to be excluded for ethical reasons. For example, when I studied how people chose names for their children to come, I decided not to use real-time techniques. Talking to a third person, parents have to rationally account for their decision, or anticipate the reaction of the listener; yet this sort of reflective thinking differs from the logics

mostly governing naming procedures—during which people follow their intuition, listen to their dreams, or explore their fantasies. In that case, interviews might have radically altered the name-choice procedure. To support this point, it appeared that even reconstructive interviews about this procedure often brought people to see the name they choose in a very different light, and sometimes to question them (Zitoun, 2004, 2005).

In real-time data production, the researchers usually choose their subjects at moments in their lives in which they are likely to experience rupture and engage in transition processes. As in some cases of reconstructive data, events likely to provoke ruptures are identified on the basis of theoretical elaboration or exploratory work. But if researchers only examine externalizations of people during these a priori defined periods, how can they verify that these are actually engaged in transition processes due to experienced ruptures?

This has not been, as far as I know, the object of systematic considerations. However, two main techniques might be imagined and explored. On the one side, the researchers could compare externalization in these periods with other externalizations. They could be compared with each externalizations of other persons, living comparable life-events under some respect (Sato et al., 2007), so as to see if different types of discourse could be identified, and if the difference could be attributed to the fact that it follows, or not, an experienced rupture. They could also be compared with externalizations of the same person at different times of her life, to identify some qualitative changes which might be attributed to the rupture. On the other hand, some cues defined on a theoretical basis might actually indicate that the person is engaged in a process of transition. If transitions demand the emergence of new modes of thinking, to define oneself, or to define new forms of actions, such cues might be: exploratory talk; alternance of prospective and reflective talk; indications of anxiety and insecurity, etc. In order to identify these cues, the actual examination of micro-transitions might be useful, as we will show in the next section.

### ***Archival Approaches to Transitions***

To avoid issues related to added reflectivity while following events as they unfold in life-trajectories, it is possible to use longitudinal data, even when produced for other purpose than a study on transitions. Diaries might offer such longitudinal data. Diaries are produced daily by people, to testify about daily events and reflection, and are usually addressed to a real or an imagined other (Lejeune, 2000). Unlike reconstructive data, the text of diaries are externalizations following quasi in real-time (with a distance of a few hours) what people experience and how they interpret facts. Sometimes, diaries enable a reader to see how they diarists think about their past experiences, and how their interpretations of events change through time. The regularity of externalization also reveals, paradoxically, the alteration of daily life, and thus offers an excellent entry on ruptures and transitions.

On the basis of such methodological reasoning, we engaged in a research project on the ruptures experienced by a young woman during World War II in England. Data was given by her diaries produced in the frame of the Mass-Observation project, launched in England at the beginning of World War II. This project asked people to write their diaries and send them to the project leader so as for people to constitute “an anthropology of ourselves” (Bloome, Sheridan, & Street, 1993). Our analysis comprised the daily externalizations that constitute the diary, together with daily newspapers and documents to which people had access at that time. We could thus on one side identify objective events likely to be perceived as ruptures, such as the declaration of war, the first bombings, or Bevin’s call inciting women to work on the “home-front”. We could on the other side identify, through a close analysis of the young woman’s writing, what events she might have actually perceived as ruptures, and transition processes in which she engaged (Gillespie et al., 2008; Zittoun et al., 2008).

To identify ruptures, we were attentive to several cues. Considering the written text as a form of externalization of the young woman’s flow of consciousness or “stream of thought” (James, 1890), we observed its alterations. For example, during some long periods the young woman reports a few lines of short sentences in quite monotonous, repetitive way. In contrast, after some events, she writes long pages of a very dynamic discourse. Also, in these pages, there are occurrences of highly dialogical, reflective, and exploratory texts, which we have called “dialogical knots” (Gillespie et al., 2008). These were marked by numerous reports of diverse interlocutors’ positions (her’s in the present and in the past, other peoples), changing pronouns and verbal times, explorations of real and alternative scenarios and their consequences, etc. Over a longer period, ruptures were also appearing retrospectively, for example when the young woman observed how much her life had changed since such and such events, or when comparing her life at anniversary dates to other calendar events (Zittoun, *in press-a*).

### ***Micro-processes of Transitions***

If we admit changes as part of complex developmental systems, any transition processes might be decomposed into more minute transitions. Reversely, studying micro-processes of transition might highlight processes occurring not only in isolation, but also as part of wider transitions. As mentioned above, phenomenon at this scale might for example facilitate the identification of cues for wider transitions. We can here mention a few techniques for the collection of micro-processes of transition.

If the goal is to study naturally occurring transitions, one method consists in using data produced over a long period of time, to identify afterwards some events that might have been perceived as ruptures, and to engage in a close analysis of its suites. Some studies identify minute changes that happen to be part of a broader developmental dynamic (e.g., becoming a professional, language acquisition). For example, de Saint-George and Filliettaz (2008) regularly filmed young apprentices’

daily manual, physical and verbal interactions in the work place. Their close analysis of discourse and gestures follows micro-adjustment to the newness of these situations. In a different field, Nelson and her colleagues analyzed the audio recordings of a little girl's self-narration before falling asleep over a period of a few months. They could then engage in minute analysis of the micro-processes, or more brusque changes of her discourse (Nelson, 2006). Interviewing students over a period of 2 years, Bell et al. (2005) combined their analysis of the micro-transitions occurring during interviews, with their analysis of changes over the whole period. Other studies become focused on ruptures of a specific type, such as "aha" moment, "prise de conscience," or acquisition of reflectivity. Gillespie (2006) thus analyses interviews made with tourists, and focuses on moments in which the discourse reveals a change of perspective (e.g., leading them to realize that they behave as much as "tourists" than other people that they criticize) manifested by a change in the use of pronouns.

If the purpose is to understand the micro-processes of transitions, one can also provoke ruptures and see how these are resolved. Some researchers thus create experimental and quasi experimental setting in which they ask their participants to verbalize their thinking as their action unfolds. For example, Abbey and Valsiner (2004) created situations in which people were exposed to disrupting situations and had to speak aloud about how they were making sense of it. Such technique is possible only in relation to events decided in advance as potentially experienced as ruptures by the researcher.

### ***From Micro to Transitions***

The techniques just illustrated enable to render visible micro-processes of transitions. At this scale, such processes are not always accompanied by the person's sense of a rupture. However, they might lead to durable changes, either through an accumulation of micro-changes, or by "breaking through" and actually becoming cause, or part of a rupture. Also, they might play an important role in our understanding of real-life transitions. On a methodological plane, these close analyses might suggest which cues might be then used to identify ruptures and transitions in life trajectory data. On a theoretical plane, the study of micro-transitions might help to better understand what transitions are made of. Of course, when ruptures are induced by the researcher, then one has to question the possibility of generalizing what is learned from observations, especially if one admits that one of the key aspects of ruptures is their personal significance.

### **Combined Methods: Accounting for Complexity**

Currently, difficulties attached to one or the other techniques call mostly for a combination of post-hoc and real-time data, within larger and shorter time-spans. Here, I mention two strategies based on the gathering of a plurality of data and their combination so as to account for phenomena in their systemic complexity.

### *Institutional Case Studies*

Transitions in people's lives can occur as the settings in which they live and work are transformed. They can also be supported by institutions. Case studies of institutions thus offer rich data to analyze transitions in their sociocultural contexts. They can combine the analyses of a given setting of activity and its link with its context, of actual interactions, of key individual perspectives. Hence they can offer a frame to examine the relationship between intra-psychological changes and changes in the social world (Beach, 1999, 2003; Heath, 1996, 2004; Miles et al., 2002; Zittoun, 2004, 2006b). For example, called to document the transformation experienced by teachers and students in a professional school after the introduction of a computer-controlled production unit, Perret and Perret-Clermont (2004) combined several types of data. Analysis of archives and official documents enabled to attest for the contextual socio-historical changes; video-recordings of everyday interactions enabled to capture micro-processes in real-life, during which teachers and students had to renegotiate their respective roles and status around a new object; and interviews with them gave voice to their personal perception of the changes over a longer period.

### *Situated Case Studies*

Similarly, case of individual changes might be apprehended more fully when a plurality of data and sources are combined. The most obvious way of elaborating a non institutional case-study is to start from a case which is already part of the public discourse and about which a plurality of data does exist. The case of the young woman writing a diary mentioned above is such a case; as her life occurred at a time of important societal events, and thanks to the fact that historical distance enables to identify significant information, we combined the first-person perspective of the diary, with the information given by other persons in their diaries during the same period (see also, Richards & Sheridan, 1987; Sheridan, Street, & Bloome, 2000), daily newspapers, scholarly researches about the period, and so forth. In his analysis of significant changes in the life of Malcolm X, Gillespie (2005) combined data given from Malcolm X's autobiography with letters from his correspondence, public discourse written by him, and other information about him.

One could also imagine combining first person reconstructive and/or quasi real-time interviews with information gathered in the significant life environment of that person—interviews of significant others (e.g., families, on the work place), observations of daily interactions, information about the setting and its implicit and explicit frame for action, etc. How this information, from different perspectives and at different levels of analysis, is then combined to give an

understanding of the whole that constitutes the transition under study, is then to be decided from case to case.

## Concluding Words

This chapter proposed an exploration of available methodological strategies for the study of transitions in life trajectories. These strategies have been selected as they could respect some theoretical assumptions characterising a developmental approach, and offer solutions to certain challenges. Firstly, it is possible to approach the time-dimension of transitions, if one examines transitions as processes in the becoming, whose outcomes are not predicable in advance, but can be retraced through reconstructive techniques. Secondly, a dynamic system approach gives a good frame to show the mutual dependency of intra-psychological change, interpersonal change, and social transformation. Thirdly, the propositions made here had at their core the processes of meaning making in which a particular person is engaged. Fourthly, idiographic approaches to development enable to preserve the richness of data. The pair of notions rupture-transitions, offering a methodological unit, also might help to identify theoretically equivalent cases (Sato et al., 2007), and offer a middle-distance notion as a step towards generalisation (Zittoun, [in press-b](#)).

However, the attempt to capture a person's meaning making in transitions has brought me to raise a specific technical problem: that of identifying in the data cues signalling that the situation under study is actually attached to a rupture perceived by the person. My overall proposition is to consider data as form of externalisation produced either as the flow of events constituting transitions following perceived are happening, or as an externalisation manifesting the person's reaction as she is remembering such events. In both cases, the flow of the person's externalisation—always part of her meaning making processes—is likely to be affected by the proximity of a personally significant rupture. Externalisation can be made through different semiotic modes—verbal, gestual, graphic, etc. The researchers have then to identify how, in the particular mode they consider, the experience of rupture is manifested. Hence, the key-point is to give oneself theoretical notions and methodological techniques to identify cues of ruptures in a given semiotic mode. On the one hand, researches in other disciplines, but specialised in the modifications of semiotic modes, can be of great help: for example, clinical studies of discourse or semiotic studies of graphic representation, can provide useful indications. On the other hand, studies of micro-transitions might render visible the processes whereby dynamics of transitions are actually generated.

Once the notion of transition becomes theoretically grounded, and translated into non trivial methodological techniques, it can offer an entrance to a better understanding of dynamics of catalysed changes in life-trajectories.



## References

- Abbey, E., & Valsiner, J. (2004). Emergence of meanings through ambivalence [58 paragraphs]. *Forum Qualitative Sozialforschung/Forum: Qualitative Social Research [On-line Journal]*, 6(1), Article 23. Retrieved January 10, 2006, from <http://www.qualitative-research.net/fqs-texte/21-05/05-21-23-e.htm>
- Abraham, N., & Torok, M. (1987). *L'écorce et le noyau*. Paris: Flammarion.
- Ammaniti, M., & Stern, D. N. (Eds.). (1991). *Psychoanalysis and development: Representations and narratives*. New York: New York University Press.
- Bakhtin, M. M. (1982). *The dialogic imagination: Four essays*. Texas: University of Texas Press.
- Bartlett, F. C. (1920). Some experiments on the reproduction of folk stories. *Folk-Lore*, 31, 30–47. Retrieved January 1, 2008, from <http://www.bartlett.sps.cam.ac.uk/SomeExperimentsOn.htm>
- Beach, K. D. (1999). Consequential transitions: A sociocultural expedition beyond transfer in education. *Review of Research in Education*, 24, 101–139.
- Beach, K. D. (2003). Consequential transitions: A developmental view of knowledge propagation through social organisation. In T. Tuomi-Gröhn & Y. Engeström (Eds.), *Between school and work: New perspectives on transfer and boundary-crossing* (pp. 39–62). New York: Pergamon.
- Bell, N. J., Wieling, E., & Watson, W. (2005). Identity development during the first two university years: Exploring intersections between micro-, ontogenetic processes. *New Ideas in Psychology*, 23, 53–73.
- Billett, S. (2003). Vocational curriculum and pedagogy: An activity theory principle. *European Educational Research Journal*, 2(1), 6–20.
- Bloome, D., Sheridan, D., & Street, B. V. (1993). *Reading mass-observation writing*. Sussex: University of Sussex Library.
- Branco, A. (2007). Cultural complexities and scientific development. *Integrative Psychological and Behavioral Science*, 41(1), 4–49.
- Bruner, J. S. (1990). *Acts of meaning*. Cambridge: Harvard University Press.
- Bruner, J. S. (1991). The narrative construction of reality. *Critical Inquiry*, 18(1), 1–21.
- Carugati, F. (2004). Learning and thinking in adolescence and youth. How to inhabit new provinces of meaning. In A.-N. Perret-Clermont, C. Pontecorvo, L. Resnick, T. Zittoun, & B. Burge (Eds.), *Joining society: Social interaction and learning in adolescence and youth* (pp. 119–140). Cambridge/New York: Cambridge University Press.
- Chatiliez, E. (1988). *La vie est un long fleuve tranquille*. French movie distributed by MK2 diffusion.
- Cornish, F., Zittoun, T., & Gillespie, A. (2007). A cultural psychological reflection on collaborative research. Conference essay: ESF exploratory workshop on collaborative case studies for a European cultural psychology [37 paragraphs]. *Forum Qualitative Sozialforschung/Forum: Qualitative Social Research*, 8(3), Article 21.
- Coulon, A. (2004). Becoming a member by learning the rules. In A.-N. Perret-Clermont, C. Pontecorvo, L. Resnick, T. Zittoun, & B. Burge (Eds.), *Joining society: Social interaction and learning in adolescence and youth* (pp. 109–118). Cambridge: Cambridge University Press.
- de Saint-George, I., & Fillietaz, L. (2008). Situated trajectories of learning in vocational training interactions. *European Journal of Psychology of Education*, 23(2), 213–233.
- Doise, W. (1982). *L'explication en psychologie sociale*. Paris: Presses Universitaires de France.
- Dominicé, P. (2007). *La formation biographique*. Paris: L'Harmattan.
- Duveen, G., & Lloyd, B. (Eds.). (1990). *Social representations and the development of knowledge*. Cambridge: Cambridge University Press.
- Elcheroth, G., Forney, Y., Gauthier, J.-A., Ghisletta, P., le Goff, J.-M., Spini, D. et al. (2003). *Trajectories, stages, transitions and events of the life course: Towards an interdisciplinary perspective* [Working document for the Pavie 2003 research colloquium]. Lausanne: Centre for life course and life style studies.

- Erikson, E. (1972). *Adolescence et crise. La quête de l'identité*. Paris: Flammarion. (Original work published 1968)
- Erikson, E. H. (1968). *Identity. Youth and crisis*. London: Faber & Faber.
- Erikson, E. H. (1995). *Childhood and society*. London: Vintage. (original work published 1950)
- Flick, U. (1992). Triangulation revisited: Strategy of validation or alternative? *Journal for the Theory of Social Behaviour*, 22(2), 175–197.
- Flyvbjerg, B. (2006). Five misunderstandings about case-study research. *Qualitative Inquiry*, 12(2), 219–245.
- Fogel, A. (2006). Dynamic systems research on interindividual communication: The transformation of meaning-making. *Journal of Developmental Science*, 1(1), 7–28.
- Fogel, A., King, B. J., & Shanker, S. G. (2008). *Human development in the twenty-first century*. New York: Cambridge University Press.
- Fuhrer, U. (2003). *Cultivating minds: Identity as meaning-making practice*. New York, NY: Routledge.
- Gillespie, A. (2005). Malcolm X and his autobiography: Identity development and self-narration. *Culture & Psychology*, 11(1), 77–88.
- Gillespie, A. (2006). *Becoming other: From social interaction to self-reflection*. Greenwich: InfoAge.
- Gillespie, A. (2007). The social basis of self-reflection. In J. Valsiner & A. Rosa (Eds.), *Cambridge handbook of socio-cultural psychology* (pp. 678–691). Cambridge: Cambridge University Press.
- Gillespie, A., Cornish, F., Aveling, E.-L., & Zittoun, T. (2008). Living with war: Community resources, self-dialogues and psychological adaptation to World War II. *Journal of Community Psychology*, 36(1), 35–52.
- Grass, G. (2007). *Peeling the onion* (M. H. Heim, Trans.). London: Harvill Secker.
- Green, A. (1973). *Le discours vivant*. Paris: Presses universitaires de France.
- Grossen, M., & Salazar Orvig, A. (Eds.). (2006). *L'entretien clinique en pratiques: Analyse des interactions verbales d'un genre hétérogène*. Paris: Belin.
- Gyger Gaspoz, D. B. (in preparation). *Impacts sur les adolescents d'une mobilité professionnelle et géographique récurrente des parents: quelles réponses individuelles et collectives?* Ph.D. thesis, Université de Neuchâtel. (Manuscript in preparation).
- Habermas, T. (2001). Objects: Material. In N. J. Smelser & P. B. Baltes (Eds.), *International encyclopedia of the social & behavioral sciences* (pp. 10797–10801). Oxford: Elsevier.
- Hasse, C. (2002). Gender diversity in play with physics. The problem of premises for participation in activities. *Mind, Culture and Activity*, 9(4), 250–270.
- Hasse, C. (2008). Learning and transition in a culture of playful physicists. *European Journal of Psychology of Education*, 23(2), 149–164.
- Heath, S. B. (1996). Ruling places: Adaptation in development by inner-city youth. In R. J. Colby & R. Shweder (Eds.), *Ethnography and human development, context and meaning in social inquiry* (pp. 225–251). Chicago: University of Chicago.
- Heath, S. B. (2004). Risks, rules, and roles: Youth perspectives on the work of learning for community development. In A.-N. Perret-Clermont, C. Pontecorvo, L. Resnick, T. Zittoun, & B. Burge (Eds.), *Joining society: Social interaction and learning in adolescence and youth* (pp. 41–70). Cambridge: Cambridge University Press.
- Henderson, S., Holland, J., McGrellis, S., Sharpe, S., & Thomson, R. (2007). *Inventing adult-hoods. A biographical approach to youth transitions*. London: Sage.
- Hundeide, K. (2004). A new identity, a new life-style. In A.-N. Perret-Clermont, C. Pontecorvo, L. Resnick, T. Zittoun, & B. Burge (Eds.), *Joining society: Social interaction and learning in adolescence and youth* (pp. 86–108). Cambridge/New York: Cambridge University Press.
- Hviid, P. (2002). *Børneliv i udvikling. Om børns engagementer i deres skole og fritidsliv*. (Child-life in development. On children's engagements in school and after school-care). Unpublished Ph.D., University of Copenhagen—Denmark.
- Hviid, P. (2008). Next year we are small, right? Different times in children's development. *European Journal of Psychology of Education*, 23(2), 183–198.

- James, W. (1890). *Principles of psychology*. London: Macmillan.
- James, W. (1984). *Psychology: Briefer course*. Cambridge, MA: Harvard University Press. (Original work published 1892)
- Kohler Riessman, C. (1993). *Narrative analysis. Qualitative research methods* (Vol. 30). Newbury Park: Sage.
- Konopásek, Z. (Ed.). (2000). *Our lives as database. Doing a sociology of ourselves: Czech national transitions in autobiographical research dialogues*. Prague: Univerzita Karlova V Praze, Nakladatelestvi Karolinum.
- Lakoff, G., & Johnson, M. (1980). *Metaphors we live by*. Chicago: University of Chicago Press.
- Lave, J., & Wenger, E. (1991). *Situated learning: Legitimate peripheral participation*. Cambridge: Cambridge University Press.
- Lejeune, P. (2000). "Cher écran..." *Journal personnel, ordinateur, internet*. Paris: Seuil.
- Leonard, R., & Burns, A. (2006). Turning points in the lives of midlife and older women: Five-year follow-up. *Australian Psychologist*, 41(1), 28–36.
- Levy, R., Ghisletta, P., Goff, J. L., Spini, D., & Widmer, E. (Eds.). (2005). *Towards an interdisciplinary perspective on the life course*. Amsterdam: Elsevier.
- London, J. (1998). *John Barleycorn*. Oxford: Oxford University Press. (Original work published 1913)
- Mahmoud, H. W. (2005). *Coping with transition: The use of symbolic resources by Sudanese refugees in Cairo*. Unpublished M.Phil. dissertation, University of Cambridge.
- Marková, I. (2003). *Dialogicality and social representations: The dynamics of mind*. Cambridge: Cambridge University Press.
- Masdonati, J. (2007). *La transition entre école et monde du travail. Préparer les jeunes à l'entrée en formation professionnelle*. Berne: Peter Lang.
- McAdams, D. P. (1993). *The stories we live by: Personal myths and the making of the self*. New York: Morrow.
- McAdams, D. P., & Logan, R. L. (2006). Creative works, love, and the dialectic in selected life stories of academics In D. P. McAdams, R. Josselson, & A. Lieblich (Eds.), *Identity and story. Creating selves in narratives* (pp. 89–108). Washington, DC: American Psychological Association.
- Miles, S., Pohl, A., Stauber, B., Walther, A., Bargiela Banha, R. M., & do Carmo Gomes, M. (2002). *Communities of youth. Cultural practices and informal learning*. Hants: Ashgate.
- Nelson, K. (Ed.). (2006). *Narrative from the crib* (2nd ed.). Cambridge, MA: Harvard University press.
- Overton, W. E. (2002). Development across the lifespan. In R. M. Lerner, M. A. Easterbrooks, J. Mistry, & I. B. Weiner (Eds.), *Handbook of psychology* (Vol. 6, pp. 13–42). New York: Wiley.
- Palmonari, A. (Ed.). (1993). *Psicologia dell'adolescenza*. Bologna: Il Mulino.
- Peirce, C. S. (1878). How to make our ideas clear? *Popular Science Monthly*, 12, 286–302. Retrieved March 20, 2008, from <http://www.peirce.org/writings/p119.html>
- Perret, J.-F., & Perret-Clermont, A.-N. (2004). *Apprendre un métier dans un contexte de mutations technologiques* (2nd ed.). Paris: L'Harmattan.
- Perret-Clermont, A.-N. (2004). Articuler l'individuel et le collectif. *Nouvelle Revue de Psychologie sociale/New Review of Social Psychology*, 3(1–2), 94–102.
- Perret-Clermont, A.-N., Pontecorvo, C., Resnick, L., Zittoun, T., & Burge, B. (2004). *Joining society: Learning and development in adolescence and youth*. Cambridge: Cambridge University Press.
- Perret-Clermont, A.-N., & Zittoun, T. (2002). Esquisse d'une psychologie de la transition. *Educacion permanente*, 1, 12–14.
- Piaget, J. (1967). *Six psychological studies*. New York: Random House. (Original work published 1964)
- Piaget, J. (2003). *La psychologie de l'enfant*. Paris: Presses universitaires de France. (Original work published 1966)

- Propp, V. (1968). *Morphology of the folk tale*. Austin: University of Texas Press. (Original work published 1928)
- Richards, J., & Sheridan, D. (1987). *Mass-Observation at the movies*. London: Routledge and Kegan Paul.
- Rochex, J.-Y. (1998). *Le sens de l'expérience scolaire*. Paris: Presses Universitaires de France.
- Rutter, M. (1994). Continuities, transitions and turning points in development. In M. Rutter & D. F. Hay (Eds.), *Development through life: A handbook for clinicians* (pp. 1–25). London: Blackwell.
- Sato, T., Yasuda, Y., Kido, A., Arakawa, A., Mizogushi, H., & Valsiner, J. (2007). Sampling reconsidered: Idiographic science and the analysis of personal trajectories. In J. Valsiner & A. Rosa (Eds.), *The Cambridge handbook of sociocultural psychology* (pp. 82–106). Cambridge: Cambridge University press.
- Sheridan, D., Street, B. V., & Bloome, D. (2000). *Writing ourselves: Mass-observation and literary practices*. Cresskill: Hampton Press.
- Smelser, N. J. (1980). Issues in the study of love and work in adulthood. In N. J. Smelser & E. H. Erikson (Eds.), *Themes of work and love in adulthood* (pp. 1–28). London: Grant McIntyre.
- Sutherland, J. (1998). Explanatory notes. In J. London (Ed.), *John Barleycorn*. Oxford: Oxford University Press.
- Tisseron, S. (1999). *Comment l'esprit vient aux objets*. Paris: L'Aubier.
- Tisseron, S. (2000). *Enfants sous influence. Les écrans rendent-ils les jeunes violents?* Paris: Armand Colin.
- Valsiner, J. (2007). *Culture in minds and societies: Foundations of cultural psychology*. New Delhi: Sage.
- Valsiner, J. (2008). Baldwin's quest: A universal logic of development. In J. Clegg (Ed.), *Observing human condition*. New Brunswick, NJ: Transaction Publishers.
- Valsiner, J. & Rosa, A. (Eds.). (2007). *The Cambridge handbook of sociocultural psychology*. Cambridge: Cambridge University press.
- van Geert, P. (1988). The concept of transition in developmental theories. In W. M. Baker, L. P. Mos, H. V. Rappard, & H. J. Stam (Eds.), *Recent trends in theoretical psychology* (pp. 225–236). New York: Springer Verlag.
- van Geert, P. (2003). Dynamic systems approaches of modeling of developmental processes. In J. Valsiner & K. J. Conolly (Eds.), *Handbook of developmental psychology* (pp. 640–672). London: Sage.
- Vermersch, P. (2006). *L'entretien d'explicitation* (5th ed.). Paris: ESF.
- von Bertalanffy, L. (1993). Le concept de système dans les sciences de l'homme. In *Théorie générale des systèmes* (pp. 119–209). Paris: Dunod.
- Vygotsky, L. (1930). *Collected works of L.S. Vygotsky. Vol. 5: Child psychology*. New York: Plenum Press. (Original work published 1930)
- Vygotsky, L. S. (1993). The fundamentals of defectology. In L. S. Vygotsky (Ed.), *Collected works* (Vol. 2). New York: Plenum Press. (Original work published 1929)
- Vygotsky, L. S. (1997). *Pensée & langage* (F. Sève, Trans., 3rd ed.). Paris: La dispute. (Original work published 1934)
- Vygotsky, L. (2004). The historical meaning of the crises in psychology: A methodological investigation. In R. W. Rieber & D. K. Robinson (Eds.), *The essential Vygotsky* (pp. 227–257). New York: Kluwer Academic. (Original text from 1926)
- Wagoner, B. (2007). Overcoming psychology's methodology: Finding synthesis beyond the American and German–Austrian Division. *Integrative Psychological and Behavioral Science*, 41(1), 60–74.
- Wagoner, B. (2009). Experimental methodology of constructive microgenesis. In J. Valsiner, P. C. M. Molenaar, M. C. D. P. Lyra, & N. Chaudhary (Eds.), *Dynamic process methodology in the social and developmental sciences* (pp. 99–121). New York: Springer.
- Wapner, S., & Craig-Bray, L. (1992). Person-in-environment transitions: Theoretical and methodological approaches. *Environment and Behavior*, 24(2), 161–188.

- Wapner, S., & Demick, J. (2005). Critical person-in-environment transitions across the life span. In J. Valsiner (Ed.), *Heinz Werner and developmental science* (pp. 285–305). New York: Kluwer.
- West, L. (2006). Managing change and transition. A psychosocial perspective on lifelong learning. In P. Sutherland & J. Crowther (Eds.), *Lifelong learning: Concepts and contexts* (pp. 39–47). Oxon: Routledge.
- Zittoun, T. (2003). The hidden work of symbolic resources in emotions. *Culture & Psychology*, 9(3), 313–329.
- Zittoun, T. (2004). Preapprenticeship as a transitional space. In A.-N. Perret-Clermont, C. Pontecorvo, L. Resnick, T. Zittoun, & B. Burge (Eds.), *Joining society: Social interaction and learning in adolescence and youth* (pp. 153–176). Cambridge: Cambridge University Press.
- Zittoun, T. (2005). *Donner la vie, choisir un nom. Engendrement symboliques*. Paris: L'Harmattan.
- Zittoun, T. (2006a). *Transitions. Development through symbolic resources*. Greenwich, CT: InfoAge.
- Zittoun, T. (2006b). *Insertions. A quinze ans, entre échecs et apprentissage* [Insertions. Being fifteen, from failure to apprenticeship]. Berne: Peter Lang.
- Zittoun, T. (2007a). Processes of interiority. In L. Simão & J. Valsiner (Eds.), *Otherness in question: Development of the self* (pp. 187–214). Greenwich, CT: InfoAge.
- Zittoun, T. (2007b). Symbolic resources and responsibility in transitions. *Young. Nordic Journal of Youth Research*, 15(2), 193–211.
- Zittoun, T. (2008). Development through transitions. *European Journal of Psychology of Education*, 23(2), 165–181.
- Zittoun, T. (in press-a). Sign the gap: Dialogical self in disrupted times. In H. Hermans & A. Konopka (Eds.), *Studia Psychologica*.
- Zittoun, T. (in press-b). Children's uses of cultural objects in their life trajectories. In J. Valsiner, S. Salvatore, S. Strout, & J. Clegg (Eds.), *YIS: Yearbook of idiographic science 2007*.
- Zittoun, T., Aveling, E.-L., Gillespie, A., & Cornish, F. (in press). People in transitions in worlds in transition: Ambivalence in the transition to womanhood during WWII. In A. C. Bastos, K. Uriko, & J. Valsiner (Eds.), *Cultural dynamics of women's lives*. Charlotte, N.C.: Information Age Publishers.
- Zittoun, T., Cornish, F., Gillespie, A., & Aveling, E.-L. (2008). Using social knowledge: A case study of a diarist's meaning making during World War II. In W. Wagner, T. Sugiman, & K. Gergen (Eds.), *Meaning in action: Constructions, narratives and representations* (pp. 163–179). New York: Springer.
- Zittoun, T., Duveen, G., Gillespie, A., Ivinson, G., & Psaltis, C. (2003). The uses of symbolic resources in transitions. *Culture & Psychology*, 9(4), 415–448.

# Chapter 19

## Dynamic Methodology in Infancy Research

Dankert Vedeler and Andrea P. Garvey

Infancy research has been a quickly expanding field in recent decades. Since the early 1970s, an increasing body of research demonstrated that the capacities of the newborn baby were far more advanced than previously assumed. New methodologies, such as eye tracking, motor movement tracking, heart rate measurements, EEG measurements, and the like, have been used in experimental settings. Furthermore, video observations have been used to follow, for example, mother-infant interaction, both in natural settings (Trevarthen & Hubley, 1978) and experimental settings, such as in the Strange Situation developed by Ainsworth to measure infant's attachment (Ainsworth, 1982).

While these methodologies and research advances have been helpful in increasing our understanding of infant's complexity, providing a more fine-grained picture of phenomena encountered in infant development, these empirical studies tended to neglect more explicit explorations of their theoretical foundations (Horowitz & Colombo, 1990). In particular, little attention has been given to revealing developmental change processes that contribute to the transformations identified in the infancy literature.

For example, experimental studies to Piaget's findings on object permanence led to the conclusion that the infant displayed a sense for object permanence at earlier ages than predicted by Piaget (Baillargeon, Spelke, & Wasserman, 1985). Accordingly, changes in infants' competence for object permanence over age were attributed to limitations in memory and motor skills, rather than to theoretically driven developmental processes, as originally described by Piaget (1954).

A very important methodological difference between Piaget, on the one hand, and the recent infant research on object permanence, on the other, should be highlighted. Piaget made use of naturalistic observations (referred to by him as "the clinical method"), while many modern infancy researchers use controlled experimental designs such as the habituation paradigm. While Piaget described cognitive development in terms of stages, his main focus was on the *transitions* between those stages.

---

D. Vedeler (✉)  
Department of Psychology  
Norwegian University of Science and Technology (NTNU)  
Trondheim NO-7491, Norway  
e-mail: dankert@svt.ntnu.no

In order for him to describe these transitions, he made use of theoretical concepts, such as *organization* and *cognitive structure* to describe the level of functioning of the child, as well as *adaptation* and *equilibration*, to describe the relationship between the child and its environment. Furthermore, he pointed out that adaptation was a two-way process: adaptation of the child to the environment (*accommodation*) and adaptation of the environment to the child (*assimilation*). Notably, this methodological approach used by Piaget, with an explicit theoretical foundation and emphasis on developmental change processes, contrasts with modern infancy research focus on standardized measures such as the habituation paradigm, emphasizing development in terms of clearly-circumscribed variables, such as memory capacity and motor skills.

In an effort to further clarify the importance of redirecting our efforts to better understand developmental change processes, we will discuss potential differences in the basic assumptions about the infant-environment relationship implicit in the prevalent research approach and the alternative we discuss herein.

## Infant-Environment Relationship

To the extent that infancy researchers make reference to a theoretical framework—more or less explicitly stated—cognitive science is the preferred paradigm (see, e.g., Spelke & Kinzler, 2007). One of the assumptions of cognitive science that is implicit in much of infancy research is the input–output model of the infant-environment relationship. Without this being explicitly stated, this kind of research makes of the infant a closed system in which the development of inner (physiological or psychological) structures is related to the information input and behaviour output of the organism. From this closed system perspective, information is an a priori input to the system, as in a pattern of sensory data that are processed to a certain structure depending on the (internal) structure of the organism (cf. Valsiner, 1997, p. 24).

Alternatively, there are two related views conceiving the developing organism (e.g., a human infant) as an open system. These two views, the conception of development as *epigenesis* and *dynamic systems approaches*, have in common that they conceptualise the infant-environment relationship as a complex and non-linear *process*, co-emerging in the context of infant development as a whole, including the physical and the social spheres of the developing infant. From this open system perspective, the input-output distinction becomes fruitless as infant and environment complement each other in a dynamic fashion.

## The Impact of Cognitive Science on Infancy Research

Within cognitive science, abstract systemic theoretical approaches (e.g., Fodor, 1975) have given way to a focus on the relationship between neurological and cognitive phenomena. This focus implicated a biological developmental perspec-

tive (e.g., Elman et al., 1999; Johnson, 1997), in which cognitive development was understood in terms of the development of the brain and other neurological systems. The attention became redirected to the nervous system as the possible central controller of motor and cognitive development. It was as though the shift was moved, away from the environment as an “external” influence, to maturational forces.

Although influenced by cognitive science, infancy researchers continued to not adopt the more systemic proposals emerging in cognitive neuroscience, such as connectionism and neural networks. Thus, most infancy research remained focused on revealing higher competence than previously assumed, pointing out the relationship between behaviour and specific neurological structures. Furthermore, such emphasis on describing behaviour in light of neuro-physiological processes is still heavily influenced by the input-output model of the infant-environment relationship described earlier. It is our contention that in such input–output models the infant is conceived as a closed system, and there is no mutuality in the relationship between organism and environment. Thus the structural aspects of the organism are described independently of the environment, in which it lives.

## **Development as an Open System: Infant-Environment Mutuality**

A mutual relationship, on the other hand, implies an ever-ongoing exchange between the infant and the environment, in such a way that changes in the infant as a consequence of environmental influences also implies changes in the environment in light of the (changed) activities of the infant. This mutuality occurs in open systems where the boundaries between input–output become blurrier, since the changes in the infant-environment relationship co-emerge.

An early description of such a relationship is offered by Piaget (e.g., Piaget, 1963) with his idea of adaptation as a dynamic relationship between assimilation and accommodation, as described above. In the case of Piaget, the relationship between assimilation and accommodation was internal to the organism. For example, a child at the same time assimilates impressions and things from the external world to its internal structures and accommodates these structures to the changing external circumstances. While Piaget defined the infant relationship to the environment in a reciprocal and dynamic manner, his emphasis remained on conceptualising adaptation as internal to the organism. In other words, the infant is beginning to be viewed as an open system but the internal–external distinction remains implicit. Later, Valsiner (1997, p. 23ff.) offers a formal description of the open system’s relationship between organism and environment, stating that biological, as well as psychological and social systems, are intrinsically open systems.

With reference to Bertalanffy (1950), Valsiner describes closed systems as systems that “do not depend for their existence on exchange relationships with their environment”. Another way of explaining the nature of a closed system is to say that it is *designed*, that is, for example, that it is based on a blueprint or is pre-programmed.



An important consequence in the functioning of a closed system is that if the structure of the system changed, the system would break down, similar to an engine that stops working if any of its parts does not function according to the engine's blueprint. However sophisticated, a computer is a closed system, that is, it is designed, both to hardware and to software, and it needs precise instructions to work. It may learn, that is, incorporate new information into its system, and thus change its way of functioning. However, this requires a very precise set of instructions, that anticipates each and every possible future learning situation and thus also close monitoring, while interacting with the real world. The ultimate consequence is that a closed system needs to be *context independent* and solutions are not emergent; instead, a closed system needs to incorporate representations of each and every possible contextual possibility into the system, as well as representations of the right action for each contextual possibility, such that the relationship between specific input to and specific output from the system always remains the same. Learning would imply that specific changes in input would lead to predefined changes in output.

It is obvious that infancy researchers inspired by cognitive science resist the idea that this closed system model as portrayed above is a proper model for infant functioning and development. However, as pointed out by Costall and Leudar (2004), while showing that infants proved to solve tasks considered as cognitive much earlier than reported by Piaget, provided that the context was appropriate, infancy cognitive researchers did not study their participants in context, but rather designed settings where context was either eliminated or highly controlled, using standardized measures such as an habituation paradigm. In most cases, these highly specific and isolated "contextual factors" were defined and operationalized as independent variables and the goal was to identify clear input (independent variable) and output (dependent variable) relationships without taking into account the potential influence of other contextual factors, not anticipated. With such a clear distinction between input, infant, and output, as well as the ambition to control or eliminate context, this kind of research could be described as representing a closed systems' view, rather than an open systems' view of the relationship between the infant and its environment, as described here above.

Furthermore, such closed systems' approaches in methodology was not easily integrated with theoretical notions of a complex and highly competent infant (e.g., as described in Stone, Smith, & Murphy, 1973). Therefore, rather than trying to corroborate their cognitive theories by their empirical findings, many infancy researchers addressed data-driven issues focused on limited and well defined infant performances such as imitation, reaching for an object, or looking time to an unexpected—as compared to an expected—event, offering an unprecedented increase in knowledge about infant capabilities. The theoretical conclusions implicit in these studies were, to a considerable extent, in terms of nativism and maturation, suggesting inborn capacities triggered and refined by environmental stimulation (see Costall & Leudar, 2004).

Open systems, on the other hand, imply that development is context dependent and emergent. This means that open systems are "dependent on exchange relationships with their environment and their structural organization is maintained, or

enhanced, by these relationships” (Valsiner, 1997, p. 23ff.). We will elaborate later on the theoretical and methodological implications of considering the human infant as an open system. Before that, in order to better understand the crucial difference between closed and open systems, let us turn to artificial intelligence, having the ambition to design machines working in the same way human cognition does. In cognitive psychology’s (including infancy research) dedication to the experimental method, the basic three-part model for research is stimulus (independent variable)—intervening variable (e.g., cognition)—response (Costall & Leudar, 2004). Stimuli and responses are observable and measured. The intervening variables, on the other hand, are non-observable and inferred from the stimulus-response relationship. Thus, there is a clear distinction between the central system (inferred and described in terms of intervening variables) and the interface with the environment, that is, stimuli and responses.

Similarly, in computer science, this distinction is fundamental and is expressed as the difference between the central system (an information processing device) and peripheral systems (such as keyboards and screens) that implement the central system’s relationship with the environment. Instead of a model for artificial intelligence based on the distinction between central and peripheral systems (which have all the constraints of closed systems), Brooks (1991) argues that an intelligent system should be based on very limited direct perception-action couplings with a minimum of processing capacity that are capable of doing a very simple job in any possible condition. Each such system, in Valsiner’s terminology, would in fact be a context independent *closed* system. However, these systems lack any elaborate central representations of external world and of the task to be performed (to the difference from the closed systems described here above). Such sub-systems in an artificial intelligent system are not defined by their function (e.g., knowledge representation, planning, language, vision, smell, etc.) but by their *activity* (e.g., sensing open space-move on/sensing obstacle-stop). *Layers* of such simple subsystems, where there is no intermediate between input and output, may in an incremental way constitute a system that may freely move around in a natural environment, handling new, non-planned situations without these situations being represented in the system. While the component simple subsystems are context independent (they react in the same way, irrespective of the situation), the layered total system (a robot) will react according to the context it finds itself in (e.g., in the simplest possible case, the robot will move around while avoiding obstacles and exploring open spaces). The way different layers interact must be specified, such that the system is in that sense designed. However, these specifications are not linked to external circumstances or specific actions of the robot, they concern only how the different layers are connected (wired) to each other. Thus, the robot as a whole will function as an open system, as its actions are context *dependent*, that is, what it does depend on the situation it finds itself in. Modern robotics took quite a different, more successful turn, as the research strategy changed from, in our terms, a closed systems’ view to an open systems’ view on the relationship between the robot and its environment. Rodney Brooks at MIT, cited here above, played a crucial role for this change in strategy. It has been followed by very interesting comparisons between “developmental

robotics” and infant development (e.g., Smith & Breazeal, 2007) featuring descriptions of the relationship between infants—as well as robots—and its environment that correspond well to Valsiner’s open systems’ view on this relationship.

Viewing the organism-environment relationship as an ongoing mutual relationship, where Heraclitean change is ubiquitous (for a synopsis on the Greek philosopher Heraclitus, see Graham, 2006), calls for theoretical and methodological approaches that capture and account for the dynamic character of such relationship. We now move on to presenting the kinds of approaches to development that imply a view of the organism as an open system: the view on development as epigenesis and dynamic systems approaches (DSA). The epigenetic view on development (e.g., Gottlieb, 2003) has not had any direct influence on infant research. However, it sets forth general principles of development that, in our view, nicely complement the DSA explication of the change processes that underlie infant development.

## Open Systems’ View on Development

### *Epigenesis: A Basic Principle for Development*

In biology, *epigenesis* is a well-known and generally accepted concept. It refers to the process through which the shape of the organism and its different parts/organs develop, taking into account that this shape is not pre-formed at conception, but emerges out of a single cell (the fertilized egg or seed) through a process of differentiation and integration, *morphogenesis* in biology, cf. the *orthogenetic principle* (Werner, 1957) in psychology.

However, in an early understanding of epigenesis, the development of the organism was considered as predetermined (Gottlieb, 2003). This view was supported by the discovery of DNA, considered as a kind of blueprint for the organism, or a programme to be implemented in the epigenesis of the organism. This view was widely adopted, in spite of findings of experimental embryology that contradicted this assumption of *predeterminism*, showing that the implementation of the gene information was highly influenced by environmental factors.

Gottlieb (e.g., 2003) was a pioneer in showing that the blueprint view was not fruitful, both by careful experimentation carried out by himself and referring to earlier research. Altogether, Gottlieb shows that the expression of genes is dependent on timing as well as situational and environmental circumstances. For example, Gottlieb (2003, p. 9) referred to one of the earliest experiments in experimental embryology (carried out by Hans Speman in 1918) where a transplantation of head (potential brain) tissue from an embryo early in the development (in the blastulad stage) to the back of another embryo of the same species (newt) resulted in the tissue developing according to its new environment. In contrast, the same transplantation later in development (end of the gastrulation stage) led the brain tissue to develop into a third eye on the back of the animal. Similarly, embryonic stem cell research demonstrates the plasticity of cells and how their specificity and function emerge in

light of its location in relation to its neighboring cells. Another well-known example of this dynamic sensitivity of the organism in relation to its environment is prenatal sexual differentiation. While the 23rd pair of chromosome is often viewed as determining one's anatomical sex, environmental influences such as prenatal exposure to sex hormones can transform that process, resulting, for instance, in a chromosomal female (i.e., xx) who is anatomically male. Thus developmental outcome, even at the cell level, depends both on timing and the surround. As highlighted by Gottlieb: "Although we do not know what actually causes cells to differentiate appropriately according to their surround, we do know that it is the cell's interaction with its surround, including other cells in that same area, that causes the cell to differentiate appropriately" (2003, p. 9).

Recent research on the notion of epigenome (also known as "ghost genes") hints at an understanding of a complex, non-linear view of genes-environment relationship. This line of research argues that "(...) complex human conditions (such as obesity and cancer) can arise from environmental alteration of the epigenome" (Luedi et al., 2007, p. 1728). To put it simply, the epigenome works as a form of parallel genome by instructing genes in an organism's genotype to be activated or not. Alterations in the epigenome (and what, when and where genes get activated) result from complex interactions with environmental conditions, thereby contributing to varied phenotypes even in identical twins raised in similar environments (Dolinoy, Huang, & Jirtle, 2007). The research on the epigenome thus further substantiates the argument for the integration of levels in the systems view of psychobiological development proposed by Gottlieb, from genes to culture.

The epigenome seems to be a worthy candidate for assuring gene regulation according to the surroundings of the single cell. This regulation, in turn, is mutual and is better understood when we take the time dimension into perspective. In other words, the gene expression will result in new cells that, over time, will change the cells surroundings, in turn, possibly altering the epigenome and the further expression of the genome. This is the central implication of epigenesis that we want to stress here: Each future state of the organism depends on its present and earlier states, including the present environment. These recent findings about the epigenome and cell plasticity nicely substantiate the open system's character of biological organizations. There is a continuous reciprocity between the organism and its surround, such that the organism continuously ingests nutrition and sensory impressions (by no means passive processes, as the input-output model suggests) while at the same time the organism acts on the environment, thus changing it.

As discussed above, the same mutuality works at the cellular level. Knowledge about the functioning of the epigenome gives a precise, biochemical description of the nature of this reciprocity. It is also important to point out that the sensitivity of the epigenome to history and the environment may lead it to give instructions to the genome that are not necessarily beneficiary to the organism. For example, the genome contains potentials for developing cancer cells. Normally, the epigenome "silences" such genes, preventing them to be expressed. However, under certain (environmental) circumstances that is not the case, and cancer may develop. As if that were not enough, the epigenome also becomes muddled with age, becoming

more prone to maladaptive influences on the expression of the genes. For the purpose of this chapter, it suffices to know that the epigenome seems to be nowhere and everywhere, it is specific to different types of cells, it changes over time and according to its immediate and distant environment (for example, chemical compounds ingested through food—the present major area of research on the epigenome, as a way of understanding the development of cancers, see e.g., Dolinoy et al., 2007).

This entire discussion is part of *epigenesis*, a strongly growing area of research in microbiology. We have here tried to point out two ideas: First, the interconnectiveness of levels of analysis in epigenesis. To take an extreme example, through the different levels of organismic functioning, culture may have an impact on epigenesis on a cellular level, and vice versa. Second, epigenesis has an historical dimension: What will happen to you in your immediate future depends on where you are now, which, in turn, depends on the succession of events and circumstances that make up your past. As a third point, we should not forget the original idea that epigenesis implies development from simpler to more complex structures.

This main premise is true for phylogenesis, the development of species, as well as for ontogenesis, the development of an individual organism. Life on earth started with single cells, some 3.5 billion years ago. Human cognition—in any understanding of these words that distinguish us from the great apes—have existed in approximately 2.5 million years (Brooks, 1991). Single cells are open systems, in continuous interaction with its environment. The simple tasks that have been solved by this interaction are survival and reproduction. Selection pressure has led to the evolution of more and more complex organisms, where survival-promoting specializations emerged, out of the condition under which organisms had to live. It is important to notice here the difference between an epigenetic view, as proposed by Gottlieb, and the common evolutionary view, where random diversity is the sole mechanism promoting “the survival of the fittest”.

With these intricate relations in the structure of the organism, at different levels of analysis, and between the organism and its environment, it is difficult to conceive development to be regulated by linear causality. But if not, how can change processes, that undeniably take place, be described? To answer this question we turn to dynamic systems approaches (DSA). Some modern infancy researchers (e.g., Fogel, 1993; Lewis, 1995) use dynamic systems principles to understand infant development as the development of a neurological organism in relational contexts. A similar movement is observed in neuroscience. Of particular note, the concept of neuroplasticity emphasizes the dynamic relationship between brain development (at all ages) and its relation to the surrounding (Doidge, 2007).

### ***Theoretical Foundations of Dynamic Systems Approaches***

More than any other theoretical approach, the DSA has provided a framework for conceptualizing the organism as a continuously active open system. In their well-known to the public book, Prigogine and Stengers (1984) proposed principles to

explain the emergent structure and behaviour of non-organic matter as well as biological and social systems; and such principles are at the basis of DSA today. According to Prigogine and Stengers, organizational changes in open systems take place whenever, and wherever, certain conditions prevail in a delimited structure and its environment without anything else being fed into the system than unspecific energy. That implies that what is fed into the system does not contain specific instructions as to *what* changes should take place. Consequently, what determines the structure and behaviour of a system are particular *relational conditions* of the system and the environment, under the influence of the unspecific energy fed into the system. Organization thus emerges in the system when certain conditions prevail, and in that sense the system self-organizes. When these ideas are transposed to psychology a qualification is in place of what will sustain and enhance the structure of the system. Information will play the same role as energy. Although structured, information is not specific to the system, but constitutes a *resource* for the system, in the same way as energy (van Geert, 2003).

Thus information does not impose structure on the system from the outside. It contains no instruction whatsoever on how the system should be organized. Organization rather emerges within the system under the influence of energy and information as resources for the system. Take, for instance, a social system where a mother provides an infant with a particular toy, a rattle, demonstrating how it can be used, by shaking it. The mother is not necessarily organizing the rattle shaking behaviour in the infant ( $\approx$  teaching the child how to make the rattle noise). What she does instead is to set the conditions under which the infant may discover the pleasure of rattle shaking. When the neurological status of the infant is appropriate and the infant is well fed and rested (energy), for instance, the *information* provided by the mother on rattle shaking (i.e., the infant sees and hears what the mother is doing) create an opportunity for the child to organize its behaviour into rattle shaking, which, most likely, will occur slightly different from the way the mother originally presented it.

Now, if we look at the same example from the assumption of the child as a closed system, the description will take a radically different turn. When the mother is demonstrating the rattle for the infant, she is literally *teaching* the infant how to make the rattle noise, that is, *she is organizing* the rattle shaking behaviour of the infant. Later on, when the infant develops a representation of a rattle, he or she will recognize a certain object as a rattle and use it as a rattle the way his/her mother taught him/her. Thus, the development of a structure in the individual is directly linked to the structure of the external world. In this sense, one could say that the environment, for example, the infant's mother, designs his or her cognition (cf. van Geert's, 2003, p. 648ff., discussion on design vs self-organization).

The closed system description of the example above resembles the way a computer works, which is often utilized by cognitive science as a viable metaphor to describe the organism-environment relationship. A computer needs both energy and information to work but is designed, a priori, by an engineer. Electric energy supports the system such that the binary instructions may function by switching currents on and off. It provides no structure to the system. However, information provides the system with structure in the form of computer programs and data input. Similarly, within this perspective, the

organism is “designed” based on its internal, inborn (hardwired) information stored in its chromosomes while external information is being fed into the organism from the environment through its sensory systems. In these cases (computer and organism, viewed as closed systems), change occurs within the constraints of a previously circumscribed system: in the computer, its hardware; and in an organism, its genotype.

The implications of these different views of a child as a closed or an open system are deep and obvious. From an educational point of view, it is the difference between the teacher feeding knowledge into the learner, on the one hand, or being a provider of optimal conditions for a self-learning process on the other. Modern pedagogy likes to conceive of the teacher as a resource. Dynamic systems approaches provide an excellent theoretical foundation for such a view.

### *Open Systems and Autopoiesis*

From a theoretical point of view, we may understand the difference between an organism as a closed or an open system in terms of organization from outside, or from inside, that is, self-organization. A car, for example, is organized from outside, it is designed by a team of engineers, and other designers, to work according to a preconceived plan. This plan might be environment-friendly, the car being equipped with solar panels that convert energy from the sun to electricity, which can run the engine. In order for the car to work as planned, every detail that is involved in the running of the engine must function according to the preconceived plan. In case of failure of one detail, the engine stops running. It is a classical example of a closed system.

Plants, on the other hand, are open systems in that they are organized in such way that solar energy directly “makes sense” to them: it allows the plant to extract carbon dioxide from the air, separate carbon from the oxygen and use this carbon in the construction of itself (cf. the concept of *autopoiesis*, Maturana & Varela, 1987). Notice that plants have not been pre-designed to perform this process, not by God, neither by the genes. Rather, the process emerged through a series of conditions that were ideal for carbon, that is, organic compounds, oxygen, water, minerals, whatever is needed for these compounds to *organize themselves* into what becomes the plant. In a simplified manner, this process *emerged* as follows: there were oxygen, carbon, and other matters such as water, which made life possible. When a certain number of these components were in place on earth, under the energy radiated from the sun, ideal conditions were in place for some of these matters to *organize themselves into living systems*. This means that different kinds of matter, when available in a certain combination under particular conditions, were able to organize themselves into a unified system, called an organism. This is the deep meaning of the famous phrase “order out of chaos”, coined by Prigogine and Stengers (1984) in their best seller book.

Thus, living systems *self-organize* under particular initial conditions and a particular kind of energy supply (Kellert, 1993). However, what is peculiar to living systems is that they also use energy to sustain continuous exchange processes with their environment, thereby producing “waste” products. These “waste” products might, in turn, benefit other living systems that may have self-organized as a result of different com-

binations of matter compounds, under similar (or different) circumstances. A good illustration of this interconnection is animals consuming oxygen discarded by plants (as well as, of course, parts of plants) and plants consuming excrements discarded by animals. Therefore, different organisms self-organize into ecological systems, functioning at more complex levels than the individual organism and the single species alone. These self-organized ecologies in turn create new potential for the system (in this case, the species) to self-organize again into even higher kinds of systems.

The principle of self-organization thus shifted our view of nature (Kellert, 1993; Kauffman, 1993) and the evolution of species. It is not only the survival of the fittest, not even the fittest for a specific ecology. Evolution emerges through self-organizing processes of existing ecological and interconnected systems, where the evolution of a particular species is intricately related to the entire surrounding ecology of this species. There is a constant give and take among the different organisms, both within a species and between species. This self-organizing nature makes individual organisms, as well as different species, open systems, where the give and take is a prerequisite for their sustainability.

To recapitulate, this dynamic systems view of life on earth is based on the concept of self-organization. Self-organization is not unique to life. Non-organic matter also self-organizes, such as the pattern formed by iron filings on a sheet of paper under the influence of a magnet underneath the paper. Self-organization is a fundamental principle of nature and it can be contrasted to organization by design (van Geert, 2003, p. 659f.). In the organization by design model, the structure of organisms is explained with reference to genetic (structured) information, information in the environment (learning), or a combination of the two. In contrast, under the perspective of the principle of self-organization, the discussion on the relative influence of genes and environment becomes fruitless. As we discussed above, living organisms (i.e., open systems) emerge and develop under specific conditions, both of the environment and of the system itself. Without DNA, there would be no organism. Without an appropriate environment, there would be no organism either. However, neither do genes, nor do environmental conditions provide the organism with structure. What genes and the environment do is to provide conditions/opportunities under which structures (or patterned organizations) may emerge through self-organization.

But what do these excursions into epigenetics and dynamic systems have to do with methodology for studying infant development? We would say: “Everything!” as it sets the basic conditions for a methodology that captures and accounts for the change processes involved in infant development.

## **An Epigenetic View and Dynamic Systems Approaches in Infant Research**

There is no explicit reference to epigenesis in research on infant psychological development. While being a central concept in biology, it is evident that an epigenetic view has much to offer in the understanding of infant development, as well as in guidance on the choice of methodology. Development takes place over time,



and in order to study development from that perspective we need concepts that handle the time dimension. We have here tried to point to the advantages of an epigenetic view in this respect, notably providing a model for handling the historical dimension of development, as well as the relationship between past, present, and future. The epigenetic view also handles the relationship between different levels of analysis, from the genome to culture, and we are indebted to Gottfried Gottlieb for making this clear to us. A combination of these two contributions of an epigenetic view, the time dimension and levels of analysis, allows us to define different time scales for development, the differences between and the relationships with which are important to handle in order to define a methodology adequate for the research question at hand.

In our approach, described and exemplified below, we make the distinction between three levels, on the one hand microgenesis, consisting of two time scales, real time in the mother-infant interaction during a particular session and historical time, accounting for the longitudinal series of sessions under study. (We contend as a fundamental methodological assumption that developmental research *must* be longitudinal, that is, in order to study change processes.) Microgenesis, in turn, should be put into the context of ontogenesis, the development of the individual as such. Beyond that, culture-genesis (Valsiner, 1997) and—ultimately—phylogenesis and the development of our planet are time scales that are linked to what happens with the epigenome at the time scale of cellular development. For our purpose, a methodology is chosen on the microgenetic time scale, as it has the greatest potential to account for ontogenesis in a context of social relations, which we consider as fundamental to our understanding of the development of the human infant.

DSA, on the other hand, has since long challenged the closed system's view of infant development described above. One may discern two kinds of approaches in infant research that make reference to Dynamic Systems Approaches: *mathematical* and *metaphorical*. The former approaches conceptualise development in mathematical terms, or at least aims at such a conceptualization, and thus are referred herein to as mathematical dynamic systems approaches. They have strong links to the natural sciences and, while recognizing the complexity of the system, try to identify variables (control parameters) that regulate changes in the system. The pioneering work of Esther Thelen and her collaborators, focusing on infant motor development, is the most typical proponent of this trend (see Thelen & Smith, 1994, for a comprehensive overview). This mathematical approach has also been used to study cognitive development, language development, and the like (Smith, Thelen, Titzer, & McLin, 1999). The goal is to predict, and possibly control, the development of the system by potentially redirecting the self-organization of the system towards a preferred direction. Within these approaches, two methodologies are often utilized: differential equations and/or computer simulations (Luenberger, 1979; van Geert, 2003), as illustrated in the area of “developmental robotics” (Smith & Breazeal, 2007).

The main focus of research from this approach has been Thelen and collaborators' studies on infant motor development, in particular walking (e.g., Thelen, Kelso, & Fogel, 1987). In the cognitive field, the most well-know example (which

is enlightening in regard to our previous discussion of the distinction between an open system's view, as opposed to a closed system's view) is based on the work of Piaget (1963) on the fourth sensorimotor substage. Specifically, Piaget observed that infants between 8 and 12 months understood that an object continues to exist even when out of sight (his concept of object permanence), however, this understanding of object permanence being dependent on the place where the object used to be. He noted that when repeatedly hiding a toy under the same pillow out of the two available, the child will consistently look under the "right" pillow where the object is repeatedly hidden. However, if you then hide the toy under the other pillow while the child is watching you hiding it, the child will nevertheless continue to look under the pillow where the toy used to be hidden. This observation has been named "the A-not-B error".

Let us compare different explanations of this phenomenon. Piaget's own explanation was that a complete object concept at that stage is not yet fully integrated in the child's cognitive structure. Therefore, the toy will be dependent on the external context in which it is conceived to be, also when the child does not have direct visual contact with it. A behaviourist explanation would be in terms of reinforcement by earlier successful retrievals of the toy. The cognitive explanation would be in terms of an internal mental image that is not yet complete, and which prevents the child to remember the object as such (on object permanence, cf. reference to Baillargeon, et al., 1985, here above, p. 431). The DSA explanation offered by Thelen's team (e.g., Smith, et al., 1999) is that the issue is not about an object concept or representation, but about actions in context. Repeated retrievals of the toy under the first (A) pillow has provided the conditions for the self-organization of the infant's behaviour into a strong habit for action (an attractor state, in DSA terminology) where looking and reaching are strongly integrated. The second pillow simply is not a part of this behavioural attractor state, that is, the child does not pay attention to it. If you were, right before reaching for the toy to hide it, drawing the child's attention to the second pillow, it will be taken into account as a possible hiding place for the toy. According to Thelen, the unaided inclusion of attention to the second pillow into a more complete system will require a more advanced mobility (walking around), where attention to different objects in the surround cannot be so tightly coupled with any actual action. (For a detailed, and at the same time succinct account of the DSA explanation of the A-not-B error, see van Geert, 2003, p. 661f.).

While the theoretical explanation of these results distinguishes the studies of Thelen's team, they follow about the same experimental design as studies among other modern infancy researchers, notably doing controlled experiments without considering the social-cultural contexts of infants' activities (see Spencer, Smith, & Thelen, 2001). The theoretical explanation takes the child's earlier and general experiences into account, as well as the real time processes in the experimental situation. However, as the conclusions are based on out of context group data, the underlying assumption suggests that the same processes are taking place in any child placed in the same situation. In DSA terminology, the aim of the studies is to identify relevant *control parameters* that explain why the child behaves in one or

the other way, in the case of the A-not-B error, self locomotion, as described above (Thelen & Smith, 1994, p. 304).

Another dynamic systems approach, referred herein to as metaphorical, does not aim to identify key control parameters of complex developmental systems. Instead, using qualitative and life history methodological traditions, the goal is to describe the subtle steps in the developmental process. Within this metaphorical approach, describing is explaining because it is through detailed descriptions of the dynamics of self-organization that one explains the functioning of the system. The purpose of this approach is thus different from that of mathematical inclination. There is no attempt at describing a mechanism at work, but rather at describing the processes involved in the evolution of the system. In other words, developmental—and historical—processes are revealed through detailed descriptions over time of, for example, mother-infant interaction in individual dyads.

## The Relational-Historical Approach

In infancy research, one of the most notable sources of inspiration for this metaphorical approach is the work of Fogel and his collaborators, referred by them to as the relational-historical approach (e.g., Fogel, 1993; Fogel & Garvey, 2007; Fogel, Garvey, Hsu, & West-Stroming, 2006; Fogel & Lyra, 1997). In addition to its emphasis on descriptive research, an important contribution of the relational-historical approach is its focus on the relationships the infant has with its environment, physical and social.

The concept of *co-regulation* is crucial in this approach as it implicates that developmental changes co-emerge as infants engage in relational processes with their primary caregivers. In Fogel and Garvey's (2007) words:

co-regulated communication occurs (...) when partners are open to mutual influence, and when the resulting process creates new information, information that was not entirely available to the participants prior to this instance of their joint engagement (p. 252).

The relational-historical approach is also comprehensive in that it covers infant development from an *historical* perspective. Each relationship is deployed in time: in real time, through the actions that embody the relationship at a given moment, and in historical time, through the patterned routines relationally co-created through these real time exchanges. For example, in a diaper changing setting, parent and infant collaborate, more or less smoothly, through bodily movements. Specifically, as the dirty diaper is removed, followed by the parent's action of cleaning up the infant before putting a new diaper on, the parent may talk to the infant while eye contact and exchange of facial expressions are observed. All of these detailed actions constitute a complex emotional atmosphere that emerges during diaper changing in real time. Parent and infant may then co-create specific diaper change routines that tend to recur over time as previous diaper change experiences influence the ongoing parent–infant transactions. In this sense, relationships are deployed not only in real time, but also in historical time. In other words, the emergence of any given

relational routine in real time is, in part, dependent upon its historical “roots” previously and continuously co-created by the relational partners. Through these dynamics, involving real time encounters and historical time changes, each moment can be conceived of as requiring an historical understanding in which these time scales are taken into consideration (for a more detailed account on time-scales, see Fogel & Lyra, 1997; Lewis, 1995; Lyra, 2000; Thelen & Ulrich, 1991). Therefore, strongly influenced by the principle of self-organization, the relational-historical approach argues that descriptions of the details of humans’ day-to-day experiences over time are at the core of a developmental analysis (Garvey & Fogel, 2008).

### ***The Concept of Frame***

In an effort to develop an heuristic tool to capture this dynamic, time-sensitive nature of relationships, Fogel (1993) borrows the concept of *frame* from Goffman (1974). Frames are useful because they allow the observer to identify structural, recurring aspects of relational, shared experiences. Frames have been defined as “segments of co-action that have a coherent theme, that take place in a specific location, and that involve particular forms of mutual co-orientation between participants” (Fogel et al., 1997, p. 11). In other words, as participants select some actions while communicating with one another, they co-define the format of their communication, framing it in a particular way. Different body positions are observed, the use of certain tools, the performance of specific gestures, and so on, to compose and define each particular form of communication routine (or frame).

The concepts of *co-regulation* and *frames* thus allow us to shift our attention away from changes in the infant and caregiver while inter-acting to focusing on historical and relational changes in infant development. Two examples of our research studies (on infant emotions and infant intentionality) are provided, focusing on the methodological implications of the relational-historical approach with an emphasis on the principle of self-organization.

### ***The Relational-Historical Approach and Infant Emotions***

Garvey’s developmental investigation is grounded on the notion that emotions and communication constitute a dynamic developmental system (e.g., Garvey & Fogel, 2008). Emotions are viewed as relational experiences lived in bodies that co-regulate their movements with the movements of others. Inspired by dynamic systems perspective and the relational-historical approach, emotions are examined as self-organizing through communication processes. In other words, emotions emerge as the various constituents of communication (such as facial actions, gaze, body movements, vocalizations, and gestures) coalesce into coherent patterns that support infants’ meaningful relationships with others. For

a more detailed discussion of emotions from a relational-historical approach, see Garvey and Fogel (2007, 2008).

As proposed by the relational-historical approach, this perspective of emotions calls for a close examination of real-time and historical-time changes across key developmental transitions (e.g., Fogel et al., 2006; Garvey & Fogel, 2007, 2008). In Garvey's work, the key developmental transition emphasized is the well-reported transition from a primary focus on direct, face-to-face communication between mother and infant to a primary focus on object communication, observed in the first 7 months of an infant's life. This developmental analysis is accomplished using longitudinal video-recordings of mother-infant dyads, visiting a laboratory playroom three times a week for a period of 4 months, starting when the infant was 10-weeks-old. Systematic observation of free-flowing communication between an infant and his mother, multiple patterns of emotion were identified in the ways the partners of the dyad related to one another. These emotions, self-organized as frames, were co-created by the infant (whose pseudo-name is Nathan) and his mother, pseudo-named Patricia.

In the first five visits, frames involving the direct connection between Nathan and his mother, without the consistent use of objects (referred to as *social playful frames*), are observed: these frames range from playful moments involving positive emotions, composed of large smiles, vocalizations, and tactile games, to more mellow moments between Nathan and his mother involving mutual gazing, subtle smiles, and soft touches (as shown below).



In these frames, both mother and infant are predominantly co-oriented to one another, continually co-regulating their movements with respect to one another. Over time, as new information is spontaneously introduced by the mother, for instance, the infant starts staring at a toy within his sight or the mother starts playing peek-a-boo with her infant using a toy, the potential for a reorganization of the system emerges. This introduction of novelty and potential for systemic reorganization is observed between sessions 5 and 9, when Nathan and his mother begin to more consistently introduce novel activities to their existing frames. More specifically, with the inclusion of toys into their social playful frames, new emotion patterns begin to be formed (such as an increasingly more focused interest on toys) while familiar routines are also slightly modified and incorporated in the flow of the dyad's communication (referred to as *social-object playful frames*—shown below).



These newly emergent frames predominantly observed between sessions 5 and 9 thus include playful moments but also toys as part of the new dyadic patterns of emotion exchanges involving smiles, vocalizations, and mutual/alternate gazing between Nathan and Patricia. By integrating these familiar routines (i.e., social playful frames) with the novel introduction of toys, Nathan and Patricia gradually and spontaneously co-create conditions for the emergence of social-object playful frames as well as the increasing complexity in the infant's emotional repertoire.

Over time, both of these playful frames—with or without toys—appear to become less predominant while another frame emerges. Specifically, between visits 10 and 20, a phase shift in the dyad's playful routines seems to occur: Nathan begins to consistently engage in a form of absorbed toy interest by persistently exploring his hands and/or toys through mouthing, while the mother quietly observes her infant, often holding a toy in front of the infant to observe/explore or providing postural support to his explorations. This frame, which becomes gradually more predominant in the landscape of this dyad's communication system, is referred here to as *interest in toys frame* due to the dyad's clear and more serious/concentrated co-orientation towards the toy (as shown below).



These excerpts from our microgenetic analysis attempt to illustrate how the dyad partners gradually shifts their focus from direct-playful frames to frames characterized by the infant's concentrated interest in toys while the mother quietly observes him. Most importantly, the distinct emotions, that add the characteristic quality of each frame, self-organize as part of the emergence of the frames themselves. Emotions are not examined as internal states expressed outward as a result of environmental influences, often deployed by the mother. Instead, through communication routines, elements of positive emotions self-organize into recurring patterns, that is,

*frames*, co-created by the mother and her infant. In other words, the infant gradually develops distinct emotion patterns through his relational moments co-created with his primary caregivers as they navigate across key developmental transitions. Thus, infant emotions develop over time as part of this communication system, both viewed as part of an open system susceptible to changes.

### ***The Relational-Historical Approach and Infant Intentionality***

Vedeler (e.g., 1991) studies the development of infant intentionality from the perspective of conceiving infant intentionality as behavioural object directedness, rather than as mindful goal directedness, the commonplace definition in psychology. The issue addressed is the impact of the development of a caretaker-infant relationship for the development of infant intentionality. Trevarthen (1979) has described the development of infant intentionality in three stages; the first features a purely social intentionality (“primary intersubjectivity”), the second a purely thing oriented intentionality (“epoch of games”). In the third stage, “secondary intersubjectivity”, the child arrives at combining social and thing oriented intentions, thus laying a foundation for language and cognition (Trevarthen & Hubley, 1978). Trevarthen assumes that an innate capacity for combining social and thing-oriented intentions matures in the infant. As an alternative explanation, Vedeler’s research proposes that the third stage in Trevarthen’s description emerges as a consequence of the self-organization of the caretaker-infant relationship. Thus, before becoming a mental-cognitive ability of the infant, secondary intersubjectivity is manifested in the relationship as a re-organization of the concrete co-actions of caretaker and infant, for example, playing with a toy.

In order to capture the process of change leading to the dyad’s reorganization of its co-regulation to cover secondary intersubjectivity, Vedeler’s research program looks for precursors of secondary intersubjectivity in the caretaker-infant interaction from 5 to 10 months. The methodology is based on Fogel et al.’s (2006) elaboration of microgenetic design within the relational-historical approach described above. The aim is to show how the constituents of secondary intersubjectivity are built up in concrete interaction that is constrained by the history of a dyad’s relationship and the actual situation, including social and physical properties of, for example, a toy.

For that purpose, weekly video recordings of mother-infant interaction, between infants’ 5th and 10th month of life, involving the same toys, are observed and described in terms of narratives of each frame of interest. Frames are circumscribed in Vedeler’s study by the particular toy the dyad is utilizing. As the same set of toys is available at each recording session, the dyad frequently plays with the same toys over many of the weeks covered by the study. Thus, we are able to follow the development of the particular frame linked to a particular toy. Specifically, microgenetic changes in the way mother and child are playing with the toy, based on established routines linked to the particular properties of the toy, its socio-cultural significance (canalized through earlier experiences of the mother) and co-regulation of the situational circumstances of the moment are observed.

For example, Jim (child's pseudo-name) could have the habit to touch his ear when he starts getting tired. This habit creates an opportunity for new situations (new frames) to emerge when Jim happens to have a phone receiver in his hand while he touches his ear, as he usually does when he gets tired. The mother, at that moment, may spontaneously highlight Jim's action by bringing her own hand to her ear and saying, "Hello, am I talking to Jim?" This spontaneous activity captures Jim's attention: he looks at his mother, but nothing more, as he appears to be tired and starts becoming fidgety. This incident is, one could assume, forgotten. At that moment, it constitutes a small variation that maintains the usual relational routine of Jim touching his ear when he's tired. However, next time Jim and his mother play with the phone, the mother pays particular attention to the way Jim is wavering with the receiver. Specifically, any movement of the phone to his ear is highlighted by the mother and used as an opportunity to reconnect to the incident of the earlier session. These small variations in the dyad's relational routine initiate what subsequently will become a new sub-frame of the telephone frame, we may call it a "hello game". Over a few sessions, this "hello game" becomes a semi-stable routine as the mother introduces the socio-cultural significance of the phone in their play. Furthermore, one could assume that Jim had other phone experiences outside the telephone frame by watching phone conversations of adults.

We may conjecture that Jim's experiences outside the telephone frame coupled with his experiences with his mother within the telephone frame facilitate his recognition of the "hello game", thereby giving it a social significance through the mother's participation in the game. Thus, exchanges of gazes, smiles, surprise facial expressions, recurrent particular verbal phrases (such as "Hello, is it grandma calling?") become elements of the co-regulation, over time, of the routines that eventually lead to a new kind of understanding of the situation. This new understanding, we argue, involves a mutual recognition of the experience of the other as similar to one's own experience of the situation; that constitutes the essence of what Trevarthen coined secondary intersubjectivity. In other words, *shared experiences* over time have contributed to a mutual understanding of these telephone experiences as indeed shared. It is important to note, however, that this early understanding is, at the outset, limited to the frame in which it has emerged, that is, it's a *situated* shared experience. Only when the same mutual understanding has emerged in many different frames will the child achieve a more generalized secondary intersubjectivity that goes beyond the child's situated experiences.

In dynamic systems terminology, when the accumulated shared experiences within a frame are sufficiently elaborated, they will re-organize (i.e., self-organize) into mutually recognized shared experiences. It is our contention that the relational-historical approach, with its emphasis on the concept of self-organization, frames, and co-regulation, allows us to capture the build-up of situations where secondary intersubjectivity becomes possible. In other words, instead of assuming secondary intersubjectivity as the maturation of a general capacity of the human mind, we propose that secondary intersubjectivity first emerges through context-specific mutual understanding of concrete situations (referred to herein as frames), with its particular relational history, that later becomes generalized to other relational situations and becomes less context-specific.



## Conclusion: Self-Organization in a Time Perspective

In this chapter we have elaborated on two different, but linked paradigmatic approaches to development, discussing their methodological implications for research on infant development: Epigenesis and Dynamic Systems approaches. The concept of development has been taken seriously, that is, has been understood as the change processes an individual goes through in his or her first years.

Epigenesis, as understood here, accounts for ontogenesis as well as microgenesis, integrating all levels of human functioning, from the genome to society and culture. Epigenesis accounts for the relationships between levels, mutuality of their influences, and their unity as the basis for understanding ontogenesis as well as microgenesis. Epigenesis also accounts for the relationship between past and present, pointing towards the future. That development has an historical dimension is crucial to the understanding of the present situation and state of any individual, including an infant. Epigenesis also accounts for the relationship between the individual and his or her outer environment, physical, and social. It also provides an understanding of the relationship between levels, where the immediate superordinate level becomes environment for the subordinate level chosen as the unit of analysis. For example, when the cell is the unit of analysis, you cannot take environment to be the environment external to the individual. That environment is mediated by the chemical substances, whether hormonal, nutritional, etc. with which the cell has a continuous exchange. At the level subordinate to the cell as the unit of analysis, the constituents of the cell, nucleus, cytoplasm etc, are components of the cell as a system that have a certain relationship to each other. The same holds true when you are choosing the dyad mother-infant as unit of analysis. Mother and infant are components of the system linked to each other through a certain relationship. Toys, the highchair, other persons in the room, etc. are environment. In both these examples, development is accounted for in terms of an history—of the cell, or of the dyad—that is crucial for the understanding of the change processes that are taking place in present time.

While epigenesis, as understood here, accounts for the historical dimension of development, dynamic systems approaches (DSA) account for the conditions for change processes. They provide theoretical concepts for the relationships between component in a system and stipulate the distinction between system and environment to be epistemological, not ontological, that is, it is the researcher choosing a unit and level of analysis that determines what is to be considered as system and what should be environment, dependent upon the research question to be addressed. More importantly, the concepts proposed by DSA, order parameter, control parameter, attractor state, phase shift, account for both stability, and change in the system over time.

Within the DSA that we have chosen to call mathematical, and where some simple variable, the control parameter, regulates phase shifts in the system, it is at least theoretically possible that “the same” critical conditions may recur. We caution to point out that the principle of the irreversibility of time is still valid for a “mathematical DSA”, the possible “return” to an earlier state is actually not a return, but a case of recurrence of the same conditions at a later time (see, however, Witherington, 2007, for an alternative view). In the development of an individual

organism, that will never be the case. In the life cycle of the organism, similar—or identical—external circumstances can never cancel out the fact that the organism will not be the same, that its history might have set new conditions for its way of responding to the external circumstances.

As an example of dynamic *methodology* (as opposed to dynamic theory) in infant research we therefore have found the historical-relational approach more appropriate than the experimental approach chosen by Thelen's team, for instance, in the research on the A-not-B error. For the study of infant development in a socio-cultural context, as we have illustrated earlier with our own work, we see a *combination* of the epigenetic view and DSA as the proper theoretical foundation for the dynamic methodology. The epigenetic view accounts for the historical dimension that is central to the historical-relational approach. It also provides a coherent model for the interconnectedness of the different levels of analysis, putting the dyad as the unit of analysis into a context that covers all levels on which the mother-infant interaction have an impact. DSA, on the other hand, provides the concepts accounting for the developmental processes themselves, concepts accounting for stability as well as change, and for the relationship between stability and change implicated in the concept of frame. History does not only consist of revolutions, phase shifts. It also consists of repetitions, continuity, and gradual refinement of skills and smoothness of co-regulations. We hope to have been able to demonstrate, using our own work as illustrations, that the concepts of attractor, emergence, and first and foremost self-organization nicely complement the mutuality, levels of interconnectedness between levels, definition of system and environment, and specification of the historical dimension offered by the epigenetic view of development.

## References

- Ainsworth, M. D. S. (1982). Attachment: Retrospect and prospect. In C. M. Parkes & J. Stevenson-Hinde (Eds.), *The place of attachment in human behavior* (pp. 3–30). New York: Basic Books.
- Baillargeon, R., Spelke, E. S., & Wasserman, S. (1985). Object permanence in five-month-old infants. *Cognition*, *20*, 191–208.
- Bertalanffy, L. v. (1950). *General system theory*. New York: George Braziller.
- Brooks, R. A. (1991). Intelligence without representation. *Artificial Intelligence*, *47*, 139–153.
- Costall, A., & Leudar, I. (2004). Where is the 'theory' in theory of mind? *Theory & Psychology*, *14*, 623–646.
- Doidge, N. (2007). *The brain that changes itself: Stories of personal triumph from the frontiers of brain science*. New York: Penguin Books.
- Dolinoy, D. C., Huang, D., & Jirtle, R. L. (2007). Maternal nutrient supplementation counteracts bisphenol A-induced DNA hypomethylation in early development. *PNAS*, *104*, 13056–13061.
- Elman, J. L., Bates, E. A., Johnson, M. H., Karmiloff-Smith, A., Pirisi, D., & Plunkett, K. (1999). *Rethinking innateness: A connectionist perspective on development*. Cambridge, MA: MIT Press.
- Fodor, J. A. (1975). *The language of thought*. New York: Crowell.
- Fogel, A. (1993). *Developing through relationships*. London: Harvester Wheatsheaf and University of Chicago Press.

- Fogel, A., Dickson, L., Hsu, H., Messinger, D., Nelson-Goens, C., & Nwokah, E. (1997). Communicative dynamics of emotion. In K. C. Barrett (Ed.), *The communication of emotion: Current research from diverse perspectives* (pp. 5–24). San Francisco, CA: Jossey-Bass Inc.
- Fogel, A., & Garvey, A. (2007). Alive communication. *Infant Behavior and Development*, *30*, 251–257.
- Fogel, A., Garvey, A. P., Hsu, H., & West-Stroming, D. (2006). *Change processes in relationships: A relational-historical research approach*. Cambridge, UK: Cambridge University Press.
- Fogel, A., & Lyra, M. C. D. (1997). Dynamics of development in relationships. In F. Masterpasqua & P. A. Perna (Eds.), *The psychological meaning of Chaos: Translating theory into practice*. Washington, DC: American Psychological Association.
- Garvey, A., & Fogel, A. (2007). Dialogical change processes, emotions, and the early emergence of self. *International Journal for Dialogical Science*, *2*, 51–76.
- Garvey, A., & Fogel, A. (2008). Emotions and communication as a dynamic developmental system. *Espaco Tiempo*, *2*, 62–73.
- Goffman, E. (1974). *Frame analysis: An essay on the organization of experience*. New York: Harper & Row.
- Gottlieb, G. (2003). Probabilistic epigenesis of development. In J. Valsiner & K. J. Connolly (Eds.), *Handbook of developmental psychology* (pp. 3–17). London: Sage.
- Graham, D. W. (2006). Heraclite. In J. Fieser & B. Dowden (Eds.), *The internet encyclopedia of philosophy*. Retrieved October 26, 2008, from <http://www.utm.edu/research/iep/h/heraclit.htm>
- Horowitz, F. D., & Colombo, J. (Eds.). (1990). *Infancy research: A summative evaluation and a look to the future*. Detroit: Wayne State University Press.
- Johnson, M. H. (1997). *Developmental cognitive neuroscience*. Cambridge, MA: Blackwell.
- Kauffman, S. A. (1993). *The origins of order: Self-organization and selection in evolution*. New York: Oxford University Press.
- Kellert, S. H. (1993). *In the wake of Chaos: Unpredictable order in dynamical systems*. Chicago: The University of Chicago Press.
- Lewis, M. D. (1995). Cognition-emotion feedback and the self-organization of developmental paths. *Human Development*, *38*, 71–102.
- Luedi, P. P., Dietrick, F. S., Weidman, J. R., Bosko, J. M., Jirtle, R. L., & Hartmink, A. J. (2007). Computational and experimental identification of novel human imprinted genes. *Genome Research*, *17*, 1723–1730.
- Luenberger, D. G. (1979). *Introduction to dynamic systems: Theory, models, and applications*. New York: Wiley.
- Lyra, M. C. D. P. (2000). Desenvolvimento como processo de mudança em um sistema de relações historicamente construído: Contribuições do estudo da comunicação no início da vida. *Reflexão e Crítica*, *13*, 257–268.
- Maturana, H. R., & Varela, F. C. (1987). *The tree of knowledge: The biological roots of human understanding*. Boston, MA: Shambhala.
- Piaget, J. (1954). *The construction of reality in the child*. New York: Basic Books.
- Piaget, J. (1963). *The origins of intelligence in children*. New York: Norton.
- Prigogine, I., & Stengers, I. (1984). *Order out of Chaos: Man's new dialogue with nature*. New York: Bantam.
- Smith, L. B., & Breazeal, C. (2007). The dynamic lift of developmental process. *Developmental Science*, *10*, 61–68.
- Smith, L. B., Thelen, E., Titzer, R., & McLin, D. (1999). Knowing in the context of acting: The task dynamics of the A-not-B error. *Psychological Review*, *106*, 235–260.
- Spelke, E. S., & Kinzler, K. D. (2007). Core knowledge. *Developmental Science*, *10*, 89–96.
- Spencer, J. P., Smith, L. B., & Thelen, E. (2001). Test of a dynamic systems account of the A-not-B error: The influence of prior experience on the spatial memory abilities of two-year-olds. *Child Development*, *72*, 1327–1346.
- Stone, J., Smith, H., & Murphy, L. (Eds.). (1973). *The competent infant: Research and commentary*. New York: Basic Books.

- Thelen, E., Kelso, J. A. S., & Fogel, A. (1987). Self-organizing systems and infant motor development. *Developmental Review*, 7, 39–65.
- Thelen, E., & Smith, L. B. (1994). *A dynamic systems approach to the development of cognition and action*. Cambridge, MA: MIT Press.
- Thelen, E., & Ulrich, B. D. (1991). Hidden skills: A dynamic systems analysis of treadmill stepping during the first year. *Monographs of the Society for Research in Child Development*, 56, 6–46.
- Trevarthen, C. (1979). Instincts for human understanding and for cultural cooperation; their development in infancy. In M. v. Cranach, K. Foppa, W. Lepenies, & D. Ploog (Eds.), *Human ethology: Claims and limits of a new discipline* (pp. 530–594). Cambridge: Cambridge University Press.
- Trevarthen, C., & Hubley, P. (1978). Secondary intersubjectivity; confidence, confiding, and acts of meaning in the first year. In A. Lock (Ed.), *Action, gesture, and symbol: The emergence of language* (pp. 183–229). London: Academic Press.
- Valsiner, J. (1997). *Culture and the development of children's action: A theory of human development* (2nd ed.). New York: Wiley.
- van Geert, P. (2003). Dynamic systems approaches and modeling of developmental processes. In J. Valsiner & K. J. Connolly (Eds.), *Handbook of developmental psychology* (pp. 640–672). London: Sage Publications.
- Vedeler, D. (1991). Infant intentionality as object directedness: An alternative to representationalism. *Journal for the Theory of Social Behaviour*, 21, 431–448.
- Werner, H. (1957). The concept of development. In D. B. Harris (Ed.), *The concept of development* (pp. 125–147). Minneapolis: University of Minnesota Press.
- Witherington, D. C. (2007). The dynamic systems approach as metatheory for developmental psychology. *Human Development*, 50, 127–153.

## Chapter 20

# Dynamics of Psychotherapy Processes

María Elisa Molina and Maria Teresa del Rio

This book has taken up the challenge to reflect on new paths to develop research methods in psychology and social sciences. Moreover—it also leads us to the clinical field. We can consider psychotherapy as an ongoing process of meaningful exchange between interlocutors—therapist and patient—that takes place in the here-and-now time frame. Of course these features pertain to most human psychological processes that involve transformation in time and construction of meanings about the self and the other. In psychotherapy we emphasize the evolving nature of self experiencing, in permanent change and transformation with some moments of temporal stability assisted by the therapist and a therapeutic setting culturally sanctioned. If we consider in psychotherapy the question about change, or in other words, how transitory experiencing at times becomes stable and constitutes a new state in development, we should be able to search for a methodology that could apprehend transitory phenomena.

In order to analyze psychological processing and its temporal display, it is useful to take a microgenetic approach. It attempts to address the micro-evolutive process that implies the emergence of actuality in the phenomenon being under study (Valsiner & van der Veer, 2000). Through transformation and novelty it is possible to detect qualitative differences in a phenomenon displayed in time. The analysis of this article intends to approach this process taking James Mark Baldwin's conception of "genetic logic" (Valsiner & van der Veer, 2000). With this notion Baldwin points at phenomena organized as open systems oriented towards the future (opened). This kind of system displays novelty from preliminary confused states to the emergence of discernible forms, carrying on a relationship with the environment (Valsiner & Diriwächter, 2004).

This look at methodology highlights the heterogeneity of experience while it apprehends the phenomenon as it appears, avoiding classifications or abstractions that hide variability. This aspect is emphasized by Windelband (in Leendert, 1998)

---

M. E. Molina (✉)  
Escuela de Psicología  
Universidad Del Desarrollo  
Santiago 7610658, Chile  
e-mail: memolina@udd.cl

when he refers to opposite and complementary methodological perspectives: The ideographic approach to historical phenomena that appreciates them in its unique character; and the nomothetic approach that arrange the facts using abstraction and guiding principles. The first one allows considering variability of phenomena instead of reducing them through statistical operations.

Therefore, ideographic methods stress variability and temporality to the extent that they consider each piece of data as unique. From that distinctiveness it is possible to explore basic universal processes. This theoretical perspective then, appears propitious to approach subjective process (Molenaar & Valsiner, 2005; Valsiner, 2007; Valsiner & Sato, 2005)

As we have stated microgenesis comprises the actual, temporal, unique and transforming quality of psychological experience. If we visualize therapy as transition to new developmental states, we can represent it as sequences of microgenetic units that are linked with ontogeny through points of stability, reaching of new organizational levels. Even more, a macrogenetic level points at the trajectory of key notions in culture (i.e., parenting, marriage, bevereament). This would be accomplished after repeated experiences that organize meanings into more stable conceptions. For this to be accomplished, the individual exchanges with his/her environment repeatedly (Siegler & Crowley, 1991). Each exchange can be termed as a microgenetic instance within the above mentioned trajectory. Therefore, ontogenesis is a result of macro and micro permanent interplay.

Psychological experience is displayed in the here-and-now moment—as passing through from one moment to the other. For our purposes, what should be our focus? We can take a stand and say that we can examine one moment as temporally fixed in time and then the next moment and so on. We would then take a privileged look to a number of observations of exchanges between a patient and a therapist, reflections of patient when commenting something and a number of other possible positions. If we undertake this effort we could use as an example a transcript of a therapy session and analyze the utterances of each interlocutor, focusing on meanings, bodily expressions—and focus on any semiotic device utilized in the process (Krause, 2005).

Another scenario would be to look at the moves in therapy that lead from one moment to the next one. These are the dynamics of the psychological processes of meaning construction that activate the dialogical flux. The dynamics which generate production and variability in behavior provide also mechanisms for its regulation. This regulation is carried out by semiotic mediation which progress through ambivalence, ambiguity, tension, and psychological distancing.

In psychotherapy we can distinguish a way to sustain a dialogue or carry out a meaningful exchange between therapist and the subject. The way is called *intervention* when is practiced by the psychotherapist—and *idiosyncratic manner* of speaking—when uttered by the patient. The topics chosen are supposed to contain important information for psychological elaboration. Both answers—to the question how, and to what—are equally important and they intertwine. There is no way to dissociate one from the other. However, frequently studies on psychotherapy focus on one or the other question. When psychotherapy is considered as a meaning

making process from a microgenetic perspective the *what* and *how* remain as part of the same process. The dynamics respond to the question *how* and are highly interesting for the psychotherapist, as a tool for intervention and evaluation of the therapy progress. Although the last subject is not our focus and will not be discussed in this chapter it is evident that appears in the analysis.

## The Complexity of Being

The concepts of ambivalence, ambiguity, tension, and psychological distancing taken from a semio-genetic approach (Abbey, 2004a; Abbey & Valsiner, 2005; Simão, 2007; Zittoun, 2006) will be used here to reflect on the practice of psychotherapy. There is very interesting theoretical work on these concepts and its application to different fields of science remains a challenge. We intend to advance highlighting some aspects of psychological processing in therapeutic encounter.

### *Ambivalence*

We have set ourselves a rather highly demanding task, since most of the supposed psychological movements are not likely to be easily detected. Furthermore, psychological production is overwhelming to the observer. That implies that we have to focus on a partial experience at any time of observation, we need to rely always on some sub-part of the overwhelming experience. For every bit of experience that is captured and analyzed there is a background to it that is not coming at the forefront at that particular moment. This is expressed in cultural psychology as dual meaning fields. Abbey and Valsiner (2005) refer to ambivalence as the relation between meanings which occurs in a time span in life, which is expressed as levels of variation that can take the form of opposition or subtle differences between meanings. The authors conceptualize this dynamic as a proximal process of meaning generation, in which meaning experience emerges in the relationship between the present experience *as it is* with the near future *as it could be*.

Notions that emerge at different stages of dialogue form meaning trajectories. A distinction about something is made, differences are acknowledged and oppositions are displayed. Ambivalence points at meanings that are simultaneously present (Abbey & Valsiner, 2005). It could be opposite meanings (“this is good” versus “this is bad”), or it could be a difference or comparison (“that is good” but “this is better”). At any moment it implies considering options and taking a course of meaning towards a future direction. It is possible to notice in any utterance the way construction and re-construction seem to be fixated at a thematic pole and the next moment emerging at the opposite pole.

We shall use a therapeutic session between a middle aged woman separated from her husband and her therapist as our field of observation to examine the above mentioned dynamics:

- P:** I don't want to talk about unimportant things here.  
**T:** But sometimes those things, the not important ones, become important along the conversation.  
**P:** Yes, but sometimes there are things that I can solve immediately.  
**T:** Would you offer an example?  
**P:** As an example, things that I am not really interested to discuss because I sorted them out already. Eeemmm, eeemmm... Lets see...mmmh...as an example...oh, I am really tired of living this life...my mind is tired. and my body is tired.

The meaning making fluctuates in such a way that thinking about a triviality becomes an overwhelming task. The meaning trajectory flows as fluctuating dynamic of ambivalences that carries a construction in a complex way opening continuously meaning possibilities towards new interpretations. Complexity of meaning making and multiple options carry ambiguity in meaning construction. We can use here a spatial metaphor to refer to the concept of ambiguity. Ambiguity would refer then to something that is taking shape, changing or becoming (Chaudhary, 2003). We do not know yet what could be the next construction in the near future but this space of ambiguity allows the psychological elaboration to carry on from one moment to the next.

Let's go back to our example:

- T:** You say that it is not a financial issue for you. You say I am with him because I have positive feelings towards him. Would he have some personality characteristics that trigger positive feelings in you?  
**P:** Yes. When we play, when he seems like a child, when I protect him, when he pampers me. The feelings that we share then.  
**T:** But, how is it that you say like a child?

Ambivalence and ambiguity arise at the core of meaning negotiation suggesting possibilities and pushing meaning making always beyond of what it was uttered at the previous moment. Childish behavior can be signified as innocent and care-less interaction. However in this case it is meant by the therapist as an inadequate behavior for an adult.

- P:** I become playful with him, I would say in a childish voice (mimicries) do you love me, do you care about me, that way, playing.  
**T:** Like children playing.  
**P:** Yes, but it was just for a few moments, until he notices that I am starting to make fun of him.  
**T:** Does that mean that he feels that you would become threatening or trying to provoke him somehow?  
**P:** I never saw him with anyone, but I loved to make fun of him. I never saw a woman near him. But, I loved to make fun of him, in a way that really bothered him.  
**T:** You tried to find out things.  
**P:** No, I was just laughing at him.  
**T:** He could be afraid that you might misuse confidential information.

From children's play the dialogue derives a move to *making fun of* (says the patient) and *provoking* (says the therapist). The next thing that appears is 'I never saw him with anyone', as a disconnected piece of dialogue which is an utterance heavily loaded with emotional significance about sexuality, affection and trust. As we understand that meaning emerges with its opposite—here the not expressed aspect



is ‘I suspect that he has a relationship’. In fact, without such “hidden other side” the actual statement is absurd—never saw him with any other human being—as manifest content. While they play like children they are safe, they do not have to face the marital side of the relationship. However what is not expressed is the absence of the marital relationship in the marriage which appears in the meaning field in a highly capricious way. The twist of the conversation is arbitrary. This is again a point towards the uncertainty of meaning making of one moment to the next.

In Chilean culture the wife can infantilize herself (childlike play) as an ambiguous way to relate to her husband. This behavior can take out agency on her sexuality in the marital relationship, but it does not erase it completely. Another cultural model of marital relationship is the idealized value of fidelity, placing as hidden discourse the behavior of betraying the marital partner. Acknowledging a situation of being betrayed is a highly humiliating experience.

Ambivalence and ambiguity necessarily are associated with the uncertainty of experience. At the same time uncertainty helps to maintain the wealth of complexity of psychological elaboration on fluctuating dynamics that increase and diminish breaches between meanings, opening new windows, closing others, increasing and diminishing the differences in visions. This flow of differences requires flexible boundaries (complexity, variability) to maintain the dialogue in course. Thus, as ambivalence intensifies, the meaning-making often pushes towards the search of stability solutions to diminish it. If stability remains, it results in polarization of the construction. As an example *as far as I don't catch him with another woman, he does not betray me*. In those cases the elaboration can generate relegation of aspects of experience—*being betrayed*—as not recognized or not explicit possibilities. In that manner, people regulate conceptualization of experience and behavior restricting or delimiting possibilities towards the future. In the example given above, regulation of experience would mean that the wife behaves in a certain way as to not meet with unwelcome outcomes. This could be not questioning her husband about certain issues, not inquiring daily activities, not questioning further on his affection towards her and so on. There is a saying in Chilean culture which is *the truly blind is the person who does not want to see* (no hay peor ciego que el que no quiere ver). This regulation process comes at the same time from culture and from the own personal needs.

What about facing uncertainty in therapy? If we go back to our example:

- P:** At the beginning when it became open the relationship with this woman, this little monkey, this little ugly thing (*este monito, esta cosa fea*), I asked him whether he was still seeing her. He said yes, but it does not matter at all.
- T:** Did that happen recently?
- P:** About a month ago.
- T:** But, what does that mean? That he actually maintains a relationship?
- P:** With this monk...
- T:** Yes, with the monkey. Does he?
- P:** That is not what he told me. I don't know it. Sometimes you (men) compliment each other (*se echan flores unos a otros*), so that one would stare in amazement.

The uncertainty that arises around the meanings of her present couple relationship appears as not tolerable for this woman. She prefers a stability solution “it does

not matter at all". *At all* acts in this case as a semiotic mechanism that imposes intensity to the construction and polarizes the dialogue. '*No matter at all*' in opposition to 'matter indeed'. It is a generalized circumvention strategy (Josephs & Valsiner, 1998). This solution relegates the feared aspects, the feeling of threat to her relationship as a couple, the pain and fear of being abandoned and betrayed. Towards the future it can restrict the possibilities of being able to make genuine efforts towards the improvement of her relationship.

From a developmental standpoint uncertainty corresponds to the subjective experience of transformation. The concept of uncertainty as a social construction is often culturally associated with negative ideas, lack of security, and seen as a threat to the preservation of integrity, well-being and success. Thus, messages relative to stability and diminishing of novelty, to planning of events in the future and the generation and maintenance of expectations, appear as strategies of avoidance of negative situations. Nevertheless, contrary to this cultural discourse, the experience of stability and predictability of future seems uncommon as in any bit of experience some novelty arises as it becomes a new context (Abbey, 2004b).

Human subjective experience is situated in space and time as a process of becoming. This becoming of experience coincides with the notion of duration of Bergson (1896/1959), in which the relation of past and present is considered as a difference that is at the same time an indivisible unit that preserves wholeness. Our psychological experience is in progress, and always related to the past. The condition of novelty and unpredictability of experience originate in the tension and directionality for experience to be developed. Due to that, absence of uncertainty can be associated to highly negative experiences, leading to experiencing lack of vitality, of sense of meaning in life, to the paralyzation of behavior and narrowing of action possibilities. An example of this is the last excerpt of dialogue. "The relationship with the other woman *does not matter at all*". In this case the definition of total certainty seems unbelievable and weak. On other situations it is unnatural and distressing.

Let see the following exchange:

- T: Have you asked him, do you love me?  
 P: Not now, before yes but "playing".  
 T: Should he feel that you are going to play with what he says to you?  
 P: I believe so.  
 T: And that must frighten him?  
 P: Yes, very much.  
 T: And how could he calm that fear?  
 P: I believe that seeing another kind of woman, a more serious one. But that would not be me.  
 T: But he can feel that you make fun of him.  
 P: Yes, it is clear. He is very insecure of that, that I may use him, manipulate him.  
 T: You have said "I treat him like this, but I am...."  
 P: Betty the beautiful.  
 T: And you are....  
 P: My footman.  
 T: And you ¿what do you believe? ¿Can you have a relationship like that?  
 P: For that reason I tell him "you unbalance me because I give signs to you, I speak to you and you are so self centered". (Tú me desequilibras porque te doy señas, te hablo y estás demasiado centrado en ti mismo).

In this dialogue, we can appreciate that this woman is blocked in a rigid moment of her life, in which she feels that her personality is totally structured and finished, being unaware of her potential to change and develop. The feelings that often are associated with that approach are probably frustration, deception, resignation and lack of self confidence, and mistrust. She may solve a conflicting situation for the time being but eventually it can turn out to be a very difficult position to hold. She appears as a great lady, trying to command a “mischievous servant” (her husband) who is supposed to serve his lady and not himself. She adopts a certain self position regarding power in the relationship. In this particular position she can harm, insult, mock, being served and admired for her beauty and her power. She places herself beyond her actual circumstances as if nothing could touch her, distancing from pain and weakness. From that position she goes to another position, one in which she begs, demands for a sign of love and companionship, declaring at the end how tired she really feels. What is interesting here is the extreme rigidity of the self position and we could hypothesize that to being able to survive such a painful life situation, she resorts to behave in a very polarized manner.

Let us examine polarization a bit further with another example.

- T:** It seems that you doubt if he really loves you, if you are in the first place and if he wants to improve the relationship with you.
- P:** I believe that he loves me. But I have not made things easy for him to love me.
- T:** And how that can be understood?
- P:** Because I am very unbearable, very impulsive, I devalue him so much.
- T:** Let me see, but that may be understood as if you should be loved anyway, without having to win his love.
- P:** Yes, being myself, not more than that.
- T:** And why?
- P:** Because I am not a bad person, I do not make any harm to anyone.
- T:** You are a person who can be loved.
- P:** Totally lovely. And, they can tell me, I am ok or I am not and I can accept it.

We should highlight here that therapist and patient are elaborating on profoundly polarized notions: to be loved or not to be loved, to be a good person versus to be a bad person. A nice person is associated with *deserved to be loved*, introducing affective value to the construction and increasing tension. The solution goes towards polarization and momentary blocking of ambiguity.

The patient seems highly rigid and with a diminished ability to negotiate a self position. She oscillates between good and bad in her behaviour and the perception of others; she can be the “queen” and a “door mat” and she does display both aspects towards her husband. We could say that when facing the difficulty of psychological elaboration, she resorts to polarization and gets entangled in a difficult situation where the husband leaves the house, acquires a lover and visits the house on a daily basis, keeping his role of the man of the house. The dialogue with the therapist is much permeated of this polarization. This is an illustration in which the regularities of the use of semiotic mechanisms can be considered as generalization of behaviour. When analyzing a small exchange in therapy as a microgenetic moment, it seems peculiar. When this psychological construction is repeated in time with this intensity and frequency, it becomes problematic and can have severe

consequences in the life of the patient, that lead to an unsatisfactory life, in which she feels humiliated.

The therapist has the privilege to witness the display of a range of self positions that this woman would not acknowledge so openly in her daily life. A very interesting question arises here. Since she is able to acknowledge all these feelings and behaviors in herself, from our perspective she is trying to place herself in relation to her husband's position and taking a survival strategy when facing a self-threatening situation. From other conceptualization we could endow these behaviors with diagnostic labeling.

## *Tension*

We can appreciate from the examples that meaning trajectories advance through fluctuations of tension, as a dynamic that introduces force and directionality, keeping the dialogue flowing. Tension includes two essential aspects of the process:

- the generation of imbalance in the dialogical relation—which arises from asymmetry of meanings;
- directionality of the construction—which not only indicates the course of the construction but it also points towards the future.

When this takes place, it highlights what the speaker is proposing as the goal of the elaboration.

**T:** But, don't you tell him "I want to love you"?

**P:** No.

**T:** Or, "Can you allow me to love you"?

**P:** No. Would not that be asking too much from me? Yes, because I get exhausted and I say: I have done so much already. I speak up, I say, I do things since I come to therapy. I feel that I have changed so much towards him. I value him; I cheer the silly things he does. I tell myself nobody can do this jerk, but I reassure him, saying it's ok, it's ok.

**T:** But when you approve him. Do you really feel that?

**P:** Yes.

**T:** Or, do you feel I have to put up with this jerk?

**P:** Oh, but he enjoys it so much. (laughter)

Through the dialogue we can identify different sources of tension set by the asymmetry of meanings. In this case, the differences between the feelings of love and tiredness; the woman's position that asks for loving care and the male's position busy with his hobbies; the difference between reassuring and devaluing.

Here we can appreciate that the tension aroused from the differences is not only of semantic nature but mostly affective as it comes from different subjectivities that interact. Consequently many aspects of that tension are pre-verbal, present in self-dialogue, but not communicated in the interaction process. What is not expressed here is the role of the woman who needs affection, the one who feels lonely—versus the woman who wants things to be done her way. The woman seeking love struggles

to value her husband's actions, while the woman who makes demands, thinks that her husband employs his time doing silly things.

When the patient talks about *cheering silly things*, she displays in a sentence the complexity of her ambivalent experience. This semiotic device—*cheering silly things*—acts as a circumvention to display coexistence of opposed meanings. This allows that the tension generated by the asymmetry can be released. However, the therapist demands that the patient takes a non-ambivalent course of meaning. When he perceives different directionalities towards future, he is at the same time compelled to reduce tension and diminishes his uncertainty at the here and now moment.

According to Marková (2003) the mere presence of positions in dialogue, or the differences among them, is not enough to trigger action. It does not arise as a logical consequence of the differences between meanings. For example, a complementary relation does not necessarily generate tension. Different forces in interaction are needed, that involve affection and intentionality, unfolded in a contrast relation—in a collaboration or opposition relation—pushing one against the other, but at the same time demanding a solution that integrates them, where the actions of one without the other are not possible to expect. Tension arises pushing towards the future seeking at the same time to solve it and to install a state of equilibrium.

A here-and-now moment of meaning emerges in the relation between two positions, and generates tension projecting directionality towards a proposed goal. Although directionality appears associated to tension, it is not the tension itself, but a consequence of it. Tension emerges from the relationship between two meanings, one emerged at the here-and-now-moment and the other in the recent past. They mutually clash, assess, and judge each other. This tension is the drive for meaning construction, de origin of directionality. Directionality is movement appealed by an uncertain future. It points at an endeavor that is characterized by ambiguity, which is diffuse and consequently creates variability. It is for that reason that directionality is both manifold and diffuse.

**T:** What you want to know is which place you have in his life in the future.

**P:** Yes, I wonder what he expects from me, what he wants from me.

**T:** Have you asked him?

**P:** I don't know. No, I haven't.

**T:** And does he ask you?

**P:** No, because I have always told him that I care, that I am interested in him, that I don't want to loose him. I always reassure him.

**T:** But what might be happening then. Could it be possible that he does not believe you?

**P:** Yeah, something along that line.

When the therapist says “but what might be happening then” he points at the tension that emerges between the position of asking and assuring love and care and other position that does not display affection, does not ask and does not love the other. Both positions are parts of the subjective experience of each of two actors of the dialogue: the woman and her husband. At any point they stand in opposite positions from each other or play opposite I-positions at the inner dialogue. The tension between these two options points to a wide frame of possibilities towards the future and this is done in a way to keep ambiguity open and the hope for something better

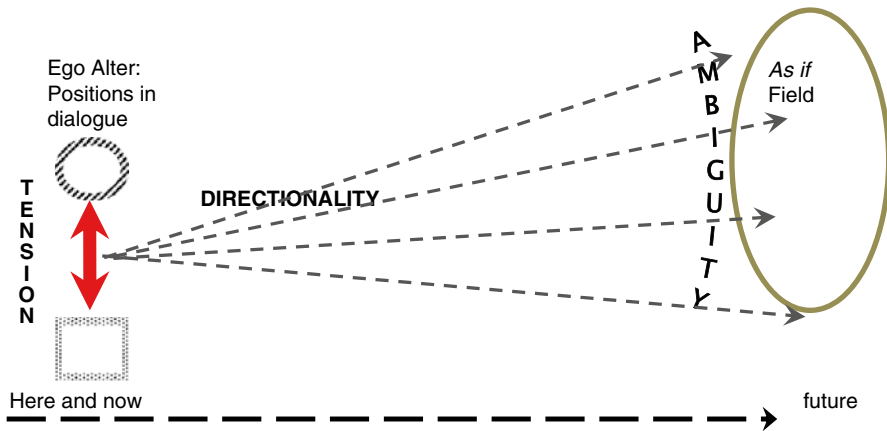

Fig. 20.1 Relation between tension, directionality, and ambiguity

in the future (see Fig. 20.1). For example, as long as the wife does not ask her husband, she can try new things without having to face an open rejection. When interacting with the patient at this point, the therapist seeks to diminish tension and a way to do it is through solving ambiguity. If he cannot obtain an answer from his patient, then he points at another interlocutor, her husband. When doing this, he invites her to distance herself from her behaviour and to seek the husband's perspective. He does not inquire how or why these two possibilities coexist in her story. When facing ambiguity and ambivalence, the therapist creates new tension questioning the patient's words. We could say that he perceives lack of congruence in his patient and feels compelled to do something about it, perhaps through suppressing subjective positions and narrowing the meaning field. Also, the therapist may attempt to seek release of tension and displays the new directionality in the dialogue oriented towards the future; but when he asks "could it be possible that he does not believe you", he opens a new range of ambiguity with the notion of believing and also he expects that his patient to internalize a new position that of "being the husband".

Should we as therapists expect that reducing ambiguity or ambivalence by means of proposing certain focus will diminish opposing positions or many alternating positions? Most likely it will not happen. Attempts to reduce polarization and rigidity so that the patient integrates opposing views towards herself and others implies new openings, perhaps of a different quality in which meaning can move not as *either/or* but as *this and that* kind of reasoning. If we examine this point from our theoretical perspective, what could be the possibilities of meaning of the notion of believing for the patient? It might be that she cares or that she doesn't care. More over, she has to prove her reliability. The therapist puts on the table the notion of credibility and establishes a value with it, which is not openly stated. *Being believed* here acts as a semiotic mechanism that seeks to solve the tension, but it displays another tension when it entails a new relation with the concept of love and care. It points to new goals in the future, and imposes new self values to the patient which can question the quality of her love or not a trusting attitude by her partner. This is

the way in which tension acts, pushing the actors of a dialogue towards emerging new goals and through generalized and ambiguous notions to emerging new meanings to be considered. When the patient answers: *Something along that line* is a point of directionality in the sense that points at the future, but the actual trajectory remains uncertain as each step is taken at a time.

The point that we would like to stress here is that directionality has to do with moving ahead as opposed to staying where one was. It is always present in conduct and does not mean a clear purpose or a clear line of thought. We move towards the future most of the time in a rather erratic manner because of the changing nature of life events.

A purpose of the therapeutic encounter and often the therapist's aim is to make the patient's discourse more coherent but this does not necessarily mean clearer directionality. The dynamic of searching congruence could block meaning-making. We could consider the therapy as the scenario in which the therapist wants the patient to take the correct standpoint and makes several interventions in order to get rid of the "blind spot" that he perceives in his patient. Displaying that effort the therapist could lead to a no way out situation, as he dismisses some positions taken by the patient that can participate making the dialogue progress.

As we explained with the examples, in Fig. 20.1 we depict how each new meaning construction generates a new tension when a new comparison relationship arises from the recent past towards the non-recent past. When the therapist expresses his doubt on any possible subject, he opens a new tension field. Those fuzzy aspects of the past are expressed as tendencies (in this example, the patient says *I do the talking and he does not react*) corresponding to past possibilities of directionality that come into friction with present directionality (*the possible doubt of the husband*). When the patient says, *yes something along that line*, she confirms the therapist and at the same time does not diminish tension. Tension is created between her who is focused in the present towards the future and the therapist who is focused on the past towards the present. *Along that line* is expressed as something that is going on and was expressed at some point already. It expresses ambiguously 'you are on the right track' and at the same time she represents it in a wide range of possibilities of meanings to be uttered. As the dialogue is kept in course, it is pulled by the future which is constantly enlarged and reframed, creating a dialogical chain around meanings from the present towards the past and towards the future at the same time. So, along psychological elaboration directionality might get more complex, but at the same time will provide new openings for making sense of psychological phenomena. A complex web is elaborated opened towards new infinities both to the past and to the future.

The tension mobilizes the opposing notions. This makes necessary a convergence of the interlocutors who participate in the interaction, within an intersubjectivity frame in which mutuality is only a departure point for the negotiation of the differences that are displayed. The opposition relation included in the intersubjectivity, is displayed at the encounter in mutuality when the other's position appears to be unfamiliar, unknown or foreign. In this way an inclusive relation of co-creation emerges in dialogue. Without this aspect according to Marková (2003) there would be no dialogue, neither action. Tension is missing as a constructing dynamic.

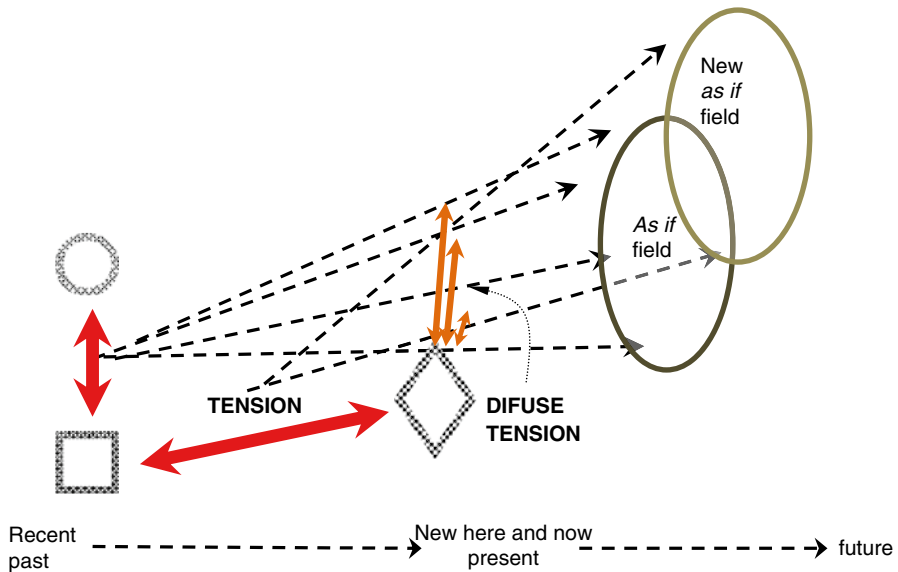

Fig. 20.2 Self-construction system

As stated, the tension allows the interlocutor, to direct his/her attention towards the directions to which the positions in dialogue are pointing at and responding to them. Also it is possible to orient the answer towards a space far from the range of possible directionality outcomes that emerge from tension (see shape C in Fig. 20.2), blocking or re-directioning the dialogical chain and generating a new one. For instance, at a certain moment the patient discloses her feelings and what she envisions as new behaviours and attitudes towards her husband and the therapist asks about a past issue. At other moment the patient expresses her feelings and subjective experience while the therapist induces her to reflect on the feelings of her husband. These possibilities, as answers or reactions in the dialogue entail avoidance strategies and may generate new courses of dialogue or to discourage them.

In the therapeutic setting we can ask ourselves when the dialogue evolves into a monologue in which the interlocutor ceases to be engaged in conversation. It could be the case when the therapist working with his patient ceases to listen to her and keeps an inner dialogue with himself, becoming monologue.

We can trace a moment in which this appears:

- P:** I believe that the most important thing is to talk about every thing that happens with us.
- T:** But that requires clarity.
- P:** Sure, I do not want this, you What do you want? You do not love the person you had before, perfect. Why you do not like her? Because she had a limited mind, because she used to laugh at me, she was unpleasant, mocking...
- T:** You have devalued him a lot.

When the therapist utters *you have devalued him a lot* it does not become clear that he is following his patient statement, or unless the full sense given by her to that



statement. She is referring to the disapproving views that she thinks her husband has towards her, but also indirectly towards the not approving attitudes that she has towards him. It is possible that the therapist deliberately decides to not address the focus of his patient in order to attend to a different focus. A possible assumption is that it could reflect the therapist's inner talk. We could depict that inner talk as:

*I'm trying to make her address to and understand the husband position because I feel that she does not care about the way he feels towards her.*

*If she does not take into account the feelings of the other she will not be able to reach her husband and will end up more lonely and unhappy.*

*She is so self engrossed, she has to recognize and analyze her relationship strategies.*

We propose this hypothetical inner dialogue of the therapist since he kept asking to the patient about the husband's behaviour and feelings: *Does he feel that way; why does he act that way; what did he have in mind when..., etc.*

The inner dialogue is not necessary troublesome. Furthermore it is expected an active inner dialogue in therapy for both interlocutors. Problems could arise in this case when the therapist pursuing his therapeutic aim loses touch or contact with the patient and the patient becomes momentarily uninterested in conversation. This could be a fruitless monologue regarding mutuality. However, it might lead to feelings of detachment in the therapist and hence to pursue contact with the patient again. This is a quite often the case in therapy. This is not only important for the semiotic construction that is being carried out but also for the relationship that is being constructed between people. From some therapeutic approaches (i.e., psychoanalytic psychotherapy, cognitive psychotherapy) it may be considered a thought-provoking strategy and constituting an appreciated therapeutic intervention. Nevertheless, our aim is to emphasize the importance of intersubjectivity in therapeutic listening, when considering two interlocutors that perceive points of tension in their utterances and orient their answers to the directions emerging from those points. The intersubjectivity is considered as an approach to the sense and value of the position of the interlocutor. When a movement of convergence is produced, conditions for a new meaning display or a counter-action emerge. When the relation does not seem supported in intersubjectivity, it can be useful to the therapist to ask him/herself where it is the tension in the communicative expression with the other.

The level of tension is a manifestation of the intersubjectivity displayed in a human exchange. When the intersubjectivity declines (i.e., people don't feel understood, don't understand the expressions of the interlocutor or become not concerned with the topic of the conversation, or with the object of an encounter or not interested in the other person), also tension decreases. So, tension reveals quality of intersubjectivity and could be a key device in therapy, beyond meaning construction or the conceptual elaboration of experience, even more in relationships construction and elaboration of feelings and attachment.

The tension is the dynamic that provides to the flow of experience, the potential and ability to generate meaning and action as it pushes towards its own reduction. Nevertheless, it is the fluctuation of the tension which maintains the developmental process in course. We should bear in mind that imbalance created by a situation of

tension is motivated by vital needs of the individual and self-regulation processes. The single reduction and even more the blocking of the tension do not allow further generation of meaning and hence new perspectives.

In the context of clinical practice and supervision there are often demands on the therapist role, such as the desire to relieve anxiety or distress in the patient. Nevertheless, when the therapist manages to tolerate his/her own anxiety as opposed to those of his/her interlocutor, therapy advances in a co-constructive process in which the perspectives of the patient are taken into account. Consequently the tension must be surpassed in and through the constructive process. People use a series of mechanisms, denominated circumventions that act as interstices and slips to evade a certain meaning and to add a difference. Permanently in the dialogue the people make use of those subterfuges to evade the tension that causes annoyance to us, but the game of the dialogue pushes to put again the tension in the scenario.

## **Distancing/Approximation**

The conceptualization of psychological phenomena as related interdependent dualities is considered here as a key theoretical notion. The dialogical paradigm assumes a meaning construction process that advances from a position that proposes and other that responds, generating sign duality complexes, conformed by a sign and its counter-sign. Also it approaches the conception of the relation between individual and society as an ontological unit, in which the adaptation experience unfolds in an inner/outer inclusive relationship. Other dual dynamic is appreciated in the fluctuations of distancing/approximating movement, which is part of psychological process.

The relation between the subjective positions of interlocutors that participate in meaning construction is immersed in a dynamic of distancing and approximation. An essential aspect of the relation between ego and alter is to be outsider to each other in mutuality. In the course of negotiation, that outsidership needs to be appropriated, contextualized. This does not imply a relation of consent but of distancing and approximation, setting up a system of mutual boundaries. From the dialogical paradigm the process of psychological distancing facilitates the relation between partners through establishing limits for the perception and interaction of speakers in dialogue. This is the process by means of which positions in dialogue are created; a person can take meta-positions towards his/her own experience. For example, as an expert towards his/her behaviour (as normal or not normal), or assuming positions of others (aligning him/herself with others) etc.

Let's return to a previous therapeutic exchange:

- P:** I believe that the most important thing is to talk about every thing that happens with us.
- T:** But that requires clearness.
- P:** Sure, I do not want this. What do you want? You do not love the person you had before, perfect. Why you do not want her? Because she had a limited mind, because she used to laugh at me, she was unpleasant, mocking...

- T: You have devalued him a lot.  
 P: Yes, very much.  
 T: And that could have caused some feelings in him?  
 P: I think it is a feeling of total rejection towards me.  
 T: Let see, I think that if you say to me “every thing about you is bad”, “your family is horrible”, “everything you do is silly” Would it not cause pain to him?  
 P: Yes, of course. He is a very sensitive man.  
 T: But, you know, I think that basically all the bad attributions point to situations that you are not involved.  
 P: Of course.  
 T: ... that what you hoped from him, the only important, the most valuable thing, nothing of family, nothing of hobbies...  
 P: Me, me, me.

She distances from the ugly aspects she thinks that she has and places it in the husbands uttering through her. This movement can have an important consequence regarding elaboration of experience, in the sense that it implies that the patient moves closer to the views of her husband as she perceives them and can evaluate damage or misunderstanding in the relationship. The therapist and the patient follow different tracks and at some point the therapist includes the patient in his own position by means of repeating her words. By using this strategy or circumvention, he obtains a moment of agreement from his patient. When having a closer look, the therapist utters his patient’s words in a different manner, not exactly the one she had used previously. He creates a position which is more extreme and generalized—*if you say to me “every thing about you is bad”, “your family is horrible”, “everything you do is silly”*. The therapist appropriates the word of the patient to elaborate his own meanings y offers them back with a different accent as if it was the patient’s original accent. The appropriation moment of the therapist remains implicit or tacit in the conversation. So, the therapist elaborates a conclusion or reflection around supposedly said by the patient, assuming it as a given fact. The patient must distance from her words and feelings and look at herself with the eyes of the therapist so that she can adopt a critical view of herself. When analysing this circumvention we can make distinctions related to mutuality. Mutuality frame seems to be reduced. The patient is saying that her husband devalues her and the therapist that she devalues her husband until a moment is reached when the voice of the therapist is more authoritative. The expression *me, me, me* can be understood as taking the point offered by the therapist and also expressing her needs. There is an illusion of mutuality while they agree on something that means differently to each speaker.

What is happening here? Is she a woman asking to be loved or is she a self centered person; is she devaluing herself or is she devaluing her husband. Therapist and patient have different perspectives at that moment. From the therapist there are a harassed husband and demanding wife, while for the patient there are an absent husband and a wife in need. What is more useful? The therapist’s invitation to join his perspective of demanding wife—demanded husband or his incursion to the patient’s perspective of absent husband—wife in need. In order to maintain the frame of mutuality both perspectives need to interact and be taken into account by both interlocutors. That implies distancing and contextualizing from both, therapist and patient. When the therapist visits the patient’s perspective he also distances himself from his

own assumptions. To be able to consider somebody else's perspective it is necessary for the interlocutor to abandon at least momentarily his or her own assumptions.

Dynamic of distancing and approximation constitute the movements that set the stage for the fluctuation of the tension and pointing to directions towards the construction of possible meanings. Thus, these movements are a resource of the meaning negotiation, displaying a variety of effects on the construction. These movements could result in: diminishing or enlarging the breaches between opposite meanings, generating distance from the meaning emitted in a previous moment, taking distance from a meaning field when constructing from the position of another social actor, being distanced from the idiosyncratic own experience or taking positions from internalized others. All these options might be used in order to place demands difficult to tolerate momentarily in others, the release one self of an unpleasant feeling, to try to get the other's attention into certain directionality.

Distancing and approximation is a dynamic of flexibility that allows understanding a variety of circumstances from a dialogical approach. Bearing this in mind, it permits articulating a range of strategies in order to allow psychological experience to develop. As long as we acknowledge the concept of ongoing dialogue between self and others and self to itself, we can make these distinctions. The concept used here is that of self positions, either internalized or externalized. Distancing allows dealing with the differences that are created in the scenario of the negotiation, at the extent that it diminishes the contextualization and the idiosyncrasy of expression. Approximation or contextualization, allows internalization and integration to the self of aspects or experiences previously perceived as pertaining to others. In the next exchange the patient tells the therapist about her change of attitude towards her husband recycling hobbies.

- P:** I used to get annoyed, now a tell him that I like what he does (hobbies)  
**T:** And when you approve that, Do you really mean it?  
**P:** Yes, because he enjoys doing that. Out of something no one appreciates he turns it into something beautiful.  
**T:** And you used to berate that?  
**P:** Yes, I used to criticize him.

She seems to decide that she is not going to criticize her husband and she congratulates him for his accomplishments. When doing that she realizes that she actually enjoys looking at the repaired artefacts and approves of her husband activities. She found an affective connection with him related to something that was not her interest before, being able to place herself in the husband position. When this happens she can feel that she is closer to her husband and the belligerent aspect of the relationship diminishes. From a dialogical perspective she internalizes an aspect of the husband's self.

The effect caused through these dynamics of distancing/contextualization is to provide movement to the evolutive process, maintaining the dialogue in course, avoiding blocking, diminishing or evading tension, allowing new elaborations with a higher level of abstraction and differentiation. At the same time allows approximating to new aspects of the self that are less recognized or accepted. The dialogical relation between distancing and approximation, allows that the construction proc-

ess evolves, becoming more integrated, new links appear between elements, reaching elaboration to new levels of abstraction, that is evolution of the construction towards greater states of differentiation. Differentiation is a key process in development and meaning transformation (Valsiner, 1997) and distancing/approximation are the dynamics that make that differentiation possible.

## Temporality

The person who attends a therapeutic instance shares the need to elaborate his/her passed experience, whichever this was and to adapt to the changes towards a future that perceives uncertain and unknown. Negative experiences threaten the sense of quasi-stability of people's lives, generating uncertainty and leading to perceive the present as a moment of instability. Not only the future is not known, but also certain aspects of past experiences remain vague, foggy, and confused. The irreversibility of experience in time (Bergson, 1896/1959; Mead, 1931/2002) characterizes all psychological phenomena as continuous processing of experience. From this viewpoint, a disturbing experience involves alteration of temporality, hampering the sense of continuity of life, which is an essential aspect of identity constitution and personal integrity. Sense of identity comprises two polar and complementary aspects: permanence and change. Analogously, societies reiterate practices to preserve their identity.

Based on the dialogical frame, sense of continuity is developed by the establishment of connections—dialogical relations—between present representations and hypothetical future or between present and past. Sense of temporality is lost when new experiences do not fit with other representations for comparison and dialogue, being too foreign or exceeding the frame of possible well-known life experiences (Zittoun, 2006). The absence of these connections causes breaches in psychological experience and loss of the dialogical relations between representations of self in the past, the present and the future. The loss of sense of continuity brings as psychological consequence an experience of disconnection expressed as solitude, isolation, judgment from others, no perspectives towards the future, absence of solutions, stagnation at extreme. Let's consider the following statement of the patient: "... because I get exhausted and I say: I have done so much already. I speak up, I say, I do things since I come to therapy. I feel that I have changed so much towards him. I value him; I cheer the silly things he does. I tell myself nobody can do this foolishness, but I reassure him, saying it's ok, it's ok".

We can observe three different moments in time that are expressed in utterance. The past experience of exhaustion and possible frustration related to the marital relationship, and the mentioning of valuing and reassuring the husband in order to obtain the therapeutic goal of a better relation in the future. These two representations placed in past and future probably are not reconcilable in present experience for this patient. So, she constructs a poor circumvention to relate these two aspects to her experience at the here and now, through the statement *I cheer the silly things*.

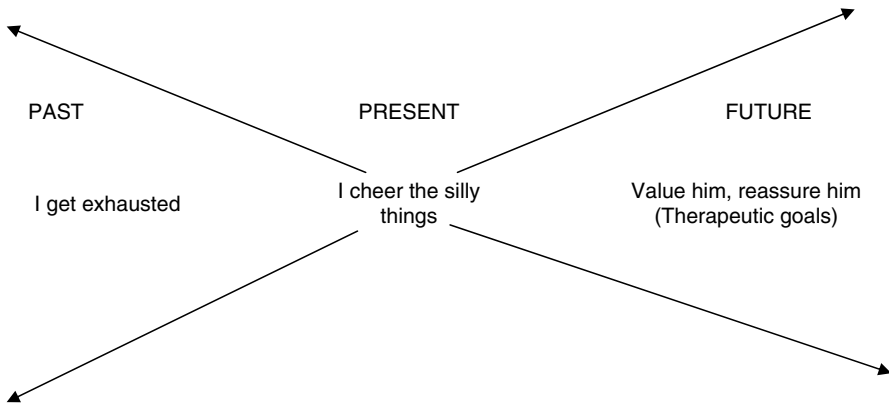

**Fig. 20.3** Temporal elaboration of experience

Therapy is a scenario in which we can appreciate the encounter of these three different contexts. Past experiences often appear as events that need to be understood or reconsidered and future visualized as difficult endeavours or aspirations. The therapeutic effort is a process carried out at the here and now, aiming to elaborating notions and representations that allow integrating these temporal contexts in a not contradictory way for the patient. In the example given above, the present solution—*I cheer the silly things*—does not provide congruency that could allow a sense of continuity in the patient.

We state that uncertainty and ambivalence open new possibilities to create new connections between present processing and past or future events, providing new reframing chances to fear, distress, frustration, and other threatening conditions. The experience of ambiguity and ambivalence usually is uncomfortable. It is argued that in daily life people do not catch the flexible aspects (ambiguous) of the present and construct quasi-stability notions (Valsiner, 2000; Sato et al., 2007). This leads to evade the stress of perceiving one self in permanent transformation and unable to control the future. At some moments of the dialogue is evident the discomfort of the patient when she becomes conscious of the contingency of experience.

- P:** Me, me, me. Everything for me.  
**T:** You mean that you needed him a lot.  
**P:** Yes. I did not want to share him with anyone.  
**T:** Yes, because it took his attention away from me.  
**P:** You must have suffered when he had to go to work.  
**T:** But I accepted it.  
**P:** But with that pain.  
**T:** Sure. With rage, pain, with but why...

With the expression of feelings of rage and pain the patient acknowledges that she cannot control her husband's life regardless of how much she needs to do it. Uncertainty in this example is placed on the patients needs when she defines the relationship with her husband in her own terms to be able to feel safe. People try to get rid of uncertainty. Nevertheless, the tendency to avoid the uncertainty leads

to restrictive solutions to action possibilities, tending towards rigid alternatives and monologization. Boesch (2001) proposes that partial solutions privilege an aspect of continuity—the permanence—leaving the dimension of change outside the elaboration. From this perspective it appears as a strategy that does not suitably dissolve the rupture of sense of continuity generated by a painful past. Abbey (2004b) analyzes the persistence of the people to control uncertainty creating expectations, as a form of habitual adaptation, that nevertheless leads to intolerant reactions when reality does not suit them. The intolerant position leads to false clarity, implying not recognizing some aspect of the ambivalence, excluding it from the elaboration, staying the person with a clear although false meaning. The patient of our example utters frequently along the therapeutic session that she and her husband need “to speak about things” and “talk to each other” as a way of searching the solutions required to their couple problems. But each time in the dialogue these expectations are not elaborated further more and stayed as normative devices. These expressions—*to speak about things* and *talk to each other*—are quite vague and generalized representations that could function as taken for granted conditions, constraining experience in a not elaborated manner. This is a way that characterizes monologization of psychological experience, through which people seem to feel more comfortable operating with restrictive strategies.

It is possible to reduce ambiguity through adopting artificial dichotomic solutions: For instance, in our example, the patient has the expectation of not experiencing rejection again in the future, which inspires its counterpart: to keep exposing herself to abusive situations when trying to relate to the husband. Another way to elaborate this experience is through creating self definitions where the notion of rejection is not any more part of the own life or from the opposite position the omnipresent rejection that threatens to appear in different manners in the future. This is the main feature of stigmatization that becomes an aspect of identity.

## Conclusion

We have stated that uncertainty, ambivalence, tension, and distancing are qualities of psychological elaboration. They are constitutive of the therapeutic exchange and cannot be avoided. Stated as such, might seems quite simple. However when working in therapy quite often therapists seem compelled to push aside uncertainty, ambivalence, and tension and strive to bring forward certainty and stability in its place as an effort to diminish suffering in their clients. A question arises then: Does stability mean a state of blissfulness or at any rate is certainty a better condition than uncertainty? Is it a rhetoric question for therapists or it is at the core of therapy making?

These questions force the therapists to take a stance regarding the notion of structure as traits, temperament, labeling or any regularity that leads to identify a person in a certain category. If we are to consider structure as a fixed state and/or static, that is to say without temporal quality, therapists and therapy making are in

trouble. Clients come to therapy to change something in their lives and therapists intend to produce changes for the betterment of the lives of their clients. What is to be changed? Should one structure be changed for another structure? Is it possible to change a fixed position for another fixed position?

A different scenario could appear if we consider the notion of *temporal structure*. That would mean a set of regularities that remain for some time in psychological elaboration and change probably gradually to another set of regularities. If therapists take this stance, then they face a challenge that we could call promote *scaffolding*, borrowing Valsiner's notion (2005). We shall use scaffolding to refer to a moving structure or as the word says, we can only find scaffolds where movement and change is taking place. Then, again we could question what therapy is about, and challenge the notions of reframing, readapting or readjusting patients. Instead, we could consider that people use highly idiosyncratic scaffoldings to exchange with their environments. Then, people come to therapy being not able to face changing situations or scenarios or life events as they appear in the flow of their experience. Therapy would then constitute an effort to help people to flow psychological dynamics in the exchange of self and environment. This means that therapy is based on identifying dynamics and movements and identifying ways to evolve, and not set ways in the manner of solutions to problems.

## References

- Abbey, E. (2004a). Circumventing ambivalence in identity: The importance of latent and overt aspects of symbolic meaning. *Culture and Psychology*, 10(3), 331–336.
- Abbey, E. (2004b). The blind leading the seeing: A new path to self-reflexivity. *Culture and Psychology*, 10(4), 409–415.
- Abbey, E., & Valsiner, J. (2005). Emergence of meaning through ambivalence. *Forum Qualitative Sozialforschung/Forum: Qualitative Social Research*, 6(1), Article 23. Retrieved May, 2008, from <http://www.qualitative-research.net/fqs-tests.htm>
- Bergson, H. (1896/1959). *Materia y memoria*. In *Obras escogidas*. México: Aguilar.
- Boesch, E. (2001). Symbolic action theory in cultural psychology. *Culture and Psychology*, 7(4), 479–483.
- Chaudhary, N. (2003). Speaking the self into becoming. *Culture and Psychology*, 9(4), 471–486.
- Josephs, I., & Valsiner, J. (1998). How does autodiologue work? Miracles of meaning making and circumvention strategies. *Social Psychology Quarterly*, 61(1), 68–83.
- Krause, M. (2005). *Psicoterapia y cambio: Una mirada desde la subjetividad*. Santiago: Ediciones Universidad Católica de Chile.
- Leendert, M. (1998). On methodological distinctions: Nomothetic psychology, or historical understanding. *Theory & Psychology*, 1(8), 39–57.
- Marková, I. (2003). Constitution of the self: Intersubjectivity and dialogicality. *Culture & Psychology*, 9(3), 249–259.
- Mead, G. H. (1931/2002). *The philosophy of the present*. Amherst, MA: Prometheus Books.
- Molenaar, P., & Valsiner, J. (2005). How generalization works through the single case: A simple idiographic process analysis of an individual psychotherapy. *International Journal of Idiographic Science*. Article No. 1. Retrieved March, 2007, from <http://www.valsiner.com/articles/molenvals.htm> (Available in S. Salvatore et al. (2009), *Yearbook of idiographic science 2008*. (Vol. 1). Rome: G Fireira Group)



- Sato, T., Yasuda, Y., Kido, A., Arakawa, A., Mizoguchi, H., & Valsiner, J. (2007). Sampling reconsidered: Ideographic science and the analyses of personal life trajectories. In J. Valsiner & A. Rosa (Eds.), *Cambridge Handbook of Socio-cultural Psychology* (Chap. 4). Cambridge: Cambridge University Press.
- Siegler, R. S., & Crowley, K. (1991). The microgenetic method: A direct means for studying cognitive development. *American Psychologist*, *46*(6), 606–620.
- Simão, L. M. (2007). Why otherness in the research domain of semiotic-cultural constructivism. In L. M. Simão & J. Valsiner (Eds.), *Otherness in question: Labyrinths of the self* (pp. 11–36). Charlotte, NC: Info Age Publishers.
- Valsiner, J. (1997). *Culture and the development of children's actions. A theory of human development*. New York: Wiley.
- Valsiner, J. (2000). *Culture and human development*. London: Sage Publications.
- Valsiner, J. (2005). Scaffolding within the structure of dialogical self: Hierarchical dynamics of semiotic mediation. *New Ideas in Psychology*, *23*(3), 197–206.
- Valsiner, J. (2006, October 13). *From double stars to dialogical self: Constructing new theoretical explanatory systems*. Paper presented at the Conference *Interaction et Pensée: Perspectives dialogiques*. Lausanne.
- Valsiner, J. (2007). *Culture in mind and society: Foundations of cultural psychology*. New Delhi: Sage Publications.
- Valsiner, J., & Diriwächter, R. (2004). Qualitative forschungsmethoden in historiscven und epistemologischen kontexten. *Qualitative Forschung in der Entwicklungspsychologie*. Deutschland: Kölner Studien Verlag.
- Valsiner, J., & Sato, T. (2005). Historically structured sampling (HSS): How can psychology's methodology become tuned in to the reality of the historical nature of cultural psychology? In J. Straub, C. Kolbl, D. Weideman, & B. Zielke (Eds.), *Pursuit of meaning*. Bielefeld: Transcript.
- Valsiner, J., & van der Veer, R. (2000). *The social mind. Construction of the idea*. Cambridge: Cambridge University Press.
- Zittoun, T. (2006, June 1–2). *Using symbolic resources, playing with time*. Paper presented at symposium: Past and future within dialogical self. Fourth International conference on dialogical self, Braga.

# Chapter 21

## Dramatic Life Courses: Migrants in the Making

Irini Kadianaki

Migration is a complex and dynamic phenomenon. It is influenced by a number of interrelated factors: social, economical, political, personal-psychological, which interact within a specific context in time. In psychology several attempts have been made to understand the migrant, which can be grouped into three main research approaches: (1) stress and coping, (2) cultural learning, and (3) social identification (Ward, Buchner, & Furnham, 2001). Following the dominant approach in psychology, these studies are based on random samples of migrants, usually belonging to a so-called ‘ethnic group’, from which generalized conclusions about ethnic groups or migrants as a whole are drawn. They reply to questions of how migrants “learn” or “adapt” to a new culture through acculturation, focusing on *states* rather than *processes*. There is a need to understand the processes through which migrants cope and how these processes are essentially embedded in culture. This implies looking at the individual, at processes of interiority, at the content of people’s identification rather than at the outcomes. Asking how people manage their transition to a new culture implies looking at the level of the symbolic system of the individual. This involves studying the life histories of individuals as they develop in space and time, ‘culturally guided and personally-semiotically reconstructed’ (Valsiner, 2000, p. 82).

In this chapter, I will develop a methodological framework appropriate to examine the above issues. I will move from reconsidering traditional ways of developing generalized knowledge on socio-cultural issues of migration and psychology in general to the presentation of an alternative way of producing knowledge through an idiographic study of life-trajectories. The theoretical inquiries guiding this methodological journey are the cultural-symbolic resources (Zittoun, 2006) that migrants moving to Greece use in order to cope with inner and social ruptures. These are examined in conjunction with the migrant’s life prior to migration, their motivations and expectations from Greece, their contact with the new reality and the Greek people, their feelings towards their country and their thoughts and plans about the future.

---

I. Kadianaki (✉)  
PPSIS, University of Cambridge  
Cambridge CB2 3RQ, UK  
e-mail: eik21@cam.ac.uk

## Reconsidering Sampling and Generalized Knowledge Through the Case of Migrants

Sato et al. (2007; this book, 2009) describe two methodological paths which science follows in order to arrive at generalized conclusions about the phenomena under examination: *idiographic* and *classifying* science. Using the trajectory of idiographic science, one single case is studied as a systemic whole-together with its structural and temporal context. The researcher builds a model based on this single case, which she/he then repeatedly tests to other single cases. Generalized knowledge thus derives from a constant abstraction of the processes that regulate the organization of the selected phenomenon. Idiographic science preserves the time aspect-historicity of the phenomena, central in the organization of every psychological process (Molenaar & Valsiner, 2005), while permitting a study of intra-individual variation (IAV). In classifying science, generalized knowledge is based on a random sample, drawn from a population comprised of numerous specimens, which are believed to belong to the same category-class. The sample is believed to be representative of the population and hence the knowledge acquired by the sample is considered applicable to each and every member of the population. In striving toward quantification and the semblance of objectivity, psychology has chosen the trajectory of classifying science (Valsiner, 2000; Sato et al., 2007; Molenaar, 2004; Molenaar & Valsiner, 2005) and has followed it sometimes blindly, without questioning its adequacy to the questions posed or even its efficacy in providing understanding of psychological processes.

It is time to ask: can we actually achieve a random sample? And if we could, would this be able to represent the population where it was drawn from? In psychological research, specimens are usually human beings, who interact with one another, live in a specific societal context and maintain an interdependent relation with their environment. They also decide whether they want to be part of this sample of the study or not and usually they have reasons for doing so. Thus, the notion of randomization is not applicable to them. Further, classifying science assumes that all the members of the group have the same qualities and that they belong to this group by the same degree of membership. However, a careful look at the example of migrants invites us to reconsider this assumption.

### What is a “Random Sample” of Migrants?

#### *Heterogeneity and Change Behind the Labels*

During my fieldwork in Greece I came across several representations that the term ‘migrant’<sup>1</sup> carries in the narratives of the participants. These representations range from *miserable poor people* and *criminals* to *economically deprived people* or *peo-*

<sup>1</sup> In the Greek language there is one word to describe the terms immigrant and migrant.

*ple who have suffered* and deserve to be respected and treated equally. Consequently for some this term is repulsive, for others attractive and for a few it is used occasionally when being conscious of a common fate with others.

Talking to women who came from South America to live in Greece with their Greek husbands, the term *migrant* sounded strange, even repulsive to some of them. Although they referred to problems that most of migrants in Greece have, they rejected the term, sometimes with angry feelings. For them, the term is largely associated to Albanians, the largest flow of immigration in the 1990s (actually later than the respondents themselves arrived) and as such it bears all the negative stereotypes that Albanians have been associated with (for discussion on aspects of Albanian migration in Greece see: Galanis, 2003; Lazaridis & Psimmenos, 2000). Even if some got married and moved to Greece to find among other things, economic prosperity—which was, to a great extent Albanian’s motivation to migrate—their immigration, as one of them emphatically stressed: ‘was because of love’. In their reactions one can easily identify their need to distance themselves from whatever is related to the term ‘migrant’, as this seems to represent a threat to their identity. In accordance with Timotijevic’s and Breakwell’s (2000) findings, it signifies a loss of distinctiveness that arises when they are positioned under a superordinate group. A pattern contradictory can be identified at migrants participating in the Greek Forum of Migrants, coming from a variety of countries. For the latter, belonging to a group of migrants marks positively their distinctiveness and is the key to their participation to the activities of the Forum, largely political. Being ‘migrants’ means that they are aware of their rights and responsibilities, the laws concerning immigration and they actively participate in the struggle for better life conditions in Greece.

Thus, the term ‘migrant’ is used differently by each ‘group’ of people mentioned above. And within these so-called ‘groups’ there are people who relate to this term in diverse ways: they use it as a resource (when Rashid gets politically involved), they partly identify with it (when Esmeralda realizes the loneliness of the migrant, independently of his country) or reject it as something threatening (when Rosa thinks that being a ‘migrant’ is belittling).

When using classifying science in order to achieve a random sample, apart from suppressing the heterogeneity of phenomena we are also blind to their *time aspect*. The different meanings to the term migrant those individuals above attribute and the differential ways relate to it have to do with inner and social processes that are unique to each individual and are *subject to change throughout their lives*. Change, although inherent in the development of human beings, cannot be studied through the classifying trajectory. The stability of human nature is overemphasized in psychology (Sato et al., 2007, p. 95); phenomena are viewed as static and variation is considered to be the ‘noise’ that regulates and restricts the degree of generalized assumptions that the research can produce.

But how static are the phenomena we examine? Talking to migrants one identifies an intense fluctuation in their relationship with the term used to describe them. Oliver came to Greece from Kenya with a student visa when he was 22. He managed to get a Greek University degree in Economics and he talks enthusiastically about the student life experience he had in Greece during the first few years. It

was not until after many years that he realized his position as a migrant in Greece. Similarly, for Ramon coming from Chile, Greece was simply a tourist destination in a period of his life that he wanted to discover the world and free himself from the ‘tight’ boundaries of his country. His tourist position soon became a migrant one, turned into the position of a Greek citizen’s spouse and back into the migrant one, which leads him now to say meaningfully: ‘we are all Albanians’.

We can safely argue that there is no homogenous group of migrants; individuals have unique life trajectories, and relate to their environment dynamically. Imposing this generic term to all migrants means disregarding their will to be identified with it.<sup>2</sup> Consequently, our knowledge about these individuals is doomed to be short-sighted or even worse, unjust. Classifying science is therefore obscuring the ideographic level of phenomena under examination.

In order to understand the psychological processes involved in migration we need to examine the ways migrants themselves relate to the term we use to study them, the dynamic processes involved in their life trajectory and their migration transition and the way they make sense of their life experiences. These questions guide us towards the individual socio-ecological frame of reference (Valsiner, 2000), which embraces the individual, its environment, the social other and their transformative interactive relationships.

## Examining the Life Trajectories of Migrants Moving to Greece

Different reasons motivate or force individuals to migrate: economical, social, and political circumstances, family reunification reasons, dramatic or desirable personal life events and most of the times a combination of all the above. The life trajectories of individuals from all over the world who at some point of their lives migrate are thus shaped by an infinite number of conditions and events that make their trajectories unique.

In Fig. 21.1 an example of three different life trajectories of individuals migrating to Greece is depicted. Person A, B, and C have all moved to Greece from different countries and through vastly different trajectories, influenced by a number of different crucial conditions. These crucial conditions—experienced by the individual through a series of events—are depicted with the circles in the course of each life trajectory. The arrows emerging from these circles signify the different trajectories that the individual could have followed after having experienced these events—they are alternative trajectories that were not realized.

<sup>2</sup> This is something that Chrysochoou (2004, p. 9) has also noted: ‘We can hypothesize that migrants and members of non-dominant cultural groups might not regard the categories that others assign to them as important for self-evaluation... People have a variety of categories to which they belong and a variety of identities. The assumption of that they will use the one that homogenizes them as members of non-dominant cultural groups, or immigrants denies them all other identities’. To illustrate she gives the example of Muslim male immigrants in Britain who do not wish to identify themselves as immigrants as this implies permanent settlement (see Stickland, 2002).

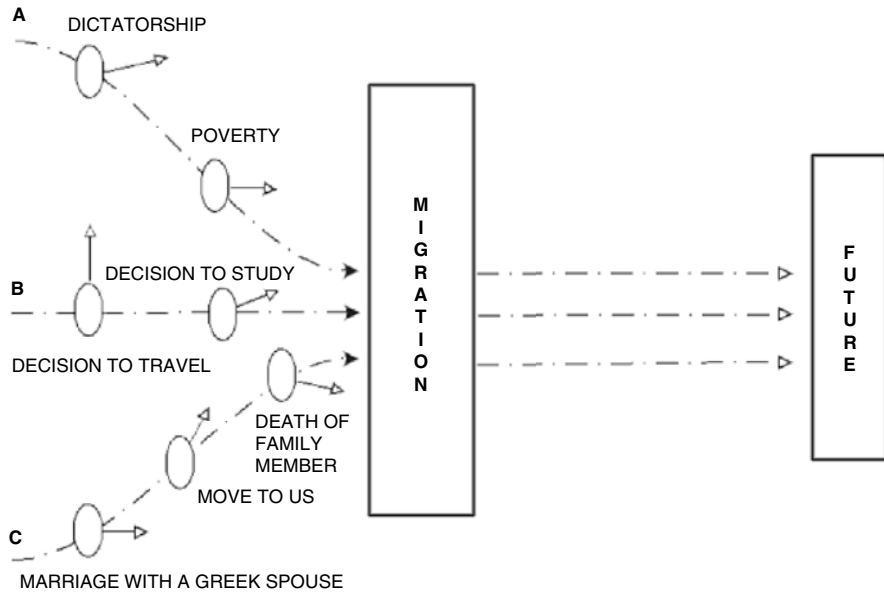

**Fig. 21.1** Three examples of life trajectories of individuals migrating to Greece

Deviating from criteria of ethnicity, the life trajectories of 31 individuals were examined coming from a variety of countries (several countries of South America, several countries of the African continent, Albania, Kurdistan, and Iran). In the examination of these life trajectories I focused on exploring the use of elements drawn from the cultural-symbolic field of the individuals to facilitate their transition to the new country, to confer meaning to their current situation and redefine-reposition themselves toward the future. Going through cultural and personal change individuals can face ambivalence and tension and it is during these moments of rupture that people engage in a dialogue with their culture (Becker, 1997). Cultural elements become facilitators—*symbolic resources* in understanding a new reality and in preparing oneself for a future situation, as Zittoun showed (2004, 2006) in both the cases of first name choices by couples for their babies to come and in the case of students moving to university. Symbolic resources respond to ruptures in inner feelings but also in those created in interaction of people coming from different cultural ‘worlds’ (see Gillespie, 2006; Wagoner & Kadianaki, 2007).

Following this framework, life trajectories were examined through in-depth interviewing that followed a ‘chronological’ and ‘transversal’ axis (Zittoun, 2006). The first guided questions within a flow of time, ranging from the times of their childhood until the moment of the study: life until the moment of migration, important life events that led to migration, representations of and expectations from Greece and experiences after arrival. The second concerned everyday life practices with specific focus on contact, use and meaning of cultural elements (such as music, fiction, cinema, religion, and others—as revealed in the course of narratives) in coping with the migration transition.

Studying the life trajectories of individuals permitted examination of: (1) their personality, their familial conditions and important life experiences, (2) the social, political, and economical circumstances in which they grew up. In this context one can identify the first ideas and motivations for migration, the life events (tragic, pushing, or impelling) that led to such a decision or solution, (3) the way the migration experience has been shaped according to the first two: as a rupture, as a possibility for change and personal growth etc. Accordingly, one can explore the resources stimulated by this experience in order to facilitate understanding of the new reality and repositioning of the self in this, and (4) the ways the migrant perceives his future: as an open, closed or vaguely defined diode to his home country or other destinations. These are shaped according to the experiences lived in all the above points in time.

The Trajectory Equifinality Model (TEM) that guides a Historically Situated Sampling (HSS) was developed to accentuate the historicity and the uniqueness of psychological phenomena (Valsiner & Sato, 2006). At the same time meaningful theoretical components are guiding the sampling procedure: individual cases are sampled according to their converging point—in this case, that of having moved to Greece—and the life trajectories that precede and follow it are studied. TEM permits us to study phenomena of systemic organization, open to constant exchange with their environment, as are the social-psychological phenomena involved in the migration transition.

## Using the TEM to Depict the Migration Transition

The notion of *equifinality* is central in this methodology and signifies a contemporary moment of similarity in the life course of the individuals, reached through vastly different individual trajectories and initial conditions. Cases are selected according to this converging equifinality point (EFP) into which they are all positioned in the time of the study. The EFP is thus a conceptual tool of the researcher, which allows the examination of the personal life trajectories of the participants through the different passage points they crossed in order to reach the present EFP.

Passage points are bifurcation points (BFP), where the individual faces alternative trajectories to move. In Fig. 21.1 BFP prior to migration were depicted by circles. These were important conditions in the lives of individuals that have shaped their trajectories and have defined their migration (i.e., dictatorship, marriage, economic deprivation, death of a family member etc.). Each of these conditions was made evident in the lives of individuals through specific events which for some individuals can be recalled and for others not, but their effect is understood, felt and memorized as general conditions-markers of these events in their memory.

Migration is then another BFP that all participants crossed at different times in their lives. Some of the passage points that individuals go through can be obligatory (OPP—obligatory passage point): one's life trajectory is prescribed to go through events which are either of biological nature (i.e., death of family member) or implied by the environment or the customs of the social setting (i.e., marriage); these are 'indigenous' and 'exogenous' obligatory passage points (OPP) accordingly.

The life trajectories as depicted in Fig. 21.2 are examined within irreversible time, as they move from the past to an infinite future. Time is an inherent feature in their development and doesn't represent the external dimension that we use to study it (Valsiner, 2000). In the case of migrants, time is apprehended through the way these individuals structure their narratives and is thus subjectively constructed.

Following the point of migration, preliminary research with 24 individuals coming from a variety of countries (see Kadianaki, 2006) served to *specify the EFP* according to which the 31 cases were selected. It showed that migration triggered different types of rupturing experiences during the transition to the new country. Specifically, four broad themes of *rupturing experiences* arose: (1) in times when rather idealized expectations from and representations of the place to come meet a hard reality, (2) in times of rupturing inner feelings such as home nostalgia, or anger about how one is treated in the new country, (3) in times of confronting otherness: (a) one needs to understand the generalized, the Greek other, (b) one needs to position oneself in the available space that the Greek other offers (e.g., that of a poor and miserable migrant when what he was expecting was becoming successful and admirable), and (4) in times when one returns home (permanently or temporarily) and things have changed in the way he understands the social reality or how his home community perceives him.

The EFP brings together all the above disruptions of the normal flow of life caused by migrating, when meanings called for redefinition. Individuals experienced ruptures in all these domains, others only in one and others experienced them at different times after their migration. Thus, the EFP is a *zone in time* (EFZ<sup>3</sup>) signifying the

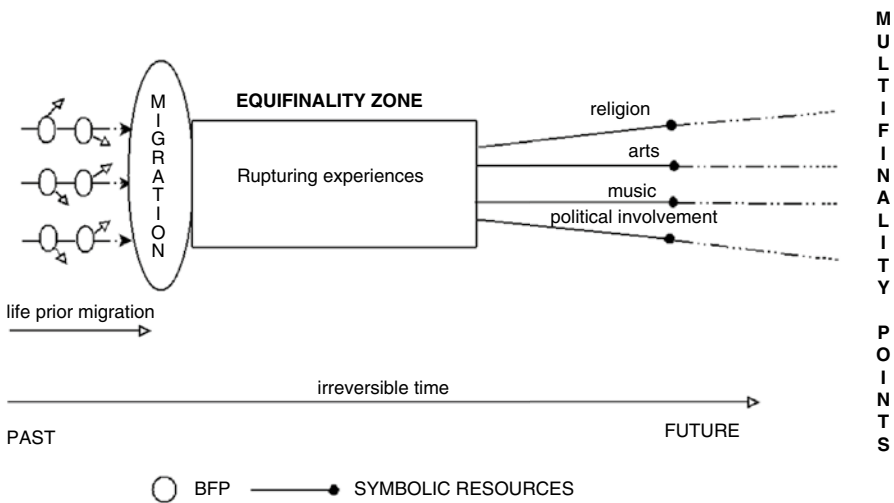

**Fig. 21.2** The migration transition through TEM: Bifurcation points, equifinality zone, and symbolic resources

<sup>3</sup> Henceforth called EFZ, Equifinality Zone.



similar state of already being a migrant in Greece and experiencing a rupture in one or more domains of experience (see Fig. 21.2). The attention of the research falls on the EFZ and the subsequent means employed to guide the migrants towards future, all in relation to life trajectories (as depicted in BFP) prior to migration.

The inner and social ruptures that the passage from the EFP triggered generated the use of cultural elements as symbolic resources. These have several functions and dimensions (Zittoun, 2006). For example, they provide the individual with time orientation that (re) establishes the sense of continuity between past and future. For Sabar, a 32-year-old Kurd from Turkey who has left his country due to prosecution, his political studies and involvement in Greece help him link the ideals of the past with those he wants to strive for in the future. Symbolic resources also assist the understanding of the new social reality and position the individual in the social milieu. For Basma coming from Egypt, religion guides her through ambivalence created by the opposing demands of the new environment and her traditional ways of thinking as shaped in her pre-migration life in Egypt.

Among other functions of semiotic regulation, symbolic resources also guide the immediate actions of the individuals and assist them in creating a personal system of commitments and beliefs. Rashid, coming from an oppressing social environment, illustrates this through his participation in the activities of the School of Migrants. Ideals of freedom and democracy become central parts of his system of beliefs and commitments that he vigorously strives for (Kadianaki, 2006).

Symbolic resources emerge from the Equifinality Zone *as ways to overcome the ruptures* induced by the migration. In the time of the study, *migrants are in the making*: as shown from the examples above, they are trying to make sense of their experience and employ different means drawn from their culture to do so in diverse ways. Symbolic resources are guiding individuals towards the future, towards unknown and infinite multifinality points by opening new paths through which individuals can move. As the case studies will demonstrate later, TEM permits us to explore the *relationship* between the *BFP* leading to migration, the *ruptures* evoked by the transition and the *resources* employed to cope with them.

TEM thus permits examination of the life trajectories of individuals up until the moment of study. Through TEM one can identify crucial life events that lead people to migrate, the ways they make sense of their experience according to their motivations and expectations and the intentional use of cultural elements to work through transition. As such, they contribute towards a consistent, culturally positioned and dynamic life history examination of the migration phenomenon.

## Two Cases Studies: Lysette and Endrit Moving to Greece

In order to illustrate the use of TEM in the case of migrants moving to Greece I will use two case studies: their life trajectories prior to migration, the passage from the EFP and their use of resources to cope with the ruptures induced by the migration transition.

## *Lysette's Story*

Lysette was born in 1964 in Free Town in Sierra Leone. She was the fourth child of a family that was soon separated. Early in her life she had to move and grow up with her father, her step mother and only a couple of her sisters and brothers. She finished school and studied Public Relations in a private College, but couldn't practice her studies. She realized very soon in her life the extreme poverty her country was in. She recalls vividly the day her father came in the house and said they had no money to buy food. Since her 16 years of age she had to study and also make her living, while supporting her family as much as she could. This meant doing very hard jobs and earning little money.

She describes herself as being very active against the oppressive government of those days, something that often put her family in danger. Back then, listening to Bob Marley would give voice to her dreams about freedom, equality and revolution and despite not having electricity she would find batteries to listen to his cassettes, although this was prohibited by the government. Listening to his songs would make her dream of leaving the country and she always thought of that as an achievement.

She briefly mentions giving birth to a child, but not making a family. She continued working hard and in one of her jobs she became close friends with a Greek couple living at that time in Sierra Leone. She used to spend a lot of time with them and she describes vividly the Easter celebrations, with lots of food, drinks and dancing (all very scarce those days). They often suggested that she left the country to live somewhere else, in better conditions. When they left they promised that they would help her leave Sierra Leone and soon after leaving they sent her a ticket to come to Greece.

Lysette left the country without second thoughts in 1982. The whole night before her flight she describes listening to Bob Marley and dancing, dreaming of her freedom. When she arrived in Greece she stayed with her Greek friends for the first six months and then she found a job as an actress. By that time her visiting visa had expired. Soon she became recognizable, which resulted in being noticed by the police and arrested, one day before coming out on stage. She was released and given some time to leave the country but she decided to stay illegally and work in a house, taking care of an elder couple. This was not something she was used to doing. She describes that in Sierra Leone people would have 'servants' in houses even if they were poor, so being herself one was not something she had anticipated. Having no other choice, she got used to it and stayed there for a long time, but didn't get paid properly. She wasn't given any help with issuing her green card or having social security and that resulted in being fired after 10 years without having any money or any proof that she has been in the country for all these years.

Being desperate, she sought for help in a women's organization. After she managed to overcome all the difficulties and get her green card, she decided to start her own organization. The injustice she received and the problems she faced motivated her in inspiring and gathering a few other women to set up an African Women Organization with the objective to 'fight for their rights'. Today, she is still running

the organization, being one of its most passionate members. She protests in marches and seeks actively for chances to demonstrate and talk about the problems of the African migrants in Greece. She tries constantly to motivate all African Women to learn about their rights and fight for the better. Listening to Bob Marley still makes her feel passionate, helps her realize the ideals she is fighting for.

A series of events since her migration have dramatically affected her life: her parents died and she has no signs of where her sisters and brothers are after the civil war in Sierra Leone. She is still in touch with her son, although she hasn't seen him for 10 years. As she says a way to overcome the difficulties in her life is to get involved in the organization: this is one of the very few things that give her meaning in life and the energy to keep going, to sustain her hopes for a better future. As for the later, although she is not thinking of returning to Sierra Leone much, she does not rule out the possibility. She feels there must be a good reason for her to return and that so far there hasn't been any. On the contrary, news from her country is always sad: illness, death and loss. That is why her future plans are still blurry.

### *Endrit's Story*

Endrit was born in Albania in 1973 and grew up in a rather quiet and pleasant environment as he says. Soon after he was 12, he started realizing what it meant to be living under a communist regime and gradually became critical of the system. The economic scarcity, the collective way people lived and some signs of how life was in the West (through few advertisement and TV programs not prohibited by the state) created a myth about life outside the borders. Growing older, he felt the need to distance himself from what he experienced as extreme collectiveness, where ideals of solidarity and respect for each other lost their true meaning; as he says they were a result of a forced and meaningless discipline. When the borders to Greece opened, in 1991 he arrived in Athens for the first time.

His first night in Athens brings together most of the ruptures that the migration transition could bring for him. Each of the people with whom he arrived left, following their own way. Also, a few Albanians that he knew they were living in Athens couldn't be found and he had to spend the night outside. He describes being in the 'real world', in a 'European capital' where anything could happen. Nothing was familiar to him; he says he couldn't imagine a space available for him in this big city. From the extreme collectiveness he felt he passed onto the other extreme, where he had to live and decide only for himself. A series of events during that first night made him feel he was not prepared for this and decided to return home soon after that. However, the urge to leave his country re-emerged and led to several attempts to enter Greece during the following years. Finally, he managed to enter the borders in 1994 and stay up until today.

During his first years in Greece he worked hard, but he was also going out a lot, enjoying the pleasures of living in a 'Western society'. He made few friends, among them some students he lived with for some time. They all shared a political-

anarchist ideology that he became affiliated with, as a means to understand the new situation in which he was living. He was facing the difficulties of being a migrant in Greece and was in constant interaction with many Albanian migrants who were working and living in very bad conditions and experiencing racism. As he mentions he felt an enormous need to change the situation, to make his personal fight part of a greater, social fight of the poor against the rich. He set up an organization with a group of friends who were feeling the same way he did; an organization that would express an everyday fight against the system.

Part of his determination for change was expressed in his decision to study social sciences in the University. This was done in the most difficult period of his life, when his family came to Greece with the intention to stay permanently. A serious health problem changed their plans and he had to work more to support them. He managed to finish his studies and his family moved back to Albania after some time. Today he works in a company, he frequents the organization and in his spare time he reads a lot. His choice of books reflects his ideology and his will to pursue social change, which always follows him at the back of his mind, as he says. His favourite book is the 'Man who laughs', by Victor Hugo, in which the main character, as he mentions, bursts and rebels without a specific reason and towards all directions.

He keeps in touch with his family and visits Albania often. He likes to know about the political situation there, although due to his ideology, he doesn't consider himself as a patriot. He also likes to read and talk in Albanian and considers language as one of the most important ethnic elements he likes to preserve. He sometimes thinks of returning permanently, but not very intensely. He thinks that during the next few years, it will be quicker to reach Albania as the road infrastructure will improve. This makes him imagine his future as 'coming and going' rather than being in a place permanently.

### ***Lysette's and Endrit's Migration Transition Through TEM***

Lysette and Endrit structured their narratives building on crucial social conditions which affected their lives and their migration to Greece (Fig. 21.3). For Lysette, three catalytic experiences were identified in her narrative as leading to her migration: (1) extreme poverty that was experienced through several incidents (i.e. the vivid memory of her father saying they have no money to eat, working hard, and not making a living), (2) the oppressive regime and the bad state of her country (Bob Marley's songs assisted her understanding of the conditions she was in and the alternatives of equality and freedom she wanted to achieve), (3) the Greek friends that she had: they provided her with an alternative choice of life and helped her realize it. For Endrit, several events which couldn't be accurately recalled, extending over a period of time, led him to be critical of the communist state while they stimulated his need to discover how life could be outside the borders. Unlike other applications of TEM (see Sato et al., 2007) the BFP here are not always specific and defined

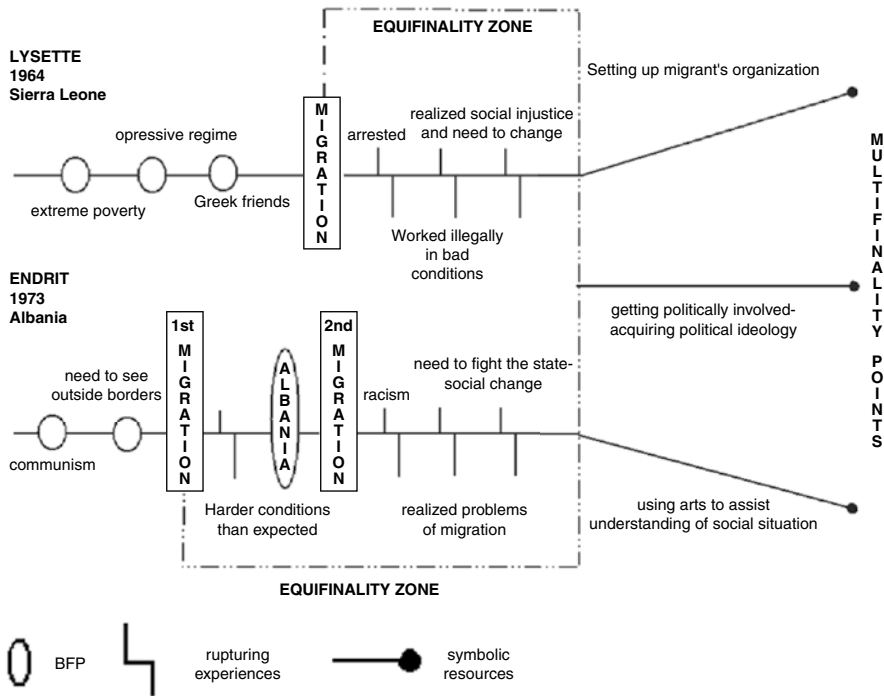

Fig. 21.3 Lysette’s and Endrit’s migration transition through TEM

events leading to decisions; rather they are conditions that can be brought to awareness through events that individuals might recall or vaguely identify.

Following migration, Lysette and Endrit experienced several ruptures, located in the EFZ. Lysette got arrested and then had to work illegally in conditions that she didn't expect. Her ruptures had to do with feeling angry about the way she was treated and with the fact that her hopes for a better life in Greece were scattered: the available space for her in Greece was not the one she had imagined. Since then she realized that life can be very hard independently to where one lives. Endrit's ruptures had to do with a different way of life he expected in the 'West'. From extreme collectivism he passed onto individualism. The racism migrants were facing in Greece and the unjust working and living conditions made him realize that the current political system did not express his ideals, the ones that brought him to Greece.

As shown above (Fig. 21.3), Lysette's and Endrit's ruptures were dealt with the employment of actual and symbolic means. Setting up a migrant's organization, enriching their knowledge on politics and becoming involved in politics (through different ways each) were means to bring back social justice and equality but also to understand their position in the new environment. Now they can offer their help to other migrants but also fight united towards a common goal. Both of them use arts to assist this process. Lysette employs Bob Marley's songs and Endrit reads books that are consistent with his ideology. At the time of the study both of them are

dynamically interacting with these symbolic means in order to open path towards the future.

It is important to note that the specific symbolic resources employed respond to the BFP that led to the migration and the ruptures that they experienced. Neither of them were happy with the regime in their countries, they came to Greece hoping for a different situation, but a series of events proved their expectations wrong. Subsequently, the resources they used—all of a political quality—were directly related to their experiences throughout their life trajectories. Thus, we can identify a qualitative link between BFP, ruptures and symbolic resources in the life course of these individuals, which only becomes obvious when we examine their life trajectories up until the moment of the interview.

## Conclusion

In this chapter I have shown why the use of random sampling is not appropriate in the study of cultural-psychological phenomena of migration. Randomness implies homogeneity and stability, both of which are unattainable in the case of living human beings and their cultural psychological functioning. Through the case of migrants in Greece, I have demonstrated that there is great heterogeneity behind the labels that we use to study individuals and in fact this can be seen as richness of the phenomena under examination. In psychology very often descriptive labels have been turned into explanatory ones obscuring the nature of the phenomena, rather than promoting their understanding. Cross cultural psychology offers many such examples of comparing seemingly homogenous ethnic groups to one another<sup>4</sup> (Valsiner, 2003).

In contemporary psychology, rather than increasing the amount of data in the name of science, we need to examine individuals and their psychological functions as embedded in the socio-cultural settings they live. Vygotsky's zone of proximal development (1978) recognised the transformative role of the social environment in individual development by situating it in social interaction. Transferring his ideas here, we can argue that rather than comparing individuals according to their outcomes in specific psychological tests, it is better to select individuals according to the way they meaningfully form their life-trajectories. TEM has replied successfully to this challenge.

There are of course certain limitations in the application of the TEM. These are limitations specific to qualitative research but also deriving from the particular theoretical and methodological stance of this research. As all qualitative research, it

---

<sup>4</sup> Valsiner (2003) explains: 'For example, it could be said that the "Italian-ness" of Italian subjects can be recruited to explain their behavior, in contrast to the "American-ness" of the American subjects. The construction of explanations like this is circular—Italians are found to be Italian because they are from Italy; and Americans to be American because they are from America (or from the United States). Interestingly, quite often there is considerable overlap in "distributions", that is, it could easily happen that Italians are more "American" in their responses than Americans, and vice versa'.

demands a high degree of familiarization of the researcher with the individuals of the study and is subject to situational aspects that shape the reconstruction of experiences. Participants get involved in a long process of recalling and narrating of both pleasant and traumatic events of their lives. Their ability and willingness to recall and the degree to which they invest on the research process depends highly on the researcher's ability to inspire trust and ensure that the space between interviewer and interviewee is a safe place for these to be heard. But also there is something unavoidable in the mere presence of the listener (researcher). To simplify Bakhtin's argument (1981), an utterance is always an utterance towards some Other, and interviewees are forming their narrative in relation to their listener—the particular person-researcher in a particular socio-cultural setting.<sup>5</sup>

Another limitation refers to tracing symbolic resources in the lives and narratives of participants. Depending on the degree of reflexivity in the use of a symbolic resource (for extended discussion see Zittoun, 2007) references to them in the narratives varies intensely across individuals and it is not an easy task to identify them. It is often only through triangulation of data (Patton, 2002) that these limitations can be confined or even overcome. The use of different methods in parallel (observation, interviewing, focus groups) and the subsequent increase in familiarity of the researcher with the informants can illuminate aspects of the participants' experiences which refer to such processes of interiority, such as emotions and meaning-making conduct. Also, through triangulation the researcher becomes increasingly aware of the situational aspects that shape the research process and of the possible, imaginary or actual audiences towards which the informants address their narratives.

Focusing on the strengths of the TEM, the purpose of applying it to the case of migrants in Greece was to reveal the enormous heterogeneity behind the label of migrant and to abstract the psychological processes that regulate the migration transition to Greece. Through TEM we can: (1) Comprehend the process through which a decision to migrate is made (through social-economical-political conditions and crucial personal life events). (2) Examine the ways through which individuals form representations of and expectations from the place they are migrating to (mass mediated resources and other people's accounts interacting with personal and sometimes illusive expectations). (3) Understand how rupturing experiences are caused as an interaction of processes 1 and 2 and the experiences lived in arrival. (4) Examine the processes in which individuals engage in order to overcome the ruptures: the symbolic means-resources that they employ, their origin in the life trajectories of individuals and their function. Thus uncovering the subjective and idiosyncratic ways of coping with the migration transition, opens a path in comprehending how psychological functioning is organized and regulated across individuals.

Advancing our understanding on the above issues, can hopefully transcend the boundaries of scientific knowledge and find a way to serve the needs of practical policy-making and interventions. To briefly give two examples of intervention: (1) The unrealistic formation of representations prior to arrival is often an important

---

<sup>5</sup> In a similar fashion, Gillespie (2006) talks about the 'surplus of knowledge' that functions as a feedback that the other can provide to the self, as a mirror does for our appearance that we cannot perceive in any other way.

cause of experiencing the migration transition as a rupture rather than as an opportunity for the realization of personal goals, growth, and development. This could be an area of intervention by the supply of realistic information to the migrants to come. (2) Individuals, as I have shown, find creative ways to cope with the ruptures of migration. However, societies and governmental policies, blind to the particularities and needs of migrants and their groups, often inhibit these creative processes or deprive migrants altogether from access to cultural resources that are of great importance to them. Practicing religiosity in the absence of worship places (i.e., absence of mosques in a Christian society) is only one example. Thus, policies need to be created and implemented through a sensitized process of looking at the distinctive characteristics and needs of migrant groups. Promoting access to important cultural and religious resources could possibly facilitate experiences of personal growth instead of those of failure.

To conclude, it seems that ideals of objectivity and generalized knowledge have guided psychology so far, leading often to the obfuscation of the phenomena. In fact, ‘objectivity in science emerges on the basis of a deeply subjective process of generalization’ (Rosa & Valsiner, 2007, p. 704). Hence we should not be afraid to embrace the variability and individuality of psychological experiences, as this seems to be a crucial step towards rich understanding. Thus, although for the 31 individuals that moved to Greece, their migration was shaped by a great variety of conditions and events than happened around the world and affected their lives in very particular ways, their narratives can promote our knowledge and understanding of what it means to be a migrant.

**Acknowledgments** I would like to thank Vassilis Pavlopoulos, Jason Rentfrow, Alex Gillespie and Jaan Valsiner for reading earlier drafts of this chapter and offering me their constructive comments.

## References

- Bakhtin, M. M. (1981). *The dialogical imagination*. Austin: The University of Texas Press.
- Becker, G. (1997). *Disrupted lives: How people create meaning in a chaotic world*. Berkeley: University of California Press.
- Chrysochoou, X. (2004). *Cultural diversity: Its social psychology*. Oxford, UK: Blackwell Publishing.
- Galanis, G. N. (2003). Greek society and immigration. Opinions of Greeks for Albanian immigrants. In K. Kasimati (Ed.), *Migration politics and strategies of integration. The case of Albanian and Pole immigrants*. Athens: Gutenberg. (in Greek).
- Gillespie, A. (2006). *Becoming other: From social interaction to self-reflection*. Greenwich, CT: Information Age Publishing, Inc.
- Kadianaki, I. (2006). *The use of symbolic resources by young adults, immigrants in Greece*. Unpublished dissertation submitted for the degree of MPhil. University of Cambridge—UK.
- Lazaridis, G., & Psimmenos, I. (2000). Migrant flows from Albania to Greece: Economic, social and spatial exclusion. In R. King, G. Lazaridis, & C. Tsardanidis (Eds.), *Eldorado or fortress? Migration in Southern Europe* (pp. 170–185). London: Macmillan.
- Molenaar, P. C. M. (2004). A manifesto on psychology as idiographic science: Bringing back the person into scientific psychology, this time forever. *Measurement: Interdisciplinary Research and Perspectives*, 2, 201–218.



- Molenaar, P. C. M., & Valsiner, J. (2005). How generalization works through the single case: A simple idiographic process analysis of an individual psychotherapy case. *International Journal of Idiographic Science, 1*, 1–13, from <http://www.valsiner.com> (Available in S. Salvatore et al. (2009), *Yearbook of idiographic science 2008*. (Vol. 1). Rome: G Fireira Group)
- Patton, M. Q. (2002). *Qualitative research and evaluation methods*. Thousand Oaks: Sage.
- Rosa, A., & Valsiner, J. (2007). Socio-cultural psychology on the move. In J. Valsiner & A. Rosa (Eds.), *The Cambridge handbook of sociocultural psychology* (pp. 692–707). New York: Cambridge University Press.
- Sato, T., Yasuda, Y., Kido, A., Arakawa, A., Mizoguchi, H., & Valsiner, J. (2007). Sampling reconsidered: Idiographic science and the analysis of personal life trajectories. In J. Valsiner & A. Rosa (Eds.), *The Cambridge handbook of sociocultural psychology* (pp. 82–106). New York: Cambridge University Press.
- Stickland, N. (2002). *Multiple identities: Examining relationships between identities among Muslim men*. B.Sc. thesis, University of Surrey, UK.
- Timotijevic, L., & Breakwell, G. M. (2000). Migration and threat to identity. *Journal of Community and Applied Social Psychology, 10*, 355–372.
- Valsiner, J. (2000). *Culture and human development*. London: Sage.
- Valsiner, J. (2003). Culture and its transfer: Ways of creating general knowledge through the study of cultural particulars. In W. J. Lonner, D. L. Dinnel, S. A. Hayes, & D. N. Sattler (Eds.), *Online readings in psychology and culture* (Unit 2, Chap. 12). Bellingham, WA: Center for Cross-Cultural Research, Western Washington University, from <http://www.wvu.edu/~culture>
- Valsiner, J., & Sato, T. (2006). Historically structured sampling (HSS): How can psychology's methodology become tuned in to the reality of the historical nature of psychology? In J. Straub, D. Weidemann, C. Kolbl, & B. Zielke (Eds.), *Pursuit of meaning* (pp. 215–251). Bielefeld: Transcript.
- Vygotsky, L. S. (1978). *Mind and society: The development of higher psychological processes*. Cambridge, MA: Harvard University Press.
- Wagoner, B. & Kadianaki, I. (2007). Selves on the move. *Culture and Psychology, 13*(4), 488–499.
- Ward, C., Bochner, S., & Furnham, A. (2001). *The psychology of culture shock* (2nd ed.). Hove, UK: Routledge.
- Zittoun, T. (2004). Symbolic competencies for developmental transitions: The case of the choice of first name. *Culture & Psychology, 10*(2), 131–160.
- Zittoun, T. (2006). *Transitions: Development through symbolic resources*. Greenwich, CT: Information Age Publishing.
- Zittoun, T. (2007). The role of symbolic resources in human lives. In J. Valsiner & A. Rosa (Eds.), *The Cambridge handbook of sociocultural psychology* (pp. 343–361). New York: Cambridge University Press.

# Chapter 22

## Innovative Moments and Change Processes in Psychotherapy: An Exercise in New Methodology

Anita Santos and Miguel M. Gonçalves

Psychotherapy is a field where development of dynamic methodologies is a conceptual imperative. In this chapter we present an analysis of the Innovative Moments (i-moments) emergence in psychotherapeutic process, through a dialogical lens. I-moments are the novel ways of thinking, interacting, and behaving that the client narrates in the therapeutic conversation, which is different from the rule he or she usually applies to his or her life. This rule is composed of general meanings over the world that guides their behaviors and understandings about it. Using Josephs' and colleagues dialectical framework (Josephs & Valsiner, 1998; Josephs, Valsiner, & Surgan, 1999) we can conceive this rule as a macro organizer of meaning.

Thus, i-moments are considered new emergent meanings that are the promoters of change in psychotherapy. We explain how i-moments develop from the macro organizer of self's meanings and their dialectical nature. We shall then analyze the processes of meaning maintenance in therapeutic poor outcome, as i-moments emerge and are recurrently integrated into the macro organizer of meaning. We also explore how i-moments meanings develop in order to achieve therapeutic change, namely into higher levels of meaning hierarchy, expressed by re-conceptualization and performing change i-moments.

### Narrating in Psychotherapy

According to the narrative metaphor, people make sense of themselves through the construction of narrative structures (Bruner, 1986; McAdams, 1993; Gonçalves, 2000; Polkinghorne, 2004; Sarbin, 1986). When these self-narratives become monothematic (Hermans & Hermans-Jansen, 1995), monological (Gonçalves, Matos, & Santos, 2009), dominant (Neimeyer, Herrero, & Botella, 2006) or saturated by the problem (White, 2007), they cease to have the flexibility of organizing the flow of

---

A. Santos (✉)  
Avenida Carlos Oliveira Campos – Castelo da Maia  
4475-690 Avioso S. Pedro, Portugal  
e-mail: anitasantos@docentes.ismai.pt

experiences of daily life. These dominant narratives become a strict rule of acting, feeling and thinking (e.g., depressive self-narrative) and all the episodes outside this rule tend to be trivialized or ignored, making the emergence of novelties very difficult to occur. An innovative moment (i-moment) refers to the emergence of a feeling, a thought, an episode or even a project that is different from the ways people usually make sense of their lives. Thus, i-moments constitute opportunities in therapy (and in everyday life) to challenge the dominant self-narrative (see Gonçalves et al., 2009).

I-moments have been studied in the context of narrative (Matos, 2006; Matos, Santos, Gonçalves, & Martins, 2009), emotion-focused (Gonçalves, Mendes, Ribeiro, Angus, & Greenberg, 2009), and constructivist psychotherapy (Ribeiro, 2008) and also in daily life changes (Cruz, 2008; Meira, 2008). We hypothesize that i-moments are process variables that allow depicting developmental patterns in self change processes. In this work we will apply the dialogical-dialectical approach (Josephs & Valsiner, 1998, Josephs et al., 1999) of meaning making to understand how i-moments emerge and develop, based on findings from a sample of narrative therapy (Matos et al., 2009).

We start by describing the processes involved in the maintenance of the problematic narrative (the rule) and also how the novelty (the exception) emerges, and then we focus on their dialectical nature, from a dialogical perspective. Within this framework, we explain the processes involved in the meaning maintenance and change in narrative psychotherapy.

### ***Innovative Moments in Narrative Therapy***

Signs, or meanings, are the mediators of psychological processes involved in development, as in psychotherapeutic change and either at an intra or interpersonal realm. They regulate the ongoing and fluid everyday experiences with the persons' meanings about them, organized in a narrative structure (Bruner, 1986; McAdams, 1993; Gonçalves, 2000; Polkinghorne, 1988; Sarbin, 1986; Valsiner, 2005). The developmental focus of this work follows Valsiner's (2001) definition of "present-to-future" developmental models, in which researchers "focus on the processes of emergence—or construction—of novelty" (p. 86). A semiotic approach enables the study of the meanings emergence online, as they are happening and as future oriented. Consider the following statements:

"I *want* to change"  
and  
"I *guess* I want to change"

These statements not only entail a present self condition of wanting to change, with some contrast with the past, but also different future potential orientations. The first statement may allow the engagement in the change process, whereas the second may prevent this active engagement, as the client used "*I guess*". The second statement seems to entail an ambivalent feature of self-uncertainty and bypass the

power of self oriented goals expressed in “I *want* to change”. Ultimately, “I *guess*” can lead to further reflections about wanting to change, actually not engaging in real efforts in order to do so. On the other hand, “I *want* to change” can promote a self state that combines reflective and active attempts to achieve a given transformation. However, the same example “I *guess* I want to change”, depending on the context, can involve the source of ambiguity or tension that is needed for further development to happen. The expressed uncertainty also entails a flexible structure needed for the emergence of other meanings. In this sense, “I *want* to change” can be seen as a way to escape ambivalence and promote stability, but at the same time, almost paradoxically, preventing development.

The self system of meanings is considered to be hierarchical, constantly involved in auto-regulation processes that either maintain stability, or generate flexibility that can lead to transformation. Regulation allows the abstraction of personal experiences into subjective and generalized meanings, which can later be applied in different contexts. Signs are interdependent, since they regulate each other in different levels of the hierarchy. The example “I want to change” may be situated at a lower level before the client entered therapy, but may also constitute a high level organizer that rules the person’s actions and thoughts in the future. Signs at the lower levels can thus be developed into the higher ones through an abstraction process (“*abstractive generalization*”, Valsiner, 2001, p. 94). The reverse process is also valid, since meanings of higher levels are able to regulate particular contexts (“*contextualizing specification*”, Valsiner, 2001, p. 94).

The client brings to the therapeutic encounter a current understanding or meaning about a specific problem that is expressed through a problematic narrative, or narratives, which seem to be composed by several rules or laws constituting the main framework for his or her understanding of life experiences. In this sense, they seem to work as macro organizers of self’s meanings (Josephs & Valsiner, 1998). There are other clinical situations in which there is hardly an organized structure of meanings and signs may be rather dispersed and not at all organized (see Dimaggio, 2006). This applies to some psychotic states (e.g., Lysaker & Lysaker, 2006) and also to some personality disorders (e.g., Dimaggio & Semerari, 2004). In this chapter we will, however, deal with situations in which clearly a macro organizer—or several—creates strong restraints to meaning making processes (this is akin, as we wrote, to monological narratives, Gonçalves et al., 2009).

Macro organizers of meanings are higher order meanings that work at an abstractive level, providing the person with specific rules of action and worldviews. In this sense, they seem to be also an evaluator of the person’s experiences and provider of morality judgment over them by statements like “I should” or “I should not”. These macro organizers emerge in the client’s narratives, usually by the emphasis in a main theme that can be a specific problem or a problematic situation, or even a set of recurrent themes, due to their “rigid generative processes” (Josephs & Valsiner, 1998, p. 73). So, they originate applications of general rules (such as avoidance of “danger” in anxiety, for instance) to the daily life context, becoming dominating and restrictive of clients’ experiences in the extent that micro or daily narratives that clients narrate are contaminated by it.

The established macro organizer of meaning is at the foreground and whenever new potential meanings emerge they tend to decay and no innovation develops. The use of this generalized meaning organizer has the consequence of stabilizing or even restraining the person meaning making efforts, as “the application of only a few basic rules would generate homogeneity within a closed system” (Josephs & Valsiner, 1998, p. 73). A macro organizer can be challenged by the occurrence of exceptions to its rule, by the self or others suggestion (as the therapist), but they can easily lead “only to circular protest or defense (“one should not do that because one should not do that”) and often to a further strengthening of rigidity” (Josephs & Valsiner, 1998, p. 73).

For instance, a female client that describes panic symptoms and episodes of agoraphobia as her major problem will probably narrate life situations highly contaminated by intense anxiety and fear. Somatic complaints, progressive isolation, and social withdraw would also be ingredients in her narratives. Her feelings would be dominated by the fear of losing control and avoidance actions would be recurrently used and therefore maintained.

**Client:** I spend a lot of time at home... watching TV, most of all. I can't find anything to do that pleases me. I really avoid getting out. Every time I need to go shopping it seems real torture to me. I must think about the best time to go: when I will not find so many people at the supermarket or when there will be less traffic on the road because I'm not able to drive in highways, it gets me confused and wondering where I could park the car...  
I avoid going to the mall... I feel like I can't breathe and I have to get out. Even in church, I have to stay by the door. All of this is too much to bear... I can't tell anyone about it. I won't allow anyone to think I'm being weak...

In this previous case, the words “*I can't*”, “*I avoid*”, “*I won't allow*” are clearly associated with a macro organizer of meanings that demands and establishes rules for her life. The macro organizer meaning condenses all the client's usual ways of acting and reasoning. An exception to this meaning organization would be, for instance, going out to the supermarket to buy something, even out of rush hours. Another example can be thinking, at some point, that the consequences of the progressive isolation will be dramatic for her life, or that she simply needs to change. These constructions were named *unique outcomes* in the re-authoring therapeutic model of White and Epston (1990). Therapeutic conversation invites

...people to continue to develop and tell stories about their lives, but they also help people to include some of the more neglected but potentially significant events and experiences that are “out of phase” with their dominant storylines. These events and experiences can be considered “unique outcomes” or “exceptions” (White, 2007, p. 61).

In this model, unique outcomes are especially important as they are the departure point for change to happen. According to White and Epston (1990) “...alternative stories can be generated or regenerated through a performance of meaning around unique outcomes” (p. 32). As clients become able to notice these exceptions and they are expanded in therapeutic conversation, they will further constitute a new self-narrative or a new self macro organizer of meanings. The therapist will help the

client to identify or co-construct these exceptional moments by means of therapeutic conversation. From this point onwards they become noticeable more often and then they are expanded into new life areas or situations. These exceptional moments seem to be the roots that provide a basis for the narrative construction of novelty, in narrative therapy. They also feed the new self-narrative, since they seem to attract other exceptions throughout therapy, in a process of novelty escalation that is the construction of a new macro organizer of meaning. If we believe that the problem dictates the rule for the person's life, then any exception to it would be a unique outcome. As Watzlawick, Weakland, and Fish (1974) pointed out "ordinarily, the promoter of change (even in certain aspects of growth and development) is deviance from some norm" (p. 31).

In the next example "*I did it two or three times*" would be considered a unique outcome, as well as "*I guess one of those times I wasn't so nervous*". However, it is also clear that the client integrated this episode in the macro organizer, since she immediately said "*I will not try to do it anytime soon!*".

**Client:** Facing a crowd? I did it two or three times and I will not try to do it anytime soon! I will certainly not! It's such an awkward feeling, my heart beat so fast, I was nervous and disoriented. My only goal was to get home quickly. I guess one of those times I wasn't so nervous.

A network of exceptions could be elaborated from the construction of meaningful connections between these unique outcomes, and turn into a new self macro organizer narrative. Progressively, as successful therapy evolves, what was the exception will become the new rule for the client's life.

Unique outcomes seem to be occurring before therapy started. Krause and colleagues (2007) suggested that change starts occurring before the client enters in therapy, being the "acceptance of one's own limits and the awareness of the need for help" (p. 674) the first efforts that lead to the actual search for help. Therefore, one of the first noticeable unique outcomes could be seeking for help and attending therapy.

### ***Innovative Moments (i-moments)***

From the notion that narrative change is achieved by the elaboration of exceptions, a method for tracking these moments was developed. As research in narrative therapy developed, the notion of unique outcomes was found to be misleading. As they seemed to have an important role in therapeutic change (Matos et al., 2009), the concept of innovative moments (i-moments) was adopted because they were found to be frequent and of a diverse nature (innovative, not unique), emerging throughout therapy. Besides, they are processes and not simply outcomes.

According to the Innovative Moments Coding System (IMCS; Gonçalves, Matos, & Santos, 2009), i-moments are tracked from the macro organizer of meanings that the client brings to therapeutic conversation. This is often composed by a set of meanings about the clients' problems or problematic relationships and also

the relevant symptoms. Once the macro organizer of meanings for a specific client is identified, i-moments are depicted since they are everything that is different or innovative from the usual way person experiences, acts, reasons and feels (see Table 22.1).

The nature of i-moments is diverse, since it can be of different types, relating to their content and the processes involved. Consider, for instance, the problem presented above in the example and the following clinical illustration:

**Client:** Yesterday, I managed to get out for half an hour and go to the supermarket because I barely had food at home.

This is considered an i-moment, as it refers to a specific action that was not predicted by the macro organizer that demands her to stay home and not to defy the fear. So, in what concerns the type, this is an **action** i-moment. It was actually the first time that the client engaged herself in this active behavior in order to face her fears and isolation.

Another type of i-moment is **reflection**. This can be any moment in which the person thinks differently than what one could expect from the dominant macro organizer point of view, or when he or she understands something new that contradicts the former. The following example relates to a self instruction with the intention of defying the macro organizer demands. This example is subtype I—*creating distance from the problems*.

**Client:** I woke up this morning with this thought: I must do something, something outside the house, maybe go for a walk.

If the client enacts a reflection subtype II, some features have to be related with a perceived change, or new achievements. Stating the difference between a prior and a present self position could be a reflection *centered on change*.

**Client:** I have been realizing that I'm able now to think about situations and about what happened, how I reacted and how I should do different next time.

The following type, the **protest** i-moments can be either composed of an action (like action i-moments) or a thought (like reflection i-moments), but they add to these actions or thoughts an attitude of active defiance or non-compliance with the rules proposed by the macro organizer and its specifications. So, we can see, either explicitly or implicitly, two positions: one that supports the problematic narrative (a person, a community), and another that defies and contradicts the former (the client). The subtype I refers to a *criticizing the problem*, which entails confrontation in relation to the macro organizer of meanings and those persons that seem to support it. In the next example, client expresses a new attitude facing fear, also acknowledging that she have been “feeding” it.

**Client:** I will try to fight my fears! I can't stand living like this anymore!

A different version of protest is the *emergence of new positions* of assertiveness and also empowerment. These protests are characterized by self confidence utterances with a firm voice tone, and they are not exclusively directed to the problematic meanings.

**Client:** I am my own top priority now! I will move forward with my life!

**Table 22.1** I-moments: Types and subtypes. From the IMCS: version 7.2 (Gonçalves et al., 2009)

Types of i-moments	Subtypes	Examples
<p><b>Action (A) i-moment:</b> Actions or specific behaviours against the problem(s)</p>		<p>New coping behaviours facing anticipated or existent obstacles Effective resolution of unsolved problems Active exploration of solutions Restoring autonomy and self-control Searching for information about the problem</p>
<p><b>Reflection (R) i-moment:</b> Thinking processes that indicate the understanding of something new that makes the problem(s) illegitimate (e.g., thoughts, intentions, interrogations, doubts)</p>	(I) Creating distance from the problem(s)	<p>Comprehension – reconsidering problems’ causes and/or awareness of its effects New problem formulations Adaptive self instructions and thoughts Intention to fight problem(s)’ demands, references of self-worth and/or feelings of well-being</p>
	(II) Centered on the change	<p>Therapeutic Process – Reflecting about the therapeutic process Change Process – Considering the process and strategies implemented to overcome the problem New positions – emergence of new positions regarding problem’s prescriptions</p>
<p><b>Protest (P) i-moment:</b> Moments of attitudinal defiance, that involve some kind of confrontation (directed at others or facets of oneself); it could be planned or concretized behaviours, thoughts, or/and feelings</p>	(I) Criticizing the problem(s)	<p>Position of critique in relation to the problem(s) or/and the others who support it. The other could be an internalized other or facet of oneself</p>
	(II) Emergence of new positions	<p>Positions of assertiveness and empowerment Repositioning oneself towards the problem(s)</p>
<p><b>Re-conceptualization (RC) i-moment:</b> Process description, at a meta-cognitive level (the client not only manifests thoughts and behaviours out of the problem dominated story, but also understands the processes that are involved in it)</p>		<p>RC always involve two dimensions: A. Description of the shift between two positions (past and present) and B. The process underlying this transformation.</p>
<p><b>Performing change (PC) i-moments:</b> References to new aims, experiences, activities or projects, anticipated or in action, as consequence of change</p>		<p>Generalization into the future and other life dimensions of good outcomes Problematic experience as a resource to new situations Investment in new projects as a result of the process of change Investment in new relationships as a result of the process of change Performance of change: new skills Re-emergence of neglected or forgotten self-versions</p>



The next excerpt accounts for a more complex type of i-moment: **re-conceptualization**.

**Client:** I know I react to situations in a different way from before and that some time ago I couldn't even do this distinction or this kind of evaluation. Just to exemplify, some days ago I parked my car near a column. When I got there, there was a car in front and I thought I couldn't get mine out. But I took a deep breath, I calmed myself, and I managed to get it out without a single scratch. Not too long ago, I would wait for the other car to leave, regardless how long that would take. I know this is just a small example, but it is also the result of an everyday effort of practicing (driving in rush hours and in more than two road lanes, parking, etc.), and not letting my negative thoughts take advantage over my actions. If I hadn't done so, I could not have succeeded. I'd better be prepared than staying in the shadow of what I could have done. I believe that I have possibilities and positive answers to my fears.

Re-conceptualization i-moments involve two main components: the contrast between the past self (the prevailing macro organizer narrative at therapy beginning) and the present self, and the description of the processes that allowed self's transformation from the past to the present. In this case, now she reacts "*to situations in a different way from before*", contrasting with "*some time ago, I would wait for the other car to leave, as long as it took*". The "*everyday effort of practicing and not letting my negative thoughts to take advantage over my actions*" and the notion that it is "*better be prepared*" were part of the process that allowed change to occur. Thus, as in reflection i-moments, the client achieves new understandings, but he or she also describes the change process involved. These i-moments are characterized by the achievement of a meta-level position, as we can see in "*some time ago I couldn't do this distinction or this kind of evaluation*", from which the person can see the difference between the old plot and the new one and from where the new story can be developed.

**Performing change** (previously designed by new experiences) are the i-moments related to future projects, activities or experiences as they are described as being the performance of change. This expansion to the future was impossible before, given the constraints of the macro organizer narrative. It prevented the person to engage into future novel experiences, as the meanings stood stable. Performing change is also the consequence of the establishment of a new higher order meaning organization that enables a new range of actions and thoughts accordingly. In the next example, as she achieved self-confidence due to recent achievements, she thought that talking about the change process with a friend would benefit her. This means a new engagement in social activities, which she had not done in recent years.

**Client:** Now that I feel more confident, I feel that I have to improve my self-confidence. I think I need to talk about this with a friend. I have a friend that always helped me facing situations, she showed she trusted me, I think it's time for me to trust her also.

## **I-moments and Psychotherapeutic Outcome in Narrative Therapy**

The i-moments research findings (Matos et al., 2009) indicated that poor outcome cases from a narrative sample were characterized mainly through the emergence of action, reflection, and protest i-moments since the beginning of therapy and their maintenance throughout the process. In good outcome cases all types of i-moments were present (from action to performing change). However, they are characterized mainly by the emergence of re-conceptualization and performing change i-moments, after the middle phase of therapy. At the same time, the i-moments salience,<sup>1</sup> which is a measure of the percentage of time that client spent narrating the i-moment in each session, was found to be significantly higher in good outcome group, with an increasing profile. In poor outcome group salience was found to be rather stable throughout process phases.

Having these results in mind, we hypothesized about what kind of processes were involved in the elaboration of i-moments that prevented the network of i-moments to develop, as in good outcome cases, namely the increasing of the salience and the emergence of re-conceptualization and performing change (Gonçalves et al., 2009).

We hypothesized that, in poor outcome cases, the narrative macro organizer and i-moments were two opposite meanings, with a feedback loop relation, as they end up feeding into each other in a cyclical movement. Given that circular dynamic loop, stability was maintained along the time and thus represented a failure to change or to develop new meaning complexes. The recurrent emergence of i-moments seemed to create narrative diversity within the self, although no further development was achieved. We believe that i-moments emergence throughout the poor outcome process occurred in a context of dynamism, where innovation was allowed to emerge in contrast to the macro organizer, but nevertheless without further development into different i-moments. As “a central need for dialogical self is to maintain dynamic stability within self” (Valsiner, 2002, p. 258), clients seemed to be engaged in a cyclical movement between a voice and a counter-voice that lead to an irresolvable dilemma and made change difficult to achieve. This process is described as mutual in-feeding, meaning that different meaning complexes establish relations between themselves that tend to “feed into each other” throughout time (Valsiner, 2002, p. 258).

A process of development would involve the emergence of novelty with a continuous, an irreversible and a future-oriented way (Valsiner, 1991), as different parts of the self can relate to each other in order to the emergence of new relations and also new meanings. This seemed to happen in good outcome cases, as clients seemed to have found a way to engage in i-moments development through the emergence of differentiated meanings.

---

<sup>1</sup> Salience is computed from the time the client spent narrating an i-moments in seconds divided by the total time of the session, in seconds.

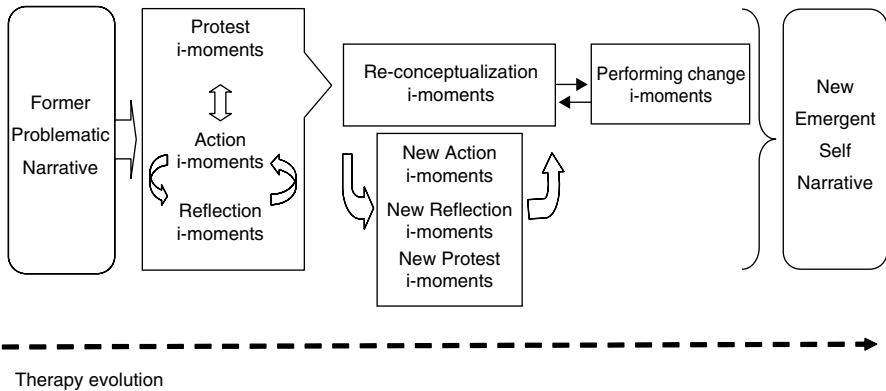

**Fig. 22.1** Model for therapeutic change (adapted from Gonçalves et al., 2009)

There is a sequential order in psychotherapy, in terms of i-moments development. In the early stages action and reflection are the most narrated i-moments, as narrative details that accounted for the first signs of the ongoing change process. Then, protest i-moments begin to emerge and they become more often narrated as process evolved to middle sessions. At a middle stage, re-conceptualization emerged and increased its salience, leading finally to performing change. As these two i-moments were narrated and expanded (clients spent more time talking about them), the other i-moments types declined in their salience, although they are still present in the final stages (see Fig. 22.1).

### ***Dialectical Approach to i-moments***

According to Valsiner (2005), meanings are synonymous of signs, the semiotic devices that people use in order to give sense to their experience. They correspond to present effort to, grounded on previous past knowledge, anticipate or move towards a future meaning or toward self development. All the range of this possible future conditions is guided by semiotic mediators that seem to occur in parallel at different levels of abstraction, from highly generalized fields (like values or beliefs) to verbally accessible mediators (self's narratives emerging in therapeutic conversation). At this point, we will focus on this lower level of self narratives in psychotherapy, highlighting a microgenetic perspective of i-moments emergence.

### ***The Emergence of i-moments***

We have described essentially two possible and contrary meaning complexes in self's narratives—the macro organizer of problematic meanings and i-moments as

alternative meanings. We have also argued that the macro organizer of problematic meanings seem to be in a high level and i-moments at a lower level of meaning organization, at least when the therapy starts. The emergence of i-moments has, at the same time, the potential to change the macro organizer of problematic meanings. Josephs and colleagues (1999) proposed a method to study the meaning making processes at a microgenetic<sup>2</sup> level, with the aim to explain, “not to understand” (Josephs et al., 1999, p. 279), them further.

According to Josephs and Valsiner (1998), meaning is transformed through dialogical relations between meaning complexes. Meaning complexes are composed “of signs (meanings per se) that present some aspects of the world, their implied opposites, and their qualifiers” (Josephs & Valsiner, 1998, p. 70). By these signs, people act upon meanings in a given present context but also oriented to the future, by means of “meanacting (acting toward creating meaning)” (Josephs et al., 1999, p. 258). The person transforms the present meaning complexes into futures ones in an autodialogical process of negotiation of the tension or disequilibrium created between them.

Meaning complexes are composed of dual fields, the field {A} and {non A}. These dual fields emerge together (explicitly or implicitly), being {A} the sign and {non A} the countersign of {A}, as in {A} the foreground and {non A} the background. Being “I feel fear” the field {A}, it is associated also with a whole range of its opposites, defined by the field {non A}, composing both the meaning complex {fear and non-fear}. We can only understand the feeling of fear taking all possible opposites feelings into account.

The field {A} is composed of a sign or signs with a specific meaning, to which we can relate synonyms and various versions by using semantic qualifiers (cf. Josephs & Valsiner, 1998). Qualifiers usually modify the meaning of the field, either opening it to transformation or closing it. So, the meaning of the field {A} could be open up for transformation by the use of qualifiers, that are signs that limit or modify the meaning of the field, such as *sometimes* or *all the time*. For instance, “*Sometimes* I feel fear of going out” is different from “I feel fear of going out *all the time*”. The latter could be conceived as a macro organizer of the meaning system, since it entails a sense of totality of the person life and actually closes the meaning complex to transformation.

The {non A} field emerges together with the previous {A} and includes its opposites, although in an unstructured or fuzzy way. It is contrasted with field {A} that is clearly defined. So, non fear can include fearless, intrepid, brave, unafraid, courageous, or even calm, cool or relaxing. This {non A} field has also the potential of involving a “yet-to-be differentiated field of meanings-to-be” (Josephs et al., 1999, p. 265), as it links the present meaning with a future one. So, {A} and {non A}, that can be thought as *as-is* and *as-if-could-be*, are related to each other by an opposition

<sup>2</sup> Microgenetic analysis is a method to study how change develops in a certain period of time by a given individual. It involves intensive analysis of the transformation mechanisms and it has been widely applied in children developmental studies (cf. Flynn, Pine, & Lewis, 2007; Siegler & Crowley, 1991).

that “is the basis for its change” (Josephs et al., 1999, p. 261), which can be either harmonious or tensional. When both opposites co-occur with no tension at all, they tend to close the meaning complex. On the contrary, if tension occurs it enables the complex to transform, as it allows the establishment of dialogical relations with other meaning complexes.

Meaning transformation can occur through a process of growth of the {A} field. It can become progressive differentiated into {A'}, {A''} or {A'''}. In these transformations, the similarity with the {A} field is maintained. In this sense, the {A—“*Sometimes* I feel fear of going out”} field can grow into an opposition like {A'—“*I only* feel fear *when* I need to go to the supermarket”}. It can also integrate the previous one and grow into {A''—“*I feel fear every time* I need to go out”}, or even perform a *takeover* of previous fields by {A'''—“*I feel fear all the time*”}. The qualifiers *sometimes*, *only*, *every time*, and *all the time* modify the meaning of the field {A} opening it to possible transformations. For instance, *only* and *when* open the complex to the {non A} field, a still unstructured one, that can assume a various range of meaning. On the other hand, *every time* and *all the time* protect the meaning to evolve, stabilizing it and assuring its determinacy.

On the other hand, the constructive elaboration of the field {non A} develops towards a separation of {A} by changing its nature, constituting an innovation from it. So, to change one meaning complex {A—“*I feel fear of going out*”}, there has to be tension between the fields (like, for instance, in the previous example “*Sometimes* I feel fear of going out”), and the field {non A} needs to be somehow elaborated so that another meaning complex emerges and substitutes the first one. For instance, the field {B} could be “*But yesterday* I managed to go out”. We also assume that the field {B}, once formed, has a dialectical relation with a field {non B}, which could entail features of the field {A}. Meaning making entails the regulation of dialogical relations between meaning complexes, {A} and {B}. They can have dialogical relations of two different natures: harmonious or tensional. In harmonious coexistence, A and B can coexist without rivalry: “*I feel fear of going out* [{A}] *but when* I go out *its ok* [{B}]”. The coexistence is clear when {A} is a determined statement and {B} does not imply any sort of tension. When tension is present some kind of resolution is needed. For instance, “*I sometimes feel fear of going out* [{A}] *but yesterday* I managed to go out, *and it was ok* [{B}]”. The use of the qualifier *sometimes* can open up the meaning to transformation, since that statement is valid for a specific moment, and then a new meaning is elaborated by the action of “*going out yesterday*”. We can assume that {B—going out} took over {A—fear} as “*it was ok*” was applied to ensure that fear did not interfere. However, a meaning complex can protect itself from a takeover. In this sense, {A} can change into {A'} (feelings of *caution* or *alert* instead of *fear*).

Summing up, we can consider the field {A} the meaning complex that expresses the macro organizer<sup>3</sup> and {non A} as the whole range of oppositions related to the

<sup>3</sup> For clarification purposes we adopt the meaning complex {A<>non A} to refer to the macro organizer of problematic meanings in every following examples in this work. We consider that

problem as {non problem}. In therapeutic conversation, if the client chooses to elaborate on the field {non A}, either by his or her intention or by therapist suggestion, it is most likely to conduct to the development of a novelty, or to an i-moment, as some version of {non A}. The elaboration of the field {non A} can lead to another meaning field {B}, originating the meaning complex {B< >non B}.

According to i-moments coding procedures, when facing materials (e.g., therapeutic sessions) coders must firstly agree upon the macro organizer of meaning that entails a problem or problematic situation, in which client is involved in. We can assume that this is akin to the field {A< >non A}. Then, they must be aware to every meaning that is different or novel from the meaning of {A< >non A}. In other words, it is this difference at the meaning level that allows coders to mark a given excerpt as an i-moment. It is to say that we need to compare each segment of conversation with the problem and decide whether it belongs to the {A} or whether it is something different, a {B} meaning complex. In this sense, i-moments are a counter-meaning of the problem.

Meanings develop or are maintained through the establishment of dialogical relations between meaning complexes. These relations enable them to put together a hierarchy of meanings. A macro-organizer is then a higher level meaning, and its relation to other meanings can be of integration or even takeover. However, its meaning can be defied by other meaning complexes, and other kinds of relations can be established. The insertion of i-moments, for instance, is an example of the emergence of low level meaning complexes. Their meaning can be simply bypassed by the macro organizer, and the novelty will decay.

The meaning of an i-moment can nonetheless establish some sort of relation with the macro-organizer enabling its transformation. Circumvention strategies regulate the relations between meanings complexes (Josephs & Valsiner, 1998; Josephs et al., 1999). They are semiotic tools used by people instantly in the task of organizing the flow of everyday experience. They can strengthen a given meaning or overcome it, making new meanings. Their role is to give meanings a marginal or central importance, originating their maintenance or change. They lie on the goals and preferences of the person, so they act upon in an idiosyncratic context.

Circumvention strategies can lead to a wide range of possible outcomes, such as promotion or restrain of meaning construction. They are semiotic regulators that allow focusing on higher level meanings attending to the person's preferences, choices, and emphasis. The regulation processes between meaning complexes can result, as we said before, in a takeover, that means an overcoming of meaning, but complexes can also have a harmonious or rival coexistence.

Circumvention strategies of meaning can act by focusing on or emphasizing specific features of the meaning complexes. So, focusing on a competing goal can mean that the client bypasses the meaning as she highlights a motivational goal that rivals with the previous meaning; e.g., "I will face fear, because *I have to* find a job, which means that *I have to* go out and *I have to* talk with other people!" Circumventing a meaning via highlighting personal preferences can happen when the

---

clients can bring more than one problem, so more than one macro organizer. However, this analysis should be undertaken in intensive case analyses, which is not the purpose of this paper.

client makes a stand as he or she will do what he or she likes (“I like”) and what he or she wants (“I want, I need, I must”) in that particular situation or even for his or her life.<sup>4</sup> Another form can be the circumvention of meaning through the introduction of symbolic helpers (the client uses symbolic statements, that are somehow decontextualized, in order to distance herself from the previous new meaning; e.g., “it’s God’s will”). Another circumvention strategy that seems to appear often, and in parallel with the previous ones, is by means of focusing on semantic qualifiers. So, expressions that somehow emphasize an absolutist and determinist fashion in i-moments, such as “I will *no longer* accept this” can be used, but other that seem to promote some instability in meaning can also be used, like “*Sometimes* I feel fear”, which can open to meaning to further elaboration.

## Therapeutic Failure and Dynamic Stability of Meaning-Making

Stability and therapeutic failure were analyzed by means of the relations between the macro organizer meaning ( $\{A < > \text{non } A\}$ ) and the i-moments ( $\{B < > \text{non } B\}$ ). These relations seemed to be regulated by the circumvention strategies that acted upon i-moments, bypassing their meaning and making the innovation movement decay. We will now illustrate our assumptions with examples from a previous case study (Santos, Gonçalves, & Matos, 2009) of a woman victim of intimate violence. This case had a poor therapeutic outcome and we will analyze it through the lens of dialectical meaning transformation.

Maria had been married for 20 years and her husband, David, had been sexually and psychologically violent toward her since the first year of marriage. When she came to psychotherapy she had severe symptoms of depression (e.g., sadness, hopelessness, social withdraw, isolation) that were externalized and labeled as “the wave”.<sup>5</sup> The next illustration shows how Maria was willing to change, despite the presence of the “wave voice”.

### *First session*

**Therapist:** That position has a voice that states: “You have to convince yourself that you are not worth a thing, you have no value at all, there is no use to fight, it’s no use to start doing new things... don’t go that way because you won’t have any results”. Is it this kind of voice?

**Client:** Yes, partly it is. It’s thinking that “it’s no use going that way because you won’t have any results”.

<sup>4</sup> These two types of circumvention strategies are difficult to distinguish, so we will apply them as being the same strategy by focusing on stronger goals and personal preferences in the following examples.

<sup>5</sup> Externalization of the problem is a narrative practice that invites clients to analyze the problem as an external “entity” (White & Epston, 1990; White, 2007). In the case of victims of partner violence, the externalized problem is, for instance, fear, sadness, or personal characteristics that support the violence, but not the abuse.

- Therapist:** You said that “partly” there’s a voice that says there’s no use making any effort because you would never get anywhere. [Problem {A}] But is there another voice? [Elaboration on {non A}]
- Client:** Yes, there’s another part that seems that I can do everything! [Reflection i-moment {B}] But suddenly, it falls down! Like a cards’ castle that we build and then suddenly falls apart! [Return to the problem {A}]

The voice “*you would never get anywhere*” was brought by Maria as belonging to the macro organizer of problematic meaning. The employment of the words “*never*” and “*anywhere*” shows how definite and determinist this organizer had been in Maria’s life. She also said that this was “partly” true, leading the therapist to question the presence of another voice. So, in terms of dialectical meaning complexes, being {A} the macro organizer, therapist questioned directly to the elaboration of the field {non A} through “*But is there another voice?*”. The client answered with an i-moment that expresses “*seems that I can do everything*” as the result of the elaboration of the field {non A}. Therefore, Maria stated the existence of these oppositional voices (meaning complexes), but after narrating the i-moment, the word “*but*” indicated the re-emergence of the previous and opposite voice by saying “*But suddenly, it falls down! Like a cards’ castle that we build and then suddenly falls apart!*”. By doing so, she prevented the meaning complexes to create tension by circumventing the meaning expressed in the i-moment. She used a symbolic helper, a “*cards’ castle*”, in order to express that i-moments’ meaning was not structured enough and it could be easily destroyed (also noted by the word “*seem*”), then creating a distance from it and reinforcing the voice “*you would never get anywhere*”. Attempts to create exceptions are possible, as in the question from the therapist, but they can be easily understood as attacks to the macro organizer’s meaning, leading to a circular movement that strength its rigidity. The i-moment (“*seems that I can do everything*”) was immediately bypassed. In this sense, Maria actually returned to and strengthened the meaning of the problem voice, despite the emergence of the i-moment (see Fig. 22.2).

As we detected in the previous analysis, the i-moment—{B} field—emerged from the development of {non A}. Then, immediately after, a circumvention strategy was applied to bypass the i-moment and promote the movement back to the {A} field, the macro organizer. I-moments seemed to emerge from the constructive elaboration of the {non A} field. Then {B} emerged as a new meaning complex. Being {non B} everything that was opposite to {B}, it entailed something about previous {A} field. So, circumvention strategies seemed to act upon this {non B} and bypassed the meaning of {B}, promoting a returning to {A} field, the problem. As i-moments emerged, they were constructed in ways that lead to the use of circumvention strategies that bypassed their meaning and facilitate the return to the problem. Thus, a recurrent feedback loop happened between the problem and i-moments (see Fig. 22.2).

In another example, relating to protest i-moment, Maria said she wanted to end with the “wave” completely.



**Fig. 22.2** Mutual in-feeding:  
A dialectical perspective  
over meaning maintenance.  
After Josephs et al. (1999)

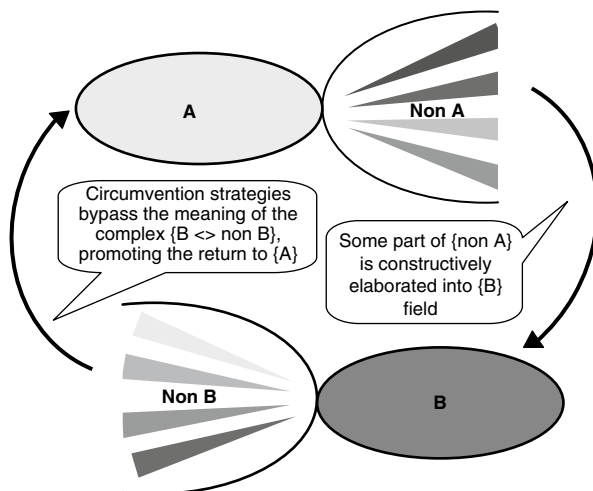

#### *Fourth session*

**Therapist:** What do you want to do to this “wave” (externalized label for depressive symptoms)? Today you’ve defied it ... [Elaboration on {non A}]

**Client:** End with it completely, [Protest i-moment {B}] but it seems very difficult to me... [Return to the problem {A}]

**Therapist:** End with it...! You’re ambitious!

As the therapist identified an exceptional moment of defiance, highlighting the {non A} field of the {A<> non A} complex, Maria enacted a protest i-moment. Instead of a change in her relation to the problem, Maria stated the wish of eliminating the problem ({B}). This magical or non realistic aim stated in absolute terms like “*completely*”, was immediately counterpointed with the difficulty of this task and its meaning was circumvented by a self oriented competing goal (the difficulty of the task), allowing the problematic voice to take over the i-moment once again. This protest i-moment was pretty much centered on defying the problem, but no strategies or further elaboration were narrated in order to change this relation. It made the gap between her wish and her perceived competence on that moment so high that she returned to the problem voice as the task seemed overwhelming for her.

In the analyzed excerpts, the meanings expressed by i-moments were frequently followed and consequently restrained by the problem voice that made the return to the meanings ruled by the macro organizer possible. It seemed that i-moments were systematically trivialized, neglected or simply taken over by the immediate emergence of the problem voice. So, dialogical relations of opposition and rivalry between the macro organizer and the i-moment were “solved” by an immediate return to the problem. In this sense, i-moments did not evolve to the construction of other possible voices, but they seemed to work as shadow voices of the problem, allowing its perpetuation and closing the meanings system. This restricted a further elaboration and new meaning complexes did not emerge (see Fig. 22.3), as they were absorbed into the vicious cycle. This process ended up strengthening the problem voice and maintaining its dominance, not only because it was still present, but because it prevented other possible voices from developing.

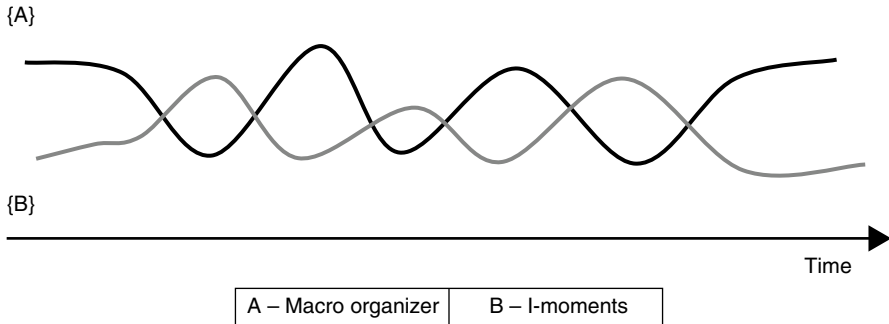

Fig. 22.3 Mutual in-feeding along therapeutic process. Adapted from Gonçalves and colleagues (in press)

In mutual in-feeding the field {non B} is somehow prompt to return to {A}, because it entails features of that same field. So, circumvention strategies are easily used to perform the task of bypass the i-moments meaning ({B}). Mutual in-feeding seemed to be also related to the content of the i-moments. So, the overall reported i-moments were mainly related to the aggressor and the experience of abuse. The prevalence of protest i-moments of subtype I—problem oriented—showed a performance of innovations inside the intimate sphere. They have no audience, meaning that others cannot validate that change was occurring. Reflection i-moments were also related mainly to the distancing from the problem (subtype I), like the questioning about abuse and victim condition, wishes that she would be capable of changing and also magical wishes of problem elimination. We do not mean that these subtypes of i-moments are not important or useful at some point of the therapeutic process. It means that these exceptions, since they are always related to the macro organizer, somehow maintain the presence of the problem, by innovating simple by contradicting the problem (cf. Gonçalves et al., 2009).

In this sense, the {B} field seemed to be able to grow into {B'}, {B''}, {B'''} as different i-moments, but always of the same subtype or content. Taking reflection as an example, different forms of expressing the need for change can be used, always related to the first main idea. The i-moment “*then I thought I have to free myself from this fear; I need to change*” can suffer a growth process into other forms, that are still related to {B}, such as “*there are moments when I think I will say to the therapist: let’s go forward, it doesn’t matter; let’s not think of anything else, and don’t look back*”, or even “*I always have that in my mind: I’ll free myself and I’m going away from here.*”

Another path that could explain the stability of meaning is when {A} and {B} suffer a growth process into mutual escalating (Valsiner, 2002). Instead of feeding each other, entailing dialogical relations between them, both A and B grow into over generalizing each meanings, entering in a cross-fire situation but maintaining the relation stable. An example of escalating could be “*I think I need to change*”, that develops into “*I really want to change*”, and later into “*I will definitely change*”. However, this is not a form of development either, since the escalating keeps the meaning complexes apart, with no dialogical relations between them, ending up in a monological outcome. This process of growing of the meaning complexes does not allow development, because it also maintains the meaning stability (Valsiner, 2002).

So, i-moments of action, reflection and protest may act as a mere opposition to the problem narrative, not allowing the development of new meanings outside the semiotic duality problematic narrative—negation of the problematic narrative (see also Gonçalves et al., 2009). What seemed to be clear with the dialectical approach is that the problem is present even when it is absent, since the meaning of the i-moments seem to require a definition by opposition of the problem. The consequent emergence of {non B}, and it's containing features of {A} field, brings the possibility of a return to the problem at anytime.

## **From Dynamism to Development**

After explaining how the process of stability of i-moments seemed to be established and maintained in poor therapeutic outcome, we will present some possible explanations for the development of i-moments in good therapeutic outcome processes. It is important to notice that these are theoretical elaborations grounded on clinical vignettes of narrative clinical cases and they correspond to an effort of developing this method in order to explain the innovation emergence.

A study of mutual in-feeding through the identification of return to the problem markers (Gonçalves et al., [in press](#)) showed that mutual in-feeding is a rare situation in good outcome cases, and that only happens in early sessions. Moreover, in these cases this process only occurs in action, reflection and protest i-moments. Findings showed that the resolution of mutual in-feeding seemed to occur in initial phases and parallel with the emergence of re-conceptualization in middle stages. On the other hand, in these cases most of the i-moments narrated in the beginning of the process are free from mutual in-feeding, enabling a development to other types and to an increasing salience, since they are not “trapped” in a circular feedback movement. For development to occur it seems necessary that clients are able not only to narrate i-moments, but also to avoid the mutual in-feeding situation, or to be able to find a way out of it when it happens.

These findings made us curious about the possible dialectical processes that allowed emergence of development. We are now trying to give a glimpse of these possible processes, as no research was intensively carried out with this method in good outcome therapy. We start by giving some clues about the resolution processes of mutual in-feeding. Then we will see how i-moments can develop in a progressive and a differentiated way, constructing the network of exceptions that will give place to a new rule, or narrative. Re-conceptualization, the most complex i-moment, will be analyzed according to the dialectical perspective over meaning transformation.

## ***Resolving Mutual In-Feeding Processes Through Takeover***

One of the first processes that seem evident to occur in good outcome cases in therapy is the progressive development of i-moments. So, from the macro organ-

izer, first exceptions are identified, which lead to their elaboration and from here to new i-moments emergence. We saw before that an i-moment, {B}, occurred from the constructive elaboration on {non A}. The following excerpt is from a victim of intimate violence, Susan, who narrated fear as the most dominant problem in her life.

*Third session*

**Client:** (...) I'm becoming aggressive, I started to... most of the times he beat me [Problem {A}] I tried not to answer, to be quiet [Action i-moment {B}]. But there were situations when, mostly with verbal violence, that... it happened today, I lost my head and I said awful things to him, some of them I remember, others I don't [Return to the problem {A}]. And that...

**Therapist:** It seems to cause you distress. [Stresses the negative feelings associated with the problem {A}]

**Client:** Yes, a lot. That made me turn around and start thinking "no, I can't go on like this because someday I'll be just like him, and I don't want that!" [Reflection i-moment {C}].

In the previous illustration we found that Susan mostly did not react to the violence upon her, as an action of self-protection. Then, she immediately stated that sometimes she reacted to verbal provocations being verbally aggressive towards him, which was considered a return to the problem. The aggressive behavior not only could lead to a violence escalate toward higher severity, but it also does not solve the situation, rather maintains it. The therapist highlighted the negative emotional state associated with the return to the problem ({A}), creating a state of clear tension between opposites. The client then elaborated on {non A—all possible non distressful situations} and narrated a new i-moment, stating a turning point and a self instruction. Return to the problem was circumvented by focusing on self preferences "I don't want it" with some powerful signs of self determination "I can't go on like this", creating a higher order organizer. {A} meaning seemed to be destroyed by a takeover, and thus restrained the possibility of returning to the problem (see Fig. 22.4).

To summarize, circumvention strategies seem to play a significant role not only in meaning maintenance, but also in the creation of higher level signs, or new i-moments meanings. New qualifiers can also be used in order to do it, such some

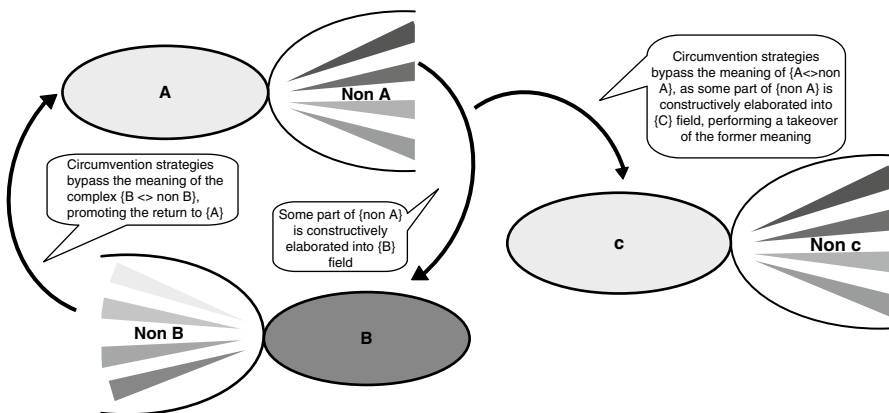

Fig. 22.4 Resolving mutual in-feeding

deterministic expressions, like *must* and *ought to*, for instance, which would compete with the ones used in the macro organizer. The possibility of returning to the problem is, in this sense, reduced, because fields {B}, {C}, or {D} no longer use qualifiers that imply ambiguity (*I think, sometimes*), but of determinacy.

### ***Resolving Mutual In-Feeding Processes by Focusing on Social Validation***

Resolving mutual in-feeding can also be enacted by therapist focus on social validation of changes. Joan, a victim of partner violence, living with her husband and two children, reported that her major difficulty was to “control” herself, meaning that she was not able to cope with the effects of the violent relation and had episodes of impulsiveness (with co-workers and her children, being often unfair to them), and also symptoms of depression and anxiety. This was a poor outcome case of the therapy (the excerpt is from a session from the final therapeutic phase):

#### *Tenth session*

**Therapist:** What are those abilities?

**Client:** Self-control. I never thought I could control myself! [Reflection i-moment {B}] but I don't know if it is enough... [Return to the problem {A}] (...)

**Therapist:** In a scale from 1 to 10, you are at point 8. In what are you different from before?

**Client:** I'm more confident of myself, and have self-control.

**Therapist:** And other abilities, as a woman?

**Client:** Self-control. And ready to help others.

**Therapist:** As a wife?

**Client:** Self-control, when I'm with him and with my children...

**Therapist:** As a mother?

**Client:** Less boring, for instance.

**Therapist:** As a professional?

**Client:** I have self-confidence, [Reflection i-moment {B}] but that's somehow complicated... [Return to the problem {A}]

In the previous excerpt the reflection i-moment that client elicited is a new meaning complex ({B—self control}), that was being amplified by the therapist questioning. An interesting feature is that client repeats the content of the i-moment as an answer to almost all the questions and does not elaborate on the new abilities, as she kept positioning herself in the macro organizer. The recurrence of the return to the problem seemed to prevent the elaboration of this ability, although the therapist's questioning around the generalization of this i-moment to other personal roles (from woman to wife, mother, and professional). The same example continues as follows:

**Therapist:** And to the society, how do others look at you at this moment, contrasting with before?

**Client:** Everyone sees me as a strong woman. Because sometimes they say: “If it were me, I wouldn't be able to handle it...”

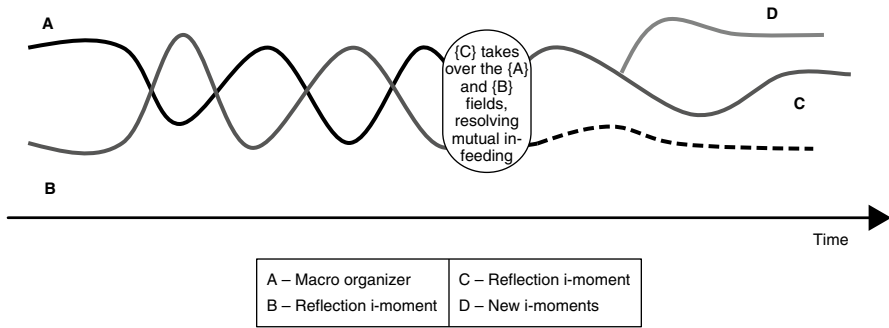

**Fig. 22.5** Resolving mutual in-feeding through a takeover process

**Therapist:** So they value you?  
**Client:** Yes.  
**Therapist:** “Strong”, how? Like resistant?  
**Client:** Yes, resistant. (...)  
**Therapist:** They value you for...?  
**Client:** For moving forward and accomplish...  
**Therapist:** What?  
**Client:** For being here, talking with you, to be able to face the situation, to talk about it, for instance.  
**Therapist:** And to able to perform some changes in your life, too?  
**Client:** Yes. For trying to get it right. [Reflection i-moment {C}]

It seemed that when questioning stops focusing on herself and is directed to the others position over her accomplishments (elaboration on {non A}), contrasting with the former macro organizer (“*at this moment, contrasting with before?*”), Joan seemed to be able to not just amplify the features of the previous i-moment, but to identify a set of new self features ({C}), that are not limited to control vs. non control. Bringing to therapy the dialogical interactions with others, besides the therapist, seemed an important step in the resolution of mutual in-feeding in this situation. Therapist seemed to introduce a catalytic resource in order to promote novelty. The emergence of {C} made a takeover of the macro organizer of meaning, surpassing the mutual in-feeding process, opening the opportunity to the emergence of new self meanings, like {D}, that are not, in their nature, close to the {A} meaning (see Fig. 22.5).

### The Emergence of i-moments and the Development of a New Self-Narrative

I-moments can develop in a continuous way, without any struggle between innovation and the macro organizer. This way is actually the one that promotes—from early sessions of therapy onwards—a clear distance from the macro organizer

**Fig. 22.6** Development of i-moments

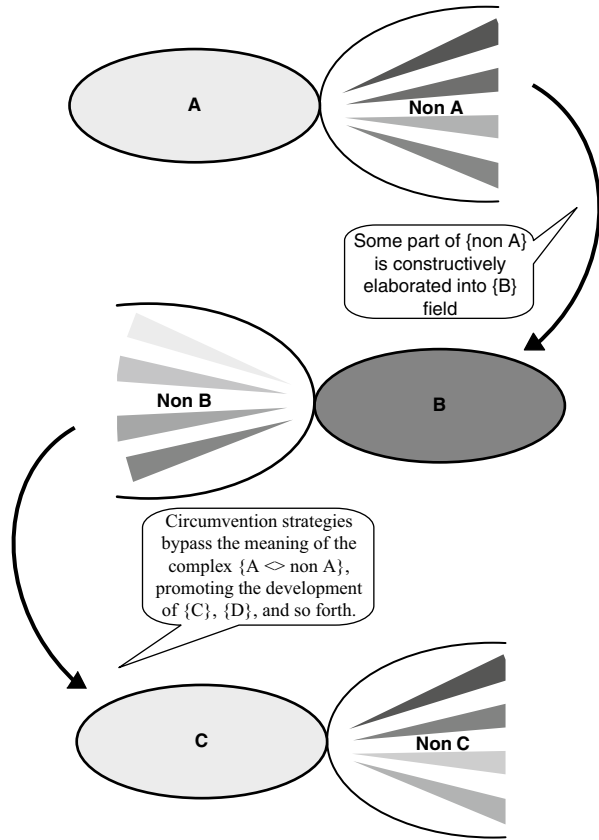

meanings. In other words, the constructive elaboration of the {non A} field can lead to new meanings {B}, {C}, {D}, and so on. This progressive construction will differentiate the new meanings from the macro organizer ( $\{A < > \text{non A}\}$ ) (see Fig. 22.6). In this section we illustrate several forms of i-moments development: (1) through constructive elaboration; (2) by content development; and (3) by means of circumvention strategies of meaning.

### ***Development of i-moments Through Constructive Elaboration***

In the following illustration Susan was narrating an episode of violence. At some point, she needed to get out of home, in order to protect herself and her daughter. Due to this situation, she engaged in thoughts about possible solutions, such as getting separated. This action i-moment lead to the emergence of the meaning “*I have to get separated, I have to do something*”.

*First session*

**Therapist:** So, you left home... [Elaboration on {non A}]

**Client:** I went out with my daughter on a bike and I ended up in a medical centre, I phoned... phoned... some friends [Action i-moment {B}] because I started thinking “I have to get separated, I have to do something”. [Reflection i-moment {C}]

As we can see, the {non A} leads to the development of novelty as the need for actions of self-protection ({B}). The implicit emergence of {non B}, as not taking actions to self protection, is immediately perceived as a self damage situation, leading to the emergence of a novel understanding, implied on {C}, as possible ways of resolving the violence situation. Note the use of “*I have to*” to emphasize a personal need and also to take over the {A<>non A} meaning. Both i-moments are related to subtypes I, congruent with therapy beginning.

### ***I-moments Content Development***

Another possible form of i-moments development is when the subtypes of action, reflection, or protest i-moments evolve into new meanings inside the same i-moment, but from subtypes I to subtypes II. Thus, reflection i-moments may evolve from subtype *creation of distance from the problem* to subtype *centered on change*; and protest from *criticizing the problem* to the *emergence of new positions*. In fact, the meaning of the i-moments of subtype I seem to be important, as they are the exceptions closer to the macro organizer, and thus they act in the “zone of proximal development” (Leiman & Stiles, 2001) of the macro organizer, defying it at the same time. As the change model presented before suggested, they are proofs that change is being accomplished, and they are the basis for further i-moments identification and amplification in therapeutic conversation. Assuming that the first subtypes are closer to the problem, and then more prompt to return to the problem, the path to their maintenance (and not deflection) could be by circumventing the problem by the use of strategies that highlight personal preferences and intentions, and therefore promote the development of new meanings that are no longer mere oppositions to the problem, leading to i-moments type II.

#### *Second session*

**Therapist:** You were telling me that you want to do some changes in your life, qualitative changes... [Elaboration on {non A}]

**Client:** I do. I do want to change. I've been realizing that I've been silencing and annihilating myself [Reflection i-moment subtype I {B}]... I used to read, to have friends with whom I talked a lot. Since I married things began to change...

**Therapist:** (...) There has been some kind of disinvestment in yourself...

**Client:** Yes, completely. But now... some time ago I started to look for myself, to take care of myself. [reflection i-moment subtype II {C}]

The previous example refers to two i-moments, of the same type, however with different subtypes. The therapist question is related to the elaboration of {non A} field, about the changes client wants to achieve in the therapeutic process. Client enacts a reflection i-moment of subtype I. This {B} field refers to the acknowledgment that she wanted to change, due to a progressive understanding that she



has been “*silencing and annihilating*” herself since her marriage began. The macro organizer was circumvented by a personal goal “*I do want to change*”. Note also the inexistence of fuzzy qualifiers in this field, making the meaning clear and determined. The therapist actually summarizes this understanding by adding the sense of disinvestment, focusing on the {non B—not wanting to change} field. As this field is very close to the macro organizer, the contrast seemed to be highlighted and tension was created. Then client said “*Yes, completely.*” This statement seemed to enact and make clear to her that she had been not investing in herself, as a past condition, from where she enacted a reflection i-moment of subtype II (“*But now...*”), as she stated an actual change of starting to take care of herself.<sup>6</sup> We can see here a development from a reflection i-moment of distancing from the problem ({B}) to one centered on change ({C}), by focusing on personal goals.

This last process could be involved in the i-moments development into more salient (more time narrated in session) and differentiated (more types and subtypes emerge). The circumvention strategies seemed to facilitate not only the emergence of these new meanings but their maintenance and ability to create other meanings.

### ***Development of i-moments by Means of Circumvention Strategies of Meaning***

As we argued before, the more distant one sets from the problem meaning complex, the easier it is to avoid the return to the old macro organizer. In fact, i-moments seem to suffer an escalate in good outcome cases. This can be promoted by the use of circumvention strategies that enhance the positive meaning of an i-moment, highlighting, for instance, the personal goals of the client. So, these meaning mediators seem to promote the development of i-moments, since they are elaborated in a way that makes unlikely the return to the macro organizer and, therefore, promote the emergence of other i-moments.

In the next excerpt, Susan narrates an episode with her husband, when she had an assertive attitude.

#### *Third session*

**Therapist:** I was suggesting that you spend the least time possible with him at this stage... being separated ... try to spend the least time possible with him, not be with him in the same space during the day...[Elaboration on {non A}]

**Client:** Last week it was ok. But then he kept saying “give me one more chance” [Problem {A}]. And there was a time when I said “I gave four years of chances, I don’t have any more to give you”. “I know you don’t believe me, but”, “I’m sorry, I don’t believe you nor do I trust you, and you had four years to...well, I gave you four years of chances, I don’t have any more to give you”. [Protest i-moment {B}]

<sup>6</sup> This i-moment could easily be coded as an action i-moment. From our point of view, the client did not relate any specific action and, given the context of the session, to “take care” of her meant to firstly have some space and time to think about the situation.

The repetition of “*I don’t have any more (chances) to give you*” is a strategy to focus on a personal goal and reinforces the meaning of her assertiveness in this protest i-moment. In this example the i-moment is still very close to the macro organizer meaning {A—giving one more chance}, but the use of the repetition and the negative “I don’t” focused the meaning in her present goals {B—not giving more chances}, taking over the macro organizer ({A}), and opening the meaning system to development.

In the subsequent example Susan made a clear distinction between features that characterized her life dominated by fear ({A}) and her new position of not letting fear to be dominant again ({B}). “*I will not let it interfere*” shows a personal intentionality, with the strengthening of this position with the contrast with the past “*it interfered so many times, and for so long*” that emphasizes the clear gap between the past and present, strengthening the present position as “*that it’s enough now...*”.

*Fifth session*

- Therapist:** So, you are trying to have control over fear. But you’d like to have more control over the fear of your husband harming your child and harming you physically. However, fear tries to interfere [Problem {A}] but it can’t... [Elaboration on {non A}]
- Client:** No. I will not let it interfere. It is a question of stubbornness now... it interfered so many times and for so long, that it’s enough now... I have to put a stop to it, don’t I? [Protest i-moment {B}]

The development of i-moments has a lot to do with therapist intervention. It is not our aim to fully explore the range of therapist interventions and techniques in this work, but to draw attention to some important features of therapist’s action from a dialogical point of view. So, in this sense, therapist intervention can play an important role by separating i-moments from the past macro organizer emphasizing the existing gap between them. Consequently, this contrast creates tension between both meaning complexes and can promote the move towards i-moments elaboration. This movement is obviously idiographic, in the sense that it is congruent with the client’s goals and preferences, and also promoted by her or his engagement with the alternative exceptions and refusal of following the past rules (macro organizer). In the following illustration Sophia was narrating the history of violence and the reasons that lead her to therapy. She had been separated from her partner several times before (macro organizer) and she is again separated from him, after being victim of a car accident provoked by him when she was pregnant.

*First session*

- Therapist:** What is the meaning of this situation for you? You have separated from him before, what is different this time? [Elaboration on {non A}]
- Client:** It’s very different. Because I value me and my son’s life, that is also his and he couldn’t give that value. That’s the most important for me, because a son is above us. My other daughter is also above everything and everyone. [Reflection i-moment {B}]
- Therapist:** You made this decision because you put yourself first and you are thinking about the future... [Elaboration on {B}]
- Client:** And I want the best for my children. He couldn’t value his son or his wife, that’s what really gets me. It’s very different now. [Reflection i-moment {B}]

In this previous excerpt, it seemed that the meaning of the macro organizer (emphasis on the return to her partner as she did before) was circumvented. This seemed to be promoted by the use of the strategy of abstraction. So, client focused on the assumption that her children are “*above everything and everyone*”. These moral stances are defined as being of higher level and somehow even seem to be “immune to counterfactual evidence” (Josephs & Valsiner, 1998, p. 79). In fact, the several times she returned to her partner seem now insignificant, as a new rule has been created for future actions.

## Re-Conceptualization of the Emergence of i-moment Through the Notion of Synthesis

According to the change model proposed before, after the emergence of action, reflection and protest i-moments, re-conceptualization emerges and has an increasing salience in good outcome groups. The emergence of re-conceptualization i-moments seemed to be a result of a synthesis process (see Cunha, Ribeiro, & Cavadas, 2009). By definition, this i-moment entails not only features of the past and the present, but also the transformation process. A meta-position had been achieved by the client that enables to see what had been happening and make meaningful connections between events. One can say that they are now able to see their story and to write their life script, from an authorship position (Gonçalves et al., 2009).

We believe that, for re-conceptualization to occur, it is important that the client had already achieved a position of separation from the problem, or a new relation to it. Previous findings (Gonçalves, Mendes, et al., 2009; Santos, Gonçalves, Matos, & Salvatore, 2009) suggested that protest i-moments seemed to promote this differentiation, as we saw in previous examples. Re-conceptualization i-moment seemed to be developed also after the other i-moments forms are present in psychotherapy in early stages. For instance, reflection could act as a precursor of re-conceptualization i-moment by making the first attempts to achieve new understandings and to depict self transformations.

An example of constructive elaboration, leading to a re-conceptualization i-moment in a successful case, is given in the next excerpt of Susan’s case. In this excerpt, divided in two parts, she had been recently separated from her husband, and her therapist was elaborating on the contrast between her vision of partner’s violence before she sought for help (judicial and psychological).

### *Fourth session*

**Therapist:** Do you think that being separated from your husband, that taking gradual steps towards a resolution, helps you to have a different image of the problem? [Elaboration on {non A}]

**Client:** I lost the tendency of forgiving him, still not all of it, the tendency to relativism and I’m starting to see things in a new light. [Reflection i-moment {B}]

**Therapist:** That’s curious, because you have persons that are trying to convince you otherwise... [Elaboration on {non B}]

- Client:** I'm also verifying something else: the more people try to convince me otherwise, the more I convince myself that I'm right, there is no way around. [Protest i-moment {C}]
- Therapist:** What do you think that helped you resist towards the discourse of unaccountability (of your husband) that others tried to convince you of? [Elaboration on {non A}]
- Client:** It's beginning to realize that things were really worse than I imagined. [Reflection i-moment {B'}]
- Therapist:** Hum
- Client:** And watching my daughter and thinking that there's no use for her to go through this. She's suffering the consequences, especially of being with her father... but my parents support is important, having them around.
- Therapist:** (...) You are telling me that you see the situation of living with violence in a new and more responsible perspective.
- Client:** I keep remembering lots of things, memories that come to my mind, that if... I think I have to write them down.
- Therapist:** And what...
- Client:** There are lots of things that came to my mind and then disappeared. I want to remember them again and I can't.
- Therapist:** What helped you to have a clear picture of the problem? [Elaboration on {non A}]
- Client:** I think that I was starting to talk openly with others... Starting to talk helped me to start remembering fights with him that didn't come to mind. [Action i-moment {B''}]

In the previous excerpt, the therapist asked about “a different image of the problem”, enabling an elaboration of the {non A} field. The client answered with a reflection i-moment, the {B} field, as she “*lost the tendency of forgiving him*”. In this i-moment we can still see features of the {A} field “*still not all of it*”. After this, the therapist made the counter-point {non B}, once again bringing the gap between both voices into light. The client stated that she was right, she is entitled to be right, as she has been the victim, and he must be responsible for his actions. Then, she will not drop the charges against him, as his family asked her to do. This protest i-moment ({C}) takes over the problem using the circumvention strategy of personal preferences “*I convince myself*” and also a powerful qualifier “*there is no way around*”. This actually takes over the meaning of “*people try to convince me otherwise*” that belongs to the problematic narrative. For this reason, we consider this protest a meaning of higher level from the previous reflection. It seems to state a new starting point for her life. We begin to notice that the rules of the problem are becoming less followed. The therapist's next question seems to aim to consolidate this clear opposition to the problem narrative (“*discourse of unaccountability that others tried to convince*”) expressed in the “*resistance*”—{non A}. The client stated new understandings in the sequence of the former ones, using qualifiers “*things were really worse than I imagined*” in {B} field. So, the main new comprehensions were not to forgive his violent actions upon her and realize that these were actually worse than she thought they were, mainly due to her tendency to relativism in the past (problematic narrative). Then, the therapist asks again about the {non A} field, the “*clear picture of the problem*”. The client elaborates on this field and enacts an action i-moment saying that she started talking about the victimization with other people, enabling her to begin to remember things that she did not remember before (Action {B''}). This field is very closely related to the previous reflection.

*Fourth session (continuation)*

- Therapist:** At this moment you recognize what you have gone through. [Elaboration on {non B"}]
- Client:** In a clearer way, yes. I think that there are things that are beginning to hurt me, because I'm letting them come forward. I used to postpone before, not thinking, because if I thought about it I felt down and my son suffered. Now my parents are helping me. I'm starting to have a space for myself. I'm starting to have time to think and to let memories come. [Re-conceptualization i-moment {D}]
- Therapist:** I'm realizing that the anesthesia is going away.
- Client:** Yes, it is. I've never cried before, I've never talked about some situations... but now I cry, this is beginning to happen to me [Continuation of the re-conceptualization {D}].
- Therapist:** But that is...
- Client:** I still control myself a lot because my daughter is always present and I control myself because my parents are present... and they have been through a lot lately... I can't imagine what they have been through...
- Therapist:** (...) In fact, the anesthesia and bad feelings are going away... however, even if you want to tranquilize important people in your life, it is also important to have moments when you can release yourself from that tension. This is one of those spaces, but maybe you'll have to look for others...
- Client:** From now on I'll try to find other spaces. I'll try to find others. [Performing change {E}]

The therapist stressed the negative emotion associated with the problem, when she hid her situation from others because of fear. So, the client developed recognition of what she went through with the violence experience and a new comprehension that she had not had while she was living with her husband. The process that allowed this understanding was the achievement of the former i-moments, to think about it and let her memories come to her, as she did not remember violence episodes when she came to therapy. Also, a new emotional expression is involved (crying) as a result of this change. In other words, re-conceptualization forms a new meaning complex ({D}) that is of higher level than the previous ones, resulting from a synthesis process not only of i-moments but also of the problem that is integrated or assimilated into this new comprehension (see Fig. 22.7) The client enacts another meaning complex ({E}) as she said she needed to find new spaces (other social contexts) where she could be able to express her feelings and have relaxing moments. These movements towards well-being could only be narrated due to the new comprehension expressed before in re-conceptualization i-moment.

The therapist's intervention bringing forward the distinction between the former and the new self frequently seemed to elicit re-conceptualization i-moments. In narrative therapy, re-conceptualization can be triggered by the establishment of an opposition to the previous macro organizer as we can see in the next illustration. In the next example the therapist compares the present ("time to receive") and the past ("time to search for") in terms of affective relationships. This meaning complex is again a re-conceptualization, fruit of previous achievements, as she stated in the process of "*thinking and rethinking the situation*".

*Session Eight*

- Therapist:** Especially at this stage... it's time to receive, isn't it? Not to search... [Elaboration on {non A}]

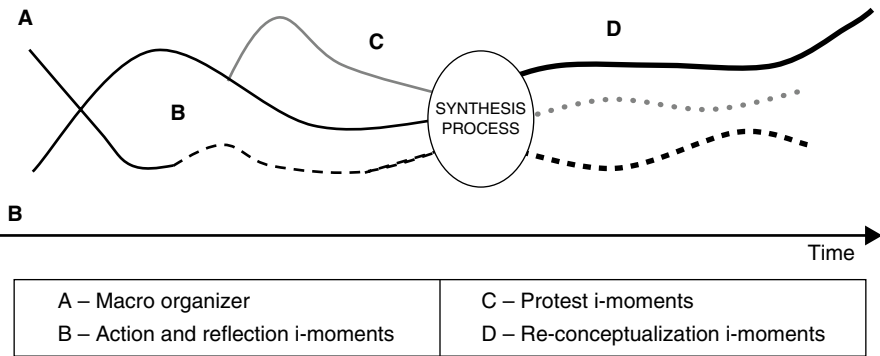

Fig. 22.7 Synthesis process and the emergence of re-conceptualization {D}

**Client:** That’s exactly how I feel, I need to receive... I came to the conclusion that... sometimes I’ve told people that the last months have been very bad, the last months with John, I mean, but lately, with all this thinking and rethinking of the situation, I see that they were not. In fact bad were the four years of emotional repression and lack of affection.

**Therapist:** It’s another interesting perspective...

**Client:** I really thought mainly about the last months, but now I don’t, I’ve started to realize that it comes from years ago... [Re-conceptualization i-moment {D}<sup>7</sup>]

**Therapist:** We can also talk about future contexts... [Elaboration on {non D}]

**Client:** I really love to be with other people, I need to have people around me, I like to have friends and quality relations, essentially. I’ve always been an affectionate person... and I’m recovering that well being that I used to have with other people, that I always had, I’m being able to recover it. [Performing change i-moment {E}]

This i-moment seemed to appear in order to reframe violent experience, meaning that she looked to past experiences and saw how they affected her, how she came to new solutions and how she dealt with them at that time. At this stage, the experience of violence began to be integrated into a new manner in the story of the self. This re-conceptualization was not preceded by a series of other i-moments, like in the previous example. Rather, at this stage of therapy, Susan enacted several re-conceptualizations i-moments as a form of synthesis from the i-moments that had been emerging in previous sessions. If we decompose this i-moment, it seemed made of several small achievements that taken together compose this new rule for Susan’s life.

Lyra (1999, 2007) described the process of abbreviation as the way of emerging novelty in mother-infant relations, as some old features of the interchange become abbreviated allowing to explore new relational features (e.g., when caregiver and child are playing with an object). So re-conceptualization emergence could be the result of an abbreviation process, as it implies the integration of past conditions

<sup>7</sup> Re-conceptualization is associated with field {D} for clarity purposes and also to highlight the higher order nature of this i-moment. It would be necessary to analyze the entire case to identify the meanings that promoted this re-conceptualization emergence that is the {A}, {B} and {C} complexes.

that are now regulated in an integrated manner. The former behaviors are no longer needed, since their meaning is abstracted and assimilated by the re-conceptualization, which means that it is available for further mediations.

The emergence of re-conceptualization can be understood as the achievement of a new macro organizer of self's meanings. As we create meaning ahead from our needs in daily life, this new framework, or meaning organizer, is a very important developmental tool for the client. This synthesis of former i-moments, as a pattern formation, provides the client with a narrative framework to understand not only present and past experiences ( $\{D\}$ ), but also futures ones. In fact, a performing change i-moment emerged, from the therapist elaboration about future contexts ( $\{\text{non } D\}$ ). Accordingly to the re-conceptualization meaning that stated lack of affection with her partner since they were married and her need to receive now, performing change developed from its contrast, the self feature of being an affective person that seemed to be vanished in the relation with her husband and that she seemed to be able to recover ( $\{E\}$ ).

The study of re-conceptualization would benefit from a deep analysis following either personal themes or voices throughout therapeutic process. It may be possible that some self positions may not achieve re-conceptualization along the process. It would be also interesting to demonstrate the weight of each of the three i-moments (action, reflection, and protest) in re-conceptualization's development.

## Conclusion

The dialectical analysis allowed a deep understanding of the meaning construction in therapy through i-moments. Moreover, it allowed explaining its emergence in a developmental framework. The dialectical nature of i-moments points to its inherent dialogicality. They seem to emerge from a dialogical relationship of contrast with the macro organizer. Thus, the kinds of dialogical relationship between the macro organizer and new meaning complexes will allow the maintenance of the first or the development of new macro organizers. In psychotherapy, i-moments are, by the action of the therapist, questioned, contrasted, emphasized, or even trivialized in therapeutic conversation. Besides the therapist effort in inviting the client to dialogue, this intervention will depend "on the way the client gives meaning to it" (Gonçalves & Guilfoyle, 2006, p. 253). Congruently, Leiman and Stiles propose the application of the zone of proximal development to therapy interchanges as an "intersubjective field" (Leiman & Stiles, 2001, p. 316), where the developmental stage of the client will influence his or her ability to make sense out of therapeutic interventions.

The meanings that clients bring to therapy seem to be organized in a way that a macro organizer is constraining the meanings system. By constrain we mean that it is a higher meaning that influence the lower ones, and often these lower levels are being continuously integrated into the previous organization. These relations between levels of meaning are stable, in the sense that do not allow the "permanent impermanence of signs" (Valsiner, 2001, p. 89).

The macro organizer of meaning acts like a rule for the person's life. In therapy, it is from this rule that transformation and change may occur, since it is the main meaning available for co-constructing change. The exceptions to this rule, or i-moments, seem to be the departure point for meaning transformation. However, i-moments can also become a part of the meaning maintenance, as in the process of mutual in-feeding, deeply explored in previous works (Gonçalves et al., [in press](#); Santos et al., 2009).

The resolution of mutual in-feeding seems to be promoted by a progressive defiance of the macro organizer of problematic meaning by i-moments meanings, establishing a different relation between them. The contrast that i-moments meanings created is used in order to take over the macro organizer, to reinforce person's goals, and, therefore, to elaborate on these exceptions. As i-moments meanings become differentiated from the macro organizer, they act like attractors to the development of further exceptions. So, i-moments suffer a differentiation in their type and content, and also an escalation as they become more elaborated in therapy. Consequently they achieve higher order levels in self's meaning system, progressively replacing previous organizers.

The i-moments escalation and progressive differentiation seems also to be the process involved in the re-conceptualization emergence. Moreover, this type of i-moment also involves the assimilation of the problem in an abstracted and generalized meaning, as a product of a synthesis process. Re-conceptualization progressive salience seemed to reduce the probability of the mutual in-feeding occurrence, since opposition was not a possibility anymore. So, the emergence of re-conceptualization would involve more than an opposition of meaning complexes, as it lead to an integration of both, that would be narratively elaborated (through an increased salience) into a new macro organizer of meaning. These new meanings became a source of flexibility in self's meanings system, being also the departure point for new innovative cycles (i.e., the emergence of more i-moments).

Re-conceptualization could be considered a promoter sign, or meaning mediator, because it seems to support development with "a feed-forward function" (Valsiner, 2005, p. 2002). It also seemed to be internalized in good outcome cases and set up conditions for future experiences, where the knowledge achieved can be transferred into other contexts (performing change i-moments). Subsequent i-moments are ruled by re-conceptualization framework, meaning that in the same contexts of life, people's actions and thoughts follow a new macro organizer that allows new meanings. This is also possible due to the temporal framework that it implies, connecting the past to the present and anticipating the future, and the formation of a new higher order stability, or a new *gestalt*.

One can argue that this process may be, once again, the establishment of a monological narrative. However, a sense of stability is needed in self's system of meanings in order to develop and be able to integrate new meanings. So, in successful therapy, this new macro organizer would not entail monological relations between parts of the self, but dialogical ones. It would enable them to negotiate new meanings and achieve new higher order semiotic mediators, allowing not only the macro organizer to orient persons' experiences, but also that novelty can be developed and transform the higher levels meanings. In this sense, it will become also more flexible.



In this approach, as in other developmental ones, the role of tension or desequilibrium is a central feature for change to happen (Josephs et al., 1999; Lewis, 2000). We would argue that it is essential for novelty to unfold within auto-regulatory self systems, since introduces a discontinuity or even a state of disorder that the person needs to resolve. This resolution may lead to the maintenance of the old patterns, as we saw in mutual in-feeding situation, but it can also lead to the rupture of those patterns, allowing an opportunity to transform and change them.

## Final Remarks

In this work we analyze the developmental and dialogical framework in which i-moments emerge in therapy. Therapeutic change is considered a developmental process that is promoted by the emergence of i-moments. Meanings are understood as complexes that entail dialogical relations between them. Therefore, the evolution of the clinical process into failure or success seems dependent on the regulation of these dialogical interchanges. The macro organizer of meanings, brought by the client to therapy, can relate with i-moments' meanings in a process of mutual in-feeding, preventing new i-moments to develop, namely re-conceptualization. The dialectical approach allowed us to deeply understand this process and to propose some ways to resolve it by, for instance, a takeover of the macro organizer by means of the circumvention strategies. The semiotic tools are thus important in promoting stability but also in enhancing development. As i-moments develop into new ones, and become distant from the previous macro organizer, the more complex and narrative structured i-moment, re-conceptualization, seemed to emerge by a process of synthesis. It seems to allow the development of a new macro organizer of meanings, regulating, and mediating not only clients' experiences, but also their past and novel meanings. Future analysis of this process will be helpful for practice, in the sense that the therapist can be involved in promoting actively the emergence of re-conceptualization i-moments.

The analysis of therapeutic change as a developmental process, allows revealing what processes take place at a microgenetic level that promote ontogenic change. The dialectical approach is a useful tool to study the rapid flow of micro-processes that are involved in i-moments emergence, maintenance and transformation into self's narratives throughout therapeutic process. It also enables researchers to account for the dynamics of the change processes that seemed to be built upon the emergence of tension and uncertainty. These seem to be not only useful, but necessary to achieve change in therapy (cf. Molina & del Rio, 2009). Avoiding the ambivalence and the asymmetry of meanings that emerge in therapeutic conversation, by means of the i-moments, in order to promote a sense of continuity or coherence, can easily end up in monological and rigid self positions. The dialogical processes and mechanisms that allow evolving from one tensional state to another can have many possible forms that are still needed to be studied, not only in therapy but in daily life self transformations.

## References

- Bruner, J. (1986). *Actual minds, possible worlds*. Cambridge, MA: Harvard University Press.
- Cruz, G. (2008). *Os Momentos de Inovação no processo de mudança espontânea: um estudo exploratório [The innovative moments in the process of spontaneous change: An exploratory study]*. Unpublished master dissertation, University of Minho, Portugal.
- Cunha, C., Ribeiro, A., & Cavadas, C. (2009). Rehearsing renewal of identity: Re-conceptualization on the move. In M. M. Gonçalves & J. Salgado (Eds.), *Processes of innovation: Studying change in psychotherapy and everyday life*. Manuscript in preparation.
- Dimaggio, G. (2006). Disorganized narratives in clinical practice. *Journal of Constructivist Psychology, 19*, 103–108.
- Dimaggio, G., & Semerari, A. (2004). Disorganized narratives: The psychological condition and its treatment. How to achieve a metacognitive point of view restoring order to chaos. In L. Angus & J. McLeod (Eds.), *Handbook of narrative psychotherapy: Practice, theory and research* (pp. 263–282). Thousand Oaks, CA: Sage.
- Flynn, E., Pine, K., & Lewis, C. (2007). Using the microgenetic method to investigate cognitive development: An Introduction. *Infant and Child Development, 16*, 1–6.
- Gonçalves, M. M., & Guilfoyle, M. (2006). Dialogism and psychotherapy: Therapists' and clients' beliefs supporting monologism. *Journal of Constructivist Psychology, 19*, 251–271.
- Gonçalves, M. M., Matos, M., & Santos, A. (2009). *Innovative moments coding system* (Version 7.2). Braga: University of Minho. Available from the authors.
- Gonçalves, M. M., Matos, M., & Santos, A. (2009). Narrative therapy and the nature of “innovative moments” in the construction of change. *Journal of Constructivist Psychology, 22*, 1–23.
- Gonçalves, M. M., Mendes, I., Ribeiro, A., Angus, L., & Greenberg, L. (2009). *Innovative moments and change in emotion-focused therapy: The case of Lisa*. Manuscript submitted for publication.
- Gonçalves, M. M., Santos, A., Salgado, J., Matos, M., Mendes, I., Ribeiro, A., Cunha, C. & Gonçalves, J. (in press). Innovations in psychotherapy: Tracking the narrative construction of change. In J. D. Raskin, S. K. Bridges, & R. Neimeyer (Eds.), *Studies in meaning 4: Constructivist Perspectives on Theory, Practice, and Social Justice*. New York: Pace University Press.
- Gonçalves, Ó. (2000). *Viver Narrativamente: A Psicoterapia como Adjectivação da Experiência*. Coimbra: Quarteto.
- Hermans, H. J. M., & Hermans-Jansen, E. (1995). *Self-narratives: The construction of meaning in psychotherapy*. New York: The Guilford Press.
- Josephs, I., & Valsiner, J. (1998). How does autodialogue work? Miracles of meaning maintenance and circumvention strategies. *Social Psychology Quarterly, 61*, 68–83.
- Josephs, I., Valsiner, J., & Sargan, S. E. (1999). The process of meaning construction—Dissecting the flow of semiotic activity. In J. Brandstadter & R. M. Lerner (Eds.), *Action and development. Theory and research through the life span* (pp. 257–282). London: Sage Publications.
- Krause, M., de la Parra, G., Aristegui, R., Dagnino, P., Tomicic, A., Valdés, N., et al. (2007). The evolution of therapeutic change studied through generic change indicators. *Psychotherapy Research, 17*, 673–689.
- Leiman, M., & Stiles, W. B. (2001). Dialogical sequence analysis and the zone of proximal development as conceptual enhancements to the assimilation model: The case of Jan revisited. *Psychotherapy Research, 11*, 311–330.
- Lewis, M. D. (2000). The promise of dynamic systems approaches for an integrated account of human development. *Child Development, 1*, 36–43.
- Lyra, M. C. D. P. (1999). An excursion into the dynamic of dialogue: Elaborations upon the dialogical self. *Culture & Psychology, 5*, 477–489.
- Lyra, M. C. D. P. (2007). On abbreviation: Dialogue in early life. *International Journal for Dialogical Science, 2*, 15–44. Retrieved December 13, 2007, from [http://ijds.lemoyne.edu/journal/2\\_1/index.html](http://ijds.lemoyne.edu/journal/2_1/index.html)

- Lysaker, P. H., & Lysaker, J. T. (2006). Psychotherapy and schizophrenia: An analysis of requirements of an individual psychotherapy for persons with profoundly disorganized selves. *Journal of Constructivist Psychology, 19*, 171–189.
- Matos, M. (2006). *Violência nas relações de intimidade. Estudo sobre a mudança psicoterapêutica da mulher* [Violence in intimate relationships: A research about the psychotherapeutic change in women]. Unpublished doctoral dissertation. University of Minho, Portugal.
- Matos, M., Santos, A., Gonçalves, M. M., & Martins, C. (2009). Innovative moments and change in narrative therapy. *Psychotherapy Research, 19*, 68–80.
- McAdams, D. P. (1993). *The stories we live by: Personal myths and the making of the self*. New York: William Morrow.
- Meira, L., Gonçalves, M. M., Salgado, J., & Cunha, C. (2008, July). *Everyday life change: Contribution to the understanding of daily human change*. Paper presented and submitted for book publication at the 2nd International Conference on Psychology, Athens, Greece.
- Molina, M. E., & del Rio, M. T. (2009). Dynamics of psychotherapy processes. In J. Valsiner, P. C. Molenaar, M. C. D. P. Lyra, & N. Chaudhary (Eds.), *Dynamic process methodology in the social and developmental sciences* (pp. 455–476). New York: Springer.
- Neimeyer, R., Herrero, O., & Botella, L. (2006). Chaos to coherence: Psychotherapeutic integration of traumatic loss. *Journal of Constructivist Psychology, 19*, 127–145.
- Polkinghorne, D. E. (1988). *Narrative knowing and the human sciences*. Albany: State University of New York Press.
- Polkinghorne, D. E. (2004). Narrative therapy and postmodernism. In L. E. Angus & J. McLeod (Eds.), *The handbook of narrative and psychotherapy: Practice, theory and research* (pp. 53–68). Thousand Oaks: Sage.
- Ribeiro, A. (2008). *Processos Narrativos de Mudança em Psicoterapia: O estudo de um caso de sucesso de terapia construtivista centrada em dilemas implicativos* [Narrative processes of change in psychotherapy: A study of a good outcome case of constructivist psychotherapy focused on implicative dilemmas]. Unpublished master dissertation. University of Minho, Portugal.
- Santos, A., Gonçalves, M., Matos, M., & Salvatore, S. (2009). *Innovative moments and change pathways: A good outcome case of narrative therapy*. Manuscript submitted for publication.
- Santos, A., Gonçalves, M. M., & Matos, M. (2009). *Innovative moments and therapeutic poor outcome in narrative therapy*. Manuscript submitted for publication.
- Sarbin, T. R. (1986). The narrative and the root metaphor for psychology. In T. R. Sarbin (Ed.), *Narrative psychology: The storied nature of human conduct* (pp. 3–21). New York: Praeger.
- Siegler, R., & Crowley, K. (1991). The microgenetic method: A direct for studying cognitive development. *American Psychologist, 46*, 606–620.
- Valsiner, J. (1991). Construction of the mental: From the ‘cognitive revolution’ to the study of development. *Theory Psychology, 1*, 477.
- Valsiner, J. (2001). Process structure of semiotic mediation in human development. *Human Development, 44*, 84–97.
- Valsiner, J. (2002). Forms of dialogical relations and semiotic autoregulation within the self. *Theory and Psychology, 12*, 251–265.
- Valsiner, J. (2005). Scaffolding within the structure if dialogical self: Hierarchical dynamics of semiotic mediation. *New Ideas in Psychology, 23*, 197–206.
- Watzlawick, P., Weakland, J. H., & Fish, R. (1974). *Change—Principles of problem formation and problem resolution*. New York: W. W. Norton & Company.
- White, M. (2007). *Maps of narrative practice*. New York: Norton.
- White, M., & Epston, D. (1990). *Narrative means to therapeutic ends*. New York: Norton.

## Chapter 23

# Techno Parties, Soccer Riots, and Breakdance: Actionistic Orientations as a Principle of Adolescence

Aglaja Przyborski and Thomas Slunecko

What is the potential of a process-oriented or praxeological methodology as outlined in our other contribution to this volume (Chapter 7)? What kind of empirical results does such a methodology generate? What is the relevance and scope of object theories<sup>1</sup> developed on the basis of reconstructive methods? In this chapter, we answer these questions by focussing on some well-confirmed research results that build up to a theory of adolescent actionism. We thereby draw on several systematically related large-scale studies based on over hundred cases (individual persons and groups) in total.<sup>2</sup> We single out individual cases to exemplify the studies in order to vividly illustrate the research practice. Methodical comments are restricted to a minimum in favour of demonstrating the unfolding of the object theory—in this case: the theory of actionism—and its embedding into a comprehensive theory of adolescent development. Two process structures—a situational and a biographical one—will be central in developing the argument: actionism and the phases of adolescent development.<sup>3</sup>

The choice of adolescent scenes—techno parties, soccer riots, and breakdance—is rather arbitrary. We could just as well have exemplified our concern with thievery (we will soon encounter this example), music making, or computer gaming (Schäffer, 1996, 2003a), strategies of partner selection (Bohnsack, Loos, & Przyborski, 2001; Przyborski, 2004, p. 198ff.), or ritual name-calling (Przyborski, 2004, p. 218ff.). Let us turn to the techno scene first.

---

<sup>1</sup> We develop the notion ‘object theory’ in Chapter 7 of this book.

<sup>2</sup> These studies mainly belong to a series of research projects funded by the German Research Foundation (DFG) with Ralf Bohnsack as the principal investigator. The results were published in Bohnsack et al., 1995; Bohnsack and Nohl, 2000; Bohnsack, Loos, and Przyborski, 2001; Nohl, 2001; Bohnsack and Nohl, 2003; Przyborski, 2004.

<sup>3</sup> For the typology of developmental phases see Bohnsack, 1989; Bohnsack et al., 1995; Schittenhelm, 2006.

---

A. Przyborski (✉)  
Department of Psychology  
Sigmund Freud University  
1030 Vienna, Austria  
e-mail: aglaja.przyborski@univie.ac.at

## “Complete Strangers Engage in the Most Erotic Dances”— Dynamics on the Dance Floor

Like the other youth culture phenomena mentioned in the title, the techno scene has been described in much detail (Hitzler & Pfadenauer, 2001; Schneider & Töpfer, 2000; D’Andrea, 2007). Both journalistic and scientific portrayals of this party scene sway between the separation and isolation in the booming, extremely rhythmic, electronic music on the one hand and a peaceful celebration of multiplicity which is open to everyone on the other hand. Such contradicting ‘diagnoses’ come about, because most descriptions ignore the recurring process structure of the techno scene. In a case study,<sup>4</sup> 2 young women who have actively taken part in the techno scene for several years describe dancing as the core activity of such parties:

**Anna:** Complete strangers engage in the most erotic dances and somehow (.) every body rubs itself against the other ey. (.) Me with an unknown man, me with an unknown man on the dance floor

**Bianca:** (short laugh)

**Anna:** Somehow (he) stands there, and what do I know, we touch and somehow there were no inhibitions. (...)

**Bianca:** It happened there on the dancefloor and actually didn’t have much-

**Anna:** It didn’t have anything to do with the outside world

**Bianca:** Yes, that didn’t mean anything anymore<sup>5</sup>

**Anna:** Wildfremde machen miteinander die erotischsten Tänze und irgendwie (.) da reibt sich jeder Körper am anderen ey. (.) Ich mit ‘nem fremden Mann, ich mit ‘nem fremden Mann auf der Tanzfläche

**Bianca:** (lacht kurz auf)

**Anna:** Irgendwie steh (er) da, und was weiß ich, wir fassen uns an und irgendwie, da warn einfach keine Hemmungen mehr da. (...)

**Bianca:** Das war da auf der Tanzfläche und hatte aber eigentlich nicht viel -

**Anna:** Das hatte nichts mit der Außenwelt zu tun.

**Bianca:** Ja, das hatte nichts mehr zu bedeuten.

In this portrayal the dancers only form a unity or couple for an instance. As they say later “it is simply the moment in which you see yourself and it becomes clear” [ist einfach nur der Moment, dass du dich siehst und dass es klar ist]. When this moment has passed the encounter remains without any consequences. All it takes is eye contact and the right feeling. Dancing partners need not know each other nor is any kind of verbal coordination required (as would be the case when asking some-

<sup>4</sup> Przyborski describes this case in detail (2004, p. 133ff.).

<sup>5</sup> The interviews were transcribed word by word and interpreted on this basis. The quoted excerpts were revised only minimally for the sake of this paper in order to allow readers not acquainted with transcriptions an easier access to the text. The translation attempts a tightrope walk between a literal and a rough translation. We include the German transcripts for readers with German reading skills who want to make their own interpretations based on the original language. It is vital that the style of the conversations is not lost because essential elements of (shared) meaning structures could be expressed even in accidental insertions, repetitions, or mutually supplementing statements. The signs read as follows: (.) = short break; underlined word = emphasis; - = stops mid-sentence; (...) = part of the interview skipped.

one to dance). A look is literally worth a thousand words here (Schäffer, 2003b). As the example of Anna shows, the shared dance comprises intensive body contact and “eroticism”. Inhibitions disappear on the dance floor, i.e., within the limited realm of the party. They still keep their function in every day life: in the “outside world”. There one stays with one’s usual moral outlooks and the according feelings. Encounters on the dance floor, however, follow a different standard of interaction than encounters in ‘real’ life. This sets certain limits to the meaning of these contacts. It is interesting that encounters between the dancers seem to emerge in a sphere without conditions. It all starts within the context of a professionally organized setting, i.e., the party, the “dance floor”, in which dancers encounter each other anonymously and completely give themselves to their own corporeality and to an unforeseeable dramaturgy. Whatever may hinder this autopoietic dynamics—like feelings bred from moral sentiments—is out of place. One gives in to the situation as it were, to one’s corporeality, and to the erotic-sexual impulses arising from movements and touches. The interaction is neither directed at a certain goal nor is it supposed to fulfill any specific function in the world outside the party setting. Dancing is not subject to any purpose. It is not object- or goal-oriented. What is at stake is shared “involvement”, an experience of shared practice, a kind of mutual incitement and euphoria. The interaction thus arises out of the spontaneity of a shared practice. We will refer to this orientation as collective actionism.

We will keep this action structure in mind while turning to different practices of youth culture that manifest different contents and foci: riots in the context of soccer (so-called hooligans) and a specific kind of dance battleship (break dancing).<sup>6</sup> We will ask for the commonalities in these practices in spite of all apparent differences.

## “We Got Enough Spanking”—The Dynamics of Fight

Soccer riots are attributed a wide range of meaning, too. They are seen as indicators of decay, brutalization, and increasing criminality among the youth,<sup>7</sup> or as signs of an almost inescapable fascination of physical-violent conflict.<sup>8</sup> A closer focusing on experiences during the fight, however, demonstrates that—while there is of course violence—the fascination and attraction of fighting stems from a different source. Again, we encounter involvement and mutual incitement. As in the above scenario, one could not speak of a goal-directed criminal orientation, too. A field researcher took part in riot activities in the hooligan scene of Berlin. He could gain access to the scene with the help of several young men (about 20-years-old). Due to their

<sup>6</sup> Such a maximal contrast is not recommended for the concrete research practice because it makes one lose sight of the wood for the trees. Analyzing a single case usually does not allow the level of abstraction we will soon reach. We present the analysis this way for the sake of providing an interesting and comprehensible depiction of results. Our presentation, thus, does not at all mirror the concrete, stepwise research practice.

<sup>7</sup> For a critique of the discourse concerning youth and criminality see Bohnsack (2000).

<sup>8</sup> A prototypical example of such a discourse is Buford (2001).

“battle-testedness” they were appointed coordinators of activities in the context of a soccer match.<sup>9</sup> On the day before the game a member of the group handed him a pair of “New Balance” shoes (a specific brand) and told him to wear them during the game. The researcher decided to comply to this demand, knowing he would be identified as a hooligan by wearing this outfit. He describes the setting of the match as follows:

*About 20–25 adolescents had gathered in the pub. I tried to introduce myself to one of the adolescents because I didn't know anyone except Benno and Carlo. The adolescent gave his name but was not interested in any further contact and moved along. Not long after that, Benno took me aside and explained that I did not need to introduce myself, and that I should not make any further contacts, for: “That's odd”.*<sup>10</sup>

*Etwa 20–25 Jugendliche waren in der Kneipe versammelt. Ich versuchte mich bei einem Jugendlichen vorzustellen, da ich außer Benno und Carlo niemanden kannte. Der Jugendliche sagte zwar seinen Namen, war jedoch nicht an einer weiteren Kontaktaufnahme interessiert und ging weiter. Benno nahm mich kurz darauf zur Seite, und erklärte mir, dass ich mich hier nicht vorzustellen bräuchte und auch keine weiteren Forschungskontakte knüpfen sollte, denn: “Das kommt nicht gut.”*

Benno initiates drinking games, is saluted by new arrivals, counts the attendants, and comes to the conclusion that 30 men already form a “good mob”. At this particular gathering—contrary to gatherings that were not about collecting a “mob”—the field researcher was expected to assimilate his outfit to the hooligans, and to refrain from any communication that could give away his social identity (researcher) or his personal identity (e.g., his name). The basis of this actionism is—comparable to the techno party—a far-reaching anonymity of the participants. The 2 women quoted above mentioned, for example, that it did not matter whether they danced with a man or a woman—although neither of them was a “lesbian”—and that they did not care about outfits. Any reference to social or personal identity loses its meaning. Among hooligans, the “battle-tested” coordinators even make this anonymity a rule. Individual identity markers are to be eliminated.

Again actionism here takes place in an externally organized setting. In the first case it is a party, in the second case a soccer game. It is only within this setting that everyday attitudes are suspended. Benno and Carlo not only coordinate the activities of the mob (at least they do so rudimentarily), but they are also responsible for inciting the atmosphere with the help of drinking games that stimulate the consumption of alcohol and loosen inhibitions. Such atmosphere is an essential backdrop for the ecstatic incitement of collective actionism. This is also evident in Benno's statement that distancing oneself from the activities by observing and demonstrating otherness is “odd”. Distancing impedes the slide into actionism. As with dancing at a techno party, entanglement and corporeality play an essential role for hooligan “fights”. Christian (21) narrates the “first game” he experienced at the age of 15:

<sup>9</sup> The case is embedded in a typology of violent actionism in Bohnsack et al. (1995).

<sup>10</sup> These notes are taken and translated from an observation protocol. We (the first author took part in the project) usually wrote these protocols on the day after the field observation. (cf. Przyborski & Wohlrab-Sahr, 2008, p. 63ff.)

*I came with them for the first time and I must tell you frankly, I was scared stiff. We arrived at the stadium and along came an older one. He took me by the arm (...) and said 'Come on, today we're gonna do one together.' (...) And then along came the Nurenbergers. (...) Well, and all of a sudden they were all standing there, and then we just(...) had to run all day long (...) and we got enough spanking throughout the day. Well ... I really felt queasy with them all standing there, about six- or seven-hundred people, and just a few of us. And I was thinking to myself 'oh my, what did you get yourself into.' I had imagined it to be a little different.<sup>11</sup>*

*Ich bin das erste Mal mitgefahren und ich muss dir ehrlich sagen, ich hatte eine Heidenangst. Wir kamen da ans Stadion und da kam gleich ein Älterer; (...) hat mich unter den Arm genommen und gesagt 'Komm wir machen beide heute einen zusammen' (...) Und dann kamen die Nürnberger. (...) Naja, und auf einmal standen die alle da, und dann ... mussten wir nur noch rennen den ganzen Tag (...) und haben genug Keile gekriegt den ganzen Tag über. Also ... da war mir echt mulmig zu Mute als die da alle standen, sechs-oder siebenhundert Leute und wir da so wenige. Da dachte ich 'Oh weia, wo bist du hier reingeraten'. Ich hatte mir eigentlich alles ein bisschen anders vorgestellt.*

Obviously, Christian did not know what he was getting involved with. Since he would join in on games and participate in riots over and over again, the unpredictability of the situation and the dynamics of completely getting entangled must have had a certain appeal, though. We neither read prowess nor sovereignty from his depiction of the situation. On the contrary, to depend on the group (represented by the “older one”) and to be ruled by a situation that induces fear and requires effort is the core of these experiences. The dependence upon the group emerges from the physical threat during the dynamics of fight. Even stronger than with techno dancing, soccer riots background personal identity and its basis (the body and physical integrity) for the sake of the actionistic focus. Nevertheless, the parallel is evident: Hooligans expose themselves to the risk of severe physical injuries—the dancers give away their inhibitions in the sexual sphere. In both cases, the boundaries of one’s body are at the mercy of unpredictable events.

## “Everyone Can Do the Powermoves”—The Dynamics of the “Battle”

Along with competitions, shows, and parties, the breakdance scene is characterized by so-called “battles”. On first glance, one would assume a competition of two groups to proceed according to rules known to both groups or under the watch of a referee. Asked about a referee by a researcher, though, the members of a popular breakdance group were rather irritated and replied: “The audience”. When asked about the win-

<sup>11</sup> This sequence is quoted from a narrative-biographical interview.



ner, they paused and answered only after a while: “Us”. Finally, Deniz, who had participated in the battle, described the structure of the competition to the researcher:<sup>12</sup>

*Two groups fight against each other but not with their fists. They try to get each other down with dancing. One shows an exercise, and one from the other group tries to out-dance him with his own step. (...) Other fighters are joining in and then you make the killer, the ultimate exercise that leaves the other group with nothing better to come up with. At the last battle we first danced each by ourselves and then we got in with eight people and danced. The others didn't even make it to the stage anymore.*

*Zwei Gruppen kämpfen gegeneinander, nicht mit Fäusten, sondern versuchen sich mit Tanzen fertigzumachen. Je einer macht eine Übung vor und einer von der andern Gruppe versucht ihn mit einer eigenen Übung zu schlagen. (...) Immer andere fighter machen bei diesem Kampf mit und dann macht man den Killer, die ultimative Übung, gegenüber der die andere Gruppe nichts Besseres zu bieten hat. Beim letzten Battle haben wir erst einzeln getanzt und sind dann plötzlich mit acht Leuten rein und haben getanzt. Die anderen kamen nicht mehr auf die Bühne.*

There are no rules to this battle. It is based on a mutual collective incitement in the sphere of corporeal-aesthetic actionism. As in Christian's narration, the break-dance battle is not primarily about winning. Comparable to the other actionisms, the adolescents taking part in a battle are not oriented toward an explicit aim. The issue of winning or not gets lost within mutual incitement and collective action.

Contrary to the actionistic scenarios described above, here there is a complex and in part communicatively structured coordination of the group members. The shows and battles are preceded by long periods of exercising. What is more, personal identity and personal style do not ‘surrender’ to actionism. Collective actionism and perfecting one's style are rather mutually dependent. This becomes evident when Tarik and Imad, both belonging to a group of younger dancers that had been instructed by the above mentioned group, distinguish between “powermoves” and “style”:

- Tarik:** Everyone can do the powermoves. Everyone can learn them, headspinning and such. That's only a matter of time. Style is not so easy. You can really see it: It's his style or it's just something he's picked up from other dancers. That's the most difficult part of dancing.
- Imad:** Style is tough. Style is someone's character. If you're aggressive, you're gonna approach the steps aggressively dumm-dumm-kre-de-kre. If you're a softy, you're gonna approach them softly, scht-da-da.
- Tarik:** Powermoves kann jeder machen. Die kann jeder lernen, so Kopfdrehen. Das ist nur eine Frage der Zeit. Beim Style ist das nicht so einfach. Da kannst du richtig erkennen: Das ist sein Style oder der hat ihn von anderen Tänzern abgeklaubt. Das ist das schwierigste beim Tanzen.
- Imad:** Style ist schwer. Style ist der Charakter eines Menschen. Wenn du aggressiv bist, gehst du aggressiv rein in die Schritte dumm-dumm-kre-de-kre. Wenn du ein Softy bist, gehst du soft rein, scht-da-da.

<sup>12</sup> For this and other cases among adolescents with a Turkish background see Nohl (2001).

Everyone can learn the technical skills of dancing. Someone's "style", however, reveals to the trained observer whether it is an authentic expression of "character" or merely an imitation. Here, collective actionism furthers and consolidates personal styles which are included in the collective action—resulting in a more or less explicit choreography of the entire group. The collective incitement—within the group as well as between groups—is thus partly based on personal identity and personal style elements. This marks a distinct contrast to the preceding examples in which mutual incitement succeeds only by means of subordinating individual identities.

In the actual research practice the comparative analysis which we have illustrated with three case studies is performed differently (see Chapter 7 in this volume). Besides the fact that we have only extracted small pieces from the cases, first analyses rarely allow such rapid abstraction. In the beginning, the comparison is rather drawn on a thematic level, i.e., by comparing passages or sequences with similar topics. The dimension of action orientations and process structures is only reached step by step—in a process of increasing abstraction. Moreover, a full-scale research project verifies across manifold comprehensively interpreted cases what we have here shown with the help of some details from single cases. The analysis proceeds as long as new cases yield significant further information. Nevertheless, even our illustrative description serves to clarify the following:

The first two cases entail a minimal contrast. Actionism takes place in a sphere in which the conditions of everyday life are suspended. It transgresses the boundaries of personal integrity and, thus, identity. Its precondition is an external frame, like an organized setting. Overlapping with one's everyday existence is avoided. There is hardly any verbal representation of core elements. The interpretation necessary for deciphering the process structure needs to rely on the decoding of imagery and performance. In later phases of their development the adolescents look back on these activities with some estrangement. Differences between the two cases are mainly found on the content level of the activities. A further difference lies in the excessive violence of soccer riots. In contrast, the last case, i.e., breakdance, demonstrates a comparatively highly organized form of interaction. Here, personal and collective identities and styles are elements of the actionism and identity boundaries are not violated. The interaction requires a reciprocal acquisition of perspectives plus a confidence that this acquisition of perspectives is stable and trustworthy and not only situational. Two parameters remain the same, though: a lack of intentional-rational, value-rational, or hedonistic goals of action, and a mutual incitement—a complete absorption into collective action. We may add a third common parameter: the central role of the body. Further analyses demonstrate the existence of actionisms not only in a corporeal sphere, but also in a religious (Nohl, 2001), intellectual (Przyborski, 1998), and musical (Schäffer, 1996) sphere, and on the basis of pre-structured commercial games (Nentwig-Gesemann, 2006).

A typification<sup>13</sup> is always an analytical abstraction. In this abstract view, actionism is a typification which is always overshadowed by other typifications—e.g., by

---

<sup>13</sup> We develop this basic notion in the section on generalizability of Chapter 7.

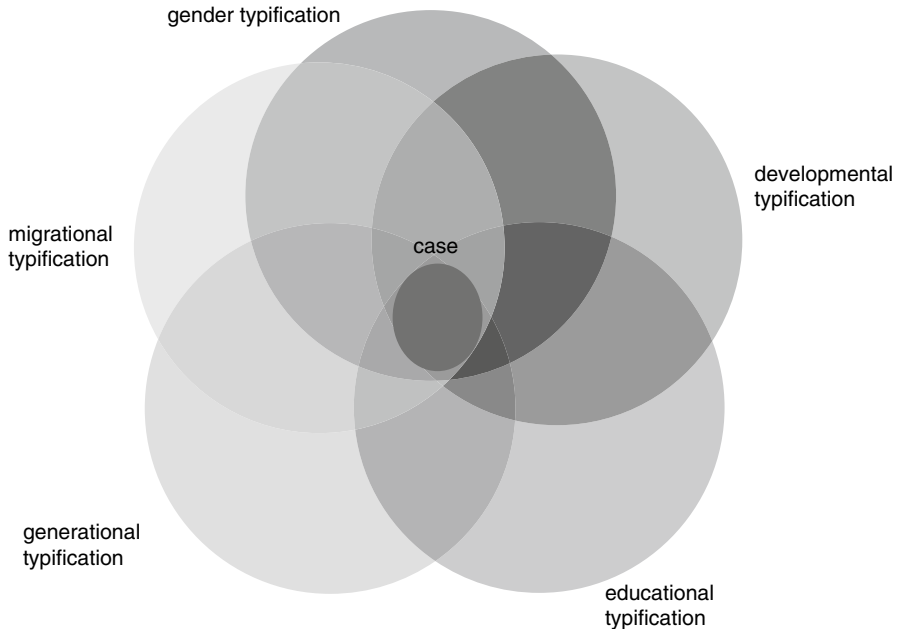

**Fig. 23.1** Graphic model of the relation between case and typifications

migrational, developmental, and gender typifications—and thus exists in different shadings.

The particular case, as we find it in reality, is a totality in its own, in which typifications are always interwoven in a unique way:

Let us return to the breakdance battle. In this case we can speak of an ‘organizational superstructuring of actionism’. It is marked by a commercial setting and entails a considerable professionalization of group members. But also the actionism of the breakdance groups has a prelude in their early adolescence and this prelude is more alike the other forms of actionism that we have described. Such asking about ‘origins’ necessitates a twofold consideration on the level of typological abstraction: it inquires the genesis—the socio-genesis or psycho-genesis—of a certain action structure or process structure; and it aims at reconstructing temporal sequences, i.e., at establishing a phase typology or development typology.

### ***Sober You Think: You Live. But What for?—The Developmental Dimension***

Between the ages of 15 and 17 many middle school students in Germany experience a transition from school to job training. They are confronted with a daily life the

redundant structures of which will make up their future lives. Often this phase of life is also marked by job applications which are very frustrating for the adolescents because these endeavours too often seem to be hopeless. These experiences often provoke first reflections upon their own life course and their background. They stimulate a search for self-positioning: How did I get here? Is it going to be like this forever? Orientations that were effective up to this point come to mind for the first time, resulting in difficulties in orientation and meaning which often manoeuvre adolescents into a more or less pronounced crisis.

This process mainly takes place within groups of peers. The crisis is usually less pronounced in groups that share a life-world, a certain history, a common life practice and whose members grew up in the same neighbourhood; it is more severe in milieus that are characterized by a high mobility of its members (Bohnsack, 1989; Bohnsack, Loos, Schäffer, Städtler, & Wild, 1995; Bohnsack & Nohl, 2003). If the life histories of group members share major commonalities from the outset, the (re)orientation mainly happens in distinction to other generations. The examples used by now, however, stem from the metropolis Berlin. Modern metropolises are characterized by national and international migration. Often, adolescents have very little life practices in common, be it at school or in the neighbourhood, because they do not share a history of socialization. When such mutualities are only insufficient, are given only as fragments, adolescents provoke such mutualities. Their search for mutualities, for a common ground of shared experience, however, does not take place in the realm of explicit values or ideas. Rather, it is a search for habitual commonalities. This search takes place in the lived life which is the basis of these values, but—in its self-evidence—precludes us from becoming conscious of it. Adolescents hardly go about this search in a conscious, goal-directed manner, i.e., by thinking and reflecting. It rather occurs in the spontaneity of action practice, through the mimesis of attitudes, or by echoing a style. As soon as there are mutual experiences, commonalities emerge.

For instance, with adolescents from rural areas the cyclic succession of rural festivals and events takes on a central meaning. Such recurrent events help the youth of the land to ascertain their commonalities and conjunctive sphere of experience and to escape their professional routines. If commonalities are missing in the first place, however, they are staged. Adolescents then experiment with different forms of collective practice. As we have seen in the above examples, such collective action is largely free of instrumental orientation and does not require explicit coordination. Shared experiences—especially if they concern mutual dependence, euphoria, collective coping with danger in the context of collective actionisms—unfold their own socialization history, at least within a certain time span. Within the collective actionism, adolescents also may try out the extent to which their own style elements can be condensed and intensified to collective style elements, and how far they can unfold habitual commonalities. In case of failure, new constellations of peers are formed.

In this critical phase between the ages of 15 and 17 the actionisms of the above portrayed breakdance group originate from a mixture of thievery and dancing. Later, the 20 years old look back on this time of their lives:

- Aziz:** Well there are lots of youths here well,  
**Deniz:** who are thieving  
**Aziz:** as a hobby.  
**Deniz:** It's become normal. Three years ago, instead of going to school, we'd go to the Ku-damm or something (.) to rich neighbourhoods where cell phones could be seen in cars and we'd steal cell phones.
- Aziz:** Also es gibt hier auch sehr viele Jugendliche also,  
**Deniz:** die klauen  
**Aziz:** hobbymäßig.  
**Deniz:** Das ist jetzt normal geworden. Vor drei Jahren oder so, statt in die Schule zu gehen, sind wir zum Ku-damm gefahren oder so (.) in reiche Gegenden, wo man in Autos Handys sieht oder so und haben Handys geklaut.

Illegal action belongs to the group's past. The adolescents distinguish phases of their development and regard the actionisms of the former phase from some distance. Their relation to it remains vague, however. It is unclear whether they themselves have become "normal", or if thieving has become "normal" for younger adolescents.

The actionism of thieving goes along with the experience of fear, involvement, and mutual dependence. It carries features apt to experiment with collectivity and the unfolding of a shared history much without pre-conditions. Thieving is thus a medium for the search for habitual commonality. It has a second function, though. In this actionism the adolescents temporarily escape their daily lives which are structured by institutionalized schedules, be it at school or at work. In this phase they negate their being forced into a life course that complies to societal expectations and norms. It can be characterized as a phase of negation.

At the age of 20, most adolescents have come to somewhat good terms with their job routines. Unlike the phase of negation, this phase knows biographical plans that reach into the future, plans to which the experiences in the context of breakdancing form an essential background. The adolescents are in a phase of re-orientation.

If we reconsider the actionisms in the phase of negation, their central meaning and their relation to the above mentioned crisis becomes more clear. To Anton and Bernd, who belong to the above quoted group of hooligans, the actionisms of the weekends form a weekly climax:

- Bernd:** Probably that's the reason why we drink so much: to get out of the rhythm. With alcohol you're on a different level. When I sometimes lie in bed at night, sober, you think: You're alive. But what for? You're dead. Your grandchildren might remember you, but that's it.
- Anton:** Yeah, sure. (...) You have to get up early during the week, you work, and come home late, it makes sense that you have some bigtime on the weekends, that you get trashed. During the week I work like an animal, it's just natural that I go have a night on the town at the weekend.
- Bernd:** Wahrscheinlich wird das der Grund sein, warum wir so viel trinken: dass man wieder aus dem Rhythmus raus kommt. Mit Alkohol bist du auf einer ganz anderen Stufe. Wenn ich abends manchmal im Bett liege, nüchtern, dann überlegste: Du lebst. Aber für was? Du bist tot. Deine Enkelkinder erinnern sich vielleicht noch, dann ist aber auch Schluss.
- Anton:** Ja, logisch. (...) Du musst immer früh die ganze Woche raus, arbeitest und kommst spät nach Hause, dann ist es doch eine ganz logische Schlussfolgerung, dass

du am Wochenende voll was machst, dich besäufst ordentlich. In der Woche gehe ich arbeiten wie ein Tier, dann ist es klar, dass ich am Wochenende voll einen losmache.

With their weekend activities (they are referring to the soccer riots) the young men escape their daily “rhythm” and an inhuman (“like an animal”) work load, out of which there is no escape and which seems senseless even in a perspective that comprises future generations.

The weekend riots are separated from their weekly routine. Their bracketing of everyday existence remains within temporal limits. This sort of actionism has relatively little influence on the daily lives on weekdays and on the adolescents’ development in general. In the phase of re-orientation one “cannot imagine to do anything like that again”, because “these times are gone anyway”.

Actionisms in which personal identity and biographical prior experiences are largely suspended allow a preliminary group-specific constitution of identity. These actionisms do not rest upon a communicative gathering of informations on others’ identities, abilities, social backgrounds etc. Rather, they provoke knowledge about the other only in the actual practice. The danger of fights and the dependence on the group necessarily enforce cohesion and commonality. “Comradeship” [Kameradenschaft] emerges through the heat of the battle. And after the battle, one might “chat” about experiences during the riots, about elements of a “shared” history. Other areas are largely excluded, though. Later in life, the phase of re-orientation is characterized by an alienation from the earlier actionisms. Within an expanded peer-group the contacts and relations that have formed during the times of actionism fade.

In a similar vein, the euphoria of dancing to techno fades over the years. Looking back, it seems difficult for Bianca and Anna to find a current situation equivalent to their former ‘dancefloor state of mind’:

- Anna:** Dancing so close in brackets, that doesn’t exist anymore. That’s past.
- Bianca:** Yes, it was very pronounced, I thought so. Well there was a lot happening. (.) Yes, when people are dancing with each other, that didn’t look as plump as it looks today. Everyone is stamping for themselves, and everyone has a stressed face, the way it looks today, (.) they all make hectic moves.
- Anna:** (accompanies Bianca with laughter for a moment)
- Bianca:** In those days everyone had a soft smile on their face, and one danced with each other somehow, it was a complete harmony. One stimulated each other further and further well until somehow this yelling came.
- Anna:** Hey, what was happening there sometimes, that’s so hard to imagine today, so perfect. I really like to think of it, it still gives me a lot.
- Bianca:** Well there was a sizzle, when you looked in, just because somehow you didn’t see it like that anywhere else.
- Anna:** Yes, ohh, (.) that was just (.) Drrr.
- Anna:** So, (.) eng eng tanzen in Anführungszeichen, das gibt’s eigentlich fast gar nicht mehr. Das war früher so.
- Bianca:** Ja, das war sehr ausgeprägt, fand ich schon. Also es kam auch sehr viel irgendwie rüber. (.) Ja, wenn die Leute miteinander getanzt haben, also das sah irgendwie nicht so plump aus wie es jetzt aussieht. Jeder stampft vor sich hin, und jeder hat ein gestresstes Gesicht, irgendwie wie’s heutzutage aussieht, (.) haben alle hektische Bewegungen.
- Anna:** (lacht nun für einen Moment begleitend)

- Bianca:** Früher hatte jeder irgendwie nur so'n leichtes Lächeln im Gesicht, und man hat halt irgendwie miteinander getanzt, das war ein totales Zusammenspiel. Man hat sich gegenseitig immer weiter aufgeputscht also bis dann irgendwie dieses Schreien kam oder so.
- Anna:** Hey, was da abging teilweise, das ist für heute so unvorstellbar, so genial. Ich denk da so gerne dran, dis gibt mir heute noch total viel.
- Bianca:** Also es war schon ein Brodeln, wenn man da reingeguckt hat, einfach weil man irgendwie das hat man nirgendwo anders so gesehen.
- Anna:** Ja, ohh, (.) dis hat einfach nur (.) Drrr.

The euphoria and ecstasy of this adolescent phase is “hard to imagine” in retrospect. The then “complete harmony” of bodies is juxtaposed with the plump, stamping non-connectedness of today. The fusion and total involvement has yielded to alienation, almost repulsion. Though the past state seems desirable and one “likes to think of it”, there are neither attempts to rekindle it nor do we find an approach to explain the difference with the present. The great the involvement was, the far away and alien this form of interaction seems in retrospect. The emotional (“soft smile”), physical (“until somehow this yelling came”), and even mental (“didn’t see it like that anywhere else”) involvement is an experience, which seems to elude reflection and communicative elaboration (just “Drrr”)—a characteristic quality for the starting phase of actionisms.

In contrast to breakdancing, but comparable to the actionism of the hooligans, this phase is not followed by any communicative elaboration of the experience. There are no criteria for a successful techno dance, for example. In breakdancing, by contrast, it is—among other features—the authenticity of style that makes a good dancer and thus functions as a quality criterion. In breakdance, the refinement of collective action, of group dancing, necessitates reflection and this reflection calls for faith in the perspective of the other and for the inclusion of (at least) elements of personal identities and individual biographies of the participants.

By comparative analysis we can thus partly locate different types of actionism within a developmental typification. Actionisms without communicative elaboration of personal and social conditions belong to a different developmental phase than the psychosocially more complex actionism of, e.g., the breakdance group.

## **Actionism as a Process Structure of Creative Style Unfolding: A Typological Classification**

The research group gained access to this particular action orientation via participatory observation and analyzing discussions of groups with a shared history of actionism. The mutual corroboration of these sources allowed them to elaborate this orientation. Most important in this analysis was to explicate a body of knowledge, which almost eludes conscious reflection but is essential for collective action: Actionisms are based on a shared performances. They are not structured by conscious decisions, explicit goals, individual opinions, or attitudes. According to the analysis, two generic types of actionism are to be differentiated:

1. Community and shared experiences are provoked by way of self-entanglement and on the basis of the participants' anonymity. Personal identity and one's own history is blinded out. The self-entanglement is limited to particular spatial and temporal spheres. It serves to cope with a typical developmental crisis and stimulates soundings in belonging and commonality. If the actionism stagnates with this exclusion of personal identity, with this strong separation from daily life, and with this pre-reflexive involvement, the experience of belonging remains limited temporally and spatially, too. A more encompassing shared identity is not formed, and the integration of the actionistic experiences into one's own life history remains precarious.
2. When the adolescents's soundings in community and habitual commonality is more successful, elements of personal identity and personal style are more easily integrated. Reflections and evaluations of the collective action set in, allowing to further develop the actionism into more refined forms. This usually goes along with an opening up to context conditions and external influences. Here, actionism is the medium allowing for the development of new collective style elements and orientations that also co-structure other areas of life. In parts, this second type is based on the first type. Hence, both types can be placed into a phase typology.

Moreover, these examples build up towards a development typology, but one that must not be understood as nomothetic. Rather, it is shaped in an always milieu-and culture-specific way and—vice versa—can only be found under specific cultural conditions (e.g., hot cultures with a fast succession of generations). We coin this relation of co-emergence a 'dynamic constitution' (Sluneco & Hengl, 2006, 2007).

## References

- Bohnsack, R. (1989). *Generation, Milieu und Geschlecht – Ergebnisse aus Gruppendiskussionen mit Jugendlichen*. Opladen: Leske und Budrich.
- Bohnsack, R. (2000). Jugendliche als Täter und Opfer. In U. Sander & R. Vollbrecht (Eds.), *Jugend im 20. Jahrhundert* (pp. 316–336). Neuwied und Berlin: Luchterhand.
- Bohnsack, R., Loos, P., & Przyborski, A. (2001). "Male Honor". Towards an understanding of the construction of gender relations among youths of Turkish origin. In H. Kotthoff & B. Baron (Eds.), *Gender in interaction* (pp. 175–207). Amsterdam: John Benjamins.
- Bohnsack, R., Loos, P., Schäffer, B., Städtler, K., & Wild, B. (1995). *Die Suche nach Gemeinsamkeit und die Gewalt der Gruppe – Hooligans, Musikgruppen und andere Jugendcliquen*. Opladen: Leske und Budrich.
- Bohnsack, R., & Nohl, A.-M. (2000). Events, Effervescenz und Adoleszenz. In W. Gebhardt, R. Hitzler, & M. Pfadenhauer (Eds.), *Events. Zur Soziologie des Außergewöhnlichen* (pp. 77–94). Opladen: Leske und Budrich.
- Bohnsack, R., & Nohl, A.-M. (2003). Youth culture as practical innovation. Turkish German youth, 'time out' and the actionisms of breakdance. *European Journal of Cultural Studies*, 6(3), 367–386.
- Buford, B. (2001). *Among the thugs*. London: Arrow.
- D'Andrea, A. (2007). *Global nomads: Techno and new age as transnational countercultures in Ibiza and Goa*. London: Routledge.



- Hitzler, R., & Pfadenhauer, M. (2001). *Technosozologie. Erkundung einer Jugendkultur*. Opladen: Leske und Budrich.
- Nentwig-Gesemann, I. (2006). Regelgeleitete, habituelle und aktionistische Spielpraxis. Die Analyse von Kinderspielkultur mit Hilfe videogestützter Gruppendiskussionen. In R. Bohnsack, A. Przyborski, & B. Schäffer (Eds.), *Das Gruppendiskussionsverfahren in der Forschungspraxis* (pp. 25–44). Opladen: Leske und Budrich.
- Nohl, A.-M. (2001). *Migration und Differenzerfahrung. Junge Einheimische und Migranten im rekonstruktiven Milieuvvergleich*. Opladen: Leske und Budrich.
- Przyborski, A. (1998). Es ist nicht mehr so wie es früher war. Adoleszenz und zeitgeschichtlicher Wandel. In K. Behnke & J. Wolf (Eds.), *Stasi auf dem Schulhof. Der Missbrauch von Kindern und Jugendlichen durch das Ministerium für Staatssicherheit* (pp. 124–143). Berlin: Ullstein.
- Przyborski, A. (2004). *Gesprächsanalyse und dokumentarische Methode. Qualitative Auswertung von Gesprächen, Gruppendiskussionen und anderen Diskursen*. Wiesbaden: Verlag für Sozialwissenschaften.
- Przyborski, A., & Wohlrab-Sahr, M. (2008). *Qualitative Sozialforschung. Ein Arbeitsbuch*. München: Oldenbourg.
- Schäffer, B. (1996). *Die Band – Stil und ästhetische Praxis im Jugendalter*. Opladen: Leske und Budrich.
- Schäffer, B. (2003a). *Generationen – Medien – Bildung. Medienpraxiskulturen im Generationenvergleich*. Opladen: Leske und Budrich.
- Schäffer, B. (2003b). „Ein Blick sagt mehr als tausend Worte“. Zur generationsspezifischen Inszenierung pädagogischer Blickwechsel in Spielfilmen. In Y. Ehrenspeck & B. Schäffer (Eds.), *Film- und Photoanalyse in der Erziehungswissenschaft. Ein Handbuch* (pp. 395–417). Opladen: Leske und Budrich.
- Schittenhelm, K. (2006). Statuspassagen zwischen Schule, Ausbildung und Arbeitswelt. Eine Analyse auf der Basis von Gruppendiskussionen. In R. Bohnsack, A. Przyborski, & B. Schäffer (Eds.), *Das Gruppendiskussionsverfahren in der Forschungspraxis* (pp. 93–107). Opladen: Leske und Budrich.
- Schneider, A., & Töpfer, L. (2000). *Jugendkultur Techno. Jeder tanzt für sich alleine?* Chemnitz: RabenstückVerlag.
- Slunecko, T., & Hengl, S. (2006). Culture and media. A dynamic constitution. *Culture and Psychology*, 12(1), 69–85.
- Slunecko, T., & Hengl, S. (2007). Language, cognition, subjectivity—A dynamic constitution. In J. Valsiner & A. Rosa (Eds.), *The Cambridge handbook of social-cultural psychology* (pp. 40–61). Cambridge: Cambridge University Press.

## Chapter 24

# Dynamic Processes and the Anthropology of Emotions in the Life Course and Aging: Late-Life Love Sentiments and Household Dynamics in Tuareg Psycho-Biographies

Susan Rasmussen

*Ahmed (pseudonym), a Tuareg smith man in the town of Agadez, Niger, related to me how he had encouraged his son to travel to Burkina Faso to sell his artisan works, in order to amass bridewealth for a marriage the father hoped would take place between him and a cousin. But once his son became economically successful there, Ahmed lamented, his son had gone ahead and married, without his father's permission, a Fulani woman he had fallen in love with there.*

*When Ahmed, a widower, himself remarried approximately two years after his first wife died of cancer, he somewhat sheepishly minimized his own romantic love motives, however. Blushing slightly, he denied any romance in this match, insisting, "She (the second wife) has white hair (i.e., her advanced age precluded "romance" in his view)! I married her only so that she can care for my remaining younger children at home...they need someone there."*

In a preliminary way, this vignette suggests a precarious balancing of personal love sentiments and larger economic considerations of benefit to the household over longterm—a reverberating theme in Tuareg love arrangements over the life course. More generally, the topic of love illustrates the limits of participant-observation in ethnography. Love, an affective personal experience whose semiotic signs are expressed in sociability, but are inwardly perceived very subjectively, but also subject to much outsider “meta-commentary” beyond the lovers themselves, is ambiguous. Dynamic study of this emotion poses analytical challenges, but also offers insights into inter-individual and intra-individual variation and change over time, the theme of the present volume. In keeping with this theme and its aim—to bring into one framework various directions of construction of methodology of dynamic processes in the social sciences—the present essay analyzes Tuareg cultural elaborations of late-life love sentiments and attachments in relation to age constructs,

---

S. Rasmussen (✉)  
Department of Anthropology  
McElhinney Hall, University of Houston  
Houston, TX 77204-5080, USA  
e-mail: srasmmussen@uh.edu

thereby situating persons and social groups in their individual cases as they work to produce performance differences (Valsiner, Molenaar, Lyra, & Chaudhary, this volume).

Some anthropologists contend that “romantic” love is experienced universally in all human societies, past and present (Jankowiak, 1995). Others focus more intently upon its local cultural elaborations, expressed in diverse ways, whose meanings are not transparent (Larkin, 1997; Ahearn, 2001; Collier, 1997; Rebhun, 1999; Gutmann, 2003). Attitudes and expectations regarding love over the life course have received some attention in aging and gender studies (Kerns & Brown, 1992; Vatuk, 1992; Lamb, 2000). There is still the need, however, to engage this topic in relation to contradictions between official ideology and public practice vs. personal sentiment and experience over time.

This essay examines cultural attitudes regarding love sentiments in later life against the backdrop of wider political economic transformations in semi-nomadic, Muslim, socially-stratified Tuareg communities of northern Niger and Mali, West Africa.<sup>1</sup> The goal is to contribute insights into late-life sentiments of “romantic love” in anthropology of aging, and also, more broadly in theory and methodology, to integrate studies of subjective personal emotion and expressive culture with political economy. Specifically, the puzzle here is how to interpret “romantic love” sentiments, aging ideals, and late-life attachments in a setting where this sentiment is expressed only indirectly, and where persons culturally defined as “old” (i.e., parents of grown children) are distanced from “romantic love” in public discourse, ritual, and symbolism. I analyze this official distancing between “romantic love” and aged persons, reasons for it, and explore unofficial strategies to negotiate late-life attachments and companionships.

The data show that, although wider socioeconomic and political transformations impinging upon the Tuareg have influenced the landscape of love upon aging, cultural interpretations and personal strategies of love based upon subjective feelings and imagination are equally powerful in shaping local responses to those transformations. Prominent in local cultural interpretations are spirit beliefs and their uses in psycho-social counseling, often expressed in oral narratives and dreams. I examine data I collected—longitudinal case studies, selections from life histories, and spirit-themed narratives as “psycho-biographies,” to borrow Obeyesekere’s term (1981), and show how these constitute local psychotherapy in love problems, shedding light upon dynamics over the life course: intra-individual variation over time and inter-individual variation across contexts.

---

<sup>1</sup> Data for this essay are based on my residence and field research between approximately 1976 and 2007 in Tamajaq-speaking Tuareg rural and urban communities in Niger and more recently Mali, West Africa, and briefly, also among expatriates in France. I gratefully acknowledge support from Fulbright Hays, Wenner-Gren Foundation, Social Science Research Council, National Geographic, Indiana University, and University of Houston in my projects on ritual (spirit possession, mediumship, and divination), healing (herbalism and other specialisms), aging and the life course, rural and urban smiths/artisans, gender, verbal art performance, and theatrical plays.

## Method, Organization, and Argument

Cases and verbal art narratives concerning late-life love open up perspectives on life-span development by situating it in a context of “multiple coexistent time perspectives” (Yamada & Kato, 2006, p. 158). Following a section devoted to ethnographic and historical background on the Tuareg, I examine local cultural values concerning love in general, its contextual meanings and expressions, and ways local residents identify love sentiments. Next, I focus more intently upon love and aging issues in official late-life marriages and re-marriages of older persons, as well as more informal liaisons. I analyze considerations of both love and practicality in these unions, against the backdrop of household dynamics and intergenerational relationships over the life course and cosmological/philosophical spirit beliefs pre-dating Islam. Among the Tuareg, I show, this spiritual dimension is centrally relevant to cultural elaborations of love over the life course: in particular, non-Qur’anic spirits play a prominent psychological role in love, providing comfort and support, but also creating some disturbance. Despite many older persons’ increasing public Islamic devotion (in principle encouraged by, not so much recent pan-Islamic reformist influence, but rather, longstanding Tuareg cultural interpretations of Islam), these spirits powerfully guide interpretations of love sentiments. As manifested in spirit motifs in myths, dreams, and divination-psychotherapy, spirits emerge as a psychological preoccupation, particularly when individuals cope with distant, interrupted, or lost love—common experiences in both longstanding local and changing global predicaments. Spirit beliefs yield insights into both conventional and unconventional love situations of older persons, and oral art about spirits provides anthropology with a “route” for understanding otherwise muted personal sentiments.

There are, in other words, constraints, but also alternative lifestyles available to aging Tuareg lovers in both “tradition” and “modernity” which are often mediated by the idiom of spirit communication, expressed in psycho-biographical and other narratives. Love strategies derive from both longstanding age-related domestic practices and current responses to global pressures: namely, men’s labor migration, state and NGO-engineered pressures for nomads to sedentarize, and recurrent droughts and wars. These pressures, I show, compete with, and affect, local cultural concepts of “romantic” love sentiments and age-related conduct of men and women. Yet local beliefs also actively affect ways elders interpret and cope with these crises.

I make several arguments. “Romantic love”, I argue, is an important sentiment for many older Tuareg, despite constraints of outward public social reserve and “official” religiosity necessary for adapting to household transformations, both micro-community-based and those generated by wider social, economic, and political forces. This reserve embodies an “intra-individual” (Valsiner et. al., this volume) tension between what it means to be an elder, and how to simultaneously be a lover, spouse, parent, and affine. Elders can and do hold these roles simultaneously, but they must mask this simultaneity in public. In contrast to some other cultures—for example, what Lamb reports in Hindu India (2000)—Tuareg do not attempt, over time, to disengage from the household or become ascetic “hermits” in late life in order to prepare for eventual death and rupture from the attachments of life, includ-

ing loved ones. Nonetheless many aging Tuareg couples do ideally emphasize some social distance, for they must be authority figures over their sons-in-law as managers of the domestic household economy in early years of their children's marriages, when residence is often uxorilocal and new grooms must respect their parents-in-law and contribute grain or nowadays increasingly, cash to their household. In current social upheavals from war and drought, which cause lengthier separations and dispersals of loved ones, with less certain reunions than the older seasonal fission and fusions of households in nomadism and caravanning, these kinship roles are becoming more fragmented. This trend has double-edged intra-individual and inter-individual consequences for inter-generational, spousal, and "romantic" love relations over the life course. For youthful men, once dependent upon the mother-in-law's approval for establishing independent married households with their wives, there is now greater freedom—at least for those who successfully benefit from the increasingly monetarized economy in labor migration and itinerant trading beyond subsistence herding, caravan trading, and oasis gardening for parents and parents-in-law. For many older men and women, by contrast, there is diminishing authority over youths—not in itself particularly unusual cross-culturally in global influences (Albert & Cattell, 1994), but nonetheless having interesting local cultural implications for late-life love, which suggest that subjective personal sentiments are not merely a passive outcome of larger-scale forces, but also actively negotiate them.

Secondly, therefore, I also argue that, in order to cope with these political-economic changes, older Tuareg draw upon longstanding, widely-held cultural and religious values in love strategies. The wish to avoid solitude, nostalgia, and the "wild" (*essuf* or *tenere*) figures importantly in psychobiographical landscapes of love, and impacts late-life love and marriage-related decisions. The *Kel Essuf* spirits of solitude or the wild and also *Iblis* the Devil, are culturally-associated with strong sentiments of the soul (*iman*) such as love, jealousy, and anger (Rasmussen, 1995, 2001b). Their association with this sentiment, particularly its illicit forms, tends to discourage potential disruption of domestic authority through elders' unbridled love expression. Love (*tara*), in fact, originates in *Iblis*: a tempter, but also necessary for reproduction (Nicolaisen, 1961). Unrequited love (*tarama*) is believed to make a person's soul (*iman*)—always capable of travel in dreams, which can change one's character (*tasney*)—particularly vulnerable to possession by *Kel Essuf* non-Qur'anic spirits, and thus even more prone to wander in the wild or solitude, a moral wilderness where the individual is suspended precariously between the home moral community of the mother's tent and the spirits' uncertain domain. The *Kel Essuf* and other pre-Islamic spirits, matrilineal spirits, figure most prominently in ritual, healing, and cosmology, but are obscured in official legal domains. On the social plane, too much preoccupation with these beings/forces contradicts and undermines, not solely the official Islamic-Qur'anic religious, but also the familial economic loyalty publicly encouraged by Islam for elders.

Yet the calls of spirits are powerful, and some older persons seek to accommodate them, in effect, undergoing a psycho-analysis through the spirit idiom. These exorcism rituals, already analyzed elsewhere (Rasmussen, 1995), are not the primary focus of the present essay; for although some participants in these public spirit

exorcism rituals are older women, others are adolescents, and not all older persons—men or women—participate in the public exorcism rituals. The focus here is instead upon spirit narratives and imagery in dreams and other expressive culture.

Most people, in fact, tend not to become publicly possessed, and instead treat psycho-social emotional problems—love-related and otherwise—in more private settings of divination, diagnosis, and counseling, conducted with non-Qur’anic mediums and Islamic scholars who specialize in Qur’anic divination. Thus this essay emphasizes more informal and intimate uses of these spirits outside the public ritual context: namely, their deployment in narratives which constitute psycho-social counsel. Longitudinal case studies and selections from life histories often reveal love sentiments indirectly. Only a few discourses in informal conversations address these sentiments more explicitly, since it is considered shameful to directly reveal one’s personal sentiments.

In elders’ cases, moreover, there are additional reasons for such reticence. Aging Tuareg face several contradictions in love matters, on psycho-social, religious, and political/economic levels. Ideally, parents of marriageable or married children must avoid the Kel Essuf and Iblis, beings believed to be present at youths’ evening festivals featuring much flirting and courtship, in order to be closer to the Islamic God (Allah), as elders ideally strive to be, and also, as already observed, in order to distance themselves as household authorities from the secular pursuits of youths. Any association with these non-Qur’anic beings is therefore problematic, since they can disrupt intergenerational relationships by competing with human economic relationships with youths and subordinates. Yet these pressures create double-binds, and data show that elders remain preoccupied with these beings in dreams and in divination sessions analyzing them. I show how Iblis and the Kel Essuf—in principle, opposed to human social civilization but also, paradoxically, offering their own form of companionship—offer a psychologically-satisfying, but sometimes socially-problematic form of alternative companionship, for example, in cases of suspected marriage to a spirit and in the symbolism of dreaming about spirits.

Thus current socioeconomic upheavals create challenges, but also opportunities, for late-life expressions of love: there are both conventional and unconventional love relationships for older persons, in tradition and change. In forging these relationships, older persons draw ideologically upon local psychiatric theories of intimacy, loss, and comfort: these are expressed in the idiom of spirit beliefs.

## **Ethnographic Interlude**

Before continuing, here is it instructive to discuss the history and culture of the Tuareg, sometimes called Kel Tamajaq, who speak Tamajaq, a Berber language, and live predominantly in rural Saharan and Sahelian regions of Niger, Mali, Burkina Faso, Libya, and Algeria. Most are semi-nomadic, combining livestock herding with oasis gardening, artisan work, caravan and other itinerant trading, artisan work, and increasingly now, labor migration and work in tourism. Their pre-colonial regional

political confederations were once stratified into social categories of aristocratic *imajeghen* descent groups, *imghad* tributaries, smiths/artisans called *inaden*, and formerly servile peoples, *iklan*, popularly called Buzu in Niger and Bella in Mali. Islamic scholars, *ineslemen*, popularly called marabouts, are respected and influential in some Tuareg groups, though many groups also retain religious elements pre-dating conversion to Islam between the eighth and eleventh centuries C.E. (Norris, 1975, 1990). Most women may visit, travel, receive male visitors after marriage, initiate divorce, and inherit and manage their own property. In Tamajaq, terms for tent (*ehan*; *aduban*) also denote marriage. To marry is “to make a tent” Women build, own, and keep the tent for life, though in more sedentarized communities, men build, own, and keep the adobe mud house. Brother-sister relationships are strong in most groups, who practice, to varying degrees, bilateral inheritance and descent, integrating ancient matrilineal elements into Qur’anic and central state patrilineal legal institutions.<sup>2</sup> Women control men’s reputations through poetry and song. Rape and wife-beating are considered highly shameful for a man. Men, not women, veil the face.<sup>3</sup> Matrilineal institutions which protect women’s property—mostly live-stock herds—pre-date patrilineal institutions introduced by Islam. Much property is controlled by elders through gradual pre-inheritance gifts and endowments.

These institutions have been modified by colonial and post-colonial state and Qur’anic laws, sedentarization, drought, unemployment, refugee flight, and sporadic armed conflicts between some Tuareg and the governments of Niger and Mali.<sup>4</sup> These wider forces threaten, but also offer opportunities for creatively negotiating personal love sentiments, property arrangements, and psycho-social health over the life course. Hence the tensions between personal love sentiments and political-economic transformations affecting household dynamics and intergenerational relationships.

<sup>2</sup> The endowments of herds and date-palms called *akh ihuderan* (“living milk”) are intended to compensate women for Qur’anic inheritance favoring male heirs. Living milk property is reserved for sisters, daughters, and nieces, and cannot be sold or given to others. See Nicolaisen and Nicolaisen (1997); Worley (1991).

<sup>3</sup> The face-veil/turban (called *tagelmust* in Niger and *asinker* in Mali) that men wear is a sign of male gender-role modesty, and also conveys respect/reserve toward parents-in-law, chiefs, and Islamic scholars. See Murphy (1967) for details. Women do not veil the face, but instead wear, in some regions, a head-scarf, and in others, a robe wrapped “toga” or “sari”-like about the head and body.

<sup>4</sup> The background of the sporadic Tuareg armed rebellions in northern regions of Niger and Mali, the first of which lasted from 5 to 6 years, (approximately from 1990–96), and more recently since 2006, has resurged, is complex. Both nations were formerly part of French West Africa, and there was unequal development of their different regions, resulting in marginalization of Tuareg and other pastoral nomads. Post-colonial governments inherited a set of problems including desertification, drought, unemployment, and tensions between nomads and farmers. For historical background of this conflict, see Bourgeot (1990, 1994); Claudot-Hawad (1993); Dayak (1992); DeCalo (1996). The 1995 and 1996 peace accords in Niger and Mali called for installing Tuareg in functionary and law-enforcement positions in predominantly-Tuareg regions such as Air, Adagh, and Azawak, and increased support of development projects in these regions. More recently in northern Niger, armed conflict has centered around transnational companies in that region and division of uranium resources.

An elder as parent has interests in arranging a child's first marriage, (called a "family marriage,") since this keeps property in the nuclear household and makes bridewealth easier to provide, with less potential for conflict. It is also advantageous to have a married daughter nearby, and a son-in-law who is successful, prosperous, and generous, contributing regularly to his parents-in-laws' household in gifts (Rasmussen, 1997). Aging parents, therefore, attempt to arrange children's first marriages with close relatives, and encourage initial uxori-local residence. Many first arranged marriages between close cousins are viewed as "unromantic," however, and tend to end in divorce, or alternatively, the husband contracts a second, polygynous love-based marriage with an unrelated woman later in life (Nicolaisen & Nicolaisen, 1997).

In the older nomadic system, the parents-in-law in effect, ran the household of recently-married daughters and their husbands somewhat like a firm (Rasmussen, 1987). The new groom was expected to complete bridewealth payments within 2 years of the marriage, and to bring back presents and millet and other goods from caravans to his parents-in-law, which they placed in their storehouse, where he could not look. He was expected to also refrain from eating in front of his parents-in-law, and from pronouncing their names. Although there are some challenges to their authority upon sedentarization of nomads and labor migration of children, the bride's mother remains, to varying degrees, influential in children's marriages: she decides when her daughter's marriage is stable, and if she likes her son-in-law, and then gives permission for her daughter to disengage livestock from her mother's herd, move to an independent kitchen, and if the couple choose to do so, move away in virilocal residence (this latter the usual preference of married men after initial uxori-local residence) (Rasmussen, 1997).

Nomadism and caravanning have always threatened to uproot love relationships, but have also enabled one to find new lovers. I encountered a man considered by others to be permanently insane, whose mental state had allegedly been caused by a former fiancée who had left him for another man during his absence on salt and date caravans. Many divorce cases I recorded were initiated by returning caravanners or labor migrants who accused the wife of extramarital affairs during their absence. New pressures now cause many youths to embark on refugeeing and political exile following droughts and the armed Tuareg rebellions, and to go on labor migration following monetarization, massive unemployment and land-shortages from oasis gardening; many youths now spend longer periods away from home and elders' supervision. This brings both loss and gain: nostalgia for home attachments and independence in love choice for youths and elders alike.

Thus there is no longer a guarantee of late-life unified household, support, or companionship from married children or sons-in-law. Older persons ideally play key authoritative roles in negotiating the marriages and controlling the sexuality and reproduction of others, but their authority in these matters is sometimes contested. Camel caravans, an important rite of passage in gender socialization of adolescent men by older men, have not ceased, but are on the decline from French colonial interference and more recent trucking competition. Young men are also often absent from other rites of passage—for example, babies' namedays—over



which elders preside, but in which youths should also, ideally, participate. Some youths who acquire different values in travel resist parents' arranged marriages, as shown in Ahmed's case, and a few prefer to marry virgins, formerly not important (Gast, 1992; Figueredo, 1993). Thus wider political economic forces, particularly monetarization, offer both challenges and loopholes for negotiating love preferences. Elders feel dilemmas in this, since it is they who must set examples to hold the household together.

## **Anthropological Studies of Emotion and Love Sentiments Over the Life Course**

In anthropological studies of emotions, there is the recognition that these sentiments are personal and subjective, but also socially-constructed (LeVine & Schweder, 1984; Lutz, 1985; Brandes, 1980; Rosaldo, 1989; Abu-Lughod, 1986).<sup>5</sup> Thus love experienced personally does not always correspond neatly to its representations in normative institutional, ceremonial, or narrative practices, and these latter cannot be assumed to transparently reflect personal love experience or expression (De Beauvoir, 1966; Cole, 1990; Collier, 1997; Gutmann, 2003). Many valuable studies (Larkin, 1997; Ahearn, 2001; Rebhun, 1999) explore how even the "individual" expression of love takes on historically and culturally—specific meanings, as inter-subjectively constructed in particular ethnographic settings.

Aging, although a process rather than an emotion, involves sentiments, and thus has certain affinities with love as an anthropological topic. Like love, aging also involves personal experience, and the study of each topic requires sorting out subjective experience, social expression, intra-individual changes over time, and inter-individual variations. In studies of aging and the life course, many anthropologists now agree that cultural elaborations of age do not always conform to literal, external markers such as linear chronology or biology (Albert & Cattell, 1994; Rasmussen, 1987, 1997; Lamb, 2000). Many also recognize the challenge posed by usually finite perspectives of researchers. As Merleau-Ponty (1962, p. 412) notes, time "is not a real process, not an actual succession, . . . but arises from my relation to things". Theories of lifespan development need to be sensitive to the time factor, for example, household dynamics, to facilitate integration of individual levels of life with larger cycles of generations and expressive culture with political economy.

"Romantic love" as a focus remains somewhat peripheral in aging studies (Butler, 1975; Cole, 1990), in part because of anthropological reluctance to impose western cultural labels upon other cultural categories, notwithstanding anthropological interest in shared universals. With few exceptions—namely, works on female aging (Kerns & Brown, 1992; Lamb, 2000; Vatuk, 1992), many anthropological perspec-

---

<sup>5</sup> Also valuable are warnings by anthropologists against making totalizing equivalences between entire cultures and moral and psychological constructs, for example, "honor" and "shame" (Brandes, 1980).

tives tend to ignore or under-theorize the topic of romantic sentiment in late life. Love and aging are usually approached separately, reflecting not solely an academic, but also a popular, cultural bias of “ageism” (Cole, 1990; De Beauvoir, 1966), and perhaps, also, the reticence of some informants/consultants (Butler, 1975).

In aging and gender studies, some researchers have described official practices distancing or discouraging older women from romantic attachments and sexuality, and have inferred from them that, in many non-Western societies, women’s lives appear to “improve” with the onset of age because other earlier restrictions are often “relaxed in middle age” (Vatuk, 1992, p. 155). In studies of Muslim communities, in particular, there is often a tendency to assume that since religion—in this case, Islam—mandates social separation of the sexes until post-reproductive years, based on a fear of childbearing-aged women’s seductive capacity, therefore it follows that greater social freedom of older women always entails greater restriction of their youthful sexuality (Bouhdiba, 1985; Davis & Davis, 1995, p. 220; Tennov, 1979). This stance, however, is problematic because it assumes that there is a monolithic “Muslim world” where uniform gender constructs prevail, but the Tuareg case contradicts these assumptions.

What is needed here is closer attention to the subjective sentiments of both women and men in later life, as these are shaped by, and re-negotiate, household dynamics. What is the connection between ambivalent cultural attitudes toward love sentiments on the part of older persons, their own and others’ experiences and representations of them, and wider social processes?

## Love Sentiments in Tuareg Society

### *Definitions, Attitudes, and Practices*

The Tuareg case is complex. Personal transformations over the life course are not neatly linear or binary. As noted, there is relatively free social interaction between women and men of all ages—(Murphy, 1964; Nicolaisen & Nicolaisen, 1997; Worley, 1991). Recently, however, childbearing-aged women’s traditional freedom to conduct affairs and to initiate divorce may be on the decline from effects of ecological disasters and political violence, which have destroyed much livestock—property owned by women, heretofore a source of their independence (Rasmussen, 2006). Many Islamic scholars believe that a song sung by a beautiful young woman distracts from prayer (Rasmussen, 1995). Yet they do not consider being in love with a woman to be the cause of all evil; nor is love associated with women’s bewitching or forms of sorcery.

In many Tuareg groups, cultural values discourage direct expression of strong sentiments by anyone, regardless of gender or age. Display of sentiments, especially preferences, too openly is believed to invite misfortune. Older persons—particularly older women—tend to be restricted even more stringently from openly sexual or “romantic” expression; for upon one’s children’s marriages, one is culturally-

defined as “older,” and ideally should become more dignified and reserved, as befits a parent-in-law as authority figure. Thus older men and women must cope with a culturally-pervasive psychic tension: of disjunction between outward appearance vs. inner sentiment.

Informal, guided conversations, folktales, poems, and songs convey the cultural importance of “romantic love.” Many couples’ divorces are explained as occurring because they no longer love each other. Youths gather at evening festivals far from the mosque, featuring dancing, songs, flirting and courtship between persons of different social origins who are not supposed to marry (Gast, 1992; Figueredo, 1993; Nicolaisen & Nicolaisen, 1997; Rasmussen, 2000a, 2001a). As yet, few Islamic scholars have heeded calls from pan-Islamist reformist leaders for greater restriction of women. Rather, they attempt to limit the times and places of secular musical festivals and courtship. But mockery discourages women and men alike from expressing love too openly or too soon; sentiments should ideally be expressed through intermediaries, in poems, songs, and teasing games. In poems and songs, love is often expressed through *tangalt*, denoting approximately allusion, metaphor, or as Casajus translates it, “shadowy words” (Casajus, 2000). For example, a lover may be praised indirectly by referring to a stately camel or beautiful piece of jewelry.

Witty conversation is important in early courtship, which may lead to “romantic” (i.e., sexual) love. While sexuality is an important component of love, and many Tuareg conduct pre—and extra-marital affairs, a Tamajaq proverb states, “The woman is for the eyes and ears, not just for the bed.” There is a special Tamajaq term for courtship conversation, *eljimat*: this includes poetry recitation, intense joking/flirting, and playful games intended to display wit. Courtship must occur after sundown, many Tuareg indicated to me, “since the darkness of night alleviates embarrassment, and also because men tend to take liberties they would not during daylight.” But men are not supposed to coerce a woman; she has the right to throw him out of her tent. Later in the relationship, sexual relations may take place, although they must be discreet, and there is a taboo against a woman bearing an illegitimate child.

In addition to *tara*, a general gloss for many types of love, additional terms and concepts convey the special importance of “romantic love.” *Tarama*, unrequited or hidden love is blamed as the cause of much psycho-social suffering: for example, illnesses “of the heart and soul,” and *tamazai*, a kind of depression, which may provoke spirit possession by Kel Essuf “people (spirits) of the wild or solitude” (Rasmussen, 1995). A commonly-heard euphemism for “romantic love” is *tara tan Iblis*, denoting “Devil(derived) love.” Iblis, the Devil, like the Kel Essuf spirits, is directly implicated in love. The following tale I collected from a man in a maraboutique (Islamic scholar) clan develops these themes:

“A very long time ago in the past, there was the Prophet Aghaly who always went to the mosque, and (once) he encountered someone who said, “Where are you going?” Aghaly answered, “I am going to the mosque in order to pray,” and Iblis said to him. “Everyone has (already) prayed, you are late.” And Aghaly returned to pray alone, whereas preferably one should pray in a group, it is more important (more effective a prayer ritual). One day, (again) Aghaly encountered Iblis, who

was telling him (again), “Oh, the people have already prayed.” Aghaly (then) tied up Iblis, he bound him tightly.

“The following night, all the men kept their distance from (i.e., did not have sexual relations with) their wives. In the morning, villagers met for a meeting and exchanged news. They wondered (about this tied-up Iblis), and Aghaly mentioned it was he who had tied up Iblis, and someone told them to untie him. They untied Iblis, and the following night the men again took up sexual relations with their wives, as usual.”

In this tale, which was related to me during gossip about alleged extra-marital liaisons in the community, there are juxtapositions and oppositions between the tying up and untying of Iblis, prayer and sexual love. These motifs express intra-individual conflicts and dilemmas over the communal vs. individualistic aspects of the group. In Islam, one is supposed to pray together in a group; Iblis, in effect, encourages individuals to consider themselves before the group, whereas domestic and wider community group values should have priority. Marriage exemplifies a group value, for it protects the family (Qur’anic patrilineal inheritance interests, and so forth) in controlling reproduction through official marriage (preferably in class endogamy and to a close cousin). Yet paradoxically, Iblis also needs to be untied in order to perpetuate the group, since sexual romantic love is necessary for reproduction. Though sexuality in this tale took place within marriage, there is nonetheless the idea that sexual love and reproductive force depend upon “the Devil unbound,” that is, elements of individual desire. Iblis, present at nightly festivals and during courtship conversation, is believed to incite illicit love affairs (Nicolaisen, 1961)—the topic of the wider conversation that provoked the marabout to relate this tale to me.

Iblis is a “Janus-headed” figure. On the one hand, he is associated with strong personal emotions, danger, and the temptation to violate rules; on the other, he is associated with reproductive force (Nicolaisen, 1961; Nicolaisen & Nicolaisen, 1997), which is necessary but must be controlled through culturally-appropriate channels of expression. There are also hints here of conflicts between Islam and more long-standing Tuareg cultural values permitting greater freedom in gender, sexuality, and marriage contexts. Many Tuareg therefore feel dilemmas concerning the expression of romantic love. One cannot have reproduction without the Devil, but one also needs to control the Devil and sexuality for purposes of the broader social good, in the Islamic emphasis upon the wider moral community. Older persons’ public conduct should ideally exemplify this control, and inspire others toward it in late-life.

Later in life, public conduct should change, especially in communities where Islamic scholars are influential: “old” women and men (i.e., those with marriageable or married children), should ideally give up singing love songs and playing musical instruments associated with youth and courtship, and instead should devote themselves to prayer, almsgiving, sacrifices, and the performance of liturgical music (Rasmussen, 1997). Once their children begin to marry, men tend to wear their customary face-veil higher on the face, and women wrap their head-scarves more tightly about the head, wear simpler embroidery patterns on their clothing, and less jewelry.

In private life, however, some widowed and divorced persons remarry in “old” age, and others have informal arrangements in what I call “alternative or unconventional relationships.” Reasons for such unions and their meanings in terms of love sentiments, as soon shown, are complex.

Elders usually allude to love matters indirectly, through allusion or metaphor (*tangalt*), accomplished in several ways. Most only speak of love in “past tense,” that is, in a remote time in their lives, and tend to publicly emphasize their distance from love in the present. For example, an elderly man in his life history, without my asking directly about love sentiments, nostalgically recalled his youthful flirting with the woman he married: “She came over to her friends... She told them, ‘I want a serious husband.’ And her friends answered, ‘There is no one worth more than Adoum.’ They told me that, and I told them, ‘You know me.’ And the woman from the oasis said, ‘Well, you came in search of a spouse?’ And I said, ‘Is it true you want an eligible, hard-working man? Why is it that you have left your own village without finding one?’ (Rasmussen, 1997, p. 21). Eventually, this couple married. During his youthful flirting, amid practical considerations and overt references to eligibility, work, and economic support, there were also playful jokes and feisty teasing.

This man’s reminiscence emphasizes verbal wit and games between the sexes, particularly during public encounters (at wells, markets, etc.), visits, weddings and other festivals, or via go-betweens, when much preliminary courtship occurs. In relating his divorce later in his life, this elderly man implied that he realized love sentiments were on the wane in his marriage when he and his wife came home and left at different times, in particular, when one spouse was unfaithful.

The same elderly man vividly described how, when his children began to marry, he adjusted his face-veil, wrapping it in the style typical of older men: wearing the lower veil portion higher over the nose, and the upper turban portion more “hood-like” over the forehead. This change to a less flirtatious, more modest and “business-like” manner of wrapping the men’s face-veil signals a readiness for negotiation over bridewealth of children’s marriage. What, then, is the purpose of older persons’ own late-life marriages? How do older persons who marry or re-marry in later life feel about their own unions, and how do others feel about them? In addressing these questions, it is important to address issues of the time factor: changing social/cultural definitions of, and strategies concerning, love sentiments among Tuareg as they become culturally-defined as “older” (i.e., persons who have children who are married or of marriageable age) (Rasmussen, 1997) are fundamental to understanding love relationships in late life.

## **Attachments Over the Life Course**

### ***The Time Factor in Social-Cultural Analysis***

As Valsiner, Molenaar, Lyra, and Chaudhary (this volume) point out, all psychological and social processes are dynamic, and involve both consistency and inconsis-

ency in actions over time. Our inconsistent behaviors and thoughts may appear chaotic, yet there is generality within this highly variable dynamics. Knowing inter-individual variation is necessary—but not sufficient. Current focus on analysis of inter-individual variation in the social sciences has to be complemented by analysis of intra-individual variation over time. The Tuareg data suggest that the high level of diversity and individuality that we see in the social world—high variability and openness to change—are compatible with the existence of general (nomothetic) organizational principles, but these data also show contradictions, dilemmas, and conflicts, revealing time-varying characteristics of the person and emotion.

Recently, the social sciences have explored the nature of time in relation to cultural and historical contexts (Carr, 1986; Valsiner, 1994; Lightfoot & Lyra, 2000). There are multiple cultural elaborations of time and across cultures, and these include temporal perspectives other than Euroamerican linear, irreversible, and historical time (Yamada & Kato, 2006, p. 144). Imaginary worlds and life stories people use to narrate their life and love must be based on local cultural temporal life-course related images, although the “local” does not imply neatly-boundedness; for global forces impinge, to varying degrees in different contexts, upon local imaginations.

Time—whether linear, circular, spiral, or recurrent, implies a certain type of progression from the standpoint of the observer (Diriwachter, 2006, p. 163). Yet progress does not have to be unidirectional. As shown, Tuareg concepts of age are based upon social and ritual roles, rather than literal biological processes or chronological progressions (Rasmussen, 1997). Relevant here are beliefs regarding the soul, which is not static or immutable but rather may change in a person’s lifetime. Concepts of *iman* (soul) have a direct relationship to attitudes toward love sentiments and attachments in later life. The soul is frequently mentioned in sung poetry of the public possession exorcism rituals (Rasmussen, 1995). The soul may rise while the person is asleep, leave the body, and travel, sometimes changing the sleeping person’s character. Thus the concern is to control the wandering soul—in effect, a trope or metaphor (*tangalt*) for love.

“Romantic love” sentiments of aging Tuareg are communicated, often obliquely, through personal histories—longitudinal case studies and more subjective personal narratives, such as life histories. As Frank and Langness (1981) point out, the life history narrative is not the sum total of experience; we remember selectively. To remember something is to re-create and re-construct, in a social ordering of personal experience. Life stories—whether in case studies or autobiographical narrative form—always present a double point of view—that of the research subject/consultant and that of the ethnographer/anthropologist, and often incorporate aspects of belief that cannot easily be corroborated, and may seem impossible or unreal to outside anthropologists (Obeyesekere, 1981; Reed-Danahay, 1997). Typicality is also an issue (Crapanzano, 1980). Nonetheless, life-history or longitudinal case study materials are illuminating when interpreted in ways sensitive to their cultural background.

What also counts as personal history varies cross-culturally, as do means of expressing life histories and personal meanings—for example, memories and

dreams are taken more seriously in some cultural settings than others, and may have a different significance than in classical western Freudian psychoanalysis. Among the Tuareg, memories, as shown, do not necessarily convey a linear past, and often make use of indirect allusion. Tuareg often use dreams to divine or prophesize the future, but not as purely entertainment; they are also used in psychosocial counseling by Islamic scholars and other divination healing specialists (Rasmussen, 2001a, 2006).

Longitudinal case studies and selections from life histories can therefore enhance anthropological understandings of the interplay between personal sentiments and collective practices over time, but the researcher must be sensitive to ways in which cultural elements of and political structures mediate and shape the way people experience, understand, and narrate their own lives.

### ***Tuareg Late-Life Marriage Cases and Underlying Love Sentiments***

Public reserve and modesty notwithstanding, it is acceptable for older persons to discreetly marry and re-marry. Tuareg late-life marriages often involve an intergenerational match with one partner who is significantly older—usually the husband, though not always, as shown in the opening vignette about Ahmed. Either a man or woman may re-marry upon widowhood or divorce, and a man may take up to four wives in polygyny, though many Tuareg women resist this. Late-life first marriages are rare, and those involving women tend to involve the woman marrying an older polygynist. Women who lack independent economic means of support often resort to these marriages, even though most Tuareg women dislike polygyny.

Love and marriage are not, of course, mutually-exclusive, but neither are they equivalent or commensurate. Personal love sentiments in late-life marriages are challenging for outsiders (both younger local residents and outside anthropological researcher) to interpret, for several reasons. One problem is that, on the surface, these cases appear unusual, for different reasons are offered for them than reasons for youths' marriages earlier in the life course, and the symbols in the late-life wedding rituals suggest, on the surface, "unromantic" motives. Ageism, of both local youths and outside researchers, may also impede interpretation here. Furthermore, since many Tuareg elders tend to be reserved and dignified, and ideally should be respected, so eliciting their sentiments and also remaining respectful is difficult.

Longitudinal case studies do not necessarily represent typicality or consensus in social practices, but when integrated with conversations and narratives, they yield some trends, and offer some hints concerning subjective personal sentiments underlying official practice.

For example, one woman, whom I'll call Tana, at around 49 years married for the first time, as second co-wife to a relatively prosperous man of noble origins, approximately 55-years-old, with a garden his son tended in a neighboring oasis, where his first wife resided. Some Tuareg men justify polygyny in this way, as a way of assisting a woman who needs support. Tana had very little property: three

goats, pre-inheritance gifts from her mother, and one female donkey, matrilineal “living milk” property (called *akh ihuderan*) from her mother. To make ends meet, she made and sold palm mats.

Several marabouts explained to me that, “the reason why Tana did not marry for so long was because her parents did not do enough amulets from her adolescence onward, very necessary in order to ensure her marriage.” These specialists, who are active in official marriage negotiations, perform a special divination that is believed to identify compatible marriage partners and “lucky” and “unlucky” families, manufacture Qur’anic amulets worn during life crises for protection, and marry the couple at the mosque. Tana’s family was poor and marginal, and stood outside some influential marriage alliance networks. Mired in poverty for several generations, they neglected to purchase expensive maraboutique divination/advice and amulet protection against misfortune. Over time, their position may have had a “self-fulfilling prophecy” effect, of prolonging her single status into late life.

Many, though not all, late-life marriages are of a special type called *akusi*: between close kin across generations (for example, the niece of a deceased woman marrying the older widower of her aunt) to forge alliances between chiefly noble and maraboutique (Islamic scholar) families serving them. In this custom, however, there are restrictions: a man cannot inherit an older niece or sister of his deceased wife; she must be younger. This inheritance of a wife who is a niece of the man’s former, deceased wife was most frequently practiced in local chiefly noble families, many of whom today are prestigious but poverty-stricken.

Intriguing here are cultural devices that appear to veil and mute the sexuality of these older persons’ official unions. For example, attitudes toward having children in late life are very ambivalent: it is somewhat shameful for a woman and her grown daughter to both be pregnant at the same time, and also for a woman to have more than twelve children. Also, all marriages involving one or both partners defined as “older” and who are re-marrying require what is called a “wedding of calm” (*aduban talamamagh*). This ceremony, analyzed in detail elsewhere (Rasmussen, 2001a), only takes place at the mosque, and omits the evening musical and dancing festival, flirting, ribald singing and drumming featured at youths’ weddings, the purpose of which is to “open” the ears of a young couple marrying for the first time.

Weddings, of course, are not the same thing as marriage, just as funerals, even laments, are not the same thing as grief (Rosaldo, 1989). Wedding symbolism does not exactly reflect marital relationships or personal emotions of love, the latter the concern in this essay—in fact, it may belie, rather than reflect, actual sentiments, or veil intimacy in public. Older persons’ relationships and sentiments in these marriages are therefore difficult to ascertain in ritual and in official discourse (Bourdieu, 1977). Nonetheless, “romantic” love may figure into these marriages. Practical considerations and personal love sentiments are not necessarily mutually-exclusive.

I observed several couples over many years in *akusi* marriages. They appeared to be happy, and did co-habit, that is, reside together. Sometimes children were born to them. Yet outsiders to the marriage tended to minimize “romantic” sentiments: they often either idealized such marriages as convenient, and sometimes even joked



about such marriages, denigrating the partners for being so “old”, sometimes even in their presence. There may also be some underlying shame connected to the poverty or other weakness compelling one partner to marry in that arrangement, who was in effect, unable to contract other marriages with anyone else. This latter explanation was given me explicitly by smiths, who often are go-betweens, concerning some of the *akusi* marriages contracted across the generations and between close relatives. For example, in one arrangement, between a widower and either a niece or younger sister of his deceased wife, the marabouts’ and male nobles’ official explanation was the following: “If a man is very respected and there are women who need a husband, he is supposed to help them by marrying them after his wife’s death.” (Rasmussen, 2001a, p. 296). Women and smiths, by contrast, gave me a very different, unofficial interpretation of this *akusi* marriage: they insisted that such a marriage “is shameful for the woman, because everyone knows she has no (other) suitors!” [Smiths often act as go-betweens in marriage and other delicate matters.]

Yet many *akusi* marriages in fact endure longer than some first marriages by youths. Divorce, as noted, is more common between young couples who are close cousins, who married earlier in the life course (Murphy, 1964, 1967; Nicolaisen & Nicolaisen, 1997; Rasmussen, 1997); it is less common among older persons re-marrying in *akusi* marriages in late-life. The point is that love sentiments are not invariably present or absent in either type of marriage, and it is the close cousin kinship relationship that deters love sentiments, rather than the partners’ age gap per se.

Other conventional late-life unions that also require “weddings of calm” are marriages or re-marriages between two older persons of the same generation, and also polygynous marriages contracted by a heretofore monogamous man. Some older husbands contract polygynous marriages in late life, for several reasons: a first wife’s childlessness, or the husband’s stated view that “the first wife is now old,” and he wishes for a “young bride;” and dissatisfaction with the first marriage arranged by parents to a closely-related cousin.

Until recently, polygyny was rare among most Tuareg (Murphy, 1967; Claudot-Hawad, 1993; Nicolaisen & Nicolaisen, 1997). Women who have the means (i.e., are wealthy in herds) have tended to resist polygyny more, by divorcing a husband who contracts such a match. Also, in more nomadic communities, there is a tendency for women to marry later and limit their number of children. Many couples remain together in monogamy, even if they are childless. With reduced livestock, however, there are pressures toward increasing sedentarization, which in turn brings pressures to bear more children earlier in the household cycle, to provide more workers required in oasis gardening. Most Tuareg women still oppose husbands’ polygyny, but divorce men less frequently for that reason; rather, they insist on separate residences, often in different villages (Rasmussen, 1995, 2006). More and more men who can afford them—particularly Islamic scholars, prosperous merchants, and oasis gardeners in more sedentarized communities—are now becoming bolder about contracting late-life polygynous marriages to non-kin in independent love matches, after remaining for years with in a less-desired marriage to a closely-related first wife. Until recently, men’s polygyny was discouraged by the disapprov-

ing gossip of friends and the resistance of most first wives, who as noted, divorced husbands who attempted these arrangements, and it was considered “inelegant” for a man to request bridewealth reimbursement. Nowadays, however, Islamic scholars rule in favor of the husband keeping the bridewealth upon divorce.

Given these problems commonly faced in late life—of distance, death, divorce, and/or alienation of a partner’s affection, with concomitant pressures to remain dignified in public or risk ridicule—how, then, do older persons cope psychologically? Where overt, direct social expression of intimate sentiments is problematic, the spiritual idiom becomes important.

## Spiritual Psychobiographies of Late-Life Relationships

### *Spirit-Themed Accounts of Disrupted or Lost Love*

Older first wives often suffer from a “broken heart”—this is locally called “an illness of the heart and soul”, a non-organic illness caused by the spirits of solitude or the wild (*Kel Essuf*), which often also leads to spirit possession. Some (though not all) women who become possessed by spirits and undergo the public exorcism rituals do so when their husband contracts a polygynous marriage. Some very elderly women who participate in these public ceremonies are mocked, however, for doing so—again, this expresses the local ambivalence at the incongruousness between their publicly-expressed romantic love sentiments and their ideal reserve with age. Perhaps this is why these public exorcism ceremonies are not, for most older persons, the preferred means for channeling love sentiments. Elders more often tend to draw on spirits to interpret love in more intimate contexts: of divination, dreaming, and other psychotherapy. In dealing with inevitable late-life loss and grief—whether from polygyny, divorce, or bereavement—*Kel Essuf* spirits in effect move in to “fill” the “gap” of loneliness—articulated in the idiom of *essuf*, the wild, solitude, or nostalgia. This is the local idiom for expressing such a condition of loss: spirits are believed to fill empty spaces (called *tinariwen*, sing. *tenere*—the latter also the name of a vast desert plain).

Cases and narratives of lost or disrupted love reveal informal negotiations of late-life love relationships, in both “official” and “unofficial” unions, within and outside formalized healing ritual contexts. First, consider the case of a man in a village in northern Mali, whom I’ll call Soulimane. Soulimane was married twice, and widowed each time. Both his wives died in childbirth. The man was seeking another wife, but encountering great difficulty because no one trusted him: many people believed that he was married to a female *Kel Essuf* spirit. Such spirits are believed to be so demanding that they compete, in jealousy, with the human spouse (Rasmussen, 2001a, 2006).

In Soulimane’s case, local residents tended to be suspicious of, and unsympathetic toward him because several of his wives had died. Thus he lacked social support. Soulimane saw a prominent marabout for an amulet cure, but his spirit illness

was so grave that he had to pay the marabout with his house and compound for further treatment. Still, everyone continued to fear and avoid marrying him. The unfortunate man moved to the outlying countryside to reside in his brother's home.

Marabouts and diviners explained to me that, "A contract with the Kel Essuf spirits is possible, and those who achieve this can become non-Qur'anic diviner/mediums, but this is difficult since it requires making regular sacrifices to these spirits, gaining the trust of the community, and following rules (e.g., keeping very clean and limiting human sexual partners). These relationships are therefore difficult, since they compete with economic and social obligations to the human domestic household." Thus some persons tend to remain in a kind of psycho-social limbo in "illnesses of the heart and soul," and in a state of *essuf*.

Soulimane was somewhat reckless in his strategy for coping with love and marriage problems. He was neither affluent nor socially-prominent, and completely disregarded the disastrous economic consequences. He continued to pay the Islamic scholar/marabout, until he gave away all his material property to him, thereby foreclosing the possibility of a contract with the Kel Essuf.

In a contrasting case, the expression of loss and grief is followed by more successful healing, in an older widow's re-marriage: Tima (pseudonym), a woman in a socially-respected, prominent noble, chiefly, and maraboutique family around Mt. Bagzan in Air, about 50-years-old, with about six children (several of whom were married and have children), had been a widow since around 1991, when her husband, while on salt and date caravans, fell ill and died suddenly. His death far from home, in Hausa country to the South, caused her great pain. Tima eventually re-married, but only after many years of intermittently holding *takote* (sacrificial alms memorial mortuary feasts with collective prayers led by Islamic scholars at the mosque) for her first husband.

Before she held the first *takote*, Tima dreamed of the spirit of her deceased husband. An Islamic scholar, by divining, interpreted her spirit dream as follows: "Your husband has been communicating his wish for you to spiritually bring his soul (*iman*) back home by holding the *takote*." Hence the importance of the spirit motif in this dream, in conveying this widow's love sentiment and grief felt, though not overtly expressed, after his death far away. Yet this *takote* also assuaged the widow's guilt over moving on. For Tima also circulated among others' sacrificial alms distributions/memorial feasts at mosques, where she gave, but unlike Soulimane, she was included in a circle of reciprocity, and also in turn received, like many other elders who participate in these more collective memorial rituals. These activities provide elders with food and sociability, under respectable conditions—somewhat like the difference, in our own culture, between going to a church supper and going to a "singles' bar"—ideally, they allow elders to save face and maintain their authority before youths, although it should be noted here that because they enable this conduct does not imply this is necessarily the conscious motive of elders for attending.

Around 1998, Tima remarried, to a prominent marabout, about 60, who was descended from the revered founding marabout of a local holy place and shrine, and whose family acted as its guardians. It is difficult to ascertain the precise nature of this couple's relationship. Her husband had another, first wife in a distant village. He divided his time between each wife's residence.

Elders' ritual participation therefore accomplishes several goals, albeit not always consciously held. First, in these mortuary memorials, one can express lingering love sentiments toward the lost loved one, and also move onward in healing grief over this loss, through official religious devotion legitimately commemorating the deceased, for here the Islamic is in effect, merged with the local pre-Islamic, non-Qur'anic spirit world compatibly, for elders who must publicly practice "official" Islam. In this context, non-Qur'anic spirits of the dead (discouraged from too overt "worship" by official Islam, but believed in local cosmology pre-dating Islam to be active near tombs and in dreams) are submerged within "official" Islamic devotion, thereby enabling widowed participants to commemorate a lost loved one by practicing religious syncretism. Official Islam discourages too-overt expression of attachment to the dead, or too-unrestrained grief expression as questioning the will of God (Allah). Here, such sentiments may be expressed indirectly by older bereaved persons with dignity.

Participation in these ceremonies also promotes marriage, kinship, and household networks safeguarding elders' security and property. At many of these *takote* rituals' re-distributions of sacrificial alms offerings, older persons are remunerated and compensated over longterm in social support and prestige. Finally, like funerals in some other traditions, the Tuareg mortuary rituals behind their formal structure provide places to meet potential new romantic partners, as well—in dreams as well as in sociability.

Spirits were also active in a dream in another case, not of bereavement or divorce, but rather a "commuting marriage." A primary school director in northern Mali, whom I shall call Moukha, approximately 45-years-old, was married to a woman whom he loved. But his wife was absent from home often and for a more prolonged a time period than in traditional nomadism: she was participating in a training program in the town of Kidal for school personnel, an opportunity not available to most rural Tuareg women. Although he was supportive of his wife's new project, Moukha felt very lonely. He commented on the connections between love, age, and the spirits of the wild or *essuf* by warning, "It is very dangerous to sleep in a room or compound alone because the Kel Essuf spirits enter to fill empty spaces. This can cause nightmares!"

As an illustration, he related a dream he once had: "Once, while my wife was in Kidal for the training session and I was alone, I dreamed that an old woman I had seen in my village came into my room with all-white head, opened her mouth, and then lay down on the bed, beckoning me. I refused to sleep with her in the bed, remaining on the mat, but could not sleep. So I got up and walked outside. But I was still frightened because this is dangerous, too: the Kel Essuf can haunt abandoned places at night that were full during the day, for example, the market, ashes from fireplaces, blood in butchers' and sacrificial sites, etc." [i.e., the old woman might really be a Kel Essuf spirit, recalling a common motif in North Africa (Crapanzano, 1980).]

Marabouts interpreted Moukha's dream as literal physical endangerment from being apart from his wife; Kel Essuf may attack those in solitude or who feel lonely. Couples have always been intermittently apart, it is true, in nomadism and cara-

vanning. But those separations were usually predictable, occurring seasonally in a regular pattern. Nowadays, separations are increasingly unpredictable and irregular in duration, as local residents respond to unemployment, property destruction, and political violence in the region.

On another level, perhaps unconsciously, Moukha did not feel at ease in his wife's tent—built as dowry by the bride's mother and other older female relatives during the wedding, and owned by the married woman, retained even on divorce—without her presence there. Interestingly, the spirit haunting him was represented in the form of a very elderly woman in his dream—an old, not young, female spirit approached him for sexual and marital relations. The spirit in the form of an old woman represented the anxiety and dilemma the man felt between his loneliness and respect for his wife (as manifested in his mentioning the solitary space of her property, the tent), and the temptation he perhaps felt (though did not explicitly mention) to approach other women during his wife's absence. This *Kel Essuf* spirit taking the form of a very elderly woman in effect, was reminiscent of his mother-in-law—as noted, the builder of his wife's nuptial tent, with whom he practices strict reserve—thus a negative reinforcement, or a warning to this man to respect this marital space. Moreover, the figure of the elderly woman also, I argue, expressed this man's ambivalence toward older women more generally as respected authority figures who cannot be juxtaposed onto contexts of sexuality without psychic distress.

Moukha the school director's story therefore expresses ambivalent sentiments and cultural contradictions regarding the anomalous mixing of categories of love and aged status: the man's dream encapsulates these problems, as well as his immediate loneliness during his wife's absence in the town—regarded ambivalently as a place of economic opportunity, but also moral temptation, and the husband's remaining at home in the village—itself now transformed into a place of equally problematic moral dilemmas.

Similar spirit imagery and sentiments concerning disrupted love emerge in the next case: Amina (pseudonym), approximately 45, had been married and divorced several times, and had several children. She resided in a semi-nomadic and multi-ethnic village. Her two bridewealth camels died in droughts. Amina's two daughters lived with her Arab ex-husband. [Usually among Tuareg, the children remain with the mother in divorce, but in rare cases, for example marriage to ethnic outsiders, the father receives custody]. Amina resided in the compound of her mother, a woman of advanced age, who during one rainy season was absent, recuperating from a broken leg in a distant hospital. Like all divorced Tuareg women, she retained her nuptial tent, located behind the house in her mother's compound. Amina had a sweetheart, but he was sometimes absent on travel to obtain goods for his shop. During his absence, Amina complained to me of sleeplessness, lamenting, "I am in *essuf* (the wild)," (i.e., suffering from nostalgia, solitude, and symptoms western allopathic medicine would call insomnia). She asked to sleep nearby in the compound adjoining my *chambre de passage* to alleviate this problem. Alternatively, she explained, "a small child can offer protection from *Kel Essuf* spirits if the child sleeps in the same room or compound with an adult during a spouse's or sweetheart's absence." Yet unfortunately, Amina's children were with her ex-husband.

The predicaments in the foregoing cases and life history selections show the importance of personal emotional needs for different types of late-life companionship, including “romantic” and other types of love, but also reveal constraints in the social construction of “romantic love” in late life. The desire of some older women for an extramarital partner has to do with filling a void—the empty space, *essuf* (or *tenere*) of disrupted ties to children. The desire of some older men, as well as women, for a partner is articulated in terms of these notions of *essuf*, its spirits, Kel Essuf, and their need to distance themselves from, yet accommodate, their solitude. Men and elders of either sex are in principle supposed to be closer to Islam and farther from the non-Qur’anic spirits than women and youths. Ideally, also, one should be faithful to one’s absent spouse—the occurrence of extramarital affairs, as observed, is tacitly tolerated but also causes personal pain for the jilted spouse, and can affect the children. *Essuf* is not solely literal space—the wild outside villages and camps and the tent if it is abandoned—but also a psycho-social state of mind.

Additional reactions to disruptions of marriage and “romantic love” emerge in the final case study and narrative, which reinforces these points and illustrates further connections between non-Qur’anic spirits (here unnamed matrilineal spirits) and love conflicts. An older woman I shall call Takhia, about 55, shared with me her views concerning men’s polygyny, women’s extra-marital affairs, and a “broken heart”:

Takhia and her brother Salikhou (pseudonyms) were orphaned when very young. They were raised by extended kin, mostly their aunt. This family had some herds outside their town, Kidal, in the Adar-n-Ifoghas region of Mali, and relatives divided their time between this town and the countryside according to season. They had experienced much uprooting and dispersion in refugee flight during the 1990–1996 Tuareg rebellion. Takhia had lived in Nouatchott, Mauritania, with her most recent Arab husband during the rebellion, and then in Morocco briefly as a refugee. Salikhou was in Burkina Faso during that conflict. Takhia and Salikhou were both divorced by 2002, and now lived with the latter’s two small children for most of the year in the same compound.

In informal conversations, Takhia related her marriage histories to me: “My first husband was a cousin; our fathers were brothers. He left another woman for me, but later reconciled with the other woman, so we divorced. My second husband was a Bambara soldier. I lived with him in Bamako for about 4 years, had two children, one a girl, who died. My son is now about 20-years-old, but I have not seen him for 8 years I liked Bamako, but prefer Kidal because my relatives are here. So, we divorced, and I returned here until the Tuareg rebellion broke out, when I had to flee to Mauritania (where there were refugee camps). My third husband, the Mauritanian Arab, took good care of me: he bought me things and got Bella (former slaves) to do housework. I liked Nouatchott, but my husband contracted a polygynous marriage, and I opposed this. So we divorced. I returned here, but at the borders, I had great difficulties. Some customs agents and soldiers stole my jewelry.”

Takhia lamented, “all men fool around. Yet women, also, may do this.” She related how her brother Salikhou’s ex-wife allegedly became involved romantically during her husband’s absence on travel for medical care. Although she lived nearby

with her uncle, she did not visit her children often. Takhia disapproved of this extra-marital liaison, not solely because it hurt her brother, but because it was so distracting that the ex-wife allegedly stopped breastfeeding her son. Takhia raised him with goats-milk, and she beamed with pride that “the children call me *anna* (mother) now.” She frequently mock-breastfed the younger child, a boy of about 18 months.

Here, as in India and parts of the Middle East (Lamb, 2000, p. 75), a mother’s milk is also a special substance, mixed with the mother’s love and distilled from her body’s blood, which creates a great pull over children. Thus despite the generally tacit tolerance of extra-marital affairs, there is shame attached to sexual relations before a child is weaned. Indeed, even within marriage, there is a postpartum sexual taboo between parents for approximately 2 years; if this is broken, it is believed that a child thus conceived will have a defect. Salikhou’s sex—wife’s affair while her then-husband was absent was criticized primarily because she abandoned her two young children; the younger child was not yet weaned. The ex-wife kept the bridewealth, but her former sister-in-law accused her of “denying him (the younger child) milk.” The ex-husband received custody of their children, and he gave them to his sister to raise.

Takhia explained some discipline problems she was having with the older son, about 4-years-old, as a consequence of matrilineal descent ties: “he inherited the character (*tasney*) of his mother’s side (*tedis*, literally also stomach). That explains his sometimes naughty behavior, because his mother is bad.” When I suggested that perhaps the boy had experienced trauma on his parents’ divorce, she responded that she did not believe the boy was hurt by his parents’ divorce, “...only older children are hurt by this, not younger children.” Yet she opposed her brother’s plans to send him to school in Gao because she loved the child.

Thus the older child’s character, believed to derive (matrilineally) more fully from his mother who had breastfed him, was explained by the aggrieved husband’s sister in terms of the mother’s alleged anti-social conduct. Here, in effect, matrilineal descent and spiritual ties were polluted by the ex-wife’s breaking of the sexual taboo and denial of milk. Matrilineal spirits are important in mother-child ties: for example, the child’s maternal grandmother confers a non-Qur’anic name on the child in an unofficial naming ritual, with references to both Islam and pre-Islamic matrilineal spirit pantheons, that takes place near the mother’s tent before the “official” Qur’anic naming ceremony at the mosque (Rasmussen, 1997). Medicinal trees are occupied by matrilineal spirits who require periodic offerings by herbalists (Rasmussen, 2001c, 2006). Spirit possession illnesses are believed to be inherited through the mother’s milk.

Also significant in Takhia’s situation is the strong brother-sister tie; both siblings fall back on this for economic support and residence during disruptions in their love and marriage, and during times of hardship, namely drought and war. Following separation, siblings often yearn to return and reside close by each other. Separation in pastoral nomadism is a prominent theme in folk tales, songs, and poems. In this, not solely romantic love and sexuality, but also love between brothers and sisters, is often threatened. A prominent tale-type motif is one of brothers searching for lost sisters who are missing, and sometimes abducted by the devil, Iblis, or by a spirit,

who attempts to make them his wife (Rasmussen, 2006). Casajus (1987, 2000) has analyzed prominent sibling incest imagery as matrilineal symbolism in these tales, expressing the double-bind between the brother-sister and spousal tie in the currently bilateral system in many Tuareg groups. Nicolaisen and Nicolaisen (1997) describes a wedding game of “tug-of-war” over the stomach of the sacrificed animal, which, according to this author, also symbolically expresses this conflict and struggle between matriliney and patriliney.

In this light, brother-sister love imagery in Tuareg folktales and its more subtle expression here in Takhia’s strong sentiments suggest that, while love romantic between lovers, sweethearts, and married couples is distinct from that between siblings, nonetheless there is some underlying tension between loyalty to siblings, on the one hand, and marital obligations, on the other, in the currently-bilateral system, with its older matrilineal influences pre-dating Islam and patriliney. Siblings, even with few resources, should come to each other’s aid and comfort, to provide moral support in “romantic love” disappointments.

## Conclusions

The foregoing analysis has explored personal viewpoints, diverging practices, and ways of negotiating official public distancing of Tuareg elders from romantic love sentiments through cases and narratives. Among them, spirit psycho-biographies offer particularly vivid insights into the management of emotions experienced powerfully, but expressed subtly.

Love and aging constitute two major strands in all human experience. Their juxtaposition in social/cultural analysis offers insights into both subjective experience of emotions and their cultural expression (and suppression) over time, in domestic dynamics over the life course and in larger-scale political economic change. The personal love sentiments of older Tuareg are often obscured by the “official” reasons for marrying or not marrying, and by their efforts to manage intergenerational relationships, in particular, changing parent-child relationships from the impacts of both local household dynamics and global forces. In negotiations of personal sentiments and wider constraints, love sentiments and aged status are kept apart in public cultural imagery, even as they remain interconnected in inner spiritual life over the life course. Spirits often become the medium of communication of love sentiments in times of crisis, channeling them in ways appropriate to the socioeconomic and religious roles of older persons, and providing a psychologically-meaningful explanation of love predicaments, if not always completely resolving them.

Population upheavals, increasingly distant and lengthier travel of youths, larger concentrations of sedentarized communities with land shortages, and diminishing animal herds now make it risky for elders to rely solely upon adult children and livestock-supported networks of prosperity and prestige for late-life support and companionship. These conditions bring new dilemmas into elders’ longstanding double-bind predicaments in love and marriage. There are tensions—both long-



standing and recently-emerging—between the need for social and economic support, on the one hand, and the limbo produced by competing religious beliefs and psycho-social pulls concerning Iblis, the Devil, the Kel Essuf and other spirits, and official Islamic devotion, the latter emphasizing family and household unity, but also allegiance to a wider community beyond the old social strata and (originally matrilineal) descent groupings.

More broadly, studies of love and aging can illuminate both structural and anti-structural aspects of life in a dynamic, time-based analysis of personal sentiments. Subjective experience, social expression, and political economy intersect in balancing personal and socio-economic concerns.

## References

- Abu-Lughod, L. (1986). *Veiled sentiments*. Berkeley: University of California Press.
- Ahearn, L. (2001). *Invitations to love: Literacy, love letters, and social change in Nepal*. Ann Arbor: University of Michigan Press.
- Albert, W. M., & Cattell, M. (1994). *Old age in global perspective: Cross-cultural and cross-national views*. New York: G.K. Hall.
- Bouhdiba, A. (1985). *Sexuality in Islam* (A. Sheridan, Trans.). London: Routledge and Kegan Paul. (Original work published 1975)
- Bourdieu, P. (1977). *Outline of a theory of practice*. Cambridge: Cambridge University Press.
- Bourgeot, A. (1990, October–December). Identite Touaregue: de l'aristocratie a la revolution. *Etudes Rurales*, 120, 128–162.
- Bourgeot, A. (1994). Revoltes et rebellions en pays touareg. *Etudes de l'Afrique contemporaine*, 170(2), 3–19.
- Brandes, S. (1980). *Metaphors of masculinity: Sex and status in Andalusian folklore*. Philadelphia: University of Pennsylvania Press.
- Butler, R. (1975). *Why survive? Being old in America*. Baltimore: Johns Hopkins University Press.
- Carr, D. (1986). *Time, narrative, and history*. Indianapolis: Indiana University Press.
- Casajus, D. (1987). *La Tente Dans l'Essuf*. Cambridge: Cambridge University Press.
- Casajus, D. (2000). *Gens de la parole*. Paris: Editions la decouverte texts a l'appui/anthropologie.
- Claudot-Hawad, H. (1993). *Touaregs: Portrait en Fragments*. Aix-en-Provence: Edusud.
- Cole, T. (1990). *The journey of life*. Cambridge: Cambridge University Press.
- Collier, J. (1997). *From duty to desire*. Princeton: Princeton University Press.
- Crapanzano, V. (1980). *Tuhami. Portrait of a Moroccan*. Chicago: University of Chicago Press.
- Davis, D. A., & Davis, S. (1995). Possessed by love: Gender and romance in Morocco. In W. Jankowiak (Ed.), *Romantic passion: A universal experience?* (pp. 219–139). New York: Columbia University Press.
- Dayak, M. (1992). *Touareg: La Tragedie*. Paris: Editions Jean-Claude Lattes.
- De Beauvoir, S. (1966). *The coming of age*. New York: W. W. Norton & Company.
- DeCalo, S. (1996). *Historical dictionary of Niger* (3rd ed.). Lanham, MD: The Scarecrow Press.
- Diriwachter, R. (2006). Commentary: The wandering soul in relation to time. *Culture and Psychology*, 12(2), 161–169.
- Figueredo, C. (1993). Identite et concitoyennete. La reelaboration des relations entre hommes et femmes aux marges de la societe Kel Adagh (Mali). In H. Claudot-Hawad (Ed.), *Touaregs et autres sahariens entre plusieurs mondes* (pp. 113–137). Aix-en-provence: Edisud.
- Frank, G., & Langness, R. (1981). *Lives: An anthropological approach to biography*. Novato, CA: Chandler and Sharp Publisher.

- Gast, M. (1992). Les relations amoureuses chez les Kel Ahaggar. In T. Yacine (Ed.), *Amour, Phantasmes et sociétés en Afrique du Nord et au Sahara* (pp. 151–173). Paris: l'Harmattan-Awal.
- Gutmann, M. (Ed.). (2003). *Changing men and masculinities in Latin America*. Durham: Duke University Press.
- Jankowiak, W. (Ed.). (1995). *Romantic passion: A universal experience*. New York: Columbia University Press.
- Kerns, V., & Brown, J. K. (Eds.). (1992). *Prime: New views of middle-aged women*. Urbana and Chicago: University of Illinois Press.
- Lamb, S. (2000). *White saris and sweet mangoes: Aging, gender, and body in North India*. Berkeley: University of California Press.
- Larkin, B. (1997). Indian films and Nigerian lovers: Media and the creation of parallel modernities. *Africa*, 67(3).
- LeVine, R., & Schweder, R. (Eds.). (1984). *Cultural theory: Essays on mind, self, and emotion*. Cambridge: Cambridge University Press.
- Lightfoot, D., & Lyra, M. C. D. P. (2000). Culture, self and time: Prospects for the new millennium. *Culture and Psychology*, 6, 99–104.
- Lutz, C. (1985). Ethnopsychology compared to what? Explaining behavior and consciousness among the Ifaluk. In G. White & J. Kirkpatrick (Eds.), *Person, self, and experience: Exploring Pacific ethnopsychologies* (pp. 35–79). Berkeley: University of California Press.
- Merleau-Ponty, M. (1962). *Phenomenology of perception* (C. Smith, Trans.). London: Routledge & Kegan Paul.
- Murphy, R. (1964). Social distance and the veil. *American Anthropologist*, 66, 1257–1274.
- Murphy, R. (1967). Tuareg kinship. *American Anthropologist*, 69, 163–170.
- Nicolaisen, J. (1961). L'Essai sur la religion et la magie touaregues. *Folk*, 3, 113–160.
- Nicolaisen, J., & Nicolaisen, I. (1997). *The pastoral Tuareg*. Rhodos, Copenhagen: The Carlsberg Foundation.
- Norris, H. T. (1975). *The Tuareg: Their Islamic legacy and its diffusion in the Sahel*. London: Aris and Phillips.
- Norris, H. T. (1990). *Sufi mystics of the Niger desert*. Oxford: Clarendon Press.
- Obeyesekere, G. (1981). *Medusa's hair*. Chicago: University of Chicago Press.
- Rasmussen, S. J. (1987). Interpreting androgynous woman. *Ethnology*, 26, 17–30.
- Rasmussen, S. J. (1995). *Spirit possession and personhood among the Kel Ewey Tuareg*. Cambridge: Cambridge University Press.
- Rasmussen, S. J. (1997). *The poetics and politics of Tuareg aging: Life course and personal destiny in Niger*. DeKalb, IL: Northern Illinois University Press.
- Rasmussen, S. J. (2000a). Between several worlds: Images of youth and age in Tuareg popular performances. *Anthropological Quarterly*, 73(3), 133–145.
- Rasmussen, S. J. (2001a). Wedding of calm, wedding of noise: Aging performed and aging misquoted in Tuareg rites of passage. *Journal of Anthropological Research*, 57, 277–303.
- Rasmussen, S. J. (2001b). Grief at seeing a daughter leave home: Weeping and emotions in the Tuareg *techawait* ceremony. *Journal of American Folklore*, 113(450), 391–421.
- Rasmussen, S. J. (2001c). *Healing in community: Medicine, contested terrains, and cultural encounters among the Tuareg*. Westport: Bergin & Garvey.
- Rasmussen, S. J. (2006). *Those who touch: Tuareg medicine women in anthropological perspective*. DeKalb, IL: Northern Illinois University Press.
- Rebhun, L. A. (1999). *The heart is an unknown country: Love in the changing economy of north-east Brazil*. Stanford, CA: Stanford University Press.
- Reed-Danahay, D. (1997). *Auto/ethnography: Re-writing the self and the society*. London, NY: Berg Press.
- Rosaldo, R. (1989). *Culture and truth*. Boston: Beacon Press.
- Tennov, D. (1979). *Love and limerance: The experience of being in love*. New York: Stein and Day.
- Valsiner, J. (1994). Irreversibility of time and the construction of historical developmental psychology. *Mind, Culture, and Activity*, 1, 25–42.

- Vatuk, S. (1992). Sexuality and the middle-aged woman in south Asia. In V. Kerns & J. Brown (Eds.), *Prime: New views of middle-aged women* (pp. 155–173). Chicago and Urbana: University of Illinois Press.
- Worley, B. (1991). *Women's war drum, women's wealth: The social construction of female autonomy and social prestige among Kel Fadey Twareg Pastoral Nomads*. Ph.D. dissertation. Morningside Heights, Columbia University—NY.
- Yamada, Y., & Kato, Y. (2006). Images of circular time and spiral repetition: The generative life cycle model. *Culture and Psychology*, 12(2), 143–161.

# Chapter 25

## Synthetic Phenomena and Dynamic Methodologies

Jytte Bang

In this chapter, dynamic methodologies are viewed as empirically and theoretically informed tools which help the researcher to study developmental processes. Dynamic methodologies will be discussed from an ecological perspective, that is, by taking seriously the individual—environment reciprocity as *the* unit of analysis. This perspective brings into focus the issue of atomism/elementarism which assumes rigid distinctions between sensations, thoughts, and acts. Dewey (1896) already addressed the problem when he said that according to such assumptions, sensory stimulus, the central activity (standing for the idea), and the motor discharge (standing for the act proper) are three different kind of things.

It is obvious that synthetic phenomena are common in everyday lives of people. Elementarism is unable to address such phenomena and so one possible way for psychology to move beyond the influence of elementarism is to study synthetic phenomena both empirically and theoretically. Dynamic methodologies must rest on theories which are able to conceive the wholeness nature of psychological processes. This is best done by studying the ecology of everyday life of humans.

### Where Traditional Methods Fail—In the Study of Development

Various criticism raised against experimental research and its implications for the study of developmental processes already has led to a major focus on the study of the everyday life of children and the study of natural settings in which children live their lives together with people who are important to them. Bronfenbrenner (1977) famously articulated the basic ecological standards for the study of developmental processes when he said that much psychology is the science of the strange behavior of children in strange situations with strange adults for the briefest possible periods

---

J. Bang (✉)  
Department of Psychology  
University of Copenhagen  
DK-1361 Copenhagen, Denmark  
e-mail: jytte.bang@psy.ku.dk

of time. In his demands on an ecological science of development he echoed the quest for ecologically based child studies formulated and brought into life by Barker and Wright's (1966, 1968, 1971) 1940ies study of Raymond and other children living in the town Midwest in the USA. What Barker and Wright and Bronfenbrenner agreed upon was to formulate alternatives to the unfamiliar and artificial nature of laboratory experiments. Even earlier, Vygotsky (in the early 1930s) derived his likewise famous concept *the zone of proximal development* (Vygotsky, 1978) from a critical discussion of the limitations of measurements which, he concluded, would have no prediction value with regard to the future development of a child (Valsiner & van der Veer, 1993; van der Veer & Valsiner, 1991). In his work with the zone of proximal development Vygotsky was explicitly occupied with the dynamic issue of psychological processes. The ideas formulated by those ecological and cultural-historical thinkers have informed and inspired generations of researchers of child development so that it has become common and natural to study child development by studying how the child lives her everyday life (see e.g., Tudge, Putnam, & Valsiner, 1990; Still & Costall, 1991; Cole, 1997; Valsiner, 1997; Valsiner & van der Veer, 1993; van der Veer & Valsiner, 1991, 1994; Heft, 1988, 2001; Chaiklin, Hedegaard, & Jensen, 1999; Hedegaard, 2002; Stetsenko, 2004, 2005; Tudge, 2008). However, empirical studies rarely solve theoretical problems.

## Ecologizing Developmental Studies

The change to ecology in developmental science implies a need to re-conceive the unit (or units) of analysis in psychology. Obviously, the unit of analysis can no longer be the child as an isolated individual with the focus on what goes on 'in the head' of the child. And the child's exchange with her environment can no longer be studied as a mechanical exchange with the child as one unit (element) inter-acting with a certain amount of other environmental (including social) units (elements). Or can it? Why should not the very old belief that the individual is the unit of analysis or the—likewise very old—belief that stimulus—response processes define psychology be able to survive attempts to ecologize developmental studies? We may, for instance, study child development by studying how a child responds to factors which she is exposed to in her natural environment. Or, we may acknowledge complexities and study how a broad variety of factors have an impact on the life of a family and how family members respond to those different social stimuli; or we might acknowledge diversities and study how 'cultures' impact children's lives in different ways and how the children responds back, etc. Such studies may very well count as ecological on the laboratory—everyday life opposition, yet they remain un-ecological when seen from the mechanical—dialectical contrasting view.

The laboratory—everyday life contrast refers to the difference between research which studies children within those conditions criticized by Bronfenbrenner and those everyday conditions in general supported by ecologists. The mechanical—

dialectical lens is suggested as a supplement because the term of ‘everyday life’ in itself does not protect against the ideas of treating phenomena in terms of mechanical causal models. These models lead to seeing the static side of everyday phenomena. In contrast, the ‘dialectical’ end of the scale proposes ‘everyday life’ to be greatly dynamic suggesting that no single part can be studied in isolation from other parts or be fixed in time and space. ‘Everyday life’ has systemic properties and in her studies the researcher should expect to find ways in which people co-constitute and change conditions of life in meaningful ways rather than any simple cause—effect relation. Both contrasts are needed for psychology to get beyond its elementaristic and stimulus—response approaches to psychological phenomena. In fact, we all deal with basic beliefs which are very hard to get beyond. To get beyond them one must try to *perceive* and to *think* beyond them, try to take seriously, what are the needed theoretical and methodological consequences of that which is the basic unit of analysis of ecological psychology: *the individual—environment reciprocity*. The somewhat paradoxical question to answer is *how to still study the individual child’s development while not having the child as a unit of analysis?*

In the present Chapter I approach this paradox by following the advice of Costall (2007) who finds that when wrestling with persistent problematic core-beliefs it might help to set the clock back in psychological theory. Let us take seriously the individual—environment reciprocity and its theoretical and methodological implications—and look back to Ehrenfels’ notion of Gestalt qualities, Baldwin’s dialectical notion of self, and to Gibson’s notions of direct perception and affordances. My reason to pick out those theories in particular is that *whole-ism* seems to form a natural alternative to individualism and Gibson’s theory encompasses Gestaltist as well as functional theory. So, I shall address the quest for dynamic methodologies by first addressing the basic issue of elementarism to which Ehrenfels as well as Gibson opposed.

### ***Problems with Elementarism***

What does one need to face in the attempt to develop and advance *dynamic* methodology? Developmental psychology has struggled with this question over decades. Firstly, it is not easy to conceive developmental phenomena in developmental ways. Describing landscapes of behaviour and organization, looking for differences or similarities and describing them, in short, painting pictures of what was, what is, and what might become is an obvious endeavour which, in itself, does not ensure a developmental perspective. What Davydov (1977) calls ‘empirical generalizations’ may very well stick to these descriptions. Secondly, this habit of making descriptions and operating within fields of categorizations is not just due to the practical constraints of empirical research. The habit of *cutting into pieces*—where one’s hope is to clear the sight of the researcher—is deeply problematic because it is based on the discourse of *elementarism* and, in general, the habit of dichotomizing phenomena that are mutually related.

The core problem in psychology related to elementarism is that of *the individual and private mind*. In western thought, the individual stands out by herself and it is broadly assumed that development is a process of separating oneself from other persons (parents) and from the restrictions set up by concrete material. Freedom of the individual is a core value and development is successful to the degree that this is the result. A child should grow to become independent in action and in thought. The values of freedom and independence on a societal level fit well with the epistemology following elementarism and the result is a struggle about how to define dynamic inter-relations when one has individualism as a starting point. Formulations like *the problems of elementarism* or of *the problems of dualism* indicate a negative stance, i.e. a position of pointing out the danger, limitations, and restrictions of an influential paradigm. A negative and critical stance is absolutely necessary. However, one needs to focus also on the negations of the critique, the possible positive outcome of critical reflections; what is needed is a positive stance, i.e. a position which allows theorists to move from a situation with the future negatively defined on the bases of critique to a situation with positive definitions of the field of psychology. The overall question is how to move from anti-elementarism (negative stance) to a dynamic psychology (positive stance).

### ***On Dynamic Methodologies***

To move dynamic methodologies forward along this line implies that it must be based on dynamic theorizing as well as dynamic perceptions and analysis of developmental phenomena. Dynamic methodologies are those which link between dynamic theories of life and dynamics of life—they are concerned with the question of how to work with dynamic theories of dynamic life. Hence, bringing forward dynamic methodologies in the first place means acknowledging the dynamic nature of human life—the idea that dynamic realities are heterogeneous and disharmonious synthesis and that the unit of analysis therefore should be the wholeness patterns of such heterogeneities and disharmonies while *also* being able to keep the individual in focus. Bringing forward dynamic methodologies further means that approaches to empirical studies should refer to foundational ecological theory which, in addition, is able to overcome the habit of dichotomizing phenomena; a habit which persists with the persistent influence of elementarism. Dynamic methodologies might be successful when based on both ecological demands—studying the everyday life of children and studying the dynamic nature of that everyday life. I shall argue in the present paper that this dialectical ecological approach helps bring the individual out of the idiosyncratic private space which elementarism dooms her to stay within. Phenomenologically experienced psychological events are non-private not only in the sense that individuals can share their thoughts, feelings, and actions with others but also in the sense that those thoughts, feelings, and actions always-already originate in societal and social processes. The question of how to move from the

somewhat general and abstract statement that ‘humans are societal/social beings’ to the more concrete determinations of what this in fact means and how it impacts research, is a hard question to answer.

### ***The Problem of the Either-Or***

When viewed in relation to dynamic methodologies, the main problem concerning elementarism is the *either-or discourse*, that is, the acceptance of the ‘law of the excluded middle’ in Aristotelian logic and the denial of the ‘synthesis’ in terms of the Hegelian logic. However, if we turn the clock more than a 100 years back to Baldwin, we find that he was deeply concerned with conceiving dialectical phenomena in dynamic (in fact dialectical) terms (Valsiner, 2008). In much of his writings, Baldwin wrestled with the notion of *self* in quite a dynamic way trying to base the notion of self on dialectical processes (Baldwin, 1897, 1899/1973, 1906, 1908, 1911, 1915; Baldwin, 1930).

Let us consider an example similar to Baldwin’s elaborations. If I (a child) think of a friend who possesses certain skills (e.g., reading well and being great at skateboarding), I may experience myself as someone who does not yet have access to those skills but might myself want to become able to read more smoothly and enjoy the pleasures of skateboarding. I know that I will have to get started with practicing and I begin the hard work to transcend my own borders of skills and of self-understanding. After a hard period of time filled with much self-challenging creative imitation of my friend’s skills I am slowly learning and now think of myself as someone who reads more smoothly and who is able to skateboard if not great then acceptable. I can feel somewhat proud of myself and feel that it is I who now possess those skills. Baldwin points out, however, that I think of myself only by thinking about my friend whom I wanted to become like and whom I tried to imitate. When I think of myself, I think of my friend or, as Baldwin states in general terms:

...each and all of the particular marks which I now call mine, when I think of myself, has had just this origin; I have first found it in my social environment, and by reason of my social and imitative disposition, have transferred it to myself by trying to act as if it were true of me, and so coming to find out that it is true of me. And further, all the things I hope to learn, to acquire, to become, all—if I think of them in a way to have any clear thought of my possible future—are now, before I acquire them, simply elements of my thought of others, of the social alter, or of what considered generally we may call the “socius” (1897, p. 342).

Baldwin finds that the notion of self should be conceived as a dialectical self—alter notion. ‘Self’ is not to be determined in isolation; it is not an element and cannot be a unit of analysis. On the contrary, in thinking of oneself, one is also essentially thinking of the alter. The personal self is filled up with the thoughts of others and the thoughts of others are filled up with oneself. The self and the alter are to our thought one and the same thing (1897, 1899/1973).



Based on his dialectical notion of *self* as *self—alter*, Baldwin elaborates certain implications of his view. An individual's "interests", for instance, is a self—alter interest rather than an interest which solely belongs to the individual. Similarly, an individual's emotions or desires may be considered self—alter emotions and self—alter desires. In its perspectives, his view is a radical deconstruction of individualism and of elementarism.

Unfortunately, psychology in general did not go thus far. Elementarism still pushes forth scepticism which forces us to think in 'either-or's, dichotomies, and (more or less) mechanical exchanges: Something is either in the individual or outside the individual; either the individual initiates or responds to stimuli; either psychology is a matter of biology or of social constructions; either a child is creative or imitative, etc. endlessly. Further, particular domains for study are being institutionalized into practices and journals, like the study of cognitive development, of social development, of emotionality, etc.

In other words, the either-or discourse of elementarism is a challenge to dynamic methodologies; it is a deeply embedded part of the history of psychology. One needs to wrestle with this foundational issue if any progress is to be made. The point is that given those habits of thought and of practices, there is a gap to be filled out between good intentions and good practice. One may wish to look at things in a 'dynamic' way or to consider 'complexities'. However, if 'dynamic' still means 'interactions' and 'complexities' still means 'the impact of a lot of different things', one might worry that one still sticks to elementarism.

## The Importance of Theoretical Concreteness

There probably are several ways to go when trying to get beyond elementarism. In the present paper I shall try take a move in that direction by using *the method of theoretical concreteness* which finds inspiration in Hegel's notion of 'the concrete'. Viewed from Hegel's (1812/1969) dialectical perspective, empiricism (which is the epistemological ground for elementarism) is related to the making of abstractions and formalizations based on the analysis of perceived differences and similarities of things (elements) which are then thus being put into fixed categories. In psychology this tendency for example influences ideas of what concepts and concept formation is about. Davydov (1977) formulated a Hegel-inspired critique of this view on concepts and processes of generalizations. He found that classifications based on perceived similarities of features are non-dynamic generalizations, while dynamic generalizations are those based on analysis of what are the driving forces and the becoming of psychological phenomena. The ideas of generalizations as categorizations is also present in Piaget as he finds inspiration in Boole's algebra and symbolic logic (Piaget, 1957). Hegel names this process 'understanding'. To him 'understanding' is merely related to abstract formalizations, not to discovery of the dynamic and *concrete* becoming of the subject matter given. According to Hegel, the *concrete* is not just what is before our senses and available to perception. The

term of ‘the concrete’ refers to the *becoming* (history) of the subject matter. It has nothing to do with processes of abstract generalizing; quite on the contrary, it has to do with processes of concretizing particularities of becoming. What is concrete is that which passes through ongoing determinations of dynamic, changing, and evolving processes of becoming.

In Hegel’s universe, matter in isolation, identity and difference, abstract universality are all concepts related to empiricism (elementarism). Contrary to this he finds that a subject matter should not be determined from the outside but from the perspective of its own real dynamic and concrete being. Dialectics is what grasps such processes in that it constitutes a method to avoid the one-sidedness and limitations of the abstract, isolated determinations. Such determinations neither leave room for movement, nor for change or emergence. Therefore, to better grasp these processes, Hegel (1812/1969) introduces his dialectic of *being and nothing*. An object of knowing is not just ‘being’ in the finite abstract form which elements are made of; the object of knowing is ‘nothing’ as well. By introducing ‘nothing’ Hegel points to processes of *becoming*, that is, what is not (yet) there, what changes over time and so on, as an immanent feature of being itself. Therefore, a particular thing, event, etc. is never just a particular in itself, it is co-existing within dynamic processes of change and becoming.

### ***An Example of Theoretical Concreteness***

A first step using the method of theoretical concreteness is to present the object of study, that is, the particular piece of everyday life which one wishes to research dynamically. The next step will be to work on a concretion of the object studied (synthesize it), hence reaching a point where the particular object can become wrenched free from an isolated position and, alternatively, become perceived and conceived as a snap-shot of becoming of a wholeness. Before I reach this step, let me first introduce an example on the basis of which the generalities of the method may be derived.

The example picked out could be any everyday event and the fact that it is picked out from a school context is in no way significant. If anything, the school context only illuminates a very general problem, especially because school knowledge and scholastic practices are often approached in somewhat rigid and limited ways as if we are dealing with learning only referring to quite simple matters of individual—subject matter interactions. Those reductions have been keenly criticized for a number of years. In relation to the present paper the school context serves to exemplify what kind of everyday psychological phenomena should become perceivable and conceivable by the help of dynamic methodologies. The first steps, hence, is to determine what kind of psychological phenomena we are dealing with by presenting it and synthesizing it. After that the third step will be to seek out the theoretical roots which still may contribute to the elaboration of dynamic methodologies.

## *The Physics Lesson—An Example*

My example is taken from an observational study of students learning physics in a Danish high school which I did some years ago (Bang, 2006). The overall aim of the study was to investigate processes that might be helpful to explain why apparently so many students find science difficult to comprehend. It is a somewhat open focus in that the process nature of students trying to understand something is the object of study. The students and their activities and communication is what was focused upon; it is a shared process and any of the individual student's activities and contributions has to be studied inter-relationally. This makes it apparent that the unit of analysis cannot be the individual student, even though it is exactly those individuals who are being kept in focus.

The theme of the particular lesson studied is 'collision', a physical event that anyone knows well from the everyday life (bumping into something, something falling down from somewhere, etc.). In the lesson, the students are asked by the teacher to analyze theoretically what happens when two cars collide on a road—the one entering a bigger road from a smaller one and hitting a car which apparently remained unnoticed by the driver until the time of the collision. The students are given a simple figure which illustrates the collision (car crash). They are asked to describe in physical terms what happens right after the crash and to illustrate it on the figure.

Three female students are going to collaborate on the task. They receive the figure which illustrates a collision and begin to work. The teacher's intentions are to make the students train their ability to think in physical terms about an everyday event, to appropriate the language and thinking of physics. Especially, they are asked to verbalize, what could be meant by "non-elastic collision" in physical terms and what are the difference between that and an "elastic" collision. The three students accept this task willingly and, so it appears to the observer, seem to find it to be a relevant and meaningful activity as it is a part of their high school education. As they begin to work with the task, sometimes they get out of focus and begin to share something else, something which seems relevant to them as friends and classmates but not relevant in relation to the theme of the lesson. Rather, they seem to have a pleasant time sharing after school activities, plans, future events, etc. This *in-and-out-of-focus pattern* concerning the task continues recurrently throughout the observation. Their in-focus activities unfold like this: They put some arrows and a curlicue into the figure to illustrate the direction of the cars and the collision event (Fig. 25.1).

Soon after, they seem to have reached a 'bump' in their apprehension which makes further task management hard to go on with. They hesitate and begin to share what 'elastic' means. Still, they go in and out of focus, hesitate, return to the question but do not challenge themselves and their own conceptions. Rather, quite soon after they *reach an agreement* about an interpretation about the term 'elastic' and confirm the agreement with words like "Yes, this is the way it must be". The agreement, however, is reached without any clear or open discussion or seeking out definitions. It is the observer's impression that reaching an agreement of understanding

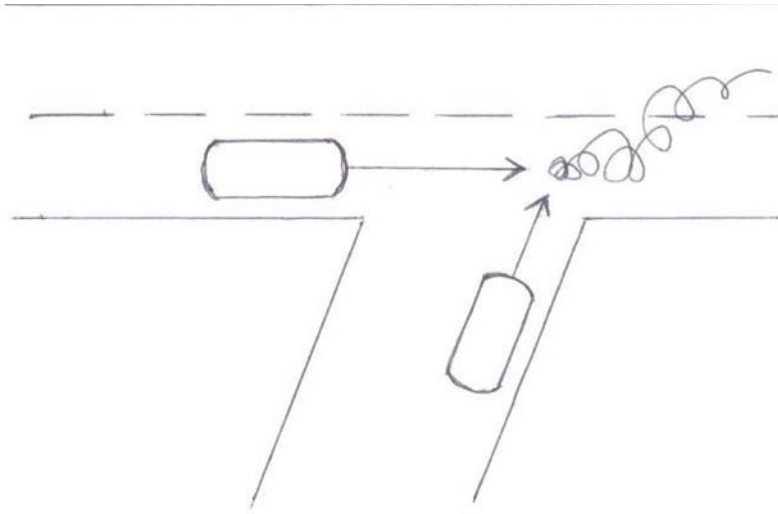

**Fig. 25.1** Children's work on the collision event

is experienced at an emotional level as a relief. The shared agreement seems to help them feel on a safe ground in the task solving process; they have now reached a point of social support for what they want to believe about the troublesome term 'collision'. Each of them agree with the other two about an interpretation to which they *conform* and now they soon can *go on* with whatever is the next to be done (what that is, is not quite clear, however). It is worth noticing that agreement is *not* reached on the background of disagreement, conflict or any deeper commitment or discussion of the present matter.

The 'cognitive conflict' experienced as a 'bump' in the flow of the group process is resolved by means of social conformity and social psychological appeal to consensus (in general, consensus appears to be a general attractor when sharing about some subject matter in group processes in school). What they seem to agree about (however falsely according to the textbook conceptions and the teacher's articulations) is that a 'non-elastic collision' means that the cars are entangled. So, if the cars are entangled, the collision is 'elastic'. However, they are not quite sure about this and call for the teacher to help them clarify the terms, which the teacher does. The teacher corrects their understanding and, hence, undermines what they just agreed about. Even though the subject matter and the terms involved are being sorted out—that is 'officially' what goes on as the teacher explains about the concepts—the students nevertheless seem to find themselves in a vacuum. Putting effort into a task and comprehending the task seem not to be the same process, however often constructed that way in a classroom context. The students do not occur to be much affected by that; when the teacher leaves, they just *go on* with something else as they repeat the pattern of going in and out of focus.

## *Second Step—Concretizing of the Physics Lesson*

A consequence of elementarism is to view learning as an exchange between elements, that is, between *the student* and *the subject matter*—either in a Cartesian sense as a process where elements from the outer world is being transferred into the mind of the student or in the Piagetian sense as the student actively constructs her own conceptual formation and abstract thinking. If the researcher goes out in classrooms and expect to find such simple student—subject matter exchange *everything else being equal*, the researcher will become disappointed. The object of study is not only far more complex, it is far more dynamic. I shall now take the next step following the method of theoretical concreteness and try to reach a point where the processes of comprehension are being perceived and conceived as synthetic phenomena. The synthesizing process, of course, is not thorough; it only intends to throw light on a few methodological means that might help replace elementarism.

Let me begin with a deconstruction since it occurs to me to be essential with regard to the further synthesis. As an observer, what is being deconstructed in theoretical terms in the example is the assumed identity of learning activities and learning outcome. There is no simple connection between what is presented to the students by the teacher and what is agreed upon among the students to be the focus of their activities. The students apparently do not conform to the teacher's hope for the activity—outcome circle: “now you do this and so in the end you will know about it”. This is the ever ongoing hope or generalized expectation which keeps up the hope for teachers wherever they practice. Of course, a critic might object that this is just an example of bad learning, that the situation is not one which offers optimal conditions for meaningful learning and probably the teacher/the students are to be blamed for this. Another teacher/pedagogy or other students might change everything to the better. Even though such a critique might be relevant; it leaves the question unanswered *what is* such an optimal situation—is it one with ideal teachers and students, optimal schools and home backgrounds? Even if such critique might have a point, the point is elitist. Elementarism relies on elitist viewpoints because they rest on abstractions from real life with real people and assume that there are special positions for special (particularly ‘gifted’) people. However, one must realize that the situation presented above serves to determine common processes of human exchange and it is constituted by *much more* than a student—subject matter exchange. One, therefore, should expect the *stream of consciousness* (James, 1912) of the students to absorb the *much more* as a global experience. In this respect, nothing is ‘private’ or just “in the head” of each individual student. From the perspective of the method of theoretical concreteness, the ‘much more’ should not be regarded as side events or disturbing ‘noise’ which prevents the ‘pure’ process of appropriation to proceed. There is no such purity to be found in everyday life of people.

The object in focus is not just learning activities or having a social exchange or going to school or receiving instruction or discussing something or whatever parts (elements) the situation appears to consist of. The object in focus is those actions among the students which seem to be meaningful to them, some of which recurrent

over time and therefore—probably—expressing some ongoing pattern of meaningfulness. What should be researched, therefore, is

- a) a pattern of activities which constitute the situation in dynamic ways,
- b) how the individual's stream of consciousness is saturated by/saturating the dynamics and
- c) how the dynamics as a synthesis are experienced and may become described at a phenomenological level.

Starting from the basic ecological unit of analysis, the individual—environment—reciprocity, one should expect to find such transitions. For the purpose of my general argument, I shall pick out a few dimensions which appear to have the qualities of being meaningful to the students and, further, add to the process of synthesizing. Those dimensions are the following activities: *work with the object* of the lesson, the *being attracted by consensus*, and the *going in and out of focus* of the activity.

*Work with the object.* What is it that the students are working with, what are the particular properties of the object in focus (collision), what is the order revealed? The teacher's explanation to the students reveals a general order of theorized physical objects which also holds true for this particular one. A theoretical understanding of collision includes two dimensions that are often fused—the dimension of what might be called a *theoretical ideal construction* and a *theoretical real construction*. The theoretical ideal construction is an idealization of what might be the case in a physical world concerning objects and movements. The theoretical ideal construction is the consideration of concrete circumstances concerning those objects and movements. It is only in the world of ideal theoretical constructions that one should expect a collision with no loss of energy to happen. In the real physical world, there will always be a transformation of energy into heat. Other examples of idealizations are the difference between the ideal and the drawn circle. Davydov (1977) found that the ideal circle is identical with the procedure to be followed when producing a real circle (i.e., using the equation of the circle as a prescription for action). A falling object is ideal only if one ignores the fact of the resistance of the medium, the wind, etc.—in short, particular environmental circumstances. The ideal <-> real nature of the physical object constitutes a cultural artifact which is part of the scientific practice. In this case, the ideal <-> real artifact is the elastic <-> non-elastic collision which established the physical object concretely. Hegel's ideas about what established something as concrete also works in the case of the subject matter. What the students meet is not just a physical event; rather, it is the cultivated access to the event and the subject matter becomes concrete for the students to the extent that the cultivation process itself (its history) becomes available and meaningful to the student. Hence, the double theoretical nature of the cultural artifact presented to the students constitutes part of the cultivation which contributes to the particular subject matter of situation.

However, the students seem to be confused and do not really know how to approach the example given; rather, they guess about possible explanations by drawing on other kinds of order like that of 'two things which tangle become one thing'. What is ideal, how the ideal anyway is real (part of practice), what is real

about the collision as an everyday event, what is essentially important, what is less important, how and why are own experiences and ideas relevant and (perhaps) why not—all of those multidimensional processes of sorting things out are present in the situation mostly as an experienced open field and as experienced confusion, disintegrated activities, and ways of approaching the object. The process of reaching a point of concreteness partly fails, but this partly failing is in itself part of the dynamic of the situation. The double theoretical nature of the object as an artifact mediates cultural experiences within a specific domain and the students meet this specific part of history when working with the object. Even though the car collision example appears to draw on everyday experiences, it is a little illusory and marks only the opening of the process. Soon the feeling of familiarity turns into confusion as the students try to identify the history present (absent present). In fact, they do not know what to identify.

*Being attracted to consensus.* The students in the present situation seem to agree that *agreement about an interpretation* is important. This might be a relevant social motive in school when one feels uneasy or hesitant towards the own level of understanding. If they do and think like others do and think, each student will bring herself in a more 'secure' position and feel some comfort in protecting herself against the tests and the individual evaluations of the school system. Being wrong about an interpretation does not feel so bad if one shares it with others. In fact, it may be less important if one is right or wrong about things in school, as long as one is a member of a community who share the views. Consensus appear to be a strong motive in a system which rests on the idea of testing and evaluating individuals on the one side, and, on the other side, sometimes offers the individuals chances to collaborate. No wonder that collaboration and consensus tendencies go together.

The ways in which collaboration and consensus go together can be seen in the activities of the students. The fact that consensus seems to be a relevant and action guiding motive for participation may link to the fact that the students tend to go in and out of focus rather than to engage themselves whole-heartedly into the task given by the teacher. They often start a conversation about something else, like what is going to happen in the next lesson when they have another subject and another teacher, are they well prepared and why not, what did they do yesterday afternoon after school and what will they be doing in the weekend and with whom, etc. In short, they go in and out of focus constantly. The discussion of the subject matter, consequently, did not get into any depth. Agreement substituted discussion in an early phase.

*Going in and out of focus.* The actions of going in and out of focus I shall discuss as a way of managing the general order of the school system. McNeil (1988) argues that school should be viewed as a societal institution where practice is influenced by the overall tension between educating new generations of citizens and controlling the educative goals—the school rests on the tension between educating and controlling. This sets the stage for ways of doing school in a society. McNeil is especially occupied with the tendency of defensive teaching which follows from the control side of the tension. If control of outcomes (tests) rules the everyday practice of school, standardization of courses will occur and standards will become

restricted and ‘school like’. As a consequence, teachers and students might reduce their interest in school and minimize efforts. Instrumental relations might occur and begin to define practice. It might grow difficult to find examples of whole-hearted engagement among participants. The students might even work against the attempts to control them and control will increase. From this perspective, the level of engagement in learning situations might mirror appropriated strategies to manage the basic tension of school in society. In addition to McNeil’s analysis of the dynamics of control, the overall educational goals lead to the construction of a variety of courses which the students must join throughout their career. The particular physics lesson is but one among others in a course and also, it is one among the lesson of other courses. The everyday practice of school means that the students must focus attention on a lot of separate things while also keeping in mind the continuation and transformations of everything. To master this order of school practice, the students have to develop relevant general strategies. They have to become ‘good enough’ students in their attempt to master the heterogeneities and contradictions of school. A “good enough” student is someone who is able to show some progress and avoid trouble. The ‘good enough’ performance protects the student and helps her make it through the courses and manage the order set to be followed. Engaging into particular subject matters or a particular issue has to co-exist with not engaging too much due to the fact that next lesson will be about something else and so on and so forth. Mastering the lesson must co-exist with mastering the day—digging oneself into some matter and spreading oneself out on several matters. This is the order set by the institutional organization of educational goals by school. There may be many ‘levels’ of being a good enough student. However, the dimensions of order described above seem to create an inescapable order which the student enters as she enters school.

### ***The Good Enough Student***

The following results appear on the basis of the three research *foci* suggested above:

- a) *A pattern of activities which constitute the situation in dynamic ways*: The activities of the students are distributed rather than focused solely on the task given by the teacher. It was found that several relevant dimensions concerning the school system were directly active in the situation and saturating the students’ activities and thoughts. Especially relevant was the history and cultivation of the subject matter and the history and ongoing practice of the school as a societal institution. Activities were found to be saturated by both in a recurrent shifting flow.
- b) *How the individual’s stream of consciousness is saturated by—and saturating—that dynamics*.

There is a meaningful relation between activities unfolded and the stream of consciousness of the students. In this respect it is found that both historical dimen-



sions mentioned above contributed to the *heterogeneity* of the situation—even to the *contradictions* found between

- 1) being a “good student” who is much occupied with the particular subject matter—versus being a “good student” mastering the ongoing flow of everyday life in school, and
- 2) being exposed to individual learning, testing, and evaluation versus collaborating with others.

Those heterogeneities and contradictions appear *assorted* to the students, they are not being reflected, sorted out, focused upon, or ordered hierarchically. Rather, they tangle into that, which *is* the situation. The students’ actions are assumed to express how they absorb it all, the ‘good enough student’ position may be considered the most obvious possible social position for the well adapted student who is able to fill out the gaps and overcome the contradictions from time to time. The stream of consciousness of the students as saturated by the heterogeneities and contradictions of the situation and their activities and thoughts acts it out and contribute to maintaining the flow as a shared process—*how the dynamics as a synthesis are experienced and may become described at a phenomenological level*. In this analysis, no attempt to ‘look inside the heads’ of the individual students is to be undertaken. The unit of analysis is the student—environment reciprocity and hence it should be expected that each student lives in a non-private world when it comes to the level of phenomenological experiences. If that is so, one should expect each student to experience herself as a participant in relation to the global whole of the situation. The heterogeneities and contradictions should be expected to find their way to how the students experience to be there and to participate in activities in school. The ‘good enough’ student hence is supposed to be not only the most probable social position but also the one to saturate the experience of the student herself. The ‘good enough’ student, of course, must be an ongoing compromise and an unstable balance—not a fixed position. It is a student who must put energy into keeping herself up in this possible position not one who rests in it. This is so, of course, because of the constancy of heterogeneity and contradictions in her school environment. Hence, she must constantly co-constitute her position and co-constitute her self-experience. The ‘good enough’ student is someone who succeeds in keeping things together by help of relevant and socially accepted strategies; the not good enough students are those who do not. The ‘good enough’ student is one who masters sufficiently well the heterogeneities and contradictions of school. The result is exactly what the present situation reveals—students who engage ‘just enough’ and who go in and out of focused activity.

The suggested synthesizing shows how actions, thinking, perceiving, feeling, experiencing is a kind of ‘summing up’ of the multidimensional and global nature of a situation filled up with heterogeneity and contradictions. I have tried to describe the presence of global phenomena which cannot—and should not—be reduced into elements. The global nature of the situation, encompassing heterogeneities and contradictions, is what the individual meets in her everyday life, it is her reality which she has to master. This is true for any individual in any everyday situation of every-

day life, hence the whole way of thinking constitutes a challenge to stage-theoretical conceptions of development, but this is a story to be told elsewhere.

## The Notion of *Gestalt Qualities* and the Dynamic Nature of Synthetic Situations

It may be a good idea, with regard to understanding the synthetic phenomena genuinely, to begin with the beginning. I shall therefore present von Ehrenfels' initial notion of Gestalt qualities and then expand the analysis to the field of everyday phenomena discussed in the paper.

Ehrenfels defines a *Gestalt quality* like this:

By a *Gestalt quality* we understand a positive content of presentation bound up in consciousness with the presence of complexes of mutually separable (i.e., independently presentable) elements. That complex of presentations which is necessary for the existence of a given Gestalt quality we call the *foundation* (*Grundlage*) of that quality (Ehrenfels, 1988, p. 93).

Elementarism visibly is a background problematic to Ehrenfels who argues against it when saying that it is possible to directly '*sense*' *Gestalt qualities of a system*. He discusses the example of a melody and finds that we do perceive directly the tone-Gestalts of a melody. It is:

...a commonly held belief that a presentation of, say a spatial shape, or even of a melody, does not originate from outside consciousness as something complete, but rather, if it is to enter consciousness at all, stands in need of some integration or synthesis of the relevant individual component sensations" (1988, p. 83).

In Ehrenfels' view, the positive alternative to elementarism is to acknowledge the existence of Gestalt qualities which can be perceived directly by the perceiver. If one perceives a coloured surface, for instance, every part can be decomposed infinitely into ever smaller parts and psychology would end up with a problem of processing those elements in consciousness as a phenomenon of infinite regression. Fortunately, we are able to perceive the surface as a plane surface which means that the phenomenon studied is not infinite amounts of elements but the continuation of a surface. We are able to perceive those Gestalts surrounding us. We are also able to perceive the family resemblance in the faces, bodies and movements of relatives even though we are not able to specify exactly on which basis we do our judgements. The Gestalt quality of family resemblance is a meaning-unit which connects the family members despite their differences. The Gestalt is a glimpse of that family's particular history which may appear to the perceiver.

A Gestalt, hence, is not a mental construct but the percept of an environmental property to which we have direct access. Spatial shapes and melodies exist without any contribution of the intellect, without the need for application of mental activity. Gestalt qualities are given in consciousness simultaneously with their foundations, without any activity of mind specifically directed towards them. This view

- 1) places Gestalt qualities in the world rather than (primarily) in the mind of the perceiver, Gestalts are not mental constructions
- 2) assumes that there is a synomorph relationship between the Gestalt quality of that which is perceived and the perception, and
- 3) that Gestalt qualities are perceived directly and immediately (without intermediate mental processes) as the perceiver turns her attention toward some matter in the world.

Ehrenfels' basic insight may be helpful when applied on synthetic everyday phenomena. Let us first try to apply the Gestalt view on the learning activity presented above: what is the psychological phenomenon studied from this perspective? Clearly, as I have argued, it is not just the individual student struggling with the subject matter. The history, organization, and ongoing practice of different co-constituents tangle so that it becomes practically and empirically impossible to stay with the idea of the 'pure case'. The object of study rather seems to be *the situation as a Gestalt*, that is, (following the realist notion of the Gestalt qualities summarized above) *the heterogeneous and contradictory Gestalt qualities which make up the situation and how the actions, perceptions and stream of consciousness of the individuals at the same time grow out of it and contribute to it*. The main conclusion of the synthesizing is exactly that the students are able to perceive and act adequately to the heterogeneity and contradictions which constitute the Gestalt-like wholeness of the situation. The students are adequately adapting themselves to that dynamic nature of this particular (though recurrent) situation. The synthesized 'good enough' student position grows out of the ability to adapt to the wholeness of heterogeneity and contradictions.

In general, institutional practices may be viewed as having Gestalt qualities, that is, there is something about the situation that transcends to particular co-constituents; it may be identified as a kind of *wholeness* which the participants co-constitute through their personal contributions which, on the other hand, are based on the perceived wholeness. This view is anti-elementaristic in the sense that (a) the object of study is the wholeness of the situation—the Gestalt qualities of the co-constituents, and (b) it is no longer clear what belongs to the individual and what belongs to the environment—the individual co-constitute her own environmental conditions hence, brings herself out of the shell of privacy.

The individual is not 'opposite to' her environment, she co-constitutes it, hence is part of it. I shall return to this point later because it helps expand the notion of the environment beyond the commonly held belief that it is that which surrounds the individual, has an impact on her, etc—a belief which is anchored in the strong influence of elementarism and stimulus—response ideas mentioned earlier in the paper. This view expands Baldwin's ego—alter dialectics into a global environmental idea—the alter is expanded to refer to all that is a result of human life and practice, the ego is expanded to mean also that, with which she contributes to the situation and how she contributes to her experiencing the situation. Her perception and her actions are dialectically constituted.

## ***The Heterogeneities and Contradictions of Situational Ecology***

When applying Ehrenfels' version of Gestalt psychology on the cases of human social practices, some reconsiderations and adjustments must be done. A social practice is not a Gestalt quality similar to a melody or a surface. Those are examples of how harmonious wholeness is the result of foundational parts. A situation within the field of social practice is not a harmonious or homogeneous whole. We are not dealing with harmony in the example, quite on the contrary. The closest thing we come to 'harmony' is the 'good enough' student who manages to operate within the heterogeneity and contradictions which constitute the wholeness of the situation. The 'good enough' student is a compromise, as argued earlier. The students are being pulled simultaneously in different directions; they perceive and act in a field of dilemmas without obvious choices because the different co-constituting dimensions are all at work. The students must perceive the dynamics of the field and act accordingly; she is adapting to the ecology of heterogeneity and contradictions and may in general grow and develop accordingly to how she masters it all.

### **James Gibson and the Situational Ecology**

The need to explore the *ecology* of the situation grows naturally out of the expanded Gestalt ideas. This is no wonder since ecological psychology in general suggests a move away from having the individual as the unit of analysis to having the individual—environment reciprocity as the unit of analysis. Gibson is one of the influential ecological thinkers who found inspiration in Gestaltist ideas of Kurt Koffka. However, unlike many Gestalt psychologists, Gibson found perception to be direct rather than indirect.

Gibson was occupied with the organism-environment reciprocity and developed his theory of *direct perception* also as a general comment to the dualism problem in psychology. The dualism problem is varied but may find its basic form in the Cartesian dichotomy between the (mechanical) world and the human mind. His struggle to formulate an ecological alternative to elementarism is present in his books in the form of his theory of information pickup. He finds the idea that perceptions of the world are caused by stimuli from the world to be problematic. The very notion of stimulation as typically composed of discrete stimuli leads to elementarism and mentalism in the Cartesian tradition, hence isolate the individual from the world. Discrete percepts (Descartes-like) will not do, he finds; in thinking so, he is in full accordance with Ehrenfels' critique of elementarism. According to the discrete percepts view, we do not know the external causes of our sensations; we cannot know the outer world. Since we cannot detect the causes of our sensations, we must deduce them by mental acts. Gibson speaks against this view and draws on Gestalt ideas to argue for his realist position contrary to the traditional view of perception.

Gibson theorizes perceiving to be direct in the sense that there are no intermediaries or ‘constructions’ in the brain going on between the perceiver and the thing being perceived. Perceiving is not the result of constructive brain processes:

According to the theory here proposed (...) the neural inputs of a perceptual system are already organized and therefore do not have to have an organization imposed upon them—either by the formation of connections in the brain or by the spontaneous self-distribution of brain processes.

The evidence of these chapters shows that the available stimulation surrounding an organism has structure, both simultaneous and successive, and that his structure depends on sources in the outer environment (...). Instead of postulating that the brain constructs information from the input of a sensory nerve, we can suppose that the centers of the nervous system, including the brain, resonate to information. (Gibson, 1966, p. 267)

Perception, he finds, is not a response to stimuli, rather, it is an observer’s awareness of the environment. This awareness is based on information specific to its sources in the environment. He regards *exploratory action* to be a basic unit of analysis which makes information available for an actively exploring organism. With his *direct realism* he claims that it is possible to perceive the environmental properties directly on the basis of information already available in the environment. No mental representations are needed for that process. Perceiving refers to “...a keeping-in-touch with the world, an experience of things rather than a having experiences” (1986, p. 239). What is perceived is not colors or forms or other abstract ‘properties’ but real properties of the world and the habitat of the organism. ‘Place’ for instance, is not an abstract notion but somewhere in the world where an organism is located and exploration of places means moving oneself around from one place to another; places are nested within larger places.

Similarly, information refers to the qualities of objects; it is a specification of the perceiver’s environment. A perceiver can keep on noticing facts about the world she lives in to the end of her life without ever reaching a limit. The information can be the same, despite a radical change in the stimulation obtained (again a thought similar to Ehrenfels’, who finds that a melody can remain the same despite the change of key). Along this theoretical line, the theory of information pickup requires perceptual systems, not senses. By a perceptual system is meant the activities of looking, listening, touching, tasting, or sniffing and it is susceptible to maturation and learning.

Everything in the world persists in some respect and changes in other respects. So does the observer himself. The continuous pickup theory of perception assumes that the apprehension of persistence is a simple act of invariance detection. In the case of the persisting thing the perceptual system simply extracts the invariants from the flowing array. According to the theory, perceiving is a registering of certain definite dimensions of invariance in the stimulus flux together with definite parameters of disturbances. The invariants are invariants of structure, and the disturbances are disturbances of structure. The invariants specify the persistence of the environment and of oneself. The disturbances specify the changes in the environment and of oneself. A perceiver is aware of her existence in a persisting environment and is also aware of her movements relative to the environment. The perceiving of the world begins with the pickup of invariants.

Perceiving means perceiving the *affordances* of things, that is, the ‘invitation qualities’ (*Aufforderungscharakter*) of things. Gibson’s inspiration in Gestalt theory is explicit here:

The hypothesis of the “invitation qualities” of objects, their valences, or what they afford, was central to Gestalt theory, especially as developed by Lewin (1936), but the phenomenal field in which they appeared had an uncertain status, neither wholly internal nor wholly external. If these valences are taken to be invariants of stimulus information, the uncertainty disappears. The stick’s invitation to be used as a rake does not emerge in the perception of a primate until he has differentiated the physical properties of a stick, but they exist independently of his perceiving them (Gibson, 1966, p. 274)

Gibson’s concept of *affordance* intends to ‘cut across the dichotomy of subjective and objective’—it is both a fact of the environment and a fact of the agent. An affordance points both ways, to the environment and the observer (Gibson, 1986; Good, 2007).

The Gestaltist inspiration to affordance theory finds its way to the idea that visual information is available to specify what an object affords (Costall, 1981). What is graspable, what can be eaten, what can be walked on, etc. are affordances, that is, what the environment offers the organism (animal). According to Gibson, affordances are real; they are objective properties or invariant groupings of properties. A surface which affords walking, for instance, must be level, solid, rigid, not frictionless, etc. (Costall, 1981). When linked to another major source of inspiration—pragmatic functionalism—Gibson’s theoretical systems appears to become a kind of applied Gestalt approach to perception-action studies. The concept of affordance is an important one because it grasps the direct access of the organism to the environmental properties relevant to that organism: Hence, the notion of affordance implies a notion of the relevance which goes beyond the mere perceiving of continuous surfaces (Ehrenfels). Gibson’s striving is to unfold “...an adequate functional account of living processes that have co-evolved with respect to a set of environmental conditions and maintain a dynamic and reciprocal relation with those conditions” (Heft, 2001, p. 15). He is not searching for any inner mechanisms or structures to explain mental phenomena. On the contrary, he finds that the exploratory activities of an organism make the information about the environment available for the exploring organism.

## **Gestaltist Ideas as a Source of Progress and Limitation to Ecological Theory**

So far, I have argued *for* the presence of synthetic phenomena in everyday lives of people—and *for* theories which help conceptualize those phenomena. This endeavor is not just meant to be an anti-thesis to elementarism; it is an attempt to move from a primarily critical formulation of the problems of elementarism to a primarily positive formulation of alternative stances. I found that the ecological unit of analysis, the individual—environment reciprocity is a basic empirical and theoretical source

for dynamic methodologies. However, the interpretation of the example mostly aimed to illustrate this reciprocal relationship by pointing to how environmental properties and demands (the history of ongoing practices and available environmental properties) find the way to the activities and the (probable) experiences of the participating individuals.

The discussion here has mostly been focused on understanding what streams in the stream of consciousness of the individual and how its public nature could be understood by using the method of theoretical concreteness. While the argument has been to describe the ‘reciprocity’ at the level of the individuals, less effort has been put into understanding the terms of ‘the environment’ and ‘the individual’ and how they conceptually relate to each other. Obviously, the environment is not just that which surrounds the individual; and the individual does not meet the environment anew all of the time as that which she sees and feels when she wakes up in the morning. The environment is not just what is materially present before the eyes of a single individual; and a single individual does not stand alone to meet the environment, she is saturated by the environment in non-reducible ways. If the environment is reduced merely to that which surrounds, the principle of reciprocity will immediately fade and the individual—environment exchange will be reduced into a mechanical one based on elements (so we are back where we started). Hence, the constituent ‘parts’ of the reciprocity deserve particular interest. In human life, the constituents of the reciprocity—the individual and the environment—constitute each other. It has already been illustrated by the example how the environment lives in the stream of consciousness of the individual and how the individual becomes part of her own environment as she experiences herself as a co-contributor to the ongoing flow of activities. Apart from the feeling of *agency*, it increasingly becomes blurred what is ‘inside’ and what is ‘outside’ of the individual.

### ***Isomorphism and Immediateness***

The organism which Gibson seems to have in mind is one who continuously explores its immediate environmental properties by help of a proper environmental medium (light); the invariant structure is directly perceivable which means that there must be a simple and non-ambiguous interrelation between the needs of the acting organism and the properties perceived in the environment. Some things afford ‘eat me’; others afford ‘sleep here’, etc. Organisms in this world may contribute to the change of their ecological niches if not exactly in purposeful ways. One must assume that because Gibson does not talk about humans (who do change their environment purposefully) environmental changes occur in the attempt to adapt to the environment by learning proper perception-action systems over time. I suggest that the world which Gibson theorizes within is the world of the animal, assuming that perceptual processes follow a similar pattern across species.

I would suggest that his inspiration from Gestaltist ideas at the same time *contributes* to his ecological thinking and *puts limitations* on it. The idea that one has

to obtain stimulation in order to extract information (1966, 1986) seems to focus much on the detection of *immediate* environmental stimulus material. The alternative to operating with dichotomies between the individual and the environment (no surprise) is the suggestion of a close connection or even an isomorph relationship between the individual and the environment according to which there is no difference or disconnectedness between what presents itself to the individual and what the individual picks up. When it comes to human life, however, the immediate relation between the individual and her conditions of life is being changed. According to Holzkamp (1983), this *breakthrough* is due to the division of labor which changes the life conditions for the individual. Her individual existence is now mediated by the common societal conditions of life. I tend to think that this point of view might be relevant to Gibson's ecology—at least if applied on human life. We do not, of course, deal with a problem solely related to Gibsonian thinking. Quite on the contrary, this isomorph 'trick' appears to be a common 'solution' to the problems created by dualism.

Good (2007), for instance, discusses the perception of social knowing, and his quotation of Asch illustrates the idea of an isomorphic relation between experienced emotions and expressions of emotions. The perceiver, it is argued, can perceive the emotion by perceiving the expression because of the assumed isomorphic relation:

Our problem of relating actions to inward experiences would be solved if we could abandon the assumption that phenomenal facts and the actions that correspond to them are utterly heterogeneous, if we could reverse this assumption and say that the organized properties of experience are structurally similar to those of the corresponding actions. We could then conclude that the emotion of joy and the expressions of joy have identical characteristics, that formally the same qualities are present in the experience and movements of tension, hesitation and daring. With this step we would provide the basis for the grasp of the psychological situation of others through the observation of their actions. At the same time we would be reversing completely the subjectivist conception of consciousness: from being hidden and private, consciousness would become something accessible to us through action (Asch, in Good, 2007, p. 267).

According to Good, Asch here seems to capture the essence of a non-mentalistic conception of social knowing which is revealed directly in actions. Further, he finds that Asch's position may be seen in a tradition of direct perception that includes (among others) Gibson. Asch's explanation of the link between the psychological properties of persons (like feeling joy) and these kinetic structures (expressing joy) is described as characteristically Gestalt; it is based on an *isomorphism* between brain states and human actions.

It seems as if the eitherto ecological solution to the problems of elementarism is to *stress the immediate nature of the relationship between the individual and the environment*. As a consequence, perception is suggested to be the point of departure for psychology. I do find, however, that the ecological solution may only be a half step away from elementarism if it sticks into *immediateness*; even though Gestaltist ideas may contribute productively to overcoming dualisms, it may also restrict the solutions suggested as long as those solutions assume isomorph and immediate relations between the individual and her environment.



## ***Adapting and Transcending—Two Merging Processes in Human Life***

An ecological theory of perception is useful—yet insufficient—to understand the dynamic phenomena in human life. It is a fact, for instance, that the school in which the observational study was carried out is a societal institution invented to educate young people, and that the need for educating people is a need of the society as it has developed through active transformations across generations of people. If we start with perception, this fact may create theoretical challenges to ecological theories or, worse, become theoretically ignored.

Since there seem to be Gestalt qualities in the world one should value and protect those insights and use them as important theoretical points when developing dynamic methodologies. However, those important insights cannot stand alone. We can, for instance, not understand the phenomenon of the learning situation presented earlier in adequate ways if only theorizing it as a perception-action situation (even though it is *also* a perception-action situation). The mere fact that the students participate in societal institutions and practices—they find themselves in socially invented and produces physical environment and co-contribute to the keep going and the keep changing of practices, etc.—transcends the immediateness perspective on human life.

### **The Individual—Environment Reciprocity Reconsidered**

Dynamic methodologies for the study of human life must rest theoretically on two basic assumptions—that of *adapting to* and that of *transcending* environmental immediateness. With the animals we share the ability to live in an immediate connectedness with our environment and *adapt* to it; we are able to pick up information about what is immediate (invariants) in a direct way—this is the legacy of Gestalt psychology and functional-pragmatic theory. Further, humans *transcend* their immediate connectedness with the environment because they are producers of their own societal life. This means that the human environment is produced environment and, further, that future directedness of humans puts change, creation, and invention into the centre of understanding dynamic phenomena. This is the legacy of Marxist philosophy and its impact on cultural-historical activity theory.

As Marx wrote, it is a fact of human life, that it is produced by humans themselves:

Men can be distinguished from animals by consciousness, by religion or anything else you like. They themselves begin to distinguish themselves from animals as soon as they begin to produce their means of subsistence, a step which is conditioned by their physical organization. By producing their means of subsistence men are indirectly producing their actual material life. (Marx, 1845)

When synthesizing those apparently contradictory assumptions we find that human life is dynamic in that it is based on the ability to *adapt by not adapting*—transcending the immediate means *adapting to the future*—to future possibilities and desired states which may or may not become realized when *also* adapting to the specific environmental constraints and the ever present social order. At a first glance, those basic assumptions may appear contradictory; however, approaching action from a functional perspective, Gibson already stressed the exploring intentional nature of agents (Gibson, 1966, 1986; Heft, 2001) and the meaningful nature of perception. Therefore, I do not find incommensurability between the theories, only different contributions to the understanding of dynamic phenomena in human life.

### ***Reification of Human Intentions—The Historical Nature of Human Environment***

As mentioned above, the human environment is a *produced* environment. Our human world consists of artifacts, guiding ideologies, norms, and practices. All this, of course, can be described as being more or less directly available to a human agent, however *not reduced* to its immediate appearances. A book in school, for instance, is an artifact with thing-like properties; however, its meaning lies in its produced purposes which are being materialized in the ‘thing’.

There is no simple isomorphism between the material thing and its intentional purpose, even though the thing expresses certain functionalities and affords ‘reading’. The artifacts of human ecology express and witness the particular reified wholeness of cultural and historical processes *so far*. Therefore, the notion of human environment refers not only to the presence of things and people in specific environments but *also* to the presence of an absence (temporality/historicity) of societal processes. Artifacts are expressions of the future directedness of humans, of their transcending and historical nature. One would become guilty of reductionism if ignoring this fact. The historical nature of humans is an *absent* present co-actor in the otherwise immediate individual—environment reciprocities. When an individual establishes a reciprocal relationship with her immediate cultural environments, she interacts not only with *things* and *people* being *present* present and available—she simultaneously interacts with the *intentions of humans across generations*—with what is *absent* present. Wartofsky (1979) stresses the general intentional nature of human environment:

The objectification of human intention is embodied both in the tools used in production, in the skills acquired and adapted to this use, and in the forms of symbolic communication which develop in language, in art, in dance and poetry, in their origins.... ‘environment’ is itself not a neutral term, but is what is functionally adapted to, and changed by an organism, or a population of organisms....the very environment itself, as a space of action, is invested with the characteristics of an artefact (1979, pp. 205–206).

Following this perspective, I find that human environment simultaneously has *historical* properties—reified intentions in the form of ideal and material artifacts

as well as ongoing human practices—and *functional* properties—properties which are regarded relative to some individual's (or group of individuals') actual actions (see also Bang, 2008, 2009).

### ***Reification of the Individual—Her Quasi-Environmental Properties***

The fact that humans produce their own environment (= conditions of life) certainly transcends an individualistic and hedonistic perspective which is not far from functionalist thinking. According to a Marxist notion, the individual is not primarily someone who utilizes her immediate environment for own private purposes (this happens and is regarded a distortion of her societal being) but someone who contributes with her forces to the community. Productive labor, rather than perception, is the starting point for psychology in that it is stressed how the individual offers to the community through her productive activities.

To extend Baldwin's ego—alter dialectics presented earlier one might say that the notion of 'the alter' should include the human environment in a broad sense. When applied to the discussion, Baldwin's 'alter' should not only refer to specific present social others (like a father and his daughter, or the student and her teacher). *The 'alter' should be considered a heterogeneous cultural category which includes the absent presence of history, of reifications and of practices, of that which has become removed and changed as well as that which has become created and invented.* In the human world, everything has a history and is part of ongoing changes. Cultural artifacts are invented and produced for certain purposes and they undergo changes along the way as other needs emerge and as they contribute to the emergence of new needs. Social others are human beings with agency and personal histories and they interact actively and in undetermined ways in situations, hence create new possibilities and restrictions for themselves as well as for others. The dialectical growth of self must have reference to this expanded notion of the alter, since each individual is a member of shared and co-produced historical environment which are being reified in particular forms hence appear 'immediate' to the observant individual.

When generalized to the notion of individual—environment reciprocity it seems obvious that imitating others and imitating generalized human practices by help of artifacts are closely linked processes. A child who cooks the dinner with her parent does not only imitate the actions of her parent but at the same time imitates a commonly shared practice by the help of proper culturally produced artifacts. She acts as if it is true for her that she is a cook like her parent, hence co-producing the commonly shared practice, the child-parent relationship, the food and herself in one and the same activity. The child is 'all that' potentially as she cuts the carrots her way, makes the pieces larger than her parent would do, hence puts her energy into the small community and reifies her intentions into a meal.

When thinking the Baldwinian way about developmental processes (valuing the dialectical relationship of imitation and creativity as the basis of development) and, further, when we extend his notion of the alter to mean not only the social others who are present in the developing individual's life but the human environment and its societal and historical nature—it increasingly grows difficult to remain satisfied with the simple individual—environment reciprocity which still seems to build on the idea that what we research is the individual in herself who stands in a relationship with her environment that surrounds her. In any activity where an individual reifies her intentions (even the child who helps cook a meal) she transcends the usual dichotomy between what 'belongs' to the individual and what 'belongs' to the environment. Through her activities, the individual becomes part of her own environment. The child mirrors herself in the carrots which she cuts and she creates a new dimension which merges with the initial one in that the evaluation (supporting comments from her parent, for instance) of her creativity grows to become part of the activity as well and of her ways of understanding herself.

While participating in cultural practices, the individual experiences her own participation in the situation *as* part of practice. In short, I suggest *self* to also be relevant in relation to the notion of environment. More precisely, two dimensions of self—that of *experiencing own participation* in a situation and that of *experiencing oneself as a person participating* in a situation—should be considered parts of the reification processes. In this sense, the individual herself becomes part of her environmental properties through her activities.

This analysis expands the notion of environment to include the experiencing individual herself—the individual is not just the centre of perceiving, acting, experiencing; she also is a *quasi-artifactual* environmental property to others, hence to herself. This notion of environment radicalizes the issue of *what is inside and what is outside* of the individual of *what is mind and what is environment*; it is an ecological position which does not stop with the simple individual—environment reciprocity whether this is formulated in mechanical or in mutualist terms.

Adding 'self' to the environmental analysis adds to the notion of Gestalt qualities of the situation researched. The co-perceiving of oneself as a participant and as an existential person should be viewed as a Gestalt quality as well. The individual is available to herself in the co-constitution of the situation. Gestalt qualities, hence, have not only reference to purely 'objective' phenomena (in the sense of not depending on the perceiving individual)—it is an overall quality of individual—environment reciprocity as well.

In the process of participation (like the students of the example above) the individual remains the centre of experience and of agency. At the same time the individual is one among other participant in the particular social practice. She therefore inhabits a double-position as *an agent* and as *a cultural being*. In the situation, her agency and her quasi-environmental qualities merge with the overall Gestalt qualities of the situation and the individual becomes able to co-experience herself as a person participating. Participating in a situation may feel comfortable and meaningful to an individual or uncomfortable and meaningless. How it is experienced by an individual is part of a complex dynamic of her life and she includes this

perspective in any present situation of participation. An individual may very well feel, for instance, that no changes of a situation or of her participation is possible or that alternatives are so challenging and filled with anxiety that she makes non-developmental generalizations about herself which makes her stick to passivity or circular self-protecting patterns of participation, some of which at the same time prevents the individual from actively altering her own conditions of life. The learning situation discussed in the present paper might be regarded as both contributing to personal growth and putting limitations on personal growth. Any single of those interpretations probably would be wrong because no situation is simple and unidirectional in its Gestalt and in its potentials.

## Conclusions

Dynamic methodologies are empirically and theoretically informed tools which are helpful in the research of developmental processes. In the present paper I have argued that to develop such tools psychology should take the individual—environment reciprocity seriously both when it comes to the question of what kind of phenomena are we studying and when it comes to the question of how to understand the theoretical terms themselves. The foundational issue addressed was elementarism, but here I have attempted to get beyond elementarism by applying the method of theoretical concreteness on a particular example. The example itself, of course, serves paradigmatic purposes which are to focus on the overall presence of synthetic phenomena to be researched in the everyday life of humans. As a result of the synthetic phenomena presented, it was argued that dynamic methodologies need to rest on theories which are capable to grasp the wholeness of heterogeneities and contradictions out of which synthesis grows. This theoretical endeavor led to attempts to re-consider the notions of ‘individual’ and ‘environment’ as those ‘parts’ which make up the reciprocity. Especially it was argued that the historical nature of human living should be taken seriously when conceiving the notion of environment; further, it was argued that when taking the notion of reciprocity seriously, it becomes radicalized. ‘Inner’ and ‘outer’, ‘mind’ and ‘environment’ distinctions could not be preserved in the traditional form (meaning that the individual has a mechanical exchange with the environment). Through her agency the individual becomes part of her environment and acquires quasi-environmental properties. This, in the end, offers her chances to include self-experiences into the synthetic processes in which she takes part.

These are the principles working in the dynamic human field and what dynamic methodologies should be become able to grasp. In addition to this story a few further problems might become resolved; one of them being the ‘mediation’ metaphor and its hidden dualist roots (Costall, 2007); the other being the repeated discussion whether an experience of something should be rooted in realism or in mutualism—this includes phenomena like ‘affordances’ (Costal, 1986) or ‘the ideal’ (Stetsenko, 2005). Both, of course!

## References

- Baldwin, J. M. (1897). The genesis of social “interests”. *The Monist*, 7, 341–357.
- Baldwin, J. M. (1899/1973). *Social and ethical interpretations in mental development*. New York: Arno Press.
- Baldwin, J. M. (1906). *Thought and things, or genetic logic. I: Functional logic, or genetic theory of knowledge*. London: Swan Sonnenschein.
- Baldwin, J. M. (1908). *Thought and things, or genetic logic. II: Experimental logic, or genetic theory of thought*. London: Swan Sonnenschein.
- Baldwin, J. M. (1911). *Thought and things, or genetic logic. III: Interest and art being real Logic*. London: Swan Sonnenschein.
- Baldwin, J. M. (1915). *Genetic theory of reality*. New York: The Knickerbocker Press.
- Baldwin, J. M. (1930). Autobiography of James Mark Baldwin. In C. Murchison (Ed.), *A history of psychology in autobiography* (pp. 1–30). Worcester, MA: Clark University Press.
- Bang, J. (2006). Hvad er en læresituation? In B. Elle, K. N. Nielsen, & M. Nissen (Eds.), *Pædagogisk Psykologi – Positioner og Perspektiver* (pp. 103–122). København: Roskilde Universitetsforlag.
- Bang, J. (2008). Conceptualising the environment of the children in a cultural-historical approach. In M. Hedegaard & M. Fleer, J. Bang, & P. Hviid (Eds.), *Studying children: A cultural-historical approach* (pp. 118–138). London: Open University Press.
- Bang, J. (2009). An environmental affordance perspective on the study of development—Artefacts, social others, and self. In M. Hedegaard, M. Fleer, & J. Tudge (Eds.), *World yearbook of education* (pp. 160–178). New York: Routledge.
- Barker, R. (1968). *Ecological psychology: Concepts and methods for studying the environment of human behavior*. Stanford, CA: Stanford University Press.
- Barker, R., & Wright, H. (1966). *One boy's day—A specimen record of behavior*. Connecticut: Sted Archon Books.
- Barker, R., & Wright, H. (1971). *Midwest and its children—The psychological ecology of an American town*. Hamden, CT: Archon Books.
- Bronfenbrenner, U. (1977). Toward an experimental ecology of human development. *American Psychologist*, 32(7), 513–531.
- Chaiklin, S., Hedegaard, M., & Jensen, U. J. (Eds.). (1999). *Activity theory and social practice: Cultural-historical approaches*. Aarhus: Aarhus University Press.
- Cole, M. (1997). *Cultural psychology: A once and future discipline*. Cambridge, MA: Belknap Press of Harvard University Press.
- Costall, A. (1981). On how so much information controls so much behaviour: James Gibson's theory of direct perception. In G. Butterworth (Ed.), *Infancy and epistemology: An evaluation of piaget's theory*. Hemel Hempstead: The Harvester Press.
- Costall, A. (1986). The “psychologist's fallacy” in ecological realism. *Teorie & Modelli*, III (1), 37–46.
- Costall, A. (2007). The windowless room: ‘Mediationism’ and how to get over it. In J. Valsiner & A. Rosa (Eds.), *Cambridge handbook of sociocultural psychology* (pp. 109–123). Cambridge: Cambridge University Press.
- Davydov, V. V. (1977). *Arten der Verallgemeinerung im Unterricht*. Berlin: Volk und Wissen.
- Dewey, J. (1896). The reflex arc concept in psychology. *Psychological Review*, 3, 357–370.
- Ehrenfels, C. v. (1988). On ‘Gestalt qualities’. In B. Smith (Ed.), *Foundations of Gestalt theory* (pp. 82–117). München: Philosophia. (Original work published 1890: über Gestaltgüalitäten)
- Gibson, J. J. (1966). *The senses considered as perceptual systems*. Boston: Houghton Mifflin.
- Gibson, J. J. (1986). *The ecological approach to visual perception*. Hillsdale: Lawrence Erlbaum Associates.
- Good, J. M. M. (2007). The affordances for social psychology of the ecological approach to social knowing. *Theory & Psychology*, 17(2), 265–295.

- Hedegaard, M. (2002). *Learning and child development: A cultural-historical study*. Aarhus: Aarhus University Press.
- Heft, H. (1988). Affordances of children's environments: A functional approach to environmental description. *Children's Environments Quarterly*, 5(2), 29–37.
- Heft, H. (2001). *Ecological psychology in context—James Gibson, Roger Barker, and the legacy of William James' radical empiricism*. Mahwah, NJ: Lawrence Erlbaum Associates.
- Hegel, G. W. F. (1812/1969). *Hegel's science of logic*. London: George Allen & Unwin.
- Holzkamp, K. (1983). *Grundlegung der Psychologie*. Frankfurt/M: Campus.
- James, W. (1912). *Essays in radical empiricism*. New York: Longmans, Green, and co.
- Marx, K. (1845). *The German ideology*, Part I; A: Idealism and materialism: First premises of materialist method. Available at <http://www.marx.org/archive/marx/works/1845/german-ideology/ch01a.htm>.
- McNeil, L. (1988). *Contradictions of control: School structure and school knowledge*. New York: Routledge & Kegan Paul.
- Piaget, J. (1957). *Logic and psychology*. New York: Basic Books INC.
- Stetsenko, A. (2004). "Tool and sign in the development of the child". In R. W. Rieber & D. K. Robinson (Eds.), *The essential Vygotsky*. New York: Kluwer.
- Stetsenko, A. (2005). Activity as object-related: Resolving the dichotomy of individual and collective planes of activity. *Mind, Culture, and Activity*, 12(1), 70–88.
- Still, A., & Costall, A. (1991). The mutual elimination of dualism in Vygotsky and Gibson. In A. Still & A. Costall (Eds.), *Against cognitivism: Alternative foundations for cognitive psychology* (pp. 225–236). Hertfordshire: Harvester Wheatsheaf.
- Tudge, J. (2008). *The everyday lives of young children: Culture, class, and child-rearing in diverse societies*. New York: Cambridge University Press.
- Tudge, J., Putnam, S., & Valsiner, J. (1990). Culture and cognition in developmental perspective. In R. B. Cairns, G. H. Elder, & E. J. Costello (Eds.), *Developmental science* (pp. 190–222). New York: Cambridge University Press.
- Valsiner, J. (1997). *Culture and the development of children's action*. New York: Wiley.
- Valsiner, J. (2008). Baldwin's quest: A universal logic of development. In J. Clegg (Ed.), *From past to future: Annals in the history of psychology*. New Brunswick, NJ: Transaction Publishers.
- Valsiner, J., & van der Veer, R. (1993). The encoding of distance: The concept of the zone of proximal development and its interpretations. In R. R. Cockling & K. A. Renninger (Eds.), *The development and meaning of psychological distance* (pp. 35–62). Hillsdale, NJ: Lawrence Erlbaum Associates.
- van der Veer, R., & Valsiner, J. (1991). *Understanding Vygotsky: A quest for synthesis*. Oxford: Basil Blackwell.
- van der Veer, R., & Valsiner, J. (Eds.). (1994). *The Vygotsky reader*. Oxford: Basil Blackwell.
- Vygotsky, L. (1978). *Mind in society*. Cambridge: Harvard University Press.
- Wartofsky, M. (1979). Perception, representation, and the forms of action: Towards an historical epistemology. In *Models-representation and the scientific understanding* (pp. 188–210). Boston: D. Reidel.

# Chapter 26

## Developmental Science: Integrating Knowledge About Dynamic Processes in Human Development

Herbert Scheithauer, Kay Niebank and Angela Ittel

There is an increasing need to develop an interdisciplinary model that describes the dynamic processes in human development. During the last decades several different theories depicting dynamic developmental processes have been formulated (Granic, 2005; Granic & Hollenstein, 2003), such as general systems theory (von Bertalanffy, 1986), developmental systems theory (Ford & Lerner, 1992), the ecological framework (Bronfenbrenner, 1979), the transactional perspective (Sameroff & Chandler, 1975; Sameroff & MacKenzie, 2003a, 2003b), nonlinear dynamics (Savelsbergh, van der Maas, & van Geert, 1999), the holistic-interactionistic-view (Bergman, Cairns, Nilsson, & Nystedt, 2000), or the epigenetic view (Gottlieb, 1991). According to Witherington (2007), these different theories can be grouped into either a contextualist developmental systems perspective and/or an organismic-contextualist developmental systems perspective.

However, developmental systems perspective (DSP) seems to be one of the more promising approaches to depict through the concept of interdependent systems of self-organization how developmental patterns arise (Witherington, 2007). The focus is on the question of how “changes at the micro-level of relationships between a system’s constituents give rise to new patterns of behavior at macro-levels” (Lavalli, Pantoja, Hsu, Messinger, & Fogel, 2005, p. 45). That is development is understood as arising from the individual and the environment, not from a maturational plan within the individual as traditional developmental theories often hold. Instead, DSP holds that the components of a system act together—according to self-organizational characteristics of complex systems—to constrict the multiple actions of other components leading to stable patterns of behavior called “attractors”. Development is conceptualized as the reorganization of prior attractors that lead to the emergence of new observable behavioral patterns at the micro level through self-organization processes (Lavalli et al., 2005).

---

H. Scheithauer (✉)

Division of Developmental Science and Applied Developmental Psychology  
Freie Universität Berlin  
14195 Berlin, Germany  
e-mail: hscheit@zedat.fu-berlin.de



Developmental systems theories (DST) postulate a slightly different view. They are concerned with the relation between individual and context—more specifically, with a dynamic, or fused and multiple relation among levels of organization integrated within the developmental system (Lerner, Dowling, & Chaudhuri, 2005; cf. Josephs & Valsiner, 2007). Changes in the relationships among levels of organization constitute the process of human development and any component of the system affects and is affected by all the other components of the system with which it is embedded. The key intellectual challenge for developmental science is the thorough understanding of the system involved in linking individuals and contexts (Lerner, Lerner, De Stefanis, & Apfel, 2001).

Although research models in psychology and developmental psychology have increasingly acknowledged the importance of the concepts put forth in the DSP it is still controversial whether the contextualist world view and the consequential paradigm shift is primarily a formal (in the mathematical sense) or empirical realization of von Bertalanffy's (1968) general systems theory tenets. In addition, there is no agreement concerning the conceptual cohesiveness of the multiple approaches that fall under the general category of 'dynamic systems' (Witherington, 2007). However, it is generally agreed that the DSP offers a 'grand narrative' framework for developmental psychology and related disciplines that promises to unite the field through its focus on both stable pattern and local variability, on developmental global order and on the particulars of real-time task-specific contexts.

Thus the DSP is viewed as a unifying meta-theoretical framework (Granic & Hollenstein, 2003; Witherington, 2007; cf. comment by Overton, 2007) for a set of abstract principles of development that have been applied within "different disciplines (...) and to various phenomena (...) at vastly different scales of analysis (from cells to economic trends)" (Granic & Hollenstein, 2003, p. 644).

A common conception of the approaches within this framework is that an individual organism is a complex system due to the interrelations of its lower level components (e.g., organ systems and cells) (Diez Roux, 2007). Furthermore, it is now a common understanding that findings from various disciplines (e.g., genetics, neuroscience) are fundamental to understand human developmental processes exhaustively. In our view, this approach is best exemplified by the discipline of developmental science. In the present chapter we will give a summary of the core-elements of developmental science that guide our work (see Petermann, Niebank, & Scheithauer, 2004; Scheithauer, Niebank, & Gottlieb, 2007) to illustrate how the principles of the DSP are compatible with developmental science's core conceptual concerns.

## Scope and Aims of Developmental Science

The task of developmental psychology is "the description, explanation, and modification (optimization) of intraindividual change in behavior and interindividual differences in such change across life span" (Baltes, Reese, & Nesselroade, 1977, p. 84).

Developmental science takes a broader approach by being devoted to the study of the interplay of changes in individuals across the life span and thereby considering psychological, biological, social, societal, historical, and cultural levels and their interdependent systems (cf. Cairns, 1996; Carolina Consortium on Human Development, 1996; Petermann et al., 2004). The interdisciplinary field of developmental science connects concepts and findings from various disciplines (e.g., psychology, anthropology, biology, communication science, neuroscience, linguistics, medical science, ethology, philosophy, and sociology), each traditionally concerned with human and non-human development separately. In other words: developmental science is—just like DSP—a metatheoretical approach rooted in developmental principles to guide empirical work and thinking on biology and social behavior and their interactions over ontogeny (Magnusson & Cairns, 1996).

Taking the above mentioned considerations into account it becomes clear that developmental science does not pursue the same goals as developmental psychology or developmental psychopathology. In fact, developmental science differs in several aspects from these sub-disciplines of psychology (cf. Scheithauer et al., 2007):

1. Unlike developmental psychology developmental science is concerned with typical or normative social, emotional, and cognitive (including language) development, as well as with the development of abnormal behavior (developmental psychopathology) not *in separate but holistic models*.
2. Developmental science therefore adds to the study of traditional developmental approaches of psychology by examining these phenomena by simultaneously taking into account the methods and perspectives of e.g., biology (genetics, neuroscience), sociology (societal institutions and traditions over the lifespan), and anthropology (cultural influences).
3. To realize such an approach, intradisciplinary (i.e., different theories and models within psychology) and inter-/transdisciplinary (i.e., different theories and models from different disciplines) perspectives are needed.

Thus, the interdisciplinary field of developmental science comprises a holistic approach (Bergman et al., 2000) to understanding how different systems interact and influence development throughout life from genetic and physiological processes to social interactions and cultural processes.

### ***A Biopsychosocial Approach: The Transactional Model of Development***

Developmental science is based on two perspectives which (1) provide a substantial biopsychosocial frame not confusing the “genetic” and the “biological” level of development (biopsychosocial perspective); (2) clearly explicate change over time—that is transactions of the different levels of development over time (developmental perspective).

According to the biopsychosocial perspective, development is not directed nor programmed by genes or by an additive combination of genes and environment. Simple dichotomous constructs concerning genes and environment are inadequate to explain development. But it is this Cartesian duality which has hindered the progress of developmental science by inspiring counter-productive debates about counterfactual division of variables and processes of human development (e.g., nature vs. nurture, organism vs. environment etc.; Jelic, Theokas, Phelps, & Lerner, 2007). Behavioral genetics on the base of twin and adoption studies have been criticised by several researchers as these studies are based on a technical statistic called “heritability” (for a discussion see Petermann et al., 2004, p. 237; Ehrlich & Feldman, 2003). Furthermore, the study of human development does not allow an easy quantification and manipulation of genetic and environmental variables, thus limiting our abilities to assess *Genes × Environment* interaction. Another limitation arises from the fact, that gene expression is dynamic over time (Gottesman & Hanson, 2005). “Just as it is unlikely that single genes or combinations of genetic material can be used alone to predict variation in complex disorders, it is also unlikely that we will be able to understand relationships between genes and environments without placing them within a developmental context” (Bennett, 2008, p. 49). Current research on the impact of genetics has to move beyond simply demonstrating genetic influence by asking questions about genetic change and continuity during development (see Plomin, 2004 for a review). Rather, development results from a nonlinear combination of various factors, a process that is not restricted to an individual organism but happens within an organism-environment system (cf. Wagman & Miller, 2003). Even though this interaction finds more and more support in the developmental literature, many approaches still employ a very simplistic model—especially on an empirical and methodological level. The continuous adherence to a simplistic conception of development and gene-environment interaction is partly due to an impenetrable conception of the pre-eminence of genes, which does not adequately consider genetic structures; namely, the fact that genes consist of relatively simple double strands of nucleic acid that only play one part rather than direct the intracellular production of proteins. It surely is an essential part but genes are not in the position to direct development. The tradition to observe only the physical and social world around us as “environment” while the term “gene” stands for everything that is biological caused Gottlieb (2003) to demur that much of what passes for gene-environment interaction is actually organism-environment interaction. When we do simply distinguish between genes and environment as driving forces behind development, everything surrounding the genes must be environment. When the same genes are expressed differently in nerve cells and in muscles, this is clearly a function of the cellular environment. Hence environment begins on the cellular level, includes tissue and organism, and extends to the external environment.

According to the perspective of developmental science as a trans- and interdisciplinary field, it is necessary to combine a biopsychosocial view of development, considering the reciprocal relationship of environment, phenotype and genotype, with a view on human development, that takes into account the individual development over time. An early example is represented by a model that Sameroff and Chandler (1975) originally proposed to depict the issue of the nature-nurture

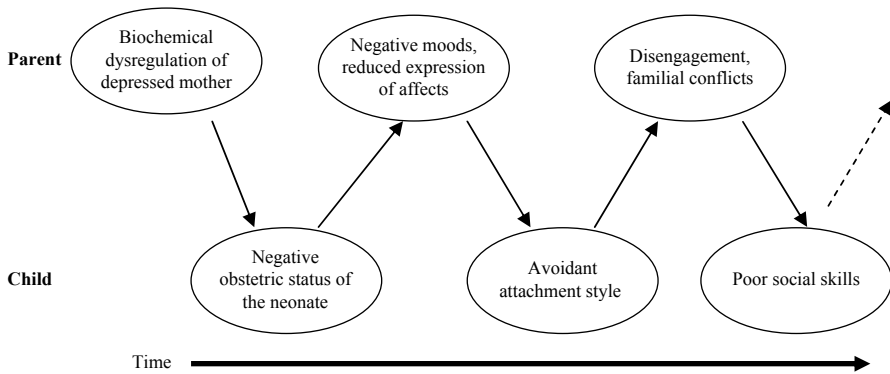

**Fig. 26.1** Transactional model of development (modified from Sameroff & MacKenzie, 2003a, p. 17) applied to interactions between depressed mothers and their children according to Berg-Nielsen, Vikan, and Dahl (2002); Martins and Gaffan (2000); Murray and Cooper (1997); Psycho-social Paediatrics Committee, Canadian Paediatric Society (2004)

problem: their transactional model of development (Fig. 26.1) (for a review of representative studies where the transactional model has been explicitly or implicitly tested, see Sameroff & MacKenzie, 2003b).

This model depicts a transactional process of development between depressed mothers and their children. Sameroff and Chandler's (1975) model expands the view on reciprocal relationship of parenting and children but highlights the importance of the ever changing and interdependent, situation specific relations of children's constitutions and the care giving environment. That is: (1) both—the child and the environment—are in a state of active reorganization and change over time and (2) to combine influences of the child's biological heritage and life experience in a dynamic system implies that the controversial discussion concerning the nature-nurture debate about the proportional influence of each factor on development becomes obsolete (Sameroff & MacKenzie, 2003a, 2003b) because the same genes are expressed differently in each cell as a function of their environment while the same parents respond differently to each of their children as a function of their individuality. "The development of the child" according to the transactional model "is a product of the continuous dynamic interactions between the child and the experience provided by his or her family and social context" (Sameroff & MacKenzie, 2003a, p. 16). The environmental experiences are not viewed as independent of the child.

### ***Ontologic Development—From Predetermined to Probabilistic Epigenesis***

As explicated in the beginning of this chapter, development can be regarded as result of the continuous dynamic interactions between different levels within a developmental system. This conception which involves the levels of genes, chromosomes,

nucleus, cytoplasm, tissue, organism, and external environment to explain development was already evident in Paul Weiss' (1959) hierarchical model— 50 years ago. In his thinking development is not a unidirectional process starting with genetic activity. According to the observation that environmental influences such as social interaction or the duration of daylight result—via intermediate steps—in genetic activation, Paul Weiss assumed bidirectional influences, from gene to environment and vice versa.

Already in 1968, Sewall Wright proposed a model in which he argues that genes can not be viewed as being isolated from the interacting system of development. That is, Wright holds that the genetic activity is subject to feedback effects during the course of individual development. According to this model genes do not stand at the beginning of a causal chain that directs development. He describes development as an entangled web of causes and effects, a system which genes are only one part of. The organism is the result of an epigenetic development, involving genes and other influences. In his conception, genetic activity is regulated by signals from the internal and external environment.

As can be seen, there have been several early theorists that proposed ideas which put the outdated concept of the predetermined nature of epigenetic development into question. One major criticism was that genetic activity was believed to inspire neural maturation in a unidirectional way, leading to the development of innate or instinctive behavior. The dichotomy between instinct and learning was emphasized especially by Konrad Lorenz (cf. 1981), who proposed “deprivation experiments” as a method to distinguish learned from innate behavior. The idea was that if an animal is deprived of the opportunity to learn a certain behavior and if the behavior still develops in a normative function this behavior has to be innate. However this logic to distinguish innate vs. “instinctive” behavior holds several pitfalls. It is impossible to deprive someone of all learning experiences by any experimental manipulation insuring that all relevant causal variables are controlled. Animals raised in isolation live in a highly controlled environment, but they are never raised deprived of all environmental stimuli. Hence it seems simplistic, to conclude that behavior is innate just because we can not immediately identify a set of manipulated variables that trigger a certain behavior by an isolation experiment.

Obviously, even though the roots of a more complex conception of development were set by theorists such as Wright and Weiss, the contribution of how “genes work” was poorly understood up to the second half of the last century. Genes were seen as causal factors underlying “nature” and seemingly unchangeable behavior was account for by the genetic determination. A direct link between genes and (instinctive) behavior was widely accepted as well as the idea that any behavior, at least under prenatal conditions, must develop through genetically guided maturation. The idea was that if we knew enough about the information encoded in genes, if we could read the genetic blueprint, we would be able to translate the base sequence of the DNA and reveal the structure of behavior. The central dogma of molecular biology claims a unidirectional and predetermined causal chain linking genes through structure and physiological function to behavior. Gottlieb (1970) coined the term “predetermined epigenesis” for this prevailing view of developmental processes:

## Genes → Structural maturation → Function → Behavior

In this sense, developmental geneticists who study how genes control development often discuss their results on the base of a predetermined epigenetic view: “From a fertilized egg cell to birth as a newborn baby, our genes dictate our development”.<sup>1</sup> However, “epigenetic perspectives grapple with the complexities of how multiple genetic factors and multiple environmental factors become integrated over time through dynamic, often nonlinear, sometimes nonreversible, processes to produce behaviourally relevant endophenotypes and phenotypes. How an embryonic cell differentiates into a liver cell while a genetically identical cell in the same embryo develops into a neuron is an epigenetic question.” (Gottesman & Hanson, 2005, p. 267f.).<sup>2</sup>

The future of genetic research in developmental psychology lies—according to leading scientists in the field of genetic research (e.g., see Plomin, 2004)—in molecular genetic studies of DNA to identify specific DNA variants responsible for the influence of genes in psychological development. Today it is well known that DNA establishes the nucleotide structure of mRNA, which then translates into the structure of the particular protein. The role of genetic activity in producing proteins is often sketched in this uni-linear process that is from our knowledge today not incorrect but a much too simplistic depiction of these processes. Due to the fact that DNA is an inert molecule, genes can not control their impact but depend on intracellular signals. Gene expression is influenced by the immediate environment of the nucleus of the cell, the cytoplasm. Cytoplasm itself can be influenced by the external environment of the organism (physical, social, cultural) via the behavior of the organism (e.g., stress hormones, intake of drugs or toxic agents). Hormones are responsive to the organism’s experience in the external world. They make their way into the nucleus of the cell and trigger the expression of genes. Depending on these particular factors different proteins are formed. Hence, genes do not act as independent causes but as part of a large and complex developmental system, their expression is determined by influences from other levels of the system. However, the environment—which is of immediate relevance for genetic activity—is not the configuration of stimuli the organism is exposed to but the state of affairs in the cytoplasm where the genes physically reside. Thus, there is no direct link between genetic activity and the behavioral phenotype or a finished neural product (Gottlieb, 2003).

Gottlieb (1970) contrasted the view of “predetermined epigenesis” with a more complex alternative called “probabilistic epigenesis”:

## Genes ↔ Structural maturation ↔ Function ↔ Behavior

<sup>1</sup> Eccles Institute of Human Genetics: <http://www.genetics.utah.edu/faculty/developmentalgenetics.html>

<sup>2</sup> For reviews of epigenetic concepts relevant to human development (see Gottesman & Gould, 2003; Nijhout, 2003; Petronis et al., 2003).

His conceptions of development differ markedly from other theories in terms of the presumed causal relations among events occurring at the different levels. In contrast to predetermined epigenesis, probabilistic epigenesis emphasizes the reciprocity of influences within and between the different levels (social and cultural influences, behavior, neural and genetic activity). In this probabilistic epigenetic view bidirectional interactions occur between the components, thus forming feedback-loops in a system that becomes potentially self-organizing.

It is important to point out that the product of a single gene cannot alone be responsible for a certain behavior and underlying processes, but it is usually involved in molecular processes that construct the brain, in an overall process that itself relies on activity-dependant changes. Merely trying to relate genes to an outcome leaves out the environmental component and perhaps the reason for the fact that the failure of replications of these gene-phenotype associations are legion (cf. Gottlieb, 2003). Apart from genetic and environmental factors that affect development, the individual history of every human being determines how a person reacts to environmental factors. The personal experiences become part of their continuously developing individuality that in turn determines how each person reacts even to stable situations each and every time. This assumption is consistent with findings within the realm of neuroscience, concerning the interaction between brain and environment during the course of development which are responsible for the development and functioning of neural structures (cf. Petermann et al., 2004). Pre-existing features of the individual (e.g., physical, brain structure), that are the results of preceding development synchronize with current experiences and genetic activities during periods of reorganization in ways that enhance individual functioning.

To obtain consistent (e.g., replicable) results, it is essential to link genes with environmental factors or life experience. Empirical examples that support this assumed link can be derived from studies of developmental psychopathology. On the one hand social factors are found to be modifiers of genetic effects. Caspi et al. (2003) for example reported that a functional polymorphism in the promoter region of the serotonin transporter gene (5-HTT) moderated the relationship between stressful life events and depression: stressful life events were only related to depression in the presence of the genotype. In another study Kaufman et al. (2004) found that the measures of the quality and availability of social support were found to moderate risk for depression associated with a history of maltreatment and the presence of the short allele of the serotonin transporter gene promoter polymorphism (5-HTTLPR). Thus, the risk for negative outcomes may be modified by both genetic and environmental factors, with the quality and availability of social support among the most important environmental factors in promoting resiliency in maltreated children, even in the presence of a genotype expected to confer vulnerability for psychiatric disorder. According to Cicchetti and Blender (2004), these results underline the necessity of a multiple-levels-of-analysis approach to the study of developmental processes in maltreatment.

“Under this scenario partitioning out contributions of ‘social’ and ‘biologic’ components becomes a futile exercise. This is because the environmental variation depends on the genotypic distribution, and the genotypic variance depends on the

environmental variance (Feldman & Lewontin, 1975, p. 1166)” (Diez Roux, 2007, p. 570). On the other hand, social and biological factors should be seen as tightly entwined in social systems. As a consequence social processes are not just antecedents and do not just function as modifiers or moderators of biological processes but are an integral part of these processes (Diez Roux, 2007). The current discussion concerning the obesity epidemic provides another illustrative example of the gene-environment relations. Commonly, a wide range of individual risk factors such as genetic, behavioral, and social characteristics, are treated as isolated factors in their relation to obesity. The results from these studies are then understood as providing explanatory evidence for each individual persons’ weight level. In the attempt to explain the current epidemic, these results are simply aggregated. A systems approach that considers the interdependence of the social, behavioral and genetic characteristics would not attempt to isolate single factors but develop a model that describes all factors on a macro level and micro level and their subsystems in which the obesity epidemic is embedded, e.g., the mass production and marketing of foods, the organization of food transportation, and the adherence to social norms concerning eating behaviors and body size. The resulting model would describe the interrelationship between these components. Within the systems’ view a model is never understood to be definite but to increase in complexity with the increasing understanding of the epidemic. The model could then be used to predict system changes in response to an intervention. A model that has been developed under these considerations necessarily integrates social and biological factors into the functioning of the system (Diez Roux, 2007) and characterizes any abnormal behavior as an emergence of patterns in different domains (e.g., biological, cognitive, emotional) simultaneously. These domains are nonlinearly related to one another and change qualitatively, as well as quantitatively (Granic & Hollenstein, 2003).

A model (see Fig. 26.2) proposed by Gottlieb (2002) (cf. Gottlieb, 2007; Halpern, Hood, & Lerner, 2007) combines reciprocal influences and changes over the course of development and consists of four major levels: genetic activity, neural activity, behavior, and environment. The model depicts a fully bidirectional co-actional system with genes *not standing outside* the system but forming an integrated part of it. Developmental understanding is in this sense a multilevel affair involving at a minimum the surrounding culture, society, immediate social and physical environments, anatomy, physiology, hormones, cytoplasm, and genes. Traditionally, professionals

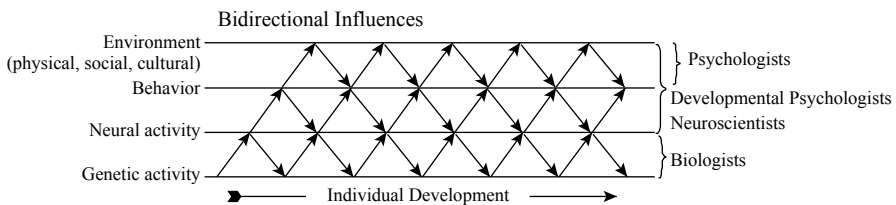
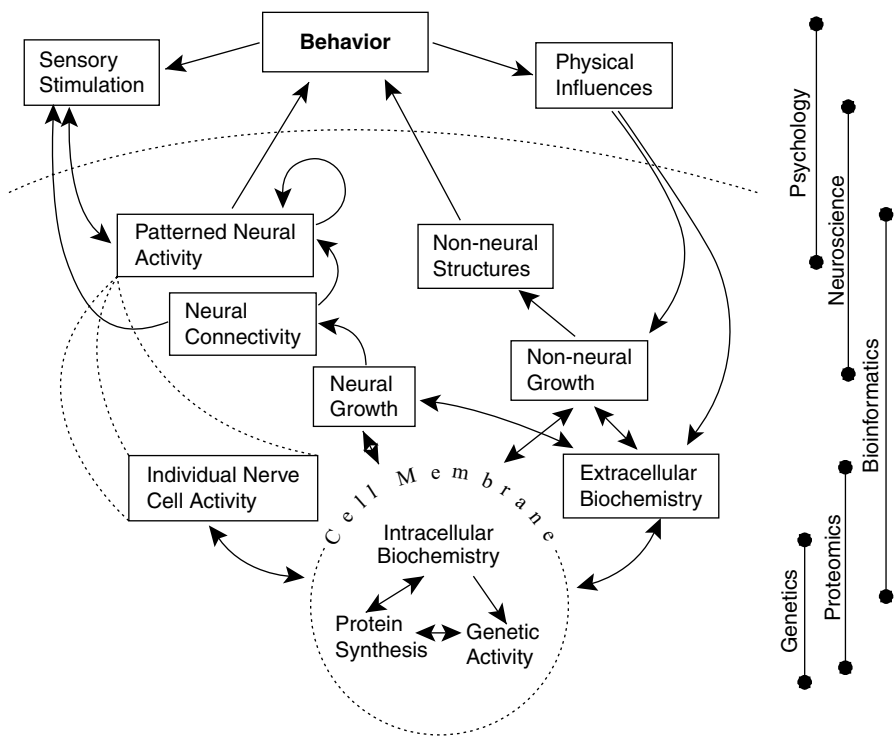

**Fig. 26.2** Depiction of the completely bidirectional nature of genetic, neural behavior, and environmental influences over the course of individual development (taken from Gottlieb, 2002, p. 186, modified by the authors)



from the various disciplines are working at the different levels of the model (at the right hand side of the diagram, see Fig. 26.2). But as it is also evident in the model: trans-, inter- and intradisciplinary approaches are necessary to understand the complex nature of ontogenetic development.

But how do the different levels in Fig. 26.2 interact to contrive ontogenetic development? How are genes related to concrete every day behavior? Johnston and Edwards (2002) have substantially “unpacked” G. Gottlieb’s bidirectional model and demonstrated that there are no direct links between someone’s genes and his or her behavior but argue that there is a large number of steps that intervene between genetic activity and behavior (Fig. 26.3). Their model shows all the interacting factors involved in the developmental construction of behavior like sensory stimulation, genetic activity, neural connectivity, protein synthesis, and intracellular biochemistry. Johnston and Edwards’ model (Fig. 26.3) extends and explicates the important features of Gottlieb’s model (Fig. 26.2) in four ways:



**Fig. 26.3** Model of gene-environment-interactions shaping behavioral development by Johnston and Edwards (2002, p. 27, modified by the authors). *Solid arrows* represent a causal relation. *Dotted lines* indicate spatial connections: (a) The factors within the cell, surrounded by the cell membrane, (b) inner-organismic factors, divided from factors outside the organism, and (c) individual nerve cell activity that is also part of patterned neural activity. Note that the mentioned disciplines on the *right side* of the model are only a selection of disciplines that study factors of behavioral development and that the lines indicate the most frequently studied factors

1. It integrates all co-acting factors involved in the developmental construction of behavior, like neural and non-neural elements or sensory stimulation. Non-neural elements encompass hormonal influences, which constitute part of the extracellular biochemistry, bones, hair, muscles and so on. Sensory stimulation is not only dependent on the nervous system (determining the sensitivity to stimulation) and the current state of neural activity but also influenced by behavior (i.e., the organism produces and modifies the received stimulation e.g., by moving about in its environment).
2. The model places genes not outside but treats them as integral part of the developing system, influencing behavior indirectly and not directly (the genetic effects on behavior are mediated through the cell membrane and subsequent co-actions among cells and neural networks).
3. The model holds that an enduring effect of experience on behavior is almost certainly mediated through changes in genetic activity. The model further exemplifies the pathway by which experiences activate genes, mediated by neural activity and makes the statement of developmental theory more precise that “there can be no genetic effects on behavior independent of the environment and there are probably no environmental effects on behavior independent of genetic activity” (Gottlieb, 2003, p. 351). Caspi et al. (2002) for example demonstrated that in individuals with a genotype that was associated with low levels of the neurotransmitter monoamine oxidase A (MAOA), those who experienced no maltreatment in their younger years were unlikely to be violent in adulthood. Those individuals having the same genotype but also having a history of being severely maltreated showed a higher rate of violent behavior in adulthood than the aforementioned group. But even in the latter group, epigenesis of antisocial behavior is still probabilistic. However, even in the group of severely maltreated individuals, fifteen percent did not develop antisocial behavior, in spite of their low-activity MAOA genotype.
4. The model also recognizes that although the activity of individual cells is nested within the patterns of activity of cell networks, there are two levels at which neural activity must be analyzed. Because individual cell activity neither causes nor is caused by the patterns of activity in cell networks.

To summarize: The cellular environment invariable modifies the functioning of genes in an inseparable, concurring system, just as the surrounding environment constantly influences biological systems. Without an extensive comprehension of the dynamic relations between biological substrates and social context it may be as impossible to predict behavioral outcomes on either the individual or population level as it is to predict phenotype from genomic and proteomic databases alone (Gottlieb, 2003; Diez Roux, 2007; cf. Lickliter, 2007).

### ***Probabilistic Epigenesis and Self-Organization***

As demonstrated before, genes can never determine structure, function or behavior “on their own”. Cognition, perception, and behavior are always products of

processes occurring not within the organism, but instead within the organism-environment system (Wagman & Miller, 2003) making it much more complicated to predict developmental outcomes. A systems perspective as outlined above holds that the assumed linear and causal links and variations among the genotype, the environment, and their interactions are misleading (Shanahan, Sulloway, & Hofer, 2000). To understand developmental processes we need a new approach, a theory of self-organizing complexity (Cicchetti & Tucker, 1994; Oyama, 1989). The term self-organization indicates the process, when an open system (a system that is potentially subject to external influences) changes into a new state without the intervention of external directing forces (see van der Maas & Hopkins, 1998). Self-organization can also be defined as the ability of a system to attain from itself a new spatial, temporal or functional structure as the result of the dynamic interaction of this system with the environment. Depending on the mathematical equations that are used to describe the development of different systems, such as the cells in a brain or the members of a family, the systems are distinguished into linear and nonlinear systems. Linear systems are also called deterministic because of the possibility to predict the course and endpoint of their development. In contrast, nonlinear, living systems react extremely sensitive to initial and contextual conditions. This sensitivity forms the basis for their instability but is the basis for their adaptability at the same time. As a consequence it is impossible to predict how a living system will develop because it is self-organizing within an environment that is self-organizing itself (cf. Ford & Lerner, 1992). Molenaar (2007) argues that the growth of neural networks and other forms of biological pattern formation is successfully explained by nonlinear dynamical models of epigenetic processes. Individual differences in cortical architecture are neither due to genetic nor to environmental influences, but are caused by nonlinear developmental processes. The organization of dynamic complex adaptive systems is not reliant on an organizing agent, but rather is inherent in the dynamical transactions of the genetic and epigenetic aspects of the biopsychosocial ecology in which behavior is embedded (cf. Greenberg, 2007). Due to its openness against environmental influences and the nonlinear relations among its components tiny fluctuations within a system's equilibrium are able to result in a spontaneous emergence of new order or new structures (cf. Wimmers, Beek, Savelsbergh, & Hopkins, 1998). The underlying mechanisms of stability and change are only partially known (cf. Wimmers et al., 1998). The increase of order within a system, occurring by self-organization, takes place as interaction between system components on lower levels.

Self-organizing processes imply that early skills and universal development processes do not inevitably have to be based on innate structures. Rather restrictive basic conditions (constraints) inside and outside the organism might be the essence of e.g., cognitive development (Krist, Natour, Jäger, & Knopf, 1998). Thelen and Smith's (1994) "dynamic cognitive theory" (cf. Metzger, 1997) characterizes cognition as dynamic, adaptive, and self-organized. According to their theory, the infant's cognitive skills grow through processes of exploration based on perception and action. "Actions of the infant are seen to emerge self-organized in each instance from the operation of motor and neural subsystems under constraints of the context,

arriving at a stable state of coordination to meet the demands of the task at hand. From this point of view, action is inseparably tied to perception and the perception-action complex is the (...) basis (...) from which (...) all cognitive skills may be derived” (Metzger, 1997, p. 63).

Due to the nonlinear interaction even complex behaviors can develop, although the components of the system are simple and follow simple rules. “The key idea of connectionist modelling is that of collective computation. That is, although the behavior of the individual components in the network is simple, the behavior of the network as a whole can be very complex” (Mareschal & Thomas, 2001, p. 749).<sup>3</sup> However, self-organizing processes in organisms are usually extremely complex due to the multiplicity of influencing factors. In addition, the mechanisms of self-organization in biological systems (living organisms) differ from those in physical systems (grains of sand, chemical reactions) such that the subunits and rules effective in them show a greater complexity (Camazine et al., 2001). While the pattern formation in physical systems is based only on physical laws such as gravity, surface tension, and viscosity, the physiological and behavioral interactions between the components in living systems are at the same time affected by genetically controlled characteristics (Gottlieb, Wahlsten, & Lickliter, 1998).

To explore complex processes like cognition, (computer) models are essential that help to understand nonlinear interactions among a large number of components like neurons and different neurotransmitters, and properties that emerge in systems as a result of such interactions. Connectionist models contribute to our knowledge of development by helping to understand nonlinear developmental trajectories, critical periods in development and developmental disorders. By providing insights into neural mechanisms these models elucidate the functions of different brain regions (Munakata & McClelland, 2003). In all these examples, simulations that help to explore the role of nonlinear dynamics are quite relevant.

Connectionist and dynamic systems approaches that depict developmental processes are closely related theoretical perspectives and share—among other ideas—an emphasis on continuous, nonlinear processes. But they also differ in some aspects. While connectionist approaches focus on learning processes and representations in cognitive tasks, dynamic systems approaches focus on mathematical characterizations of physical elements and the interactions of systems within the environment (Munakata & McClelland, 2003). Dynamic systems theories are not just a single theory to understand a single phenomenon but a general approach that bears many different opportunities to understand development in all its complexity. However, in empirical work, the connectionist work has tended to focus on the representations that underlie performance in cognitive and linguistic tasks. Most of the dynamic systems work has tended to focus on sensorimotor phenomena and the relationship between physical elements of the environment and the behavioral system.

In the following paragraphs we will discuss methodological issues of research in developmental science against the background of a DSP.

---

<sup>3</sup> For a review of the ongoing discussion on connectionist and dynamic systems models see Cowan (2003).

## ***DSP as a Tool for Research in Developmental Science: Methodological Issues***

An understanding of developmental phenomena demands a co-active concept of causality, as opposed to a conceptualization that assumes that singular causes can act in isolation (Gottlieb & Halpern, 2002). However, traditional methodology can not address this complexity adequately. As it has become apparent by the description of the developmental processes, we will need complex and innovative methodological strategies. Obviously we need prospective, longitudinal research to promote the study of ontogenetic integration across levels and over time. But simply acquiring data of children from different age groups and to compare these results does not suffice to address this complexity. Even studies on neonates and infants frequently do not focus on change but, like studies on adults, are only concerned with real-time processing within steady-state systems. That is, most of these studies that claim to address developmental question can not be considered developmental in a more profound way, as outlined in this chapter (cf. Karmiloff-Smith, 1997).

Traditional methods in developmental psychology hold some limitations restricting research in developmental science. Intra-individual variability can be defined “as differences in the level of a developmental variable within individuals and between repeated measurements” (van Geert & van Dijk, 2002, p. 341). Although variability is an important developmental phenomenon, van Geert and van Dijk (2002; cf. van Geert & Steinbeek, 2005) summarize that “the standard methodological toolkit of the developmental psychologist offers few instruments for the study of variability” (p. 341). The consideration of variability is necessarily connected with a departure from the measurement-error-hypothesis, “which systematically considers variability (in the form of fluctuating developmental levels) as the result of measurement error” (p. 342).

According to Granic and Hollenstein (2003) complex developmental models often remain untested because of inadequate techniques of measurement. They mention the heterogeneity of antisocial behavior over the life course and equifinality of aggression as an example. Developmental models which consider these results are difficult to confirm on an empirical level. Summarizing similar subjects into groups or classes in order to perform analyses at the attained group-level is a basic principle of most of the current research and analytic procedures. It is therefore difficult to investigate variability (heterogeneity of antisocial behavior) due to the a priori assumption of multivariate analytic methods that groups are homogeneous within themselves. One reason for the reductionistic, a priori assumptions often found in psychology can be seen in adopting techniques of mechanistic physical sciences of the 19th century to academic psychology.

Behavioral (or in a broader sense developmental) outcomes are not always predictable in a linear way from their antecedents. Thus, it is necessary to discover and depict the dynamic and bidirectional relations between levels of organization in the organism-environment system, whilst discarding antecedents-consequence ties (Lickliter, 2007). According to Molenaar (2008) standard statistical analysis techniques of inter-individual variation are invalid to investigate developmental processes. Depictions of age-to-age average changes or the stability of rank order

can point to developmental processes in only limited ways. “In many cases, the measurement occasions are begun, spaced, and end arbitrarily and the descriptions they afford of what is transpiring are just as arbitrary” (Nesselroade & Schmidt McCollam, 2000, p. 295). Methods and statistics, developed to test dynamic systems models, are more appropriate for research in developmental science. Only the employment of powerful computers allows the design of working-models to simulate the behavior of nonlinear systems. In order to be able to promote our understanding of systems, computerized models do not only have to be biologically plausible but also have to share other characteristics of natural systems such as phase transitions in the behavior and being able to learn without preceding programmed instructions (cf. van der Maas & Hopkins, 1998). Complex mathematical equations and computers enable the prediction of the characteristics of complex systems and offer a possibility to verify theories about mechanisms effective in a system (Camazine et al., 2001).

According to Fischer and Rose (1999) two research approaches in nonlinear dynamic systems can be differentiated:

1. Data-driven research which centers on identifying and describing specific developmental phenomena with dynamic properties (e.g., nonlinear growth) and shifting developmental patterns from multiple influences, especially as they apply to actions.
2. Model-driven approaches that focus on explicating specific models of growth and development in mathematical terms and testing those models to determine whether they produce the developmental properties that theorists have claimed for them.

Nonlinear dynamics in development can only be explained if research goes beyond descriptive demonstration of the interrelatedness of different factors that contribute to a certain phenomenon and moves towards holistic explanations that demonstrate the interplay of various factors contributing to a developmental pathway of a certain behaviour (Fischer & Rose, 1999).

It is only rarely recognized that not only theory but largely methodological features form the view of human development derived from empirical work in a decisive manner (Jelic et al., 2007). Studies that attempt to provide such holistic explanations make use of developmental contextual methods (Lerner et al., 2005), that appraise the dynamic and reciprocal linkages between individuals and between these groups of individuals and their environments. The developmental systems perspective therefore aims to study human development from three perspectives simultaneously: (a) the individual; (b) the context; (c) the relation between individual and context.

Lerner et al. (2005) and also Jelic et al. (2007) describe the theory of developmental contextualism as an approach to consider the dynamic reciprocal person context relations. According to their approach, three issues are important to adequately measure developmental systems (cf., Lerner et al., 2005):

- a. Relationism (dynamic reciprocity of all change processes in the developmental system and irreversibility of changes which are relational to the loci in time and

place that they occur, with implications for generalizability: results may not be causally shifted from one to another context);

- b. Probabilism (changes within developmental systems have a probabilistic epigenetic character);
- c. Temporality (changes occurring at different points in time are inherently different processes).

One difficulty concerning the study of change is that most of the time we do not observe the process of change but the developmental outcome of change (Lavalli et al., 2005). In this sense, Werner (1926, 1937) argued that the actual process of unfolding of structure in development rather than the outcomes of such development needs to be the unit of analysis. Werner developed his microgenetic experimental focus in parallel with Sander's (1927, 1932) methodology of *Aktualgenese* (cf. Josephs & Valsiner, 2007; Valsiner & Van der Veer, 2000). Microgenetic designs however offer a promising approach to study change processes by focusing on descriptions of moment-by-moment changes. Knowledge about changes on the micro level is necessary to understand changes on the macro level, a premise "strengthened by recent advances in the dynamic systems perspective" (Lavalli et al., 2005, p. 42) for example "to test potential control parameters, that is, those factors that according to a dynamic systems perspective shift the observed system into new behavioral configurations" (p. 43). Lavalli et al. (2005) summarize the key characteristics of microgenetic designs as follows:

1. The changing individual is the unit of analysis;
2. Observations are conducted not only before and after a developmental change take place, but also while the developmental changes occur;
3. Observations are conducted at time intervals that are shorter than the time intervals required for the developmental change to occur;
4. Intensive qualitative and quantitative analysis of observed behaviors.

However, while these aforementioned characteristics seem more than reasonable on a theoretical level, it is hard to find analytical strategies that are appropriate for this type of research in developmental science. Although a variety of dynamic mathematical and statistical models are now available, and so are numerous applications of such models to empirical developmental data, the development of these models and statistical analysis strategies in a dynamic framework (dynamic modeling) enabling us to considering nonlinear changes, still needs more attention, and the application of such models in the elucidation of developmental processes is highly complex (cf. van Geert & Steenbeek, 2005).

Some strategies that can be considered appropriate are: configural frequency analysis and other multivariate categorical methods (see Lerner et al., 2001), latent growth (curve) analysis, multivariate time-series analysis (Ferrer, Balluerka, & Widaman, 2008; Schmitz, 1990), dynamic models based on latent difference scores (McArdle, 2001; McArdle & Hamagami, 2001), dynamic factor models, respectively (Molenaar, 1985), nonlinear difference equation modeling (Gottman, Swanson, & Swanson, 2002), state space grid analysis (Granic & Hollenstein, 2003; Lewis, Lamey, & Douglas, 1999), longitudinal data analysis with structural equa-

tions (Rosel & Plewis, 2008), application of item response theory (IRT) with hierarchical linear modelling and other forms of applications of IRT (for a summary see Nesselrode & Schmidt McCollam, 2000) and strategies and methods described in Granic and Hollenstein (2003); Granic (2005); Little, Bovaird, and Card (2007) or Fischer and Rose (1999). Due to the complexity of the research goals within the developmental systems framework, some of these methods require a highly advanced if not expert understanding of the underlying statistical and mathematical principles. In addition, the appropriateness of each method to a particular research questions needs to be closely and critically evaluated before running a particular analysis.

Besides selecting appropriate statistical methods and data analysis strategies, research in developmental science as an interdisciplinary, and biopsychosocial approach needs appropriate methods to model the assumed relationships. From a developmental science perspective it is necessary to consider changes within and between all of the biopsychosocial levels—or systems—to understand human development comprehensively. An exhaustive description of methods in developmental science, such as animal models, computational and genetic methods, brain imaging, lesion and electrophysiological methods and their combination with established psychological methods (converging approaches or hybrid methods; Posner, 2002) are far beyond the opportunities we have in this book chapter (but see Casey & de Haan, 2002; Casey & Munakata, 2002, and the special issues in the journals *Developmental Science* and *Developmental Psychobiology* devoted to this topic). Usually, few studies have the relevant resources but to be addressing questions that are considered within the realm of developmental science two levels have to be assessed at a minimum (Lerner et al., 2005). Thus, the challenge is to develop adequate methods to investigate issues from a developmental systems perspective against the background of developmental scientific assumptions, or in other words, to investigate the behavior and relationships of all elements in a particular system while it is functioning.

Resuming, Granic and Hollenstein (2003) refer to Richters (1997) who described four aspects future studies need to take into consideration:

- a. intense focus placed on understanding individuals and individuals' development;
- b. multi-method strategies and different methods in accordance with phenomena investigated;
- c. exploratory approaches discovering developmental processes;
- d. a focus on explanatory power, not on explained variance and prediction.

Finally, Granic and Hollenstein (2003, p. 647ff.) summarize Thelen and colleagues' strategies (1994) for developmental psychologists interested in dynamic analyses:

1. identify the collective variable (observable phenomenon that captures the coordination of the elements of a multidimensional system) of interest;
2. describe the attractors for that system (map the real-time trajectory of the collective variable in various contexts across different developmental periods and identify its relative stability);



3. map the individual developmental trajectory of the collective variable (requires collecting observations at many time points in a longitudinal design) with graphed developmental profiles on a case by case basis and a description of differences and similarities among profiles;
4. identify phase transitions (characterized by increased variability, a breakdown of stable patterns, and the emergence of new forms) in development;
5. identify control parameters (the “agents of change”; control parameters are continuous and changes in these parameters result in abrupt threshold effects on a collective variable);
6. manipulate control parameters to experimentally generate phase transitions.

Although promising, these strategies require expensive and time consuming data collection (e.g., multiple measurements over time) which needs to be taken into consideration when selecting research designs and methodologies and not all of the developmental changes of interest are characterized by quantitative changes (e.g., increases or decreases) over time, such as the development of psychopathology.

## Conclusions

In this chapter we demonstrated the complexity of (human) developmental processes and the implication for empirical work that aims to show this complexity.

Ontogenetic development is a constructive process of qualitative reorganization within and between systems. This process involves dynamic interactions of manifold (biopsychosocial) factors on various levels (of the system). It results in an increase in complexity through differentiation and functional organization in context. This approach emphasizes the active involvement of the individual during lifespan and is beautifully summarized by Sameroff and MacKenzie (2003b, p. 636):

Children affect their environments and environments affect children. In addition, environmental settings affect and are affected by each other. Moreover these effects change over time in response to normative and non-normative events. To get evidence of the multidirectional chaining of such influences will require longitudinal research that pays equal attention to the details of each individual and setting.

Zing-Yang Kuo was one of the first researchers who demanded the foundation of a multidisciplinary research centre of development which should integrate work within the disciplines of psychology, endocrinology, neurophysiology, embryology, zoology, ecology, and anthropology, and therewith contribute to the investigation of behavior and its ontogenesis in biochemical, structural, and environmental contexts (Gottlieb, 1972). Kuo himself spent a large amount of his research career on the investigation of embryonic developments of chickens and was recognized as a great scientist not only by psychologists but also biologists. Lickliter (2007) summarizes that Kuo in his 1967 monograph “developed and honed a conceptual framework for a systems analysis of the development of behavior” (p. 315).

Modeling developmental processes—as in developmental science—seems to be promising on the base of a systems approach with their strong emphasis on the inte-

grated functioning organism (Nesselroade et al., 2000). In this holistic framework of development, the individual is an active, purposeful part of a dynamic system that is also encompassing the social environment. Consequently it is impossible to understand individual functioning without knowledge of social functioning and vice versa. Such a holistic view has multiple consequences for research design, measurement, and statistical analyses (cf. Carolina Consortium on Human Development, 1996). But one has to keep in mind that most of the other disciplines, such as biology or sociology, do NOT take a developmental focus but rather interpret their results within a static framework. In addition, researchers still discuss their results on the base of a predetermined epigenetic view—as we could show with our examples above. In this sense, developmental science has to not only sensitize for a “developmental focus”—in the tradition of e.g., a probabilistic epigenetic view—but also offer the “theoretical/developmental frame” which might unify the results from different disciplines with the goal to obtain a more complete picture of human development. To achieve this aim, developmental science requires new concepts, measures and methodologies that permit to describe individuals as systems integrated in a biopsychosocial context that dynamically change over time. But moreover, we will need to expand our intellectual horizons to fully understand what we have only briefly glimpsed at in this chapter.

## References

- Baltes, P. B., Reese, H., & Nesselroade, J. R. (1977). *Life-span developmental psychology: Introduction to research methods*. Monterey: Brooks/Cole.
- Bennett, A. J. (2008). Gene environment interplay: Nonhuman primate models in the study of resilience and vulnerability. *Developmental Psychobiology*, *50*, 48–59.
- Bergman, L. R., Cairns, R. B., Nilsson, L.-G., & Nystedt, L. (Eds.). (2000). *Developmental science and the holistic approach*. Mahwah: Erlbaum.
- Berg-Nielsen, T. S., Vikan, A., & Dahl, A. A. (2002). Parenting related to child and parental psychopathology: A descriptive review of the literature. *Clinical Child Psychology and Psychiatry*, *7*, 529–552.
- Bronfenbrenner, U. (1979). *The ecology of human development: Experiments by nature and design*. Cambridge: Harvard University Press.
- Cairns, R. B. (1996). Developmental science: Three audacious implications. In R. B. Cairns, G. H. Elder, Jr., & J. Costello (Eds.), *Developmental science* (pp. 49–62). New York: Cambridge University Press.
- Camazine, S., Deneubourg, J.-L., Franks, N. R., Sneyd, J., Theraulaz, G., & Bonabeau, E. (2001). *Self-organization in biological systems*. Princeton: Princeton University Press.
- Carolina Consortium on Human Development (1996). Developmental science: A collaborative statement. In R. B. Cairns, G. H. Elder, Jr., & J. Costello (Eds.), *Developmental science* (pp. 1–6). New York: Cambridge University Press.
- Casey, B. J., & de Haan, M. (2002). Introduction: New methods in developmental science. *Developmental Science*, *5*, 265–267.
- Casey, B. J., & Munakata, Y. (2002). Converging methods in developmental science: An introduction. *Developmental Psychobiology*, *40*, 197–199.
- Caspi, A., McClay, J., Moffitt, T. E., Mill, J., Martin, J., Craig, I. W. et al. (2002). Role of genotype in the cycles of violence in maltreated children. *Science*, *297*, 851–854.

- Caspi A., Sugden K., Moffitt T. E., Taylor, A., Craig, I. W., Harrington, H. L. et al. (2003). Influence of life stress on depression: Moderation by a polymorphism in the 5-HTT gene. *Science*, *301*, 386–389.
- Cicchetti, D., & Blender, J. A. (2004). A multiple-levels-of-analysis approach to the study of developmental processes in maltreated children. *Proceedings of the National Academy of Sciences of the United States of America*, *101*, 17325–17326.
- Cicchetti, D., & Tucker, D. (1994). Development and self-regulatory structures of the mind. *Development and Psychopathology*, *6*, 533–549.
- Cowan, N. (2003). Comparisons of developmental modeling frameworks and levels of analysis in cognition: Connectionist and dynamic systems theories deserve attention, but don't yet explain attention. *Developmental Science*, *6*, 440–447.
- Diez Roux, A. V. (2007). Integrating social and biologic factors in health research: A systems view. *Annals in Epidemiology*, *17*, 569–574.
- Ehrlich, P., & Feldman, M. (2003). Genes and cultures. What creates our behavioural phenome? *Current Anthropology*, *44*, 87–106.
- Feldman, M. W., & Lewontin, R. C. (1975). The heritability hang-up. *Science*, *190*, 1163–1168.
- Ferrer, E., Balluerka, N., & Widaman, K. F. (2008). Factorial invariance and the specification of second-order latent growth models. *Methodology*, *4*, 22–36.
- Fischer, K. W., & Rose, S. P. (1999). Rulers, models, and nonlinear dynamics: Measurement and method in developmental research. In G. Savelsbergh, H. van der Maas, & P. van Geert (Eds.), *Nonlinear developmental processes* (pp. 197–212). Amsterdam: Royal Netherlands Academy of Arts and Sciences.
- Ford, D. H., & Lerner, R. M. (1992). *Developmental systems theory. An integrative approach*. Newbury Park: Sage.
- Gottlieb, G. (1970). Conceptions of prenatal behavior. In L. R. Aronson, E. Tobach, D. S. Lehman, & J. S. Rosenblatt (Eds.), *Development and evolution of behavior* (pp. 111–137). San Francisco: Freeman.
- Gottlieb, G. (1972). Ying-Yang Kuo: Radical scientific philosopher and innovative experimentalist (1898–1970). *Journal of Comparative and Physiological Psychology*, *80*, 1–10.
- Gottlieb, G. (1991). Epigenetic systems view of human development. *Developmental Psychology*, *27*, 33–34.
- Gottlieb, G. (2002). *Individual development and evolution*. Mahwah: Erlbaum. (Original work published 1992, *Individual development and evolution: The genesis of novel behavior*. New York: Oxford University Press.)
- Gottlieb, G. (2003). On making behavioral genetics truly developmental. *Human Development*, *46*, 337–355.
- Gottlieb, G., & Halpern, C. T. (2002). A relational view of causality in normal and abnormal development. *Development and Psychopathology*, *14*, 421–435.
- Gottlieb, G., Wahlsten, D., & Lickliter, R. (1998). The significance of biology for human development: A developmental psychobiological systems view. In W. Damon (Series Ed.) & D. Kuhn & R. S. Siegler (Vol. Eds.), *Handbook of child psychology: Vol. 1. Theoretical models of human development* (5th ed., pp. 233–273). New York: Wiley.
- Gottlieb, M. S. (2007). The developmental point of view: Anything can change everything; permission to doubt dogma, the Gilbert Gottlieb legacy. *European Journal of Developmental Science*, *1*, 200–207.
- Gottesman, I., & Gould, T. (2003). The endophenotype concept in psychiatry: Etymology and strategic intentions. *American Journal of Psychiatry*, *160*, 1–10.
- Gottesman, I. I., & Hanson, D. R. (2005). Human development: Biological and genetic processes. *Annual Review in Psychology*, *56*, 263–286.
- Gottman, J., Swanson, C., & Swanson, K. (2002). A general systems theory of marriage: Nonlinear difference equation modeling of marital interaction. *Personality and Social Psychology Review*, *6*, 326–340.
- Granic, I. (2005). Timing is everything: Developmental psychopathology from a dynamic systems perspective. *Developmental Review*, *25*, 386–407.

- Granic, I., & Hollenstein, T. (2003). Dynamic systems methods for models of developmental psychopathology. *Development and Psychopathology, 15*, 641–669.
- Greenberg, G. (2007). Why psychology is not a biological science: Gilbert Gottlieb and probabilistic epigenesis. *European Journal of Developmental Science, 1*, 111–121.
- Halpern, C. T., Hood, K. E., & Lerner, R. M. (Eds.). (2007). Integration nature and nurture through developmental science: The contributions of Gilbert Gottlieb. *European Journal of Developmental Science, 1*(2, Special Issue).
- Jelic, H., Theokas, C., Phelps, E., & Lerner, R. M. (2007). Conceptualizing and measuring the context within person  $\leftrightarrow$  context models of human development: Implications for theory, research and application. In T. D. Little, J. A. Bovaird, & N. A. Card (Eds.), *Modeling contextual effects in longitudinal studies* (pp. 437–456). Mahwah: Erlbaum.
- Johnston, T. D., & Edwards, L. (2002). Genes, interactions, and the development of behavior. *Psychological Review, 109*, 26–34.
- Josephs, I. E., & Valsiner, J. (2007). Developmental science meets culture: Cultural developmental psychology in the making. *European Journal of Developmental Science, 1*, 47–64.
- Karmiloff-Smith, A. (1997). *Beyond modularity*. Massachusetts: MIT.
- Kaufman, J., Yang, B.-Z., Douglas-Palumberi, H., Houshyar, S., Lipschitz, D., Krystal, J. H., et al. (2004). Social supports and serotonin transporter gene moderate depression in maltreated children. *Proceedings of the National Academy of Sciences of the United States of America, 101*, 17316–17321.
- Krist, H., Natour, N., Jäger, S., & Knopf, M. (1998). Kognitive Entwicklung im Säuglingsalter: Vom Neo-Nativismus zu einer entwicklungsorientierten Konzeption. *Zeitschrift für Entwicklungspsychologie und Pädagogische Psychologie, 30*, 153–173.
- Kuo, Z.-Y. (1967). *The dynamics of behavior development: An epigenetic view*. New York: Random House.
- Lavalli, M., Pantoja, A. P. F., Hsu, H.-C., Messinger, D., & Fogel, A. (2005). Using microgenetic designs to study change process. In D. M. Teti (Ed.), *Handbook of research methods in developmental science* (pp. 41–65). Malden: Blackwell.
- Lerner, R. M., Dowling, E., & Chaudhuri, J. (2005). Methods of contextual assessment and assessing contextual methods: A developmental systems perspective. In D. M. Teti (Ed.), *Handbook of research methods in developmental science* (pp. 183–209). Malden: Blackwell.
- Lerner, R. M., Lerner, J. V., DeStefanis, I., & Apfel, A. (2001). Understanding developmental systems in adolescence: Implications for methodological strategies, data analytic approaches, and training. *Journal of Adolescent Research, 16*, 9–27.
- Lewis, M. D., Lamey, A. V., & Douglas, L. (1999). A new dynamic systems method for the analysis of early socioemotional development. *Developmental Science, 2*, 457–475.
- Lickliter, R. (2007). Kuo's epigenetic vision for psychological sciences: Dynamic developmental systems theory. In J. Valsiner (Ed.), *Thinking in psychological science. Ideas and their makers* (pp. 315–329). New Brunswick: Transaction Publishers.
- Little, T. D., Bovaird, J. A., & Card, N. A. (Eds.). (2007). *Modeling contextual effects in longitudinal studies*. Mahwah: Erlbaum.
- Lorenz, K. Z. (1981). *The foundations of ethology*. New York: Simon & Schuster.
- Magnusson, D., & Cairns, R. B. (1996). Developmental science: Principles and illustrations. In R. B. Cairns, G. H. Elder, Jr., & J. Costello (Eds.), *Developmental science* (pp. 7–32). New York: Cambridge University Press.
- Mareschal, D., & Thomas, M. S. C. (2001). Self-organisation in normal and abnormal cognitive development. In A. F. Kalverboer & A. Gramsbergen (Eds.), *Brain and behavior in human development. A source book* (pp. 743–766). Dordrecht: Kluwer Academic Press.
- Martins, C., & Gaffan, E. A. (2000). Effects of early maternal depression on patterns of infant-mother attachment: A meta-analytic investigation. *Journal of Child Psychology and Psychiatry, 41*, 737–746.
- McArdle, J. J. (2001). A latent difference score approach to longitudinal dynamic structural analysis. In R. Cudeck, S. du Toit, & D. Sörbom (Eds.), *Structural equation modeling: Present and*

- future. *A Festschrift in honor of Karl Jöreskog* (pp. 341–380). Lincolnwood, IL: Scientific Software International.
- McArdle, J. J., & Hamagami, F. (2001). Linear dynamic analyses of incomplete longitudinal data. In L. Collins & A. Sayer (Eds.), *New methods for the analysis of change* (pp. 139–175). Washington, DC: American Psychological Association.
- Metzger, M. A. (1997). Applications of nonlinear dynamical systems theory in developmental psychology: Motor and cognitive development. *Nonlinear Dynamics, Psychology, and Life Sciences, 1*, 55–69.
- Molenaar, P. C. M. (1985). A dynamic factor model for the analysis of multivariate time series. *Psychometrika, 50*, 181–202.
- Molenaar, P. C. M. (2007). Developmental systems theory contra developmental behavior genetics. Gilbert Gottlieb, in memoriam. *European Journal of Developmental Science, 1*, 138–144.
- Molenaar, P. C. M. (2008). On the implications of the classical ergodic theorems: Analysis of developmental processes has to focus on intra-individual variation. *Developmental Psychobiology, 50*, 60–69.
- Munakata, Y., & McClelland, J. L. (2003). Connectionist models of development. *Developmental Science, 6*, 413–429.
- Murray, L., & Cooper, P. J. (1997). Effects of depression on infant development. *Archives of Disease in Childhood, 77*, 99–101.
- Nesselroade, J. R., & Schmidt McCollam, K. M. (2000). Putting the process in developmental processes. *International Journal of Behavioral Development, 24*, 295–300.
- Nijhout, H. (2003). The importance of context in genetics. *American Scientist, 91*, 416–423.
- Overton, W. F. (2007). A coherent metatheory for dynamic systems: Relational organicism-contextualism. *Human Development, 50*, 154–159.
- Oyama, S. (1989). Ontogeny and the central dogma: Do we need the concept of genetic programming in order to have an evolutionary perspective? In M. R. Gunnar & E. Thelen (Eds.), *The Minnesota symposia on child psychology, Vol. 22. Systems and development* (pp. 211–218). Hillsdale: Erlbaum.
- Petermann, F., Niebank, K., & Scheithauer, H. (2004). *Entwicklungswissenschaft. Entwicklungspsychologie—Genetik—Neuropsychologie* [Developmental Science. Developmental Psychology—Genetics—Neuropsychology.]. Heidelberg: Springer.
- Petronis, A., Gottesman, I., Peixiang, K., Kennedy, J., Basile, V., Paterson, A., et al. (2003). Monozygotic twins exhibit numerous epigenetic differences: Clues to twin discordance. *Schizophrenia Bulletin, 29*, 169–178.
- Plomin, R. (2004). Genetics and developmental psychology. *Merrill-Palmer Quarterly, 50*, 341–352.
- Posner, M. I. (2002). Convergence of psychological and biological development. *Developmental Psychobiology, 40*, 339–343.
- Psychosocial Paediatrics Committee, Canadian Paediatric Society (CPS) (2004). Maternal depression and child development. *Paediatrics and Child Health, 9*, 575–583.
- Richters, J. E. (1997). The Hubble hypothesis and the developmentalist's dilemma. *Development and Psychopathology, 9*, 193–229.
- Rosel, J., & Plewis, I. (2008). Longitudinal data analysis with structural equations. *Methodology, 4*, 37–50.
- Sameroff, A. J., & Chandler, M. J. (1975). Reproductive risk and the continuum of caretaker casualty. In F. D. Horowitz, M. Hetherington, S. Scarr-Salapatek, & G. Siegal (Eds.), *Review of child development research* (Vol. 4, pp. 187–244). Chicago: University of Chicago Press.
- Sameroff, A. J., & MacKenzie, M. J. (2003a). A quarter-century of the transactional model: How have things changed? *ZERO TO THREE, September 2003*, 14–22.
- Sameroff, A. J., & MacKenzie, M. J. (2003b). Research strategies for capturing transactional models of development: The limits of the possible. *Development and Psychopathology, 15*, 613–640.
- Sander, F. (1927). Über Gestaltqualitäten [On Qualities of Gestalt]. Proceedings of the 8th International Congress of Psychology, 1926 (pp. 183–189). Groningen: Noordhoff.

- Sander, F. (1932). Funktionale Struktur, Erlebnisganzheit und Gestalt [Functional Structure, Erlebnisganzheit and Gestalt]. *Archiv für die gesamte Psychologie*, *85*, 237–260.
- Savelsbergh, G., van der Maas, H., & van Geert, P. (Eds.). (1999). *Nonlinear developmental processes*. Amsterdam: Royal Netherlands Academy of Arts and Sciences.
- Scheithauer, H., Niebank, K., & Gottlieb, G. (2007). To see an elephant: Developmental science. *European Journal of Developmental Science*, *1*, 6–22.
- Schmitz, B. (1990). Univariate and multivariate time-series models: The analysis of intraindividual variability and intraindividual relationships. In A. von Eye (Ed.), *Statistical methods in longitudinal research. Vol. II: Time series and categorical longitudinal data* (pp. 351–386). San Diego: Academic Press.
- Shanahan, M. J., Sulloway, F. J., & Hofer, S. M. (2000). Change and constancy in developmental contexts. *International Journal of Behavioral Development*, *24*, 421–427.
- Thelen, E., & Smith, L. (1994). *A dynamic systems approach to the development of cognition and action*. Cambridge: MIT.
- Valsiner, J., & Van der Veer, R. (2000). *The social mind*. New York: Cambridge University Press.
- van der Maas, H. L. J., & Hopkins, B. (1998). Developmental transitions: So what's new? *British Journal of Developmental Psychology*, *16*, 1–13.
- van Geert, P., & Steenbeek, H. (2005). Explaining after by before: Basic aspects of a dynamic systems approach to the study of development. *Developmental Review*, *25*, 408–442.
- van Geert, P., & van Dijk, M. (2002). Focus on variability: New tools to study intra-individual variability in developmental data. *Infant Behavior and Development*, *25*, 340–374.
- von Bertalanffy, L. (1968). *General systems theory*. New York.
- Wagman, J. B., & Miller, D. B. (2003). Nested reciprocities: The organism–environment system in perception–action and development. *Developmental Psychobiology*, *42*, 317–334.
- Weiss, P. (1959). Cellular dynamics. *Reviews of Modern Physics*, *31*, 11–20.
- Werner, H. (1926). Über Mikromelodik und Mikroharmonik. *Zeitschrift für Psychologie*, *98*, 74–89.
- Werner, H. (1937). Process and achievement. A basic problem of education and developmental psychology. *The Harvard Educational Review*, *7*, 353–368.
- Wimmers, R. H., Beek, P. J., Savelsbergh, G. J. P., & Hopkins, B. (1998). Developmental changes in action: Theoretical and methodological issues. *British Journal of Developmental Psychology*, *16*, 45–63.
- Witherington, D. C. (2007). The dynamic systems approach as metatheory for developmental psychology. *Human Development*, *50*, 127–153.
- Wright, S. (1968). *Evolution and the genetics of populations, Vol. I: Genetic and biometric foundations*. Chicago: University of Chicago Press.

## Chapter 27

# Cognitive and Interactive Patterning: Processes of Creating Meaning

Jürgen Kriz

One of the most challenging questions for psychological and sociological researchers concerns the discrepancy between two images of our world:

On the one hand, our modern scientific view of the world converges with the philosophies of various cultures and times (and with those of our own culture), in the awareness that the world is above all to be seen as an incredibly complex process. It is a world out of a fast changing, high complex multitude of elements, stimuli, etc. and an incomprehensible stream of unique moments. One cannot wade into the same river twice, as Heraclites long ago pointed out.

On the other hand, in our everyday life, we describe and experience the world in terms of smooth developing, semi complex, and ordered units. In banishing the chaotic complexity, we are searching for order and stability. We are creating meaning in our personal and social Lebenswelt which is essential for our everyday life.

This discrepancy confronts us in many areas and on many levels: For example, the process of visual perception can be described—from an objective external viewpoint—as an erratic sequence of discrete fixations of 0.1–0.3 s in duration, which are interrupted by eye movements of various kinds (particularly by macro saccades, which are larger but unconscious changes in gaze). Therefore, the neighbor whom we meet every morning on the way to the bus stop, for say 10 min, is part of a stimuli multitude in a sequence of around  $4 \times 20 = 240$  fixated images per minute—or 2,400 images per morning, or 876,000 per year. However, in order to recognize the neighbor a constructive figure-ground separation of stimuli and integration into a Gestalt is necessary. Moreover, despite of changing in the neighbor's appearance over the past years we have a more or less stable schematic image that shows this neighbor “sun tanned” in summer, “rather pale” in winter, sometimes casually and sometimes elegantly clothed, etc.

In the same way, the “objectivity” of myriad single utterances of the neighbor, each comprising many words and phonemes, which are further composed of

---

J. Kriz (✉)  
Department of Psychology  
University of Osnabrück  
49074 Osnabrück, Germany  
e-mail: juergen.kriz@uni-osnabrueck.de

complex and diverse component frequencies, give rise to something that we experience as part of his biographical life-story. And we arrange these utterances too, into a vague but coherent image of his son, for example, who lives in Japan.

Finally, to give a third example, there is also an important discrepancy between the functional basis of our consciousness and its content: There is a lot of different empirical research that converges to the fact that our consciously experienced “now”, which is related to the “attention span”, “working-memory” or “short-term memory” (STM) lasts approximately about 15–30 s. “Lasts” means here the length of time we are able to keep perceived or recalled (from “long-term memory”) information in mind without having to perceive or recall it again. In contrast to this rather short STM in the objective time, the *content* which is produced in this span of 20 s is extremely wide. We mostly have the awareness that we have an overview over all the decades of our life and, additionally, of the next time in future. Moreover, in contrast to the rapidly fading STM, the produced image of our self and the world around us is rather stable, only smoothly changing. We can barely endure too fast, too disturbing or too far-reaching changes in our Lebenswelt (Kriz, 1997).

In order to deal with this discrepancy and to understand the process of constructing meaning and stability in our Lebenswelt I have proposed a multi-level concept of somatic, ecological-interactive, psychic and socio-cultural processes (Kriz, 1985, 1991) which was elaborated in the last 25 years into “person-centered systems theory” (Kriz, 2004a, 2008). From a clinical perspective, particularly so-called neurotic symptoms can be understood as an inadequate exaggeration of the useful ability to create meaning and stability out of chaotic complexity. Parts of personal and interactive Lebenswelt become then too reduced, encrusted, over-reified und over-stabilized with lack of adaptation to an ever changing objective and social world, which gives developmental task both in individual and social aspects of life. A simple example of the latter is a nice and useful interactive structure of parents and their 3-year-old son which would be totally crazy and pathological when it remains the same for 20 years (and the 23-year-old man is treated and let himself be treated as if he would be 3 years old) instead of passing some phase transitions of the structural patterns due to developmental task from the body (e.g., sexuality) psyche (e.g., self-determination) or culture (e.g., responsibility).

Starting primarily with pure psychological roots of elaborated dynamic approaches—particularly the Würzburg- (O. Külpe, K. Bühler) and Berlin-Frankfurt- (M. Wertheimer, K. Koffka, W. Köhler, K. Goldstein, K. Lewin) tradition (see Chapter 15, this book) and its influences to clinical psychology (C.R. Rogers) and experimental psychology (F. Bartlett—see Chapter 5, this book)—the “person-centered systems theory” became influenced by the interdisciplinary systems approach, particularly by “Synergetics” (Haken, 1978, 1983, 1992; Haken & Stadler, 1990). Core of the Synergetics is the (mainly mathematical) description and explanation of the emergence of self-organized order and the phase transition of order into other order. The theory was developed by Haken, firstly in order to explain the processes of laser-light. Then it turned out that the way of dealing the problems in Synergetics is also of value for many questions in other disciplines concerning the development and change of (dynamically) ordered states. Therefore, in the more



than hundred volumes of “Springer Series in Synergetics” (and much more other volumes) besides primarily contributions from physics, chemistry, computer- and other sciences there is a small but increasing number of contributions also from psychology and social sciences.

From this (important but here mainly implicit) background, it is the aim of this chapter to introduce into and discuss some core principles and aspects of the systemic perspective which could be helpful in order to understand cognitive and interactive dynamics. However, two points should be noted to avoid misunderstandings. First, “the” systems theory does not exist. Instead, there are different approaches more or less in accordance with the principles of the description in this chapter—in decreasing order: “Synergetics” (Haken, 1978, 1983), “Dissipative Structures” (Prigogine & Nicolis, 1977; Prigogine, 1980) “Catastrophe Theory” Thom (1989) “Autopoiesis” (Maturana & Varela, 1980) and its sociological version (Luhmann, 1984/1995). Second, being in accordance with an approach (mainly Synergetics) which first of all stems from science and has been used to describe phenomena in physics, chemistry, etc. does not at all entail the reduction of psychological and social processes to natural science or to confuse the *phenomena*. Quite the reverse, our everyday language is full of words, concepts, principles, and metaphors which stem from a successfully dealing with dead matter in the frame of applied science, particularly engineering, for example, “he got stuck”, “we have to push the blocked development” or “there is no forthcoming”, and to reify processes to things (Kriz, 2008). Therefore this chapter can also be understood as a plea to rethink and overcome inadequate metaphors and principles and to think of cognitive tools which are more adequate to describe the dynamics of the processes of living.<sup>1</sup>

## Relatedness and Feed-Back as Basic Concepts of the Systems Approach

In modern interdisciplinary systems science, interconnectedness and feed-back loops are the essence of “emergence” and “phase transitions” of self-organized patterns and order. A core distinction between classical mechanistic and modern systemic approaches is illustrated in Fig. 27.1a, b:

In Fig. 27.1a, an input “I” is given to the box, which “operates” somehow and gives an output “O”. This is not only the underlying perspective of stimulus-response psychology and the core of experimental science. It is, moreover, often the everyday understanding disseminated in simple textbooks describing social relationships: A wife asks her husband: “what do you mean about X?” And he gives an answer. The question is identified with “I” and the answer with “O”, and the interaction

<sup>1</sup> Additionally, it should be mentioned that many further research paths exist for the demonstration of the correspondence between system-theoretical and psychological principles. Today, an increasing number of psychological researchers are involved. Overviews are given in Haken and Stadler (1990); Tschacher, Schiepek, and Brunner (1992); Schiepek and Tschacher (1997); Tschacher and Dauwalder (1999, 2003).



**Fig. 27.1** Classical input-output focus (a) versus systemic feedback focus (b)

takes place because the wife cannot look directly into the “black box” (the man’s brain) but has to investigate this box by input–output analysis. Typically, the classical metaphor of experimental input–output-analysis applied to human relationship.

However, this description misses the essence of what really takes place when a couple communicates. In contrast to two persons who meet each other for the first time, a couple has a relationship which reflects the common history, some common ideas about the future, and the cognitive processes in the present. Therefore, the man “knows” that certain answers might be interpreted by his wife in a way which he does not want. This belief of course influences the possible answers a great deal. On the other side, “knowing” her husband, and that he “tends” towards “evasive answers”, the wife tries to ask in a way that reflects these “tendencies” in order to find out what he really thinks. However, the man has experienced that his wife ... etc.

We could go on telling this story in more and more detail and with more prospective loops which reflect the experiences gained during thousands of previous loops (see Fig. 27.1b). But even this rough example shows the flaws of a mere input–output analysis in contrast to taking account of the history of feedback loops in which cognitive patterns of beliefs, expectations, interpretations, and so on provide a meaning field that determines the question and answers. Due to inter-connections and history every “stimulus” is also a “response” to what happened before, and every “response” is also a “stimulus” for the further process. Therefore, what happens reflects the pattern of interaction and meaning which emerged in the biography of that couple. This pattern is not imposed from outside (although many influences are important: social and language structure, individual biography, “personality”, etc.) but is self-organized with respect to these influences.

We can describe self-organized order on the interactional level as patterns of communication or interaction. And, in addition, we can describe self-organized order on the cognitive level as cognitive patterns. However, in most cases patterns of interaction and cognitive patterns are two aspects of one more complex process in which cognitive and interactive dynamics work together. A simple and often used example is the “nagging wife” and the “withdrawing husband”. Let us call the behavior of the female F and of the male M. Then we can observe the pattern of sequences:

$$\dots \rightarrow M \rightarrow F \rightarrow M \rightarrow F \rightarrow M \rightarrow F \rightarrow \dots$$

and we can understand the feed-back loops corresponding to Fig. 27.1b in the following (Fig. 27.2):

However, in addition to this interactional pattern we find cognitive patterns. One typical class of such patterning is described as “punctuation” (Watzlawick, Beavin, & Jackson, 1967). The woman interprets the process in the way

**Fig. 27.2** Dynamic circle of male-female-interaction

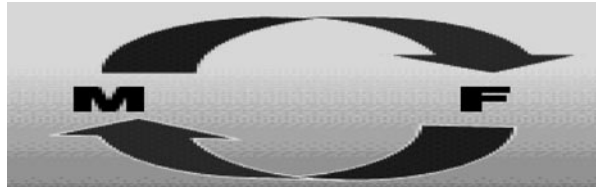

...  $\rightarrow$  (M  $\rightarrow$  F)  $\rightarrow$  (M  $\rightarrow$  F)  $\rightarrow$  (M  $\rightarrow$  F)  $\rightarrow$  ... = “I am nagging because you withdraw”

while the man has the cognitive pattern

...  $\rightarrow$  M  $\rightarrow$  (F  $\rightarrow$  M)  $\rightarrow$  (F  $\rightarrow$  M)  $\rightarrow$  (F  $\rightarrow$  ... = “I am withdrawing because you nag”

Indeed, therapists who deal with families and couples often observe how reactions to another person’s forms of expressing himself have less to do with the communication itself than with some curious rules: off-hand one could say that the attempt at communication made by one person—let’s call her Ute—as registered and processed by the other person—let’s call him Peter—merely acts as a general trigger which causes an “inner film” of expected meaning to start to play. So, Peter does not actually listen any more. In certain situations if Ute merely opens her mouth he already knows “what’s up”. At least he thinks he knows. But how can he know for sure if he doesn’t really listen any more? At any rate, what Peter is reacting to is more his “inner film” than what Ute has said. For therapists the following brief exchange is therefore typical:

**Therapist:** What did you perceive?

**Peter:** The way Ute looked at me I knew what to expect.

**Therapist:** Did you hear what she said?

**Peter:** No, sorry. But I already know what she is going to say when she looks at me like that.

When Ute becomes aware that Peter’s reactions to much of what she says are always the same because he doesn’t listen, she will go to less effort to come up with anything new. This in turn confirms Peter in his belief that he was right in thinking that “Ute always goes on about the same old things.”Unfortunately, it is not only Peter who is affected in this manner. We could have observed and related this whole interaction from Ute’s point of view. Here a vicious circle of reduction has been set in motion in which both partners appear to be both active participants and victims of circumstance at the same time. Sadly, this commingling of the roles of perpetrator and victim is typical of many social relationships.

Those interpretation patterns and forms of behavior which (in the sense of the interpretations) are mutually confirmable develop especially well during the common development of a couple or a family. Hence, these persons’ degree of freedom can under unfavorable circumstances become increasingly restricted. Finally, this dynamics develops an interaction pattern which an observer experiences and describes as “encrusted, rigid structures”. The wife’s most likely different utterances and their intentions are all reduced to the category of “nagging”, and this is

what her husband reacts to. There are simply far too few categories at hand that could be used to understand the partner's behavior.

## Attractors: The Teleological Aspect of a Dynamic

This reduction of complexity is also well described by interdisciplinary systems theory. When input and output are not artificially isolated but interconnectedness and feed-back are admitted, order or patterns can emerge in a self-organized manner. "Order" always refers to a reduction of complexity. Because an often incomprehensible multitude of elements can then be described (and is often perceived) by rather few "principles", "laws" or "structural aspects", and by this becomes comprehensible.

A self organized pattern is called an "attractor", a term which refers to a stable structure towards which the dynamic tend. So, when we start this process from different initial points (or "situations") it always tends toward the same structure (or "situation"). This can easily be demonstrated by using the feed-back loop (Fig. 27.1b):

Let us take the following operation, which should also be understandable for those who are at loggerheads with mathematics: *"multiply the input with 0.05, then subtract this result from 2.2, and then multiply this result with the input"*.

As a consequence, starting with an input "I"—which we call " $X_{old}$ "—we can write

$$X_{old}^*(2.2 - 0.05X_{old}) \rightarrow X_{new}$$

For the first  $X_{old}$  we can begin with a very simple value, for example 10, in order to calculate the right hand side of the equation—therefore:  $10*(2.2 - 0.05*10)$ , and we get  $X_{new} = 17$ . In the next step, this value is used again as  $X_{old}$  on the right hand side—therefore:  $17*(2.2 - 0.05*17)$ , which now gives 22.95. This procedure, in which the result of an operation serves as the initial value for the next step, is called recursion or iteration. Continuing with the iteration process for, say 15 steps, we obtain a result made up of 15 values:

$$\begin{aligned} X_{old} &= 10 \\ \text{Step 1: } &(2.2 - 0.05*10)*10 \rightarrow 17 \\ \text{Step 2: } &(2.2 - 0.05*17)*17 \rightarrow 22.95 \\ \text{Step 3: } &(2.2 - 0.05*22.95)*22.95 \rightarrow 24.15488 \end{aligned}$$

After some steps, we get the results: 24, 24, 24, 24, i.e., we can already see after a couple of steps that the numbers converge to one value—in our case, 24. If we had chosen 2.6 instead of 2.2, this number would be 32.<sup>2</sup>

<sup>2</sup> It should be noted that this example can be—and is often—used to show the opposite: if we'd chosen 3.1, for example, instead of 2.2, this would have resulted in a series that ultimately oscillates between two values, lying at approximately 34.6 and 47.4; moreover, using 3.9, for example, instead of 2.2, the series of results do not have any cycle at all and the result after, say, 100 steps cannot be forecasted due to the exponential increasing amount of digits which exceeds the exactness of every computer. Therefore, in contrast to the simple determinism of the operation or

**Table 27.1** From different starting points the dynamic runs into the attractor 24

Start	$X_{old} * (2.2 - 0.05X_{old}) \rightarrow X_{new}$				
	10	5	20	30	38
17		9.75	24	21	11.4
22.95		16.69688	24	24.15	18.58201
24.15488		22.79385	24	23.96888	23.61587
23.96783		24.16849	24	24.00618	24.06945
24.00639		23.96489	24	23.99876	23.98587
23.99872		24.00696	24	24.00025	24.00282
24.00026		23.99861	24	23.99995	23.99944
23.99995		24.00028	24	24.00001	24.00011
24.00001		23.99995	24	24	23.99998
24		24.00001	24	24	24.00001
24		24	24	24	24
24		24	24	24	24
...		...	...	...	...

Table 27.1 demonstrates that the attractor 24 is not only reached from the starting point 10 but is reached from many starting points: all the different sequences of “results” run into 24. This can be shown graphically in Fig. 27.3.

In this simple case the attractor is just a number (“24”). However, attractors can be more complicated patterns, as is demonstrated in Fig. 27.4 where a repeatedly applied geometric operation (which can, of course also be written in an analytical mathematical manner) runs into the shape of a maple leaf starting from “KRIZ” (or from any other shape).

Accordingly, we understand the emergence and function of “meaning attractors” (Kriz, 2008), which reduce the interpretative complexity in the “meaning space”

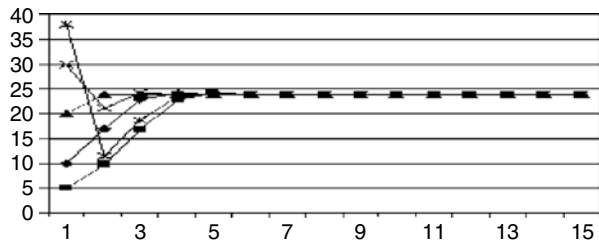

**Fig. 27.3** The graphic representation of Table 27.1

the equation the result (after 50 steps) is practically unpredictable—this is called “deterministic chaos”. This is, in addition, a very important and fascinating aspect of systems science (see Kriz, 1992). However, in the context of this contribution the order-aspect is more important and realistic: Operations which lead to order instead to chaos are more relevant for the evolution of our species in the given areas of concern [cognitive and interactive patterns—while, in contrast, on the biological level in our body also chaotic processes can be more healthy than too ordered ones: for example, the EEG during an epileptic fit, or certain medical parameters in osteoporosis (a disease of bone metabolism)].

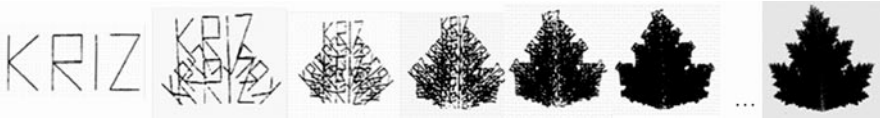
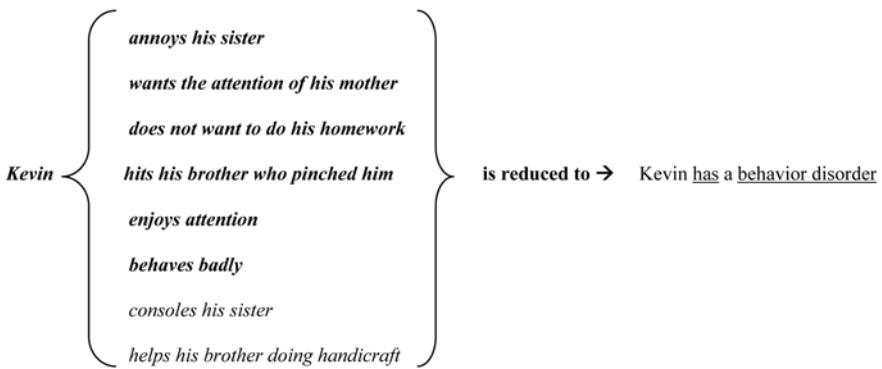

Fig. 27.4 Repeated operation runs into the attractor of a maple leaf (after Kriz, 1992)

into an ordered understanding. In strong correspondence with Fig. 27.3, this can be demonstrated by the following example, in which the first six lines of Kevin’s behaviour, which correspond to different complex situations, are reduced to the simple, low complex description: “Kevin has a behavior disorder”.



Even the situational meaning, outlined by the last two lines, might be drawn into that “meaning attractor”. The reality of counseling shows, that this behavior will be ignored, misunderstood or quickly forgotten. It should be noted that “behavior disorder” is a typical reification which reduces a process to a thing. In addition, the word “has” is rather static and amplifies the encrusted meaning. Therefore from left to right we find a pathogenic process of becoming rigid and petrified by reducing multitude of different dynamic situations with a multitude of meanings and, therefore, a multitude of possible actions to an simple, static, clear but abstract defined, thing-like. No wonder then, that also the space of possible action or reaction is rather small. In many approaches, the core of psychotherapy is to go from the right side to the left side, i.e. to enrich the abstract and reduced description with more detailed, vivid, sensual, situations which opens not only a multitude of meanings and understandings but, from this, also a many options of action.

A real example can be found in the Chapter 20 (this book): In the first sequence of a therapeutic session the woman in therapy says:

P: I don’t want to talk about unimportant things here.

and, a little later, asked to give an example:

P: As an example, things that I am not really interested to discuss because I sorted them out already. Eeemmm, eeemmm...Lets see...mmmh...as an example...oh, I am really tired of living this life...my mind is tired. And my body is tired.

We can be sure that this woman does not refer to real material “things”, such as chairs or pencil-boxes, which she has “sorted out” but uses these reifying words to inadequately referring to the complex stream of unique moments with many aspects. Things can be sorted out of a room. But in order to sort “things” out of the mind’s “space”, the lively sensual experience in a multitude of changing moments has to be reduced and abstracted from the complexity of sensual impressions by creating categories. The more therapy is able to invite a patient to rediscover the sensual complexity the less will he be able to “sort” something out. It is a step from a rigid categorized world out of abstractions to a “re-enchanted” (Kriz, 2008) world out of fascinating experiences.

With respect to our culture of control ideology, we should be aware that even the term “disorder” means “to disturb the order of something”. This means exactly the opposite from what our analysis showed: that there is *too much* and not *too less* order. We see the strong invitation to even more control in our culture in order (!) to prevent so-called disorder.

### ***Cognitive Attractors***

The correspondence between Fig. 27.3 and the meaning attractor with regard to Kevin’s behavior is not just metaphoric. It is interesting that the attracting power of the feed-back loops can be demonstrated precisely on an experimental level. Even more interestingly, long before the discourses on dynamic process methodology, chaos theory, and self-organization became so important in the natural sciences in the 1960s and then in interdisciplinary systems sciences, some core ideas were discussed in psychology. The Gestalt psychologists of the 1920s and 1930s have already impressively shown in numerous research publications that human perception is, to a high degree, an attractive process where the “Gestalt” is the attractor. They investigated the principles from which the order in cognitive processes arises. Besides the manifold Gestalt laws, the tendency towards *Prägnanz* (good form) is, in particular, widely known.

Less well known is that the research in the context of this tendency towards *Prägnanz* had already been applied to those iterative operations which are now examined in many disciplines with regard to current discussions about chaos and structure. Such research was carried out by the British psychologist Bartlett in the 1930s (see also the Chapters 5 and 6, this book). One of the classical Bartlett experiments was similar to what, in a modified form, is playfully called “Chinese whispers”: a person takes a piece of complex information, e.g. a long sentence, whispers it in his neighbour’s ear, who then whispers what she has understood into her neighbour’s ear, and so on. It is therefore a matter of a serial reproduction of (in this case) something that was heard. As is generally known, strange statements can often arise from this funny procedure.

Bartlett<sup>3</sup> investigated the serial reproduction of stories in a precise way. His question was, on the one hand, which aspects of a complex story would change with

<sup>3</sup> Brady Wagoner is running a website at Cambridge University, UK with a Bartlett—Archive (created by Gerard Duveen, Alex Gillespie, and Brady Wagoner). See: [www-bartlett.sps.cam.ac.uk](http://www-bartlett.sps.cam.ac.uk) (September 2008).

serial reproduction, and on the other hand, if the content would sufficiently stabilise at some point. Without going into details, it is obvious that stories in a serial reproduction are simplified and reduced to well-ordered forms which are suited to everyday life. One is much more able, of course, to memorise and retell such simple, reduced, and consistently constructed emerging stories. Therefore the changes become smaller and smaller, and the new emerged story becomes stable in this process (cf. Bartlett, 1932). As an aside, it should be noted that with this research, Bartlett was a forerunner of Jean Piaget's Schema Theory which is also significant for Cognitive Psychology. Indeed, Bartlett coined the term "Schema Theory" which was later—together with fundamental principles described by Bartlett—adopted by Piaget (1976).

The formation of stable patterns in cognitive processes naturally holds not only for the reproduction of stories. An impressive example of the tendency towards *Prägnanz* by using serial reproduction in the area of visual perception is given in Fig. 27.5. A complex random pattern of dots (upper left in Fig. 27.5) is shown to a person as an initial stimulus for some seconds. The reproduced pattern (second pattern in the first line of Fig. 27.5) is then used as the initial stimulus for the next person, and so forth. This serial reproduction procedure (or so-called Bartlett-scenario) tends to highly ordered dot patterns. The result is fascinating and simple at the same time: due to its complexity, the initial pattern cannot be memorized perfectly. It is altered during the procedure until it is so simple and well-formed that it can easily be reproduced perfectly. There is no possibility to predict what kind of pattern will be reached as an attractor. However, one can predict that it will be well-formed and simple—for example, a diamond, a cross, etc. (cf. Stadler & Kruse, 1990).

In some of the work I have initiated (see Kriz, 2001 for an overview), it could be shown that such attractor dynamics are also verifiable for other cognitive processes, again by using serial reproduction. In processes of perceiving or thinking, attractor dynamics evolve, which meaningfully reduce the complexity of a situation, and at the same time stabilise this reduced arrangement—analogously to the above examples. I have therefore coined the term "meaning-attractor", which conceptualizes these dynamic phenomena.

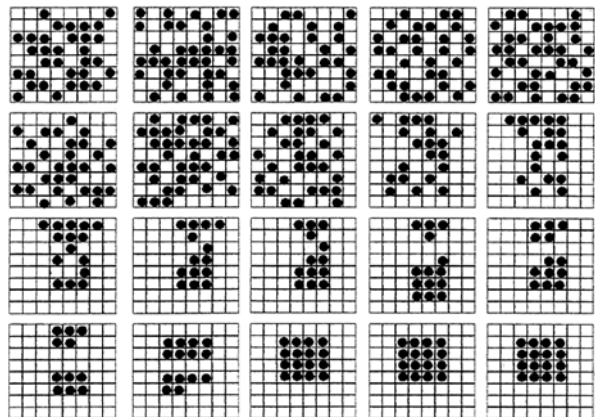

**Fig. 27.5** Serial reproduction of a complex point pattern using 19 successive subjects (from Stadler & Kruse, 1990)



For example, according to Bartlett’s interests concerning the structuring forces in the dynamics of remembering we used descriptions of persons (e.g., by lists of features) in order to demonstrate the pattern formation in remembering (which means constructing or inventing) the “personality” of a person. In one study (Kriz & Kriz, 1992) 30 subjects were given 72 statements which describe a fictive person. These statements were very short and just combined adjectives out of a list of 72 pairs (“intelligent–unintelligent”, “happy–unhappy”, “friendly–unfriendly”, etc.) with four qualitative categories (“extreme”, “very”, “rather”, “little”). Accordingly, the statements were like: Person X is “very intelligent”, “extreme unhappy”, “rather friendly”, etc.

A subject had to read these 72 statements in as much time as he wanted. After some minutes of doing mental arithmetic (in order to have some other cognitive activity) he was asked to reproduce the statements by making crosses in a list with these 72 pairs of adjectives—each pair in one line with a nine-point-scale between (the 2 × 4 qualitative categories plus “I don’t know”). These answers were typed into a computer while the subject again was doing some mental arithmetic. The next step then was to present the subject a printout of his answers—however, transformed again in statements and in another sequence. This procedure was repeated 10 times.

In Fig. 27.6 the ordinate represents a measure of change from one cycle to the next one (which is just the mean of all differences) while the abscissa shows the 10 cycles of serial production (“0” is the initial material). The solid line is computed from the differences between “input” and “output” in each cycle. Accordingly, a difference of 0 (or nearly 0) stands for the fact, that the description of the person is perfect (or nearly perfect) repeated. In Fig. 27.6 this is the case after seven cycles while at the first cycles we find rather big changes (a maximum change would be at about 6 because from one extreme “–4” to the other “+4” is the difference 8, but if we start from “–1” the maximum possible difference is 5).

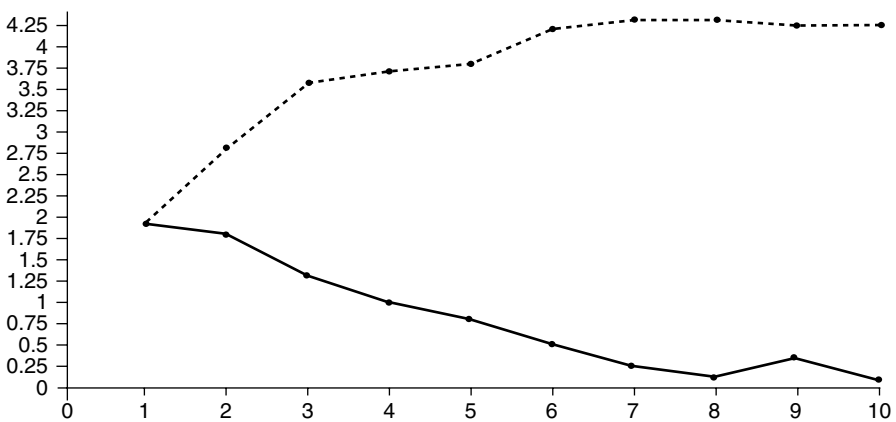

**Fig. 27.6** Dynamics of mean differences between two successive serial reproductions (solid line) and between the reproductions and the initial description of attributes. Data from one typical subject (from Kriz & Kriz, 1992)

It is evident that the process of serial descriptions of the person has an attractive dynamic. It is important to note that Fig. 27.6 is typical to 25 out of 30 subjects. However, for five subjects no attractive dynamic could be seen (in 10 cycles): the differences between successive cycles—or, what is the same: between “input” and “output”—stayed to be rather big.

Another important point to be made about the attractive dynamic (by these 25 subjects) is the fact that the descriptions of persons attitudes became rather quick stable, but these stable “descriptions” turn out to be merely constructions: The dotted line in Fig. 27.6 represents the mean differences of each cycle to now the *initial* description. It couldn’t be more dissimilar!

According to Bartlett and other experimenters in the Gestalt tradition, we can step from the analysis of single cases over finding out “typical” dynamics to aggregate analysis. For example, in the same study (Kriz & Kriz, 1992) three different conditions were given to the 30 subjects (each condition to 10 subjects): The initial description was (1) rather consistent (2) medium consistent and (3) rather inconsistent (e.g., the person was described as “very friendly” but later as “rather gruff”).

While differences between successive cycles became rather fast 0 (or nearly 0) in all three conditions (for 25 subjects) the differences in the first two cycles were significantly higher for the inconsistent description than for the medium consistent description and were significantly lowest for the consistent description (see Fig. 27.7).

Of course, the total difference of the stable pattern from the initial pattern follows shows the same effects. In conclusion it may be stated that constructive pattern formation/recognition changes an inconsistent “reality” more than a consistent “reality”. This is rather likely because we all want to live in a consistent cognitive world rather than in an inconsistent one.

In other experiments (Kriz, Kessler, & Runde, 1992) the process of pattern formation by use of personality inventories was investigated: Subjects were given 10

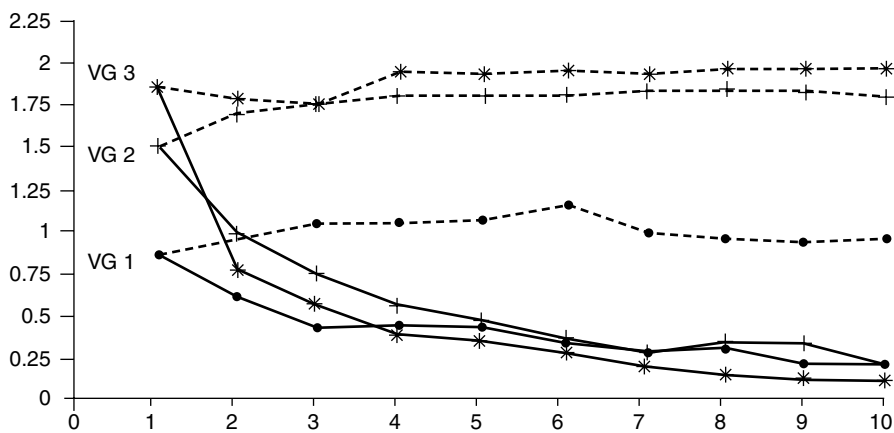

Fig. 27.7 Mean dynamics (cf. Fig. 27.6) for three groups: VG 1 rather consistent, VG 2 little more inconsistent, VG 3 rather inconsistent initial description of attributes (from Kriz & Kriz, 1992)

statements of a German personality inventory (FPI-R)—which is a very rough, vague and colorless information. The subjects were told to assume that these 10 items are statements made by “Mr. K. from W.” about himself when they had “met him during their holiday in Spain”. The subjects then got a questionnaire with 200 more items from that personality test. They were asked to guess whether “Mr. K. from W.” would have agreed to that statement about him. Additionally, they were asked to scale how sure they are in their judgment on a rating scale between 1 and 5. These 200 items were presented on 20 pages of paper, 10 items/pages. Moreover, each page with 10 items represented a random sequence of exactly the 10 personality dimensions. As a consequence, this procedure can again be understood as a serial production procedure with 20 cycles, 10 items each.

One interesting result of that study is the fact, that all “normal” subjects show attractive guesses only in some dimensions while in other dimensions random guesses indicates that no notion of Mr. K. has been formed. Moreover, these dimensions vary from subject to subject. In contrast, “clinical” subjects—patients of a psychiatric hospital with the diagnosis “schizophrenic disease” but not in an acute phase or attack of symptoms—did not show any stable guessing at the personality scales. They were clearly unable to form a pattern of the personality of Mr. K. (for details see Kriz, 1993).

In addition, these results were used to make predictions about the emergence and stabilisation of patterns of interaction. Although these predictions are yet to be verified and demonstrated in detail in the laboratory, their empirical existence and relevance within the scope of systemic family and couple therapy is, however, undisputed. It is clear then that a specific cognitive digestion of sensual impressions to meaningful perceptions due to meaning-attractors is also a basis for specific styles and schemas of expression. These expressions can, accordingly, be “understood” from a communication partner using his own meaning-attractors (see Fig. 27.2 and the related example of “punctuation” by the two partners). “Even if I would change my behaviour and try something new, my partner wouldn’t notice that”, is a very often heard utterance in partner therapy. As a consequence, partners do not only reduce the complexity and uniqueness of every moment into (often too) reduced and reified categorical meaning. But they also reduce the complexity of their behaviour, decrease or stop totally attempts to create something new, when the partner (mostly mutually!) does not react to the new aspects but only to the old categories.

Therefore, iterative processes are also found in the interactions on the level of couple and family dynamics. These allow patterns of interaction to emerge—as attractors of the interaction dynamics (referred to in the literature of family therapy as, for example, “family rules”). These patterns of interaction stabilise the individual meaning-attractors on the one hand, and on the other hand are, as a result, stabilised by these meaning-attractors. This is a typical circular dynamic between the macro level (patterns of interaction) and the micro-level (interactions as the individual’s expressions, which again can be understood to have been shaped by meaning-attractors).

Again, we cannot go into more details here. It can, however, be said in summary that our human brain is—cognitively—a generator of dynamics which attract

the chaotic complexity of unique moments, aspects, stimuli, etc. into meaning by using cognitive schemata. Whatever we do—we can't do otherwise—we interpret and decipher the experiences we have in our life processes in our encounters with the world, with other people, and ultimately with ourselves, and embed these experiences in the meaning structures of our *Lebenswelt*. Relationships and encounters are always both *impressive* and *expressive*. People's impressions and expressions are dynamically inter-related to one another. The human ability—or even necessity—to relate to others therefore becomes apparent not just in impressive, but also in expressive encounters with the world. People do not *behave* in a way that can be formulated from an external “non-human” point of view. Only a thing or an animal is describable in such a way. People, in contrast, *act*. Therefore, cognitive schemata also play a central role with regard to the formation and stabilisation of interaction patterns.

### ***Circular Causality, Order, and Fields***

An other central aspect of systems theory, which was already essentially for the concept of “Gestalt”, concerns the circular interaction between the macroscopic and the microscopic level—or in terms of Gestalt psychology: between the whole (the Gestalt) and its parts. Points on paper are “automatically” ordered into patterns and pictures, a sequence of tones is perceived (whenever possible) as a “melody”. This is the bottom-up dynamics of ordering which we already discussed. However, the top-down dynamics is equally important: The elements (dots or tones) do not simply disappear in the Gestalt, as was said in undifferentiated holistic approaches. In contrast, the constituent parts (points or tones) often obtain a new and specific meaning within these orderings. In a melody, for example, you find the phenomena of the root and the tonic keynote, which gives this element a particular meaning that it would not have without the top-down influence Gestalt.

Therefore we have the bottom-up perspective of the dynamics in which the parts contribute to the whole and also the top-down perspective of dynamics in which the whole shapes and influences the parts. In the interdisciplinary systems approach Synergetics (Haken, 1992), there is a precise formulation of so-called *order parameters* on the macroscopic level, which represent mathematically the order, and the dynamic on the microscopic level that is *enslaved* by these order parameters. (The term “enslaved” was used, before it turned out that the descriptions and explanations in physics are relevant for psychical and social processes, too. Here, of course, the term “enslave” is problematic). Typical examples are in different realms (without going into much detail here—and omitting examples involving cognitive aspects, which we will discuss again in the next paragraph):

- **Laser:** the coherent light wave, which synchronizes the emission of light from the individual atoms in such a way that they contribute to a common light wave; which in turn *enslaves* the dynamics of the atoms (photon emission);

- **Bénard Instability:** the hexagonal macroscopic, coherent movements in the form of convection “rolls” which *enslave* the movements of the individual molecules in such a way that they contribute to the common pattern of movement;
- **Rhythmic Applause:** the spontaneously arising common clapping rhythm, which often emerges from the chaos of applause after a concert, synchronizing the individual clapping rhythms in such a way that they contribute to the common rhythm;
- patterns of interaction and interpretations in a “**marriage crises**”: the mutually structured climate of distrust, insinuation, misrepresentations, and allegations which undermines the benevolent trusting interpretation of actions in such a way that this climate (i.e., cognitive-interactive field) dominates and shapes the thinking, perceiving, interpreting, and acting of each partner, enslaves the patterns of interaction, and contributes in turn to this climate of distrust. This has been also discussed in the starting example.
- **Corporate Identity:** the common imagination of the goals, values, and principles of a company (or other organization), which shapes the activities of smaller departments or individuals in such a way that they act in the sense of this imagination and thus contribute to it.

All of these examples have the following in common: Order parameters on the macroscopic level—which mathematically represent a field of structuring forces—are relatively stable (i.e., if at all, they only change slowly) and *enslave* the microscopic dynamics. Again: this is the top-down perspective of the interrelation. At the same time, however, the order parameters (and the field which they represent) are nothing other than abstract structural variables, to which all of the elements on the microscopic level contribute by means of their dynamics. Again, this is the bottom-up perspective of the interrelation. Accordingly, the coherent wave of the laser is made up of emitted light (waves) of single atoms; the highly ordered “rolls” of movement in the Bénard Instability are made up of the movements of single molecules; the coherent applause rhythm consists of the hand-clapping of many individuals; the climate of distrust is composed of the interpretations and communications of each partner; and the “corporate identity” consists of the imaginations of the individuals. These common descriptions of phenomena in totally different realms underline our claim at the beginning: these realms and their phenomena are not “reduced to natural science” by referring to these principles in description, rather, these are descriptions which have their meaning and relevance for understanding dynamics in areas investigated as well in physics, chemistry, etc. as in psychology, sociology, etc.

During the self-organized formation of order (so-called “emergence”), these order parameters first develop in relation to competing possibilities of order by means of weak fluctuations. Some of these alternatives of possible order, however, do not represent the overall condition of the system and its surroundings as well as others—as a consequence, they lose the competition and their special contribution to the dynamics becomes weaker and weaker. Other alternatives lose the competition just by chance.

Accordingly, and also in our examples, the forces of order become stronger and stronger while the order establishes, and by this more strongly enslave the dynamics of the parts on the micro-level in a circular-causal manner (*autocatalysis*). For example, the louder an adequate rhythm emerges out of the chaotic noise of many clapping rhythms the higher is the probability that other persons will join that rhythm which again increases the loudness of this rhythm. Although the order parameters emerge in a self-organized fashion, they nevertheless represent the environmental conditions of the system in such a way that they represent one (of two or many) possible adaptations to these external conditions (represented by so-called *control parameters*). For example, if the clapping rhythm is inadequate to the needs or possibilities of many persons—may be too fast or too slow or too complicated—then there is no chance that this rhythm can win the competition against other emerging rhythms that are more adequate.

In most cases, the order parameters represent the minimization or maximization of certain variables (or aspects), which coordinate the relations between the system and its environment. For example, in the case of a laser, this concerns the maximization of the flow of energy; in the case of the Bénard instability, the convection movement transports a maximum of energy through the system of molecules. Admittedly, beyond the clear description of these variables in natural sciences due to the advanced nomothetic structure of science, it is not so clear which variables or aspects are minimized or maximized by the emerging order in social science or psychology. However, at least on a phenomenological level, it makes sense to understand the emerging order that way and analogously indicate the transferability of the concepts of self-organization to such topics. For example, in the experiment of iterative remembering of a configuration of points (Fig. 27.5) it is rather plausible, that a clear, simple, and well-known pattern like a square minimizes the difficulties of perceiving, remembering and reproducing. Similarly, the clapping rhythm supposedly concerns the maximization of the expressive group feeling; the marriage crisis concerns the maximization of the caution against harm and even more about “being the fool”; and in the case of corporate identity, it is a matter of the maximization of the feeling of coherence and the clarity, in the sense of belonging to the organization in contrast to competitive alternatives. Further research, of course, requires a careful analysis and the definition of the exact processes and operations in order to enable the transferability of concepts from Synergetics more than mere metaphorical. I am, however, hopeful that it is possible, and in the case of the “clapping rhythm” example, this has already been shown to a large extent (see Kriz, 1999b, 2004a; Néda, Ravasz, Brechet, Vicsek, & Barabási, 2000).

In the examples mentioned, the central aspect was that the self-organized orders were just in nascence—a so-called *emergence*. In the fields of psychology and social science, however, there are many phenomena for which it makes sense to assume that the order and their order parameters have developed already before the relevant time-frame of observation, and that these order parameters display their effects now, in the current dynamic.<sup>4</sup> For example, many of the ordering principles with which

<sup>4</sup> Elsewhere (Kriz, 1997), I have pleaded for the differentiation between (a) structure emergence, e.g. formation of attractors, (b) structure representation through a dynamic process, and (c) structure representation through display.

an adult structures his relations to the world, to other people, and finally to himself can be understood as order parameters, which emerged in early development through self-organization (but, of course, in relation to the environment).<sup>5</sup> Accordingly, the operators that play a central role in various approaches under the concept of “schema” are normally structuring principles which emerged already years ago. In the current processes of perception, cognitive processing, and expression (including actions and movements), these structuring principles actualize and unfold their shaping forces which act on the new material of cognition.

### **“Schema”—A Nice but Ambiguously Used Concept**

Already in the above mentioned work of Bartlett (1932), who coined the term “Schema” and introduced it into psychology, the cognitive reception of complex and new material meant assimilation through existing schemata. Moreover, Bartlett stressed that the act of memory requires an active “process of construction”. In this process of remembering, existing schemata are used to construct compatible details.

According to Piaget, who took Bartlett’s schema concept and differentiated it further for his developmental psychology, every cognitive activity is interplay between *assimilation* and *accommodation*. *Assimilation* structures a situation according to already existing schemata. *Accommodation*, on the other hand, means that the environmental conditions are such that the schemata can no longer adequately work and, therefore, they modify themselves in order to adapt the organism to the new conditions. In the terminology of Synergetics, this is a “phase transition”: the system’s dynamic abandons an established state of order, passes the gate of chaotic instability and creates a new attractor due to modified environmental conditions (i.e., control parameters). In our discussion above we called this “developmental tasks”—remember the example concerning the 3- and 23-year-old boy and the different demands to his psychic and interactive patterns. Piaget assumed a hierarchy of schemata, whereby higher-order schemata work as structuring operators on lower schemata—and at the same time, again through circular causality, the higher-order schemata emerge from this process.

The schema concept has the problem, however, that two very different aspects and levels of the process dynamics are often confused with one another: “Schema” is understood mostly in the sense of ordering forces, thus meaning the operators, order parameters, or ordering forces mentioned above. For others, however, “schema” relates to the developed order, thus to the ordered contents. When the term *schema* is used in this chapter, the meaning is the former. For example, neither the maple leaf in Fig. 27.4 nor the square in Fig. 27.5 is a schema. Schemata

---

<sup>5</sup> Some structuring principles—like the figure-ground differentiation, for example—have already even emerged in the process of evolution. However, in our considerations here they play no central role, as we share these principles to a large extent with all people, and they lie outside of our time-frame for self-organization processes.

are the operators or ordering forces which lead the dynamics to the maple leaf and the square, respectively. Unfortunately, many examples of an unclear and “mixed” use or interpretation of *schema* can be found in the literature. *Schema* is used there as ordered “*content*” or, even worse, both meanings are mixed together by one author within one and the same paper.

For this reason, we prefer the concept of *order parameters* which defines a field that influences (or even *enslaves*) the current dynamics. Here, the term “field” is to be understood in purely abstract terms (similarly to the idea of a “variable space” in psychology)—in no way does it require Euclidean space. Accordingly, Gestalt psychology had already referred to Einstein’s field definition: “A totality of simultaneously existing facts, which are understood as being reciprocally dependent upon one another, is what one calls a field” (Einstein, 1934; after Metzger, 1986). The Gestalt psychology of the Berlin School (Wertheimer, Koffka, Köhler) understood “Gestalt” explicitly in the context of such a field conception. This was specifically elaborated by Köhler in the context of his isomorphism thesis, and by Lewin (1935, 1938) in the context of (psychological) field theory. These concepts did not only sway Bartlett and Piaget strongly; Haken also explicitly refers to Gestalt psychology in his consideration of psychological phenomena. Accordingly, the connections of these Gestalt aspects with Synergetics are further elaborated in a volume of Tschacher (1997) about “Prozessgestalten” (*Gestalt of a Process*).

It should be noted however, that the field-concept in order to refer to the structured whole was also used in other *Ganzheits-* and *Gestalt-*Traditions, particularly by the Würzburg- and by the Leipzig School (see Chapter 6, this book). However, *Ganzheit* refers more to the bottom-up aspects, i.e. focuses on the question how elements or parts are dynamically integrated into a meaningful *Ganzes* (whole), while *Gestalt* explicitly includes the top-down aspect of the dynamics, too. Particularly Lewin became famous for elaborating a comprehensive field theory of human’s cognitive processes in their relation to the world.

These top-down influences of fields (including meaning fields) will further be discussed in the next paragraphs.

## Ordering Fields in Cognitive Dynamics

Haken (1992), with reference to the circular causality between the field (described by the order parameters) and the micro-level dynamics, emphasized that pattern formation and pattern recognition are to be conceived of as two sides of the same coin. If a part of the subsystems (or elements) is already ordered, a field is generated, which “enslaves” the rest of the system—thus completing the order. From this perspective, pattern *formation* takes place.

Orders are “*recognized*” the other way around, in that some features of the order similarly generate a field (or order parameters), which completes the further characteristics of the order (cf. Fig. 27.8 with some of the above examples).



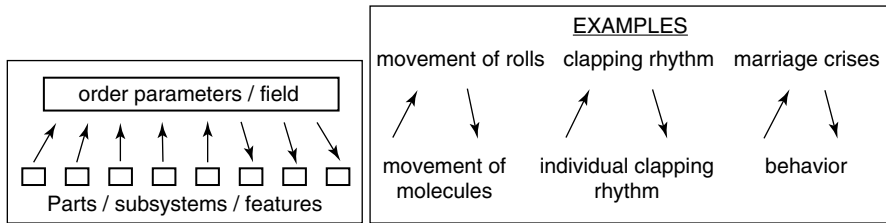

Fig. 27.8 Circular causality

The concept of *completion dynamics* is also relevant to cognitive processes. The macroscopic order is reestablished according to the field’s order parameters. A classical experiment from Asch (1946) can, for example, be newly interpreted from this perspective. Asch was a proponent of the Gestalt psychological view, and therefore pointed out that the overall impression of a situation or of a stranger is not just a collection of various separate pieces of information. Rather, the given information is seen in a context and thus yields an organized whole.

Therefore, when we look at a person, a certain impression of his character emerges immediately in us. This corresponds to the completion dynamic. In one of Asch’s richly varied experiments, a description of a person, in the form of a list of six typical characteristics, was read slowly to students. One group was presented with the following list: “intelligent-industrious-impulsive-critical-stubborn-envious”. Another group was given the same list but in reverse order: “envious-stubborn-critical-impulsive-industrious-intelligent”. It was shown that the first group had a clearly positive impression of the described person afterwards, while the other group had judged the person in a clearly negative manner.

Often quoted in the literature as a “primacy effect”, this finding can also be understood in the light of circular causality or completion dynamics, as shown in Fig. 27.9. The first characteristics generate an overall impression, which “enslaves” the interpretation of the further characteristics correspondingly—i.e., each in turn further completing the image of that person. For example, “critically” can be understood in a more positive or in a more negative way—or, more precisely, being part of a positive judged person or part of a negative judged person.

These few examples should demonstrate the fruitfulness of the system-theoretical approach and its principles, even when applied to the reconstruction of psychological phenomena, findings, descriptions, and the associated dominant principles. It therefore stands to reason to apply this approach to the investigation of mental and/or affect-logical<sup>6</sup> completion dynamics.

Already the example of Ute and Peter, discussed at the beginning of this chapter can illuminate the relevance of cognitive completion dynamics in everyday life.

<sup>6</sup> I use “affect-logically” here, because the meaning of “cognitive” in former times included the entire cognitive process (thus, naturally, rational, and affective components), but was then absurdly reduced in psychology to “rational-logical” aspects. As a consequence, one now has to readjust this analytical one-sidedness of this view with creative terms like “cognitive affective”.

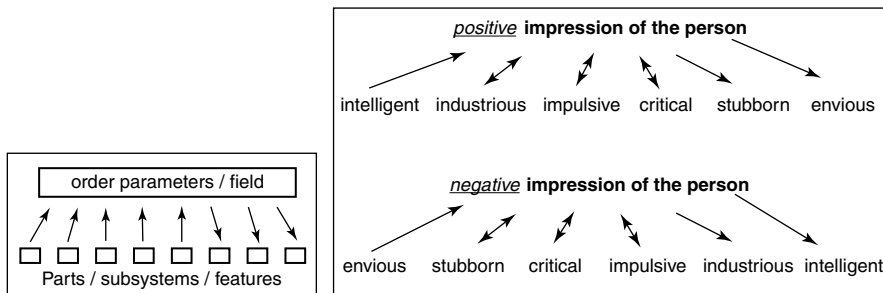

**Fig. 27.9** Asch's experiment, seen as a completion dynamic in a cognitive field (the directions of the arrows only illustrate the possible main directions of the forces)

Peter does not really listen to Ute's words—like we do too often in many social constellations—but takes only very few stimuli (together with already existing expectations) to complete in his mind by the dynamic of his thinking a “well known meaning”.

Similarly, the psychoanalytic concept of *transference* can be discussed from the perspective of completing dynamics. In contrast to a high structured situation in the everyday world, where a lot of material and social external demands are rather clearly “given”, the psychoanalytical setting is very underdetermined. There is no desk with piled-up papers or tasks, not any client or colleague in front of you or on line who asks for clear information. Instead, there is a rather empty room with a couch or some chairs and, moreover, a person with an open but very unclear offered relationship. In this underdetermined situation is the high complexity of possibilities and therefore the need of structuring evident. Due to the lack of external structure and operational tasks the patient is forced to structure the relationship to the analyst in the way he structures relationships in his personal Lebenswelt by using the ordering principles he has developed to cope the experience of interactions with the social world, particularly in early childhood. Therefore, a patient rather seldom mistakes the analyst for his father or takes “pieces” of information out of a “container” called memory—a totally mechanistic way of description. Instead, some cues in this underdetermined situation—there is a “man” and I feel unclear about what to do, even what to say—call up the ordering principles of relationship to a man while being in a somehow inferior position. These ordering principles have emerged in the biography, particularly in early childhood when the first steps to create order in a chaotic complexity of experiences had to emerge (aside from inborn structuring principles). And these order principles shape here and now the perpetual stream of impressions (experiencing, perceiving), the perpetual stream of expressions (behaving, acting), and, linked to, the perpetual stream of consciousness (thinking, feeling). Where “linked to” means: *moderates and is moderated by* (Kriz, 1985, 2004a). As a consequence, the patient sets here and now these old structures into action. Under these circumstances, the ordering principles from early childhood can be seen very clearly due to the lack of many other ordering forces from everyday demands which would interfere too much. We can say that

the patient completes the few cues of the here-and-now situation according to the ordering forces from early childhood. And, of course, some experience from early situations will be remembered. However, this happens in the way Bartlett and other understood “remembering”, i.e., *constructing*.

To this end, numerous experiments have been conducted in Osnabrück in the last 15 years, in which the attracting strength of the affect-logical processes was examined in quite different contexts (overviews can be found in Kriz, 1999a, 2001, 2004b). It should be noted that there are two alternatives to particularly observe the power of ordering forces. At a first glance these alternatives seem to be contradictory, namely when too much (too complex) or too less (under-determined) information is given. In the first case, ordering processes reduce the incomprehensible amount of detailed information. In the second case, ordering processes reduce the incomprehensible space of possibilities (possible meanings, interpretations, “facts”).

## Order Parameters in the Surroundings of Orders

What then does a meaning field organize? In Asch’s experiment, for example, may the following question arise: Is the interpretation of the “person” organized by the field that came up from the attributes (micro → macro, or bottom-up) or is the meaning of the attributes organized by the field that came up “down” from the impression of the whole “person” (macro → micro, or top-down)? Of course, a great number of influences on meaning are always active, operating in the sense of mutual penetrating and interacting fields. For example, our understanding of meanings is subject to social, familial, biographic and general ongoing influences, among other things. This complexity of the aspects and levels is nothing unusual, however, because self-organization always takes place only relative to the environment of the system. Thus, for example, in the case of patterns of interaction in a family, a variety of influences always take part in the self-organization process—social (including legal aspects); biological and evolutionary; individual biographical; and ongoing. These rules and orders are then predetermined for a family, and (nearly) closed to influence. Of course, these influences naturally play a role when trying to understand a particular interaction pattern in the family. However, it makes sense to focus only on one certain aspect—namely on how such a pattern in the dynamics of interaction develops and stabilizes through self-organization (with respect to the influences of the “environment”). Under given societal or biological rules, for example, these patterns can be on the level of the interpretation and the actual conversation about these rules.

In the case of fields of meaning there are also influences on different levels. For example, on the societal level certain categorically reduced themes have already been evolved in our culture, which work as very strong “meaning attractors”, as was discussed at length elsewhere (Kriz, 1997, 2004a). These attractors enslave the interpretation and bring about a contraction in the space of perceptions and interpretations in the cognitive processes of individuals, couples and families. As

a consequence, people end up with a narrow horizon where alternative options are left out of the view. Typical themes, operating as such malignant “meaning attractors” often narrow the options of interpretation and action, are for example “good–bad”, “true–false”, “sick–healthy”, “guilty–innocent”, “correct–incorrect”, “right–wrong”, etc. These themes, of course, refer to great and important aspects of orientation in the life of human beings. However, they develop malignant power when they are understood in a totalitarian way (Kriz, 2004a). For example, when you “know” what “sick” or “crazy” behavior “is”—or even personalized, who the “sick” and “crazy” guy in the family is—then the stream of a multitude of situations with different interpretations of meanings, causes, motives, options, etc. is reduced and encrusted to a single attribute (cf. Fig. 27.3 and the related discussion of Kevin’s “behavior disorder”). The so-called *basin* of the attractor, i.e. the area of meanings and situations which can be related to “sick” or “crazy”, is very large. This is also the case for all the above mentioned pairs of attributes. Moreover, these categories are connected with important values and therefore combined with strong affects. This, again, supports attracting and reducing forces in order to get “clarity” and to feel more secure and weakens the elaborations of differentiated thinking of the “cool mind”. Finally, for many situations, these categories give a (wrong but) simple “explanation” of what is going on. Therefore, the “bad”, “sick”, “crazy”, “incorrect”, or “wrong-acting” guys have little chance to revise the judgment. Nearly all what they may do, can be interpreted by this attracting attribute and by this give proof that the judgment was correct, of course.

There are many other fields of meaning in language, culture, and society which cannot be modified a great deal by individuals within a short time. It is interesting, therefore, to analyze how fields of meaning in communication develop through self-organization relative to such fields of meaning and sense attractors that are already in existence. We will take the communication between only two people as a central example (e.g., a couple or a patient and therapist). It is easy to see, however, that these principles can be extended to communications involving more than two people.

Our starting point is the fact that communication always contains two sub-processes: the process of “*incitation*” and the process of “*excitation*”, as Nørretranders (1997) puts it. The words which one person says to another represent a very large amount of “meaning information”, which exists consciously and unconsciously “in the head” of the speaker, and is “infolded” more or less into the spoken words. In doing so, certain aspects are selected and others discarded and information is condensed. However, at the same time some aspects are simultaneously unfolded and developed and “appropriate” words and metaphors are sought. This information, condensed by “incitation”, is now voiced and, in the process of understanding, excited by the listener, i.e. unfolded. This “tree of speech” is roughly illustrated in Fig. 27.10.<sup>7</sup>

<sup>7</sup> Here, the structuring rules of the metaphors of speaking and understanding (which are overlooked far too often) should be taken into account. These are very concisely elaborated in Jaynes (1976), with reference to the “characteristics of consciousness”: Specialization, Excerption, the Analog ‘I’, the Metaphor ‘Me’, Narratization and Conciliation (for details, see Jaynes, 1976).

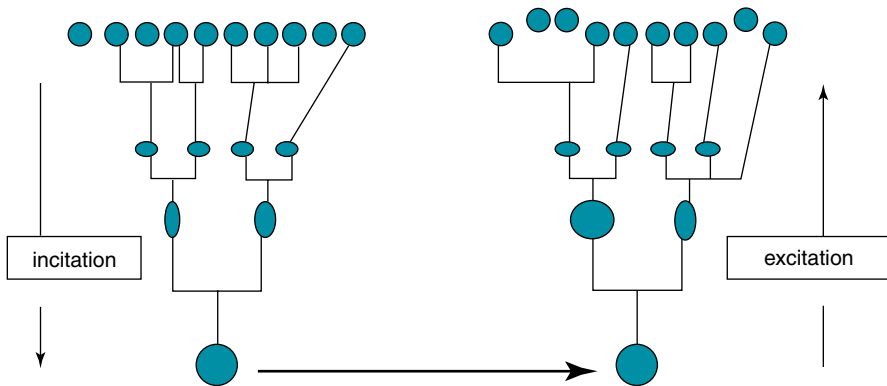

Fig. 27.10 The tree of speech (after Nørretranders, 1997)

Along with all of this, it must however be considered that “verbalizing” and “listening” as a rule regard a small portion of a longer process, in which both partners are involved by means of diverse feedback loops. As a consequence, that which the “verbalizer” has “in his head” (in the broadest sense) at a particular instant—i.e. the meaning which he would like to communicate and has to incitate—depends on many aspects. Besides the above mentioned common fields of meaning in society (i.e., the rather “general” meanings of the words, for example), it also depends on the preceding course of the communication. This determines what actually comes to his mind, what he assumes to be meaningful to the listener, what he chooses, etc.

Even stronger, though, is the influence of previous experience in the case of the excitation of the listener. Naturally, he doesn’t necessarily unfold his meaning according to the meaning in the head of the speaker (inside of which the listener obviously can’t see; otherwise one wouldn’t need to communicate). Rather, he excites according to the cognitive ordering processes in his own head—and these often have a lot to do with his own biography—rather than giving consideration to the message or to the meaning in the speaker’s head.

As was already discussed above, the words of the speaker can often act as a sort of trigger for starting “inner movies”. Here then, the excitation is almost stimulus invariant: what is activated (and which will then be responded to), is that which one wants to hear, i.e., the meaning that is *assumed*. And people all too often no longer check back whether this meaning is also seen in the same way by the other person. This was illustrated above by the sequence where the therapist asks the woman in a relationship counseling session: “Did you hear what your partner just said?” and she answers “No, I didn’t—but by the way he looked at me, I already knew what he would say!”

On the other hand however, a communication that succeeds sufficiently well means that a *common* field of meaning emerges from the many running feedback loops (including the expectation of the expectation regarding the interpretation of meaning). This field governs both that on which both actually focus the conversation, and the processes of incitation and excitation. During the course of the com-

munication, a more or less exclusive shared field of meaning thus emerges between both partners. This exclusivity perhaps becomes clearest, when it is obvious to both that the whimsical expression of an “Olé!” is an allusion to a bullfight during last summer’s holiday in Spain, which may have been followed by a particularly lovely evening spent together. In this example, there are certainly further aspects that both partners unfold in a similar manner. However, there are other aspects that each partner unfolds in their own more private and individual way—connected with *non*-shared associations.

To the outsider who didn’t take part in the development of this common field of meaning, the meaning of the “Olé!” remains largely cryptic. If necessary, he can indeed excitate something from *his* experience of life that makes sense to *him*. And when he now communicates this, a common field of meaning develops, to which *all three* persons contribute. At the same time, however, this example makes it clear that in a field of meaning, different substructures can be active for the individual participants. For example, the third person could probably never participate in *all* of the *commonly* excited meanings of the *couple*. And in the same way, the couple cannot participate in *all* excited meanings of each individual partner. Communication is just—in the actual sense of the word *communio*—a larger or smaller participation in a field of meaning that is developed in common. In no way, however, is it the possession of all meanings of the other (and certainly not a possession of “the truth”!).

It should now be clear, that the emergence of a common field of meaning of two (or more) partners and the ordering processes of incitation and excitation, can be well described in terms of Synergetics, with its circular causality, order parameters, and completion dynamic. Figures 27.8 and 27.9 can be expanded into Fig. 27.11. This can describe how two or more persons create a common meaning field by completion dynamics. Vice versa, this common meaning field *enslaves* the dynamic of understanding and interpreting situations (filled with words, acts, behavior, things...). Similarly to the well known term *synchronization*, which refers to the phenomenon that two or more persons mutually coordinate activities (like dancing, moving, singing) in *time* (Greek: *chronos*), I have proposed and coined the term *synlogization*, which refers to the just discussed phenomenon that two or more persons mutually coordinate their process of making meaning (including certain denotative and connotative word-meaning relationships) by developing common meaning fields. This process does not at all require any coordination in time. For example, two persons can create a common field of meaning by writing letters to each other in long time sequence. Therefore, *time* is not important but *meaning* (Greek: *logos*). As a consequence, the term *synlogization* has been coined (Kriz, *in press*).

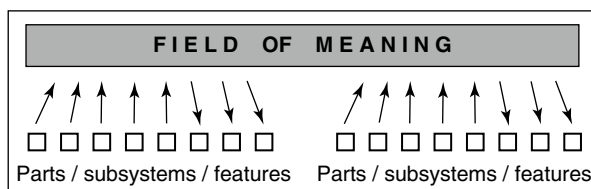

**Fig. 27.11** Two (or more) people develop a common field of meaning

The question, which can again be discussed here only briefly, of when the self-organization processes which generate a common field of meaning are particularly effective, can be answered similarly to the question of the effectiveness of order parameters in general. They are more effective the less the dynamic is influenced by other fields. So, to refer to the above discussed example of psychoanalysis, the strange forces of fields whose effect we describe as “neurosis” can hardly become effective when the situation is strongly pre-structured. Because, when one buys bread in a baker’s shop there are all these shelves, filled with bread, and more things that clearly indicate that he is at the baker’s. Moreover, the salesperson asks which sort of bread is wanted which reminds the shopper why he is in that shop. In a word, everything is so clearly structured that the interaction dynamic will be dominated (one can by all means say “enslaved”) by this. Quite contrary to this, in a very unstructured situation—for instance on the psychoanalyst’s couch or while getting to know a new partner—it is exactly those neurotic field forces that are effective (and so are open to experience and observation).

Accordingly, the probability is low that a common field of meaning will self-organize when the meanings are already strongly pre-structured—for instance when the conversation is characterized by clear logical deductions, definitions, use of simple facts, etc. (shared by both parties). Then on the one hand, hardly any reduction in complexity is needed, and/or the rules of the incitation and excitation are explicitly and normatively set.

## **Intuition in Social and Scientific Context(s)**

In the mainstream sciences (including psychology), “intuition” is a concept that has been comparatively under-researched. If anything, one can even say that Western science banished the idea of intuitive access “to the world”, for example, during the battle against witchcraft and alchemy. Instead, science gave a one-sided preference to the analytic-discursive approach. In summary, one can say that Western science mainly propagates a means of access to the world in which intuitive, holistic, and qualitative (in the sense of “qualia”) aspects are irrelevant.

However, dynamics or developments, which in their early stages are not yet very distinctive, but move towards an order that becomes increasingly apparent, are quite often intuitively grasped. Using the concept of “attractor”, exactly this phenomenon is investigated and discussed in systems science: In the development and change of dynamic order, a process moves towards a state of order (the attractor) that is only gradually established. Without question, this concerns a teleological principle that was banished from classical Western science a long time ago because of its “obscurity”. Now, as a result of the “attractor” concept, it has returned again with dignity to modern natural science. From the perspective of established order, one can also say that a still very incomplete order becomes increasingly completed during an attracting process (the so-called “completion dynamics”).

**Fig. 27.12a, b** Iterative point dynamics, each based on four transformations (from Kriz, 1992), see text for explanation

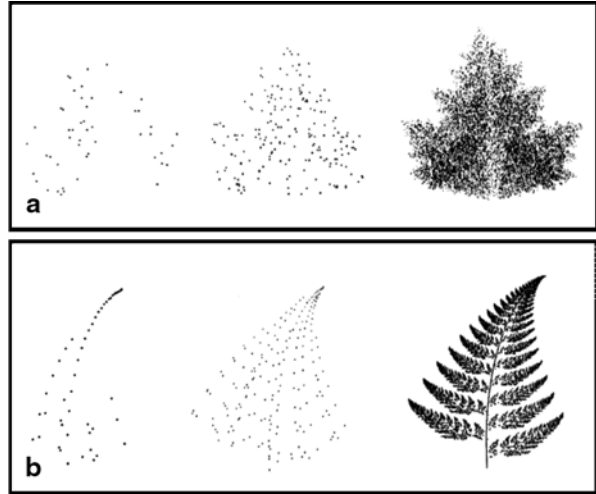

Without going into detail here (see Kriz, 1992, 1999a,b), this process can be illustrated as in Fig. 27.12 In this figure, an operation (or transformation) is carried out on a randomly chosen point, which then produces another point. The same operation is then carried out on this new point, and so on; and in this way increasingly many more points arise. The iterative application concerns one (or very few—here: 4) operations. According to the operation rules (equations that describe the transformations), a “fern” (Fig. 27.12a), for example, or a “maple leaf” (Fig. 27.12b) arise. The entire procedure can be understood as a dynamic process, out of which the form (order) of the “leaf” or “fern” increasingly develops. The images on the right each contain 10,000 points, those in the middle contain 500, and the pictures on the left have only 50 points. Nevertheless, the developing order can already be recognized in the middle image (which contains only 5% of the final number of points).

The answer to the question of exactly what it is that is special about the dynamic principle of developing order, as compared to the classical analytic-synthetic idea of order is perhaps made even more clear in Fig. 27.13. The plant-like image on the right can be produced using the “normal” conception of order (and classical geometry) by means of a long series of instructions of the following form: “draw a straight line of x cm; then after y cm from the starting point move to the right by z degrees and draw again...” One would need very many such instructions, but in

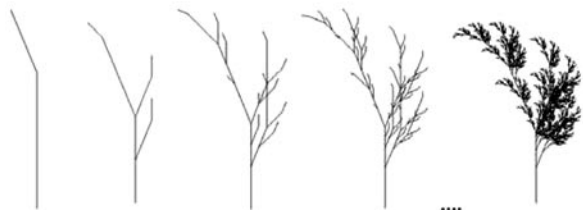

**Fig. 27.13** Recursion of one simple geometrical operations



principle it is possible to use this method to produce exactly this drawing. In fact, it's possible that there are many people who might regard this as the only possibility of producing it.

The alternative possibility is described by the sequence of pictures beginning on the left. In this case, it is a matter of only one simple operation that is carried out on the first picture on the left. The same operation is then performed on the result (second picture from left), and so on. After just six such repetitions (“recursions”), the picture on the right already appears. This process of development—which could even be called the “unfolding” of the ordering potential of this operation—is indeed very different to the step-wise linking of lines in the operation first described above. However, in the step-wise production every step can be controlled and compared to the final picture in order to detect errors and to correct them. In the dynamics of unfolding, in contrast, one has to trust that the final order will emerge, because for many iterations (or: for a long time in the process) it is not so evident that the process will really arrive at that form (especially when the forms are more complex—for example a photo of a face). And, as we already discussed, for many people (and organizations) it is much more comfortable to control than to trust.

By implementing such development processes in a computer program and using more complex end-pictures, it becomes clear that a holistic-intuitive means of access can already grasp and “anticipate” the emerging order at a rather early stage.

This was shown in Fig. 27.12, where a very slight development of the order—that is, a very small part of the final information—could be seen and completed intuitively to arrive at the final picture (fern or leaf). The final order—the “attractor”—exists only at the “end” of the development (given a certain time-window in which to observe the development). But the ordering forces (called “order parameters” in Synergetics) increasingly manifest the order in a way that can be discerned by a cognitive system. Subjectively, the order—that is the figure—appears “as if out of a mist”. It is not a case of “clear detail” after “clear detail” that fit together into a whole. Rather, a holistic shape forms from the beginning—a shape that is, however, very unclear and blurry at first, gradually becoming clearer. This is shown in Fig. 27.14.

From this perspective, intuition can be characterized as the ability to grasp developing or unfolding (or in some way: changing) order in its essential aspects and as a complete whole, even in the early stages of development, when this order can only later be fully described in an analytic way.

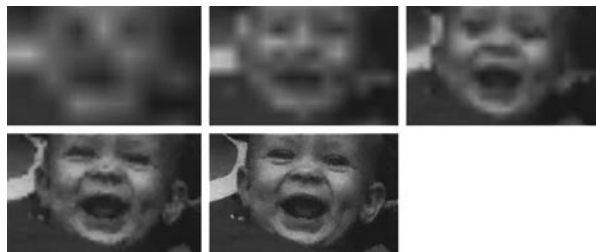

**Fig. 27.14** Recursion of more complex geometrical operations (but in general the same procedure of fractal encoding and decoding as in Fig. 27.13)

## Imagination Versus Planning

With respect to imaginative and creative processes which are, undoubtedly, essentially for our world as human beings the teleological aspect of attractors comes again into our discussion. Teleology represents “forces from the future” which are indeed rather typical for cognitive and interactive dynamics. When we ask a student who is going downstairs (in an university building) to a special lecture: “Why are you going?” we would find the following explanations very lousy: “due to gravity”, or: “due to the impetus of my movement”. We also would question the (past oriented) explanation: “because I decided yesterday to do that”—asking: why did he made this decision, what were his expectations? Wouldn’t it just be the most simple and satisfying (future oriented) explanation when he says like this: “because I want to hear the lecture of Prof. X?” Here the expectations or imagination of future states are indeed very important in order to understand the dynamics.

In this context, I would therefore plead for a more equal balance between the normally overemphasized planning of actions and the completely undervalued imagination (Kriz, 2008). Planning means that one can start a process from a clearly analyzed status and that this process proceeds in well defined steps in order to reach an explicitly given aim. Deviation or departure from these steps is interpreted as failure or error and, therefore, it is corrected or eliminated. If goals or conditions change, planning must begin again. Imagination, on the other hand, is a typical example of a cognitive dynamic with a systemic attraction. Moving towards a goal, perhaps some professional aim, we have only a vague idea about the concrete realization. For example, if one wants to become a professional psychologist, it is rather vague at the beginning of one’s studies what the job will really look like in 5 years. Moving towards this vague goal, however, there are decisions to be made along the way that then clarify the goal. This corresponds very well to what we said above: The attractors become clearer and more detailed and precise as the attractive dynamic develops the system in the direction of these attractors.

This process of approaching a goal leaves room for creative and flexible adaptation to the given, but also to unforeseen developments, changes, and disruptions in peripheral conditions. On such a path, deviations pose no difficulties and will not be seen as unpleasant surprises standing in the way of some precisely defined plan. On the contrary, even major corrections to one’s plans are normal and to be expected. Instead of controlling the plans and goals and trying to avoid diversions, detours, and surprises, the main moving forces here are openness, creativity, flexibility, and a search for meaning.

It is not my intent to set one principle against the other, as both have their own justification for being, just as dynamics and stability are oppositional but equally necessary. I do, however, wish to critically question a one-sided emphasis on planning in preference to imagination. It is precisely in times of upheaval and change that flexibility and creativity are more likely to be appropriate and successful than the controlled security of precisely defined plans.

## Conclusions

In the last decade of the 19th century and in the first three decades in the 20th century, there has been an important stream of psychological thought which stressed by concepts such as *Gestalt and Ganzheit* the field dynamics in processes of perceiving, thinking, remembering and so on. Field dynamics explicitly contrasts the ideas of “independent” and “dependent” variables, of linear cause-effect-relationship, of non-historical states or of imposing order as being the *only* way that we get order. These approaches had developed their particular methodology and scientific tools in order to investigate the phenomena of interest (see Diriwächter, 2009—Chapter 16 and Wagoner, 2009—Chapter 5, this book). For example, when “change” from A to B, observed on an “dependent variable”, is not just determined by an “independent variable” but of the hole complex situation (which includes the former experience and the path on which A has been arrived at) then analysis has to be made on single cases first and all further steps of aggregation or generalization have to be made with increased attention to artifacts. Summing up different developmental paths is always very dangerous and could only be done very carefully (Kriz, 1981, 1988).

After the Second World War, these traditions and methodologies were, to a great extent, superseded by the behavioristic approach and its methodology. Moreover, concepts like “actualization” (i.e. self-organized ordering and development by order-order-transition) were devalued as being “less scientific” compared to randomized controlled designs with a clearly defined cause-and-effect relationship between independent input-variables and dependent output-variables.

In the last decades, however, there is a convergence of these “old” psychological traditions and modern interdisciplinary systems theory. For example, “dissipative structures”—the concept for which Prigogine got the Nobel-prize, 1977 in chemistry—is much more in tune with the principles of *Gestalt-* and *Ganzheits* psychology than with the principles of behaviourism. Moreover, the physicist Haken, founder of the interdisciplinary program *Synergetics*, explicitly refers in his work to these traditional psychological notions and principles.

In this chapter, I have tried to show that concepts from interdisciplinary systems theory, particularly Synergetics, can be used to discuss and illuminate the dynamics of cognitive and interactive processes, too. Systems theory can describe following phenomena, for example, in the real of physics or chemistry: Due to smooth changes of conditions in the environment of a system, a self-organized order—i.e. a pattern in system’s dynamics—can emerge. Furthermore, established order can, again self-organized, become instable and by phase transition create a new dynamically order when the environmental conditions change. Emergence and phase transition of order are non-linear linked to these changes in the environment. That means that small changes in the environment can result, in some dynamically states (near points of instability), in dramatically changes of the system. On the other hand, rather big changes of the environment can result in nearly nothing (at least no essential or qualitative change) when the system is in a stable dynamic state (*attractor*). Therefore, one can say that such systems are adaptive to changes in the environment

in the way of the system's inherent structural possibilities. All these phenomena are essential for psychological and interactive processes, too.

Moreover, self-organized systems in physics will complete the dynamically order if only a part of the system is ordered. The dynamic creates, bottom-up, some features, or structural forces (*order parameters*) which, as field-forces, vice versa, "enslave" top-down the rest of the system according to that order. Order always means a reduction of complexity (for example, from myriads of chaotically moving molecules emerge ordered rolls which can be described by a few equations). When the system approaches a certain order (attractor), one can say that's something teleological in the way that the systems develops in the direction of this order. It has been shown in this chapter, that all these phenomena are essential for psychological and interactive processes, too.

Finding these correspondences and using them in order to ask for some illuminating details and relations or to be inspired to create experiments and investigations does not at all mean to reduce psychical and social processes to physics or natural sciences. In contrast, using this correspondence in the phenomena and principles may help to resist the contemporary trend to reduce psychical and social processes primarily to neuroscience and biological psychology in order to be "academic" or "scientific". Systems theory may help to investigate psychical and social processes also on the level of their realm without necessarily looking for their correlations to other realms (electric spikes of neurons, etc.).

However, in natural sciences is the emergence of order and the other discussed phenomena due to the maximisation or minimisation of variables related to (forms of) energy. This is in regard of a certain phenomenon or system clear operationally defined and mathematically describable. Admittedly, this is not so clear for the discussed psychological and interactive processes. Reduction of complexity, attractors, stability, and instability, etc. are here, of course, not related to energy but to information. The reduction of complexity by the emergence of meaning attractors can be seen easily in Fig. 27.5 and roughly be measured in the processes depicted in Figs. 27.6 and 27.7. Moreover, there is a lot of research—which cannot be reported here—by the Synergetics group and others to describe principles of systems theory even for our "soft and weak" variables and measurements in psychology and social sciences in a precise mathematical manner. A lot of research has to be done on that way. However, even without such mathematical and operational precision, this chapter has hopefully shown, that it can be useful to include the systems theoretical perspective in the discourses concerning cognitive and interactive processes.

## References

- Asch, S. (1946). Forming impressions of personality. *Journal of Abnormal and Social Psychology*, 41, 258–290.
- Bartlett, F. C. (1932). *Remembering*. Cambridge: Cambridge University Press.
- Einstein, A. (1934). *Mein Weltbild*. Amsterdam: Querido.
- Haken, H. (1978). *Synergetics. An introduction. Nonequilibrium phase transitions in physics, chemistry and biology*. Berlin: Springer.

- Haken, H. (1983). *Advanced synergetics. Instability hierarchies*. Berlin: Springer.
- Haken, H. (1992). Synergetics in psychology. In W. Tschacher, G. Schiepek, & E. J. Brunner (Eds.), *Self-organization and clinical psychology. Empirical approaches to synergetics in psychology* (pp. 32–54). Berlin: Springer.
- Haken, H., & Stadler, M. (1990). *Synergetics of cognition*. Berlin: Springer.
- Jaynes, J. (1976). *The origin of consciousness in the breakdown of the bicameral mind*. Boston: Houghton Mifflin.
- Kriz, J. (1981). *Methodenkritik empirischer Sozialforschung. Eine Problemanalyse sozialwissenschaftlicher Forschungspraxis*. Stuttgart: Teubner.
- Kriz, J. (1985). *Grundkonzepte der Psychotherapie. Eine Einführung*. München: Urban & Schwarzenberg. (6th ed. 2007: Weinheim: Beltz/PVU)
- Kriz, J. (1985/2007). *Grundkonzepte der Psychotherapie*. München: Urban & Schwarzenberg (6th ed.). Weinheim: Beltz/PVU. (Span. ed.: 2008). *Corrientes fundamentales en psicoterapia* (3rd ed.). Buenos Aires: Amorrortu-Editores).
- Kriz, J. (1988). *Facts and artefacts in social science. An epistemological and methodological analysis of social science research techniques*. Hamburg: McGraw-Hill.
- Kriz, J. (1991). Mental health: Its conception in systems theory. An outline of the person-centered system approach. In M. J. Pelaez (Ed.), *Comparative sociology of family, health & education, XX* (pp. 6061–6083). Malaga: Espania.
- Kriz, J. (1992). *Chaos und Struktur. Systemtheorie* (Bd. 1). München: Quintessenz.
- Kriz, J. (1993). Pattern formation in complex cognitive processes. In H. Haken & A. Mikhailov (Eds.), *Interdisciplinary approaches to nonlinear complex systems* (pp. 161–175). Berlin: Springer.
- Kriz, J. (1997). On chaos and order. *Gestalt Theory, 19*, 197–212.
- Kriz, J. (1999a). *Systemtheorie. Eine Einführung für Psychotherapeuten, Psychologen und Mediziner* (3rd ed.). Wien: Facultas.
- Kriz, J. (1999b). On attractors—The teleological principle in systems theory, the arts and therapy. *POIESIS. A Journal of the Arts and Communication, 1*, 24–29.
- Kriz, J. (2001). Self-organization of cognitive and interactional processes. In M. Matthies, H. Malchow, & J. Kriz (Eds.), *Integrative systems approaches to natural and social dynamics* (pp. 517–537). Heidelberg: Springer.
- Kriz, J. (2004a). Personenzentrierte Systemtheorie. Grundfragen und Kernaspekte. In A. v. Schlippe & W. C. Kriz (Eds.), *Personenzentrierung und Systemtheorie. Perspektiven für psychotherapeutisches Handeln* (pp. 13–67). Göttingen: Vandenhoeck & Ruprecht.
- Kriz, J. (2004b). Beobachtung von Ordnungsbildungen in der Psychologie: Sinnattraktoren in der Seriellen Reproduktion. In S. Moser (Hrsg.), *Konstruktivistisch Forschen* (S. 43–66). Wiesbaden: VS Verlag für Sozialwissenschaften.
- Kriz, J. (2008). *Self-actualization: Person-centred approach and systems theory*. Ross-on-Wye, UK: PCCS-books.
- Kriz, J. (in press). *Synlogisation: Über das Glück, verstanden zu werden und andere zu verstehen*. *Systema*.
- Kriz, J., Kessler, T., & Runde, B. (1992). Dynamische Muster in der Fremdwahrnehmung. *Forsch. ber. Nr 87, FB Psychologie*. Osnabrück.
- Kriz, W. C., & Kriz, J. (1992). Attrahierende Prozesse bei der Personen-Wahrnehmung. *Forsch. ber. Nr 88, FB Psychologie*. Osnabrück.
- Lewin, K. (1935). *A dynamic theory of personality*. New York: McGraw-Hill.
- Lewin, K. (1938). The conceptual representation and measurement of psychological forces. *Contributions to Psychological Theory, 1*(4), 247.
- Luhmann, N. (1984). *Soziale Systeme: Grundriß einer allgemeinen Theorie*, [Frankfurt: Suhrkamp (in English: 1995)] *Social systems*. Stanford: Stanford University Press.
- Maturana, H., & Varela, F. (1980). Autopoiesis and cognition: The realization of the living. In S. Robert, R. S. Cohen, & M. W. Wartofsky (Eds.), *Boston studies in the philosophy of science*. (p. 42). Dordrecht: D. Reidel Publishing Co.
- Metzger, W. (1986). Gestaltpsychologie. Ausgewählte Werke aus den Jahren 1950–1982. In M. Stadler & H. Crabus (Eds.), *Gestaltpsychologie*. Frankfurt/M.: Kramer.

- Néda, Z., Ravasz, E., Brechet, Y., Vicsek, T., & Barabási, A.-L. (2000). Self-organizing processes: The sound of many hands clapping. *Nature*, *403*, 849–850.
- Nørretranders, T. (1997). *Spüre die Welt. Die Wissenschaft vom Bewußtsein*. Reinbek: Rowohlt.
- Piaget, J. (1976). *Die Äquilibration der kognitiven Strukturen*. Stuttgart: Pieper.
- Prigogine, I. (1980). *From being to becoming*. San Francisco: Freeman.
- Prigogine, I., & Nicolis, G. (1977). *Self-organization in non-equilibrium systems*. New York: Wiley.
- Schiepek, G., & Tschacher, W. (1997). *Selbstorganisation in Psychologie und Psychiatrie*. Braunschweig: Vieweg.
- Stadler, M., & Kruse, P. (1990). The self-organisation perspective in cognition research: Historical remarks and new experimental approaches. In H. Haken & M. Stadler (Eds.), *Synergetics of cognition* (pp. 32–52). Berlin: Springer.
- Thom, R. (1989). *Structural stability and morphogenesis: An outline of a general theory of models*. Reading, MA: Addison-Wesley.
- Tschacher, W. (1997). *Prozessgestalten*. Göttingen: Hogrefe.
- Tschacher, W., & Dauwalder, J. P. (1999). *Dynamics, synergetics, autonomous agents. Nonlinear systems approaches to cognitive psychology and cognitive science*. Singapore: World Scientific.
- Tschacher, W., & Dauwalder, J. P. (2003). *The dynamical systems approach to cognition*. Singapore: World Scientific.
- Tschacher, W., Schiepek, G., & Brunner, E. J. (1992). *Selforganization and clinical psychology*. Berlin: Springer.
- Watzlawick, P., Beavin, J. H., & Jackson, D. D. (1967). *Pragmatics of human communication*. New York: Norton & Company.

# Index

## A

Abbey, E., 423, 457, 473  
Abelson, R.P., 371  
Academic task structure (ATS), 374  
Action (A) i-moment, 498, 499  
Adolescent actionism  
    breakdance, battles  
        mutual collective incitement, 532, 533  
        typification, 533, 534  
    case and typification graphic model, 534  
    collective action, 533  
    developmental dimension  
        comradeship and chat, 537  
        mutualities, 535  
        negation phase, 536  
        re-orientation phase, 537  
        shared experiences, 535  
    self-entanglement, 539  
    soccer riots, hooligans, 530, 531  
    techno parties, erotic dances, 528, 529  
Aggen, S.H., 262  
*Aktualgenese* (actual genesis)  
    Gestalt law of *Prägnanz*, 332  
    “here-and-now” development, 335  
    micro-developmental progression, 334  
    psychical development, 334  
    series of the target, 333  
    Wohlfahrt’s figures, 332  
Allport, G.W., 291, 359  
Altman, R.M., 277  
Amidzic, O., 91  
Andersen, A.P., 209  
Anderson, M., 79  
Andersson, G., 197  
ARIMA models  
    applications, social sciences, 196, 197  
    autoregressive (AR) model, 192, 193  
    full ARIMA model, 195, 196

    mixed autoregressive moving average (ARMA) model, 194, 195  
    moving average (MA) model, 193, 194  
    univariate extensions  
        applications, social sciences (SARIMA and ARFIMA models), 201, 202  
        fractionally integrated ARMA (ARFIMA) model, 199, 200  
        impact/interrupted ARIMA model, 200, 201  
        seasonal ARIMA model, 198, 199  
Asch, S., 637  
ATS. *See* Academic task structure  
*Autocatalysis*. *See* Circular causality  
Autoregressive moving average (ARMA) model  
    multivariate extensions  
        applications, social sciences, 207, 208  
        cointegrated model, 205–207  
        latent VARMA model, 205  
        VARMAX model, 204, 205  
        vector ARMA model, 203, 204  
    nonlinear extensions  
        applications, social sciences, 212  
        bilinear (BL) mode, 209  
        conditional heteroscedastic autoregressive (ARCH) models, 209, 210  
        Markov switching autoregressive (MSAR) model, 211, 212  
        threshold autoregressive (TAR) models, 210, 211  
    time series analysis, 191  
    with trends, 198

## B

Bakhtin, M.M., 490  
Bamberg, M., 344  
Bargh, J.A., 69, 70

- Barker, R.G., 373, 568  
 Barkham, M., 14, 180  
 Bartlett, F.C., 105, 106, 123, 135, 138, 139, 635  
 Bartlett-scenario, 627, 628  
 Bartlett's theory, 134, 135  
 Baum, L.E., 276  
 Beals, J., 229  
 Beck Depression Inventory (BDI), 312  
 Bell, N.J., 423  
 Bentler, P.M., 262  
 Berg-Nielsen, T.S., 599  
 Bergson, H., 137, 460  
 Bertalanffy, L.v., 433  
 Bifurcation points (BFP), 482–484  
 Binet, A., 109  
 Blender, J.A., 602  
 Böckenholt, U., 287  
 Body Mass Index (BMI), 312  
 Boesch, E., 473  
 Bohnsack, R., 151, 153, 157, 164, 529, 530  
 Bollen, K.A., 207, 208  
 Bonarius, H., 222  
 Borckardt, J.J., 177  
 Boring, E.G., 107, 324  
 Bourdieu, P., 152  
 Bourgeot, A., 546  
 Bovaird, J.A., 611  
 Box, G.E.P., 198  
 Branco, A.U., 354, 374  
 Brannigan, A., 208  
 Breakwell, G.M., 479  
 Brillinger, 259  
 Bronfenbrenner, U., 567  
 Brooks, R.A., 435  
 Brown, D., 262  
 Brown, S.D., 137, 138  
 Browne, M.W., 213, 261, 262  
 Brummer, E.J., 23, 186  
 Bruner, J., 226, 374  
 Brunner, E.J., 621  
 Bucci, W., 11  
 Buck, R., 201  
 Buckle, H.T., 37  
 Buford, B., 529  
 Bühler, C., 376  
 Bühler, K., 329–331  
 Bureau, A., 287  
 Burrows, L., 69  
 Busch-Rossnagel, N., 220  
 Bye, E.K., 196
- C**
- Callero, P.L., 222  
 Cardaciotto, L.A., 13  
 Card, N.A., 611  
 Casajus, D., 563  
 Casey, E.S., 136  
 Caspi, A., 602, 605  
 Cassidy, J., 3  
 Catán, L., 100, 109  
 Cattell, A.K.S., 205  
 Cattell, R.B., 205, 257  
 CFA. *See* Configural frequency analysis  
 Chandler, M.J., 598, 599  
 Chang, L., 262  
 Chaotic process, psychotherapy
  - dissipative trajectory, 19
  - empirical depiction, communication
    - factorial matrix, 22, 23
    - methodological approach, 21
  - empirical traces, 18, 19
  - phase transition, 17
  - sensitive dependence, 17, 18
  - stationary (ergodic) non linear system, 16
  - strange attractor, 19–21
- Chatfield, C., 191  
 Chen, M., 69  
 Chinese whispers, 627  
 Chrysochoou, X., 480  
 Chung, H., 280  
 Cicchetti, D., 602  
 Circular causality, 632–637, 642  
 Classifying science, 478  
 Claudot-Hawad, H., 546  
 Cognitive and interactive patterning
  - attractors, the teleological aspect
    - attractor 24, dynamic runs, 625
    - bottom-up perspective, 632
    - Chinese whispers, 627
    - circular causality, 634
    - complexity reduction, 624
    - complex pattern, serial reproduction, 628
    - definition, 624
    - dynamics of mean differences, 629
    - graphic representation, 625
    - Kevin's behaviour, 626
    - maple leaf, repeated operation runs, 626
    - results, 631
    - Schema theory, 628, 635, 636
    - top-down, 632
    - women therapeutic session, 626, 627
  - imagination vs. planning, 646
  - intuition, social and scientific context, 643
    - complex geometrical operation, recursion, 645
    - iterative point dynamics, 644



- simple geometrical operation, recursion, 644
  - ordering fields, cognitive dynamics
    - Asch's experiment, 638
    - circular causality, 637
    - completion dynamics concept, 637
    - pattern formation and recognition, 636
    - transference*, psychoanalytic concept, 638, 639
  - order parameters, 632, 633
    - excitation process, 640
    - fields of meaning, 639, 640, 642
    - incitation, 640
    - listening, 641
    - neurosis effect, 643
    - synlogization*, 642
    - tree of speech, 641
    - verbalizing, 641
  - relatedness and feed-back concepts
    - classical mechanistic vs. modern systemic approach, 621, 622
    - male-female-interaction, dynamic circle, 623
    - self-organized order description, 622
  - Cohan, C.L., 202
  - Cointegrated model, ARMA model
    - bivariate time series, 206, 207
    - cointegrating vector (*M*-variate vector **a**), 206
  - Cole, S.W., 202
  - Common factor analysis (CFA), 299, 300
  - Conceptualization, dynamics
    - dynamic systems approach
      - fundamental concepts, 56, 57
      - questionable practices, 56
    - linear efficient causal approach
      - brain and brain-mind relationships, 55
      - Hume's static thinking, 54
  - Configural frequency analysis (CFA)
    - first order and log-linear modelling, 246–249
    - 2-group and log-linear modelling, 249–251
  - Constructive microgenesis
    - comparison
      - common origins, Würzburg school, 106, 107
      - experimenter and participant relationship, 110–112
      - process and product, 107–109
      - Würzburgers and Wundt debate, 109, 110
    - generalization and synthesis pathways
      - aggregate analysis, 112–115
      - goal, 112
      - single case analysis, 115–117
      - synthesis, 117, 118
  - microgenetic case studies
    - Bartlett's repeated reproduction, 104–106
    - Vygotsky's double stimulation, 102–104
    - Werner's method, 100–102
    - pre-WWII era psychology, 99, 100
  - Cook-book recipe, 61, 62
  - Cooper, P.J., 599
  - Cortés, M., 231, 232
  - Costa, P.T., Jr., 75
  - Costall, A., 434, 569
  - Coulon, A., 420
  - Cowan, N., 607
  - Cronbach, L.J., 34, 36, 68, 69, 75, 94
- D**
- Dahl, A.A., 599
  - Danziger, K., 36, 113
  - Danziger's methodolatry, 113
  - Dauwalder, J.P., 621
  - Davydov, V.V., 569, 572, 577
  - Dayak, M., 546
  - de Saint-George, I., 422
  - DeCalo, S., 546
  - Delignières, D., 202
  - Delintnières, D., 197
  - Developmental science
    - biopsychosocial approach
      - gene-environment interaction, 598
      - perspective, 597, 598
      - reciprocal relationship, 599
    - developmental systems perspective (DSP)
      - aspects, 611
      - characteristics, microgenetic design, 610
      - intra-individual variability, 608
      - relationism, probabilism and temporality, 609, 610
      - Thelen and colleagues strategies, 611, 612
    - epigenesis and self-organization
      - connectionist and dynamic systems, 607
      - dynamic cognitive theory, 606, 607
      - linear and nonlinear systems, 606
    - ontologic development
      - bidirectional nature diagram, 603
      - cytoplasm, 601
      - gene-environment-interactions model, 604, 605
      - genetic activity, 600

- hierarchical model, 599, 600
  - hormones, 601
  - innate vs. instinctive behavior, 600
  - probabilistic epigenesis, 601, 602
  - risk factors, obesity, 603
  - serotonin transporter gene (5-HTT), 602
    - serotonin transporter gene promoter polymorphism (5-HTTLPR), 602
  - scope and aim, 596, 597
  - Developmental systems perspective (DSP), 595–597, 607, 608
  - Developmental systems theories (DST), 596
  - Dewey, J., 567
  - Diekmann, A., 156
  - Differential psychology, person-centered inquiry
    - attributes and individuals, basic concepts, 34, 35
    - individual differences, 33
    - Stern's "nature and tasks", 32
  - Ding, Z., 200
  - Diriwächter, R., 320, 327, 348
  - Discursive flow analysis (DFA), 179, 182–184
  - Distancing/approximation, psychotherapy processes
    - conceptualization, 468
    - differentiation, 471
    - flexibility, 470
    - internalization and integration, 470
    - mutuality, 469
    - relationship, ego and alter, 468
  - Dolan, C.V., 75, 208, 213, 261, 262
  - Dramatic life courses, migrants
    - idiographic and classifying science, 478
    - life trajectories, 480–482
    - random sample, 478–480
    - TEM, migration transition
      - bifurcation points (BFP), 482, 483
      - equifinality point (EFP), 482–484
      - equifinality zone (EFZ), 483, 484
      - Lysette and Endrit, 487–489
      - obligatory passage points (OPP), 482
      - rupturing experiences, 483
      - symbolic resources, 484
  - DSA. *See* Dynamic systems approaches
  - DSP. *See* Developmental systems perspective
  - Du Toit, S.H.C., 213
  - Duncker, K., 331
  - Durbin, J., 191
  - Durland, J.M., 211
  - Dutilh, G., 281
  - Dynamic factor analysis, psychological processes
    - classical ergodic theorems, 256–258
    - definition, 259
    - lagged factor loading convolution, 259
    - multivariate Gaussian series, 258, 261
    - nonstationary analysis
      - covariance function, 264
      - ( $q + r$ )-dimensional innovations process, 265
      - EKFIS estimate, autoregressive model, 265, 266
    - replicated time series design application, 261–264
    - state-space model, 260, 264
  - Dynamic methodologies. *See* Synthetic phenomena and dynamic methodologies
  - Dynamic systems approaches (DSA), 436, 438, 439, 442, 443, 450, 451
    - information*, 439, 440
    - relational conditions*, 439
  - Dynamic systems, psychodynamic theories
    - definition, 1, 2
    - periodicity, 6
    - theoretical concept, 2
    - transition function, 4
    - typology, 5, 6
- ## E
- Ebbinghaus, H., 115, 123
  - Education research methods
    - analytical-quantitative approaches, 366
    - assumptions and implications
      - learning, 354
      - normative ideas, 355
    - dynamic systems theory
      - bio-physiological, psychic and communicative processes, 368, 369
      - concepts and methods, 366, 367
    - methodology cycle, 353, 354
    - narratives description
      - developmental process, 376
      - interpretive-hermeneutic approach, 376
      - self-accounts, 375, 376
    - open developmental process
      - aggregation over time, 357, 358
      - data aggregation, 356, 357
      - temporal resolutions, 358, 359
    - orchestral scores
      - manifest structures, 370
      - scripts, 371, 372

- systemic-constructivist approach, 369, 370
  - theoretical reflection, 370, 371
  - Unterrichtspartitur*, 370
- process-oriented
  - analytical-quantitative type, 363
  - approaches, 365
  - reconstructive-hermeneutic method, 363, 364
  - scientific methods, 364, 365
- social context
  - cross-situational consistency issue, 360, 361
  - ecological perspective, 359, 360
  - social construction, 361, 362
- verbal and non-verbal behavior
  - academic task structure (ATS), 374
  - behavioral concept, 373
  - characteristics, 373, 374
  - interpretation steps, 375
  - quantitative-experimental method, 373
  - social participation structure (SPS), 374
  - teaching-learning process, 374, 375
- Edwards, D., 109
- Edwards, L., 604
- Efficient causality epistemology
  - future methodology, 59, 60
  - structuralist dynamic methodology
    - characteristics
      - aims, 60
      - cook-book recipe, principles, 61, 62
      - mental phenomena, 60
  - toolbox research, modern mainstream
    - psychology
      - efficient causality framework, 57
      - simple linear cause-effect, 58
- Ehrenstein, W.H., 325
- Einführung* process, 343, 344
- Elbert, T., 91
- Eliason, S., 220
- Ellis, J.L., 76
- Elo-rating, 90, 91
- Emotional *will*-theory, 321
- Engle, R.F., 209
- Epigenesis
  - embryonic stem cell research, 436, 437
  - epigenome, 437, 438
  - experimental embryology, 436
- Epston, D., 496
- Equifinality point (EFP), 482–484
- Equifinality zone, 483, 484
- Ergodic theorems, classical
  - conditions, 257
  - consequences, 257, 258
  - heuristic description, 257
  - psychological data analysis and measurement, 256
  - P-technique, 257
  - R-technique, 257
- Erickson, F., 374
- Erickson, E.H., 414
- Erickson's developmental stage theory, 219
- Ernst, T., 262
- Eroticism, 528, 529
  
- F**
- Fan, J., 191, 209
- Farrell, S., 202
- Fassnacht, G., 354
- Fehr, T., 91
- Feldman, G., 13
- Ferrer, E., 208, 262
- Filliettaz, L., 422
- Fischer, K.W., 609, 611
- Fish, R., 497
- Flury, B., 301
- Fodor, J., 92
- Fogel, A., 444–446, 448
- Forni, M., 262
- Fortes, M., 197, 202
- Frank, G., 553
- Frank, L.K., 224
- Freud, S., 83
- Freud's psychosexual stage theory, 218
  
- G**
- Gabbard, G., 3
- Gaffan, E.A., 599
- Ganzheitspsychologie* threshold
  - analytic thought, 328
  - holistic approach, 326
  - synthetic thought, 328
  - Völkerpsychologie*, 327
- Gardner, H., 78
- Garfinkel, H., 146
- Garvey, A., 444, 446
- Generalization and synthesis pathways,
  - constructive microgenesis
    - aggregate analysis
      - Danziger's methodolatriy, 113
      - definition, 112
      - experimental psychology, 113
      - limitations, 114, 115
      - unmediated and mediated memory, 113, 114
    - goal, 112

single case analysis, 115–117  
 synthesis, 117, 118  
 Gennaro, A., 25, 183  
 Gergen, K.J., 123, 135  
 Gerstorff, D., 262  
 Gestalt law of *Prägnanz*, 332  
 Gestalt qualities. *See also* Synthetic phenomena and dynamic methodologies  
   co-constituents, 582  
   heterogeneities and contradictions, 583  
   reification, 590–592  
   theory, 585  
 Gestalt Switch, 128–132  
 Gibson, J.J., 137, 139  
 Gillespie, A., 423, 424, 490  
 Glaser, B., 164  
 Gödel, K., 94  
 Goffman, E., 144, 375, 445  
 Gonçalves, M.M., 509  
 Good, J.M.M., 587  
 Gottlieb, G., 436, 598, 600, 601, 603  
 Gottman, J.M., 212  
 Granger, C.W.J., 193–195, 200, 209  
 Granic, I., 608, 611  
 Grasman, R.P.P.P., 281  
 Grass, G., 418  
 Grassi, R., 18, 185  
 Gubrium, J.F., 328  
 Gunji, Y.-P., 128

## H

Habermas, J., 154, 155  
 Hägnebo, C., 197  
 Haken, H., 368, 621, 636  
 Haker, H., 202  
 Hallin, M., 262  
 Hamaker, E.J., 261, 262  
 Hamaker, E.L., 75–77, 93, 201, 208, 212  
 Hamilton, J.D., 191, 193, 211  
 Hardy, S.A., 262  
 Harré, R., 84  
 Harvey, A.C., 191  
 Hasse, C., 418  
 Hay, R.A., 200  
 Hayes, A.M., 13  
 Hegel, G.W.F., 572, 573  
 Hermans, H.J.M., 222  
 Heterogeneity, 478–480  
 Hidden Markov models (HMM)  
   elements, 273  
   likelihood model, 274, 275  
   parameter estimation and inference, 275–277  
   parameters, 274

Perth water dam application  
   goodness-of-fit measures, 279  
   models, 278, 279  
   water inflow data, 277, 278  
 relationships with other models, 272  
 speed-accuracy trade-off (SAT)  
   baseline category logit model, 280  
   hypothesis testing, 282  
   measurement model, 285  
   reaction time data, 281, 282  
   state models, 283, 284  
   transition matrix values, 283  
   transition model, 285  
   transition probability hysteresis, 286  
 2-state model, 274  
 state space and measurement model, 270, 271  
   transition dynamics, 271, 272  
 Hitzler, R., 150  
 Hofstee, W., 40, 41  
 Hollenstein, T., 608  
 Holstein, J.A., 328  
 Holzkamp, K., 587  
 Hooker, K., 262  
 Hooligans, 529–531  
 Hughes, J.P., 275, 276, 287  
 Huizenga, H.M., 75, 76  
 Hume, D., 51, 54  
 Hume's static thinking, 54  
 Hviid, P., 419

## I

Ichii, K., 202  
 Idiographic data analysis  
   ARIMA models  
     applications, social sciences, 196, 197  
     autoregressive (AR) model, 192, 193  
     full ARIMA model, 195, 196  
     mixed autoregressive moving average (ARMA) model, 194, 195  
     moving average (MA) model, 193, 194  
     univariate extensions, 197–201  
   autoregressive moving average (ARMA) model  
     bilinear (BL) mode, 209  
     cointegrated model, 205–207  
     conditional heteroscedastic autoregressive (ARCH) models, 209, 210  
     latent VARMA model, 205  
     Markov switching autoregressive (MSAR) model, 211, 212  
     multivariate extension, applications, 207, 208  
     nonlinear extension, applications, 212

- threshold autoregressive (TAR) models, 210, 211
  - time series analysis, 191
  - with trends, 198
  - VARMAX model, 204, 205
  - vector ARMA model, 203, 204
- time series analysis, 191
- Idiographic microgenesis, *Aktualgenese*
  - causality issue
    - cause-effect relationships, 321, 322
    - experimental philosophy*, 323
    - principle of actuality*, 322
  - Gefühlston* and *Gesamteindruck*
    - causality issue, 347, 348
    - cognitive qualities, 345
    - feeling tone (pos/neg), 346
    - mean ratings, 346
  - “here-and-now” development
    - Einfühlung* process, 343, 344
    - future-orientation of the present, 344
    - generic synthesis model, 343, 345
    - zone of actual development (ZAD), 344
  - origin, 320, 321
  - revival, narrative approach
    - Gestalt tendencies, 337
    - landscape images, trial 1, 338
    - synthetic progression demonstration, 341, 342
    - trial 2, 339–341
  - Werner’s methodologies
    - developmental laws, 336
    - publications, 335
    - whistling sound production, 336
  - Wundt’s methodology
    - apperception, *will* process, 325, 326
    - criteria to be met, 324
    - experimental introspection, 323
    - Ganzheitspsychologie* threshold, 326–328
    - psychological experiment, 323, 324
  - Würzburg School methodologies
    - “*Aha-experience*”, 331
    - consciousness of a rule*, 330, 331
    - consciousness of relations*, 331
    - Külpe-group, 329, 330
    - research participant study, 330
    - “think aloud” approach, 331
- Idiographic science, 478
- Individual–environment reciprocity
  - adapt and transcend environmental immediateness, 588, 589
  - reification
    - human intensions, 589, 590
    - quasi-environmental properties, 590–592
- Infancy research methodology
  - cognitive science, 432, 433
  - epigenetic view and dynamic systems approaches
    - control parameters*, 443, 444
    - DSA explanation, 443
    - mathematical* and *metaphorical*, 442
    - “the A-not-B error”, 442, 443
  - frame concept, 445
  - infant–environment mutuality
    - central systems, 435
    - closed system model, 433, 434
    - layered total system, 435
    - open system model, 434, 435
    - organism–environment relationship, 436
    - peripheral systems, 435
  - infant–environment relationship, 432
  - open system
    - and autopoiesis, 440, 441
    - dynamic systems approaches, 438–440
    - epigenesis, 436–438
    - relational–historical approach
      - and infant emotions, 445–448
      - and infant intentionality, 448, 449
- Innovative moments coding system (IMCS), 497
- Innovative moments (i-moments),
  - psychotherapy
    - action (A), 498, 499
  - macro organizers
    - abstractic level, 495
    - problematic meanings, 503
  - meaning complexes
    - circumvention strategies, 505
    - qualifiers, 503
  - meaning transformation, 504
  - mutual in-feeding
    - meaning maintenance, 508
    - social validation, 511–513
    - takeover process, 510, 511
    - therapeutic process, 509
  - narrative therapy
    - dialectical approach, 502
    - macro organizers, 495
    - microgenetic level, 503
    - regulation, 495
    - salience, 501
    - signs, 495
    - therapeutic change model, 502
    - unique outcomes, 496, 497

- new self-narrative, development
    - circumvention strategies of meaning, 516–518
    - constructive elaboration, 514, 515
    - content, 515, 516
  - performing change (PC), 499, 500
  - protest (P), 498, 499
  - re-conceptualization (RC)
    - synthesis process, emergence, 518–522
    - types, 499, 500
  - reflection (R), 498, 499
  - therapeutic failure and dynamic stability, 506–510
  - Integrated autoregressive moving average (ARMA) models. *See* ARIMA models
  - Intensive categorical longitudinal data
    - definition, 241
    - run test
      - categorical data analysis, algorithmic elements, 243–245
      - definition, 242
      - log-linear modeling and first order CFA, 246–249
      - log-linear modeling and 2-group CFA, 249–251
      - pre-specified range scores, 243
      - up-and-down score patterns, 243
  - Inter- and intra-psychological processes, 413
  - Inter-individual difference, MLSCA
    - emotional structure, 303
    - sources, 298
  - Inter-individual variation analysis
    - pooling across subjects, 255
    - P-technique definition, 257
    - R-technique definition, 257
    - structure analysis, 256
  - Interpersonal relationships
    - characteristics, 387
    - developmental expression, 387, 388
    - methodological procedure, 387
  - Intersubjectivity, dynamic systems
    - assumption, process invariance, 174, 175
    - data analysis, 172, 173
    - dynamic system paradigm (DS), 188, 189
    - emergence
      - criteria, 186
      - self-organization, 186, 187
      - super order meanings and activity, correlations, 187
    - epistemological statements, 172
    - modelling
      - discursive flow analysis, 179
      - meta-trend, 178, 179
      - temporal trajectory, DS analysis, 178
  - non-independent data analysis
    - bootstrapping methodology, 176
    - conventional parametric and nonparametric statistics, 177
    - severity, symptomatology, 176, 177
    - simulation model analysis (SMA), 177, 178
  - post-pre difference, 173, 174
  - psychological methodology, 171
  - structural approach
    - lexical variables, 184
    - textual analysis, examples, 184–186
  - time dependence
    - relative vs. absolute states, 183, 184
    - sensemaking, 182, 183
  - trajectory, phase space
    - growth mixture model, 181, 182
    - super-order knots (SK), quadratic curve, 180, 181
    - two stage semiotic model (TSSM), 180
  - variables, 175, 176
  - Intimate partner violence (IPV)
    - definition, 245
    - pregnant women, 249
    - violence status, 246
  - Intra-individual variability, MLSCA
    - dominant emotional pattern difference, 308
    - mood structure, 298
    - multivariate data analysis, 294
    - sources, 296, 297
  - Irremediable vagueness, communication, 146, 147
  - Item response theory (IRT), 611
- J**
- James, W., 328, 329
  - Jelic, H., 609
  - Jenkins, G.M., 198
  - Jensen, A., 79, 80
  - Johnston, T.D., 604
  - Josephs, I., 503, 508
- K**
- Kagiticbasi, C., 386
  - Kanazawa, S., 75, 80
  - Kaplan, D., 277
  - Kaufman, C., 229
  - Kaufman, J., 602
  - Kaura, I., 391
  - Kevin's behaviour, 626
  - Kim, C.-J., 211, 262
  - Kirkpatrick, E.A., 50
  - Kissinger, S., 326
  - Kleine-Horst, L., 334
  - Koffka, K., 50

- Kohlberg's six-stage model, 219  
 Köhler, W., 50, 367  
 Koopman, S.J., 191  
 Kowalik, Z., 16  
 Krappmann, L., 374, 376  
 Krause, M., 497  
 Krueger, R.F., 75, 327, 335, 347  
 Krummheuer, G., 374  
 Külpe, O., 50  
 Külpe-group, 329, 330  
 Kusch, M., 107
- L**
- Ladd, G.T., 50  
 Lamiell, J.T., 70, 72  
 Land, K.C., 200  
 Langness, R., 553  
 Lauber, C., 202  
 Laurenceau, J.P., 13  
 Lauro-Grotto, R.P., 9, 186  
 Lavalli, M., 610  
 Lebo, A.M., 262, 263  
 Leckman, J.F., 197  
 Lerner, R.M., 220, 609  
 Leudar, I., 434  
 Levinas, E., 385  
 Lewin (1936), 585  
 Lewin, K., 114, 224, 636  
 Lexical multiple correspondence analyses (LMCAs), 25, 26  
 Lichtenberg, U., 374  
 Lickliter, R., 612  
 Life course and aging, Tuareg  
   anthropological studies, emotions  
     individual expression, 548  
     Muslim communities, 549  
 ethnographic interlude  
   family marriage, 547  
   Kel Tamajaq, 545, 546  
   matrilineal institutions, 546  
   nomadic system, 547  
 late-life marriage cases  
   *akusi*, 555, 556  
   personal love sentiments, 554  
   wedding of calm, 555  
 love sentiments  
   marriage, 551  
   sexuality, 550  
   unrequited love, 550  
 marabouts, 546, 559  
 organization and argument  
   Islamic God, 545  
   Kel Essuf, 544  
   love strategies and spirit beliefs, 543  
   romantic love  
     intra-individual, 543  
     sexuality, 551  
 social-cultural analysis, time factor  
   inter-individual variation, 553  
   longitudinal case studies, 554  
   soul concepts, 553  
 spiritual psychobiographies, late-life  
   relationships  
     Kel Essuf, 557, 560  
     marabouts, 558  
     matrilineal spirits, 562  
 Life-course transitions  
   approach development, transition  
     meta-theoretical frame, 408  
     open system, 409  
   development study, 406, 407  
   inter- and intra-psychological processes, 413  
   locating ruptures, 412, 413  
   mediated reconstruction, 419  
   methodological difficulties, 407, 408  
   methods  
     institutional case studies, 424  
     situated case studies, 424, 425  
   notion of transition, 410  
   perceived ruptures, 412  
   process, 413, 414  
   real-time transitions  
     approaches, 421, 422  
     data production, 420, 421  
     micro-process, 422, 423  
   reconstructive autobiography  
     demultiplication, 418  
     narration, 417, 418  
     semiotic resources, 419  
   reconstructive interview, 415–417  
   rupture-transitions, 414, 415  
   static to dynamic understandings, 411, 412  
 Lim, K.S., 210  
 Lin, Z., 208  
 Lippi, F., 262  
 Little, T.D., 611  
 LMCAs. *See* Lexical multiple correspondence analyses  
 Locating ruptures, 412, 413  
 Log-linear modelling  
   first order CFA, 246–249  
   2-group CFA, 249–251  
 Loos, P., 151  
 Lüders, M., 374  
 Luhmann, N., 149, 151  
 Luria, A.R., 50, 108, 111, 115, 116, 390  
 Lykken, D.T., 67, 68, 75

- Lykken's hypothesis, 67  
 Lyra, M.C.D.P., 521  
 Lystig, T.C., 275, 276
- M**
- Maciel, D., 374  
 MacKenzie, M.J., 612  
 Macmillan, R., 220  
 Mahmoud, H.W., 416  
 Malti, T., 202  
 Mannheim, K., 141, 162, 165  
 Marabouts, 546, 559  
 Marková, I., 463, 466  
 Markovian procedure, intersubjectivity, 182, 183. *See also* Discursive flow analysis (DFA); Intersubjectivity, dynamic systems  
 Markov switching autoregressive (MSAR) model, 211, 212  
 Marriott, M., 387  
 Martins, C., 599  
 Maslow, A.H., 219  
 McAdams, D.P., 223  
 McArdle, J.J., 262  
 McCleary, R., 200  
 McCrae, R.R., 75  
 McCurdy, T.H., 211  
 McDowall, D., 200  
 McNeil, L., 578  
 McNemar, Q., 227  
 McQuellon, R.P., 220  
 Meidinger, E.E., 200  
 Meinefeld, W., 147  
 Merleau-Ponty, M., 548  
 Methods, life-course transitions  
   institutional case studies, 424  
   situated case studies, 424, 425  
 Metzger, W., 367  
 Meyer, L.B., 346  
 Meyers, J.M., 262  
 Microgenetic case studies  
   Bartlett's repeated reproduction  
     analytic strategy, 106  
     remembering studies, methods, 104, 105  
   definition, 100  
   Vygotsky's double stimulation  
     experimentally isolated components, 103, 104  
     external mediator, 102  
     *means and process*, 104  
     memory studies, 102, 103  
   Werner's method  
     *Aktualgenese* method, modified, 102  
     aphasics, 102  
     innovation, 101  
     microgenesis, 100  
     spherical cognition, 101  
 Middleton, D., 109, 137, 138  
 Miele, F., 79  
 Migration transition, TEM  
   bifurcation points (BFP), 482, 483  
   equifinality point (EFP), 482–484  
   equifinality zone (EFZ), 483, 484  
   Lysette and Endrit, 487–489  
   obligatory passage points (OPP), 482  
   rupturing experiences, 483  
   symbolic resources, 484  
 Mischel, W., 222, 223, 360  
 Mitchell, C., 229  
 Mitscherlich, A., 355  
 MLSCA. *See* Multilevel simultaneous component analysis  
 Modern mainstream psychology  
   assumptions, 46  
   basic questions  
     cross-country psychology, 48  
     static theoretical constructs, 47  
   failures, 46, 47  
   methodological perspective, 46  
   toolbox research, 57, 58  
 Molenaar, P.C.M., 75, 76, 113, 187, 205, 208, 258–262, 264, 294, 606, 608  
 Moore, G.H., 242  
 Mori, N., 127, 132, 234  
 Morley, S., 201  
 Morris, M.J., 193–195  
 Mossi, P.G., 18  
 Mozart, W.A., 371  
 Multi-group/multilevel structural equation model (SEM), 299–301  
 Multilevel simultaneous component analysis (MLSCA)  
   adolescent girls–mothers emotions after conflict  
     between-component scores, 304  
     conflict episodes, course of emotions, 307  
     dominant emotional pattern, intra-individual variability, 308  
     inter-individual differences, intra-individual structure, 305–307  
     personality development theories, 303  
     variance accounted for (VAF), 304  
     Varimax rotation, 302  
     within-component scores, 305, 306  
   eating disorder research  
     advantages, 309, 310  
     affect regulation, 309



- between-part solution, 310–312
    - drive for thinness hypothesis, 309
    - excessive physical activity, 309
    - inter-individual differences, intra-individual variances, 313–315
    - Promax rotation, 311
    - within-part solution, 312–314
  - model selection, stability and inference, 298, 299
  - multivariate data analysis, multiple subjects
    - approaches, 294, 295
    - data matrix, 295, 296
    - different sources, 298
    - fitting procedure, 296
    - inter-individual variability sources, 298
    - intra-individual variability sources, 296, 297
  - principal component analysis
    - data matrix Y, 292, 293
    - data reduction technique, 292
    - solution interpretation, 293
    - Varimax rotation, 293
  - related models, 301
  - vs. multi-group/multilevel SEM, 299–301
- Multivariate Gaussian series, 258, 261
- Mumma, G.H., 262
- Muran, J.C., 11
- Murphy, R., 546
- Murray, J.D., 212
- Murray, L., 599
- Mutual in-feeding processes
  - meaning maintenance, 508
  - social validation, 511–513
  - takeover process, 510, 511
  - therapeutic process, 509
- N**
- Narrative therapy, innovative moments
  - dialectical approach, 502
  - macro organizers, 495
  - microgenetic level, 503
  - regulation, 495
  - salience, 501
  - signs, 495
  - therapeutic change model, 502
  - unique outcomes, 496, 497
- Naujok, N., 374
- Navigation experiment
  - dominant ‘alteration’/dominant ‘succession,’ 133
  - double blind method, 132
- Neo-Galtonian model, psychological research
  - closer examination
  - empirical knowledge, 40
  - probabilistic claims, 41
  - subjectivism, 40
- Cronbach’s central point, 36
- historical perspective
  - Buckle’s discussion, 38
  - Quetelet’s view, 37
  - variables effects (or variable combinations), 39
- Nesselroade, J.R., 75, 76, 208, 258, 261–264, 294, 297
- Nicolaisen, I., 546, 563
- Nicolaisen, J., 546, 563
- Ninot, G., 197, 202
- Noble Memorial Prize, Engle, R. and Granger, C., 205
- Nohl, (2001), 151
- Nohl, A.-M., 532
- Nomadism, 547
- Nørretranders, T., 640
- Notion of transition, 410
- O**
- Obeyesekere, G., 542
- Obligatory passage points (OPP), 229, 482
- Odbert, H.S., 291
- Ohashi, Y., 127, 132
- Ontologic development
  - bidirectional nature diagram, 603
  - cytoplasm, 601
  - gene-environment-interactions model, 604, 605
  - genetic activity, 600
  - hierarchical model, 599, 600
  - hormones, 601
  - innate vs. instinctive behavior, 600
  - probabilistic epigenesis, 601, 602
  - risk factors, obesity, 603
  - serotonin transporter gene (5-HTT), 602
  - serotonin transporter gene promoter polymorphism (5-HTTLPR), 602
- Open system
  - and autopoiesis
    - living organisms, 441
    - self-organization, 440, 441
  - dynamic systems approaches (DSA)
    - information, 439, 440
    - relational conditions, 439
  - epigenesis
    - embryonic stem cell research, 436, 437
    - epigenome, 437, 438
    - experimental embryology, 436
- Opinion rating, 395, 396
- Orchestral scores
  - manifest structures, 370

- scripts, 371, 372
- systemic-constructivist approach, 369, 370
- theoretical reflection, 370, 371
- Unterrichtspartitur*, 370
- Oswald, H., 374
- P**
- Pals, J.L., 223
- Park, Y., 280
- Passkönig, O., 321
- Peirce, C.S., 226
- Perceived ruptures, 412
- Perception-action studies, Gestalt approach, 585. *See also* Gestalt qualities
- Performing change (PC) i-moment, 499, 500
- Perret-Clermont, A.-N., 424
- Perret, J.-F., 424
- Personality development theories, 303
- Person-centered inquiry
  - differential psychology
    - attributes and individuals, basic concepts, 34, 35
    - individual differences, 33
    - Stern's "nature and tasks", 32
  - perseveration, 42
  - statistical thinking, co-optation
    - Buckle's discussion, 38
    - neo-Galtonian model, 35, 36
    - Quetelet's view, 37
    - variables effects (or variable combinations), 39
- Perth water dams
  - goodness-of-fit measures, 279
  - models, 278, 279
  - water inflow data, 277, 278
- Peterson, B.S., 197
- Petrie, T., 276
- Phase transition model (PhTM), 280
- Philips, D.P., 207, 208
- Piaget, J., 431, 443, 628
- Pieters, G., 309
- Polarized equifinality point (PEFP), 228, 233, 236. *See also* Trajectory equifinality model (TEM)
- Popper, K., 161
- Potì, S., 21
- Praxeological methodology
  - acquisition and development, 165, 166
  - common sense, constructions
  - orientations and embeddings, 143
  - reconstruction, 145
  - scientific interpretation, 144
  - second degree constructions, 144
  - subjective constructions, 144, 145
- formulating common standards, 153, 154
- formulation, theoretical basis, 142
- generalization process
  - basic typification, 164, 165
  - conceptual representativeness, 163
  - milieu types, 164
  - significance, 162
- meta-theoretical foundation
  - aspect structure, 162
  - biographical theory, 161, 162
  - critical rationalism, 161
  - research processes, 160
- methodical controlled understanding
  - approach
    - explanation, 148
    - interaction, example, 145
    - irremediable vagueness, 147
    - meta-communication, conversation study, 145–147
    - opposite empirical access, 147, 148
    - standardized investigation procedure, 147
  - objectivity, perennial problem, 158, 159
  - objects theories, empirical research, 141, 142
  - ontological validity, 151, 152
  - qualitative and quantitative research negotiation, 142
  - reconstructive research, 143
  - subjective theories vs. process structures
    - conversation analysis, 150, 151
    - corresponding social habitus, 151
    - process-oriented analytical attitude, 150
    - qualitative research, 149, 150
    - second degree constructions, 149
    - second order observations, 151
    - standardized methods, 149
  - understanding reliability
    - arbitrary thematic structure, 157
    - homologies, 157, 158
    - principles, reconstructive methods, 156, 157
  - validity, empirical method
    - ethno-methodology, 154
    - milieu and culture, 155
    - quantitative procedures, 153
    - tacit knowledge, 155, 156
- Pre-WWII Continental-European psychology
  - Hume's cause-effect thinking, 51
  - modern medicine, 52
  - structuralism, 50
- Prigogine, I., 438, 440
- Principal component analysis

- data matrix Y, 292, 293
  - data reduction technique, 292
  - solution interpretation, 293
  - Varimax rotation, 293
  - Probst, M., 309
  - Promax rotation, 311
  - Protest (P) i-moment, 498, 499
  - Przyborski, A., 150, 151, 157, 163, 528
  - Psychodynamic theories
    - chaotic process, psychotherapy
      - dissipative trajectory, 19
      - empirical depiction, communication, 21–23
      - empirical traces, 18, 19
      - phase transition, 17
      - sensemaking, 19–21
      - sensitive dependence, 17, 18
      - stationary (ergodic) non linear system, 16
      - strange attractor, 19–21
    - deterministic chaos, 7, 8
    - dynamic systems
      - definition, 1, 2
      - periodicity, 6
      - theoretical concept, 2
      - transition function, 4
      - typology, 5, 6
    - psychoanalytic perspectives, 3, 4
    - psychological phenomena
      - chaotic order, 15
      - non-linearity, 13–15
      - periodicity, 10
      - psychotherapy, 11–13
    - self-organization
      - Hopfield model, 8, 9
      - synergetic theory, 9
  - Psychological phenomena
    - chaotic order, 15
    - non-linearity
      - dramatic and traumatic events, 13
      - two stage semiotic model (TSSM), 14, 15
    - periodicity, 10
    - psychotherapy
      - referential activity, 11
      - therapeutic cycle method of Mergenthaler (TCM), 12, 13
  - Psychotherapy processes
    - ambivalence
      - and ambiguity, 459
      - childish behavior, 458
      - marital relationship, 459
      - meaning complexity, 458
      - notion, 457
      - self position, 461, 462
      - subjective experience, 460
      - uncertainty, 460
    - distancing/approximation
      - conceptualization, 468
      - differentiation, 471
      - flexibility, 470
      - internalization and integration, 470
      - mutuality, 469
      - relationship, ego and alter, 468
    - temporality
      - intolerant position, 473
      - past experience, 472
      - quasi-stability notions, 472
      - sense of identity and continuity, 471
      - temporal elaboration of experience, 472
      - uncertainty, 473
    - tension
      - aspects, 462, 463
      - congruence, 464, 465
      - directionality, 463, 465
      - here-and-now moment, 463
      - imbalance, 468
      - inner talk, 467
      - interaction, 463, 465
      - interlocutor's role, 466, 467
      - intersubjectivity, 467, 468
      - opposing positions, 464, 465
      - self-construction system, 466
  - P-technique, 257, 258, 261, 262
- Q**
- Quarta, R., 18
  - Quasi-environmental properties, 590–592
- R**
- Raijmakers, M.E.J., 213, 271
  - Ram, N., 262, 263
  - Random walk model (RWM), 280, 281
  - Ratcliff, R., 202
  - Ratner, C., 386
  - Real-time transitions
    - approaches, 421, 422
    - data production, 420, 421
    - micro-process, 422, 423
  - Re-conceptualization (RC) i-moment
    - synthesis process, emergence
      - action i-moment, 519
      - meaning complex, 520
      - performing change i-moment, 522
      - protest i-moment, 519
      - reflection i-moment, 519
    - types, 499, 500

- Reconstructive autobiography, life-course transitions  
 demultiplication, 418  
 narration, 417, 418  
 semiotic resources, 419
- Reflection (R) i-moment, 498, 499
- Reichlin, L., 262
- Reich, S., 9
- Reification, dynamic methodologies  
 human intensions, 589, 590  
 individualistic and hedonistic perspective  
 Gestalt qualities, 591, 592  
 quasi-artifactual environmental property, 591  
 reciprocity, 590, 591
- Relational-historical approach  
 and infant emotions  
 emotions, 445, 446  
 face-to-face communication, 446  
*interest in toys frame*, 447, 448  
*social-object playful frames*, 446, 447  
*social playful frames*, 446  
 and infant intentionality  
 development stages, 448  
*shared experiences*, 449
- Remembering and memory, 123. *See also*  
 Schema approach, remembering and memory
- Research task, social dynamics  
 culture of origin/culture of application distance, 390  
 examples, 388  
 impede ongoing interactions, 390  
 individual interview/questionnaire, 391, 392  
 infant developmental assessment, 392  
 interview responses, 391  
 mirror self recognition study, 392  
 puzzlement, 390  
 self-conscious distance, 389
- Rhymer, R.D., 205
- Richters, J.E., 611
- Rieber, R.W., 321
- Riehle, H.J., 91
- Rijmen, F., 309
- Robinson, D.K., 321
- Rose, S.P., 609
- Rössler, W., 202
- Rotter, J.B., 319
- Rovine, M.J., 213
- R-technique, 257
- Ruggeri, R., 18
- Run test  
 categorical data analysis, algorithmic elements, 243–245  
 definition, 242  
 information used, 242, 243  
 log-linear modeling and first order CFA, 246–249  
 log-linear modeling and 2-group CFA, 249–251
- Rupture-transitions, 414, 415
- Russell, B., 94
- RWM. *See* Random walk model
- S**
- Sacks, H., 146, 150
- Safran, J.D., 11
- Salvatore, S., 18, 21, 24, 184
- Sameroff, A.J., 598, 599, 612
- Sander, F., 334, 338, 610
- Sandra Bem's (1979), 319
- Sasaki, M., 137
- Sato, T., 226, 231, 356, 393, 478
- Sbarra, D.A., 262
- Schank, R.C., 371
- Schema approach, remembering and memory  
 actualization, Bergsonian terms, 137  
 Bartlett's theory, 134, 135  
 communicative remembering, 138  
 discursive psychology, 135  
 features, 123, 124  
 findings  
 Amagasaki case, 128–132  
 Ashikaga case, 125–127  
 Kabutoyama case, 127, 128  
 interrogation  
 Amagasaki case, 129, 130  
 navigation experiment, 132, 133  
 self-identity, 136  
 social constructionists, 134, 135  
 temporal nature, remembering, 136  
 textual essentialism, 135
- Schema theory, 628, 635, 636
- Schiepek, G., 23, 186, 368, 621
- Schmittmann, V.D., 213, 271
- Schmitz, B., 207
- Schrenk, J., 376
- Schütz, A., 144, 147
- Schütze, F., 147, 148
- Scientific psychology disciplines  
 chess expertise case studies  
 autonomy and irreducibility, 92  
 cognitive ability, 91  
 Elo-rating, 90, 91  
 magneto-encephalogram recordings (MEG), 91  
 complex systems theory, 94

- conceptual view
  - general intelligence hypothesis, 86
  - inter-individual differences intractable properties, 87–89
  - psychological dynamics, 84, 85
  - racing ability, 86, 87
  - supervenience, 89, 90
- correlational research vs. experimental research, 72, 73
- inter-inter-individual differences and intra-individual dynamics, 68
- Lykken's hypothesis, 67
- mind-body debate, 93
- non-Euclidean geometry, 93
- psychology disunity, working hypothesis, 92
- psychometric view
  - between-subject variability model, 76
  - ergodicity, 77, 78
  - 1-factor model, 76
  - homology and inferences, 75
  - local homogeneity, 77
  - measurement models, 74
  - time series structure convergence, 77
- ruling paradigms
  - correlational research, 71, 72
  - experimental research, 69–71
  - hypothetical relation, 73
  - temporal dynamics role, 73, 74
- substantive view, inter-individual differences
  - intelligence case, 79–81
  - personality case, 81–84
- Scribner, S., 399
- Seale, C., 153
- Second person approach, 399, 400
- Seidel, T., 372
- Self-organizational dynamics, evidence
  - lexical multiple correspondence analyses (LMCAs), 25, 26
  - synergetic perspective, 24
- Semerari, A., 185
- Serial reproduction procedure. *See* Bartlett-scenario
- Shapiro, D.A., 14, 180
- Shaver, P.R., 3
- Shiboski, S., 287
- Shifren, K., 262
- Shoda, Y., 360
- Silverman (2004), 153
- Simulation model analysis (SMA), 177, 178
- Sivo, S.A., 213
- Skinner, E., 207
- Slunecko, T., 161
- Smith, L., 606
- Social and behavioral sciences
  - linear nondynamic cause-effect thinking, 48–50
  - modern mainstream psychology, 48, 49
  - pre-WWII Continental-European psychology
    - Aristotle concepts, 50
    - Hume's cause-effect thinking, 51
    - modern medicine, 52
    - structuralism, 50
  - structuralist-systemic explanation
    - dynamic structural concepts, 53, 54
    - and pure process theory, 53
    - static, 52
    - structure constrains processes, 53
- Social dynamics, complex family contexts
  - cultural psychology functions, 384, 385
  - experiments, ethnography and observation, 398, 399
- instruction, modifications of
  - compliance task data, 396, 397
  - encouragement types, compliance task, 397, 398
- interpersonal relationships
  - characteristics, 387
  - developmental expression, 387, 388
  - methodological procedure, 387
- rating one's opinion, 395, 396
- research task
  - culture of origin/culture of application distance, 390
  - examples, 388
  - impede ongoing interactions, 390
  - individual interview/questionnaire, 391, 392
  - infant developmental assessment, 392
  - interview responses, 391
  - mirror self recognition study, 392
  - puzzlement, 390
  - self-conscious distance, 389
- sampling procedures, 393, 394
- second person approach, 399, 400
- self-orientation patterns
  - individualism and puritanism, 385
  - psychological orientation, 386
- standard materials, 394, 395
- talk, play and teasing study, 393
- Social participation structure (SPS), 374
- Soeffner, H.-G., 155
- Speed-accuracy trade-off (SAT), HMM
  - baseline category logit model, 280
  - hypothesis testing, 282
  - measurement model, 285

- reaction time data, 281, 282
    - state models, 283, 284
    - transition matrix values, 283
    - transition model, 285
    - transition probability hysteresis, 286
  - Springer, W., 147
  - Stadler, M., 640
  - Statement generation schema, 127–129
  - Stengers, I., 438
  - Stern, W., 32, 33, 376
  - Stevens, S.S., 221
  - Stiles, W.B., 14, 180
  - Stock, J.H., 262
  - Strauss, A., 164
  - Strauss, J.L., 13
  - Strayer, J., 308
  - Stringfield, S., 358
  - Stroe-Kunold, E., 208
  - Strübing, J., 163
  - Substantive view, inter-individual differences
    - intelligence case
      - g-factor, 79
      - height, 80
      - Jensen's statement, 80
      - person-specific attribute, 81
    - personality case
      - contemporary personality science, 82
      - dispositional variables, 82
      - Freud's case studies, 83, 84
      - lexical tradition, 84
      - thought experiment, 83
      - variable and theorist, 81
  - Sully, J., 50
  - Supervenience relation, 89, 90
  - Swanson, C.C., 212
  - Swanson, K.R., 212
  - Synlogization*, 642
  - Synthetic phenomena and dynamic methodologies
    - ecological theory, limitations
      - adapting and transcending, 588
      - isomorphism and immediateness, 586, 587
      - reciprocity, 586
      - synthetic phenomena, 585
    - ecologizing developmental studies
      - dynamic methodologies, 570, 571
      - either-or discourse, 571, 572
      - elementarism, 569, 570
      - mechanical exchange, 568
    - gestalt qualities
      - co-constituents, 582
      - heterogeneities and contradictions, 583
    - individual—environment reciprocity
      - adapting and transcending, 588
      - human intensions, reification, 589, 590
      - Marxist philosophy, 588
      - reification, quasi-environmental properties, 590–592
  - situational ecology, Gibson, J.
    - affordance theory, 585
    - direct perception theory, 583
    - exploratory action, 584
  - theoretical concreteness
    - concretizing, 576–579
    - generalizations, 572, 573
    - heterogeneities and contradictions, 579–581
    - object presentation, 573
    - observational study, 574, 575
    - school knowledge and scholastic practices, 573
    - traditional methods, 567, 568
- T**
- Talk, play and teasing study, 393
  - TCM. *See* Therapeutic cycle method of Mergenthaler
  - Tebaldi, C., 21
  - TEM. *See* Trajectory equifinality model
  - Ten Berge, J.M.F., 294
  - Textual essentialism, 135
  - Thelen, E., 606
  - Theoretical concreteness. *See also* Synthetic phenomena and dynamic methodologies
    - concretizing
      - consensus, 578
      - double theoretical nature, 577, 578
      - ecological analytical unit, 577
      - institutional organization, 579
      - real and ideal construction, 577
      - standardization of courses, 578, 579
      - student's activities, 576, 577
    - dialectical perspective, empiricism
      - generalizations, 572, 573
      - heterogeneities and contradictions, 579–581
      - school knowledge and scholastic practices, 573
      - observational study, 574, 575
  - Therapeutic cycle method of Mergenthaler (TCM), 12, 13
  - Thom, R., 621
  - Thorndike, E.L., 33
  - Timmerman, M.E., 93, 299
  - Timotijevic, L., 479
  - Titchener, E.B., 107
  - Tong, H., 210
  - Toomela, A., 112, 175, 184

- Trajectory equifinality model (TEM)
- basic notions
    - equifinality and trajectories, 228
    - historically structured sampling (HSS), 227
    - irreversible time and bifurcation point, 229
    - multifinality and zone of finality (ZoF), 229, 230
    - open system transformation, 230
    - polarized equifinality point (PEFP), 228
    - social direction and social guidance, 230
  - dynamics, life development
    - life course studies and trajectory measurement, 219, 220
    - number assignment and scale types, 221, 222
    - personality psychology, debate, 222–224
    - stage theories, 218, 219
    - structural equation models (SEM), 220, 221
  - empirical studies, dynamic depiction
    - construction strategies, 231, 232
    - HSS and TEM, 233
    - KJ method and PEFP, 233
    - life event studies, 231
  - Endrit, 486, 487
  - Hojoki, Japanese literature, 217
  - Lysette, 485, 486
  - migration transition
    - bifurcation points (BFP), 482, 483
    - equifinality point (EFP), 482–484
    - equifinality zone (EFZ), 483, 484
    - Lysette and Endrit, 487–489
    - obligatory passage points (OPP), 482
    - rupturing experiences, 483
    - symbolic resources, 484
  - model construction, creating future equifinality, 226
  - multilinearity of trajectories, 227
  - personal decision making
    - dialogical processes, 235, 236
    - social guidance and social direction, 234, 235
    - synthesized personal orientation (SPO), 234
    - three layer model of genesis (TLMG), 236, 237
  - rating scale
    - point model, 225
    - trajectory model, 226
    - vector models, 224
- Trajectory, psychosocial recovery, 220
- Trevarthen, C., 448
- Tschacher, Scheier, and Grawe (1998), 24
- Tschacher, W., 23, 186, 621, 636
- TSSM. *See* Two stage semiotic model
- Tuareg, late-life love sentiments
  - anthropological studies, emotions
    - individual expression, 548
    - Muslim communities, 549
  - definitions, attitudes and practices, 549–552
  - marriage cases
    - akusi*, 555, 556
    - personal love sentiments, 554
    - wedding of calm, 555
  - method and argument
    - Islamic God, 545
    - Kel Essuf, 544
    - love strategies and spirit beliefs, 543
  - spirit-themed accounts
    - Kel Essuf, 557, 560
    - marabouts, 558
  - time factor, social-cultural analysis
    - inter-individual variation, 553
    - longitudinal case studies, 554
    - soul concepts, 553
- Two stage semiotic model (TSSM), 14, 15
- Typification, 533, 534
- Tyson, R., 212
- V**
- Valsiner, J., 100, 106, 114, 187, 229, 327, 335, 354, 374, 393, 423, 433, 457, 474, 489, 494, 502, 503
- Vanderlinden, J., 309
- van der Maas, H.L.J., 212, 213, 281
- van der Veer, R., 100, 106
- van Dijk, M., 608
- van Geert, P., 608
- Van Rijn, P., 77
- Vansteelandt, K., 309, 311
- Varimax rotation
  - emotion-after-conflict data, 302
  - PCA, 293
- Venuleo, C., 18, 184
- Veracity, 124, 127, 133–136. *See also* Schema approach, remembering and memory
- Verbal and non-verbal behavior
  - academic task structure (ATS), 374
  - behavioral concept, 373
  - characteristics, 373, 374
  - interpretation steps, 375
  - quantitative-experimental method, 373

- social participation structure (SPS), 374
  - teaching-learning process, 374, 375
  - Vikan, A., 599
  - Virasoro, M.A., 9
  - Visser, I., 271, 281
  - Volkelt, H., 326, 338, 342, 343
  - von Bertalanffy, L., 596
  - von Foerster, H., 356
  - Vorsmann, N., 370
  - Vygotsky, L.S., 50, 102, 103, 237, 489
  - Vygotsky's double stimulation
    - experimentally isolated components, 103, 104
    - external mediator, 102
    - means and process*, 104
    - memory studies, 102, 103
- W**
- Wagenmakers, E.-J., 202, 281
  - Wagner-Willi, M., 375
  - Wallerstein, R.S., 3
  - Wallis, W.A., 242
  - Walls, T.A., 213, 280
  - Warren, K., 212
  - Wartofsky, M., 589
  - Watson, D., 298
  - Watson, M.W., 262
  - Watzlawick, P., 497
  - Wayman, J., 358
  - Weakland, J.H., 497
  - Weiss, P., 600
  - Wellek, A., 327
  - Welsch, W., 142
  - Werner, H., 50, 51, 108, 110, 320, 335, 610
  - Werner, J., 208
  - Werner's method
    - Aktualgenese* method, modified, 102
    - aphasics, 102
    - innovation, 101
    - microgenesis, 100
    - spherical cognition, 101
  - Wertheimer, M., 51
  - Wettstein, A., 360
  - Weymann, A., 147
  - Whitehead, A.N., 94
  - White, M., 496
  - Wickens, T.D., 271
  - Wienbruch, C., 91
  - Witherington, D.C., 595
  - Wittgenstein, L., 19
  - Wohlfahrt, E., 332
  - Wohlrab-Sahr, M., 163
  - Wollenberg, A.L.v.d., 76
  - Wood, P., 262
  - Worley, B., 546
  - Wright, H., 373, 568
  - Wright, J.C., 360
  - Wundt's methodology
    - apperception, *will* process, 325, 326
    - criteria to be met, 324
    - experimental introspection, 323
    - Ganzheitspsychologie* threshold
      - analytic thought, 328
      - holistic approach, 326
      - synthetic thought, 328
      - Völkerpsychologie*, 327
    - psychogenesis search, 325
    - psychological experiment, 323, 324
  - Wundt, W., 50, 320, 322, 324–329
  - Würzburg School methodologies
    - "Aha-experience", 331
    - consciousness of a rule*, 330, 331
    - consciousness of relations*, 331
    - Külpe-group, 329, 330
    - research participant study, 330
    - "think aloud" approach, 331
- Y**
- Yao, Q., 191
  - Yardley, L., 197
  - Yasuda, Y., 226, 228
- Z**
- Zhang, G., 261, 262
  - Zhang, Z., 212
  - Zhu, W., 262
  - Zittoun, T., 481
  - Zone of actual development (ZAD), 344
  - Zone of finality (ZoF), 229, 230