



FOOD ENGINEERING SERIES

Eugène Vorobiev  
Nikolai Lebovka  
*Editors*



# Electrotechnologies for Extraction from Food Plants and Biomaterials

 Springer

# Food Engineering Series

## **Series Editor**

Gustavo V. Barbosa-Cánovas, Washington State University

## **Advisory Board**

José Miguel Aguilera, Pontificia Universidad Católica de Chile

Xiao Dong Chen, Monash University

J. Peter Clark, Clark Consulting

Richard W. Hartel, University of Wisconsin

Albert Ibarz, University of Lleida

Jozef Kokini, Rutgers University

Michèle Marcotte, Agriculture & Agri-Food Canada

Michael McCarthy, University of California at Davis

Keshavan Niranjana, University of Reading

Micha Peleg, University of Massachusetts

Shafiur Rahman, Sultan Qaboos University

M. Anandha Rao, Cornell University

Yrjö Roos, University College Cork

Walter L. Spiess, Bundesforschungsanstalt

Jorge Welti-Chanes, Universidad de las Américas-Puebla

For further volumes:

<http://www.springer.com/series/5996>

Eugène Vorobiev • Nikolai Lebovka  
Editors

# Electrotechnologies for Extraction from Food Plants and Biomaterials

 Springer

*Editors*

Eugène Vorobiev  
Université de Technologie  
de Compiègne  
Centre de Recherche de Royallieu  
Compiègne  
France  
eugene.vorobiev@utc.fr

Nikolai Lebovka  
F.D. Ovcharenko  
NAS of Ukraine  
Kyiv  
Ukraine  
lebovka@roller.ukma.kiev.ua

ISSN: 1571-0297

ISBN: 978-0-387-79373-3

e-ISBN: 978-0-387-79374-0

DOI: 10.1007/978-0-387-79374-0

Library of Congress Control Number: 2008932546

© 2008 Springer Science+Business Media, LLC

All rights reserved. This work may not be translated or copied in whole or in part without the written permission of the publisher (Springer Science+Business Media, LLC, 233 Spring Street, New York, NY 10013, USA), except for brief excerpts in connection with reviews or scholarly analysis. Use in connection with any form of information storage and retrieval, electronic adaptation, computer software, or by similar or dissimilar methodology now known or hereafter developed is forbidden.

The use in this publication of trade names, trademarks, service marks, and similar terms, even if they are not identified as such, is not to be taken as an expression of opinion as to whether or not they are subject to proprietary rights.

Printed on acid-free paper

springer.com

# Preface

Solvent and pressure extraction are the major unit operations in many food and related industries (production of sugar, wine, vegetable oils, and fruit juices), recuperation of valuable plant components (proteins, antioxidants, and flavors), dehydration of fibrous materials and biological wastes, etc.

Recently, electrotechnologies, based on effects of pulsed electric fields (PEF), ohmic heating (OH), and DC electric field, gained the real interest in relation to the processing of foods. These techniques allow enhancement of efficient extraction from food plants and dehydration of biosolids. PEF and pulsed OH preserve nutritional, functional, structural, and sensory properties of products better than conventional extraction technologies. Electrofiltration and electro-osmotic dewatering can be very effective for separation of bioproducts and dehydration of food wastes. This book overviews fundamental principles of the said electrical techniques, electro-physical properties of foods and agricultural products, and application of various emerging electrotechnologies for enhancing the solid-liquid separation and drying processes, extraction of pigments, processing of different in-plant tissues and biosolids, electro-osmotic dewatering and electrofiltration of biomaterials, recent industrial-scale gains, and other aspects.

In Chapter 1 the main mechanisms of electroporation, important differences between single-cell and tissue electroporation, and effects of the treatment parameters and media composition are discussed. Various applications of electroporation in biotechnology, medicine, food preservation, and tissue ablation are also reviewed. In Chapter 2, the fundamental aspects of electroporation in application to electrically induced damage of plant tissues are critically discussed, and recent experiments in PEF-induced acceleration of expression, diffusion, and drying processes are analyzed. Chapter 3 reviews perspectives of the moderate electric field (MEF) application for improvement of extraction, dehydration, and fermentation operations. In Chapter 4, the effects of the low-intensity DC electrification of vegetative and animal materials in food and agricultural applications are presented. In Chapter 5, the electric field applications for electro-osmotic dewatering of biomaterials, food processing products and wastes, and biomass sludge, are covered in details. Chapter 6 reviews different examples of electrofiltration application for dewatering of biopolymers and fractionation of different polymer colloids. The general guidelines to operation of the press electrofiltration, based on the practical

experience of the authors with this technology, are also summarized. Chapter 7 contains illustrations of the potential of PEF application for food preservation, enhancement of mass transfer processes, and softening of the plant tissues. The energy requirements and cost-effectiveness are also analyzed. Chapter 8 analyzes application of high-voltage electrical discharges for enhancing kinetics and quantity of extracted matter extracted from the oilseeds and other food plants. And, finally, in Chapter 9 the technical requirements and perspectives of industrial-scale electroporation of the plant cell tissues are discussed. The recent industrial applications for sugar beet treatment, green biomass conditioning, and extraction of aromas and flavors from the wine grapes are also considered.

We sincerely hope that this book will be useful for the engineers and scientists searching the new efficient methods for extraction and separation of desired components from plant materials.

Eugène Vorobiev  
Nikolai Lebovka

Compiègne Cedex, France  
Kyiv, Ukraine

# Contents

|  |     |
|--|-----|
| <b>Electroporation in Biological Cell and Tissue: An Overview</b> .....  | 1   |
| Maša Kandušer and Damijan Miklavčič  |     |
| <b>Pulsed-Electric-Fields-Induced Effects in Plant Tissues: Fundamental Aspects and Perspectives of Applications</b> ..... | 39  |
| Eugène Vorobiev and Nikolai Lebovka  |     |
| <b>Moderate Electrothermal Treatments of Cellular Tissues</b> .....  | 83  |
| Suzanne Kulshrestha, Sanjay Sarang, Laleh Loghavi, and Sudhir Sastry   |     |
| <b>DC Electrical Field Effects on Plant Tissues and Gels</b> .....   | 96  |
| Amos Nussinovitch and Ronit Zvitov   |     |
| <b>Electro-Osmotic Dewatering (EOD) of Bio-Materials</b> .....   | 121 |
| Arun S. Mujumdar and Hiroshi Yoshida   |     |
| <b>Electrofiltration of Biomaterials</b> .....   | 155 |
| R. Hofmann, T. K  ppler, and C. Posten   |     |
| <b>Food Industry Applications for Pulsed Electric Fields</b> .....   | 181 |
| Henry Jaeger, Ana Balasa, and Dietrich Knorr   |     |
| <b>Application of High-Voltage Electrical Discharges for the Aqueous Extraction from Oilseeds and Other Plants</b> .....   | 217 |
| C  cile Gr  my-Gros, Jean-Louis Lanoisell  , and Eug  ne Vorobiev  |     |
| <b>Industrial-Scale Treatment of Biological Tissues with Pulsed Electric Fields</b> .....                                  | 237 |
| H. Bluhm and M. Sack   |     |
| <b>Index</b> .....   | 271 |

# Contributors

Ana Balasa

Department of Food Biotechnology and Food Process Engineering, Berlin  
University of Technology

H. Bluhm

Forschungszentrum Karlsruhe GmbH, Institute for Pulsed Power and Microwave  
Technology, Postfach 3640, D-76021 Karlsruhe, e-mail: bluhm@ihm.fzk.de

Cécile Grémy-Gros

Université d'Angers, ISTIA, LASQUO, UPRES EA 3858,  
e-mail: cecile.gros@istia.univ-angers.fr

R. Hofmann

Degussa AG, Process Technology, e-mail: ralph.hofmann@degussa.com

Henry Jaeger

Department of Food Biotechnology and Food Process Engineering, Berlin  
University of Technology

Maša Kandušer

Faculty of Electrical Engineering, University of Ljubljana, Tržaška 25, SI-1000  
Ljubljana, Slovenia, e-mail: Masa.Kanduser@fe.uni-lj.si

T. Käppler

Institute of Process Engineering in Life Sciences, University of Karlsruhe,  
e-mail: clemens.posten@mvm.uka.de

Dietrich Knorr

Department of Food Biotechnology and Food Process Engineering, Berlin  
University of Technology

Suzanne Kulshrestha

Department of Food, Agricultural, and Biological Engineering, The Ohio State  
University, 590 Woody Hayes Dr., Columbus, OH 43210,  
e-mail: kulshrestha.11@osu.edu



Jean-Louis Lanoisellé

Université de Technologie de Compiègne, Chemical Engineering Department,  
UMR CNRS 6067, e-mail: jean-louis.lanoiselle@utc.fr

Nikolai Lebovka

Department de Génie Chimique, Université de Technologie de Compiègne, Centre  
de Recherche de Royallieu, B.P. 20529-60205 Compiègne Cedex, France; Institute  
of Biocolloidal Chemistry named after F.D. Ovcharenko, NAS of Ukraine, 42, blvr.  
Vernadskogo, Kyiv 03142, Ukraine, e-mail: Nikolai.Lebovka@utc.fr

Laleh Loghavi

Department of Food, Agricultural, and Biological Engineering, The Ohio State  
University, 590 Woody Hayes Dr., Columbus, OH 43210,  
e-mail: loghavi.1@osu.edu

Damijan Miklavčič

Faculty of Electrical Engineering, University of Ljubljana, Tržaška 25, SI-1000  
Ljubljana, Slovenia, e-mail: Damijan.Miklavcic@fe.uni-lj.si

Arun S. Mujumdar

National University of Singapore, Mineral, Metal & Materials Technology Centre,  
Engineering Science Programme, e-mail: mpeasm@nus.edu.sg

Amos Nussinovitch

The Hebrew University of Jerusalem, Faculty of Agricultural, Food and  
Environmental Quality Sciences, Institute of Biochemistry, Food Science and  
Human Nutrition, P.O. Box 12, Rehovot 76100 Israel, e-mail: nussi@agri.huji.ac.il

C. Posten

Institute of Process Engineering in Life Sciences, University of Karlsruhe,  
e-mail: clemens.posten@mvm.uka.de

M. Sack

Forschungszentrum Karlsruhe GmbH, Institute for Pulsed Power and Microwave  
Technology, Postfach 3640, D-76021 Karlsruhe

Sanjay Sarang

Department of Food, Agricultural, and Biological Engineering, The Ohio State  
University, 590 Woody Hayes Dr., Columbus, OH 43210, e-mail: sarang.1@osu.edu

Sudhir Sastry

Department of Food, Agricultural, and Biological Engineering, The Ohio State  
University, 590 Woody Hayes Dr., Columbus, OH 43210, e-mail: sastry.2@osu.edu

Eugène Vorobiev

Department de Génie Chimique, Université de Technologie de Compiègne,  
Centre de Recherche de Royallieu, B.P. 20529-60205 Compiègne Cedex, France;  
Chemical Engineering Department, Université de Technologie de Compiègne,  
UMR CNRS 6067, e-mail: eugene.vorobiev@utc.fr

Hiroshi Yoshida

Oyama National College of Technology, Department of Materials Chemistry  
and Bioengineering, e-mail: yoshida@oyama-ct.ac.jp

Ronit Zvitov

The Hebrew University of Jerusalem, Faculty of Agricultural, Food and  
Environmental Quality Sciences, Institute of Biochemistry, Food Science and  
Human Nutrition, P.O. Box 12, Rehovot 76100 Israel, e-mail: zvitovr@gmail.com

# Electroporation in Biological Cell and Tissue: An Overview

Maša Kandušer and Damijan Miklavčič

**Abstract** In this chapter, basics and mechanisms of electroporation are presented. Most important electric pulse parameters for electroporation efficiency for different applications that involve introduction of small molecules and macromolecules into the cell or cell membrane electrofusion are described. In all these applications, cell viability has to be preserved. However, in some biotechnological applications, such as liquid food sterilization or water treatment, electroporation is used as a method for efficient cell killing. For all the applications mentioned above, besides electric pulse parameters, other factors, such as electroporation medium composition and osmotic pressure, play significant roles in electroporation effectiveness. For controlled use of the method in all applications, the basic mechanisms of electroporation need to be known. The phenomenon was studied from the single-cell level and dense cell suspension that represents a simplified homogenous tissue model, to complex biological tissues. In the latter, different cell types and electric conductivity that change during the course of electric pulse application can significantly affect the effectiveness of the treatment. For such a complex situation, the design and use of suitable electrodes and theoretical modeling of electric field distribution within the tissue are essential. Electroporation as a universal method applicable to different cell types is used for different purposes. In medicine it is used for electrochemotherapy and genetherapy. In biotechnology it is used for water and liquid food sterilization and for transfection of bacteria, yeast, plant protoplast, and intact plant tissue. Understanding the phenomenon of electroporation, its mechanisms and optimization of all the parameters that affect electroporation is a prerequisite for successful treatment. In addition to the parameters mentioned above, different biological characteristics of treated cell affect the outcome of the treatment. Electroporation, gene electrotransfer and electrofusion are affected by cell membrane fluidity, cytoskeleton, and the presence of the cell wall in bacteria yeast and plant cells. Thus, electroporation parameters need to be specifically optimized for different cell types.

---

M. Kandušer

Faculty of Electrical Engineering, University of Ljubljana, Tržaška 25, SI-1000 Ljubljana, Slovenia  
e-mail: Masa.Kanduser@fe.uni-lj.si

## 1 Basics and Mechanisms

Electroporation is a method of cell membrane permeabilization that is today widely used in biotechnology and medicine for delivery of drugs and genes into living cells (Neumann et al. 1982; Fromm et al. 1985; Teissié 1988; Ferber 2001; Prud'Homme et al. 2006). It is alternative method for water sterilization and food preservation (Teissié et al. 2002), and it is a prerequisite for cell electrofusion (Zimmermann 1982; Teissié and Rols 1986; Ramos and Teissié 2000a).

The phenomenon of electroporation can be described as a dramatic increase in membrane permeability caused by externally applied short and intense electric pulses. Various theoretical models were developed to describe electroporation, among which the transient aqueous pore model is the most widely accepted. According to this model, hydrophilic pores are formed in the lipid bilayer of a cell membrane when it is exposed to external electric pulses. In the cell membrane, hydrophobic pores are formed by spontaneous thermal fluctuations of membrane lipids. In a cell exposed to an external electric field, the presence of an induced transmembrane potential provides the free energy necessary for structural rearrangements of membrane phospholipids and thus enables hydrophilic pore formation (Neumann et al. 1989; Tsong 1991; Chang et al. 1992; Weaver and Chizmadzev 1996). Hydrophilic pores form only in a small fraction of the membrane exposed to electric field. Even though some attempts to visualize the changes in the membrane structure caused by electric pulse application were made (Stenger and Hui 1986; Chang and Rees 1990), the structural reorganization and creation of hydrophilic pores has so far not been directly observed (Rols 2006). All the data available until now have been obtained as an indirect evidence of membrane permeabilization, such as measurements of conductivity changes caused by electric pulse application and observations of molecular transport through the cell membrane (Neumann et al. 1989; Weaver and Chizmadzev 1996).

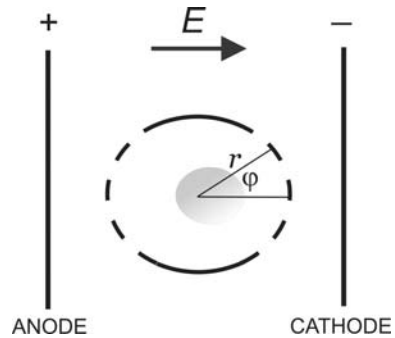
Cell membrane electroporation takes place because the cell membrane amplifies the applied external electric field, as its conductivity is several orders of magnitude lower than the conductivities of extra cellular medium and cell cytoplasm. The theoretical description of the transmembrane potential induced on a spherical cell exposed to electric field is known as Schwan's equation (Neumann et al. 1989; Marszalek et al. 1990; Kotnik et al. 1997). The induced transmembrane potential for a spherical cell can be calculated as:

$$U_{TI} = -1.5rE\cos\varphi \quad (1)$$

where  $r$  is the radius of the cell,  $E$  is the strength of applied electric field, and  $\varphi$  is the angle between the direction of the electric field and the selected point on the cell surface. The induced transmembrane potential and therefore maximum electroporation occur at the poles of the cell exposed to the electric field facing the electrodes (Fig. 1).

Electroporation can be either reversible or irreversible, depending on parameters of the electric pulses. It is a threshold phenomenon: the induced transmembrane

**Fig. 1** Cell in an electric field. The induced transmembrane potential is maximal at the poles of the cell in accordance with Equation (1). Electroporated area is presented with dashed line



voltage imposed by external electric field should reach a critical value to trigger formation of transient aqueous pores in the cell membrane (Kinosita and Tsong 1979; Abidor et al. 1979; Neumann and Rosenheck 1972; Kinosita and Tsong 1977). The threshold membrane potential that needs to be reached in the cell membrane is between 200 mV and 1 V (Zimmermann 1982; Tsong 1991; Teissié and Rols 1993). For reversibility of electroporation, the membrane potential has to be kept below the critical value. In such conditions, the cell membrane recovers after electric pulse application (Neumann et al. 1989). On the contrary, when the critical value is exceeded, irreversible electroporation takes place, resulting in cell membrane disintegration and loss of cell viability (Hamilton and Sale 1967; Meaking et al. 1995; Danfelter et al. 1998).

The electroporation process consists of different phases. The first of them is pore formation, which is the cell membrane's response to the induced threshold membrane potential, and lasts a few microseconds. The second phase is a time-dependent expansion of the pore size taking place in a time range of hundreds of microseconds to milliseconds, and lasts throughout the duration of pulses. The last phase is membrane recovery, which takes place after electric pulse application and consists of pore resealing, and lasts several minutes (Kinosita and Tsong 1977; Hibino et al. 1993; Neumann et al. 1999; Leontiadou et al. 2004). This resealing phase is strongly affected by temperature (Kinosita and Tsong 1977) and cytoskeleton integrity (Rols and Teissié 1992a; Teissié and Rols 1994). The first phase of electroporation can be measured by changes in membrane conductivity and is related to short-lived transient pore formation, which does not contribute to molecular transport (Pavlin et al. 2007). Molecular transport across the permeabilized cell membrane associated with electroporation is observed from the pore formation phase until membrane resealing is completed (Gabriel and Teissié 1997, 1999; Prausnitz et al. 1995; Puc et al. 2003; Pavlin et al. 2007).

Electroporated membranes are also a prerequisite for associated membrane phenomena termed electrofusion. During electric pulse application and immediately after it, the cell membrane is capable of fusion: it is in a so-called fusogenic state (Teissié et al. 1982; Zimmermann 1982).

In brief, electroporation is a useful technique in biotechnology and medicine for introduction of different molecules into the cell, electrofusion, or water sterilization

and food preservation. Among different theoretical models that describe electroporation, the transient aqueous pore model is most widely accepted. This model predicts hydrophilic pore formation as a response to induced external electric field on the cell membrane. Electroporation can be reversible or irreversible, depending on the electric pulse parameters used.

## 2 Influential Parameters

Electroporation is affected on the one hand by parameters of electric pulses and chemical composition of the media used and on the other by the characteristics of the cell that is exposed to the electric field. The effect of the electric pulse parameters and electroporation media are described in this section.

### 2.1 Parameters of Electric Field

The parameters of electric pulses were extensively investigated. The most important electric pulse parameters are amplitude, duration, number, and repetition frequency (Rols and Teissié 1990a; Wolf et al. 1994; Gabriel and Teissié 1995a; Vernhes et al. 1999; Maček-Lebar et al. 1998; Maček-Lebar and Miklavčič 2001; Bilska et al. 2000; Canatella et al. 2001). If those parameters exceed the optimal values, irreversible electroporation takes place due to cell membrane disintegration (Hamilton and Sale 1967; Danfelner et al. 1998) and DNA damage (Meaking et al. 1995), resulting in cell lysis. The choice of electric pulse parameters thus depends on the desired application. Some applications require reversible, while others require irreversible electroporation. For loading of foreign molecules into the cell, reversible electroporation is required. The choice of electric pulse parameters depends on the type of the foreign molecule that is being introduced. For small molecules, such as different drugs or fluorescence dyes, a train of relatively short pulses (time duration in range of microseconds to milliseconds) is sufficient. For large molecules, such as DNA, longer pulses (range of few milliseconds) or a combination of high-voltage short-duration pulses and low-voltage long-duration pulses is used (Wolf et al. 1994; Klenchin et al. 1991; Sukharev et al. 1992; Šatkauskas et al. 2002).

Besides the before mentioned parameters of electric pulses, different pulse shapes can also be used. The most frequently used are exponential and square wave pulses. One should be careful when comparing results obtained by different pulse shapes, as the membrane polarization process that takes place during the pulse application is different (Neumann 1992).

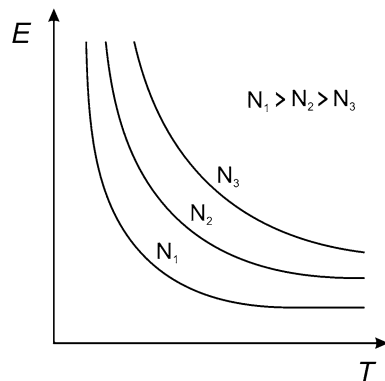
Electric pulses can be applied in one direction or their orientations can be changed during the pulse application. Such protocols were successfully used for electrochemotherapy and gene electrotransfer (Rols, Teissié 1990a; Tekle et al. 1991; Serša et al. 1996; Vernhes et al. 1999; Kotnik et al. 2001a; Kotnik et al. 2001b; Golzio et al. 2002; Faurie et al. 2004; Faurie et al. 2005; Reberšek et al. 2007).

### 2.1.1 Introduction of Small Molecules

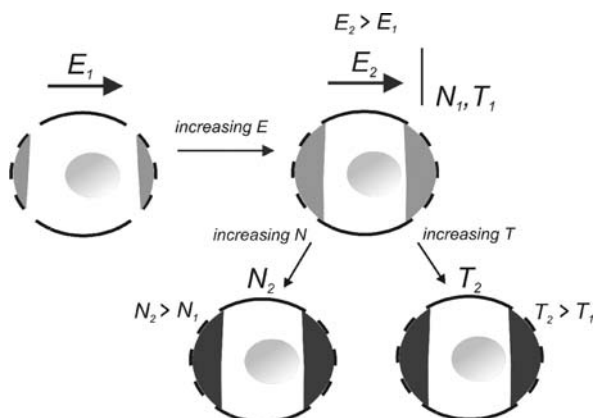
For introduction of small molecules, short electric pulses in a range of tens to hundreds of microseconds are generally used. The most important parameter is pulse amplitude. It should reach a threshold value at which the electroporation of cell membrane is triggered. Above the threshold value the increase in electroporation is obtained with increase of pulse duration and number of pulses (Fig. 2). The increase in pulse duration increases the electroporation of cells until a plateau is reached and further increase in number of pulses or its duration does not affect cell electroporation (Rols and Teissié 1990a; et al. 1993; Maček-Lebar and Miklavčič 2001). At the same time the increase in pulse number and pulse duration affects cell viability (Gabriel and Teissié 1995b; Maček-Lebar and Miklavčič 2001). The following explanation for the relationship between the pulse amplitude and the pulse number or duration was proposed: increasing the pulse amplitude results in larger area of membrane electroporation with smaller extent of electroporation, while increase in pulse number or duration does not affect the electroporated membrane area but increases the extent of electroporation (Fig. 3) (Rols 2006). Nevertheless, when increasing the duration of the pulse, one should also consider that longer pulses cause significant Joule heating of the sample (Pliquett et al. 1996).

Systematic study of electric pulse parameters revealed that electroporation and cell viability are not related to the total electrical energy delivered (Maček-Lebar et al. 1998; Vernhes et al. 1999). Further examinations of different parameters of electric pulses indicate complex dependence between electric pulse parameters and degree of electroporated cell membrane (Canatella et al. 2001).

Another electric pulse parameter affecting electroporation of the cell membrane is pulse repetition frequency. When pulses are applied with high repetition frequency, above 1 kHz, the pause between two consecutive pulses is too short and does not allow cell membrane to return to pre-pulse state. From the experimental results it can be concluded that cell viability and cell membrane electroporation is optimal in the frequency range from 0.5 to 10 Hz and decreases at higher frequencies (Vernhes et al. 1999; Pucihar et al. 2002; Pavlin et al. 2005).



**Fig. 2** Fraction of electroporated cells is increasing with increasing number of applied pulses. E, electric field strength, T, pulse duration, N, number of applied pulses



**Fig. 3** Increasing the pulse amplitude results in larger area of membrane with smaller extent of electroporation, while increase in pulse number or duration does not affect the membrane area but increases the extent of electroporation

For reversibility of electroporation, the membrane potential has to be kept below the critical value. In such conditions, the cell membrane recovers after the electric pulse application (Neumann et al. 1989). On the contrary, when critical value is exceeded, irreversible electroporation takes place, resulting in cell membrane disintegration and loss of cell viability (Hamilton and Sale 1967; Meaking et al. 1995; Danfelter et al. 1998).

### 2.1.2 Introduction of Macromolecules

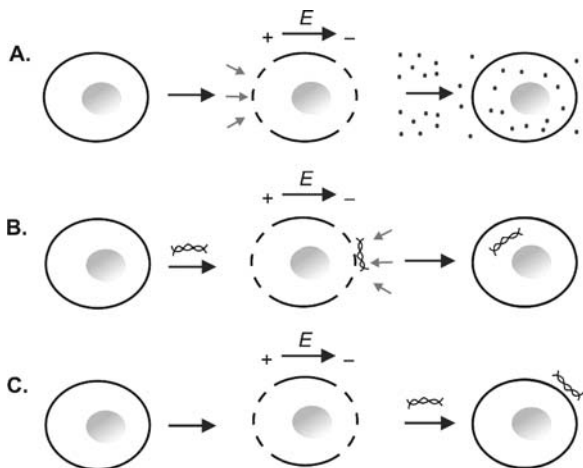
The optimal conditions for introduction of macromolecules are different from optimal conditions for introduction of small molecules (Wolf et al. 1994). Most experiments were performed with long, 5 to 10 ms pulses with relatively low pulse amplitude. When those results were compared with results obtained with higher-voltage microsecond pulses, typically used for introduction of small molecules, it was established that many different pulse parameters are capable of delivering plasmid DNA into the cell. Protocols employing millisecond pulses are more efficient than microsecond pulses for long-term gene expression *in vivo* (Lucas and Heller 2001).

The efficiency of gene electrotransfer into mammalian cells was first related to the pulse shape used, and exponentially decaying pulses were reported as more effective than the square wave pulses (Andreson and Evans 1989). Later, the use of combination of high-voltage and low-voltage pulses was suggested. High-voltage pulse causes electroporation of cell membrane, while the low-voltage pulse helps highly charged DNA entrance into the cell interior. A low-voltage pulse thus provides electrophoretic movement of DNA into the cell in *in vitro* conditions, or it can be a powerful driving force for improving interstitial transport of DNA during gene delivery *in vivo* (Klenchin et al. 1991, Sukharev et al. 1992; Zaharoff



et al. 2002; Zaharoff and Yuan 2004). The effect of electrophoretic pulses was successfully used and demonstrated in *in vivo* experiments in mammalian tissues (Bureau et al. 2000; Somiari et al. 2000; Šatkauskas et al. 2002; Šatkauskas et al. 2005; Andre and Mir 2004; Zampaglione et al. 2005; Pavšelj and Preat 2005a). Nevertheless, the role of electrophoretic force in DNA movement across permeabilized membrane is questioned for *in vitro* gene electrotransfer as no contribution of electrophoretic force could be detected (Wolf et al. 1994). Lately the effect of electrophoretic movement of DNA by low-voltage pulse has also been questioned for *in vivo* applications (Liu et al. 2006).

The effect of low-voltage electric pulse on the highly charged DNA is alternatively attributed to electrophoretic accumulation of DNA on the cell membrane (Wolf et al. 1994). It has also been demonstrated by visualization of DNA interaction with the cell membrane that the electric field orientation plays an important role in gene electrotransfer (Golzio et al. 2002; Faurie et al. 2004; Faurie et al. 2005; Reberšek et al. 2007). Similar to small molecules, asymmetric DNA uptake is observed during electroporation (Mehrlle et al. 1985; Tekle et al. 1991). Nevertheless, DNA, unlike small molecules that enter cell cytoplasm on the membrane-facing cathode, enters the cell on the surface-facing anode (Golzio et al. 2002; Faurie et al. 2004; Faurie et al. 2005). Another main difference between introduction of small molecules and DNA is that for successful gene electrotransfer, DNA has to be present in the medium before electric pulses are applied (Fig. 4) and the transport of the DNA through cell membrane takes place minutes after the pulse



**Fig. 4** Introduction of small and large molecules by electroporation. (A) Introduction of small molecules takes place during and predominantly after the pulse. Electroporation of the cell membrane is asymmetrical and occurs first at the anode side (small grey arrows). (B) Introduction of DNA into the cell. DNA must be present before electric pulses are applied. The initial step is DNA adsorption to the cell membrane, which takes place in the cell membrane facing cathode (small grey arrows). (C) When DNA is added after the pulse application it cannot be introduced into the cell

application (Golzio et al. 2002). No spontaneous interaction of DNA with the cell membrane was detected. The complex between the DNA and the membrane forms only when the membrane is electroporated. If DNA is added after pulse application, no transfection can be observed. It was, however, demonstrated that transfection is successful if the DNA is added after the high-voltage pulse and before low-voltage pulse, but the level of DNA expression is lower (Šatkauskas et al. 2002).

### 2.1.3 Electrofusion

The electrofusion is a two-step process; it involves cell membrane electroporation and a close physical contact of two electroporated membranes in fusogenic state (Zimmermann 1982; Saunders et al. 1986). The electric field parameters needed for introduction of small molecules and for electrofusion are similar. The main difference between two processes is the critical voltage required for electrofusion, which is higher than for electroporation (Teissié and Rols 1993; Abidor et al. 1994; Teissié and Ramos 1998), and the duration of fusogenic state, which is shorter than cell membrane resealing process. The resealing of the cell membrane after electroporation can take up to tens of minutes, while membrane fusion is only possible if the contact of permeabilized membranes is achieved within few minutes after pulse application (Teissié and Rols 1986; Sowers 1986; Ramos and Teissié 2000a). The contact needed for electrofusion can be obtained before or immediately after the electroporation pulse. When the cell contact is obtained before electroporation, most often dielectrophoresis is used (Zimmermann 1982), while the contact of cells after electroporation is obtained by centrifugation of fusogenic cells (Teissié and Rols 1986; Sowers 1986).

The close physical contact obtained by dielectrophoresis results in pearl chain formation (Zimmermann 1982). For this application, an alternating electric field of low amplitude on the order of few hundred volts per centimeter and frequencies in the range of 10 kHz to 6 MHz is used (Zimmermann 1982; Vienken and Zimmermann 1985; Saunders et al. 1986). During electrophoresis the polarized cells are attracted to the areas of high field strength (Oblak et al. 2007). Cells migrate toward each other and form pearl chains. The procedure is rapid and has negligible effect on cell viability (Saunders et al. 1986). The alternating electric field is then switched off and an electroporation pulse is applied. To maintain cells in the close contact after electroporation, the alternating electric field is applied again for a short duration (Vienken, Zimmermann 1985).

When the contact of electroporated cells is obtained after the pulse (Teissié and Rols 1986), better fusion yield is obtained, if a larger membrane area is in fusogenic state. This can be obtained by proper selection of electric pulse parameters, such as number of pulses and their duration (Ramos and Teissié 2000a). When the electric field orientation is changed during the pulse application, it results in increase of electroporated area of cell membrane (Valič et al. 2003). The efficiency of electrofusion was reported to be slightly lower when the contact is obtained after the pulse than with the pre-pulse contact (Wu et al. 1992). Therefore, it is possible that

the membrane merging already starts during the electric pulse application and is concluded after the pulse (Dimitrov and Sowers 1990).

Besides electric field parameters, mechanical forces can increase the fusion yield as they enable good contact of cells (Jaroszeski et al. 1994; Ramos and Teissié 2000b).

#### **2.1.4 Irreversible Electroporation**

Irreversible electroporation is in some applications the undesired, while in others it is the desired outcome of the electric pulse application. It is a consequence of membrane rupture that is directly caused by electric pulse application (Weaver and Chizmadzev 1996). Irreversible electroporation and Joule heating are an integral part of electrical injury, which affects especially nerve and muscle cells due to their size. Release of intracellular components from affected cells cause acute renal failure due to deposition of iron-containing molecules such as myoglobin (Lee and Dougherty 2003). Successful treatment of electroporated membranes with nontoxic polymers can reduce tissue injury produced by irreversible electroporation due to sealing of electroporated cell membranes (Lee et al. 1992; Lee and Dougherty 2003).

Irreversible electroporation is the desired result when it is used for microbial deactivation in water and food treatment. The applied electric pulses should cause irreversible damage of treated cells (Teissié et al. 2002). For effective treatment, critical electric field parameters should be chosen properly. Typical pulse amplitude for microbial deactivation in water and liquid food is between 20 and 35 kV/cm, pulse duration, from micro- to milliseconds, and pulse number varies from ten to hundred pulses (Zhang et al. 1995; Angersbach et al. 2000; Beveridge et al. 2002). For food preservation, amplitudes used are lower than for microbial inactivation in freshwater and liquid food. The main problem is the choice of optimal treatment parameters that would require minimal power consumption and would effectively disintegrate treated cells (Lebovka et al. 2000, 2002).

Recently, irreversible electroporation was reported as an alternative minimally invasive surgical technique in medicine for tissue ablation. The train of ten electrical pulses in the range of 1.5 kV/cm and duration 300 ms was applied three times for effective tissue ablation. The method was also tested in vivo. For in vivo applications, mathematical models provided a valuable tool for proper electrode positioning and optimal pulse parameter determination for effective treatment (Davalos et al. 2005; Miller et al. 2005; Edd et al. 2006; Rubinsky et al. 2007).

## ***2.2 Electroporation Medium Composition***

Conflicting reports are found on the effect of medium composition on electroporation. In some reports, increasing the ionic strength of the medium resulted in cell membrane electroporation at lower electric field intensities. The nature of monovalent ions such as sodium, potassium, or lithium (Na, K, Li) does not affect the

electroporation. On the other hand, presence of bivalent calcium ion in the medium resulted in cell lysis and death (Rols and Teissié 1989). Nevertheless, toxicity of calcium ions was reported independently of electroporation, as they are involved in different physiological processes in the living cell. Because of sudden and uncontrolled increase of calcium in the cytoplasm, the cell cytoskeleton is disrupted and uncontrolled activation of calcium-dependent catabolic enzymes takes place (Orrenius et al. 1989).

In some studies, when the medium conductivity was maintained unchanged, the effect of ionic composition and strength of the media on electroporation was almost negligible. Yet, when medium conductivity was decreased, electroporation efficiency increased drastically. In contrast, the resealing of the membrane was independent on medium ionic composition or conductivity (Djuzenova et al. 1996; Barrau et al. 2004). In our study performed in the wide range of medium conductivities it was observed that cell membrane electroporation as such was not affected by medium conductivity, while it had significant effect on cell survival (Pucihar et al. 2001). Medium composition affects heating of the sample during electroporation. When short electric pulses are used (in range of microseconds), Joule heating in high-conductivity media is negligible. On the other hand, when long pulse duration (milliseconds) and high amplitudes are used, Joule heating takes place during electroporation and is more pronounced in high-conductivity than in low-conductivity media (Pliquett et al. 1996; Pavlin et al. 2005).

Medium composition plays an even more important role in gene electrotransfer of bacteria, yeast, plant, and animal cells. Monovalent alkali ions were found to be involved in gene electrotransfer of the plant protoplasts. It was proposed that they increase membrane fluidity or enhance membrane electrical potential, making the protoplast more susceptible to an applied electric pulse (Saunders et al. 1989). In contradiction to the previously reported role of calcium on cell viability, the presence of bivalent cations such as calcium and magnesium ( $\text{Ca}^{2+}$   $\text{Mg}^{2+}$ ) was found to improve transfection efficiency of bacteria and yeast (Xie et al. 1990; Neumann et al. 1996). The role of bivalent cations in gene electrotransfer is attributed to improved DNA adsorption to the cell membrane.

Electrofusion yield is also improved by the presence of bivalent cations in the medium (Ohno-Shosaku and Okada 1985; Vienken and Zimmermann 1985), while the presence of monovalent ions decreased the fusion yield (Rols and Teissié 1989). Nevertheless, cell electrofusion is a complex process and several biologically active substances affect its yield (Grobner, Velizarov, Berg 1996; Velizarov and Berg 1998a; Velizarov et al. 1998b; Liu et al. 2000).

### ***2.3 Osmotic Pressure***

Electroporation is further affected by electroporation buffer osmolarity. When it is carried out in a hypertonic media, cells are permeabilized at a lower voltage than cells maintained in isotonic media and exposed to the same electric pulse parameters. On the other hand increasing the osmotic pressure of the post-electroporation

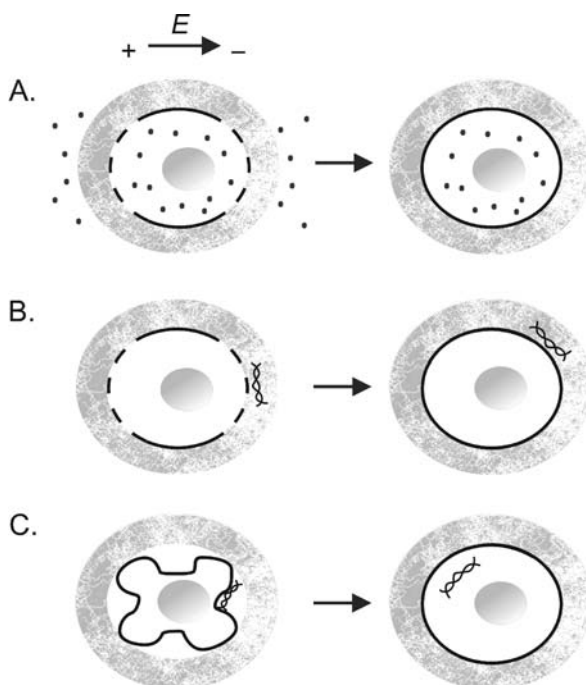
media (hypertonic media) facilitates the resealing of electroporated cells (Rols and Teissié 1990b).

Osmolarity of the electroporation media affects the cell size and shape changes caused by electroporation. The electroporation of cells in suspension results in an increase in cell diameter up to 30%, which corresponds to 100% of volume increase, in isotonic medium, while the increase is significantly lower in hypertonic medium. In addition, the osmolarity of the medium plays an important role in post-pulse incubation (Golzio et al. 1998; Barrau et al. 2004).

As electrostatic and electrorepulsive forces play an important role in an initial step of gene electrotransfer process, when a highly charged DNA molecule adsorbs to cell membrane, the medium osmolarity is an important factor in this process. Hypotonic media facilitate the gene electrotransfer in mammalian cell because of the decrease in repulsion between DNA and cell membrane. The initial step of successful DNA–membrane interaction is a key step for successful gene transfer (Wolf et al. 1994; Golzio et al. 1998). On the other hand, a hypertonic medium improves gene electrotransfer of gram-positive bacteria because of improved cell survival. Higher electric pulse amplitudes can be used, which result in better electroporation of the cell membrane and DNA loading into the cell (Xue et al. 1999). Also in plant cells, a hypertonic medium is used for improved gene electrotransfer. Osmotic treatment of an intact plant cell causes plasmolysis, which is a consequence of water loss from the vacuole. The plant cells vacuoles maintain high turgor pressure, which enables cell membrane to attach closely to the cell wall. When a cell is placed in hypertonic solution, the membrane is pulled away from the cell wall because of water loss from the cytoplasm, and the cell shrinks. These partial detachments of the cell wall from the membrane cause a void space between the rigid cell wall and the cell membrane and enables the required contact between the cell membrane and the macromolecule that is being introduced into the cytoplasm (Fig. 5) (D'Halluin et al. 1992; Ganeva et al. 1995; Sabri et al. 1996a; Eynard et al. 1997; Wu and Feng 1999).

As in gene electrotransfer, the medium osmolarity also plays an important role in cell electrofusion. The electrofusion efficiency is increased in hypotonic medium due to increased osmotic pressure in the cell (Rols and Teissié 1990b, Barrau et al. 2004). When the distance between adjusted cells is reduced, repulsive forces between neighboring cells become significant; however, those forces are balanced by osmotic pressure. In a hypertonic electroporation medium, electrofusion yield is reduced (Abidor et al. 1994).

In brief, in this section the effects of electric pulse parameters, electroporation medium composition, and osmotic pressure are described. Among electric pulse parameters, pulse amplitude, duration, number, and repetition frequency significantly affect electroporation. When these parameters exceed their optimal values, cell viability is affected and irreversible electroporation takes place. For introduction of small and large molecules, different electric pulse parameters need to be used. Small molecules are efficiently introduced into the cell by application of short electric pulses in range of tens to hundreds of microseconds. The transport of small molecules takes place predominately after the pulse by diffusion. On the



**Fig. 5** Electroporation of a cell with cell wall. (A) Introduction of small molecules is not affected by cell wall. (B) DNA molecule is trapped in the cell wall. (C) Plasmolysis improves DNA transport into the cell

other hand, for macromolecules, long 5 to 10  $\mu\text{s}$  pulses with relatively low pulse amplitude are used. Besides, for successful gene electrotransfer, DNA has to be present in the medium before electric pulses are applied, while small molecules can enter the cell even if added after the pulse. Electric pulse parameters for cell electrofusion are similar to those used for introduction of small molecules, but the critical voltage required is higher. For irreversible electroporation that is used for inactivation of microorganisms, the electric pulse parameters should exceed critical value, as cell death is the desired result of such application. In addition to the electric pulse parameters, electroporation medium composition and its osmolarity strongly affect electroporation as well as related gene electrotransfer and electrofusion.

### 3 From Single-Cell to Tissue

Single-cell electroporation is a suitable tool for the study of basic electroporation mechanisms. A few attempts were made to observe ultra-structural changes related to electroporation (Stenger and Hui 1986; Escande-Geraud et al. 1988); however, the process is too fast. Besides, chemical composition and fluid characteristics of the thin cell membrane make direct observation of primary membrane changes

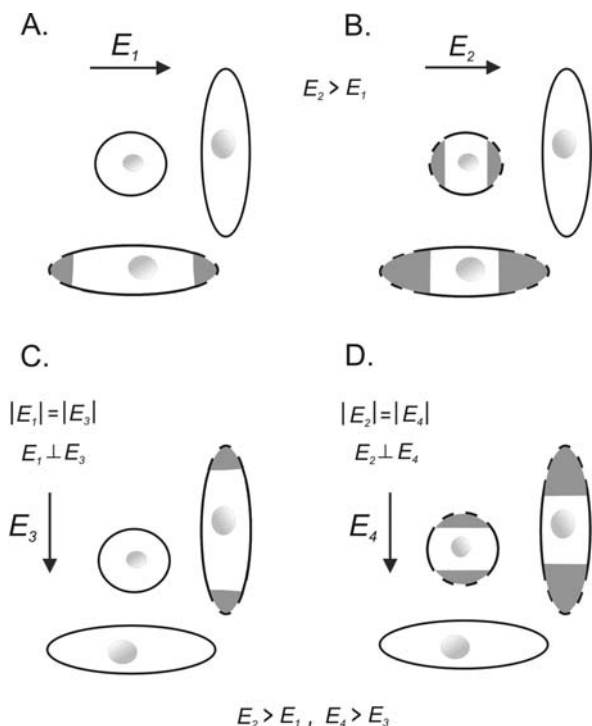
related to electroporation very difficult (Weaver and Chizmadzev 1996). The attempt was made to use rapid freezing scanning microscopy to determine the changes in membrane structure (Chang and Rees 1990); however, the size of the pores observed was 20 nm up to 120 nm, too large compared to theoretically estimated 1 nm (Weaver and Chizmadzev 1996), and the observed pores were most probably secondary structures (Rols 2006).

At the cell membrane level, the induced transmembrane potential was imaged by fluorescence probes sensitive to transmembrane potential changes induced by an external electric field. Temporal and spatial induction of transmembrane potential on the cell membrane that responds to externally applied electric field was observed with potentiometric dyes (Gross et al. 1986; Kinoshita et al. 1988; Tekle et al. 1990; Tekle et al. 1991; Hibino et al. 1991). The results obtained in those experiments on a single spherical cells are in good agreement with the theoretically calculated values obtained by Schwan's equation (Loew 1992). The value of induced transmembrane potential sustainable for living cell electroporation was determined to be 1 V (Zimmermann 1982; Tsong 1991). Later the value of the induced transmembrane potential that triggers electroporation was determined to be in the range of 200–500 mV (Marszalek et al. 1990; Grosse and Schwan 1992; Teissié et al. 1993). These values obtained by fluorescence imaging and calculations were further confirmed by direct measurement at the single-cell level using patch clamp technique (Ryttsen et al. 2000).

The value of induced transmembrane voltage depends on the cell size, shape, and the position of the cell with respect to the direction of applied electric field (Sale and Hamilton 1967; Zimmermann 1982; Graškova et al. 1996; Teissié et al. 1999; Kotnik and Miklavčič 2000; Valič et al. 2003; Valič et al. 2004). For a spheroidal cell, the maximum induced transmembrane potential strongly depends on its orientation with the respect to the electric field (Fig. 6). It is maximum when the spheroidal cell is parallel to the applied electric field (Valič et al. 2003).

The distribution of induced transmembrane potential is asymmetric due to native transmembrane potential that is present in live cells. As the induced transmembrane potential caused by externally applied electric pulses is superimposed to the resting membrane potential of the cell, the side of the cell facing the anode is hyperpolarized while the side facing the cathode is depolarized (Mehrlé et al. 1985; Gabriel and Teissié 1997, 1999; Pucihar et al. 2006). The membrane labeling with fluorescent probes allows imaging of the membrane area affected by applied electric pulse (Gabriel and Teissié 1997). It was found that the membrane resting potential has a significant effect on asymmetric electroporation, especially when the induced transmembrane potential is close to the threshold voltage that triggers electroporation. This, however, is the case in majority of the applications in which cell viability needs to be preserved (Valič et al. 2004).

The cell shape affects the site of cell membrane electroporation, and it is especially important in attached cells, as they are not at regular shape. The calculation of induced transmembrane potential on single cells, therefore, depends on the realistic cell shape that needs to be taken into account as it affects the calculated distribution of the induced transmembrane potential (Pucihar et al. 2006).



**Fig. 6** Effect of electric field orientation on electroporation of different cell sizes and shapes. (A) Electric field parallel to elongated cell. (B) Electric pulse amplitude is increased. (C) Orientation of electric field is changed. (D) Electric pulse amplitude is increased

Although a single-cell model is a valuable tool for the study of basic mechanisms of electroporation, it is not the best method to predict electroporation behavior in a tissue. As a tissue is composed of cells that are close to each other, dense cell suspensions represent an intermediate level between the single-cell level and the tissue (Abidor et al. 1994). Neighboring cells, even if they are not in direct contact, affect each other due to mutual electrical shading (Susil et al. 1998; Pavlin et al. 2002; Pucihar et al. 2006). For electroporation of cell suspensions, the proportion of the cells in the total volume is important. When they represent less than 1% of the volume fraction they behave as single cell, while for volume fraction greater than 10% or for clusters of cells, the induced transmembrane potential is affected by the suspension density (Susil et al. 1998, Pavlin et al. 2002; Pavlin et al. 2007). The fraction of electroporated cells decreases with increase in cell density and the resealing of cells in dense cell suspensions is slower. In dense cell suspensions, cell clusters, and multicellular spheroids it was found that the molecular transport is slower due to slower diffusion of molecules into the interior of such cluster or spheroid (Abidor et al. 1994; Canatella et al. 2004; Pucihar et al. 2007).

Dense cell suspensions can serve as a model for tissues with homogeneous structure composed of similar cells in close contact; nevertheless, most tissues are



not homogeneous. Tissues are composed of different cell types that are irregularly shaped, are vascularized, and present different electrical properties. All the mentioned factors affect the distribution of electric field within the tissue and consequently its electroporation efficiency (Miklavčič et al. 1998; Šemrov and Miklavčič 1998; Pucihar et al. 2006). Furthermore, cells in tissue are connected by gap junctions for intracellular communications and transport, which change the electroporation behavior of such cells, and they behave as a single larger cell (Fear and Stuchly 1998a, 1998b). For efficient tissue electroporation *in vivo*, the electric field distribution, which depends on electrode geometry, position, and electrical properties of the sample, is crucial (Šemrov and Miklavčič 2000). The electrical properties of biological tissue such as conductivity and permittivity change once the tissue is permeabilized and the electric field distribution is changed. The largest part of these changes is attributed to increased membrane conductivity due to electroporation (Pavšelj et al. 2005b; Šel et al. 2005). Changes in membrane conductivity need to be taken into account when performing electroporation with multiple needle electrodes and can be used for detection of cell membrane electroporation and for pulse delivery control. Recently these changes were used for regulating the output voltage for *in vivo* gene transfection (Cukjati et al. 2007). One of the major problems with respect to conductivity measurements *in vivo* is the inhomogeneous distribution of current density and electric field due to inhomogeneous and anisotropic properties of the tissue. For successful tissue electroporation, anatomically based mathematical models are important tools for prediction of the outcome of the treatment (Miklavčič et al. 1998; Šemrov and Miklavčič 1998; Brandinsky and Daskalov 1999; Miklavčič et al. 2000; Šel et al. 2007; Miklavčič et al. 2006a).

In brief, in this section the differences between single-cell and tissue electroporation are described. Single-cell electroporation is a suitable tool for study of basic electroporation mechanisms. The situation is more complex in tissues as they are composed of cells that are in close contact with each other and their proximity affect electroporation. Besides, most tissues are not homogenous structures, they are composed of different cell types that are irregularly shaped, are vascularized, and have different electrical properties that affect current density and electric field distribution, all of these affecting electroporation effectiveness. Mathematical models are thus a valuable tool for predicting electroporation behavior of the tissue.

## 4 Electrodes/Shaping the Electric Field

Electroporation is used for different purposes and depending on the application one should choose the right electrodes to obtain the desired result.

For different applications, different types of electrodes are available and can be classified according to their geometry into different groups: plate, needle, wire, and tweezers electrodes (Miklavčič and Puc 2006b). In certain cases, special electrodes are needed; for example, for individual-cell electroporation, specially designed microelectrodes are required (Lundqvist et al. 1998; Ryttsen et al. 2000; Olofsson et al. 2003). For treatment of large volumes of sample and for flow electroporation,

electroporation chambers that allow efficient treatment were designed and successfully tested. They were successfully used for gene transfection or water treatment (Stopper et al. 1987; Teissié and Conte 1988a; Teissié and Rols 1988b; Rols et al. 1992b; Li et al. 2002; Teissié et al. 2002). The choice of most suitable electrodes for a given application depends also on the characteristics of the treated sample (Miklavčič et al. 2006b).

For reversible electroporation used in medicine, electrode design have to allow efficient electroporation and at the same time cause as little cell damage of the surrounding tissue as possible. In *in vivo* electroporation, electrical properties of the treated tissue have to be taken into account, as they vary significantly among different tissues. In electroporation, mathematical models taking into account the tissue conductivity changes can be very useful for proper electrode selection and their positioning with respect to the tissue that needs to be electroporated (Pavšelj et al. 2005b; Šel et al. 2005, 2007), since the electric field distribution can be efficiently modified by electrode geometry and their position during the pulse application (Šel et al. 2005, 2007).

Irreversible electroporation, used in water sterilization and food preservation, where large volumes need to be treated and high electric fields need to be applied, requires different methodologies (Teissié et al. 2002). For flow electroporation, it is crucial that the pulse delivery frequency is linked to the flow rate in such a way that each cell that passes electroporation chamber receives electric pulse treatment. Liquid flow during electroporation affects causes cell elongation therefore electric field orientation with respect to cell is important (Fig. 6) (Teissié et al. 2002).

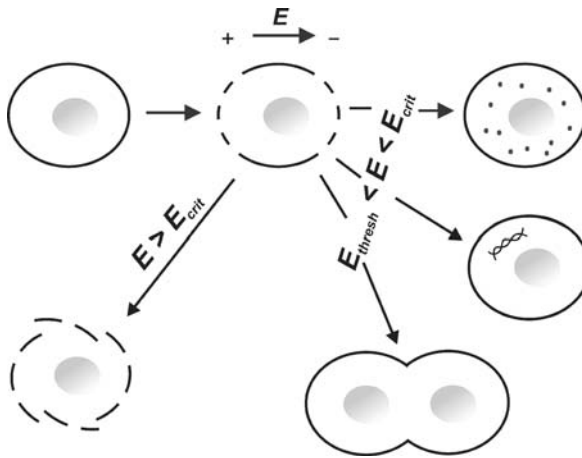
In brief, in this section, electrode type and effects of electrode shape and positioning on electroporation effectiveness are described. The choice of proper electrode shape and their position during the pulse application is crucial for successful treatment, as they affect the electric field distribution. The most appropriate electrode type and positioning depends on the application.

## 5 Different Applications

Various applications of electroporation have already been proposed, ranging from gene electrotransfer in biotechnology, biology, and medicine to cell killing in water sterilization, food preservation, and tissue ablation (Fig. 7) (Miklavčič et al. 2006b). These electroporation-based technologies and treatments require proper selection and choice of pulse parameters, electrodes, and pulse generators (Puc et al. 2004). In this section different applications in biology, biotechnology, and medicine are briefly reviewed.

### 5.1 Use in Medicine

In medicine, electroporation is used with the method called electrochemotherapy in clinical practice for improved drug delivery for cancer treatment, and in preclinical



**Fig. 7** Different application of electroporation. When external electric field reaches threshold value ( $E_{\text{thresh}}$ ) cell membrane is electroporated. Small and large molecules can be introduced into the cell or when two cells are in close contact their membranes can fuse. When external electric field exceeds certain critical value ( $E_{\text{crit}}$ ) irreversible electroporation occurs resulting in cell membrane disintegration and cell death

trails for gene electrotransfer (Serša et al. 1995; Serša et al. 1998; Serša et al. 2003; Heller et al. 1999; Mir and Orlowski 1999; Mir 2000). From the point of view of medical applications, it is more convenient to use a high-repetition pulse frequency rather than 1 Hz pulse repetition, which is currently used in clinical trials. This is important when larger tumor nodules need to be treated and when multiple needle electrodes are used. In that case, a large number of pulses need to be delivered to each of the pairs of the electrodes, which would represent an unpleasant and a relatively long treatment time, if pulses were delivered at 1 Hz repetition frequency. The application of pulses with higher repetition frequency does not significantly affect the electrochemotherapy efficiency and the treatment is less unpleasant than application of pulses with standard 1 Hz repetition frequency (Miklavčič et al. 2005; Županič et al. 2007).

At the *in vivo* level, tissue vascular lock is observed due to disruption of blood vessel network after the application of high-voltage pulses. Consequently, the tissue oxygenation level is reduced by electroporation resulting in enhanced tumor cell death (Serša et al. 1999; Čemaar et al. 2001; Serša et al. 2002; Gehl et al. 2002; Kanthou et al. 2006).

## 5.2 Water Sterilization and Food Preservation

Irreversible electroporation is used in food technology for liquid food sterilization, food preservation, and water treatment as a tool for efficient cell killing (Graškova et al. 1996; Danfelter et al. 1998; Lebovka and Vorobiev 2004), which

is important for nonthermal food preservation and for freshwater treatment (Gould 1995; Lebovka et al. 2002; Lebovka and Vorobiev 2004; Teissié et al. 2002).

The benefit of nonthermal food preservation is the maintenance of food quality (Zhang et al. 1995; Ade-Omowaye et al. 2001). The design of static and flow chambers for liquid food pasteurization by electroporation has to take into account sufficient electric field strength and treatment times (Zhang et al. 1995). For efficient use of irreversible electroporation in food industry, identification of optimal parameters is crucial (Angersbach et al. 2000, Lebovka et al. 2000, 2002). In some cases, irreversible electroporation is combined with other treatments for superior results. For example, inactivation of *Escherichia coli* was obtained by combination of electroporation and high-temperature treatment. For efficient liquid food sterilization, a apparatus was developed, which combines thermal, high pressure, and electric pulse treatment. The main advantage of the system is that it is not only effective for inactivation of vegetative cells but it efficiently eradicates even spores (Uemura and Isobe 2002). As yet, irreversible electroporation treatment alone is effective for inactivation of vegetative microorganisms; its effectiveness is not sufficient for the inactivation of their spores (Gould 1995).

Similarly, as for food preservation, the combination of irreversible electroporation and other established methods is used for freshwater treatment. Such a combination was applied for electroporation-assisted water chlorination, which was efficient for elimination of *Giardia muris* (Haas and Atrualiye 1999). Further, synergistic effect of electroporation and photodynamic treatment was reported. Such combined treatment reduced the time needed for efficient cell elimination as compared with photodynamic treatment alone (Wang et al. 1998; Zhou et al. 2000).

### **5.3 Electroporation of Bacteria and Yeast**

Gene electrotransfer of bacteria provides an important methodology for the improvement of microorganisms used in food and pharmaceutical industry. Electroporation is used as an efficient transformation technique for gram-positive and gram-negative bacteria (Chassy et al. 1988; Dower et al. 1988; Fiedler and Wirth 1988; Tryfona and Bustard 2005). Mechanisms of gene electrotransfer were studied extensively, among which surface binding and diffusion through electropores, effective electric pulse parameters, and the effect of DNA topology on transformation efficiency were investigated (Xie et al. 1990; Xie and Tsong 1992; Xie et al. 1992).

The optimal temperature for bacterial gene electrotransfer depends on the strain used. For slow-growing mycobacteria, elevated temperatures markedly increases electrotransformation efficiency. On the contrary, for fast-growing strains the highest transformation is achieved at low temperatures (Wards and Collins 1996). Furthermore, different bacterial culture conditions were reported for optimal electrotransformation of *Corynebacterium*. In some species of *Corynebacterium*, cultivation at suboptimal temperature conditions and heat shock following electric pulse application significantly increased gene electrotransfer. The heat shock effect contributed to the inactivation of the restriction system present in bacteria, as it was observed only

with xenogenic DNA, where the restriction system inhibits DNA expression (Van der Rest et al. 1999). Optimization of technical conditions for gene electrotransfer in bacteria is crucial for successful use in industry (Kim et al. 2005; Mason et al. 2005). Among the most important factors for improved gene electrotransfer of bacteria is the disruption of the cell wall, which presents an obstacle for macromolecular uptake by the cell. Optimization of electric pulse parameters and the choice of the compatibility of foreign and endogenous plasmids is also required (Kim et al. 2005). Optimization of conditions for gene electrotransfer is not only species and strain specific, it also depends on the environmental conditions, from which bacteria was isolated (Mason et al. 2005).

The complexity of cell wall and cell shape of given bacterial strain determines the optimal parameters for efficient gene electrotransfer to bacteria. The optimal field strength is usually lower for gram-positive bacteria, rod-like bacilli, and cocci, and higher for gram-negative bacteria (Dower et al. 1992). Rod-like cells orient with the long axis in the direction of the electric field (Neumann 1992). Electroporation of rod-like bacteria was thus described as a multistep process in which orientation of the rod in the electric field plays an important role. When the rod is parallel to the electric field, the effective electroporation takes place at lower pulse amplitudes as compared to non-oriented one. The pulse duration must thus be sufficient for effective orientation and successful electroporation (Eynard et al. 1997; Eynard et al. 1998).

Similar to bacteria, the yeast species have a cell wall that interferes with the transport of molecules to the cell. Macromolecules are trapped in the yeast cell wall (Ganeva et al. 1995). At the same time the cell wall also presents a barrier for macromolecule release from the cell. Different yeasts species belonging to *Saccharomyces* taceae family are used in biotechnology as a cell factory due to their ability to produce desired proteins (Meilhoc et al. 1990). When electroporation is used for macromolecular release, besides cell membrane alteration produced by electric pulses, the cell wall alterations were proposed as mechanism responsible for macromolecule release from the cell interior (Ganeva et al. 2003, 2004; Suga et al. 2007). This statement, however, is not in agreement with other authors who assume that the cell wall, at least in plant species, is not altered by electric pulse application (Joersbo and Brunstedt 1991).

#### ***5.4 Plant Protoplast Electroporation***

Electroporation can be used as an efficient method for transfer of foreign genes into plant protoplasts of monocotyledons and dicotyledons (Fromm et al. 1985). In case of gene electrotransfer, the range of plants is not limited by pathogen host specificity as in the case of gene transfer by *Agrobacterium tumefaciens*. Besides, large amounts of protoplasts can be transformed at the same time (Saunders et al. 1989).

Gene electrotransfer of plant protoplasts was successfully applied for transformation of several crop species such as maize, rice, wheat, sorghum, soybean, and rye (Fromm et al. 1986; Lee et al. 1986; Christou et al. 1987; Pitt et al. 1997;

Quecini et al. 2002). Cell viability preservation is crucial for production of transgenic plants, as transformed protoplast should maintain the ability of normal organogenesis. Conflicting reports about electrotransfected plant protoplast regeneration ability are found in the literature. Some authors reported increased cell division, plant regeneration, and DNA synthesis in protoplast transformed by electroporation (Rech et al. 1987; Rech et al. 1988; Chand et al. 1988; Ochatt et al. 1988; Joersbo et al. 1991), while others found slower plant regeneration of electrotransfected protoplasts (Quecini et al. 2002). In some studies, increasing electric field strength and the number of pulses decreased plant protoplast viability and plating efficiency. Nevertheless, the regeneration of plantlets was stimulated (Mordhorst and Lorz 1992).

Electroporation can be successfully used for production and extraction of plant metabolites from cell culture. Plant cell suspension cultures can be used for large-scale production of many plant secondary metabolites, such as different alkaloids (Kutney 1982; Yang and Bayraktar 2003, Ladygin 2004; Vanisree et al. 2004). One of the advantages of such production of secondary metabolites is that they are extractable from the cell culture. When plant cell culture is combined with efficient cell transfection methods, it can provide constant levels of desired metabolite production and therefore an important source for plant secondary metabolites (Vanisree et al. 2004). Electroporation is a suitable technique for such applications as it is applicable to different species and suitable for continuous production of desired product. It is important to note that cell viability and cell biosynthetic capabilities are not affected by the treatment when electroporation parameters are chosen properly (Yang et al. 2003).

Another important application of electroporation in plant protoplast is electrofusion that allows production of hybrid plant cells. As an effective field strength for cell fusion depends on the cell diameter, the amplitude needed for protoplast fusion is much lower than for animal or bacterial cells, as protoplast diameter is much larger than that of animal or bacterial cells. However, the method presents its limitations as hybrid cells obtained from electrofusion are mainly genetically unstable and present multiple ploidy levels (Saunders et al. 1989).

### ***5.5 Transfection of Intact Plant Tissue***

The limitations related to electrotransfected protoplast regeneration are overcome by gene electrotransfer in the intact plant cells. Even though the cell wall represents a barrier, osmotic shock pretreatment that provokes plasmolysis can be used to create a passage of molecules through the cell wall (D'Halluin et al. 1992; Ganeva et al. 1995; Sabri et al. 1996a; Eynard et al. 1997; Wu and Feng 1999).

Reactive oxidative species are produced in response to oxidative stress in mammalian and plant cells exposed to electric pulses (Biedinger et al. 1990; Gabriel and Teissié 1995a, Maccarrone et al. 1995; Sabri et al. 1996b, 1998). Even if the cell viability is not directly correlated with reactive oxidative species production, gene

electrotransfer efficiency is improved by post-pulse treatment with antioxidants, which protect the cell from reactive oxidative species (Sabri et al. 1996; Sabri et al. 1998).

Electroporation is an alternative method for plant transformation. It is, however, still not widely used due to its low efficiency. Although it was effective in some species, such as maize (D'Halluin et al. 1992), a much lower efficiency was obtained in other species, such as wheat (Walden and Wingender 1995; Rakoczy-Trojanowska 2002). In some cases, gene electrotransfer in wheat was successful and electrotransfected explants were able to regenerate plants via somatic embryogenesis; however, the transformation was transient (He and Lazzeri 1998). The production of fertile transgenic wheat plants via tissue electroporation still depends on the quality of plant material used (Sorokin et al. 2000). The stable electrotransformation procedure as an alternative method for *Triticaceae* family crop species (wheat) transformation is still in development. Fully fertile plants that expressed transgenes and transmitted them to progeny were obtained from tritordeum, fertile amphiploid derived from durum wheat and wild barley, by tissue electroporation (He et al. 2001). Barley transfected by tissue electroporation resulted in stable genetic transformation (Gurel and Gozukirmizi 2000).

In brief, in this section different applications of electroporation were described. The method is successfully used in medicine in clinical practice as electrochemotherapy. Preclinical trials for gene electrotransfer are progressing and irreversible electroporation has a potential as a new surgical method for tissue ablation. Besides, irreversible electroporation is used for water sterilization and food preservation. In biotechnology gene electrotransfer is successfully used for improvement of microorganisms used in food and pharmaceutical industry. Gene electrotransfer is also used as efficient tool for manipulation of yeast cells and their ability to produce desired proteins. On the other hand, plant protoplast gene electrotransfer and electrofusion is used to obtain transgenic plants while plant cell cultures serve as bioreactors to produce desired secondary metabolites of economical interest. For production of transgenic plants, limitations associated to electroporated/fused protoplast regeneration are overcome by gene electrotransfer into intact plant tissue. The method has already been used successfully for some economically important species while for others the transfection efficiency and transformation stability is still not sufficient for wider use and needs further improvements.

## 6 Understanding Electroporation of Different Cell Types

Electroporation can be successfully used for different cell types although they differ in their electroporation behavior. While part of the differences can be attributed to the differences in cell size and shape, already mentioned before, some differences are related to biological characteristics of the treated cell (O'Hare et al. 1989; Rols and Teissié 1992a; Rouan et al. 1991; Čemaar et al. 1998; Čegovnik and Novaković 2004; Kandušer et al. 2006). Among such biological factors that affect

cell membrane electroporation are membrane fluidity, cell cytoskeleton, and cell wall in bacteria, yeast, and plant cells.

### ***6.1 Influence of Cell Membrane Fluidity***

Cell membrane fluidity is a physical characteristic of biological membrane that changes with membrane composition and temperature. The content of cholesterol and the ratio between saturated and unsaturated fatty acids that are part of the membrane lipids determine cell membrane fluidity. It can be altered by chemical compounds that integrate into the membrane bilayer or by rapid temperature changes. On the other hand, slow environmental temperature changes cause changes in membrane composition in bacteria, yeast, and plant cells, as these organisms regulate their membrane fluidity in response to environmental factors.

It was reported that membrane fluidity affects the electroporation response of a cell exposed to electric pulses. Two conflicting findings on membrane fluidity effect on electroporation were reported. On the one hand, at physiological temperature less fluid membranes are permeabilized at lower voltages than the more fluid ones (Rols et al. 1990c; Kandušer et al. 2006). On the other hand, the effect of cell membrane fluidity on electroporation is just the opposite when membrane fluidity is altered by chilling. Different responses are found in different cell types. Low temperature had almost no effect on erythrocyte electroporation (Kinosita and Tsong 1979). In alga *Valonia*, rye leaf protoplast, porcine stratum corneum, and in our recent study on mammalian cell lines, exposure of cells to low temperature has as a consequent increase in a voltage required for successful electroporation (Coster and Zimmermann 1975; Pitt et al. 1997; Gallo et al. 2002; Kandušer, Šentjurc, Miklavčič, 2008). These temperature effects on electroporation were attributed to the lipid fluidity change produced by lower temperature (Gallo et al. 2002). Probably more than overall lipid fluidity changes, the membrane domain structure is responsible for the observed differences in electroporation behavior. Besides, the temperature probably affects electroporation by other means not only by cell membrane fluidity alterations.

Membrane fluidity is probably also involved in cell membrane electrofusion. It was reported that the membrane fluidity could be an important factor affecting molecular rearrangements in the electroporated cell membrane responsible for the cell fusion (Dimitrov and Sowers 1990). Moreover, in biological membrane fusion, the process depends on properties of the membrane lipid bilayer. It was shown that biological fusion is altered by changes in membrane lipid composition (Chernomordik et al. 1995). In addition, in electrofusion the presence of anesthetic agents or polylysine, substances that affect cell membrane fluidity, also affect cell fusion (Grobner et al. 1996; Velizarov et al. 1998b). It was also reported that in bacteria different temperature and culture conditions that affect membrane lipid composition and fluidity affect efficiency of gene electrotransfer (Wards and Collins 1996; Van der Rest et al. 1999). The effect of membrane fluidity on efficiency of gene electrotransfer was also observed in plant cells (Wu and Feng 1999).



## 6.2 Influence of Cell Cytoskeleton

The cell cytoskeleton is a very dynamic structure, which is composed of actin filaments, microtubules, and intermediate filaments. It is responsible for cell shape maintenance and mobility (Janmey 1995). As the cell cytoskeleton interacts with cell membranes, it is expected that it also affects cell membrane electroporation.

Tubulin, which is a main component of microtubules, was found to play an important role in electroporation and electrofusion (Blangero et al. 1989; Rols and Teissié 1992a; Teissié et al. 1994; Kanthou et al. 2006). The experiments in which cell cytoskeleton was disrupted by chemical agents showed that the first two phases of electroporation, pore formation and expansion, are not affected by cytoskeleton integrity. On the contrary, the third phase of the electroporation process, cell membrane resealing is dramatically affected. In cells with disrupted cytoskeleton, cell membrane resealing is significantly faster than in intact cells. Similar results were obtained when erythrocytes cytoskeleton was disrupted by heat treatment or when cells in the phase of mitosis, when tubulin cytoskeleton is rearranged in mitotic spindle were electroporated (Rols and Teissié. 1992a; Teissié et al. 1994).

The effect of electroporation on cell cytoskeleton was studied in different cell types, and its disorganization was observed during cell electrofusion (Blangero et al. 1989; Wu and Feng 1999; Rols and Teissié 1992a; Harkin and Hay 1996; Teissié et al. 1998; Kanthou et al. 2006). In some cases, tubulin and vimentin intermediate filaments disruption was dependent on the composition of electroporation media. In media with similar ionic composition as cytoplasm, the cell cytoskeleton disruption was prevented (Harkin and Hay 1996). Disruption of cell cytoskeleton is observed immediately after electroporation and recovery took place in 1 hour after the pulse application. Although electroporation interferes with the organization cytoskeleton filaments, it does not result in degradation of cytoskeletal proteins (Kanthou et al. 2006).

## 6.3 Influence of Cell Wall in Bacteria, Yeast, and Plants

The cell wall chemical composition varies from bacteria, to yeast, to plant cells. The bacterial cell wall is composed of cross-lined peptidoglycans and polysaccharides; nevertheless, its composition varies in different types of bacteria. Cell walls of bacteria present additional surface structures such as capsules, slimes, S layers, and sheals (Beveridge and Graham 1991; Schaffer and Messner 2005). In yeast species, the chemical composition of cell walls varies with species and is composed, in case of *Saccharomyces cerevisiae*, of glucan, manoprotein, and chitin. The main component is glucan that forms a microfibrillar matrix to which other components are bound (Mazan et al. 2006). In plant species the primary cell wall is composed of cross-linked pectines and hemicellulose molecules. The free spaces among molecules that constitute the cell wall are species and tissue specific, ranging from 3.5 to 5.2 nm (Carpita et al. 1979). The cell wall structure is permeable to

small molecules but represents a barrier to large molecules such as DNA or proteins (Wu and Feng 1999).

Regardless of the cell wall chemical composition, it presents a barrier to electrofusion and is a limiting factor for gene electrotransfer. Nevertheless, the cell wall does not affect transport of small molecules. The cell wall does not interfere with electric pulses, which cause electroporation of cell membrane, as only slight differences were obtained when the electroporation of plant protoplast and intact plant cells was compared (Saunders et al. 1995). Small molecules can freely diffuse through the cell wall; therefore, their loading into cytoplasm was not affected significantly by the presence of the cell wall in bacteria, yeasts, or plants. From those results, it was concluded that electroporation of cell membrane on itself is not affected by the presence of the cell wall (Ganeva et al. 1995; Aouida et al. 2003; Saunders et al. 1995).

On the other hand, when large molecules need to be introduced into the cell, such as DNA, for gene electrotransfer of bacteria, transfection efficiency is improved when the cell wall is partially disrupted by chemical agents (Ganeva et al. 1995). It was also reported that electrotransformation of the gram-positive bacteria is less effective than in gram-negative bacteria due to the thicker and denser cell walls in gram-positive species (Dower et al. 1992; Trevors et al. 1992, Kim et al. 2005). A similar situation occurs in yeast species, where a cell wall represents a barrier for introduction of macromolecules into the cell. Observation of fluorescent 70 kDa dextrans during electroporation of yeast revealed that those macromolecules are trapped in the wall. The presence of macromolecules at the cell membrane level was thus reduced and consequently their loading into the cytoplasm was smaller than it would be in a cell without a cell wall (Ganeva et al. 1995). To improve the transport of macromolecules through the cell wall of bacteria, yeast, and plant cells, different pretreatments were suggested. Before electroporation, partial disruption of the cell wall was effective for bacteria and yeast, while for plant cells, pre-pulse plasmolysis was successfully applied (D'Halluin et al. 1992; Ganeva et al. 1995; Sabri et al. 1996a; Eynard et al. 1997; Wu and Feng 1999).

In brief, in this section characteristics of different cell types on electroporation effectiveness are described. Biological characteristics of treated cells such as membrane fluidity, integrity of cytoskeleton, and presence of cell wall in bacteria, yeast, and plant cells affect electroporation. These characteristics need to be taken into account when optimizing electroporation parameters. Besides, for improved loading of macromolecules into the cells with the cell wall, pretreatments that partly disrupt cell wall or cause plasmolysis can be successfully used.

## 7 Conclusions

Electroporation is a useful technique in biotechnology and medicine for introduction of different molecules, electrofusion, or water sterilization and food preservation. Among the different theoretical models that describe electroporation, the transient aqueous pore model is the most widely accepted. This model predicts hydrophilic

pore formation that takes place in a cell membrane as a response to an induced electric field. Electroporation can be reversible or irreversible, depending on the electric pulse parameters used. The effectiveness of electroporation is determined by electric pulse parameters, electroporation medium composition, and its osmotic pressure. Among the electric pulse parameters, pulse amplitude, duration, number, and repetition frequency are most important. Pulse amplitude is a critical parameter as, when it reaches threshold value, it triggers the electroporation process. When electric pulse parameters exceed their optimal values, cell viability is affected and irreversible electroporation takes place. For introduction of small and large molecules, different electric pulse parameters need to be used. Small molecules are efficiently introduced into the cell by application of short electric pulses in range of tens to hundreds of microseconds. The transport of small molecules takes place predominately after the pulse by diffusion. On the other hand, for macromolecules, long 5 to 10  $\mu\text{s}$  pulses with relatively low pulse amplitudes are used. In addition, for successful gene electrotransfer, DNA has to be present in the medium before electric pulses are applied, while small molecules can enter the cell even if added after the pulse is applied. Electric pulse parameters for cell electrofusion are similar to those used for introduction of small molecules, but the threshold voltage required is higher. For irreversible electroporation that is used for inactivation of microorganisms, the electric pulse parameters should exceed critical value as cell death is the desired result of such applications. Electroporation medium composition and its osmolarity affect electroporation and related gene electrotransfer and electrofusion.

The basic mechanisms of electroporation were mainly studied at the single-cell level, although the situation is more complex in a tissue. The tissue is composed of cells that are in close contact with each other and their proximity affects electroporation. In addition, most tissues are not homogenous structures. They are composed of different cell types that are irregularly shaped and have different electrical properties that affect current density and electric field distribution and consequently also electroporation effectiveness. The mathematical models are thus a valuable tool for prediction of electroporation behavior of the tissue. In addition, the electrode type, shape, and positioning affect electroporation effectiveness. The choice of proper electrode type, shape, and positioning is crucial for successful treatment, as it affects the electric field distribution and depends on the application.

Electroporation has many different applications; the method is successfully used in medicine in clinical practice as electrochemotherapy. Preclinical trials for gene electrotransfer are in progress, and recently irreversible electroporation was suggested as a new surgical method for tissue ablation. In addition, irreversible electroporation is used for water sterilization and food preservation. In biotechnology, gene electrotransfer is successfully used for improvement of microorganisms used in food and pharmaceutical industry and for plant cell cultures that produce secondary metabolites. On the other hand, gene electrotransfer in plant protoplast or protoplast electrofusion is used to obtain transgenic plants. Limitations found in protoplast regeneration are overcome by gene electrotransfer into intact plant tissue. The method is successfully used for some important crop species, while for others the

transfection efficiency and transformation stability is still not sufficient for wider use and needs further improvements.

Although electroporation is used in a wide range of different cell types, biological characteristics of the treated cell, such as membrane fluidity, integrity of cytoskeleton, and presence of cell wall in bacteria, yeast, and plant cells, affect its efficiency. Specific characteristics of different cells need to be taken into account when optimizing electroporation parameters. The cell wall that presents a barrier to large molecules loading into the cell can be partly disrupted or cell can be plasmolysed. Such pretreatment improves electroporation effectiveness.

It can be concluded that electroporation can be efficiently used for different applications in biotechnology and medicine if proper conditions are chosen and characteristics of the treated sample are taken into account.

**Acknowledgments** The authors wish to thank mag. Selma Čorović for preparation of the figures, Dr. Alenka Maček-Lebar and Anže Županič for their useful comments. The work was financially supported by Slovenian Research Agency (ARRS).

## References

- Abidor, I.G., Arakelyan, V.B., Chernomordik, L.V., Chizmadzev, Y.A., Pastusenko, V.F. and Tarasevich, M.R. (1979) Electric breakdown of lipid membranes. I. The main experimental facts and their quantitative discussion. *Bioelectrochemistry and Bioenergetics* 6, 37–52.
- Abidor, I.G., Li, L.H. and Hui, S.W. (1994) Studies of cell pellets: II Osmotic properties, electroporation, and related phenomena: membrane interaction. *Biophysical Journal* 67, 427–435.
- Ade-Omowaye, B.I.O., Angersbach, A., Taiwo, K.A. and Knorr, D. (2001) Use of pulsed electric field pretreatment to improve dehydration characteristics of plant based foods. *Trends in Food Science and Technology* 12, 285–295.
- Aouida, M., Tounekti, O., Belhadj, O. and Mir, L.M. (2003) Comparative roles of the cell wall and cell membrane in limiting uptake of xenobiotic molecules by *Saccharomyces cerevisiae*. *Antimicrobial Agents and Chemotherapy* 47, 2012–2014.
- Angersbach, A., Heinz, V. and Knorr, D. (2000) Effects of pulsed electric fields on cell membranes in real food systems. *Innovative Food Sciences and Emerging Technologies* 1, 135–149.
- Andre, F. and Mir, L.M. (2004) DNA electro transfer: its principles and an updated review of its therapeutic applications. *Gene Therapy* 11, S33–S42.
- Anderson, G.L. and Evans, G.A. (1989) Optimization of electroporation for transfection of mammalian cell lines. *Analytical Biochemistry* 180, 269–275.
- Barrau, C., Teissié, J. and Gabriel, B. (2004) Osmotically induced membrane fusion facilitates the triggering of living cell electroporation. *Bioelectrochemistry* 63, 327–332.
- Beveridge, T.J. and Graham L.L. (1991) Surface layers of Bacteria. *Microbiological Reviews* 55, 684–705.
- Beveridge, J.R., MacGregor S.J., Marsili, L., Anderson J.G., Rowan, N.J. and Farish, O. (2002) Comparison of the effectiveness of biphasic and monophasic rectangular pulses for the inactivation of micro-organisms using pulsed electric fields. *IEEE Transactions on Plasma Science* 30, 1525–1531.
- Biedinger, U., Youngman, R.J. and Schnabl, H. (1990) Differential effects of electrofusion and electroporation parameters on the membrane integrity of plant protoplasts. *Planta* 180, 598–602.

- Bilska, A., DeBruin, K.A. and Krassowska, W. (2000) Theoretical modeling of the effects of shock duration, frequency and strength on the degree of electroporation. *Bioelectrochemistry* 51, 133–143.
- Blangero, C., Rols, M.P. and Teissié, J. (1989) Cytoskeletal reorganization during electric field induced fusion of Chinese hamster ovary cells grown in monolayers. *Biochimica et Biophysica Acta* 981, 295–302.
- Brandinsky, K. and Daskalov, I. (1999) Electrical field and current distributions in electrochemotherapy. *Bioelectrochemistry and Bioenergetics* 48, 201–208.
- Bureau, M.F., Ghel, J., Deleuze, V., Mir, L.M. and Scherman, D. (2000) Importance of association between permeabilization and electrophoretic forces for intramuscular DNA electro transfer. *Biochimica et Biophysica Acta* 1474, 353–359.
- Canatella, P.J., Karr, J.F., Petros, J.A. and Prausnitz, M. (2001) Quantitative study of electroporation-mediated molecular uptake and cell viability. *Biophysical Journal* 80, 755–764.
- Canatella, P.J., Black, M.M., Bonnicksen, D.M., McKenna, C. and Prausnitz, M.R. (2004) Tissue electroporation: quantification and analysis of heterogeneous transport in multicellular environments. *Biophysical Journal* 86, 3260–3268.
- Carpita, N., Sabularse, D., Montezinos, D. and Delmer, D.P. (1979) Determination of the pore size of cell walls of living plant cells. *Science* 205, 1144–1147.
- Chang, D.C. and Reese, T.S. (1990) Changes in membrane structure induced by electroporation as revealed by rapid-freezing electron microscopy. *Biophysical Journal* 58, 1–12.
- Chang, D.C., Chassy, B.M., Saunders, J.A. and Sowers, A.E. (1992) *Guide to electroporation and electrofusion*, Academic Press, San Diego.
- Chand, P.K., Ochatt, S.J., Rech, E.L., Power, J.B. and Davey M.R. (1988) Electroporation stimulates plant regeneration from protoplasts of the woody medical species *Solanum dulcamara* L. *Journal of Experimental Botany* 39, 1267–1274.
- Chassy, B.M., Mercenier, A. and Flickinger J. (1988) Transformation of bacteria by electroporation. *Trends in Biotechnology* 6, 303–309.
- Chernomordik, L., Kozlov, M.M. and Zimmerberg (1995). Lipids in biological membrane fusion. *The Journal of Membrane Biology* 146, 1–14.
- Christou, P., Murphy, J.E. and Swain, W.F. (1987). Stable transformation of soyabean by electroporation and root formation from transformed callus. *Proceedings of the National Academy of Sciences USA* 84, 3962–3966.
- Coster, H.G.L. and Zimmermann, U. (1975) The mechanism of electrical breakdown in the membranes of *Valonia utricularis*. *Journal of Membrane Biology* 22, 73–90.
- Cukjati D., Batuskaite D., André F., Miklavčič D. and Mir L.M. (2007) Real time electroporation control for accurate and safe *in vivo* non-viral gene therapy. *Bioelectrochemistry* 70, 501–507.
- Čegovnik, U. and Novaković, S. (2004) Setting optimal parameters for *in vivo* electrotransfection of B16F1, SA1, LPB, SCK, L929 and CHO cells using predefined exponentially decaying electric pulses. *Bioelectrochemistry* 62, 73–82.
- Čemažar, M., Jarm, T., Miklavčič, D., Maček-Lebar, A., Ihan, A., Kopitar, N.A., Serša, G. (1998) Effect of electric-field intensity on electroporation and electrosensitivity of various tumor-cell lines *in vitro*. *Electro and Magnetobiology* 17, 263–272.
- Čemažar, M., Parkins, C.S., Holder, A.L., Chaplin, D.J., Tozer, G.M. and Serša G. (2001) Electroporation of human microvascular endothelial cells: evidence for an anti-vascular mechanism of electrochemotherapy. *British Journal of Cancer* 84, 565–570.
- Danfelter, M., Engstrom, P., Persson, B.R.R. and Salford, L.G. (1998) Effect of high voltage pulses on survival of Chinese hamster V79 lung fibroblast cells. *Bioelectrochemistry and Bioenergetics* 47, 97–101.
- Davalos, R.V., Mir, L.M. and Rubinsky, B. (2005) Tissue ablation with irreversible electroporation. *Annals of Biomedical Engineering* 33, 223–231.
- D'Halluin, K., Bonne E., Bossut M., De Beuckeleer M. and Leemans J. (1992) Transgenic maize plants by tissue electroporation. *The Plant Cell* 4, 1495–1505.

- Dimitrov, D.S. and Sowers A.E. (1990) A delay in membrane fusion: lag times observed by fluorescence microscopy of individual fusion events induced by an electric field pulse. *Biochemistry* 29, 8337–8344.
- Djuzenova, C.S., Zimmermann, U., Frank, H., Sukhorukov V.L., Richter, E. and Fuhr, G. (1996) Effect of medium conductivity and composition on the uptake of propidium iodide into electropermeabilized myeloma cells. *Biochimica et Biophysica Acta* 1284, 143–152.
- Dower, W.J., Miller, J.F. and Rasdale C.W. (1988) High efficiency transformation of *E. coli* by high voltage electroporation. *Nucleic Acids Research* 16, 6127–6145.
- Dower, W.J., Chassy, B.M., Trevors, J.T. and Blaschek, H.P. (1992) Protocols for the transformation of bacteria by electroporation. In: D.C. Chang, B.M. Chassy, J.A., Saunders and A.E. Sowers (Eds.), *Guide to Electroporation and Electrofusion*. Academic Press, San Diego, pp. 265–290.
- Edd, J.F., Horowitz, L., Davalos, R.V., Mir, L.M. and Rubinsky, B. (2006) *In vivo* results of a new focal tissue ablation technique: irreversible electroporation. *IEEE Transactions on Biomedical Engineering* 53, 1409–1415.
- Escande-Geraud, M.L., Rols, M.P., Dupont, M.A., Gas, N. and Teissié J. (1988) Reversible plasma membrane ultrastructural changes correlated with electropermeabilization in Chinese hamster ovary cells. *Biochimica et Biophysica Acta* 939, 247–259.
- Eynard, N., Rols, M.P., Ganeva, V., Galutzov, B., Sabri, N. and Teissié J. (1997) Electrotransformation pathways of prokaryotic and eukaryotic cells: recent developments. *Bioelectrochemistry and Bioenergetics* 44, 103–110.
- Eynard, N., Rodríguez, F., Trotard, J. and Teissié J. (1998) Electrooptics studies of *Escherichia coli* electropulsation: orientation, permeabilization and gene transfer. *Biophysical Journal* 75, 2567–2596.
- Faurie, C., Phez, E., Golzio, M., Vossen, C., Lesbordes, J.C. Delteil, C., Teissié, J. and Rols M.P. (2004) Effect of electric field vectoriality on electrically mediated gene delivery in mammalian cells. *Biochimica et Biophysica Acta* 1665, 92–100.
- Faurie, C., Golzio, M., Phez E., Teissié, J. and Rols M.P. (2005) Electric field induced cell membrane permeabilization and gene transfer: theory and experiments. *Engineering in Life Science* 5, 1–7.
- Fear, E.C. and Stuchly, M.A. (1998a) Biological cells with gap junctions in low-frequency electric fields. *IEEE Transactions on Biomedical Engineering* 45, 856–866.
- Fear, E.C. and Stuchly, M.A. (1998b) Modeling assemblies of biological cells exposed to electric fields. *IEEE Transactions on Biomedical Engineering* 45, 1259–1271.
- Ferber, D. (2001) Gene therapy: safer and virus free? *Science* 294, 1638–1642.
- Fiedler, S. and Wirth, R. (1988) Transformation of bacteria with plasmid DNA by electroporation. *Analytical Biochemistry* 170, 38–44.
- Fromm, M.E., Taylor, L.P. and Walbot, V. (1985) Expression of genes transferred into monocot and dicot plant cells by electroporation. *Proceedings of the National Academy of Sciences of the United States of America* 82, 5824–5828.
- Fromm, M.E., Taylor, L.P. and Walbot, V. (1986) Stable transformation of maize after gene transfer by electroporation. *Nature* 319, 791–793.
- Gabriel, B. and Teissié, J. (1995a) Spatial compartmentation and time resolution of photooxidation of a cell membrane probe in electropermeabilized Chinese hamster ovary cells. *European Journal of Biochemistry* 228, 710–718.
- Gabriel, B. and Teissié, J. (1995b) Control by electrical parameters of short and long-term cell death resulting from electropermeabilization of Chinese hamster ovary cells. *Biochimica et Biophysica Acta* 1266, 171–178.
- Gabriel, B. and Teissié, J. (1997) Direct observation in the millisecond time range of fluorescent molecule asymmetrical interaction with the electropermeabilised cell membrane. *Biophysical Journal* 73, 2630–2637.
- Gabriel, B. and Teissié, J. (1999) Time courses of mammalian cell electropermeabilization observed by millisecond imaging of membrane property changes during the pulse *Biophysical Journal* 76, 2158–2165.

- Gallo, S.A., Sen, A., Hensen, M.L. and Hui, S.W. (2002) Temperature dependant electrical and ultrastructural characterizations of porcine skin upon electroporation. *Biophysical Journal* 82, 109–119.
- Ganeva, V., Galutzov, B. and Teissié J. (1995) Electric field mediated loading of macromolecules in intact yeast cells is critically controlled at the wall level. *Biochimica et Biophysica Acta* 1240, 229–236.
- Ganeva, V., Galutzov, B. and Teissié J. (2003) High yield electroextraction of proteins from yeast by flow process. *Analytical Biochemistry* 315, 77–84.
- Ganeva, V., Galutzov, B. and Teissié J. (2004) Flow process for electroextraction of intracellular enzymes from the fission yeast, *Schizosacchomyces pombe*. *Biotechnology Letters* 26, 933–937.
- Gehl, J., Skovsgaard, T. and Mir, L.M. (2002) Vascular reactions *in vivo* electroporation: characterization and consequences for drug and gene delivery. *Biochimica et Biophysica Acta* 1569, 51–58.
- Golzio, M., Mora, M.P., Raynaud, C., Delteil, C., Teissié, J. and Rols M.P. (1998) Control by osmotic pressure of voltage-induced permeabilization and gene transfer in mammalian cells. *Biophysical Journal* 74, 3015–3022.
- Golzio, M., Teissié, J. and Rols M.P. (2002) Direct visualization at the single cell level of electrically mediated gene delivery. *Proceedings of the National Academy of Sciences of the United States of America* 99, 1292–1297.
- Gould, S.W. (1995) Biodeterioration of foods and overview of preservation in the food and dairy industries. *International Biodeterioration and Biodegradation* 37, 267–277.
- Graškova, D., Sigler, K., Jonderova, B. and Plašek, J. (1996) Effect of high-voltage pulses on yeast cells: factors influencing the killing efficiency. *Bioelectrochemistry and bioenergetics* 39, 195–202.
- Grobner, U., Velizarov and S. and Berg, H. (1996) Polylysine supports electrofusion. *Bioelectrochemistry and Bioenergetics* 39, 181–184.
- Gross, D., Loew, L.M. and Webb, W.W. (1986) Optical imaging of cell membrane potential changes induced by applied electric fields. *Biophysical Journal* 50, 339–348.
- Grosse, C. and Schwan, H.P. (1992) Cellular membrane potentials induced by altering fields. *Biophysical Journal* 63, 1632–1642.
- Gurel, F. and Gozukirmizi, N. (2000) Optimization of gene transfer into barley (*Hordeum vulgare* L.) mature embryos by tissue electroporation. *Plant Cell Reports* 19, 787–791.
- Haas, C.N. and Atrualiyé, D.N. (1999) Kinetics of electroporation – assisted chlorination of *Giardia muris*. *Water Research* 33, 1761–1766.
- Harkin, D.G. and Hay, E.D. (1996) Effects of electroporation on the tubulin cytoskeleton and direct migration of corneal fibroblasts cultured within collagen matrices. *Cell Motility and the Cytoskeleton* 35, 345–357.
- Hamilton, W.A. and Sale, A.J.H. (1967) Effects of high electric fields on microorganisms: II. Mechanisms and action of the lethal effect. *Biochimica et Biophysica Acta* 148, 789–800.
- He, G.Y. and Lazzeri P.A. (1998) Analysis and optimization of DNA delivery into wheat scutellum and *Tritodeum* inflorescence explants by tissue electroporation. *Plant Cell* 18, 64–70.
- He, G.Y., Lazzeri P.A. and Cannell M.E. (2001) Fertile transgenic plants obtained from *tritodeum* inflorescences by tissue electroporation. *Plant Cell Reports* 20, 67–72.
- Heller, R., Gibert, R. and Jaroszeski, M. (1999) Clinical application of electrochemotherapy. *Advanced Drug Delivery Reviews* 35, 119–129.
- Hibino, M., Shigemori, M., Itoh, H., Nagayama, K. and Kinoshita, K., (1991) Membrane conductance of an electroporated cell analyzed by submicrosecond imaging of transmembrane potential. *Biophysical Journal* 59, 209–220.
- Hibino, M., Itoh H. and Kinoshita, K. (1993) Time courses of cell electroporation as revealed by submicrosecond imaging of transmembrane potential. *Biophysical Journal* 64, 1789–1800.
- Jaroszeski, M.J., Gilbert, R., Fallon, P.G. and Heller, R. (1994) Mechanically facilitated cell-cell electrofusion. *Biophysical Journal* 67, 1574–1581.

- Janmey, P. (1995) Cell membranes and the cytoskeleton. In: R. Lipowsky and E. Sackmann (Eds.), *Structure and Dynamics of Membranes, Handbook of Biological Physics*. Elsevier, pp. 805–849.
- Joersbo, M. and Brunstedt, J. (1991) Electroporation: mechanism and transient expression, stable transformation and biological effects in plant protoplasts. *Physiologia Plantarum* 81, 256–264.
- Kandušer, M., Šentjerc, M., Miklavčič, D. (2006) Cell membrane fluidity related to electroporation and resealing. *European Biophysics Journal* 35, 196–204.
- Kandušer, M., Šentjerc, M., Miklavčič, D. (2008) The temperature effect during pulse application on cell membrane fluidity and permeabilization. *Bioelectrochemistry* in press.
- Kanthou, C., Kranjc, S., Serša, G., Tozer, G., Županič, A. and Čemaar, M. (2006) The endothelial cytoskeleton as a target of electroporation-based therapies. *Molecular Cancer Therapeutics* 5, 3145–3152.
- Kim, Y.H., Han, K.S., Oh, S., You, S. and Kim S.H. (2005) Optimization of technical conditions for the transformation of *Lactobacillus acidophilus* strains by electroporation. *Journal of Applied Microbiology* 99, 167–174.
- Kinosita, K. and Tsong, T.Y. (1977) Formation and resealing of pores of controlled sizes in human erythrocyte membrane. *Nature* 268, 438–441.
- Kinosita, K. and Tsong, T.Y. (1979) Voltage induced conductance in human erythrocyte membranes. *Biochimica et Biophysica Acta* 554, 479–497.
- Kinosita K., Ashikawa, I., Saita, N., Yoshimura, H., Itoh, H., Nagayama, K. and Ikegami, A. (1988) Electroporation of cell membrane visualized under pulsed-laser fluorescence microscope. *Biophysical Journal* 53, 1015–1019.
- Klenchin, V.A., Sukharev, S.I., Serov, S.M., Chernomordik, L.V. and Chizmadzhev, Y.A. (1991) Electrically induced DNA uptake by cells is a fast process involving DNA electrophoresis. *Biophysical Journal* 60, 804–811.
- Kotnik, T., Bobanovič, F. and Miklavčič, D. (1997) Sensitivity of transmembrane voltage induced by applied electric fields – a theoretical analysis. *Bioelectrochemistry Bioenergetics* 43, 285–291.
- Kotnik, T. and Miklavčič, D. (2000) Analytical description of transmembrane voltage induced by electric fields on spheroidal cells. *Biophysical Journal* 79, 670–679.
- Kotnik, T., Mir, L.M., Flisar, K., Puc, M. and Miklavčič, D. (2001a) Cell membrane electropermeabilization by symmetrical bipolar rectangular pulses. Part I. Increased efficiency of permeabilization. *Bioelectrochemistry* 54, 83–90.
- Kotnik, T., Miklavčič, D. and Mir, L.M. (2001b) Cell membrane electropermeabilization by symmetrical bipolar rectangular pulses. Part II. Reduced electrolytic contamination. *Bioelectrochemistry* 54, 91–95.
- Kutney, J.P. (1982) Studies in plant tissue culture: potential source of clinically important antitumor agents. *Pure and Applied Chemistry* 54, 2523–2536.
- Ladygin, V.G. (2004) Efficient transformation of mutant cells of *Chlamydomonas reinhardtii* by electroporation. *Process Biochemistry* 39, 1685–1691.
- Lebovka, N.I., Bazhal, M.I. and Vorobiev, E. (2000) Simulation and experimental investigation of food material breakage using pulsed electric field treatment. *Journal of Food Engineering* 44, 213–223.
- Lebovka, N.I., Bazhal, M.I. and Vorobiev, E. (2002) Estimation of characteristics damage time of food materials in pulsed-electric fields. *Journal of Food Engineering* 54, 337–346.
- Lebovka, N.I. and Vorobiev, E. (2004) On the origin of the deviation from the first-order kinetics in inactivation of microbial cells by pulsed electric fields. *International Journal of Food Microbiology* 91, 83–89.
- Lee, R.C., River P., Pan, F.S., Ji, L. and Wollmann, R.L. (1992) Surfactant-induced sealing of electropermeabilized skeletal muscle membranes *in vivo*. *Proceedings of the National Academy of Sciences of the United States of America* 89, 4524–4528.
- Lee, R.C. and Dougherty, W. (2003) Electrical injury: mechanisms, manifestations and therapy. *IEEE Transactions on Dielectrics and Electrical Insulation* 10, 810–819.



- Lee, T.M.O., Turgeon, R. and Wu, R. (1986) Expression of a foreign gene linked to either a plant virus or a *Drosophila* promoter, after electroporation of protoplasts of rice, wheat and sorghum. *Proceedings of National Academy Sciences of the United States of America* 83, 6815–6819.
- Leontiadou, H., Mark, A.E. and Marrink, S.J. (2004) Molecular dynamics simulation of hydrophilic pores in lipid bilayers. *Biophysical Journal* 86, 2156–2164.
- Li, L.H., Shivakumar, R., Feller, S., Allen, C., Weiss, J.M., Dzekunov, S., Singh, V., Holaday, J., Fratantoni, J. and Liu, L.N. (2002) High efficient, large volume flow electroporation. *Technology in Cancer Research and Treatment* 1, 341–349.
- Liu, M., Gothe G. and Berg, H. (2000) Electroporation and fusion of human cancer cells modified by amino acids and polypeptides. *Electro and Magnetobiology* 19, 331–338.
- Liu, F., Heston, S., Shollenberger, L.M., Sun, B., Mickle, M., Lovell, M. and Huang L. (2006) Mechanisms of *in vivo* DNA transport into cells by electroporation: electrophoresis across the plasma membrane may not be involved. *The Journal of Gene Medicine* 8, 353–361.
- Loew, L.M. (1992) Voltage-sensitive dyes: Measurements of membrane potentials induced by DC and AC electric fields. *Bioelectromagnetics Supplement* 1, 179–189.
- Lucas, M.L. and Heller R. (2001) Immunomodulation by electrically enhanced delivery of plasmid DNA encoding IL-12 to murine skeletal muscle. *Molecular Therapy* 3, 47–53.
- Lundqvist, J.A., Sahlin, F., Aberg, M., A.L., Stromberg, A. and Erikson, P.S. (1998) Altering the biochemical state of individual cultured cells and organelles with ultramicroelectrodes. *Proceedings of the National Academy of Sciences of the United States of America* 95, 10356–10360.
- Maček-Lebar, A., Kopitar, N.A., Ihan, A., Serša, G. and Miklavčič, D. (1998) Significance of treatment energy in cell electroporation. *Electro. Magnetobiol.* 17, 253–260.
- Maček-Lebar, A. and Miklavčič, D. (2001) Cell electroporation to small molecules *in vitro*: control by pulse parameters. *Radiologica Oncology* 35, 193–202.
- Maccarrone, M., Bladergroen, M.R., Rosato, N. and Agro F. (1995) Role of peroxidation in electroporation induced cell permeability. *Biochemical and Biophysical Research Communications* 209, 417–425.
- Marszalek, P., Liu, D.S. and Tsong, T.Y. (1990) Schwan equation and transmembrane potential induced by altering electric field. *Biophysical Journal* 58, 1053–1058.
- Mason, C.K., Collins, M.A. and Thompson K. (2005) Modified electroporation protocol for *Lactobacilli* isolated from the chicken crop facilitates transformation and the use of a genetic tool. *Journal of Microbial Methods* 60, 353–363.
- Mazan, M., Mazanova, K. and Farkas, V. (2006) Bukova stena hub – Vyzva pre vyskum novych antimykotik, *Chem. Listy* 100, 433–439.
- Meaking, W.S., Edgerton, J., Wharton, C.W. and Meldrum, R.A. (1995) Electroporation-induced damage in mammalian cell DNA. *Biochimica et Biophysica Acta* 1264, 357–362.
- Mehrle, W., Zimmermann, U. and Hampp, R. (1985) Evidence for asymmetrical uptake of fluorescence dyes through electro-permeabilized membranes of *Avena mesophyll* protoplasts. *FEBS Letters* 185, 89–94.
- Meilhoc, E., Masson, J.M. and Teissie, J. (1990) High efficiency transformation of intact yeast cells by electric field pulses. *Biotechnology (N.Y.)* 8, 223–227.
- Miklavčič, D., Beravs, K., Šemrov, D., Čemaar, M., Demšar, F. and Serša, G. (1998) The importance of electric field distribution for effective *in vivo* electroporation of tissues. *Biophysical Journal* 74, 2152–2158.
- Miklavčič, D., Šemrov, D., Mekid, H. and Mir, L.M. (2000) A validated model of *in vivo* electric field distribution in tissues for electrochemotherapy and for DNA electro transfer for gene therapy. *Biochimica et Biophysica Acta* 1519, 73–83.
- Miklavčič, D., Pucihar, G., Pavlovec, M., Ribarič, S., Mali, M., Maček-Lebar, A., Petkovšek, M., Nastran, J., Kranjc, S., Čemaar, M. and Serša, G. (2005) The effect of high frequency electric pulses on muscle contractions and antitumor efficiency *in vivo* for a potential use in clinical electrochemotherapy. *Bioelectrochemistry* 65, 121–128.

- Miklavčič, D., Čorović S, Pucihar, G. and Pavšelj, N. (2006a) Importance of tumour coverage by sufficiently high local electric field for effective electrochemotherapy. *European Journal of Cancer Supplement* 4, 45–51.
- Miklavčič, D. and Puc, M. (2006b) Electroporation. In: *Wiley Encyclopedia of Biomedical Engineering*, John Wiley & Sons, New York., pp. 1–11.
- Miller, L., Leor, J. and Rubinsky, B. (2005) Cancer cell ablation with irreversible electroporation. *Technology in Cancer Research and Treatment* 4, 1–7.
- Mir, L.M. and Orlovski, S. (1999) Mechanisms of electrochemotherapy. *Advanced Drug Delivery* 35, 107–118.
- Mir, L.M. (2000) Therapeutical perspectives of *in vivo* cell electroporation. *Bioelectrochemistry* 53, 1–10.
- Mordhorst, A.P. and Lorz, H. (1992) Electrostimulated regeneration of platelets from protoplasts derived from cell suspensions of barley (*Hordeum vulgare*). *Physiologia Plantarum* 85, 289–294.
- Neumann, E. and Rosenheck K. (1972) Permeability changes induced by electric impulses in vesicular membranes. *Journal of Membrane Biology*. 10, 279–290.
- Neumann, E., Schafer-Ridder, M., Wang, Y. and Holschneider, P.H. (1982) Gene transfer into mouse lymphoma cells by electroporation in high electric fields. *The EMBO Journal* 1, 841–845.
- Neumann, E., Sowers, A.E. and Jordan, C.A. (1989) *Electroporation and electrofusion in cell biology*, Plenum press, New York.
- Neumann, E. (1992) Membrane electroporation and direct gene transfer. *Bioelectrochemistry and Bioenergetics* 28, 247–267.
- Neumann, E., Kakorin, S., Tsoneva, I., Nikolova, B. and Tomov, T. (1996) Calcium mediated DNA adsorption to yeast cells and kinetics of cell transformation by electroporation. *Biophysical Journal* 71, 868–877.
- Neumann, E., Kakorin, S. and Toensing, K. (1999) Fundamentals of electroporative delivery of drugs and genes. *Bioelectrochemistry and Bioenergetics* 48, 3–16.
- Oblak, J., Kriaj, D., Amon, S., Maček-Lebar, A., Miklavčič, D. (2007) Feasibility study for cell electroporation detection and separation by means of dielectrophoresis. *Bioelectrochemistry* 71, 164–171.
- O'Hare, M.J., Ormerod M.G., Imrie P.R., Peacock J.H. and Asche W. (1989) Electroporation and electrosensitivity of different types of mammalian cells. In: E. Neumann, A.E. Sowers and C.A. Jordan (Eds.), *Electroporation and Electrofusion in Cell biology*, Plenum Press, New York, pp. 319–330.
- Ohno-Shosaku, T. and Okada Y., J. (1985) Electric pulse-induced fusion of mouse lymphoma cells: roles of divalent cations and membrane lipid domains. *The Journal of Membrane Biology* 85, 269–280.
- Ochatt, S.J., Rech, E.L., Davey, M.R. and Power, J.B. (1988) Long-term effect of electroporation on enhancement of growth and plant regeneration of colt cherry (*Prunus avium* x *pseudocerasus*) protoplasts. *Plant Cell Reports* 7, 393–395.
- Olofsson, J., Nolkantz, K., Rytsen, F., Lambie, B.A., Weber, S.G., Owar, O. (2003) Single cell electroporation. *Current Opinion in Biotechnology* 14, 29–34.
- Orrenius, S., McConkey, D.J., Bellomo, G. and Nicotera, P. (1989) Role of  $Ca^{2+}$  in toxic cell killing, *TIPS* 10, 281–285.
- Pavlin, M., Pavšelj, N. and Miklavčič, D. (2002) Dependence of induced transmembrane potential on cell density, arrangement, and cell position inside a cell system. *IEEE Transaction on biomedical engineering* 49, 605–612.
- Pavlin, M., Kandušer, M., Reberšek, M., Pucihar, G., Hart, F.X., Madjarević, R. and Miklavčič, D. (2005) Effect of cell electroporation on the conductivity of a cell suspension. *Biophysical Journal* 88, 4378–4390.
- Pavlin, M., Leben, V. and Miklavčič, D. (2007) Electroporation in dense cell suspension – Theoretical and experimental analysis of ion diffusion and cell permeabilization. *Biochimica et Biophysica Acta* 1770, 12–23.

- Pavšelj, N. and Preat, V. (2005a) DNA electro transfer into skin using a combination of one high and one low-voltage pulse. *Journal of Controlled Release* 106, 407–415.
- Pavšelj, N., Bregar, Z., Cukjati, D., Batiuskaite, D., Mir, L.M. and Miklavčič, D. (2005b) The course of tissue permeabilization studied on a mathematical model of subcutaneous tumor in small animals. *IEEE Transactions on Biomedical Engineering* 52, 1373–1381.
- Pitt, R.E., Parks, J.E., Huber, C.S. and Sangree, J.A. (1997) Glycerol permeability of rye protoplasts as affected by temperature and electroporation. *Plant, Cell Tissue and Organ Culture* 50, 215–219.
- Pliquett, U., Gift, E.A. and Weaver, J.C. (1996) Determination of the electric field and anomalous heating caused by exponential pulses with aluminum electrodes in electroporation experiments. *Bioelectrochemistry and Bioenergetics* 39, 39–53.
- Prausnitz, M.R., Lau, B.S., Milano, C.D., Conner, S., Langer, R. and Weaver, J.C. (1993) A quantitative study of electroporation showing a plateau in net molecular transport. *Biophysica Journal* 65, 414–422.
- Prausnitz, M.R., Corbett, J.D., Gimm, J.A., Golan, D.E., Langer, R. and Weaver, J.C. (1995) Millisecond measurement of transport during and after an electroporation pulse. *Biophysica Journal* 68, 1864–1879.
- Prud'homme, G.J., Glinka, Y., Khan, A.S. and Draghia-Akli, R. (2006) Electroporation-enhanced nonviral gene transfer for the prevention or treatment of immunological, endocrine and neoplastic diseases. *Current Gene Therapy* 6, 243–273.
- Puc, M., Kotnik, T., Mir, L.M. and Miklavčič, D. (2003) Quantitative model of small molecules uptake after *in vitro* cell electropermeabilization. *Bioelectrochemistry* 60, 1–10.
- Puc, M., Čorović, S., Flisar, K., Petkovšek, M., Nastran, J., Miklavčič, D. (2004) Techniques of signal generation required for electropermeabilization. *Survey of electropermeabilization devices*. *Bioelectrochemistry* 64, 113–124.
- Pucihar, G., Kotnik, T., Kandušer M. and Miklavčič, D. (2001) The influence of medium conductivity on electropermeabilization and survival of cells *in vitro*. *Bioelectrochemistry* 54, 107–115.
- Pucihar, G., Mir, L.M., Miklavčič, D. (2002) The effect of pulse repetition frequency on the uptake into electropermeabilized cells *in vitro* with possible applications in electrochemotherapy. *Bioelectrochemistry* 57, 167–172.
- Pucihar, G., Kotnik, T., Valič, B. and Miklavčič, D. (2006) Numerical determination of transmembrane voltage induced on irregularly shaped cells, *Annals of Biomedical Engineering* 34, 642–652.
- Pucihar, G., Kotnik, T., Teissié, J. and Miklavčič, D. (2007). Electropermeabilization of dense cell suspensions. *European Biophysics Journal* 36, 173–185.
- Quecini, Y.M., de Oliveira, A.C., Alves, A.C. and Vieira, M.L.C. (2002) Factors influencing electroporation mediated gene transfer to *Stylosanthes guianensis* (Abul.) SW. protoplasts. *Genetics and Molecular Biology* 25, 73–80.
- Rakoczy-Trojanowska, M. (2002) Alternative methods of plant transformation – A short review. *Cellular and Molecular Biology Letters* 7, 849–858.
- Ramos, C. and Teissié, J. (2000a) Electrofusion: a biophysical modification of cell membrane and a mechanism in exocytosis. *Biochimie* 82, 511–518.
- Ramos, C. and Teissié, J. (2000b) Tension-voltage relationship in membrane fusion and its implication in exocytosis. *FEBS Letters* 465, 141–144.
- Reberšek, M., Faurie, C., Kandušer, M., Čorović, S., Teissié, J., Rols M.P., Miklavčič, D. (2007) Electroporator with automatic change of electric field direction improves gene electrotransfer *in vitro*. *Biomedical Engineering OnLine* 6, 25
- Rech, E.L., Ochatt, S.J., Chand, P.K., Davey, M.R., Mulligan, B.J. and Power, J.B. (1988) Electroporation induces DNA synthesis in cultured plant protoplasts. *Biotechnology* 6, 1091–1093.
- Rech, E.L., Ochatt, S.J., Chand, P.K., Power, J.B. and Davey M.E. (1987) Electro-enhancement of division of plant protoplast derived cells. *Protoplasma* 141, 169–176.

- Rols, M.P. and Teissié, J. (1989) Ionic strength modulation of electrically induced permeabilization and associated fusion of mammalian cells. *European Journal of Biochemistry* 179, 109–115.
- Rols, M.P. and Teissié, J. (1990a) Electroporabilization of mammalian cells. Quantitative analysis of the phenomenon. *Biophysical Journal* 58, 1089–1098.
- Rols, M.P. and Teissié, J. (1990b) Modulation of electrically induced permeabilization and fusion of Chinese hamster ovary cells by osmotic pressure. *Biochemistry* 29, 4561–4567.
- Rols, M.P., Dahhou, F., Mishra, K.P. and Teissié, J. (1990c) Control of electric field induced cell membrane permeabilization by membrane order. *Biochemistry* 29, 2960–2966.
- Rols, M.P. and Teissié, J. (1992a) Experimental evidence for the involvement of the cytoskeleton in mammalian cell electroporabilization. *Biochim Biophys Acta* 1111, 45–50.
- Rols, M.P., Coulet D. and Teissié J. (1992b) Highly efficient transfection of mammalian-cells by electric-field pulses – application to large volumes of cell-culture by using a flow system *European Journal of Biochemistry* 206, 115–121.
- Rols, M.P. (2006) Electroporabilization, a physical method for the delivery of therapeutic molecules into cells. *Biochimica et Biophysica Acta* 1758, 423–428.
- Rouan, D., Montane, M.H., Alibert, G. and Teissié J. (1991) Relationship between protoplast size and critical field strength in protoplast electropulsing and application to reliable DNA uptake in *Brassica*. *Plant Cell Reports* 10, 139–143.
- Rubinsky, B., Onik, G. and Mikus, P. (2007) Irreversible electroporation: a new ablation modality-clinical implications. *Technology in Cancer Research and Treatment* 6, 37–48.
- Ryttsen, F., Farre, C., Brennan, C., Weber, S.G., Nolkranz, K., Jardemark, K., Chiu, D. and Orwar, O. (2000) Characterization of single-cell electroporation by using patch-clamp and fluorescence microscopy. *Biophysical Journal* 79, 1993–2001.
- Sabri, N., Pelissier, B. and Teissié J. (1996a) Transient and stable electrotransformation of intact black Mexican sweet maize cells are obtained after preplasmolysis. *Plant Cell Reports* 15, 924–928.
- Sabri, N., Pelissier, B. and Teissié, J. (1996b) Electroporabilization of intact maize cells induces an oxidative stress. *European Journal of Biochemistry* 238, 737–743.
- Sabri, N., Pelissier, B. and Teissié, J. (1998) Ascorbate increases electrotransformation efficiency of intact maize plants. *Analytical Biochemistry* 264, 284–286.
- Sale, A.J.H., and Hamilton W.A. (1967) Effects of high electric fields on microorganisms. I Killing of bacteria and yeast. *Biochimica et Biophysica Acta* 148, 781–788.
- Saunders, J.A., Roskos, L.A., Mischke, S., Aly, M.A.M. and Owens L.D. (1986) Behaviour and viability of tobacco protoplasts in response to electrofusion parameters. *Plant Physiology*. 80, 117–121.
- Saunders, J.A., Matthewas, B.F. and Miller, P.D. (1989) Plant gene transfer using electrofusion and electroporation. In: E. Neumann, A.E. Sowers and C.A. Jordan (Eds.), *Electroporation and Electrofusion in Cell Biology*, Plenum Press, New York, pp. 319–330.
- Saunders, J.A., Lin, C.H., Hou, B.H., Cheng, J., Tsengawa, N., Lin, J.J., Smith, C.R., McIntosh, M.S. and Wert, S.V. (1995) Rapid optimization of electroporation conditions for plant cells, protoplasts, and pollen. *Molecular Biotechnology* 3, 181–190.
- Schaffer, C. and Messner, P. (2005) The structure of secondary cell wall polymers: How Gram-positive bacteria stick their cell walls together. *Microbiology* 151, 643–651.
- Serša, G., Čemaar, M. and Miklavčič, D. (1995) Antitumor effectiveness of electrochemotherapy with cis-diamminedichloroplatinum(II) in mice. *Cancer Research* 55, 3450–3455.
- Serša, G., Čemaar, M., Šemrov, D. and Miklavčič D. (1996) Changing electrode orientation improves the efficacy of electrochemotherapy of solid tumors in mice. *Bioelectrochemistry and Bioenergetics* 39, 61–66.
- Serša, G., Štabuc, B., Čemaar, M., Jančar, B., Miklavčič, D. and Rudolf, Z. (1998) Electrochemotherapy with cisplatin: Potentiation of local cisplatin antitumor effectiveness by application of electric pulses in cancer patients. *European Journal of Cancer* 34, 1213–1218.
- Serša, G., Čemaar, M., Miklavčič, D. and Chaplin, D.J. (1999) Tumor blood flow modifying effect of electrochemotherapy with bleomycin. *Anticancer Research* 19, 4017–4022.

- Serša, G., Krzič, M., Šentjarc, M., Ivanusa T, Beravs, K., Kotnik V., Coer, A., Swartz, J. and Čemaar, M. (2002) Reduced blood flow and oxygenation in SA-1 tumors after electrochemotherapy with cisplatin. *British Journal of Cancer*, 87, 1047–1054.
- Serša, G., Čemaar, M. and Rudolf Z. (2003) Electrochemotherapy: advantages and drawbacks in treatment of cancer patients. *Cancer Therapy* 1, 133–142.
- Somiari, S., Glasspool-Malone, J., Drabick, J., Gilbert, R.A., Heller, R., Jaroszeski, M.J. and Malone, R.W. (2000) Theory and *in vivo* application of electroporative gene delivery. *Molecular Therapy* 2, 178–187.
- Sorokin, A.P., Ke, X.Y., Chen, D.F. and Elliott, N.C. (2000) Production of fertile transgenic plants via tissue electroporation. *Plant Science* 156, 227–233.
- Sukharev, S.I., Klenchin, V.A., Serov, S.M., Chernomordik, L.V. and Chizmadzhev Y.A. (1992) Electroporation and electrophoretic DNA transfer into cells. The effect of DNA interaction with electropores. *Biophysical Journal* 63, 1320–1327.
- Sowers, A.E (1986) A long-lived fusogenic state is induced in erythrocyte ghosts by electric pulses. *J Cell Biol* 102, 1358–1362.
- Suga M., Goto, A. and Hatakeyama, T. (2007) Electrically induced protein release from *Schizosaccharomyces pombe* cells in a hyperosmotic condition during and following a high electropulsation. *Journal of Bioscience and Bioengineering* 103, 298–302.
- Sušil, R., Šemrov, D. and Miklavčič, D. (1998) Electric field induced transmembrane potential depends on cell density and organization. *Electro- and Magnetobiology* 17, 391–399.
- Stenger, D.A. and Hui, S.W. (1986) Kinetics of ultrastructural changes during electrically-induced fusion of human erythrocytes. *The Journal of Membrane Biology* 93, 43–53.
- Stopper, H., Jones, H. and Zimmermann, U. (1987) Large scale transfection of mouse L-cells by electroporabilization. *Biochimica. et Biophysica Acta* 900, 38–44.
- Šatkauskas, S., Bureau, M.F., Puc, M., Mahfoudi, A., Scherman, D., Miklavčič, D. and Mir, L.M. (2002) Mechanisms of *in vivo* DNA electro transfer, Respective contributions of cell electroporabilization and DNA electrophoresis. *Molecular Therapy* 5, 1–8.
- Šatkauskas, S., Andre, F., Bureau, M.F., Scherman, D., Miklavčič, D. and Mir, L.M. (2005) Electrophoretic component of electric pulses determines the efficacy of *in vivo* DNA electro transfer. *Human Gene Therapy* 16, 1194–1201.
- Šel, D., Cukjati, D., Batuskaite, D., Slivnik, T., Mir, L.M. and Miklavčič D. (2005) Sequential finite element model of tissue electroporabilization. *IEEE Transactions on biomedical engineering* 52, 816–827.
- Šel, D., Maček-Lebar, A. and Miklavčič D. (2007) Feasibility of employing model-based optimization of pulse amplitude and electrode distance for effective tumor electroporabilization. *IEEE Transactions on biomedical engineering* 54, 773–781.
- Šemrov, D. and Miklavčič, D. (1998) Calculation of the electrical parameters in electrochemotherapy of solid tumours in mice. *Computers in Biology and Medicine* 28, 439–448.
- Šemrov, D. and Miklavčič, D. (2000) Numerical modeling for *in vivo* electroporation. In: M.J. Jaroszeski, R. Heller and R. Gilbert (Eds.), *Electrochemotherapy, Electrogenetherapy, and Transdermal Drug Delivery, Electrically Mediated Delivery of Molecules to Cells, Methods in Molecular Medicine*, 37, Humana Press, New Jersey, pp. 63–81.
- Teissié, J. (1988) Effects of electric fields and currents on living cells and their potential use in biotechnology: a survey. *Bioelectrochemistry and Bioenergetics* 20, 133–142.
- Teissié, J., Knutson, V.P., Tsong T.Y. and Lane M.D. (1982) Electric pulse-induced fusion of 3T3 cells in monolayer culture. *Science* 216, 537–538.
- Teissié, J., and Rols, M.P. (1986) Fusion of mammalian cells in culture is obtained by creating the contact between cells after their electroporabilization. *Biochemical and Biophysical Research Communications* 140, 258–266.
- Teissié, J. and Conte, P. (1988 a) Electrofusion of large volumes of cells in culture. Part I Anchorage-dependant strains. *Bioelectrochemistry and Bioenergetics* 19, 49–57.
- Teissié, J. and Rols, M.P. (1988 b) Electrofusion of large volumes of cell culture. Part II. Cells growing in suspension. *Bioelectrochemistry and Bioenergetics* 19, 59–66.

- Teissié, J. and Rols, M.P. (1993) An experimental evaluation of the critical potential difference inducing cell membrane electroporation. *Biophysical Journal* 65, 409–413.
- Teissié, J. and Rols, M.P., (1994) Manipulation of the cell cytoskeleton affects the lifetime of cell membrane electroporation. *Annals New York Academy of Sciences USA* 720, 98–109.
- Teissié, J. and Ramos, C. (1998) Correlation between electric field pulse induced long-lived permeabilization and fusogenicity in cell membrane *Biophysical Journal* 74, 1889–1898.
- Teissié, J., Eynard, N., Gabriel, B. and Rols, M.P. (1999) Electroporation of cell membranes. *Advanced Drug Delivery Reviews* 35, 3–19.
- Teissié, J., Eynard, N., Vernhes, M.C., Benichou, A., Ganova, V., Galutzov, B. and Cabanes, P.A. (2002) Recent biotechnological developments of electroporation: A prospective review. *Bioelectrochemistry* 55, 107–112.
- Tekle, Astumian, R.D. and Chock, P.B. (1990) Electro-permeabilization of cell membranes: effect of resting membrane potential. *Biochemical and Biophysical Research Communications* 172, 282–287.
- Tekle, Astumian, R.D. and Chock, P.B. (1991) Electroporation by using bipolar oscillating electric field: and improved method for DNA transfection of NIH 3T3 cells. *Proceedings of the National Academy of Sciences of the United States of America* 88, 4230–4234.
- Trevors, J.T., Chassy, B.M., Dower, W.J. and Blaschek, H.P. 1992 Electrotransformation of bacteria by plasmid DNA. In: D.C.Chang, B.M. Chassy, J.A. Saunders and A.E. Sowers (Eds), *Guide to Electroporation and Electrofusion*, Academic Press, San Diego, pp. 265–290.
- Tryfona, T. and Bustard, M.T. (2005) Enhancement of bimolecular transport by electroporation: A review of theory and potential application to transformation of *Corynebacterium glutamicum*. *Biotechnology and Bioengineering* 93, 413–423.
- Tsong, T.Y. (1991) Electroporation of cell membranes. *Biophysical Journal* 60, 297–306.
- Uemura, K. and Isobe, S. (2002) Developing a new apparatus for inactivating *Escherichia coli* in saline water with high electric field AC. *Journal of Food Engineering* 53, 203–207.
- Valič, B., Golzio, M., Pavlin, M., Schatz, A., Faurie, C., Gabriel, B., Teissié, J., Rols, M.P., and Miklavčič, D. (2003) Effects of electric field induced transmembrane potential on spheroidal cells: theory and experiment. *European Biophysics Journal* 32, 519–528.
- Valič, B., Pavlin, M. and Miklavčič, D. (2004) The effect of resting transmembrane voltage on cell electroporation: a numerical analysis. *Bioelectrochemistry* 63, 311–315.
- Vanisree, M., Lee, C.Y., Lo, S.F., Nalawade, S.M., Lin, C.Y., and Tsay, H.S. (2004) Studies on the production of some important secondary metabolites from medicinal plants by plant tissue cultures. *Bot. Bull. Acad. Sin.* 45, 1–22.
- Van der Rest, M.E., Lange, C. and Molenaar, D. (1999) A heat shock following electroporation induces highly efficient transformation of *Corynebacterium glutamicum* with xenogenic plasmid DNA. *App Microbiol Biotechnol* 52, 541–545.
- Velizarov, S. and Berg, H. (1998a) Electroporation and electrofusion of human lymphoma cells modified by proteolytic enzymes. *Bioelectrochemistry* 46, 263–265,
- Velizarov, S., Reitz, M., Gluck, B. and Berg H. (1998b) Electroporation and electrofusion of human cells modified by anesthetic agents. *Bioelectrochemistry* 47, 89–96.
- Vernhes, M.C., Cabanes, P.A. and Teissié, J. (1999) Chinese hamster ovary cell sensitivity to localized electrical stresses. *Bioelectrochemistry and Bioenergetics* 48, 17–25.
- Vienken, J. and Zimmermann, U. (1985) An improved electrofusion technique for production of mouse hybridoma cells. *FEBS Letters* 182, 278–280.
- Wang, X., Hones, I. and Berg, H. (1998) Uptake of sensitizer by electroporated yeast cells. *Bioelectrochemistry and bioenergetics* 47, 175–177.
- Wards, B.J. and Collins, D.M. (1996) Electroporation at elevated temperatures substantially improves transformation efficiency of slow-growing mycobacteria. *FEMS Microbiology Letters* 145, 101–105.
- Walden, R. and Wingender, R. (1995) Gene transfer and plant regeneration techniques, *TIBTECH* 13, 324–331.

- Weaver, J.C. and Chizmadzhev, Y.A. (1996) Theory of electroporation. *Bioelectrochemistry and Bioenergetics* 41, 135–160.
- Wolf, H., Rols, M.P., Boldt, E., Neumann, E. and Teissié J. (1994) Control by pulse parameters of electric field mediated gene transfer in mammalian cells. *Biophysical Journal* 66, 524–531.
- Wu, F.S. and Feng, T.Y. (1999) Delivery of plasmid DNA into intact plant cells by electroporation of plasmolysed cells. *Plant Cell Reports* 18, 381–386.
- Wu, Y., Montes, J.G. and Sjodin, R.A. (1992) Determination of electric field threshold for electrofusion of erythrocyte ghosts. Comparison of the pulse-first and contact-first protocols. *Biophysical Journal* 61, 810–815.
- Xie, T.D., Sun, L. and Tsong, T.Y. (1990) Study of mechanisms of electric field-induced DNA transfection. I DNA entry by surface binding and diffusion through membrane pores. *Biophysical Journal* 58, 13–19.
- Xie, T.D. and Tsong, T.Y. (1992) Study of mechanisms of electric field-induced DNA transfection. II Electric parameters and other conditions for effective transfection. *Biophysical Journal* 63, 28–34.
- Xie, T.D., Sun, L., Zhao, H.G., Fuchs, J.A. and Tsong, T.Y. (1992) Study of mechanisms of electric field-induced DNA transfection. IV Effects of DNA topology on cell uptake and transfection efficiency. *Biophysical Journal* 63, 1026–1031.
- Xue, G.P., Johnson, J.S. and Dalrymple, B.P. (1999) High osmolarity improves the electrotransformation efficiency of the gram-positive bacteria *Bacillus subtilis* and *Bacillus licheniformis*. *Journal of Microbiological Methods* 34, 183–191.
- Yang, R.Y.K. and Bayraktar, H.T.P. (2003) Plant cell bioreactors with simultaneous electropermeabilization and electrophoresis. *Journal of Biotechnology* 100, 13–22.
- Zaharoff, D.A., Barr, R.C., Li, C.Y. and Yuan, F. (2002) Electromobility of plasmid DNA in tumor tissues during electric field-mediated gene delivery. *Gene Therapy* 9, 1286–1290.
- Zaharoff, D.A. and Yuan, F. (2004) Effects of pulse strength and pulse duration on *in vivo* DNA electromobility. *Bioelectrochemistry* 62, 37–45.
- Zampaglione, I., Arcuri, M., Cappelletti, M., Perretta, G., Nicosia, A., La Monica, N. and Fattori, E. (2005) *In vivo* DNA gene electro-transfer, a systematic analysis of different electrical parameters. *The Journal of Gene Medicine* 7, 1475–1481.
- Zhang, Q., Barosa-Canovas, V. and Swanson, B.G. (1995) Engineering aspects of pulsed electric field pasteurization. *Journal of Food Engineering* 25, 261–281.
- Zhou, A., Liu, M., Baciú, C., Gluck, B. and Berg, H. (2000) Membrane electroporation increases photodynamic effects. *Journal of Electroanalytical Chemistry* 486, 220–224.
- Zimmermann, U. (1982) Electric field-mediated fusion and related electrical phenomena. *Biochimica et Biophysica Acta* 696, 227–277.
- Županič, A., Ribarič, S. and Miklavčič, D. (2007) Increasing the repetition frequency of electric pulse delivery reduces unpleasant sensations that occur in electrochemotherapy. *Neoplasma* 54, 246–250.

# Pulsed-Electric-Fields-Induced Effects in Plant Tissues: Fundamental Aspects and Perspectives of Applications

Eugène Vorobiev and Nikolai Lebovka

**Abstract** The purpose of this contribution is to review the existing approaches to pulsed electric field (PEF) application as a tool for enhancing the processing of plant tissues. The PEF-treatment as a nonthermal method, which allows to preserve the natural quality, color, and vitamin constituents of food products. The numerous laboratory attempts to modernize the optimal PEF application protocols still lack universality. The problem is inherently multidisciplinary and integrates different biological, electrophysical, and chemical processes. The fundamental aspects of electroporation in application to plant tissues, electrically induced damage, optimal power consumption, synergetic effect of combined PEF-thermal treatment, and influence of pulse protocol parameters are presented and critically discussed. The experimental data on PEF-induced acceleration in expression, diffusion, and drying processes are also analyzed.

## 1 Introduction

During the last decade, the pulsed electric field (PEF)-treatment was found to be useful for enhancing the pressing, drying, extraction, and diffusion processes (Barsotti and Cheftel 1998; Angersbach et al. 2000; Vorobiev et al. 2005; Vorobiev and Lebovka 2006). The PEF-treatment has also found application as a minimally invasive method for processing of plant tissues, allowing to avoid many undesirable changes in products, pigments, vitamins, and flavoring agents, which are typical for other pre-treatment techniques, including thermal, chemical and enzymatic ones. Moreover, the PEF-treatment is also promising for purposes of microbial inactivation (Barbosa-Canovas and Vega-Mercado 1996; Toepfl et al. 2007).

The PEF-treatment at moderate electric field strength  $E = 500\text{--}1000$  V/cm and treatment time within  $10^{-4}\text{--}10^{-2}$  s allows to damage tissue effectively without any significant temperature increase (Fincan and Dejmek 2002; Lebovka et al.

---

E. Vorobiev

Department de Génie Chimique, Université de Technologie de Compiègne, Centre de Recherche de Royallieu, B.P. 20529-60205 Compiègne Cedex, France

e-mail: eugene.vorobiev@utc.fr



2002). Efficiency of the PEF-induced damage can be appreciably enhanced by additional thermal treatment (Lebovka et al. 2005a; Lebovka et al. 2007a; Shynkaryk 2007).

A moderate electric field (MEF)-treatment by low-gradient electric fields ( $<100$  V/cm) can also induce tissue damage. The advantages of MEF application have been already discussed in the early works. The MEF-induced enhancement was demonstrated for juice extraction and diffusion (Flaumenbaum 1949; Zagorulko 1958; Katrokha and Kupchik 1984; Gulyi et al. 1994) and for processing of vegetable raw materials, meat, and fish (Kogan 1968; Matov and Reshetko 1968; Rogov and Gorbатов 1974). Recently, also, efficiency of the MEF-induced damage with respect to different materials was demonstrated (Wang and Sastry 2002; Lebovka et al. 2005b). The research efforts were aimed on optimization of the protocols accounting the increase of the product temperature and energy consumption (Praporscic et al. 2006). It was shown that MEF-treatment allows to enhance extraction, expressing, and drying processes for different food materials (Wang and Sastry 2002; Zhong and Lima 2003).

This chapter discusses recent advantages of the PEF-treatment application in processing of plant tissues.

## 2 Electric Field Effects in Plant Tissues

Electric fields (PEF or AC) produce a current through the biological tissue and may result in damage of membranes and volumetric ohmic heating. As a result, a number of different phenomena, such as intracellular liquid release, diffusion of solutes, and membrane resealing processes, develop inside the cellular structure after their treatment. Specific effects like electro-osmotic flow and electrolysis phenomena can be also important.

### 2.1 Origin of Electroporation

The unique property of PEF application is related to selective damage of the biological membranes. An external electric field  $E$  induces a transmembrane potential  $u_m$  on a membrane. When the transmembrane potential exceeds some threshold value (typically about 0.2–1.0 V), electric field cause a temporary loss of semipermeability by the cell membranes (electroporation) or their damage.

The exact mechanism of permeabilization is not precisely understood yet, but it is accepted that electroporation consists of different stages including (Teissié et al. 1999; Teissie et al. 2005; Krassowska and Filev 2007):

- (1) charging and polarization of the membranes (charging time of  $\approx 1 \mu\text{s}$ );
- (2) temporal destabilization and creation of pores (reported as occurring on time scales of 10 ns (Tarek 2005));

- (3) expansion of pore radii and aggregation of different pores (in a time range of 100  $\mu$ s);
- (4) resealing of pores and memory effects (lasting from seconds to hours).

Proposed theories account for pore formation (electroporation), and for electro-mechanical, electrohydrodynamical, viscous-elastic, electrothermal, and electro-osmotic instabilities (Ho and Mittal 1996; Weaver and Chizmadzhev 1996; Chen et al. 2006). Sufficiently strong PEF exposure (high electric fields and long time of treatment) leads to formation of large pores, deformation of membranes, and cell lysis (Pliquett et al. 2007). The other possibilities of cell lysis may be explained by chemical imbalances resulting from the enhanced transmembrane transport (Dimitrov and Sowers 1990) and Joule overheating of the membrane surface (Lebovka et al. 2000b). Reversibility of electroporation is closely related to the pulse protocol, i.e. electric field strength, shape of pulses, pulse duration, and intervals between pulses (Canatella et al. 2001). The PEF application can result in transient or stable electroporation.

### 2.1.1 Transmembrane Potential

For a single spherical cell, the transmembrane potential depends on the angle  $\theta$  between the external field  $E$  direction and the radius vector  $r$  on the membrane surface (Schwan 1957):

$$u_m = 1.5RE \cos \theta (1 - \exp(-t/t_c))f. \quad (1)$$

Here,  $R$  is the cell radius, and the time dependence reflects the membrane capacitance charging processes.

The time constant  $t_c$  is defined as (Pauly and Schwan 1959)

$$t_c = t_c^m / (1 + a), \quad (2)$$

where  $t_c^m = Ch/\sigma_m$ ,  $C$  is the specific capacitance of membrane,  $h$  is its thickness, and  $a = (h\sigma_i/R\sigma_m)/(1+\sigma_i/\sigma_o)$ . Here,  $\sigma_m$ ,  $\sigma_e$ , and  $\sigma_i$  refer to conductivities of the membrane, extracellular medium, and cytoplasm, respectively.

The typical values of  $C = 10^{-2}$  F/m<sup>2</sup>,  $h = 5$ nm and  $\sigma_m = 3 \cdot 10^{-7}$  S/m (Kotnik et al. 1998) give  $t_c^m = 1.7 \cdot 10^{-4}$ s.

The general expression for  $f$  is rather complex (Kotnik et al. 1998), but in the case of  $h\sigma_i/R\sigma_m \gg 1$  (for physiological conditions,  $\sigma_i \approx 3 \cdot 10^{-1}$  S/m, and  $R = 100$   $\mu$ m,  $h\sigma_i/R\sigma_m \approx 50$ ) it can be simplified to:

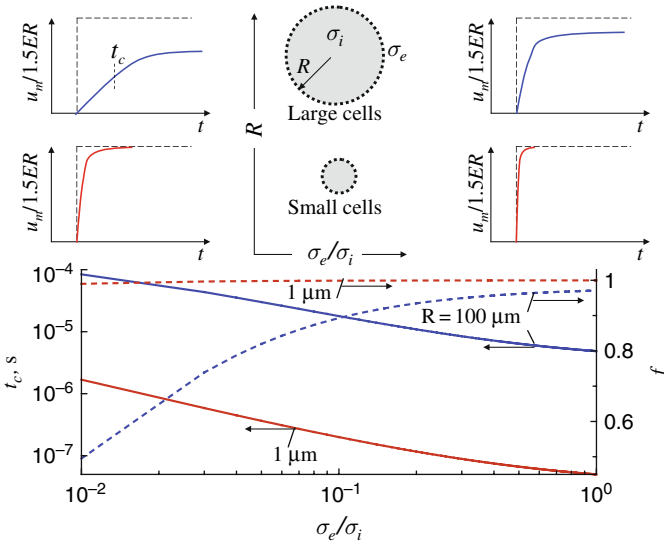
$$f = 1 - 1/a. \quad (3)$$

The steady conditions realized when the pulse duration  $t_p$  is long as compared with the time required to charge up the membrane capacitance. The value of  $u_m$  is proportional to the cell radius  $R$ . The highest drop of potential occurs at the cell

poles, and decreases to 0 at  $\theta = \pm\pi/2$ . So, the larger cells get damaged before the smaller ones, and the damage probability is maximum at the cell poles. The width of a membrane  $h$  ( $\approx 5$  nm) is very small as compared with a plant cell radius  $R$  ( $\approx 100$   $\mu\text{m}$ ). The electric field strength concentrated at the membrane can be estimated as  $E_m = u_m/h \approx ER/h \sim 2 \cdot 10^4 E$ .

In soft plant tissues the cells are rather large  $R$  ( $\approx 100$   $\mu\text{m}$ ) as compared with microbial cells ( $\approx 1$ – $10$   $\mu\text{m}$ ) and induced transmembrane potentials, as well as membrane charging phenomena, can be greatly influenced by the cell radius and  $\sigma_e/\sigma_i$  ratio. An undamaged biological tissue is usually a low-conductivity medium, so, it satisfies the inequality  $\sigma_e/\sigma_i < 1$ . But it can be assumed that  $\sigma_e/\sigma_i$  value increases with increase of the PEF-induced damage, and  $\sigma_e/\sigma_i \approx 1$  in the limit of high tissue disintegration. Figure 1 presents dependences of  $t_c$ ,  $f$  versus  $\sigma_e/\sigma_i$  (a) calculated for different values of cell radius  $R$ . For small cells ( $R = 1$   $\mu\text{m}$ ), the value of  $f$  is close to 1 and the value of  $t_c$  is less than 1  $\mu\text{s}$ . For larger cells like those in cellular tissues, with  $R \approx 100$   $\mu\text{m}$ , the value of  $f$  deviates from 1 and  $t_c$  increases noticeably at small  $\sigma_e/\sigma_i$  values. The scheme at the top of the figure demonstrates that charging of large membrane cells can be greatly influenced by the ratio of  $\sigma_e/\sigma_i$ .

If a cell is nonspherical, the transmembrane potential  $u_m$  becomes more complex function of the cell size and geometry, direction of external field and location on the membrane surface. In steady conditions, the transmembrane potential  $u_m$  in some



**Fig. 1** Dependences of parameters  $t_c$  and  $f$  in Equation (1) versus ratio of the extracellular medium and cytoplasm electrical conductivities  $\sigma_e/\sigma_i$  for different values of cell radius  $R$ . The calculations were done using  $\sigma_i = 3 \cdot 10^{-1}$  S/m (physiological medium). The scheme at the top of the figure demonstrates differences in charging of membranes for small and large cells and for different values of  $\sigma_e/\sigma_i$  ratio

point on the membrane surface  $r(x,y,z)$  may be calculated from the following generalized Schwan equation (Fricke 1953):

$$u_m = \sum_{i=x,y,z} r_i E_i / (1 - L_i). \quad (4)$$

Here,  $L_i$  are the depolarizing factors defined by the cell aspect ratio  $a$  (Landau et al. 1984). For a spherical cell  $L_x = L_y = L_z = 1/3$ , for a long cylinder  $L_x = L_y \approx 0.5$ ,  $L_z \approx 0$ , and for a thin disk  $L_x = L_y \approx 0$ ,  $L_z \approx 1$ . This approximation works for the membranes with negligibly small conductance and its application was extensively discussed in literature (Bernhardt and Pauly 1973; Zimmermann et al. 1974; Kotnik and Miklavcic 2000; Gimsa and Wachner 2001).

### 2.1.2 Stability of Membranes and Cells

In electroporation theory, the lifetime  $\tau_m$  of a membrane can be estimated as (Weaver and Chizmadzhev 1996):

$$\tau_m = \tau_\infty \exp W/kT(1 + (u_m/u_o)^2), \quad (5)$$

where  $W$  is the membrane damage activation energy,  $\tau_\infty$  is a parameter,  $k = 1.381 \cdot 10^{-23}$  J/K is the Boltzmann constant,  $T$  is the absolute temperature, and  $u_o$  is a parameter characterizing the electroporation response of the membrane.

For lipid membranes, the following estimations of parameters were obtained experimentally:  $W \approx 270$  kJ/mol,  $u_o \approx 0.17$  V, and  $\tau_\infty \approx 3.7 \cdot 10^{-7}$  s (Lebedeva 1987); however, these values depend on the structure and composition of membranes in plant cells. For example, for membranes in sugar beet cells the values of  $W \approx 166$  kJ/mol and  $\tau_\infty \approx 10^{-23}$  s were obtained experimentally (Lebovka et al. 2007a).

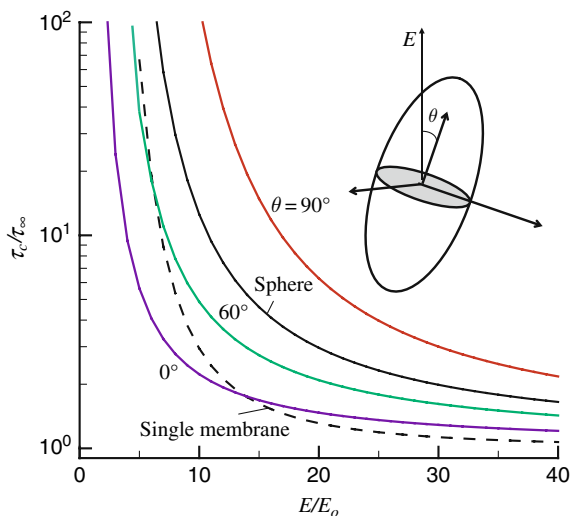
The mean lifetime of a spherical cell  $\tau_c$  may be estimated by averaging of  $\tau_m^{-1}$  over the cell surface. (Lebovka et al. 2002; Lebovka and Vorobiev 2004)

$$\tau_c^{-1} = \int_0^\pi \tau_m^{-1} d \cos \theta / 2, \quad (6)$$

where  $\tau_m$  is determined by Equations (1) and (5).

The lifetime  $\tau_c$  of a spheroid depends also on its orientation in the external field (Lebovka and Vorobiev 2007). For example, the lifetime of a prolate spheroid is minimum for its orientation along the external field  $E$  ( $\theta = 0^\circ$ ) and maximum for its perpendicular ( $\theta = 90^\circ$ ) orientation (Fig. 2).

This result is an accordance with maximum of the transmembrane potential and electropermeabilization for cells oriented by their longest axes in parallel to the external electric field, which was reported for different ellipsoidal microorganisms (Valic et al. 2003; Toepfl et al. 2007; Agarwal et al. 2007).



**Fig. 2** Lifetime  $\tau_c$  of a prolate spheroid versus field strength  $E$  at different angles  $\theta$  between electric field direction and axis of spheroid. Here,  $E_o = 2u_o/3R$ ,  $R$  is the radius of a sphere with the same volume as spheroid,  $a = 10$  is the aspect ratio, and dashed line corresponds to the lifetime of a single membrane (in this case  $E/E_o = u_m/u_o$ ). Numerical calculations were done (Lebovka and Vorobiev 2007) using parameters estimated for lipid membranes (Lebedeva 1987)

## 2.2 Electrically Induced Damage in the Cellular Tissues

In cell suspensions and in biological tissues, electroporation is a complex function of cell orientation and distribution of cell sizes and may be influenced by aggregation of cells, their arrangement, local cell density and solute concentration, and distribution of local electric field (Canatella et al. 2004; Pucihar et al. 2007; Pavlin et al. 2007). Moreover, an external field can affect orientation (Lebovka and Vorobiev 2007) and aggregation of cells (Toepfl 2006) in suspensions. Redistribution of the local fields inside a biological tissue is possible also during the PEF-treatment (Lebovka et al. 2000a; Lebovka et al. 2001).

### 2.2.1 Estimation of the Damage Degree

The damage degree  $P$  can be defined as the ratio of the damaged cells and the total number of cells. The direct estimation of the damage degree can be done through microscopic observation of the PEF-treated tissue (Fincan and Dejmek 2002), but this procedure is not simple and it is ambiguous.

It is possible to estimate the damage degree from diffusion coefficient measurements in the PEF-treated biological materials (Jemai and Vorobiev 2001; Lebovka et al. 2007b)

$$P \approx (D - D_i)/(D_d - D_i), \quad (7)$$

where  $D$  is the measured apparent diffusion coefficient and the subscripts  $i$  and  $d$  refer to the values for intact and totally destroyed material, respectively.

The apparent diffusion coefficient can be determined from solute extraction or convective drying experiments. Unfortunately, diffusion techniques are indirect and invasive for biological objects, and they may impact the structure of the tissue. Moreover, validity of Equation (5) approximation is still controversial (Vorobiev et al. 2005; Lebovka et al. 2007b).

A conventional method of damage degree  $P$  estimation is based on electrical conductivity measurements. The local electrical conductivity is elevated near the damaged cells, and averaged electrical conductivity increases as the damage degree grows. The conductivity disintegration index  $Z$  can be defined as (Rogov and Gorbatov 1974):

$$Z = (\sigma - \sigma_i)/(\sigma_d - \sigma_i), \quad (8)$$

where  $\sigma$  is the electrical conductivity value measured at low frequency (1–5 kHz) and indexes  $i$  and  $d$  refer to the conductivities of intact and totally destroyed cellular system, respectively. This equation gives  $Z = 0$  for the intact tissue and  $Z = 1$  for the totally disintegrated material.

This method is useful for tissues and colloidal biosuspensions (Lebovka et al. 2000a; Vorobiev and Lebovka 2006; El Zakhem et al. 2006a, 2006b). But it requires determination of  $\sigma_d$  from supplementary measurements for maximally damaged material after freeze-thawing or strong PEF-treatment with high strength electric field and long duration of PEF-treatment (Lebovka et al. 2007a).

Another method is based on electrical conductivity measurements at low ( $\approx 1$  kHz) and high (3–50 MHz) frequencies (Angersbach et al. 2002):

$$Z = (k\sigma^o - \sigma_i^o)/(\sigma_i^\infty - \sigma_i^o), \quad (9)$$

where  $k = \sigma_i^\infty/\sigma^\infty$  and the indexes  $o$  and  $\infty$  refer to the low and high conductivity limits, respectively.

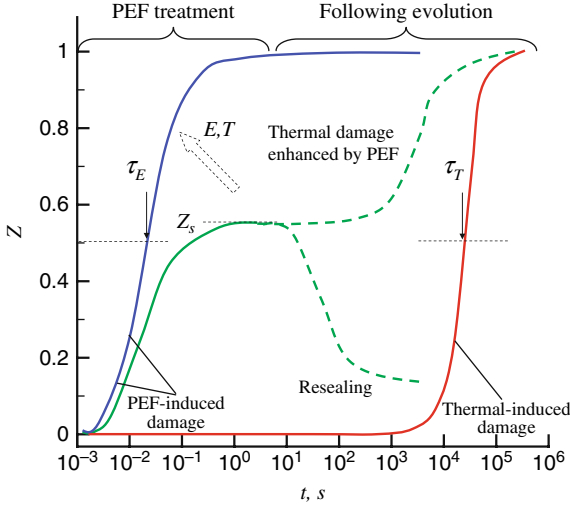
Unfortunately, there exist no exact relation between disintegration index  $Z$  and damage degree  $P$ , though it may be reasonably approximated by empirical Archie's equation (Archie 1942):

$$Z \approx P^m, \quad (10)$$

where exponent  $m$  falls within the range of 1.8–2.5 for biological tissues, such as apple, carrot and potato (Lebovka et al. 2002).

### 2.2.2 Evolution of Damage and Transient Effects

Examples of the time dependence of the conductivity disintegration index  $Z$  are presented schematically in Fig. 3. It is useful to introduce the characteristic damage



**Fig. 3** Evolution of the conductivity disintegration index  $Z$  under the PEF and thermal treatment. Here,  $\tau_E$  and  $\tau_T$  are the electric and thermal characteristic damage times, respectively,  $Z_s$  is the level of disintegration index saturation

time  $\tau$  defined as a time needed for attaining a half of the maximal damage ( $Z \approx 1/2$ ) (Bazhal et al. 2003).

The damage evolution in tissue can be approximated by the following transition function (Bazhal et al. 2003):

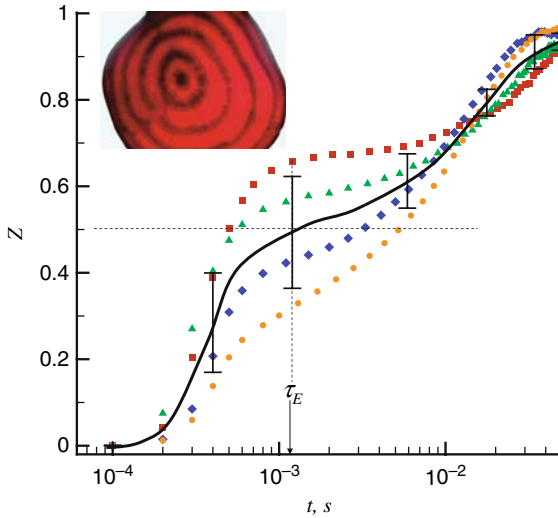
$$Z = [1 + (\tau/t)^k]^{-1}, \quad (11)$$

where  $k$  is an empirical exponent. For damage caused by PEF-treatment, time  $t$  corresponds to the total time of PEF-treatment:  $t = t_{PEF} = nt_p$ , where  $n$  is the number of pulses and  $t_p$  is the pulse duration. It follows from Equation (11) that  $Z = 1/2$  at  $t = \tau$  so, the definition of the characteristic damage time  $\tau$  is evident.

The thermally induced damage requires a long time and is accelerated by the temperature  $T$  increase. The PEF-induced damage depends on the treatment protocol and its rate grows with increase of the electric field strength  $E$  and temperature  $T$  (Lebovka et al. 2005a, 2005b).

At moderate electric fields ( $E < 300$  V/cm) and room temperature, disintegration index  $Z$  may reach plateau at long PEF-treatment. It was experimentally observed that the saturation level  $Z_s$  increased with increase of both  $E$  (Lebovka et al. 2001) and  $T$  (Lebovka et al. 2007a). For example, the maximal disintegration index  $Z_s$  was of the order of 0.75 at  $E = 100$  V/cm for sugar beet tissue (Lebovka et al. 2007a).

The saturation behavior possibly reflects existence of a complex structure and wide spread of the cell geometries and sizes. At higher fields,  $E > 500$  V/cm, the saturation behavior was not observed for tissues with relatively homogeneous structures (potatoes, apples, etc.), and it was possible to attain the maximal disintegration



**Fig. 4** Evolution of the conductivity disintegration index  $Z$  under the PEF-treatment at electric field strength  $E = 400$  V/cm, pulse duration  $t_i = 10$   $\mu$ s, pulse repetition time  $\Delta t = 200$   $\mu$ s. Symbols are for data of four different experiments, solid line corresponds to the mean values, and error bars are the standard deviation

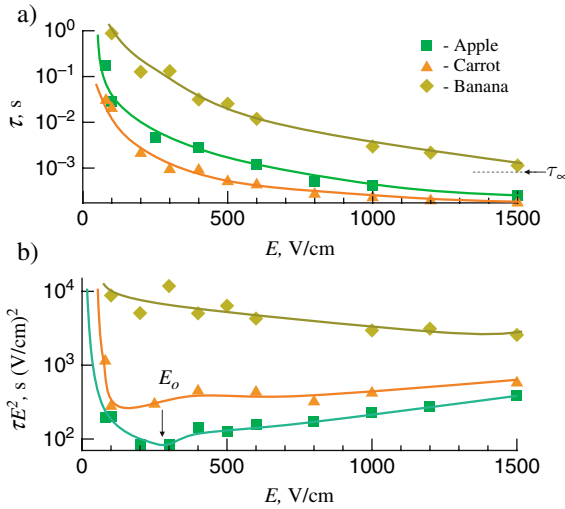
( $Z_s \approx 1$ ) for these materials. But inhomogeneous materials, such as the red beetroot tissues, for example, can display a step-like behavior of the conductivity disintegration index  $Z$  even at higher fields (Fig. 4). These steps evidently reflect existence of different domains in the red beetroot tissues and the presence of the cell survivability distribution (Shynkaryk et al. 2008; Shynkaryk 2007).

If PEF stops at the saturation level (Fig. 3), the scenario of the further evolution can be different. At small level of disintegration, the cells can partially reseal (Knorr et al. 2001). But higher level of disintegration usually results in further increase of  $Z$  after a relatively long time (Lebovka et al. 2001; Angersbach et al. 2002) and acceleration of the thermally induced damage as shown in Fig. 3. The nature of the PEF-induced transient effects is not fully understood yet and requires more thorough study in the future.

### 2.3 Optimal Energy Consumption

Characteristic damage time  $\tau$  depends on the tissue type (Lebovka et al. 2002), which can be explained by cell size differences, membranes nature and constitution, and tissue porosity. Characteristic damage time in the limit of very high fields  $\tau_\infty$  reflects resistance of material to the PEF-treatment (Fig. 5a). The higher is the value of  $\tau_\infty$ , more treatment time is needed to destroy material. For example, the value of  $\tau_\infty$  decreases in the following order: banana  $\rightarrow$  apple  $\rightarrow$  carrot (Bazhal 2001; Bazhal et al. 2003).





**Fig. 5** Characteristic damage time  $\tau$  (a) and product  $\tau E^2$  (b) versus electric field intensity  $E$  for apple, carrot and potato. The PEF-treatment was done at  $T = 20^\circ\text{C}$  (Bazhal 2001; Bazhal et al. 2003)

High disintegration of tissue requires sufficient power consumption, associated with PEF-treatment. The volume density of the energy input  $Q$  during the PEF-treatment is equal to

$$Q = \int_0^t \sigma(t) E^2 dt, \quad (12)$$

where the electrical conductivity of tissue  $\sigma$  increases with time  $t$  owing to damage.

The energy consumption  $Q$  is roughly proportional to the product  $\tau E^2$  (Lebovka et al. 2002). As  $\tau(E)$  decreases with increase of the electric field strength  $E$ , the product  $\tau E^2$  goes through a minimum (Fig. 5b). The optimum value of  $E_o$  at minimum power consumption corresponds to the minimum of the product  $\tau E^2$ .

The further increase of  $E$  results in progressive increase of the energy consumption, but gives no additional increase in the conductivity disintegration index  $Z$ . For vegetable and fruit tissues, the typical values of  $E_o$  lie in the range of  $E = 200\text{--}500$  V/cm (Bazhal et al. 2003).

## 2.4 Synergetics of PEF and Thermal Treatments

Separate application of the PEF processing at a moderate electric field strength ( $E < 100$  V/cm) and at a room temperature, or of the thermal processing at a moderate temperature ( $T < 50^\circ\text{C}$ ) without any electric field, require a long time of (PEF or thermal) treatment, and high energy consumption as a consequence. The

simultaneous PEF and thermal treatment exerts a synergetic effect on the tissue damage (Lebovka et al. 2005a, 2005b, 2007a).

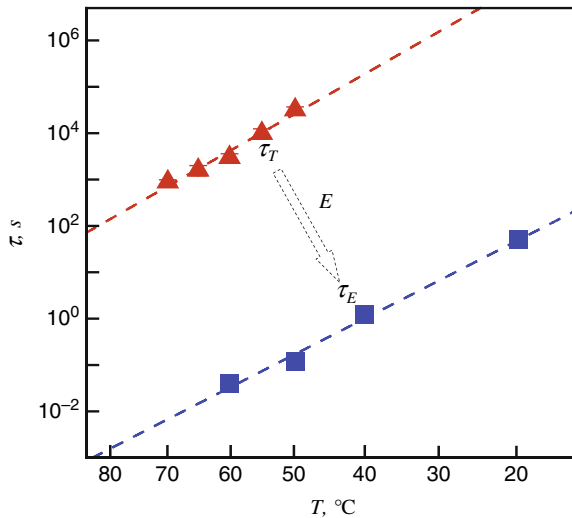
This effect can reflect structural transitions, which are possible inside membranes at elevated temperatures. The tissue membranes consist of different lipids and other species, and their phase transitions are possible within the temperature interval of 20–55°C (Exerova and Nikolova 1992; Mouritsen and Jørgensen 1997). In the vicinity of phase transition softening of the membranes occurs, pores arise more easily, and electroporation can be stimulated at smaller fields. A noticeable drop of the breakdown transmembrane voltage was experimentally observed near the temperature of thermal softening of a single membrane ( $\approx 50^\circ\text{C}$ ) (Zimmermann 1986).

In cellular tissues, the characteristic damage time was dropping by many orders of magnitude (Fig. 6) with increase of temperature  $T$  or electric field strength  $E$  (Lebovka et al. 2007a). Relations between the characteristic damage time  $\tau$  and electric field strength  $E$ , or temperature  $T$ , may be rather complex. The experimental data for potato tissue were fitted successfully by the following equation (Lebovka et al. 2005a):

$$\tau_m = \tau_\infty \exp W/kT(1 + (E/E_0)^2), \quad (13)$$

where  $\tau_\infty$ ,  $W$ , and  $E_0$  are adjustable empirical parameters.

Note that that this equation is mathematically simple and resembles Equation (5) in its form. It has no any fundamental justification based on the mechanisms of electroporation processes in tissues.



**Fig. 6** Temperature dependencies of electric  $\tau_E$  and thermal  $\tau_T$  characteristic damage times for sugarbeet tissue. The PEF-treatment was done at  $E = 100$  V/cm (Lebovka et al. 2007a)

## 2.5 Electroporation during Ohmic Heating

When the current flows through the tissue, the ohmic heating develops. It causes a temperature rise, which can be estimated using the following differential equation:

$$dT/dt = \sigma E^2 / \rho C. \quad (14)$$

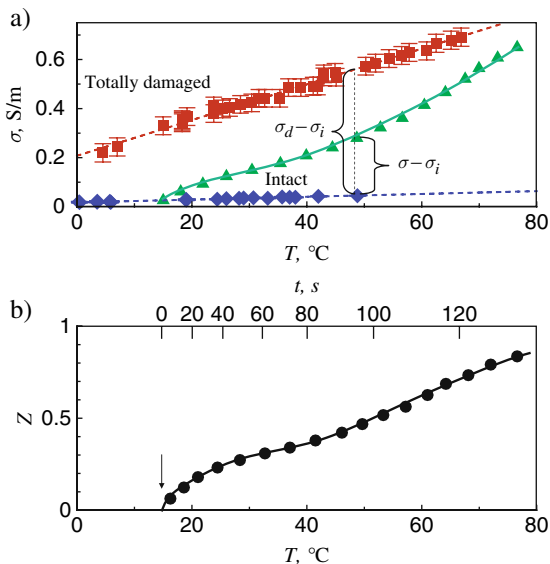
Here,  $\rho$  is the density and  $C$  is the specific heat capacity of tissue; also, adiabatic regime implying very small thermal exchange with environment is assumed.

Direct application of Equation (14) for estimation of the temperature  $T(t)$  evolution in tissues is not simple, because the time  $t$  function of electrical conductivity  $\sigma$  is unknown.

The linear temperature dependencies are typical for electrical conductivity of both damaged and intact tissues (Fig. 7a):

$$\sigma = \sigma_o(1 + \alpha(T - T_o)/(1 + \alpha T_o)), \quad (15)$$

where  $\sigma_o$  is the electrical conductivity at the reference temperature  $T_o$ , and  $\alpha$  is the temperature coefficient of the electrical conductivity.



**Fig. 7** Temperature dependence of electrical conductivity  $\sigma$ (a) and conductivity disintegration index  $Z$ (b) of an ohmically treated sugarbeet tissue at  $E = 60$  V/cm. Dashed lines in (a) show the temperature dependency of conductivities ( $\sigma_d$  and  $\sigma_i$ ) in the totally damaged and intact tissues, respectively. Upper axis in (b) corresponds to the time of treatment  $t$

As an example, for sugarbeet tissue,  $\sigma_{o,i} = 0.018 \pm 0.004$  S/m,  $\alpha_i = 0.036 \pm 0.007/^\circ\text{C}$  for the intact and  $\sigma_{o,d} = 0.21 \pm 0.05$  S/m,  $\alpha_d = 0.035 \pm 0.003/^\circ\text{C}$  for the maximally disintegrated tissue (Lebovka et al. 2007a).

When electrical conductivity is a linear function of temperature, the integration of Equation (14) results in

$$T = T_o + (\exp(\sigma_o E^2 t / C \rho) - 1) / \alpha, \quad (16)$$

Changes in the tissue structure, electrically induced during its ohmic heating, can be essential (Wang and Sastry 2002). The ohmic heating at electric fields  $E$  of the order of 20–80 V/cm induces changes of electroporation nature, as it was observed for potato and apple tissues (Lebovka et al. 2005a, 2005b). So, electrical conductivity may be a complex nonlinear function of time, temperature, electric field strength and damage degree.

The direct monitoring of electroporation changes can be done by experimental measurements of the conductivity evolution during the ohmic heating (Fig. 7a). The conductivity disintegration index can be estimated from Equation (8) using experimentally measured temperature dependencies of the conductivities of intact  $\sigma_i$  and totally damaged  $\sigma_d$  tissues. This procedure is schematically demonstrated in Fig. 7b for sugar beet tissue (Lebovka et al. 2007a)

It seems to be very promising to select a pulse protocol suitable for the PEF-treatment at a moderate electric field and to apply simultaneously the ohmic heating for the same product.

## 2.6 Damage as a Function of Pulse Protocol

Experiments show that application of electrical pulses can exert several different effects on the cell membrane, which depend on various pulse parameters; such as amplitude, shape, duration  $t_p$ , number of repeats  $n$ , and intervals between pulses  $\Delta t$  (Canatella et al. 2001). Also, the relevant parameters are treatment temperature and initial ionic strength. Criteria of optimal protocol selection are not precisely understood yet.

### 2.6.1 Electric Field Strength and Total Treatment Time

Sale and Hamilton (1967) defined the applied electric field strength  $E$  and the total treatment time  $t_{PEF}$  ( $t_{PEF} = nt_i$ ) as the main relevant parameters determining efficiency of the PEF damage. The higher electric field strength leads to better damage efficiency (Canatella et al. 2001; Toepfl et al. 2007), but as it was noticed in Section 2.3, the optimal values of the electric field strength for many vegetable and fruit tissues are within  $E = 300\text{--}500$  V/cm. The time dependence of the disintegration degree may reach plateau at long times of the PEF-treatment by smaller electric fields. Also, the electrical power consumption noticeably increases at a moderate electric field in the range of  $E < 100$  V/cm (Lebovka et al. 2007b). The damage

efficiency clearly correlates also with the total time of treatment  $t_{PEF}$  (Lebovka et al. 2000a), but it is evident that main processing parameters  $E$  and  $t_{PEF}$  do not completely account for the experimentally observed behavior related to PEF-induced effects.

### 2.6.2 Waveforms

The pulse shapes commonly used in PEF generators are exponential decay and square wave. Furthermore, pulse shapes may be either monopolar or bipolar. The square-wave generators are more expensive and require more complex equipment than the exponential decay generators. But square wave generators have better energy performance and demonstrate higher disintegrating efficiency in experiments with microcells inactivation (Zhang et al. 1994).

Bipolar pulses are more advantageous than monopolar ones. Successive monopolar pulses can produce high concentration of the space charge near electrodes due to migration of ions and living cells. Bipolar pulses cause additional stress in the membrane structure and enhance damage efficiency. It was also reported that bipolar pulses offer minimum energy consumption, with reduced deposition of solids on the electrodes and decreased food electrolysis (Chang 1989; Qin et al. 1994; Wouters and Smelt 1997).

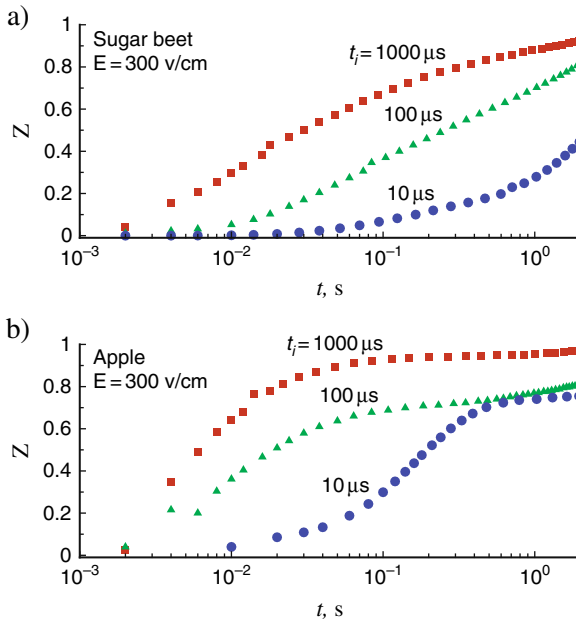
### 2.6.3 Intervals Between Pulses

An interval between pulses  $\Delta t$  was shown to effect the PEF disintegration efficiency of the apple tissue (Lebovka et al. 2001). The protocol with  $\Delta t = 60$  s displayed accelerated kinetics of disintegration in comparison with that of  $\Delta t = 10^{-2}$  s for the fixed total treatment time  $t_{PEF}$ . It was unexpected, because the resealing processes can mask electroporabilization at long time intervals between pulses. The obtained results can be explained accounting for PEF acceleration of the moisture diffusion transfer processes inside the cellular structure. Influence of the pulse delaying time on the inactivation of *E. coli* was reported (Evrendilek and Zhang 2005), but explanation of the observed results is still ambiguous. The further experiments are needed to clarify the effect of interval between pulses on the disintegration efficiency.

### 2.6.4 Pulse Duration

Literature lacks sufficient information regarding the effect of pulse duration on the PEF-induced disintegration of tissues at the fixed total treatment time. Existing works discuss mainly the effects of pulse duration in the PEF inactivation experiments with different microorganisms (Martin-Belloso et al. 1997; Wouters et al. 1999; Raso et al. 2000; Mañas et al. 2000; Aronsson et al. 2001; Abram et al. 2003; Sampedro et al. 2007).

Some authors have demonstrated that inactivation was more efficient at higher pulse width at invariable quantity of the applied energy (Martín-Belloso et al. 1997;



**Fig. 8** Electrical disintegration index  $Z$  of sugar beet (a) and apple (b) tissues versus PEF-treatment time  $t_{PEF}$  at different pulse durations  $t_i = 10, 100, 1000 \mu\text{s}$ . The PEF-treatment was done at  $T = 20^\circ\text{C}$ ,  $E = 300$  V/cm, and  $\Delta t = 100 \mu\text{s}$  (De Vito et al. 2008)

Abram et al. 2003), but others observed little effect of the pulse width on inactivation (Raso et al. 2000; Mañas et al. 2000; Sampedro et al. 2007). The effect of pulse width seems to vary depending on electric field strength; still, the obtained results are controversial (Wouters et al. 1999; Aronsson et al. 2001).

Note that theory predicts deceleration of the membrane charging processes for large cells and for extracellular medium with low electrical conductivity (Kotnik et al. 1998). The membrane charging time  $t_c$  may be rather large,  $t_c \approx 10^{-5} - 10^{-4}$  s, for cellular tissues with large cells (Fig. 1). An efficient PEF-treatment requires long pulse duration  $t_i$  as compared with membrane charging time  $t_c$  in order to reach the maximum transmembrane voltage. At larger values of  $t_c$  the longer pulses will be required for attaining the desired voltage amplitude. So, we can expect higher PEF efficiency for longer pulse width  $t_i$  at invariable total treatment time and other conditions. Experiments clearly showed the effect of pulse duration  $t_i$  (10–1000  $\mu\text{s}$ ) on the efficiency of the PEF-treatment of sugar beet (Fig. 8a) and apple (Fig. 8b) tissues. Longer pulses were more effective, and their effect was particularly pronounced at room temperature and moderate electric fields ( $E = 100 - 300$  V/cm) (De Vito et al. 2008). But general relationships between the PEF-treatment protocols, type and quality of soft tissues, process parameters (temperature, geometry and size of samples, etc.), and the resulting degree of material disintegration are not completely clear and require more thorough study in the future.

### 3 PEF-Enhanced Expression, Diffusion, and Drying

#### 3.1 Solid–Liquid Expression from Food Plants

Extraction by pressing, called also solid–liquid expression is widely used in production of sugar, wine, fruit and vegetable juices (Schwartzberg 1997). Different equipment like screw presses, belt presses, hydraulic presses, or filter-presses, are employed for expression of juices from the raw food materials. The cellular juice is initially enclosed in cells, which have to be ruptured for the expression.

Pressing at a moderate pressure is usually insufficient for the effective rupture of cells. Different pretreatment operations (fine grinding of raw material, heating, and enzyme maceration) assure the cell rupture and intracellular liquid release to facilitate pressing. However, intensive mechanical, thermal, or enzymatic treatment causes plant tissue degradation and juice pollution. A multistage juice clarification is then needed (Albagnac et al. 2002, Van der Poel et al. 1998).

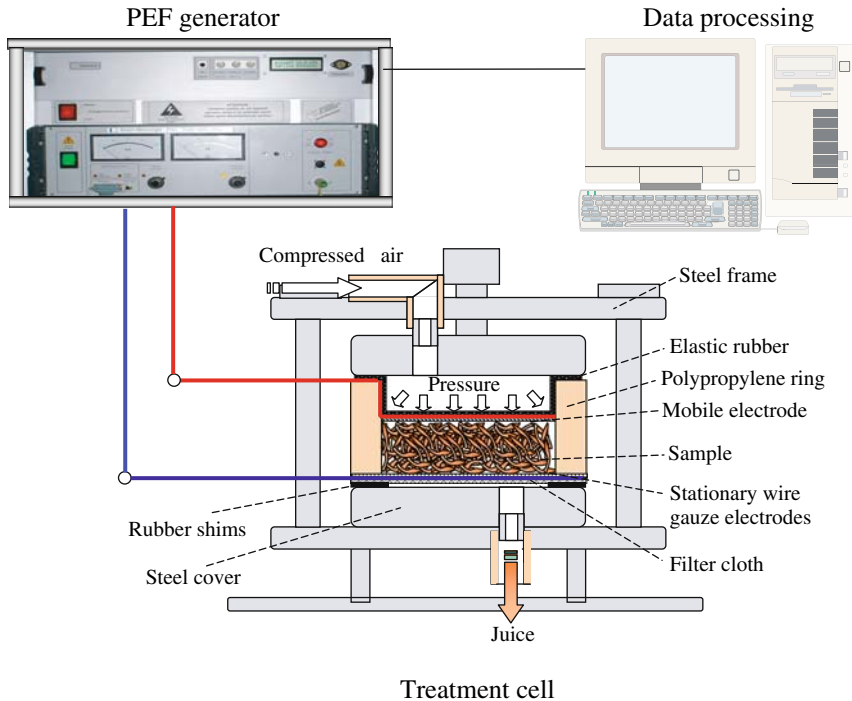
The PEF application as a pretreatment operation before pressing and combination of PEF with pressing allows to increase significantly the juice yield and to obtain products of higher quality (Eshtiaghi and Knorr 1999; Bazhal 2001; Bazhal et al. 2001; Bouzrara 2001; Bouzrara and Vorobiev 2000, 2001, 2003; Jemai and Vorobiev 2002, 2006; Lebovka et al. 2003; Praporscic 2005; Praporscic et al. 2005; Chalermchatand and Dejmek, 2005; Toepfl 2006).

##### 3.1.1 Example of a Laboratory Device for the Combined Pressing and PEF-Treatment

The laboratory device developed in the University of Technology of Compiègne (UTC) (Fig. 9) permits both pretreatment and intermediate treatment by PEF. The treatment cell has a polypropylene frame with a cylindrical cavity compartment (20 mm thick, 56 mm in diameter), which should be initially filled with gratings and then closed from both sides by steel covers. A mobile electrode is attached to the elastic rubber diaphragm. A stationary wire gauze electrode is installed between the filter cloth and the layer of gratings. Both electrodes are connected to the PEF generator, which can provide the monopolar or bipolar pulses of near-rectangular shape. The pulse duration  $t_i$  can be varied within the interval of 10–1000  $\mu\text{s}$ , and the pulse repetition time  $\Delta t$  can be varied within the interval of 1–100 ms. Pulse protocols ( $E$ ,  $t_i$ ,  $\Delta t$ , number of pulses  $n$ ) and all the output data (current, voltage, electrical resistance and actual mass of extracted juice) are collected using a data logger and a special software. The pressure of compressed air is applied to the layer of gratings through the mobile electrode and elastic diaphragm.

##### 3.1.2 Kinetics of Solid–Liquid Expression and Quality of Juices

Eshtiaghi and Knorr (1999), Bouzrara (2001), Bouzrara and Vorobiev (2000, 2001, 2003), Jemai and Vorobiev (2002, 2006), Praporscic et al. (2005) studied the effects



**Fig. 9** Experimental setup

of PEF-pretreatment and intermediate treatment on the efficiency of sugar beet pressing.

Bouzzara and Vorobiev (2001) have studied the pressing of slices obtained by grating a sugar beet root on a 6 mm grater. After initial pressurization of gratings inside the treatment chamber (Fig. 9), the juice yield was about 19.1% at 5 bars. Application of the PEF (500 pulses, pulse duration of 100  $\mu$ s, pulse frequency 100 Hz) markedly enhanced the juice yield, which rises to 43%, 68%, and 79% respectively for voltage gradients of 215 V/cm, 300 V/cm, and 427 V/cm. Initial pressurization of slices serves to assure a good electrical contact between them. Moreover, during pressurization some quantity of released cellular juice is expressed from the treatment chamber. As a result, the quantity of solid-liquid mixture remained in the treatment chamber and to be treated by PEF decreases. Therefore, the intermediate PEF-treatment leads to minimization of the electrical energy consumption. Taking into account the juice yield evolution as a function of both intensity of the PEF and pulse number, Bouzzara and Vorobiev (2001) have demonstrated that the energy input needed for effective intermediate PEF-treatment of the pressurized sugar beet gratings was just 0.6–1 W-hour/kg of raw material. The PEF-pretreatment of coarse gratings unsaturated by the released juice was inhomogeneous and less efficient (Bouzzara and Vorobiev 2000, 2001; Praporscic et al. 2005). In addition to PEF parameters, other factors, such as compressive pressure



(studied in the range of 0.5–10 bars) and size of sugar beet gratings (studied widths: 1.5, 3, 4, 5, 6 and 7 mm, length 5 mm and thickness 1.5 mm) have been reported to have significant effects on efficiency of the expression process (Bouzzara and Vorobiev 2000, 2001; Bouzzara 2001).

Bazhal and Vorobiev (2000) have demonstrated improvement of the juice extraction from Golden Delicious apple slices by solid–liquid expression with an intermediate PEF-treatment. The slices were obtained by grating an apple on a 6-mm grater. The laboratory filter press cell was similar to that presented in Fig. 9. When pressure was varied from 1 to 30 bars, the juice yield after the first pressing increased from 28% to 61%. The maximum juice yield was attained at the energy input of 3 kJ/kg of raw material.

Bouzzara (2001) studied the solid/liquid expression of the carrot gratings at their intermediate PEF-treatment with voltage gradients of  $E = 180, 225, 270$  and  $360$  V/cm,  $t_i = 100$   $\mu$ s and frequency  $f = 100$  Hz. The overall treatment time  $t_{PEF}$  was 5 s. The carrot slices were grated on a 6 mm grater and pressed at 5 bars. An intermediate PEF-treatment permitted to increase the juice yield from 25.6% to 38.3% at 180 V/cm and to 72.4% at 360 V/cm. A threshold of the juice yield was noted for the energy input about of 1.5 Wh/kg of raw material.

Efficacy of the PEF-treatment was also demonstrated for expression of juices from spinach (Bouzzara 2001), haricots, topinambours and red cabbages (Vorobiev et al. 2002), potatoes and onions (Vorobiev et al. 2004), artichokes (Marchal et al. 2004), and grapes (Praporscic et al. 2007a).

The plant tissue conditioning by mild heating at 45–50°C leads to its softening and influences textural properties of foods (apples, carrots, potatoes). Lebovka et al. (2004a, 2004b) has demonstrated that such conditioning enhances expression kinetics. Both thermal and PEF-pretreatments of plant tissue result in increase of the juice yield during its further expression. A combination of these methods clearly demonstrates the synergetic effect (Vorobiev and Lebovka 2006). Ohmic heating (OH) additionally to thermal effect is believed to induce electopermeabilization of the cell membranes (Wang and Sastry 2002). Praporscic et al. (2005, 2006) have compared the effects of moderate OH and PEF-treatments on kinetics of the juice expression from sugar beet gratings. These authors also explored the combined action of the said two treatments. OH accelerates expression kinetics even at mild temperatures (30–50°C). However, only at higher temperature of OH (60°C), the yield of the expressed juice was comparable to that obtained with PEF. A synergetic effect is remarked when the sugar beet tissue was conditioned by OH with further PEF-treatment (Praporscic et al. 2005). However, while the energy consumed by PEF was low (1–5 kW-hour/t of raw material), the OH applied at 40°C during 10 min consumed nearly 40 kW-hour/t of the raw material (Praporscic et al. 2005).

An important advantage of the PEF-treatment is acceleration of the juice expression from coarse particles. It has been demonstrated (Praporscic et al. 2005) that quantity of juice expressed from small ( $1.5 \times 1 \times 35$  mm), middle ( $6 \times 1.5 \times 35$  mm) and coarse ( $7 \times 3 \times 35$  mm) sugar beet gratings differs less importantly with the PEF-treatment than without it. It means that the size of particles subjected to juice expression can be increased with the PEF-treatment without any noticeable impact

on the juice yield. The impact of the particle size on the quantity of expressed sugar juice becomes nearly negligible after conditioning of the tissue by mild heating followed by PEF-treatment (Praporscic et al. 2005).

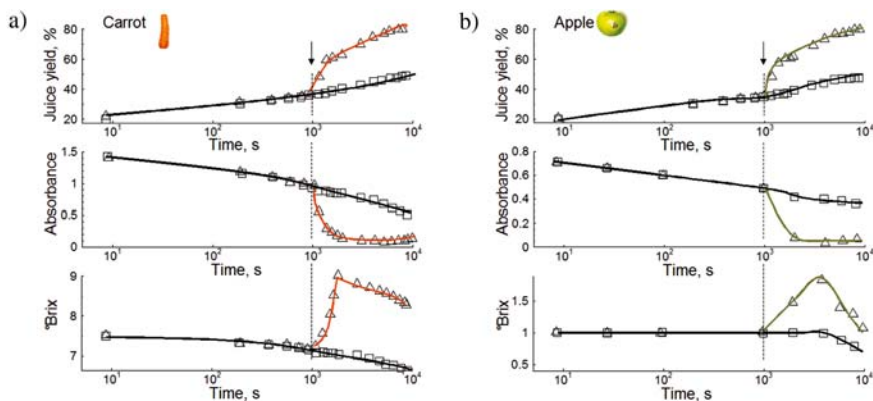
The abovementioned studies were mainly focused on the impact of PEF on the juice yield enhancement, and only few of them investigated the qualitative characteristics of the expressed juices (Bouzzara and Vorobiev 2001, 2003; Vorobiev et al. 2005, Toepfl 2006).

Bouzzara and Vorobiev (2001) compared the physicochemical characteristics of the expressed cold sugar beet juices: after the first pressing (before PEF application) and after the intermediate PEF-treatment followed by second pressing. The second pressing juice after the PEF application was less colored and had higher sugar concentration than the first pressing juice.

Later on, Jemai and Vorobiev (2006) confirmed that cold juices expressed from sugar beet gratings after the intermediate PEF-treatment (second pressing juice) have higher purity values (95~98%) as compared to that after the first pressing (90~93%). Additionally, the quantity of pectin was noticeably lower in the second pressing juice, which facilitates its following purification. The color of the second pressing juice was systematically 3–4 times lower than the color of the first pressing juice and factory juices. Moreover, sugar crystals, obtained after evaporation and crystallization of the PEF-treated juices, were less colored than sugar crystals obtained from the factory juice. The pulp obtained after the PEF-treatment and juice expression contained 3–5 times more  $\alpha$ -amino nitrogen and 2–3 times more sodium and potassium compared to sugar factory pulp (Jemai and Vorobiev 2006). These results showing significant amelioration of the qualitative juice characteristics open new interesting perspectives of a cold PEF-enhanced expression from the sugar beets.

Praporscic et al. (2007b) has studied evolution of the quantitative (juice yield) and qualitative (absorbance, °Brix) characteristics of juices obtained by expression from apple ( $7 \times 3 \times 30$  mm) and carrot ( $1.5 \times 2 \times 30$  mm) slices prepared using the food cutting equipment CL 50 (Robot-Coupe S.N.C., France). The arrows show the time of PEF application (Fig. 10).

As it can be expected, the PEF application results in more pronounced additional expression of juice. The absorbance and °Brix, presented in Fig. 10, are instantaneous values characterizing small portions of the expressed juice at a given mean time of expression  $t$ . These portions were collected in different containers, which were changed every 60 s during the first 1200 s of pressing and every 600 s during the remaining period. The PEF application results in considerable decrease of absorbance immediately after the electrical treatment. Note that the absorbance can increase slightly after  $t > 3\text{--}5 \cdot 10^3$  s. This behavior seems to reflect the effects of color degradation at long time. The juice °Brix value of untreated slices is nearly constant or decreases with expression time increase. The PEF-treatment always results in substantial increase of the juice °Brix value immediately after the electrical treatment. A rather complex behavior of both absorbance and °Brix values reflects a balance between the input and output of juice inside a sample and changes in filtration properties of the press-cake formed from slices during expression. It is not

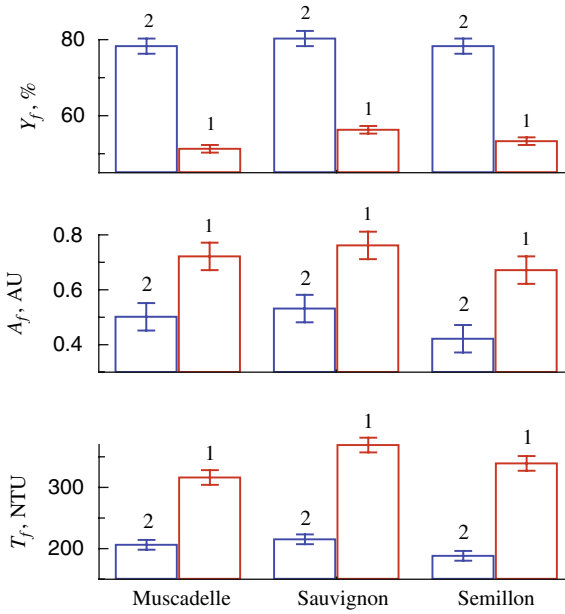


**Fig. 10** Juice yield, absorbance, and °Brix kinetic curves for carrot (a) and apple (b) gratings with intermediate PEF-treatment

surprising that concentration of the solid particles and colored substances in a juice may decrease during the juice filtration through more compacted press-cake. Visually, the expressed juice becomes more transparent and less cloudy during pressing. It can be speculated that °Brix increase after the PEF-treatment (Fig. 10) is related to the release of the intracellular content as a result of the damage of cells.

Recently, Praporscic et al. (2007a) investigated quantitative (juice yield) and qualitative (absorbance and turbidity) characteristics of juices obtained during expression of white grapes (Muscadelle, Sauvignon, and Semillon). The experiments were carried out at expression pressure of 5 bars using laboratory compression chamber equipped with a PEF-treatment system (Fig. 9). The PEF with field strength  $E = 750$  V/cm and the total treatment duration  $t_{PEF} = 0.3$  s was applied. The total expression time was 45 min. Similar to apple and carrot samples, the intermediate PEF application resulted in substantial increase of the juice yield and decrease of the juice absorbance and turbidity. Figure 11 shows data on the final yield  $Y_f$ , absorbance  $A_f$ , and turbidity  $T_f$  of the juices obtained with the PEF-pretreatment (left columns) and without PEF-treatment (right columns). The PEF-treatment results in increase of the final juice yield  $Y_f$  up to 73–78% as compared to  $Y_f \approx 49$ –54% for the untreated grapes; that is, PEF-pretreatment increases the juice yield, approximately, by 25%. A rather noticeable decrease of absorbance  $A_f$  and turbidity  $T_f$  was observed for all the studied white grape varieties as a result of the PEF-treatment. In PEF-pretreatment experiments, the juice absorbance  $A_f$  and turbidity  $T_f$  were lower, but the electrical energy consumption was higher than for the intermediate PEF-treatment (Praporscic et al. 2007a).

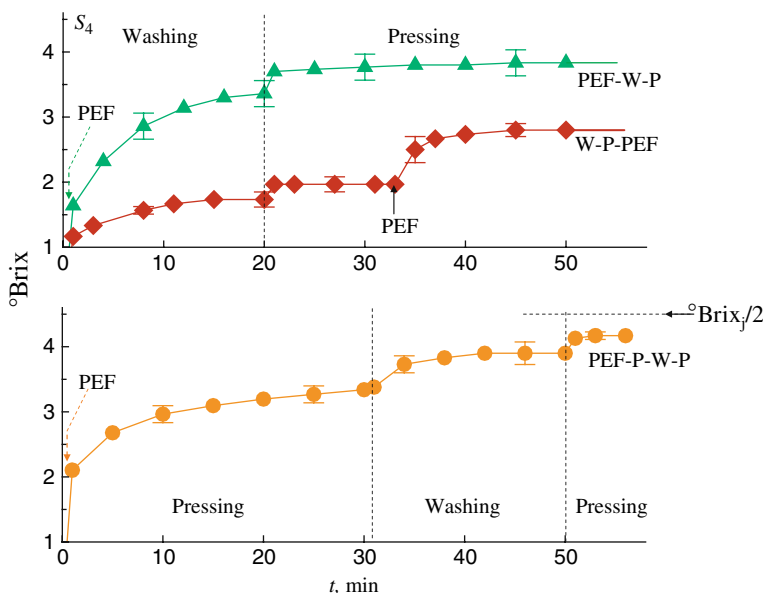
If the valuable components (aromas, colorants, etc.) should be extracted from the food plants, washing, and water diffusion operations are frequently used as supplementary to pressing. The serious limitations of these technologies are related to a necessity to use large quantities of water (the ratio of  $r = (\text{mass of water})/(\text{mass of slices})$  should be larger than 3, as a rule) and long time of washing (more than several



**Fig. 11** Different final characteristics of the expressed juices (juice yield  $Y_f$  (%), absorbance  $A_f$  and turbidity  $T_f$  (NTU)) (1) without PEF and (2) with PEF-pretreatment

hours) (Albagnac et al. 2002). Grimi et al. (2007) studied the PEF-induced effects in juice extraction from the carrot slices using different combinations of pressing and washing operations. The carrot was chosen as a representative vegetable material, which contains both water-soluble (mainly soluble sugars) and non-water-soluble (carotenoids) components. The different cutting degrees varying from mash-like slices  $S_1$  ( $0.078 \times 0.078 \times 2$  mm) and  $S_2$  ( $0.15 \times 0.15 \times 2$  mm) to millimeter-sized slices  $S_3$  ( $1.5 \times 1 \times 20$  mm) and  $S_4$  ( $7 \times 2 \times 30$  mm) were used for finding a relationship between the juice characteristics and applied mode of extraction. Extraction included the PEF-pretreatment followed by the washing–pressing (PEF–W–P mode) or pressing–washing–pressing (PEF–P–W–P mode), and intermediate PEF-treatment after washing during pressing (W–P–PEF mode). The same PEF intensity (500 V/cm) was used in all the experiments. All the PEF-treatments were applied as follows:  $n_t = 2$  trains of  $n = 100$  rectangular pulses, each one lasting  $t_i = 100$   $\mu$ s, with pulse repetition time  $\Delta t = 100$  ms. A pause of  $t_p = 2$  s separated the trains.

This PEF protocol permitted to reach a higher degree of the electrical disintegration index without any substantial temperature increase (it was less than  $2^\circ\text{C}$ ). The experiments were carried out at expression pressure of 5 bars using a laboratory compression chamber equipped with a PEF-treatment system (Fig. 9). The total extraction time (pressing + washing) was approximately 1 hour. Figure 12 compares the evolution of the solution  $^\circ\text{Brix}$  values for PEF–washing–pressing (PEF–W–P), washing–pressing–PEF (W–P–PEF), and PEF–pressing–washing–pressing (PEF–P–W–P) modes of extraction from large slices  $S_4$  at  $r = 1$ . The data shows that



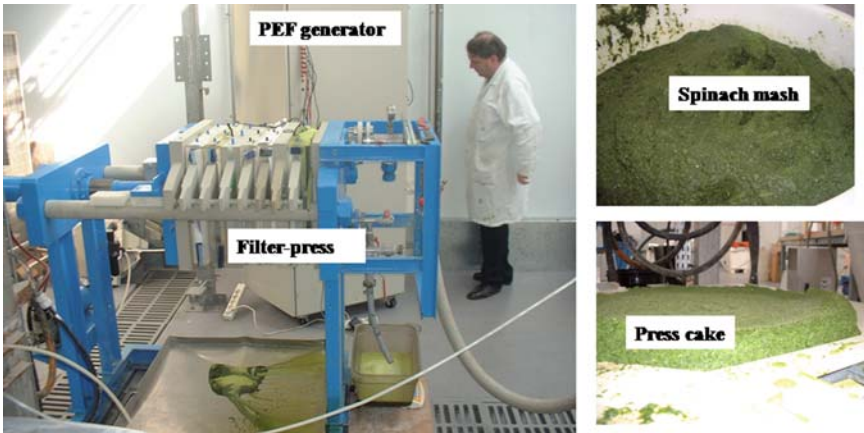
**Fig. 12** °Brix of solution versus time for PEF–washing–pressing (PEF–W–P (▲)), washing–pressing–PEF (W–P–PEF (◆)) and PEF–pressing–washing–pressing (PEF–P–W–P (●)) modes of extraction. The slices were of size  $S_4$ , and the mass of slices was equal to the mass of water ( $r=1$ ). Symbols show the experimental data and lines are drawn for the guidance of eye. Arrows show the time of the PEF-treatment. The error bars represent the standard data deviations

PEF–P–W–P mode of extraction is most efficient and allows to obtain extracts with high final °Brix values, which are comparable with °Brix values of the diluted juice solutions.

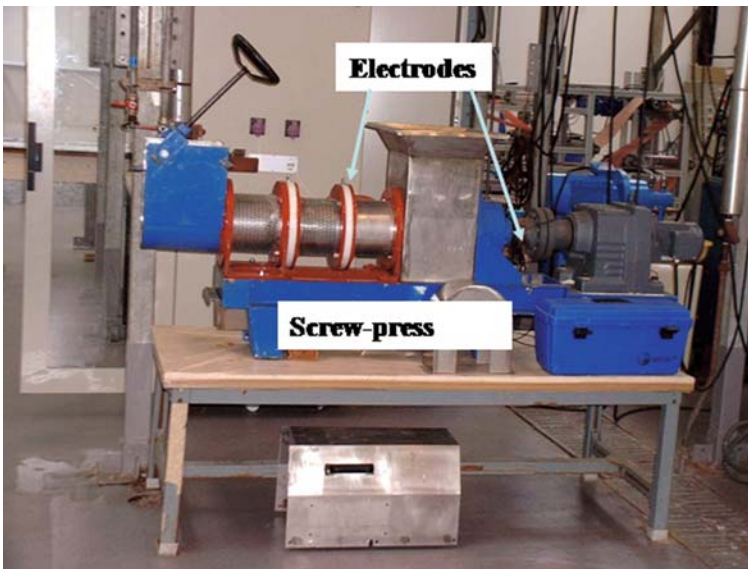
Turbidity of solutions extracted from the PEF-pretreated large slices  $S_4$  was 400–450 NTU, which is significantly lower than turbidity of solutions extracted from fine slices  $S_1$  (1600–1700 NTU). It reflects a low content of the submicron particles in solutions. But PEF-pretreatment requires higher energy consumption as compared with the PEF intermediate treatment (W–P–PEF mode). For the specific case of the carrot, where carotenoids are practically insoluble in water, it can be assumed that their content in the juice is proportional to the level of solid particles in solution. This conclusion was supported by spectrophotometrical data for the juice extracts in cyclohexane (Grimi et al. 2007).

Both washing–pressing (PEF–W–P) and pressing–washing–pressing (PEF–P–W–P) procedures show approximately the same ability for concentration of carotenoids inside the press-cake, though the second procedure releases the water-soluble component inside the juice more efficiently. The considered example of PEF application to extraction from large slices of carrot evidences that it is possible to produce from the press-cake a ‘sugar-free’ concentrate rich in vitamins and carotenoids, which can be used as an additive in diet foods.

Figure 13 shows the photo of pilot filter press CHOQUENET adapted for the pressing-washing operations combined with PEF-treatment. This filter-press is installed in the University of Technology of Compiègne (UTC). Another pilot equipment—the screw press developed in UTC for the combined pressing and PEF-treatment operations—is presented in Fig. 14.



**Fig. 13** The pilot filter press CHOQUENET adapted for the pressing-washing operations combined with PEF-treatment



**Fig. 14** The pilot screw press developed in UTC for the combined pressing and PEF-treatment operations

### 3.2 Aqueous Extraction of Solutes from Food Plants

Solvent extraction from the food plants is an important unit operation in different industrial applications (extraction of sugar, vegetable oils, natural colorants, aromas, and other valuable cell components) (Schwartzberg and Chao 1982). The modern chemical philosophy, known as green chemistry, seeks to avoid the use of dangerous and polluting solvents and encourages the use of eco-friendly solvents like water. However, the plant cells remain undamaged contacting with cold or warm water. Just water heated at least to 65–70°C destroys the cell membranes and permits the soluble matter diffusion from interior of cells. For example, the thermal treatment of beet tissue at 70–74°C is used for sugar diffusion in industrial sugar processing. Unfortunately, such elevated temperatures result in overheating of the cell walls leading to their continuous alteration and to release of polluting substances affecting the purity of juices. Overheating changes the inner chemical structure of cell walls through hydrolytic degradation reactions. For instance, the amount of pectin passing into the juice increases sharply with temperature rise, which complicates considerably the sugar juice purification (Van der Poel et al. 1998).

The PEF-treatment is a suitable alternative for achievement of a nonthermal membrane breakdown permitting cold (warm) aqueous diffusion of valuable plant substances. Recently, several studies dealing with the PEF effect on solute extraction from the food plant tissue were performed (Jemai and Vorobiev 2002, 2003; Fincan et al. 2004; El-Belghiti and Vorobiev 2004, 2005a, 2005b; El-Belghiti 2005; El-Belghiti et al. 2005; Corrales et al. 2008).

#### 3.2.1 Diffusion Kinetics and Qualitative Characteristics of Extracts

Jemai and Vorobiev (2002) compared kinetics of diffusion from the apple discs (Golden delicious) after their thermal denaturation (75°C, 2 min) and after PEF-treatment at different field intensities ( $E = 100\text{--}500$  V/cm) and treatment duration (1000 monopolar rectangular pulses of 50  $\mu\text{s}$ , 100  $\mu\text{s}$ , and 200  $\mu\text{s}$ ). A detectable enhancement of the diffusion kinetics starts at the field intensities of 100–150 V/cm. For thermally treated samples, the temperature variation of the diffusion coefficient  $D$  is of Arrhenius type with two diffusion regimes: (i) without thermal pre-treatment ( $E_a \sim 28$  kJ/mol) and (ii) after thermal denaturation ( $E_a \sim 13$  kJ/mol). Only one regime with intermediate activation energy ( $E_a \sim 20$  kJ/mol) was observed for electrically treated samples.

El-Belghiti and Vorobiev (2005b) investigated the influence of the energy provided by PEF (0–55 kJ/kg) on kinetics of extraction from the carrot slices obtained by grating carrot in a 6 mm grater (1.5 mm thick coarse slices) or in a 2 mm grater (0.5 mm thick fine slices). Diffusion of slices occurred to a limited volume of stirred surrounding water (liquid-to-solid mass ratio  $r = 2$ ) kept at different moderate temperatures (18–35°C). In the absence of PEF-pretreatment, only 45% of solute was obtained from the coarse slices after 8 h of extraction at 18°C. On increase of energy provided by the PEF-pretreatment, the quantity of the extracted solute increased accordingly (up to 90–93%), until the energy threshold (9 kJ/kg)

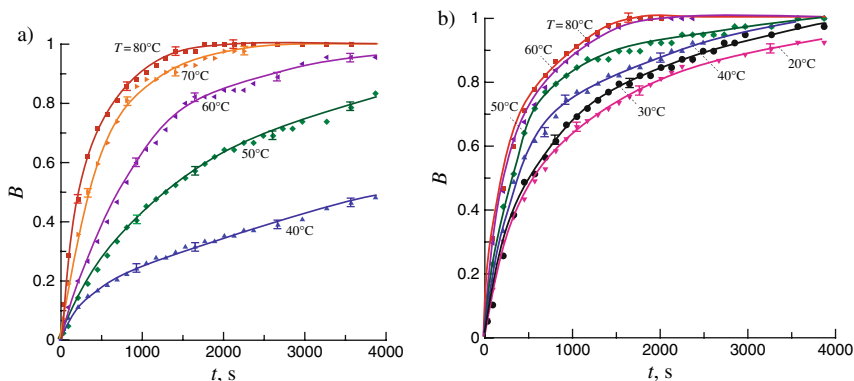
was attained. No further enhancement of the solute yield was observed above this threshold. The energy input of 9 kJ/kg (attained at  $E = 550$  V/cm,  $t_i = 100$   $\mu$ s and  $n = 1000$  pulses) was considered as optimal and was maintained to optimize the diffusion parameters (duration, temperature, and stirring velocity). The results showed that fine and coarse slices had almost the same extraction kinetics after the PEF-treatment. That confirms attractiveness of PEF-treatment especially for the coarse particles.

El-Belghiti and Vorobiev (2005b) El-Belghiti et al. (2005) have studied the influence of the PEF intensity and duration on the static and centrifugal aqueous extraction from coarse sugar beet slices (1.5 mm in thickness) obtained on a 6 mm grater. There was observed a static diffusion of treated and untreated slices to a limited volume of well-stirred surrounding water (liquid to solid mass ratio  $r = 3$ ) kept at different moderate temperatures (25–50°C). The yield of solute was significantly increased with PEF-treatment: it was about 40% for untreated slices and attained 93% after the PEF-treatment ( $E = 670$  V/cm,  $t_{PEF} = 0.025$  s, energy input 5–6 kJ/kg) and 2 hours of extraction at ambient temperature. Majority of the cellular membranes were probably permeabilized at these levels of PEF intensity and duration. Further increase of the PEF intensity up to 800 V/cm was not effective. The temperature elevation to 50°C permitted to accelerate diffusion kinetics and to obtain 93% of solutes after the 40 min of extraction. Centrifugal diffusion of slices was done with the same liquid to solid mass ratio  $r = 3$  and under different centrifugal accelerations (150–9660 g), and temperatures (18–35°C). The extraction kinetics was much faster in the centrifugal field. For instance, the yield of solute after the PEF-treatment reached 97% after 60 min of extraction even at the low centrifugal acceleration (14 g) and at the temperature of 25°C. There was observed existence of an acceleration threshold (150 g) beyond which no further enhancement of extraction occurred. At this centrifugal acceleration, the solute concentration of 97% was reached after 25 min of aqueous extraction at 25°C and just after 15 min of aqueous extraction at 35°C.

Industrial diffusion of sugar from the sugar beets is carried out at the elevated temperatures of 70–74°C with beet tissue preheating at 80–90°C (Van der Poel et al. 1998). Lebovka et al. (2007a) compared kinetics of thermal diffusion and diffusion coefficients for untreated and PEF-treated sugar beet slices. The PEF generator provided the trains of bipolar pulses of near-rectangular shape. Bipolar mode of the PEF-treatment allows to avoid asymmetry of electroporation at the poles of the cells. An individual train consisted of  $n$  pulses with pulse duration  $t_i$  and pulse repetition time  $\Delta t$ . There was a pause of  $\Delta t_i = 30$  s after each train. Owing to the long intertrain pause, the ohmic temperature elevation  $\Delta T$  during one train application was rather small ( $\Delta T \approx 1^\circ\text{C}$ ). Therefore, the system relaxed to the initial temperature during the intertrain period and the PEF-treatment was done practically under isothermal conditions. The total time of electrical treatment during the PEF experiments was calculated as  $t_t = nNt_i$ , where  $N$  is the number of trains. The maximally damaged sugar beet tissues ( $Z \approx 1$ ) were obtained at  $E = 400$  V/cm and  $t_i = 0.1$  s.

Diffusion of the electrically treated and untreated slices (1.5 mm  $\times$  10 mm  $\times$  10 mm) occurred to a limited volume of well-stirred surrounding water (liquid to





**Fig. 15** The normalized Brix of the sugarbeet juice  $B$  versus extraction time  $t$  for the untreated (a) and PEF-pretreated (b) slices at different temperatures. The PEF pretreatment was done at the electric field strength  $E = 400$  V/cm. Error bars are the standard deviation

solid mass ratio  $r = 3$ ) kept at different temperatures (20–80°C). Figure 15 shows data of extraction kinetics at different temperatures ( $T = 30$ –80°C) presented as  $B$  versus time  $t$ , where  $B$  is the normalized °Brix of the sugar beet juice defined as

$$B = \frac{^{\circ}\text{Brix}_f - ^{\circ}\text{Brix}_i}{^{\circ}\text{Brix}_f - ^{\circ}\text{Brix}_i} \quad (17)$$

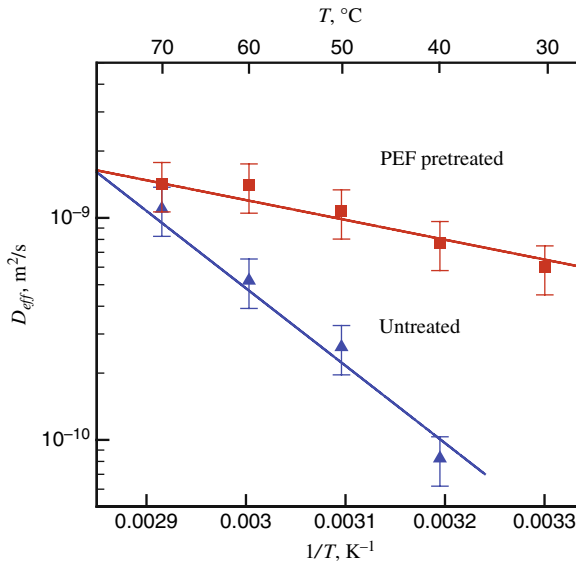
Here,  $^{\circ}\text{Brix}_i$  and  $^{\circ}\text{Brix}_f$  are the initial and the final soluble matter content, respectively. Both temperature increase and PEF-pretreatment accelerated the extraction kinetics (Fig. 15a, b).

For purposes of simplicity, Lebovka et al. (2007a) had assumed that the slices were thin slabs of a uniform thickness, and the Fick's second law solution (Crank 1975) was used for estimation of the effective sugar diffusion coefficient  $D_{eff}$  in a sugar beet:

$$B = 1 - \frac{8}{\pi^2} \sum_{n=0}^{\infty} \frac{1}{(2n+1)^2} \exp\left(-\frac{(2n+1)^2 \pi^2 D_{eff} t}{4h^2}\right) \quad (18)$$

where  $h \approx 1.5$  mm is the thickness of a slab. The first five leading terms of Equation (4) were taken into account for  $D_{eff}$  estimation.

The Arrhenius plots of  $D_{eff}$  are presented in Fig. 16 for untreated and PEF-pretreated sugar beet slices. At 70°C, the values of  $D_{eff}$  were nearly the same for both untreated and PEF-pretreated slices ( $1$ – $1.5 \cdot 10^{-9}$  m<sup>2</sup>/s). The activation energy for the PEF-treated slices was  $W_{E,D} = 21 \pm 2$  kJ mol<sup>-1</sup>, which is close to the activation energy of sugar in the aqueous solutions,  $W_D \approx 22$  kJ/mol (Lysjanskii 1973). The activation energy was noticeably higher,  $W_{T,D} = 75 \pm 5$  kJ/mol, for the untreated



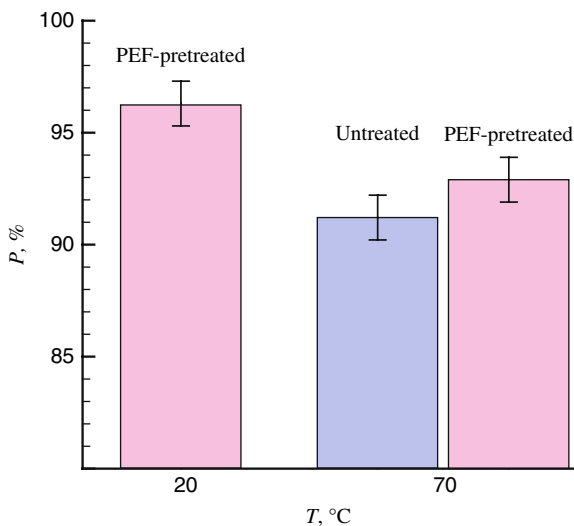
**Fig. 16** The Arrhenius plots of the effective diffusion coefficient  $D_{eff}$  for untreated and PEF-pretreated sugar beet slices. Error bars are the standard deviation

slices, which possibly reflects interrelations of the restricted diffusion and thermally induced damage effects in the untreated sugar beet tissue.

As can be seen from Fig. 16, sugar diffusivity inside the PEF treated tissue remains rather high even at moderate temperatures. For instance, the value of  $D_{eff}$  is nearly the same for the PEF treated tissue at 50°C and for the untreated tissue at 70°C. It opens new possibilities for energy saving in the sugar beet production. Another interesting effect of the PEF-treatment is the higher juice purity (Lebovka et al. 2007a). The purest juice is obtained after the cold diffusion (Fig. 17). However, even after the thermal diffusion at 70°C, juice purity was higher for slices pretreated by PEF than for untreated slices.

Recently, El-Belghiti et al. (2008) studied the PEF-enhanced extraction from thin and coarse fennel gratings of seven different sizes in order to obtain extracts, which can be used as natural food preservatives (antioxidants). The finest gratings GR1 and GR2 were obtained by crushing using Urschel crusher (Urschel Laboratories Inc., Valparaiso, USA). The coarse gratings GR3–GR7 were obtained by cutting using the slicer CL 50 (Robot-Coupe SNC, France).

Different moderate pulsed electric field intensities  $E = 0\text{--}600$  V/cm and number of pulses  $N = 0\text{--}850$  was used to electroporabilize the cell membranes and to accelerate the following extraction. Figure 18 presents kinetics of extraction from untreated (a) and PEF-treated (b) fennel gratings of different sizes. As can be seen from Fig. 18a, extraction kinetics from the finest gratings GR1 and GR2 was very rapid even without PEF-treatment and the final solute yield reached 98% after just 30 min of extraction. This indicates that almost all the cells were broken

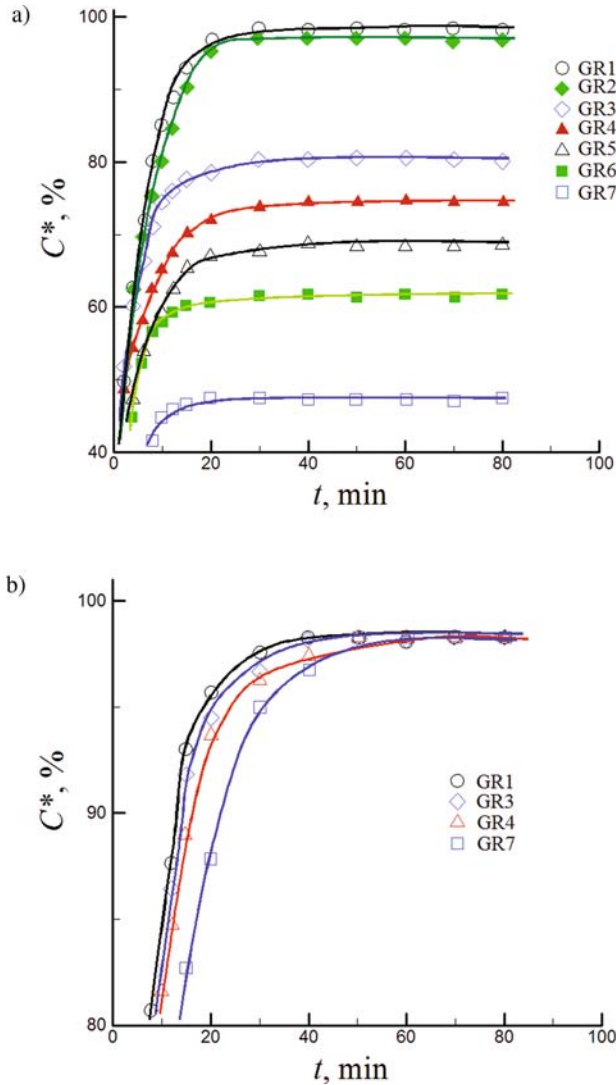


**Fig. 17** Purity of the diffusion solutions at different temperatures for the untreated and PEF-pretreated slices

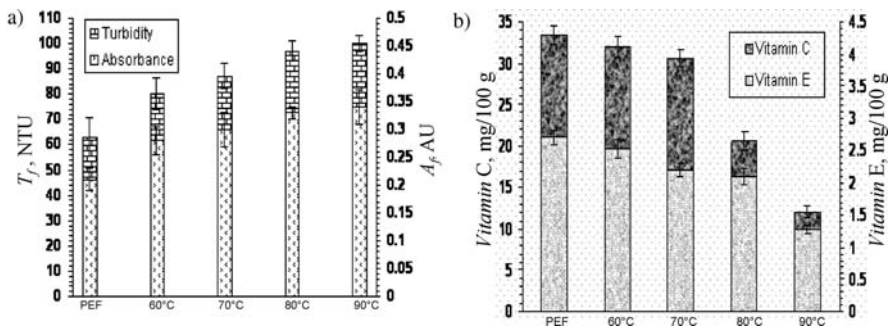
mechanically during the crushing. The PEF application did not accelerate the extraction kinetics for such gratings. However, extraction of the coarse grating was considerably improved after the optimal PEF-treatment, and the final solute yield of 98% was attained even for largest gratings GR6 and GR7 (Fig. 18b).

The optimal PEF-treatment was different for the gratings of different sizes. Generally, with increase of the gratings size from GR3 to GR7, the optimal PEF intensity increased from 300 to 600 V/cm and the optimal number of pulses increased from 200 to 900. This led to the increase of the PEF energy input from 2 kJ/kg to 3 kJ/kg for the smallest gratings GR3 to about 40 kJ/kg for the largest gratings GR7.

Expectedly, turbidity of the extracts obtained from coarse gratings was significantly lower than one obtained from thinner gratings. It was higher than 400 NTU for the gratings GR1 and lower than 50 NTU for the gratings GR7. Similarly, absorbance of the coarse gratings was lower than absorbance of the fine gratings. The PEF-treatment application somewhat decreased the turbidity and absorbance of gratings of the same size. Evidently, it is preferable to apply the PEF-treatment for solutes diffusion from coarse fennel gratings (GR3–GR7). Alternatively, extraction from coarse gratings can be assured by the hot water. That is why El-Belghiti et al. (2008) compared water diffusion from the coarse fennel gratings (GR5) treated by PEF and damaged thermally at 60–90°C. While kinetics of extraction from the coarse gratings was significantly accelerated due to thermal denaturation of the fennel tissue, the qualitative characteristics of extract were worse than after the PEF-treatment (Fig. 19). With the increase of heating temperature, the degradation



**Fig. 18** Extraction kinetics  $c^*(t)$  from untreated (a) and optimally PEF-treated (b) fennel gratings, where  $c^*$  is the ratio  $c/c_\infty$ ,  $c$  being the actual solutes concentration in solution and  $c_\infty$  being the equilibrium solute concentrations. The sizes of gratings: GR1 ( $0.1 \times 0.4 \times 6$  mm), GR2 ( $0.2 \times 0.8 \times 12$  mm), GR3 ( $0.5 \times 1.9 \times (25-50)$  mm), GR4 ( $0.75 \times 1.5 \times (30-50)$  mm), GR5 ( $1.2 \times 2.6 \times (30-60)$  mm), GR6 ( $1.6 \times 3.5 \times (25-75)$  mm) and GR7 ( $1.8 \times 6 \times (30-60)$  mm). The optimal parameters of the PEF treatment: GR3 –  $E = 300$  V/cm,  $N = 200$ ; GR4 –  $E = 350$  V/cm,  $N = 350$ ; GR7 –  $E = 600$  V/cm,  $N = 900$



**Fig. 19** Turbidity and absorbance (a) and concentration of vitamins (b) in extracts obtained after the PEF and thermal extraction from coarse gratings GR<sub>5</sub>

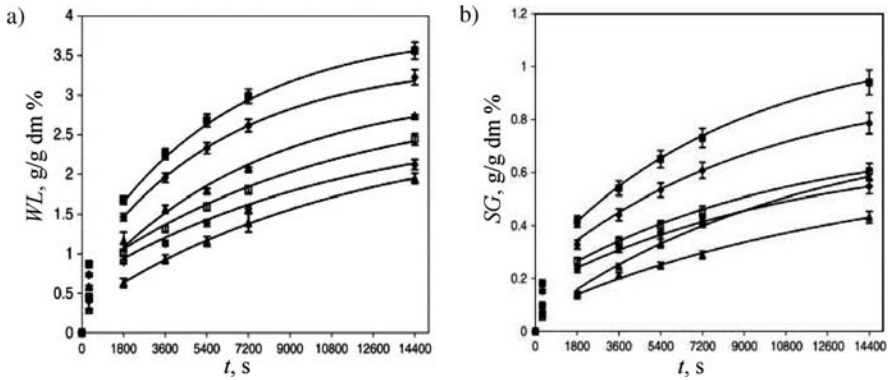
of cell structure and intracellular components is more pronounced. A repercussion is observed on the extract characteristics (Fig. 19).

Another disadvantage of thermal extraction is a high energy consumption exceeding considerably the energy consumed by PEF-treatment. For instance, the energy consumption for the thermal extraction from fennel gratings GR<sub>5</sub> at 60–90°C was approximately 500–650 kJ/kg, while it was just 15 kJ/kg for the same gratings treated by PEF

### 3.3 Osmotic Dehydration with PEF

Osmotic dehydration (OD) naturally occurs in the foods, such as fruits and vegetables, placed in a hypertonic sugar or salt solution presenting a high osmotic pressure and a low water activity. Diffusion phenomenon takes place with two simultaneous countercurrent flows: a water flow from the food to the outer solution and a simultaneous flow of solute from the solution to the food. These mechanisms lead to water loss (*WL*) and solid gain (*SG*) in the food. The OD process occurs at mild temperatures (up to 50°C) and requires less energy compared to drying. Therefore, it improves the product color and flavor retention. However, the cellular membrane exerts a high resistance to transfers, thus slowing down the OD rate. Recently, the PEF has been successfully applied for enhancing OD of different food plants, such as apples, carrots, mangos, and red bell peppers (Ade-Amowaye et al. 2001, 2002; Amami et al. 2006; Amami et al. 2007a, 2007b).

Figure 20a and 20b show the influence of the electric field intensity *E* on the water loss  $WL(g/g) = (W_0 - W)/S_0$  and solid gain  $SG(g/g) = (S - S_0)/S_0$  for an apple sample placed in a sucrose solutions (44.5, 55 and 65 Brix) at ambient temperature (Amami et al. 2006). *W*<sub>0</sub> and *W* are, respectively, the initial and actual weight of moisture in the sample; *S*<sub>0</sub> and *S* are, respectively, the initial and actual weight of dry matter in the sample. Increase of the electric field intensity *E* up to



**Fig. 20** Water loss (a) and solid gain (b) as functions of time for the OD of apple disk at room temperature in solutions of different concentration: *squares*, 65 Brix<sub>0</sub>; *diamonds*, 55 Brix<sub>0</sub>; *triangles*, 44.5 Brix<sub>0</sub>. *Open symbols*: without treatment, *full symbols*: with PEF-treatment (0.9 kV/cm, 750 pulses of 100 μs each), line corresponds to predictions of the Fick's diffusion model

0.9 kV/cm and the number of rectangular pulses (pulse duration  $t_i = 0.1$  ms) up to  $n = 1000$ , resulted in improvement of both WL and SG.

The energy consumption at the above PEF parameters was 21 kJ/kg. Reduction of  $n$  to 750 pulses (total duration of PEF application  $t_{PEF} = t_i \cdot n = 10^{-4} \cdot 750 = 0.075$  s) just reduced slightly WL and SG, but minimized the energy consumption to 12 kJ/kg. The WL increase (~50%), observed in Fig. 20 for experiments with PEF-treatment, was more impressive than that of SG (~6%). Such a low value of SG, obtained for PEF-pretreated samples, might offer an advantage for the OD process in some applications requiring simultaneously high WL assorted to minimum solute uptake. Another example of a reduced solid gain in comparison to water loss was indicated for bell pepper (Ade-Amowaye et al. 2002). It is already known that PEF-treatment damages mainly the cell membranes; while other structural changes, induced in plant tissue by PEF, remain limited. Therefore, penetration of solids inside the tissue during OD may be retarded or blocked because of the structure resistance, which remains almost unchanged. However, the OD mechanism consecutive to PEF-treatment is not yet well elucidated. Some other examples of PEF-treatment prior to OD were also recently addressed (Teijo et al. 2002). Mango pieces treated with PEF (2.67 kV/cm, 100 pulses of 0.84 ms) were immersed in a 50°Brix sucrose solution at 40°C for 5 hour. The PEF effect on WL was not significant, but SG was slightly increased (from  $\approx 0.63$  g/g to  $\approx 0.82$  g/g) (Teijo et al. 2002). Recently, Amami et al. (2007a, 2007b) have demonstrated that the combined effect of PEF, centrifugal field and salts could enhance WL from the carrot tissue. Addition of salt during the static and centrifugal OD resulted in WL and SG increases; however, the WL/SG ratio remained approximately the same during the static OD. The combination of PEF with salt enhanced additionally both WL and SG. The application of centrifugal field during OD enhanced WL but reduced SG. Therefore, the WL/SG ratio was increased in the centrifugal field; however salt addition decreased this

ratio. If gain of solids is also the goal of OD (confectionary additives, for example), the static OD may be better than centrifugal OD, which is especially interesting in the case of desirable limitation of the solid uptake (dietetic products).

### 3.4 Drying of Food Plants

Removing of moisture from the food materials allows to minimize microbial activity and undesirable chemical reactions (Barbosa-Canovas and Vega-Mercado 1996). But commonly used hot-air drying or freeze-drying techniques are limited by high energy consumption and long drying times. Moreover, drying at elevated temperatures can produce undesirable changes in pigments, vitamins and flavoring agents (Aguilera et al. 2003). In general, the drying processes consume an appreciable part of the total energy used in food industry, and so it is very important to develop the new hybrid drying technologies for energy saving and preserving of food quality (Chou and Chua 2001).

Different pre-treatment drying techniques, such as microwave heating (Beaudry et al. 2003), ohmic heating (Salengke and Sastry 2005; Zhong and Lima 2003), electrohydrodynamic drying (Bajgai and Hashinaga 2001; Cao et al. 2004; Li et al. 2005), and drying by chemical reagents or osmotic pre-treatment (Chua et al. 2004), were reported.

Recently, the PEF-treatment at high and moderate fields have been proposed for enhancement of the drying processes (Ade-Omowaye et al. 2003; Toepfl 2006; Lebovka et al. 2006; Lebovka et al. 2007b; Shynkaryk 2007). The PEF-treatment seems to be a promising non-thermal method that provides interesting advantages for enhancement of drying of the thermally sensitive food materials.

#### 3.4.1 Drying Kinetics and Moisture Diffusion Affected by PEF Cell Disintegration

Electrically assisted drying is characterized by decrease of processing time, temperature, and energy consumption. Electrically induced disintegration of the plant cells facilitates diffusivity of the moisture and can enhance drying. Figure 21 demonstrates the effects of PEF-treatment on potato tissue drying at 50°C in a convective dryer (Lebovka et al. 2007b). Here, the drying curves are presented as  $\omega$  versus time  $t$ , where the dimensionless moisture ratio  $\omega$  is determined as

$$\omega = (M(t) - M_e)/(M_o - M_e), \quad (19)$$

where  $M$  is the moisture content in a sample, and the subscripts  $o$  and  $e$  refer to the initial and equilibrium (final) moisture content, respectively.

The drying rate passes through the maximum near  $\omega \approx 1$ , when the excess surface moisture is removed, and then it decreases with decrease of  $\omega$  (insert in Fig. 21). The drying process proceeds at the falling rate and no period of constant drying rate is observed. The constant rate-drying period usually reflects the presence of

a continuous layer of free water that covers the surface (Zhang et al. 1997). The absence of the constant rate stage indicated importance of internal mass transfer processes and can be also explained by the shrinkage factor (May and Perré 2002).

The drying time was affected considerably by the drying temperature and freeze-thawing or PEF-pretreatment (Lebovka et al. 2007b). The higher the total treatment time of the PEF-treated potato tissue, the more rapid was the drying process (Fig. 21). The PEF-treatment of material releases moisture from the damaged cells and enhances the transport processes, which results in increase of the drying rate.

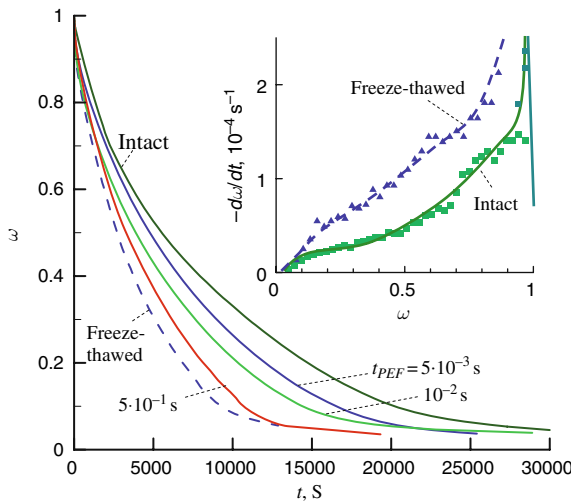
The drying rate can be characterized by the effective moisture diffusion coefficient  $D_{eff}$  determined through solution of the Fick's second law (Crank 1975):

$$\omega = 8/\pi^2 \sum_{i=0}^{\infty} (2i + 1)^{-2} \exp(- (2i + 1)^2 \pi^2 D_{eff} t / 4h_s^2). \tag{20}$$

This equation is valid for an infinite slab with thickness  $h_s$ .

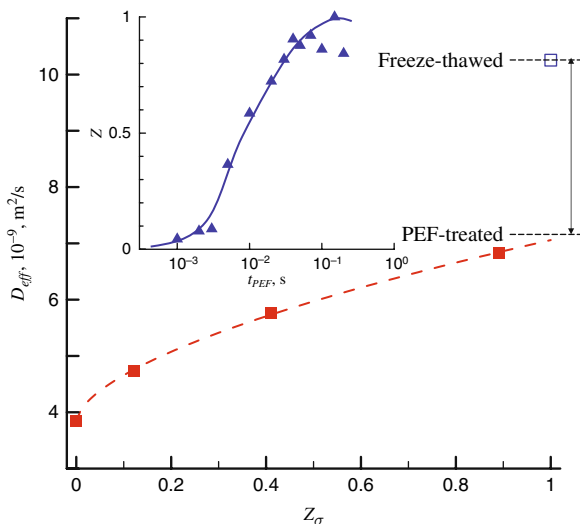
The diffusion coefficient  $D_{eff}$  was estimated from the least square fitting of this series expansion to the experimental drying curves (Lebovka et al. 2007b). The diffusion coefficient  $D_{eff}$  increased with increase of the damage degree  $P$  and was a non-linear function of the conductivity disintegration index  $Z$  (Fig. 22). In approximation of the parallel model of diffusion (Saravacos and Raouzeos 1984), the diffusion coefficient can be presented as (Lebovka et al. 2007b)

$$D_{eff} = P D_{eff}^d + (1 - P) D_{eff}^i = Z^{1/m} D_{eff}^d + (1 - Z^{1/m}) D_{eff}^i \tag{21}$$



**Fig. 21** The moisture ratio  $\omega$  versus drying time  $t$  for intact, PEF-treated and freeze-thawed (*dashed line*) potato tissues at  $50^\circ\text{C}$  drying temperature. Insert shows drying rate curves as  $d\omega/dt$  versus  $\omega$ . The volumetric flow rate was  $6 \text{ m}^3/\text{hour}$ . The PEF-pretreatment was done at room temperature,  $T = 25^\circ\text{C}$ , electric field strength  $E = 400 \text{ V/cm}$ , pulse duration  $t_i = 10^{-3} \text{ s}$ , pulse repetition time  $\Delta t = 10^{-2} \text{ s}$ , and different treatment time  $t_{PEF}$ , shown at the figure





**Fig. 22** Effective diffusion coefficient  $D_{eff}$  versus conductivity disintegration index  $Z$  for PEF pre-treated potato tissues. Insert shows conductivity disintegration index  $Z$  versus total treatment time  $t_{PEF}$ . The volumetric flow rate was  $6 \text{ m}^3/\text{hour}$ , the drying temperature was  $50^\circ\text{C}$ . The PEF-pretreatment was done at a room temperature,  $T = 25^\circ\text{C}$ , electric field strength  $E = 400 \text{ V/cm}$ , pulse duration  $t_i = 10^{-3} \text{ s}$ , pulse repetition time  $\Delta t = 10^{-1}$ . The open square show the data for tissue pre-treated by freeze-thawing

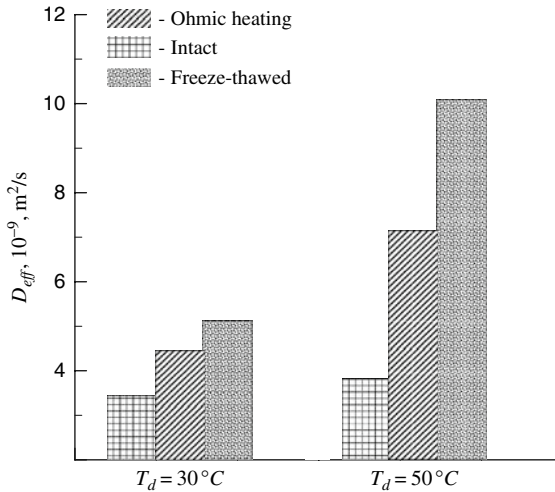
where  $D_{eff}^i$ ,  $D_{eff}^d$  are diffusion coefficients of the intact and totally PEF-damaged tissues, respectively. Here, Archie's equation (Equation (10)) relating  $P$  and  $Z$  was used.

The Archie's exponent  $m$  of  $1.68 \pm 0.04$  was estimated by the least square fitting of the experimental data to Equation (21). This result was consistent with other estimations of  $m$  values for different biological tissues (Lebovka et al. 2002).

The drying rate and diffusion coefficient  $D_{eff}$ , observed for the freeze-thawed tissue, exceed noticeably the same parameters for the totally PEF-damaged tissue with  $Z \approx 1$  (Fig. 22). It reflects differences in the structures of the freeze-thawed and PEF-damaged potato, as it was demonstrated by the textural studies (Lebovka et al. 2004a). It is known that drying processes can be noticeably influenced by the structure, density, and porosity of materials (May and Perré 2002).

Very similar accelerating effect of AC-treatment on convective air-drying was also observed at a moderate electric field strength ( $\leq 100 \text{ V/cm}$ ) (Lebovka et al. 2006). The experimental results evidence essential influence of the electric field strength  $E$  and the total electric energy input  $W$  on the drying rate. The effective moisture diffusivity increases with  $E$  and  $W$  increase.

Figure 23 presents effective diffusion coefficient  $D_{eff}$  of moisture for intact, AC-treated and freeze-thawed potato tissues at two different drying temperatures (30 and  $50^\circ\text{C}$ ). At air drying temperature  $50^\circ\text{C}$ , the effective diffusion coefficient  $D_{eff}$  of moisture for AC-treated potato tissue was still lower ( $D_{eff} \approx 0.71 \cdot 10^{-8} \text{ m}^2/\text{c}$ )



**Fig. 23** Moisture effective diffusion coefficient  $D_{eff}$  for intact and AC- and freeze-thawing pretreated potato tissues. Here,  $T_d$  is the drying temperature. The volumetric flow rate was  $6 \text{ m}^3/\text{hour}$ . The ohmic heating pre-treatment was done using AC at starting room temperature  $T = 25^\circ\text{C}$ , and electric field strength  $E = 100 \text{ V/cm}$ ; the samples were heated to the temperature of about  $50^\circ\text{C}$ , the total electric energy input was  $W \approx 100 \text{ kJ/kg}$  and disintegration index was  $Z \approx 0.7$

than that of the freeze-thawed pretreated potato ( $D_{eff} \approx 1.0 \cdot 10^{-8} \text{ m}^2/\text{c}$ ), even at the highest degree of destruction  $Z \approx 0.7$ . At a low air drying temperature ( $T = 30^\circ\text{C}$ ), the AC treatment allowed to increase the moisture diffusivity to a level noticeably higher than that observed for an intact tissue at drying temperature  $50^\circ\text{C}$ .

Though the highest drying rate was always observed for the freeze-thawing pretreatment, this process is rather energy consuming and requires  $\approx 280 \text{ kJ/kg}$  (Toepfl and Knorr 2006). Thermal drying at the elevated temperatures is also energy consuming and it can cause undesirable changes in the product quality. The AC pretreatment allows to decrease the drying temperature, approximately, by  $20^\circ\text{C}$  for potato tissue, and this method seems to be promising for enhancing the air drying processes for this product.

Similar effects in drying behavior were also observed for the red beetroot tissues (Shynkaryk et al. 2008; Shynkaryk 2007). The PEF or freeze-thawing pre-treatment allowed to increase noticeably the moisture diffusivity (for the same drying temperature  $T_d$ ), or to decrease the drying temperature, approximately, by  $20\text{--}25^\circ\text{C}$  (for the same level of diffusivity  $D_{eff}$ ).

The activation energies  $W$  of moisture diffusion in intact, PEF- and freeze-thawing pretreated red beetroot, potato and apples tissues are presented in Table 1 (Lebovka et al. 2007b; Shynkaryk et al. 2008; Shynkaryk 2007). Differences between activation energies seem to reflect variety of structures of the untreated and pretreated tissues. However, direct correlations between the mode of treatment (PEF or freeze-thawing) and values of  $W$  were not observed for different materials.

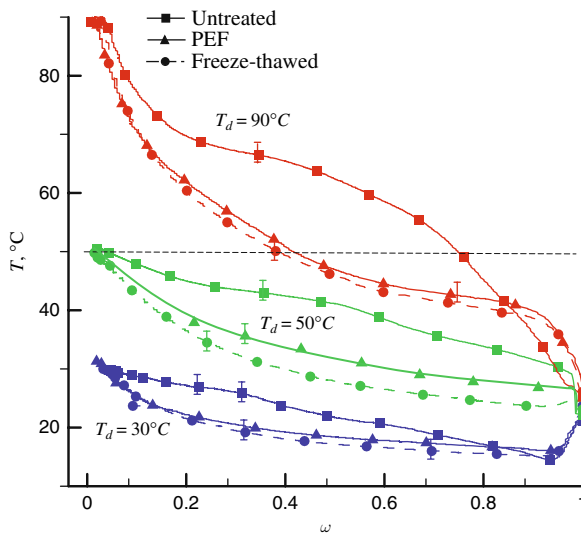
**Table 1** The activation energies of moisture diffusion  $W$  ( $\text{kJ mol}^{-1}$ ) for intact, PEF- and freeze-thawing pretreated tissues. The drying temperatures  $T_d$  was within 30–90°C (Lebovka et al. 2007b; Shynkaryk et al. 2007)

| Dried products                  | Untreated      | Pretreated by           |                                    |
|---------------------------------|----------------|-------------------------|------------------------------------|
|                                 |                | PEF ( $Z \approx 1.0$ ) | Freeze-thawing ( $Z \approx 1.0$ ) |
| Red beetroots (Unknown variety) | $20.2 \pm 2.3$ | $19.2 \pm 0.3$          | $17.6 \pm 1.3$                     |
| Potatoes (Agata)                | $21 \pm 1$     | $20 \pm 2$              | $27 \pm 4$                         |
| Apples (Golden)                 | $25.2 \pm 1.8$ | $18.6 \pm 1.8$          | $20 \pm 3$                         |

### 3.4.2 Temperature Evolution

The temperature factor is very important for degradable food materials, where the undesirable changes in pigments, vitamins and flavoring agents are possible (Aguilera et al. 2003). Preserving regimes of drying are essential for preparation of such products as red beetroots, apples, currants and grapes. Moreover, changes of porosity and texture on the external surface of material taking place at elevated temperatures can restrict diffusivity and the moisture cannot escape.

Figure 24 shows examples of temperature evolution inside red beetroot versus moisture ratio  $\omega$  for the untreated and pretreated red beetroot samples at different drying temperatures  $T_d$  (Shynkaryk et al. 2007; Shynkaryk 2007). The untreated samples exhibit higher temperature  $T$  than PEF- and freeze-thawed pretreated samples with the same moisture content  $\omega$ . Stability of water-soluble betalaines, contained by red beetroot, is strongly affected by water activity and temperature,



**Fig. 24** Temperature in the centre of a red beetroot sample  $T$  versus moisture ratio  $\omega$  for the untreated and PEF and freeze-thawing pretreated tissues at different temperatures of convective air  $T_d$ . The lines are drawn for the guidance of the eye and error bars are the standard deviations

and elevated temperatures ( $>50^{\circ}\text{C}$ ) accelerate degradation of this pigments (Saguy et al. 1978).

Preserving regime of drying is very important for red beetroot for preparation of the product rich in red-purple pigments, and degradation can be expected to diminish at smaller drying temperature and smaller moisture content inside the pre-treated tissues. The moisture content at  $50^{\circ}\text{C}$   $\omega_{50}$  remains rather low ( $<0.4$ ) even when drying temperature  $T_d = 90$  for the pretreated tissues, but the values of  $\omega_{50}$  are noticeably higher for the untreated tissues. Moreover, the obtained spectral data (Shynkaryk et al. 2007; Shynkaryk 2007), demonstrate that PEF-pretreatment is beneficial for drying regimes, as far as it preserves colorants. Although the PEF-pretreatment results in higher tissue shrinkage, as well as in higher time of rehydration, a difference in textural properties of the rehydrated samples with and without PEF-treatment is not essential. So, the observed behavior reflects a possibility of a colorant-safe drying for the pretreated samples, and PEF-assisted drying seems to be promising for enhancing industrial air drying processes.

**Acknowledgments** The authors would like to thank the ‘Pole Regional Genie des Procèdes’ (Picardie, France) for providing the financial support. Authors also thank Dr. N.S. Pivovarova for her help with preparation of the manuscript.

## References

- Abram, F., Smelt, J.P.P.M., Bos, R. and Wouters, P.C. (2003) Modelling and optimization of inactivation of *Lactobacillus plantarum* by pulsed electric field treatment. *Journal of Applied Microbiology* 94, 571–579.
- Ade-Amowaye, B.I., Angersbach, A., Taiwo, K.A. and Knorr, D. (2001) Use of pulsed electric field pre-treatment to improve dehydration characteristics of plant based foods. *Trends in Food Science and Technology* 12(8), 285–295.
- Ade-Amowaye, B.I., Rastogi, N.K., Angersbach, A. and Knorr, D. (2002) Osmotic dehydration of bell peppers: influence of high intensity electric field pulses and elevated temperature treatment. *Journal of Food Engineering* 54, 35–43.
- Ade-Omowaye, B.I., Rastogi, N.K., Angersbach, A. and Knorr, D. (2003) Combined effects of pulsed electric field pre-treatment and partial osmotic dehydration on air drying behaviour of red bell pepper. *Journal of Food Engineering* 60(1), 89–98.
- Agarwal, A., Zudans, I., Weber, E. A., Olofsson, J., Orwar, O. and Weber, S. G. (2007) Effect of cell size and shape on single-cell electroporation. *Analytical Chemistry* 79(10), 3589–3596.
- Aguilera, J.M., Chiralt, A. and Fito, P. (2003) Food dehydration and product structure. *Trends in Food Science and Technology* 14(10), 432–437.
- Albagnac, G., Varoquaux, P. and Montigaux, J.-C. (2002) *Technologies de transformation des fruits*. Lavoisier, Paris.
- Amami, E., Vorobiev, E. and Kechaou, N. (2006) Modelling of mass transfer during osmotic dehydration of apple tissue pre-treated by pulsed electric field. *LWT- Food Science and Technology* 39(9), 1014–1021.
- Amami, E., Fersi, A., Khezami, L., Vorobiev, E. and Kechaou, N. (2007a). Centrifugal osmotic dehydration and rehydration of carrot tissue pre-treated by pulsed electric field. *LWT – Food Science and Technology* 40(7), 1156–1166.
- Amami, E., Fersi, A., Vorobiev, E. and Kechaou, N. (2007b). Osmotic dehydration of carrot tissue enhanced by pulsed electric field, salt and centrifugal force. *Journal of Food Engineering*, 83(4), 605–613.

- Angersbach, A., Heinz, V. and Knorr, D. (2000) Effects of pulsed electric fields on cell membranes in real food systems. *Innovative Food Science and Emerging Technologies* 1(2), 135–149.
- Angersbach, A., Heinz, V. and Knorr, D. (2002) Evaluation of process-induced dimensional changes in the membrane structure of biological cells using impedance measurement. *Biotechnology Progress* 18(3), 597–603.
- Archie, G.E. (1942) The electrical resistivity log as an aid in determining some reservoir characteristics. *Transactions on AIME* 146:54–62.
- Aronsson, K., Lindgren, M., Johansson, B.R. and Rönner, U. (2001) Inactivation of microorganisms using pulsed electric fields: the influence of process parameters on *Escherichia coli*, *Listeria innocua*, *Leuconostoc mesenteroides* and *Saccharomyces cerevisiae*. *Innovative Food Science and Emerging Technologies* 2, 41–54.
- Bajgai, T.R. and Hashinaga, F. (2001) High electric field drying of Japanese radish. *Drying Technology* 19(9), 2291–2302.
- Barbosa-Canovas, G. and Vega-Mercado, H. (1996) *Dehydration of foods*. Chapman & Hall, New York.
- Barsotti, L. and Cheftel, J.C. (1998) Traitement des aliments par champs électriques pulses. *Science des Aliments* 18, 584–601.
- Bazhal, M. and Vorobiev, E. (2000) Electrical treatment of apple cossettes for intensifying juice pressing. *Journal of the Science of Food and Agriculture* 80, 1668–1674.
- Bazhal, M. (2001) *Etude du mécanisme d'électroporabilisation des tissus végétaux. Application à l'extraction du jus des pommes*. PhD thesis, Université de Technologie de Compiègne, France.
- Bazhal, M.I., Lebovka, N.I. and Vorobiev, E.I. (2001) Pulsed electric field treatment of apple tissue during compression for juice extraction. *Journal of Food Engineering* 50, 129–139.
- Bazhal, M.I., Lebovka, N.I. and Vorobiev, E. (2003) Optimisation of pulsed electric field strength for electroporation of vegetable tissues. *Biosystems Engineering* 86, 339–345.
- Beaudry, C., Raghavan, G.S.V. and Rennie, T.J. (2003) Microwave finish drying of osmotically dehydrated cranberries. *Drying Technology* 21(9), 1797–1810.
- Bernhardt, J. and Pauly, H. (1973) On the generation of potential differences across the membranes of ellipsoidal cells in an alternating electrical field. *Biophysik* 10, 89–98.
- Bouzzara, H. and Vorobiev, E. (2000) Beet juice extraction by pressing and pulsed electric fields. *International Sugar Journal* CII 1216, 194–200.
- Bouzzara, H. (2001) *Amélioration du pressage de produits végétaux par Champ Electrique Pulsé. Cas de la betterave à sucre*. PhD thesis, Université de Technologie de Compiègne, France.
- Bouzzara, H. and Vorobiev, E. (2001) Non-thermal pressing and washing of fresh sugarbeet cossettes combined with a pulsed electrical field. *Zucker* 126, 463–466.
- Bouzzara, H. and Vorobiev, E. (2003) Solid/liquid expression of cellular materials enhanced by pulsed electric field. *Chemical Engineering and Processing* 42, 249–257.
- Canatella, P.J., Karr J.F., Petros, J.A. and Prausnitz, M.R. (2001) Quantitative study of electroporation mediated uptake and cell viability. *Biophysical Journal* 80, 755–764.
- Canatella, P.J., Black, M.M., Bonnicksen, D.M., McKenna, C. and Prausnitz, M.R. (2004) Tissue electroporation: quantification and analysis of heterogeneous transport in multicellular environments. *Biophysical Journal* 86, 3260–3268.
- Cao, W., Nishiyama, Y., Koide, S. and Lu, Z.H. (2004) Drying enhancement of rough rice by an electric field. *Biosystems Engineering* 87(4), 445–451.
- Chang, D.C. (1989) Cell poration and cell fusion using an oscillating electric field. *Biophysical Journal* 56, 641–652.
- Chalermchatand, Y. and Dejmeek, P. (2005) Effect of pulsed electric field pretreatment on solid-liquid expression from potato tissue. *Journal of Food Engineering* 71, 164–169.
- Chen, C., Smye, S.W., Robinson, M.P. and Evans, J.A. (2006) Membrane electroporation theories: a review. *Medical Biology Engineering Computing* 44(1/2), 5–14.
- Chou, S.K. and Chua, K.J. (2001) New hybrid drying technologies for heat sensitive foodstuffs. *Trends in Food Science and Technology* 12, 359–369.

- Chua, K.J., Chou, S.K., Mujumdar, A.S., Ho, J.C. and Hon, C.K. (2004) Radiant-convective drying of osmotic treated agro-products: effect on drying kinetics and product quality. *Food Control* 15(2), 145–158.
- Corrales, M., Toepfl, S., Butz, P., Knorr D. and Tauscher, B. (2008). Extraction of anthocyanins from grape by-products assisted by ultrasonic, high hydrostatic pressure or pulsed electric fields: a comparison. *Innovative Food Science and Emerging Technologies*, 9(1), 85–91.
- Crank, J. (1975). *The mathematics of diffusion*. Oxford University Press, Oxford.
- De Vito, F., Ferrari, G., Lebovka, N.I., Shynkaryk, N.V. and Vorobiev, E. (2008) Pulse duration and efficiency of soft cellular tissue disintegration by pulsed electric fields. *Food Bioprocess Technology*, In Press.
- Dimitrov, D.S. and Sowers, A.E. (1990) Membrane electroporation – fast molecular exchange by electroosmosis. *Biochimica et biophysica acta* 1022, 381–392.
- El-Belghiti, K. and Vorobiev, E. (2004) Mass transfer of sugar from beets enhanced by pulsed electric field. *Food and Bioprocess Processing* 82(c3), 226–230.
- El-Belghiti, K. (2005) *Effets d'un champ électrique pulsé sur le transfert de matière et sur les caractéristiques végétales*. PhD thesis, Université de Technologie de Compiègne, France.
- El-Belghiti, K., Rabhi, Z. and Vorobiev, E. (2005) Effect of the centrifugal force on the aqueous extraction of solute from sugar beet tissue pretreated by a pulsed electric field. *Journal of Food Process Engineering* 28, 346–358.
- El-Belghiti, K. and Vorobiev, E. (2005a) Kinetic model of sugar diffusion from sugar beet tissue treated by pulsed electric field. *Journal of the Science of Food and Agriculture* 85, 213–218.
- El-Belghiti, K. and Vorobiev, E. (2005b) Modelling of solute aqueous extraction from carrots subjected to a pulsed electric field pre-treatment. *Biosystems Engineering* 90(3), 289–294.
- El-Belghiti, K., Moubarik, A. and Vorobiev, E. (2008) Aqueous extraction of solutes from fennel (*Foeniculum vulgare*) Assisted by pulsed electric field. *Journal of Food Process Engineering*, In Press.
- El Zakhem, H., Lanoisellé, J.-L., Lebovka, N.I., Nonus, M. and Vorobiev, E. (2006a) Behavior of yeast cells in aqueous suspension affected by pulsed electric field. *Journal of Colloid and Interface Science* 300(2), 553–563.
- El Zakhem, H., Lanoisellé, J.-L., Lebovka, N.I., Nonus, M. and Vorobiev, E. (2006b) The early stages of *Saccharomyces cerevisiae* yeast suspensions damage in moderate pulsed electric fields. *Colloids and Surfaces B47(2)*, 189–197.
- Eshtiaghi, M.N. and Knorr, D. (1999) Method for treating sugar beet, International Patent Nr WO 99/6434
- Evrendilek, G.A. and Zhang, Q.H. (2005) Effects of pulse polarity and pulse delaying time on pulsed electric fields-induced pasteurization of *E. coli* O157:H7. *Journal of Food Engineering* 68(2), 271–276.
- Exerova, D. and Nikolova, A. (1992) Phase transitions in phospholipid foam bilayers. *Langmuir* 8(12), 3102–3108.
- Fincan, M. and Dejmek, P. (2002) In situ visualization of the effect of a pulsed electric field on plant tissue. *Journal of Food Engineering* 55, 223–230.
- Fincan, M., De Vito, F. and Dejmek, P. (2004) Pulsed electric field treatment for solid–liquid extraction of red beetroot pigment. *Journal of Food Engineering* 64(3), 381–388.
- Flaumenbaum, B.L. (1949) Electrical treatment of fruits and vegetables before extraction of juice. *Trudy OTIKP* 3, 15–20 (in Russian).
- Fricke, H. (1953) The electric permittivity of a dilute suspension of membrane-covered ellipsoids. *Journal of Applied Physics* 24, 644–646.
- Gimsa, J. and Wachner, D. (2001) Analytical description of the transmembrane voltage induced on arbitrarily oriented ellipsoidal and cylindrical cells. *Biophysical Journal* 81, 1888–1896.
- Grimi, N., Praporscic, I., Lebovka, N. and Vorobiev, E. (2007) Selective extraction from carrot slices by pressing and washing enhanced by pulsed electric fields. *Separation and Purification Technology*, 58(2), 267–273.

- Gulyi, I.S., Lebovka, N.I., Mank, V.V., Kupchik, M.P., Bazhal, M.I., Matvienko, A.B. and Papchenko, A.Y. (1994) *Scientific and practical principles of electrical treatment of food products and materials*. UkrINTEI, Kiev (in Russian).
- Ho, S.Y. and Mittal, G.S. (1996) Electroporation of cell membranes: a review. *Critical Reviews in Biotechnology* 16, 349–362.
- Jemai, A.B. and Vorobiev, E. (2001) Enhancement of the diffusion characteristics of apple slices due to moderate electric field pulses (MEFP). In: J. Welti-Chanes, G.V. Barbosa-Canovas and J.M. Aguilera (Eds.), *Proceedings of the 8th International Congress on Engineering and Food*. Technomic Publishing Co., Pennsylvania, USA, pp. 1504–1508.
- Jemai, A.B. and Vorobiev, E. (2002) Effect of moderate electric field pulse (MEFP) on the diffusion coefficient of soluble substances from apple slices. *International Journal of Food Science and Technology* 37, 73–86.
- Jemai, A.B. and Vorobiev, E. (2003) Enhancing leaching from sugar beet cossettes by pulsed electric field. *Journal of Food Engineering* 59, 405–412.
- Jemai, A.B. and Vorobiev, E. (2006) Pulsed electric field assisted pressing of sugar beet slices: towards a novel process of cold juice extraction. *Biosystems Engineering* 93(1), 57–68.
- Katrokha, I.M. and Kupchik, M.P. (1984) Intensification of sugar extraction from sugar-beet cossettes in an electric field. *Sakharnaya Promyshlennost* 7, 28–31 (in Russian).
- Knorr, D., Angersbach, A., Eshtiaghi, M.N., Heinz, V. and Lee D.-U. (2001) Processing concepts based on high intensity electric field pulses. *Trends in Food Science and Technology* 12(3–4), 129–135.
- Kogan, F.I. (1968) *Electrophysical methods in canning technologies of foodstuff*. Tehnika, Kiev (in Russian).
- Kotnik, T., Miklavcic, D. and Slivnik, T. (1998) Time course of transmembrane voltage induced by time-varying electric fields: a method for theoretical analysis and its application. *Bioelectrochemistry and Bioenergetics* 45, 3–16.
- Kotnik, T. and Miklavcic D. (2000) Analytical description of transmembrane voltage induced by electric fields on spheroidal cells. *Biophysical Journal* 79, 670–679.
- Krassowska, W. and Filev, P.D. (2007) Modeling electroporation in a single cell. *Biophysical Journal* 92, 404–417.
- Landau, L.D., Lifshitz, E.M. and Pitaevskii, L.P. (1984) *Electrodynamics of continuous media*. Pergamon, New York.
- Lebedeva, N.E. (1987) Electric breakdown of bilayer lipid membranes at short times of voltage effect. *Biological Membranes* 4, 994–998 (in Russian).
- Lebovka, N.I., Bazhal, M.I. and Vorobiev, E. (2000a) Simulation and experimental investigation of food material breakage using pulsed electric field treatment. *Journal of Food Engineering* 44, 213–223.
- Lebovka, N.I., Melnyk, R.M. and Kupchik, M.P., Bazhal, M.I. and Serebrjakov, R.A., (2000b) Local generation of ohmic heat on cellular membranes during the electrical treatment of biological tissues. *Scientific Papers of Kiev Mogyla Academy* 18, 51–56.
- Lebovka, N.I., Bazhal, M.I. and Vorobiev, E. (2001) Pulsed electric field breakage of cellular tissues: visualization of percolative properties. *Innovative Food Science and Emerging Technologies* 2, 113–125.
- Lebovka, N.I., Bazhal, M.I. and Vorobiev, E. (2002) Estimation of characteristic damage time of food materials in pulsed-electric fields. *Journal of Food Engineering* 54, 337–346.
- Lebovka, N.I., Praporscic, I. and Vorobiev, E. (2003) Enhanced expression of juice from soft vegetable tissues by pulsed electric fields: consolidation stages analysis. *Journal of Food Engineering* 59, 309–317.
- Lebovka, N.I., Praporscic, I. and Vorobiev, E. (2004a) Combined treatment of apples by pulsed electric fields and by heating at moderate temperature. *Journal of Food Engineering* 65, 211–217.

- Lebovka, N.I., Praporscic, I. and Vorobiev, E. (2004b) Effect of moderate thermal and pulsed electric field treatments on textural properties of carrots, potatoes and apples. *Innovative Food Science and Emerging Technologies* 5, 9–16.
- Lebovka, N.I. and Vorobiev, E. (2004) On the origin of the deviation from the first-order kinetics in inactivation of microbial cells by pulsed electric fields. *International Journal of Food Microbiology* 91, 83–89.
- Lebovka, N.I., Praporscic, I., Ghnimi, S. and Vorobiev, E. (2005a) Temperature enhanced electroporation under the pulsed electric field treatment of food tissue. *Journal of Food Engineering* 69(2), 177–184.
- Lebovka, N.I., Praporscic, I., Ghnimi, S. and Vorobiev, E. (2005b) Does electroporation occur during the ohmic heating of food. *Journal of Food Science* 70(5), 308–311.
- Lebovka, N.I., Shynkaryk, M.V. and Vorobiev, E., (2006) Drying of potato tissue pretreated by ohmic heating. *Drying Technology* 24, 1–11.
- Lebovka, N.I., Shynkaryk, M.V., El-Belghiti, K., Benjelloun, H. and Vorobiev, E. (2007a) Plasmolysis of sugarbeet: pulsed electric fields and thermal treatment. *Journal of Food Engineering* 80(2), 639–644.
- Lebovka, N.I., Shynkaryk, N.V. and Vorobiev, E. (2007b) Pulsed electric field enhanced drying of potato tissue. *Journal of Food Engineering*, 78(2), 606–613.
- Lebovka, N.I. and Vorobiev, E. (2007) The kinetics of inactivation of spheroidal microbial cells by pulsed electric fields. E-print arXiv:0704.2750v1, 1–22.
- Li, F.-D., Li, L.-T., Sun, J.-F. and Tatsumi, E. (2005) Electrohydrodynamic (EHD) drying characteristic of okara cake. *Drying Technology* 23, 565–580.
- Lysjanskii (1973). *The extraction process of sugar from sugarbeet: theory and calculations (Process ekstraktzii sahara iz svekly: teorija i raschet)*. Pischevaja Promyshlennost, Moscow (in Russian).
- Mañas, P., Barsotti, L. and Cheftel, J.C. (2000) Microbial inactivation by pulsed electric fields in a batch treatment chamber: effects of some electrical parameters and food constituents. *Innovative Food Science and Emerging Technologies* 2, 239–249.
- Marchal, L., Muravetchi, V., Vorobiev, E., Bonhoure, J.P. (2004). Recovery of inulin from Jerusalem Artichoke Tubers: development of a pressing method assisted by pulsed electric field. *International Congress on Engineering and Food, Montpellier, 7–11 mars, CD-Rom, (6 p)*.
- Martín-Belloso, O., Vega-Mercado, H., Qin, B.L., Chang, F.J., Barbosa-Cánovas, G.V. and Swanson, B.G. (1997) Inactivation of *Escherichia coli* suspended in liquid egg using pulsed electric fields. *Journal of Food Processing and Preservation* 21, 193–208.
- Matov, B. I. and Reshetko, E.V. (1968) *Electrophysical methods in food industry*. Kartja Moldav-enjaskje, Kishinev (in Russian).
- May, B.K. and Perré, P. (2002) The importance of considering exchange surface area reduction to exhibit a constant drying flux period in foodstuffs. *Journal of Food Engineering* 54(4), 271–282.
- Mouritsen, O.G. and Jørgensen, K. (1997) Small-scale lipid-membrane structure: simulation versus experiment. *Current Opinion in Structural Biology* 7, 518–527.
- Pavlin, M., Leben, V. and Miklavcic, D. (2007) Electroporation in dense cell suspension. Theoretical and experimental analysis of ion diffusion and cell permeabilization. *BBA* 1770(1), 12–23.
- Pauly, H. and Schwan, H.P. (1959) Über die Impedanz einer Suspension von kugelförmigen Teilchen mit einer Schale. *Zeitschrift für Naturforschung B* 14, 125–131.
- Pliquett, U., Joshi, R.P., Sridhara, V. and Schoenbach, K.H. (2007) High electrical field effects on cell membranes. *Bioelectrochemistry* 70(2), 275–282.
- Praporscic, I. (2005) *Influence du traitement combiné par champ électrique pulsé et chauffage modéré sur les propriétés physiques et sur le comportement au pressage de produits végétaux*. PhD thesis, UTC, Compiègne, France.



- Praporscic, I., Ghnimi, S. and Vorobiev, E. (2005) Enhancement of pressing sugar beet cuts by combined ohmic heating and pulsed electric field treatment. *Journal of Food Processing and Preservation* 29(5–6), 378–389.
- Praporscic, I.V., Lebovka, N., Ghnimi, S. and Vorobiev, E. (2006) Ohmically heated, enhanced expression of juice from apple and potato tissues. *Biosystems Engineering* 93(2), 199–204.
- Praporscic, I., Lebovka, N.I., Vorobiev, E. and Mietton-Peuchot, M. (2007a) Pulsed electric field enhanced expression and juice quality of white grapes. *Separation and Purification Technology* 52(3), 520–526.
- Praporscic, I., Shynkaryk, M., Lebovka, N. and Vorobiev, E. (2007b) Analysis of juice colour and dry matter content during pulsed electric field enhanced expression of soft plant tissues. *Journal of Food Engineering* 79(2), 662–670.
- Pucihar, G., Kotnik, T., Teissie, J. and Miklavcic, D. (2007) Electroporation of dense cell suspensions. *European Biophysics Journal* 36(3), 173–185.
- Qin, B.L., Zhang, Q., Swanson, B.G. and Pedrow, P.D. (1994) Inactivation of microorganisms by different pulsed electric fields of different voltage waveforms. *Institute of Electrical and Electronics Engineers Transaction on Industry Applications* 1(6), 1047–1057.
- Raso, J., Álvarez, I., Condón, S. and Sala-Trepat, F.J. (2000) Predicting inactivation of *Salmonella senftenberg* by pulsed electric fields. *Innovative Food Science and Emerging Technologies* 1, 21–29.
- Rogov, I.A. and Gorbатов, A.V. (1974) *Physical methods of foods processing*. Pischevaja Promyshlennost, Moscow (in Russian).
- Saguy, I., Kopelman, I.J., Mizrahi, S., (1978) Thermal kinetic degradation of betanin and betalamic acid. *Journal of Agricultural and Food Chemistry* 26(2), 360–362.
- Sale, A. and Hamilton, W. (1967) Effect of high electric fields on microorganisms. I. Killing of bacteria and yeast. *Biochimica et Biophysica Acta* 148, 781–788.
- Salengke, S. and Sastry, S.K. (2005) Effect of ohmic pretreatment on the drying rate of grapes and adsorption isotherm of raisins. *Drying Technology* 23, 551–564.
- Sampedro, F., Rivas, A., Rodrigo, D., Martínez, A. and Rodrigo, M. (2007) Pulsed electric fields inactivation of *Lactobacillus plantarum* in an orange juice–milk based beverage: effect of process parameters. *Journal of Food Engineering* 80(3), 931–938.
- Saravacos, G.D. and Raouzeos, G.S. (1984) Diffusivity of moisture during air drying of starch gels. In: B.M. McKenna (Ed.), *Engineering and food*. Elsevier Applied Science, London, pp. 381–394.
- Schwan, H.P. (1957) Electrical properties of tissue and cell suspensions. In: J.H. Lawrence and A. Tobias (Eds.), *Advances in biological and medical physics*. Academic Press, New York, pp. 147–209.
- Schwartzberg, H.G. and Chao, R.Y. (1982) Solute diffusivities in leaching processes. *Food Technology* 36, 73–86.
- Schwartzberg, H.G. (1997) Expression of fluid from biological solids. *Separation and Purification Methods* 26, 1–213.
- Shynkaryk, M.V. (2007) *Influence de la perméabilisation membranaire par champ électrique sur la performance de séchage des végétaux*. PhD thesis, Université de Technologie de Compiègne, France.
- Shynkaryk, M.V., Lebovka, N.I. and Vorobiev, E. (2008) Pulsed electric fields and temperature effects on drying and rehydration of red beetroots. *Drying Technology* 26(6), 695–704.
- Tarek, M. (2005) Membrane electroporation: a molecular dynamics simulation. *Biophysical Journal* 88, 4045–4053.
- Teijo, W., Taiwo, K.A., Eshtiaghi, N. and Knorr, D. (2002) Comparison of pretreatment methods on water and solid diffusion kinetics of osmotically dehydrated mangos. *Journal of Food Engineering* 53, 133–142.
- Teissié, J., Eynard, N., Gabriel, B. and Rols, M.P. (1999) Electroporation of cell membranes. *Advanced Drug Delivery Reviews* 35(1), 3–19.

- Teissie, J., Golzio, M. and Rols, M.P. (2005) Mechanisms of cell membrane electroporation: a minireview of our present (lack of?) knowledge. *Biochimica et Biophysica Acta* 1724, 270–280.
- Toepfl, S. (2006) *Pulsed electric fields (PEF) for permeabilization of cell membranes in food- and bioprocessing – applications, process and equipment design and cost analysis*. PhD thesis, Institut für Lebensmitteltechnologie und Lebensmittelchemie, Berlin.
- Toepfl, S. and Knorr, D. (2006) Pulsed electric fields as a pretreatment technique in drying processes. *Stewart Postharvest Review* 4(3), 1–6.
- Toepfl, S., Heinz, V. and Knorr, D. (2007) High intensity pulsed electric fields applied for food preservation. *Chemical Engineering and Processing* 46(6), 537–546.
- Valic, B., Golzio, M., Pavlin, M., Schatz, A., Faurie, C., Gabriel, B., Teissié, J., Rols, M.-P. and Miklavcic, D. (2003) Effect of electric field induced transmembrane potential on spheroidal cells: theory and experiment. *European Biophysics Journal* 32, 519–528.
- Van der Poel P.W., Schiweck, H. and Schwartz, T. (1998) *Sugar technology beet and cane sugar manufacture, beet sugar development foundation*. Denver, USA.
- Vorobiev E., Bazhal, M. and Bouzrara, H. (2002) Solid-liquid expression of biological materials enhanced by electroosmosis and pulsed electric field. *Symposium on Emerging Technologies for the Food Industry*. 11–13 March 2002, Madrid, Spain.
- Vorobiev, E., Lebovka, N., Praporscic, I. and Muravetchi, V. (2004) Stages of constant rate and constant pressure solid-liquid expression enhanced by pulsed electric field. *Proceedings of 9 World Filtration Congress, New Orleans, USA, 18–24 April 2004*, CD-Rom, (9 p).
- Vorobiev, E., Jemai, A.B., Bouzrara, H., Lebovka, N.I. and Bazhal, M.I. (2005) Pulsed electric field assisted extraction of juice from food plants. In: G. Barbosa-Canovas, M.S. Tapia and M.P. Cano (Eds.), *Novel food processing technologies*, CRC Press, New York, pp. 105–130.
- Vorobiev, E. and Lebovka, N.I. (2006) Extraction of intercellular components by pulsed electric fields. In: J. Raso and V. Heinz (Eds.), *Pulsed electric field technology for the food industry. Fundamentals and applications*. Springer, New York, pp. 153–194.
- Wang, W.C., and Sastry, S.K. (2002) Effects of moderate electrothermal treatments on juice yield from cellular tissue. *Innovative Food Science and Emerging Technologies* 3, 371–377.
- Weaver, J.C. and Chizmadzhev, Y.A. (1996) Theory of electroporation: a review. *Bioelectrochemistry and Bioenergetics* 41, 135–160.
- Wouters, P.C. and Smelt, J.P.P.M. (1997) Inactivation of microorganisms with pulsed electric fields: Potential for food preservation. *Food Biotechnology* 11(3), 193–229.
- Wouters, P.C., Dutreux, N., Smelt, J.P.P.M. and Lelieveld, H.L.M. (1999) Effects of pulsed electric fields on inactivation kinetics of *Listeria innocua*. *Applied and Environmental Microbiology* 65, 5364–5371.
- Zagorulko, A. Ja. (1958) Technological parameters of beet desugaring process by the selective electroporation. In: *New physical methods of foods processing*, Izdatelstvo GosINTI, Moscow, pp 21–27 (in Russian).
- Zhang, Q., Monsalve-Gonzalez, A., Qin, B.L., Barbosa-Canovas, G.V. and Swanson, B.G. (1994) Inactivation of *Saccharomyces cerevisiae* in apple juice by square-wave and exponential-decay pulsed electric fields. *Journal of Food Process Engineering* 17, 469–478.
- Zhang, Z., Yang, S. and Liu, D. (1997) Mechanism and mathematical model of heat and mass transfer during convective drying of porous materials. *Journal of Chemical Industry and Engineering* 48(1), 52–59.
- Zhong, T. and Lima, M. (2003) The effect of ohmic heating on vacuum drying rate of sweet potato tissue. *Bioresource Technology* 87(3), 215–220.
- Zimmermann, U., Pilwat, G. and Riemann, F. (1974) Dielectric breakdown of cell membranes. *Biophysical Journal* 14, 881–899.
- Zimmermann, U. (1986) Electrical breakdown, electroporation and electrofusion. *Reviews of Physiology, Biochemistry and Pharmacology* 105, 175–256.

# Moderate Electrothermal Treatments of Cellular Tissues

Suzanne Kulshrestha, Sanjay Sarang, Laleh Loghavi, and Sudhir Sastry

**Abstract** Moderate electrothermal treatments, or moderate electric field (MEF) processing of foods, are operations that typically use field strengths below 1 KV/cm and frequencies below 1 MHz. Heating usually occurs in these applications, but controlled studies have shown enhanced mass transfer effects that are nonthermal in nature. MEF processing has been useful in improving drying, extraction, and fermentation processes. The mechanism for improved drying and extraction appears to be increased permeability of the cell membrane, allowing for ease of transport of materials out of cells. Drying and extraction are improved most from tissue with intact cells, such as raw fruits and vegetables. Low frequencies are most effective for these applications. Several studies have also shown MEF processes to increase the rate of microbial growth during controlled fermentations. However, the mechanism is not understood, and this field of study is currently in its infancy. Research is underway to develop industrial applications of the new technology that have been already been demonstrated in the laboratory, and to investigate new applications.

## 1 Introduction

For several applications in the food industry, electric field treatments, such as pulsed electric field (PEF), moderate electric field (MEF) processing, radio frequency heating, and microwave heating, have been identified and discussed in the literature. Microwave heating is usually done at 2.45 GHz or 915 MHz and is from exposure to radiation, rather than direct contact, and radio frequency heating is accomplished at 40 MHz (<http://www.radiofrequency.com>). The regulation of electromagnetic technology for industrial applications is described at <http://www.itu.int/ITU-R/terrestrial/faq/index.html>. MEF treatment involves the application of an electric field, usually at frequencies on the order of 50 Hz and at field strengths below 1000 V/cm. MEF fields are lower than those for PEF, which are usually DC

---

S. Kulshrestha  
Department of Food, Agricultural, and Biological Engineering, The Ohio State University, 590  
Woody Hayes Dr., Columbus, OH 43210  
e-mail: Kulshrestha.11@osu.edu

pulses measured in field strengths of kV/cm. MEF treatment times are also typically measured in seconds, whereas PEF treatments involve exposure times at the microsecond order of magnitude.

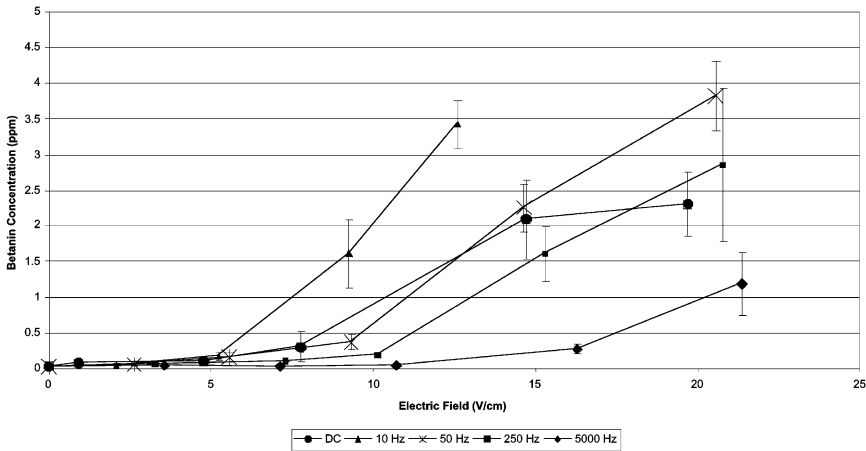
Recently, a growing body of literature suggests that even relatively moderate electric fields can have significant permeabilizing influences on both prokaryotic and eukaryotic cells. The character of the permeabilization is different from thermal effects. What has not been universally realized is the remarkable range and variety of food processing operations that can be impacted by electrical treatment. Depending on the relative electrical and thermal exposure of a particular treatment, it is possible to obtain a wide variety of effects in biological materials, and there are a large number of potential applications waiting to be discovered in this area. Since the intent of these processes is controlled, possibly reversible, permeabilization, and they are characterized by relatively moderate, arbitrary waveform electrical fields, they are termed here as moderate electric field (MEF) processes, to distinguish them from ohmic heating sterilization and the PEF process.

What makes MEF processes particularly interesting for nonmicrobial control applications is that they are potentially far less expensive than either PEF or high-pressure processes considered for the same purpose. Since these are generally unrelated to microbial control, they do not face stringent regulatory scrutiny prior to commercialization. Also, in many cases, the imposition of a simple alternating current from a readily available power supply is sufficient to cause permeabilization without the need for specialized switching circuits or heavy devices for pressure containment. High-voltage equipment and procedures are generally required for application of voltages higher than 600 peak (424 RMS). For liquids, a high field strength can be obtained by creating a narrow gap between the electrodes. For particulates, this can limit the field strength according to the particulate size. However, field strengths can easily be obtained that have significant benefits to food operations.

MEF treatment has been shown to nonthermally increase the permeability of cell tissue and diffusion of water and soluble matter through cell membranes, thus opening the door for potential future applications, such as improvements in extraction, dehydration, and fermentation operations. Under most conditions, ohmic heating occurs during MEF treatment, but here we are concerned with the nonthermal electrical effects. This chapter reviews research on MEF treatment applications and discusses mechanisms contributing to enhanced mass transfer.

## **2 Nonthermal Effects of Electric Fields on Cells with Intact Membranes**

Although MEF processing may offer thermal advantages for rapid, uniform ohmic heating, the nonthermal effects are most significant for extraction, drying, and fermentation processes. The numerous studies of food processing applications of MEF have clear trends that suggest an electroporation mechanism, which may also be called electropermeabilization or plasmolysis, in which the electric field causes pores to form in the cell membranes of intact cellular tissue, as is found



**Fig. 1** Diffusion of betanin from fresh tissue MEF processed for 3 min at 45°C: Effect of electric field strength and frequency. Error bars represent 95% confidence intervals. Reproduced from Kulshrestha and Sastry (2003)

in fresh plant tissue and living microorganisms. With MEF heating, greater electropermeabilization is seen at low frequencies (Imai et al. 1995; Lima et al. 1999; Kulshrestha and Sastry 2003), presumably because the cell membranes have more time to become polarized and develop pores (Fig. 1). Enhanced mass transfer has occasionally been reported for noncellular tissue (Schreier et al. 1993; Kemp and Fryer 2007), suggesting that other mass transfer processes, such as electro-osmosis or electrophoresis, may be occurring as well. However, in most studies, noncellular material and cellular material that has had its cell membranes destroyed via a freeze–thaw cycle or heating above 60°C do not have the same dramatic increase in process efficiency during food operations. A living cell has a thin, dielectric membrane with high resistance (about 10<sup>4</sup> Ω cm<sup>2</sup>) and a capacitance (C) of about 1 μF/cm<sup>2</sup> (Williams et al. 1964). Living cell membranes are selective, allowing water to pass, but not most ions or polar molecules (Kotyk and Janáček 1975).

Protons are not capable of passively diffusing through the cell membrane under normal physiological conditions. Active pumps use proton gradients to run certain chemical reactions. The most important energy requiring steps in the cell are the metabolism of macromolecules and transport of essential solutes against their concentration gradients. The membrane link electron transport chain is a commonly known process that creates proton gradients around cell membranes in respiring organisms. Since the membrane is impermeable to H<sup>+</sup>, the flow of protons out of the cell creates a proton gradient which is composed of two components (Neidhardt et al. 1990; Axelsson 1993), a proton concentration gradient, ΔpH, and an electrical charge gradient, ΔΨ. The sum of these two gradients creates a potential energy called proton motive force (PMF), defined as follows:

$$\text{Proton motive force} = \Delta\text{pH} + \Delta\Psi \tag{1}$$

The proton motive force can be used for a variety of purposes by the cell, including active transport of certain molecules against their concentration gradients, reduction of nicotinamide adenine dinucleotide (NAD), and synthesizing adenosine triphosphate (ATP) from adenosine diphosphate (ADP) (Neidhardt et al. 1990).

When a cell of radius  $R$  is exposed to an external electric field ( $E$ ), charge accumulates at the membrane surface, establishing a potential difference ( $\Delta\Psi$ ) that is maximal at the ends that are in line with the field (Tsong 1992). The maximum  $\Delta\Psi$  is

$$\Delta\Psi_{\max} = 1.5 R E \quad (2)$$

For alternating currents, the charging time of the membrane is significant. The following equation should be used:

$$\Delta\Psi_{\max} = 1.5 R E \{1 + (2\pi f\tau)^2\}^{1/2} \quad (3)$$

where  $f$  = frequency in Hz,  $\tau = RC$  ( $r_{\text{int}} + r_{\text{ext}}/2$ ),  $R$  = radius of cell,  $C$  = capacitance/area,  $r_{\text{int}}$  = electrical resistance of cell fluid, and  $r_{\text{ext}}$  = electrical resistance of the external medium. Living cells have a natural potential difference ( $\Delta\Psi_{\text{nat}}$ ) of approximately  $-150$  mV (Coster 1965), which must be added to the induced field.

Because the natural field is uniform, an externally applied field will be hyperpolarizing at the pole facing the positive electrode (anode) and depolarizing at the pole facing the negative electrode (cathode). Thus, the maximum potential difference will be only at one pole, and will be

$$\Delta\Psi_{\max} = \Delta\Psi_{\text{nat}} - 1.5 R E \quad (4)$$

Under alternating conditions, these poles will reverse themselves with each cycle. Because of the effect of cell radius, larger cells will have a larger  $\Delta\Psi$ . Within dormant bacterial spores, electrolytes are immobile (Carstensen et al. 1971), so the  $\Delta\Psi$  should be much less than for normal cells. The membranes of dead cells lose their selectivity (Zhang et al. 1992; Osterhout 1922) and will therefore not maintain any voltage gradient.

The maximum electric field within the cell membrane ( $E_m$ ) is simply the  $\Delta\Psi_{\max}$  divided by the membrane thickness ( $d$ ), which is about 10 nm for plants (Fensom 1985). Thus,

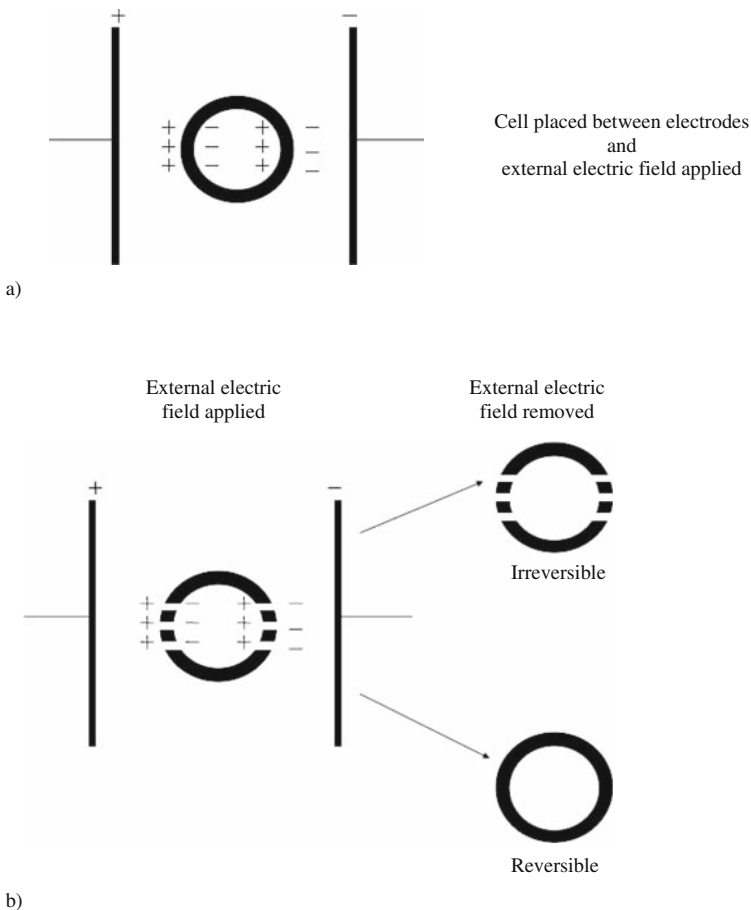
$$E_m = (\Delta\Psi_{\text{nat}} - 1.5 R E)/d \quad (5)$$

As an example of a food application, beet cells have a  $\Delta\Psi_{\text{nat}}$  of  $-154$  mV (Zhang et al. 1992) and an approximate diameter of  $45 \mu\text{m}$  (Joersbo et al. 1990). The  $E_m$  of a beet cell will increase from about  $1.54 \times 10^5$  V/cm to  $2.36 \times 10^5$  V/cm when placed in an electric field of 24 V/cm, which is typical of our laboratory MEF conditions. This corresponds to a hyperpolarization of 83 mV, for a  $\Delta\Psi_{\max}$  of 233 mV.

Coster (1965), while charging the membranes of giant algal cells with a micro-electrode, observed that hyperpolarizing currents caused a sudden increase in

permeability when the membrane potential reached about  $-300$  mV. He called the phenomenon “punch-through,” but it is now known as “electroporation” or “electropermeabilization.” Zimmerman et al. (1974) used an externally applied high-voltage field to cause “dielectric breakdown” of red blood cell membranes (Fig. 2).

Most research on electroporation uses a PEF method, which is used to insert DNA into cells during transformation. Molecules, such as DNA, that are to be inserted are included in a suspension of cells that are electroporated. Under the right conditions, pores are formed in the membrane through which diffusion occurs. The surface of a pore is continuous with the inner and outer surfaces of the cell



**Fig. 2** Diagram of electroporation of a live cell. (a) Cell has been placed between electrodes and an external electric field was applied. Charges accumulate on the cell membrane. (b) When the external electric field reaches a threshold value, pore formation occurs. If the external electric field increases above a critical level, pore formation is irreversible. Otherwise, the electroporation is reversible

membrane, which is composed of phospholipids (Stein and Danielli 1956). Therefore, they have a negatively charged surface surrounded by hydrogen ions. They are normally permeable to water, but not to most ions or other molecules larger than water (Kotyk and Janáček 1975). The Weaver model suggests that when the electric field is applied and the ions are trying to respond, but before the pore expands, the ions can move more easily near the pore because the higher capacitance allows more charge accumulation, whereas a thinner layer of ions near the surface of the lipid layer would create a charge repulsion force counteracting the electric field. When a cell is exposed to an electric field, the ions accumulating at the membrane surface are preferentially drawn to the aqueous pores, which have a much higher capacitance than the lipid fraction of the membrane (Weaver 1987).

The ions pushing on the pore cause a pressure that expands it. When the hole has become large enough for ions to pass through, a decrease in resistance is measured. Experiments that used single pulses of 10 ns to 1000  $\mu$ s revealed that the threshold breakdown voltage is inversely proportional to pulse duration (Zimmerman and Benz 1980; Joersbo et al. 1990). That is, a longer pulse can cause breakdown at a lower field strength. Because it takes several minutes for the cell membrane to recover completely (Zimmermann and Benz 1980), pulses given in quick succession (every 0.5 s) have a cumulative effect (Lindsey and Jones 1987).

MEF treatments that use alternating current are analogous to a sequence of pulses. The number of pulses per second is simply the frequency. The duration of an equivalent pulse would be the time spent above the threshold voltage and is therefore a function of the voltage amplitude, the threshold voltage, and the frequency. Pulsed radio frequency (Chang 1989) and 50 Hz alternating current (Joersbo and Brunstedt 1990) pulses have been used for electroporation.

Both the pore formation (Zimmerman and Benz 1980) and resealing events (Lindsey and Jones 1987) are faster at higher temperatures. Diffusion through pores will continue after electroporation for minutes at 35°C to hours at 4°C (Lindsey and Jones 1987). This is accompanied by a decrease in electrical resistance which is recovered when the pores reseal (Zimmerman and Benz 1980).

The size of pores determines the permeability of the membrane to molecules of various sizes. Pore size can be controlled by the ionic strength of the suspension medium (Kinosita and Tsong 1977). High ionic strength media cause formation of small pores, whereas large pores result from those of low ionic strength.

### **3 Food Engineering Applications of MEF Processes**

#### ***3.1 Drying Rate***

Several studies have shown enhanced drying rate of MEF-treated vegetables and fruits when compared to untreated, conventionally treated, or microwave-treated samples. Wang and Sastry (2000) compared raw samples with those pretreated to 50°C and 80°C using conventional, microwave and MEF treatment at 60 Hz and 40 V/cm, and found that MEF treatment resulted in the largest enhancement of the



subsequent drying rate of carrot, yam, and potato cylinders. Microwave and conventional pretreatments showed some drying acceleration, and so part of this effect can be explained by thermal effects. However, the visually observable moisture migration in the samples, the difference in desorption isotherms, and the residual enhancement of drying by MEF fields indicate that there are also nonthermal effects on the tissue structures affecting moisture mobility. Zhong and Lima (2003) studied the effect of different treatment combinations (electric field strengths of 50, 70, and 90 V/cm; end-point temperatures of 45°C, 60°C, and 80°C) on the vacuum drying rates of sweet potato cubes. For most treatment combinations, the vacuum drying rates of MEF-treated samples were higher than those for untreated samples, and the maximum reduction in drying time was 24%.

Lima and Sastry (1999) investigated the effect of frequency and waveform of the alternating current on the hot-air drying rate of yam (60 Hz sine wave and 4 Hz sawtooth wave). Significantly higher drying rates were obtained using a 4 Hz sawtooth wave as compared to a 60 Hz sine wave. For food materials with an outer skins, such as grapes and berries, the rate of moisture diffusion during drying is largely dependent on permeability of skin to the moisture. Salengke and Sastry (2005) observed a significant increase in the drying rate of grapes by MEF (15 V/cm) pretreatment to 60°C at 30 Hz and 60 Hz, but not at 7.5 kHz. They also observed tears in the grape skins, which were more pronounced at the lower frequencies. The strong effect of frequency indicates a nonthermal electric field effect, since in this range frequency affects electroporation, but not heating rates.

The increases in mass transfer in these drying studies are thought to be caused by increases in cell membrane permeability caused by the electric field, which allow the moisture to escape the tissue matrix.

### ***3.2 Extraction***

Enhanced extraction of sugar from sugar beet using MEF treatment was observed by several researchers. Fedorenchenko et al. (1983) observed greater decline in resistivity of sugar beet cossettes during extraction with application of an electric field (10 V/cm DC) and greater purity of juice. Jemai and Vorobiev (2003) applied MEF pulses (160–780 V/cm) during sugar extraction and observed increases in both electrical conductivity and soluble solids that had diffused from the cossettes. Lebovka et al. (2007) also observed disintegration of sugar beet tissues under MEF conditions of 20–100 V/cm at 50 Hz, with a large increase in effect occurring between 20 V/cm and 30 V/cm. Kim and Pyun (1995) observed enhanced diffusion of soy milk from soybeans. Solid and protein yields were increased by approximately 16% and 25 %, respectively, when the soy slurry was heated using a 12.5 V/cm voltage gradient. Praporscic et al. (2006) investigated the effect of temperature and MEF treatment (18–100 V/cm at 50 Hz) on the juice yields from apple and potato tissues. The best efficiency of juice extraction from pressing was observed when the tissue was treated electrically at a temperature of 50°C.

Schreier et al. (1993) compared the diffusion of dye from beetroot using MEF (3–20 V/cm) and conventional heat treatment to 75°C. These investigators estimated a 40% enhanced diffusion effect for MEF treatment, and observed that the concentration of diffused dye was directly proportional to beetroot particle surface area, and a linear function of electric field strength. Lima et al. (2001) also studied diffusion of beet dye during electrical and conventional treatment, but under a continuous electric field and at constant temperature. Enhanced diffusion was observed under MEF treatment (24 V/cm, 60 Hz) as compared to conventional heat treatment at 42°C and 58°C, but not at 72°C. The cellular structure of beetroot begins to break-down at around 60°C, and significant amounts of beet dye are released into the solution (Halden et al. 1990). At high temperatures, the thermal effect is probably more prominent.

Kulshrestha and Sastry (2003) measured diffusion of dye from beet cubes during a 3 min MEF process using frequencies ranging from 0 (direct current) to 5000 Hz and field strengths ranging from 0 (conventional heating) to 24 V/cm, while maintaining a steady-state temperature at 45°C throughout the process. Except for direct current, diffusion enhancement by MEF processing increased with increasing field strength and decreasing frequency. In this study, there appears to be a threshold potential above which significant increases in permeabilization occur. The threshold potential level for permeabilization was found to increase as the frequency increased, except for DC.

Lima and Sastry (1999) found that MEF treatment of apple tissue prior to mechanical juice extraction significantly increased apple juice yields with respect to untreated apple tissue. Significantly higher juice yields from apples were obtained using a 4 Hz sawtooth wave as compared to a 60 Hz sine wave at 40 V/cm. Jemai and Vorobiev (2002) found an increase in the diffusion coefficient of soluble substances from apple tissue when MEF pulses were applied (500 V/cm, 1000 pulses, 100  $\mu$ s duration). Sensoy and Sastry (2004) studied the effect of MEF treatment (0–125 V/cm and 50 Hz to 5 kHz) on the extraction yields for fresh and dried mint leaves and fermented black tea leaves. MEF treatment significantly increased the extraction yield for fresh mint leaves. However, no enhancement was observed in previously dried cellular materials, such as dried mint leaves and fermented black tea leaves. Enhancement was greatest at the lowest frequency.

Enhanced extractions observed on MEF treatment described so far have used food samples that possess minimal to moderate amounts of lipids and high moisture contents. Lakkakula et al. (2004) studied the MEF effect on the extraction yields from low moisture, high fat food: oil extraction from rice bran. Ohmic heating increased the lipids extraction yield from rice bran to a maximum of 92%, while 53% of total lipids were extracted from the untreated samples. Lowering the frequency of the alternating current (60 to 1 Hz) significantly increased the amount of oil extracted.

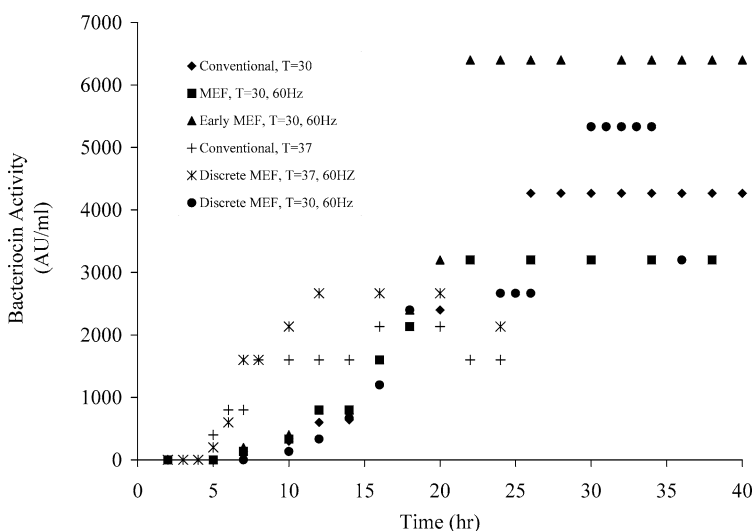
Evidence for pore formation has been provided by Yoon et al. (2002), who found more exuded intracellular materials of *Saccharomyces cerevisiae* under MEF treatment compared to conventional heat treatment under a similar time-temperature history. They also supported this result by morphological observations. They

suggested electropore formation as the main reason for the increase in transmembrane permeability.

Extraction applications are improved by MEF treatments, especially at lower frequencies. Electroporation is a likely mechanism, with the increase in permeability allowing the solutes to leach from the cellular matrix.

### 3.3 Fermentation

Several studies have been conducted on the stimulation effects of alternating electric current on microbial growth. Kliewe and Neidl (1952) reported that the growth of various bacteria is stimulated by 50 Hz alternating current. Carlson (1954) reported that alternating current causes an increase in enzymatic activity of living cells. Shimada and Shimahara (1977) have reported that alternating current of 50 Hz influenced the growth lag phase of *E. coli* B depending on the inoculum size, shaking rate during cultivation, and composition of the medium. However, Rowley (1972) presented results showing that alternating current had little or no effect on the growth rate of microorganisms in the frequency range of 1–60 Hz and current range of 15–30 mA. Treatment conditions in the above studies have varied widely and several results are apparently contradictory. Experimental details in the above studies are also insufficient to make a general conclusion on the effect of electricity on microorganisms. However, recent studies under controlled temperature conditions have shown that MEF at 50–60 Hz and 1 V/cm accelerates growth in the early stage of the fermentation of *Lactobacillus acidophilus* (Cho et al. 1996; Loghavi



**Fig. 3** Production of bacteriocin, measured in arbitrary units (AU/ml), during fermentation of *L. acidophilus* OSU133 for different experimental treatments (T: temperature (°C)). Reproduced from Loghavi et al. (2007)

et al. 2007) and *Lactococcus lactis* (Unal 2000). MEF treatment at 60 Hz also increases the bacteriocin production of *Lactobacillus acidophilus* (Fig. 3; Loghavi et al. 2007). This may be due to slow pH decline at suboptimum temperature, longer lag time, and the role of the electric field in altering the mechanism of production and release of prebacteriocin. These results indicate that MEF fermentations can add economic benefits by decreasing the fermentation operation time and potentially increasing bacteriocin production.

## 4 Conclusion

There is a growing body of research demonstrating the advantages of MEF processing in extraction, drying, and fermentation operations. If a thermal process is desired, MEF may have advantages over conventional heating under certain conditions that promote rapid and uniform heating. However, this chapter has focused on the nonthermal effects of MEF fields on cell membranes, particularly the increase in permeability that facilitates mass transfer during extraction and drying operations. In the above applications, electroporation seems to be an important mechanism in extraction and drying of plant tissues. MEF also has a demonstrated advantage in fermentation processes. However, bacterial cells are much smaller than plant cells, and there are still few studies of MEF treatments during fermentation. Further research will be required to understand the mechanisms of the effect of MEF on fermentation processes. This technology is continuing to be developed as a deepening understanding of the underlying mechanisms allows researchers to optimize food process operations accordingly.

## References

- Axelsson, L.T. (1993) Lactic acid bacteria: Classification and physiology. In: Salminen, S., and Wright, A.V. (Eds.), *Lactic Acid Bacteria*. Marcel Dekker, New York, pp. 1–64.
- Carlson, V.S. (1954) Arch. Hyg. Bacteriol. 137, 86–95.
- Carstensen, E.L., Marquis, R.E., and Gerhardt, P. (1971) Dielectric study of the physical state of electrolytes and water within *Bacillus cereus* spores. J. Bacteriol. 107, 106–113.
- Chang, D. (1989) Cell fusion and cell poration by pulsed radio-frequency electric fields. In: Neumann, E., Sowers, A., and Jordan, C.A., (Eds.), *Electroporation and Electrofusion in Cell Biology*, Plenum Press, New York, ch. 14, pp. 215–227.
- Cho, H.Y., Yousef, A.E., and Sastry. S. (1996) Growth kinetics of *Lactobacillus acidophilus* under ohmic heating. Biotechnol. Bioeng. 49, 334–340.
- Coster, H.G.L. (1965) A quantitative analysis of the voltage-current relationships of fixed charge membranes and the associated property of "punch-through". Biophysic. J. 5, 669–686.
- Fedorenchenko, L.A., Guly, I.S., Bazhal, I.G., Bobrovnik, L.D., Karpovich, N.S., Zabrodskaya, Y.A., and Martynenko, T.A. (1983) The effects of a low-voltage electric field on the electrical resistivity of beet tissue during the extraction process (in Russian). Sahar. Prom. 2, 23–24.
- Fensom, D.S. (1985) Electrical and magnetic stimuli. In: Pharis, R.P. and Reid, D.M., (Eds.) *Encyclopedia of Plant Physiology, Vol. 11, Hormonal Regulation of Development 3: Role of Environmental Factors*, Springer-Verlag, Berlin, ch. 17, pp. 625–652.

- Halden, K., De Alwis, A.A.P., and Fryer, P.J. (1990) Changes in electrical conductivity of foods during ohmic heating. *Int. J. Food Sci. Technol.* 25, 9–25.
- Imai, T., Uemura, K., Ishida, N., Yoshizaki, S., and Noguchi, A. (1995) Ohmic heating of Japanese white radish *Rhaphanus sativus L.* *Int. J. Food Sci. Technol.* 30(4), 461–472.
- Jemai, A.B., and Vorobiev, E. (2002) Effect of moderate electric field pulses on the diffusion coefficient of soluble substances from apple slices. *Int. J. Food Sci. Technol.* 37, 73–86.
- Jemai, A.B., and Vorobiev, E. (2003) Enhanced leaching from sugar beet cassettes by pulsed electric field. *J. Food Eng.* 59, 405–412.
- Joersbo, M., and Brunstedt, J. (1990) Direct gene transfer to plant protoplasts by electroporation by alternating, rectangular and exponentially decaying pulses. *Plant Cell Rep.* 8, 701–705.
- Joersbo, M., Brunstedt, J., and Floto, F. (1990) Quantitative relationship between parameters of electroporation. *Plant Physiol.* 137, 169–174.
- Kemp, M.R., and Fryer, P.J. (2007) Enhancement of diffusion through foods using alternating electric fields. *Innovative Food Sci. Emerging Technol.* 8, 143–153.
- Kim, J., and Pyun, Y. (1995) Extraction of soy milk using ohmic heating. *Abstract, Ninth Congress of Food Science and Technology*, Budapest, Hungary.
- Kinosita, K., and Tsong, T.Y. (1977) Formation and resealing of pores of controlled sizes in human erythrocyte membrane. *Nature* 268, 438–441.
- Kliewe, V.H., and Neidl, G. (1952) *Arch. Hyg.* 136, 265–281.
- Kotyk, A., and Janáček, K. (1975) *Cell Membrane Transport*, 2nd ed. Plenum Press, NY.
- Kulshrestha, S., and Sastry, S.K. (2003). Frequency and voltage effects on enhanced diffusion during moderate electric field (MEF) treatment. *Innovat. Food. Sci. Emerg. Tech.* 4, 189–194.
- Lakkakula, N.R., Lima, M., and Walker, T. (2004) Rice bran stabilization and rice bran oil extraction using ohmic heating. *Biores. Technol.* 92, 157–161.
- Lebovka, N.I., Shynkaryk, M., and Vorobiev, E. (2007) Moderate electric field treatment of sugar-beet tissues. *Biosys. Eng.* 96(1), 47–56.
- Lima, M., and Sastry, S.K. (1999) The effects of ohmic heating frequency on hot-air drying rate and juice yield. *J. Food Eng.* 41, 115–119.
- Lima, M., Heskitt, B., and Sastry, S. (1999) The effect of frequency and wave form on the electrical conductivity – temperature profiles of turnip tissue. *J. Food Process Eng.* 22(1), 41–54.
- Lima, M., Heskitt, B.F., and Sastry, S.K. (2001) Diffusion of beet dye during electrical and conventional heating at steady-state temperature. *J. Food Process Eng.* 24, 331–340.
- Lindsey, K., and Jones, M.G.K. (1987) The permeability of electroporated cells and protoplasts of sugar beet. *Planta* 172, 346–355.
- Loghavi, L., Sastry, S.K., Yousef, A.E. (2007) Effect of moderate electric field on the metabolic activity and growth kinetics of *Lactobacillus acidophilus*. *Biotechnol. Bioeng.* 98(4), 872–881.
- Neidhardt, F.C., Ingraham, J.L., and Schaechter, M. (1990) *Physiology of the Bacterial Cell, a Molecular Approach*. Sinauer, Massachusetts.
- Osterhout, W.J.V. (1922) *Injury, Recovery, and Death, in Relation to Conductivity and Permeability*. J. B. Lippincott, Philadelphia.
- Praporscic, I., Lebovka, N.I., Ghnimi, S., and Vorobiev, E. (2006) Ohmically heated, enhanced expression of juice from apple and potato tissues. *Biosys. Eng.* 93(2), 199–204.
- Rowley, B.A. (1972) Electrical current effects on *E. coli* growth rates. *Proc. Soc. Exptl. Biol. Med.* 139(3), 929–934.
- Salengke, S. and Sastry, S.K. (2005) Effect of ohmic pretreatment on the drying rate of grapes and adsorption isotherm of raisins. *Drying Technol.* 23, 551–564.
- Schreier, P.J.R., Reid, D.G., and Fryer, P.J. (1993) Enhanced diffusion during the electrical heating of foods. *Int. J. Food Sci. Tech.* 28, 249–260.
- Sensoy, I., and Sastry, S.K. (2004) Extraction using moderate electric fields. *J. Food Sci.* 69(1), FEP 7–FEP 13.

- Shimada, K., and Shimahara, K. (1977) Effect of alternating current on growth lag in *Escherichia coli* B. J. Gen. Appl. Microbiol. 23, 127–136.
- Stein, W.D., and Danielli, J.F. (1956) Disc. Faraday Soc. 21, 238.
- Tsong, T.Y. (1992) Time sequence of molecular events in electroporation. In Chang, D.C., Chassey, B.M., Saunders, J.A., and Sowers, A.E. (Eds.) *Guide to Electroporation and Electrofusion*. Academic Press, San Diego, ch. 4, pp. 47–61.
- Unal, R. (2000) *Interaction of Microorganisms with Electricity: Growth Kinetics of Lactococcus lactis subsp. lactis ATCC 11454 Under Sublethal Ohmic Heating*. PhD. Dissertation, The Ohio State University, Columbus, OH.
- Wang, W.C. and Sastry, S.K. (2000) Effects of thermal and electrothermal pretreatments on hot air drying rate of vegetable tissue. J. Food Process Eng., 23, 299–319.
- Weaver, J.C. (1987) Transient aqueous pores: a mechanism for coupling electric fields to bilayer and cell membranes. In: Blank, M., and Findl, E., (Eds.), *Mechanistic Approaches to Interactions of Electric and Electromagnetic Fields with Living Systems*. Plenum Press, New York, pp. 249–270.
- Williams, E.J., Johnston, R.J., and Dainty, J. (1964) The electrical resistance and capacitance of the membrane of *Nitella translucens*. J. Exp. Bot. 15, 1–14.
- Yoon, S.W., Lee, S.Y.J., Kim, K.M., and Lee, C.H. (2002) Leakage of cellular material from *Saccharomyces cerevisiae* by ohmic heating. J. Microbiol. Biotechnol. 12(2), 183–188.
- Zhang, Q., Läubli, A., and Greenway, H. (1992) Effects of anoxia on solute loss from beetroot storage tissue. J. Exp. Bot. 43(252), 897–905.
- Zhong, T. and Lima, M. (2003) The effect of ohmic heating on vacuum drying rate of sweet potato tissue. Bioresource Technol. 87, 215–220.
- Zimmerman, U., and Benz, R. (1980) Dependence of the electrical breakdown voltage on the charging time in *Valonia utricularis*. Membrane Biol. 53, 33–43.
- Zimmerman, U., Pilwat, G., and Riemann, F. (1974) Dielectric breakdown of cell membranes. Biophys. J. 14, 881–899.

# DC Electrical Field Effects on Plant Tissues and Gels

Amos Nussinovitch and Ronit Zvitov

**Abstract** Gels (intermediate between a solid and a liquid) have similarities to both animal and vegetative materials. Most food products are solids composed of 50–90% water, and they can be regarded in many ways as multicomponent gels. Moreover, the cellular structure of fruits and vegetables can be considered a “foam” with a closed-cell geometry, filled with gel. Gels are omnipresent, and as such gel electrification seems to be a necessary step in studying the effects of electrical fields in biology and life. Early studies described the collapse of polyacrylamide gels and the shrinkage of ionic gel beads near the phase-transition point under DC and AC excitations. The similarity between food gels (i.e., alginate, agar, agarose, and gellan) and vegetative materials (cut pieces of potato, sweet potato, kohlrabi, radish, and pear) is reflected in their similar behavior under application of a low DC electrical field (nonthermal effect). Both moieties’ samples shrink under such a field. Surface changes in the shrunken sample, mineral diffusion, changes in the treated specimens’ mechanical properties, and local changes in sample pH have also been observed. In potato, inhibition of browning and reduction in polyphenol oxidase activity are detected. Similar to gels, pores are produced in the vegetative tissue (from the anode side), promoting slow release of cell components. Electrification of vegetative tissues in fluid results in induced extraction of soluble solids, pigments, and minerals with almost no alteration of those tissues’ gross textural properties. It is therefore possible to simultaneously obtain the desired ingredients and utilize the tissue that is left for further applications, such as pieces to be included in jams or soups, or for individual quick-frozen processes. The electrical treatment displays advantages over ingredient extraction performed by freezing the tissue. Electrification of leaves results in stomatal opening on both sides of the leaf lamina (from both anode and cathode sides), as compared to the closed stomata of the untreated tissues. Possible implications of this stomatal opening could be facilitating water loss from the tissue to enhance drying processes and perhaps ethylene production

---

A. Nussinovitch

The Hebrew University of Jerusalem, Faculty of Agricultural, Food and Environmental Quality Sciences, Institute of Biochemistry, Food Science and Human Nutrition, P.O. Box 12, Rehovot 76100 Israel

e-mail: nussi@agri.huji.ac.il

and involvement in the ripening process of fruits. Electrification of vegetative and animal materials, gels in particular, by low-intensity DC electrification could be of interest in many future biotechnological, medicinal, food, and agricultural applications.

## 1 Introduction

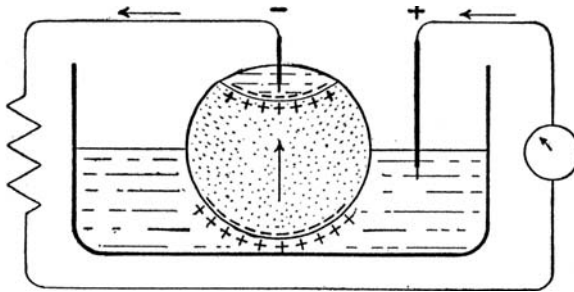
Scientists, philosophers, and laymen alike have long speculated on the possible relationship between life and electricity. This has been a natural pursuit, for both life and electricity are extraordinary forces. Increasing knowledge has strengthened, rather than decreased the ancient part scientific, part superstitious belief that electricity is a potent and all-pervading life force (Seifriz 1936).

About 100 years ago, it was only natural for a scientist to pass a current through an object in order to study its influence on the condition/behavior of the electrified item. Thus, experimental physiology began with Galvani's observation (performed in Bologna in 1789) that a muscle contracts if touched by two metal strips, one out of copper and the other, zinc. From this he drew two conclusions—that the production of an electrical current is a cause of muscular contraction and that the origin of the current is the life force within the muscle. The first conclusion is correct; the second not justified (Seifriz 1936). Galvani's experiments led Volta of Pavia, in 1800, to construct the kind of electrical cell that now goes by his name.

We are surrounded by plants, and can attribute part of our existence to the vegetative kingdom; therefore, the relationships between vegetative commodities and currents, potentials, or charges are of interest to the researcher. It is thus not surprising that a few experiments involving electrical phenomena and vegetative organs rather than muscles have been performed. Although there is some question as to whether an apparatus for determining the potential difference between the cut and whole surface of a fruit (Beutner 1920) was the first investigative tool, it is clear that at that time (ca. 1900), attempts to check the relationships between electricity and objects were the trend, and of great scientific interest. Beutner performed an experiment in which an apple was placed in a bowl containing a salt solution (0.01 M KCl). A depression cut in the top of the apple held a similar salt solution and an electrode (or agar bridge leading to an electrode). The measured potential involved at least three differences, that is, between the inner and outer sides of the cut surface, between the inner and outer sides of the intact skin, and between the cut surface and the intact skin. Beutner concluded that in the apple, the flow of current is from the inner surface of the lower untouched skin, which must, therefore, be negative, to the inner surface of the upper, cut area, which is, therefore, positive (Fig. 1).

Those early studies, dealing with electrification of muscle (frog's leg—animal kingdom) or measuring potential differences between the cut and whole surface of a fruit (apple—vegetative kingdom), led to more complex experiments. It was thought/concluded that a better understanding of the inherent changes within tissues after electrification could only be achieved by conducting broad research in this direction.





**Fig. 1** Diagram of the flow of current (i.e., electrons) from the cut (*upper*) surface of an apple containing a salt solution and an electrode, through a resistance, a galvanometer, an electrode, and a surrounding electrolytic solution, to the whole (*bottom*) surface of the apple and through it; from Seifriz (1936)

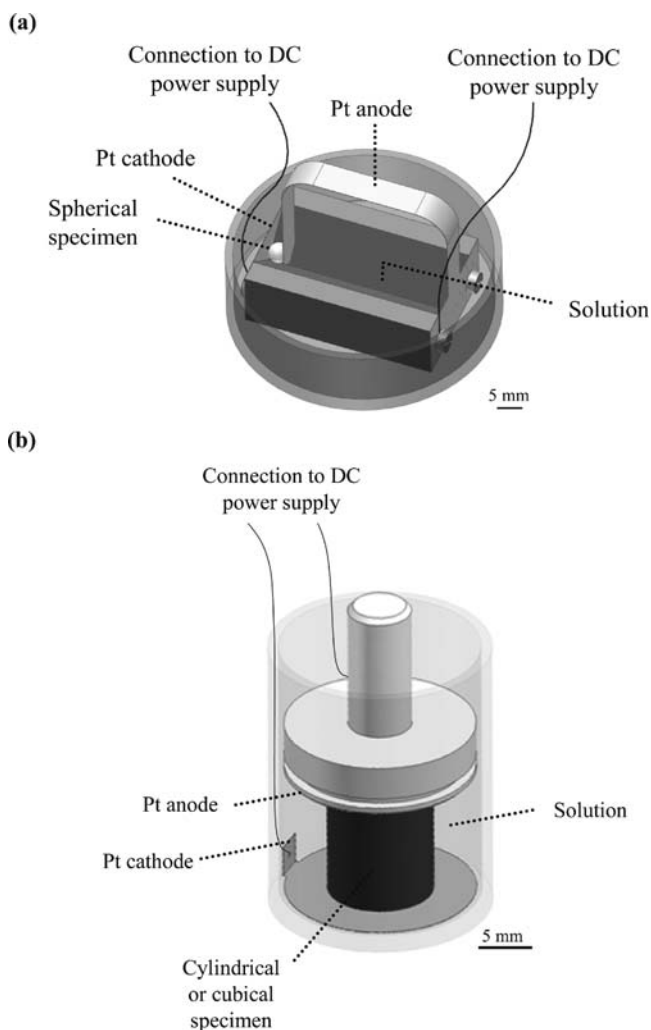
Indeed, over the last decades, extensive studies have been conducted on the effect of various electrification methods on different tissues, particularly foods. Electricity has been applied to foods by ohmic heating, low-electrical-field stimulation, high-voltage arc discharge, low-voltage alternating current, and high-intensity pulsed electrical fields (Barbosa-Canovas et al. 1999; Chen et al. 1994; Knorr et al. 1994; Rastogi et al. 1999; Wang and Sastry 1997). All have been used to achieve practical and indeed necessary aims, such as food preservation, bacterial control, or enzyme inactivation toward longer shelf life, while retaining nutritional value and organoleptical properties (Barbosa-Canovas and Zhang 2001). Several research groups studied the use of pulsed electrical fields (PEF) as an alternative to conventional food processing methods with potential applications such as cold sterilization of liquid foods for instant juices, cream soups, and milk and egg products (Barbosa-Canovas et al. 1999). Other researchers applied low-intensity DC electrical fields to gels and plant tissues to study their effect on solid vs. liquid moieties (Zvitov and Nussinovitch 2001a; Zvitov et al. 2003b). This partial list of old and new studies demonstrates mankind's continual interest in electricity and electrification and reveals that ~70–80 years ago, scientists studied electrical currents and their influences on both intact commodities and induced sap flow within plants (Lund 1930).

## 2 Electrical Apparatus and Measurement Systems

Samples are electrically treated using custom-made apparatuses that are suitable for both spherical (Fig. 2a) (Zvitov and Nussinovitch 2001b, 2005; Zvitov et al. 2004) and cylindrical/cubic samples (Fig. 2b) (Nussinovitch and Zvitov 2004, 2007).

The treated samples (different gels or plant tissues) are placed between a pair of platinum (Pt) electrodes. A voltage ranging from 0 to 40 V is applied across the

electrodes with a DC power supply. Relatively low electrical field strengths (usually up to 40 V/cm) are used in order to minimize the absorption energy of the treated systems, which could be transformed into heat. The voltage and current data are recorded on a dual-channel 20 MS/s digitizer (or similar equipment) using a high-voltage probe. Voltage and current through the samples are measured using a true RMS multimeter. The electrical treatment can be controlled by using a feedback measuring system (Fig. 3) when needed (e.g., in cases in which the samples are sensitive to heat, etc.).



**Fig. 2** Electrical apparatus: (a) for circular specimens; (b) for cylindrical specimens

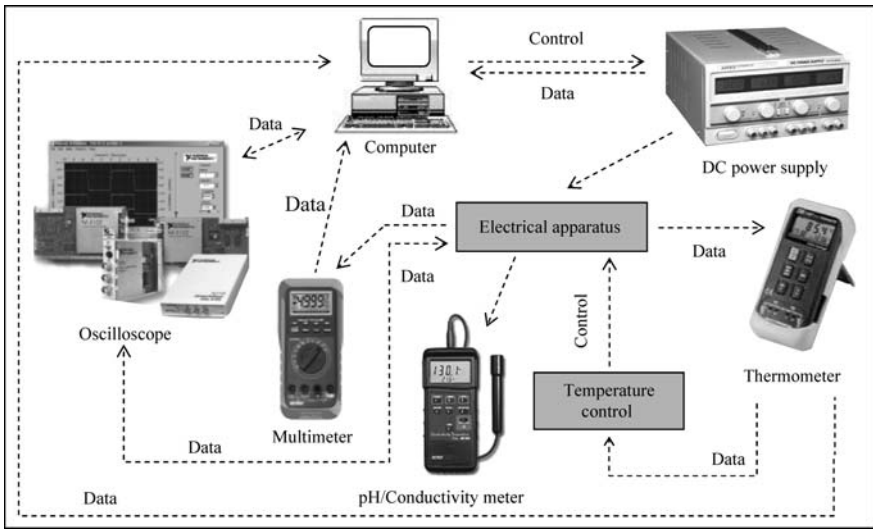


Fig. 3 Feedback system for DC electrical field application

### 3 Electrification of Gels

Most of the up-to-date research relates to electrification of liquids, suspensions, dispersions, and the like. Only a few very old and new publications deal with electrification of solids and semisolids. A solid object is characterized by its resistance to deformation and changes in volume. On the microscopic scale, the atoms or molecules that comprise the solid are packed closely together. A semisolid is defined as a moiety that lies somewhere between a solid and a liquid, with intermediate properties, particularly rigidity. Examples of semisolid substances include stiff dough or firm gelatin, the latter being a gel.

#### 3.1 Induction of Phase Transition in Gels by Electrical Fields

Gels are used for a great variety of applications, such as immobilizing cells and enzymes, controlling drug release in pharmaceutical preparations, and absorbing urine in disposable diapers, among many others. Nevertheless, there is no agreed-upon definition of a gel. A phenomenological definition is that gels are solid or solid-like materials that consist of two or more components, one of which is a liquid (Almdal et al. 1993). Another textbook definition is that the elastic modulus is greater than the viscous modulus: unlike liquids, gels do not flow as a result of steady shear (Trevors and Pollack 2005). Another definition considers a gel as a form of matter intermediate between a solid and a liquid. It consists of polymers, or long-chain molecules, cross-linked to create a tangled network and immersed in a liquid medium. The properties of the gel depend strongly on the interaction

between these two components (Tanaka 1981). The liquid prevents the polymer network from collapsing into a compact mass; the network prevents the liquid from “escaping” from the formed structure (Nussinovitch 1997). Examples of gels in foods include most starch-thickened puddings and pie fillings, egg custards, and fruit jellies (Nussinovitch 2003). Many other foods include hydrocolloids responsible for thickening or gelling. A partial list of typical gelling agents includes: agar, alginate, gellan, carrageenan, pectin, and curdlan, among others. Gels can also be produced by a combination of xanthan and locust bean gum (LBG). Other combinations are also possible (Nussinovitch 1997). Gelatin mixtures can also produce gels (Bennion 1985). Many texts that deal with cooking describe gels as mixtures which have the ability to hold the shape of the container in which they are formed. This is correct, but it should be borne in mind that several shapes can be achieved without using any molds. Spherical gel beads, for example, can be formed by dropping, spraying, etc. Gels may vary from soft to fairly rigid moieties. They can also gain softness, elasticity, or resilience and therefore are good candidates for electrification. Moreover, gels or “gel-like” materials fill the eyeball, make up the brain, and are included in the knee joint, and as such their study is important from a biological point of view.

Hydrocolloid gels can change their volume considerably when they are immersed, as they exchange water and solutes with their environment. Such processes are attributed to changes in the polymer network’s structure. The direction and intensity of the change can be affected by many factors, such as temperature, pH, UV light, special molecules or chemicals, solvent composition, and electrical fields (Tanaka 1981; Tanaka et al. 1982; Zvitov and Nussinovitch 2001b).

The first report on electrical-field-induced deformation of polyelectrolyte gels was authored by Hamlen et al. (1965). They observed that an ionic polyvinyl alcohol (PVA) gel fiber, which was placed touching an anode in 1% NaCl solution, shrank on the anode side as a result of an applied DC moderate electric field (MEF) of 5 V. When the polarity of the applied voltage was changed, the deformed gel swelled to its initial size in the absence of the electrical field (Hamlen et al. 1965). Almost 26 years ago, a pioneering study described the phenomenon of gel collapse in an electrical field. Early experiments were carried out with gels that had a polymer matrix of cross-linked polyacrylamide (Tanaka 1981). The preparation of the gel begins with two monomers: acrylamide, which is a small organic molecule that terminates in an aminocarbonyl ( $-\text{CONH}_2$ ) group, and bisacrylamide, which consists of two acrylamide monomers that are linked through their aminocarbonyl groups. The monomers are dissolved in water, then two more initiators are added—ammonium persulfate and tetramethylethylenediamine (TEMED). Polymerization takes about 30 min. After a few hours, the gel is washed to remove untreated monomers or initiators. The final step includes conversion by basic hydrolysis of aminocarbonyl groups into carboxyl groups ( $-\text{COOH}$ ). In solution, some of the groups spontaneously ionize to yield  $\text{H}^+$  and  $\text{COO}^-$  ions (Tanaka 1981). The electrical field affects both the negative and the positive charges in the gel. The hydrogen ions flow towards the negative electrode. The negative charges of the carboxyl groups, on the other hand, are attached to the polymer matrix; therefore, the polymer

is drawn towards the positive electrode. The directed force gives rise to a negative pressure in the gel. The pressure varies along the length of the gel and where it is sufficient, it brings about a phase transition (Tanaka 1981). In other words, an infinitesimal change in electrical potential across a polyelectrolyte gel produces a discrete reversible volume change. The volume of the collapsed gel can be several hundred times smaller than that of its swollen counterpart (Tanaka 1981; Tanaka et al. 1982). A few years later, shrinking of ionic gel beads near the phase-transition point under DC and AC excitation was described. The complex behavior of the gel was associated with ion drift (Hirotsu 1987). Another report from the same year described deformation of a gel in an electrical field. The gel was placed at a fixed position, separate from the two electrodes. The surrounding solution was NaOH. When the concentration of NaOH was high, the gel swelled at the anode side in the presence of the electrical field. When the concentration was low, the gel shrank at the anode side (Shiga and Kurauchi 1990). These authors explained that the swelling deformation occurs through a change in osmotic pressure due to the ionic distribution inside and outside the gel in the presence of an electrical field (Shiga and Kurauchi 1990).

In addition to Tanaka's explanation of the gel's volume collapse due to phase transition (Tanaka et al. 1982), gel shrinkage in a DC electrical field has been explained as an electrokinetic phenomenon (Osada et al. 1987), and as a local pH change near the electrode (Doi et al. 1992; Hirose et al. 1992). However, most of the moieties examined consisted of polyacrylamide gels in water/acetone combinations (Tanaka et al. 1982) or some other synthetic polymer (DeRossi and Chiarelli 1994; Gong et al. 1997; Kishi et al. 1990; Osada et al. 1991). Another report deals with an electrically driven "chemomechanical system." This system was made of water-swollen synthetic polymer gel (weakly cross-linked poly(2-acrylamido-2-methylpropane sulfonic acid) (PAMPS)) suspended in a solution of the surfactant *N*-alkyl-pyridinium (CnPyCl). Upon application of a DC electrical field, the gel showed significant and rapid bending toward the anode. If the polarity of the electrical field was altered every 2 s, the gel showed repeated pendulum-like swinging in the surfactant solution (Ueoka et al. 1997).

Gels that react to electrical stimuli are very important and may be useful in the food industry, as well as in various other fields, such as biotechnology and medicine. Studies have been performed over the years on their electrification in different fluids under DC electrical fields. Only a few studies have looked at natural networks produced from water-soluble polymers, such as collagen, agar, and alginate (Kishi and Osada 1989; Shoefeld and Gradzinsky 1980; Wahab et al. 1997). In a series of manuscripts, Zvitov and Nussinovitch caused electrical-induced shrinkage of hydrocolloid gels (alginate, agar, agarose, and gellan) and studied changes in their shape, porosity, mechanical properties and chemistry caused by the electrical treatment. These authors provided detailed explanations for the results, suggesting a mechanism for the observations and identifying the resemblance between electrified plant tissues and gels (Zvitov and Nussinovitch 2001b, 2002; Zvitov et al. 2003b). During these experiments, when gels were electrified to cause small changes in weight/length (up to 40 V/cm) but were still far from collapse, a few major points

were noted, including weight reduction, imprinting of the electrode shape on the surface of the shrunken gel, mineral diffusion, changes in the treated specimens' mechanical properties, and local changes in gel pH, as detailed further on.

### ***3.2 Types of Electrified Networks***

Polyelectrolyte gels consist of a special kind of macromolecule: they are composed of a charged network with fluid filling the interstitial spaces of that network. The intrinsic properties and behaviors observed in these gels are characterized by the nature of the cross-linked charged network associated with their counter-ions and the solvents. These gels exhibit reversible swelling and contraction under various stimuli, including electrical fields. As previously described, electrical-field-induced deformation of polyelectrolyte gels was first reported by Hamlen et al. (1965). A strip of gel placed with its long axis parallel to (but not touching) the electrodes will bend like a bimetal. Gels placed with their length spanning the gap between the electrodes are seen to shrink preferentially at one end. Water dripping from the gel at the cathode has also been reported. Another more recent report deals with the shear modulus of two polyelectrolyte gels (a weak acid with small side groups and a strong acid with large side groups). The modulus was measured with and without application of an electrical field across the gels. Under a steady state field, the measured modulus of these gels was seen to decrease with time. This was explained by migration of the free counterions and associated water towards the cathode (Whiting et al. 2001).

When polysaccharides are used for gel formation, their ionic nature becomes relevant. A wide range of treated gels can include non-ionic, a blend of ionic and non-ionic, or charged polysaccharides. This is why, in Zvitov and Nussinovitch (2003), agar, agarose alginate, and gellan were chosen for further experimentation. Agar is composed of repeating units of D-galactose and 3,6-anhydro-L-galactose (Araki 1958; Cottrell and Baird 1980). Agar extract comprises two groups of polysaccharides: agarose—the gelling component—is an essentially sulfate-free, neutral (non-ionic) polysaccharide (Nussinovitch 1997), and agaropectin—the nongelling ionic (charged) polysaccharide. The percentage of agarose in agar-bearing seaweed can range from 50 to 90 (Araki 1965).

Both alginate and gellan are anionic polysaccharides. Alginic acid is a linear copolymer composed of D-mannuronic acid (M) and L-guluronic acid (G) units. Regions within the acid can consist of one or the other unit, or both monomers in alternating sequence, that is, M blocks, G blocks, or heteropolymeric MG blocks, respectively (Nussinovitch 1997). The molecular structure of gellan gum is a linear chain based on repeating glucose, rhamnose, and glucuronic acid units. In its native, or high acyl form, two acyl substituents—acetate and glycerate—are present. Both substituents are located on the same glucose residue, and on average, there is one glycerate per repeat and one acetate per every two repeats. In low-acyl gellan gum, the acyl groups are completely removed. Deacylation provides gellan gum in this low-acyl form. The acyl groups have a profound

influence on the gel's characteristics. The high-acyl form produces soft, elastic, nonbrittle gels, whereas the low-acyl form produces firm, nonelastic, brittle gels (<http://www.cpkelco.com/products/index.html>).

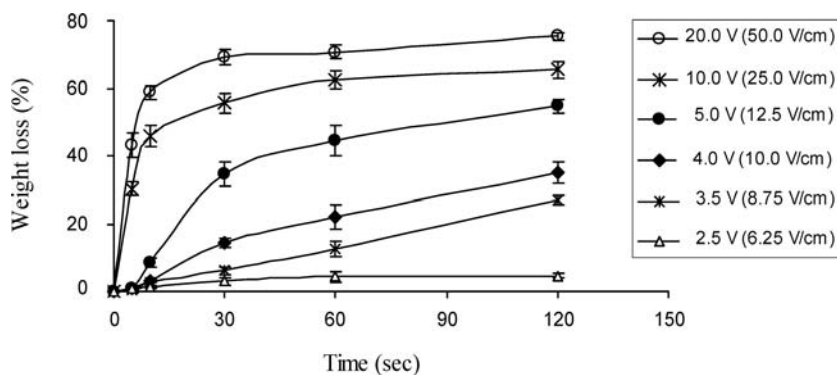
Both the alginate and the low-acyl gellan gums gel with a wide variety of cations. In general, the amount of cross-linking agent added is more than the stoichiometric quantity needed. For example, in alginate, the stoichiometric concentration is 0.075 mg/g alginate, while the concentration in the bath can be higher than 20 mg/g medium (Glicksman 1969).

### 3.3 Electrification of Alginate Gels

#### 3.3.1 Influence of Alginate Gel Composition on Weight Loss During Electrification

In principle, it is possible to electrify any type or shape of gel. However, it is simpler to apply electrical fields to beads, since they are small, easy to introduce between electrodes in a fluid medium, easy to manufacture and handle, and easy to keep for further experiments. Alginate is a favorable material for the production of beads for biotechnological and other purposes. When an alginate gel bead was interposed between a pair of electrodes and a DC current was applied (field intensity of 25–50 V/cm), losses of 46–60% of the initial weight were observed within 10 s (Fig. 4).

Shrinkage of alginate beads as a result of DC application was accompanied by electrolysis, as has been observed for polyelectrolyte gels in an electrical field (Kishi et al. 1990). As a general rule, electrolysis is disadvantageous, and therefore a system avoiding gas formation is desirable and can be achieved by using a complex microgel of polymethacrylic acid (PMAA) and  $\text{Ca}^{2+}$  on a polypyrrole electrode



**Fig. 4** Influence of the supplied voltage on weight loss of 1% alginate beads cross-linked with 2%  $\text{FeCl}_3$

(Shinohara and Aizawa 1989). The percent weight loss of a 2% alginate, 1% CaCl<sub>2</sub> bead was observed to be constant ( $\sim 20 \pm 2\%$ ) under 20 V for 10 s, even when the volume of the liquid was increased by a factor of 200. Weight loss was dependent on the gum and cross-linking agent concentrations (Zvitov and Nussinovitch 2001b).

No significant differences were found between alginates differing in their G-to-M ratios in terms of percent weight loss (Zvitov and Nussinovitch 2001b). This is in agreement with the fact that the most important effect of electrical field applications seems to be the migration and redistribution of counter- and added ions within the gel (Hirose et al. 1992). It was observed that the higher the affinity of the alginate to the cross-linking agent (for high-M alginate), the lower the induced weight loss (Zvitov and Nussinovitch 2001b). It is well known from the literature that the affinity between the alginate and cations used in this study follows the order Ba > Ca > Fe. As the electrical field increased, this trend became more pronounced. It was also observed that the higher the osmotic pressure produced by various salts in the immersion liquid, the smaller the weight loss (Zvitov and Nussinovitch 2001b).

### 3.3.2 Effect of Electrical Treatment on Mechanical Properties

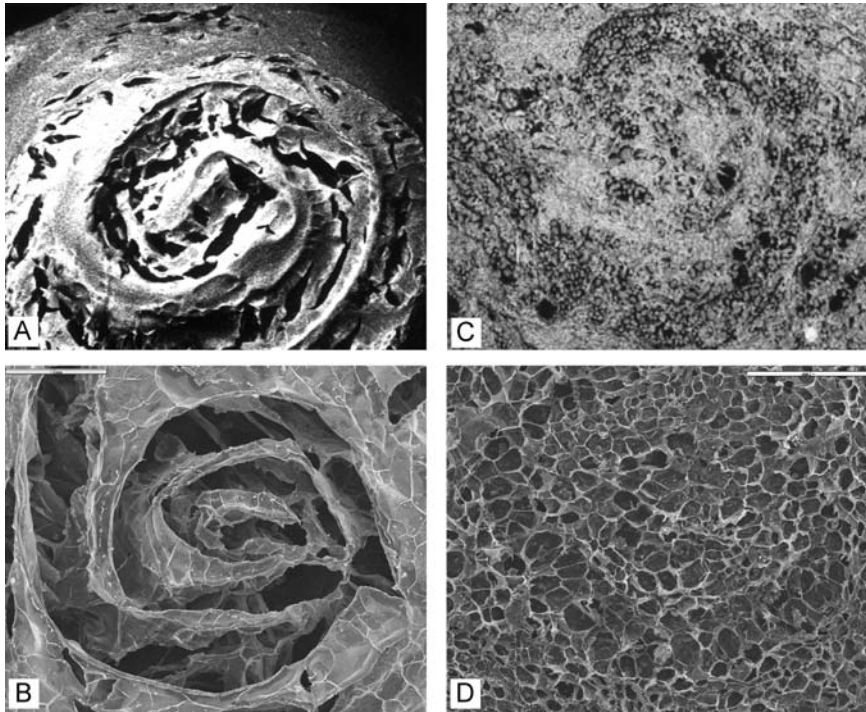
Contraction takes place only in the anode region: no contraction was observed in the cathode area. This is in agreement with the fact that alginate is a polyanion gel. The spheroidal shape of the contracted beads did not change significantly (Zvitov and Nussinovitch 2001b). In general, electrically induced shrinkage of the gel caused its texture to strengthen; the same phenomenon has been observed for gels immersed in acetone solutions which become stiffer as a result of shrinkage (Nussinovitch and Peleg 1990). Beads became stronger and more rigid than those that had not been contracted (Zvitov and Nussinovitch 2001b).

### 3.3.3 Structural Changes

The shape of the affected area of the shrunken gel bead resembles the shape of the electrode (Fig. 5A). In addition, pores of different dimensions are produced along these lines (Zvitov and Nussinovitch 2001b). These pores can change the porosity of the bead and affect its diffusivity. The distortion of the bead from its spherical shape and the creation of pores within it can help induce and control leaching of entrapped materials to the surroundings. The resultant beads can be freeze-dehydrated to obtain a cellular solid structure with even higher porosity (Fig. 5B).

The higher porosity of these gels could be advantageous in fields such as water denitrification, drug delivery, and biological control of soil-borne root diseases (Nussinovitch 1997; Nussinovitch et al. 1993; Rassis et al. 1997; Tal et al. 1999). The freeze-dried hydrocolloid gels could also be useful as carriers for many food snacks, nonfood matrices, and biotechnological operations (Nussinovitch and Zvitov 2007; Nussinovitch and Zvitov-Marabi 2008).



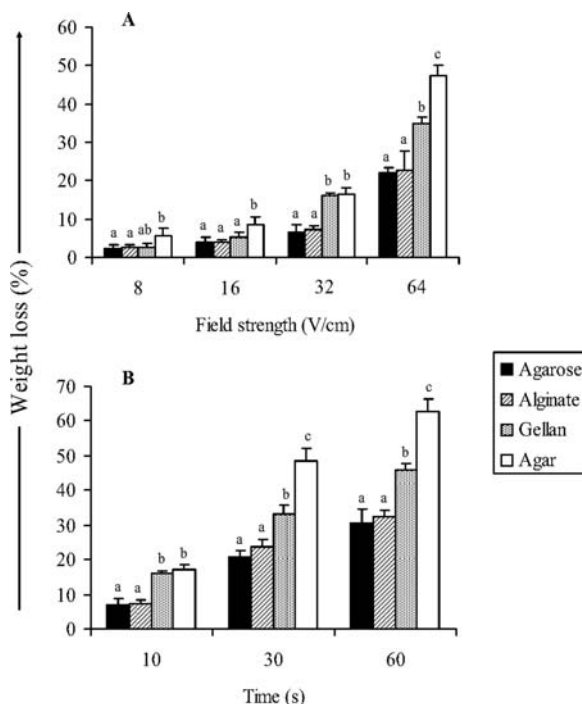


**Fig. 5** SEM micrographs of spiral shape produced on the specimen surface as a result of DC electrical field applied by spiral wire-shaped anode: (A–B) alginate bead before and after freeze-dehydration, respectively; (C–D) same for potato specimen

### ***3.4 Electrification of Different Gel Types (Alginate, Agar, Agarose, Gellan) and Possible Underlying Mechanisms***

Agarose beads lose less weight than beads produced from alginate, gellan, or agar (Fig. 6). Agarose may be less influenced by the electrical field because it is essentially a sulfate-free, neutral polysaccharide and because of its mechanical strength (Zvitov and Nussinovitch 2003).

Agar extract comprises two groups of polysaccharides: agarose, which serves as the gelling component and agarpectin, which is the nongelling ionic polysaccharide. In addition, agar may be more influenced than agarose since it contains soluble salts as residues from the alga itself (Meer 1980). As stated by Yaphe and colleagues (Duckworth and Yaphe 1971; Duckworth et al. 1971), agar is not made up of natural and charged polysaccharides but rather comprises a series of related polysaccharides, ranging from a virtually neutral molecule to the highly charged galactan. Finally, agar holds a large amount of water in its internal network which can move freely (Armisen and Galatas 2000).



**Fig. 6** (A) Influence of electrical field strength (V/cm) on weight-loss percentage of different gel beads at constant application time (10 s); (B) percent weight loss versus time in different gel beads under constant electrical strength ( $\sim 30$  V/cm). Different letters indicate significant differences at  $p < 0.05$

As a result of the DC electrical field and bead shrinkage, water and soluble salts are transferred to the surrounding medium. In the case of agarose, no significant differences were observed in the states before and after the contraction (Zvitov and Nussinovitch 2003). For agar, differences were observed in Ca- and Na-soluble salts. For gellan and alginate, changes were detected due to the migration of the excess salts present from previous cross-linking operations. As a result of the DC electrical field and bead shrinkage, water and soluble salts are transferred to the surrounding medium (Zvitov and Nussinovitch 2001b, 2003).

### 3.5 Conclusions

An anionic gel (e.g., alginate) swells slightly near the cathode and contracts extensively near the anode; the reverse occurs for cationic gels (e.g., chitosan). The observed contractile behaviors are essentially electrochemical phenomena. The electrical field causes mobile counterions and macronetwork ions, together with the surrounding water, to be pumped in opposite directions until the mobile ions reach

the electrode. The shrinkage of gels, such as alginate, can be explained thusly: the negatively charged particle moves to the anode, and cations move to the cathode owing to electrophoretic migration. Carboxylate anions (or other charged ions) are replaced by  $H^+$  in the fluid and become largely undissociated. The carboxyl groups in this state are much less hydrated, and the gel can consequently contract (Kishi and Osada 1989).

A pH gradient occurs through the gel sample (potentially reaching  $\sim 2$  near the anode and  $\sim 12$  near the cathode) (Zvitov and Nussinovitch 2005). Higher pH values near the cathode and lower values near the anode have been reported in the literature for different gels (Hirose et al. 1992; Kishi et al. 1990; Ramanathan and Block 2001). As stated above, the application of DC electrical fields to gels leads to electrolysis; this causes the region near the anode to become more acidic as oxygen is released and protons are formed in the solution ( $H_2O \rightarrow 2H^+ + 2e^- + 1/2O_2$ ), and the region near the cathode becomes more basic ( $H_2O + e^- \rightarrow OH^- + 1/2H_2$ ) (Yoshioka and Calvert 2002).

## 4 Electrification of Plant Tissues

Vegetables are plants or parts of plants that are used as food. This is a very broad definition that includes all fruits, nuts, and cereals which, although of vegetable origin, are not commonly classified as vegetables (Bennion 1985). The term *vegetable* has, through common usage, come to apply in a more narrow sense to those plants or parts of plants that are served raw or cooked as part of the main course of a meal (Bennion 1985). Botanically, a fruit is the seed-bearing part of the plant, which means that squashes, cucumbers, green beans, peas in the pod, okras, and tomatoes are actually fruits, even though they are usually regarded as vegetables. Technological developments in recent years have made a wide variety of fruits and vegetables more plentifully available than ever before (Gates 1981).

An acceptable estimate is that 25%, and up to 80%, of freshly harvested fruits and vegetables are lost through spoilage (Willis et al. 1981). Fruits and vegetables continue their metabolic activity after harvest and will either undergo rather rapid ripening if climacteric, or senescence if nonclimacteric, unless special procedures are adopted to slow down these processes (Nussinovitch 1997). Post-harvest shelf-life extension can be achieved by the application of edible films that are semi-permeable to water vapor and gases. Sometimes a portion of the fresh produce is not harvested, for economic reasons (i.e., to maintain the required profit margin for the farmer as well as for the marketing chain), due to severe external damage that renders the product unappealing/unacceptable to the customer, or due to impact or other mechanical damage. Thus, any technological treatment which can make use of these fruits, either as products or by-products, or for extraction of specific ingredients, could be beneficial for the grower. Since it was found (and see later) that gels and plant tissues behave similarly under the influence of an electrical treatment, part of this agricultural "loss," which can amount to a considerable percentage of the produce, could find other channels for use, by using electrification procedures.

#### ***4.1 Resemblance between Gels and Plant Tissues***

Foods are highly heterogeneous materials. High-moisture, semisolid foods derived from biological tissue or fluids can be modeled to a first approximation as composites, where the mechanical properties result from the interplay of at least two microstructural elements, one of which is a gel (Aguilera 1992). A gel can be defined as a three-dimensional polymeric network that holds large quantities of aqueous solution and exhibits mechanical rigidity. In this sense, all cellular interiors are considered to be gels (Silberberg 1989), and most foods having a cellular structure as modified gels. Moreover, most food products are solids composed of 50–90% water, and as such they can be regarded as multicomponent gels (Tolstoguzov and Braudo 1983). The cellular structure of fruits and vegetables is likened to a foam with closed-cell geometry, filled with gel. The presence of water prevents buckling of the cell walls and gives rise to turgor pressure (Aguilera 1992). In addition, it is well known that polysaccharides are building blocks for plant material. For example, celluloses and hemicelluloses can be found in the plant's cell walls. The pectic substances constitute another group found in cell walls as well as between the cells, sometimes serving as binding substances. Thus, not only are plant cells filled with a "jelly" material that can be influenced by electrification, but the cell wall itself includes the same polysaccharides, serving different functions, that are responsible for structure and strength, and as network producers they might also be influenced by electrical fields (Zvitov et al. 2003b).

In addition, the high-moisture, semisolid structures of gels can provide suitable starting materials for the fabrication of simulated fruits and vegetables (Nussinovitch 1997, 2003; Nussinovitch and Peleg 1990). In fact, the patent literature is full of such examples and oftentimes alginates and pectates have served as the materials for such applications. Fruit analogs based on alginates are in a way trials at mimicking homogeneous textures such as those found in apples and peaches. Additional physical processes, such as freeze–thaw cycles, can be used to include a certain degree of heterogeneity in such textures (Szczesniak 1968). Slow freezing enables the formation of a "skin," which somewhat simulates cell walls. Therefore, it was of interest to check whether plant tissues would undergo shrinkage via the application of small voltages for short times in a manner similar to gels (Zvitov and Nussinovitch 2001a; Zvitov et al. 2003b).

#### ***4.2 Expression Processes in the Food Industry and Betanin Extraction***

When a gel is electrified, it contracts, and fluid containing salts or other low-molecular-weight ingredients leak out of its structure, in parallel to other observed phenomena (Zvitov and Nussinovitch 2003). In other words, electrification which results in contracting tissues could serve as a method of expression.

Expression is a process by which components can be extracted from vegetative tissues. The materials to be extracted are located within the cells, and thus the cells

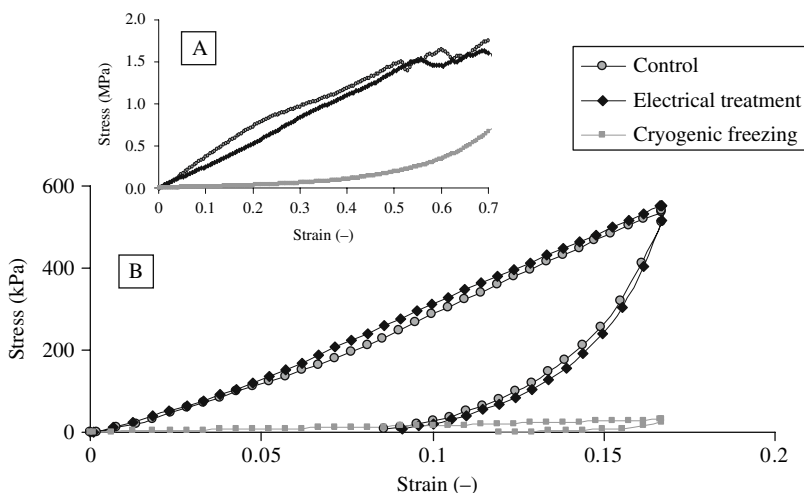
need to be disrupted to release the ingredients. This can be achieved by rupturing the cells, by size reduction followed by separation in a press, or by electrification. Common types of equipment for expressing juice or oil are the tank press and the cage press (Fellows 2000). Another unit operation that involves separation of specific food components is extraction using solvents. This type of extraction depends on temperature, the surface area exposed to the solvent and the flow rate of the solvent. Typical solvents include supercritical carbon dioxide, water or methylene chloride, acetone, ethyl ether, carbon disulfide, hexane, heptane, and cyclohexane, and their choice depends on the type of food and the temperature (Fellows 2000).

Color makes an essential contribution to the attractive appearance of foods and beverages. In the past few years, the food industry has increased the use of natural pigments in many foods and beverages in place of artificial flavoring materials (Colin and Timberlake 1986). This change has created a challenge for the food industry and for the manufacturers of natural colors. Naturally occurring pigments include carotenoids, flavonoids, porphyrins, betalains (beetroot), quinonoids (cochineal), and miscellaneous pigments (Timberlake and Henry 1986). Beetroot red is the name given to the color extracted from beets (*Beta vulgaris*), the principal color components of which are betanin and vulgaxanthin, these pigments making up ~1% of the total solids. Expressed juice from washed and crushed beet-roots is extracted under acidic conditions (usually citric acid) and after vacuum concentration to ~68° Brix, yields a liquid extract which can be subsequently dried into a free-flowing powder (Timberlake and Henry 1986).

It was observed that electrification of vegetative cut tissue in a relatively low DC electrical field (40 V/cm) is capable of extracting the contents of included ingredients. An example is the application of DC voltage to beet tissue (*B. vulgaris*), which results in leakage of betanin (the red beetroot pigment found in the vacuole), as observed by spectrophotometric analysis. The extraction, which is performed in fluid, also induces removal of soluble solids and minerals with almost no alteration of the gross textural properties of the tissue. Optical density (OD) values of the immersion solutions increased with increased time of applied electrical field, indicating vacuolar damage (Zvitov and Nussinovitch 2003).

Since freezing and then thawing a tissue can also effect ingredient extraction, it was interesting to identify the differences between the methods. Scanning electron micrographs revealed minor changes in the surface of the electrically treated tissue versus major changes in the tissue after freeze-thaw treatment (Zvitov et al. 2003a). Cryogenic freezing and thawing (one cycle) of the same tissue for the same treatment time induced considerable damage, as evidenced by reduced values of stress at failure and loss of the tissue's elastic properties (Fig. 7).

The intact tissue and DC-electrically treated tissue had the same stress at failure (ca. 1500 kPa) and the same degree of elasticity (ca. 30%), in contrast to the tissue that underwent freeze-thawing (ca. 14%) and lost its elastic textural properties. Electrical extraction has a major advantage over other methods since the tissue stays almost intact, and thus can be used for other commercial applications, such as filling and baking (Zvitov et al. 2003a).



**Fig. 7** (A) Typical corrected compression stress vs. Hencky's strain relationships for untreated, electrically treated (15 V for 20 s) and cryogenically frozen (20 s) *Beta vulgaris* cylinders; (B) typical stress-strain relationships during a single compression-decompression cycle for the tissues in A

Another example of applied expression can be observed in electrified leaves. To test whether DC application causes leakage from the tissue, mineral composition of the solutions in which the contracted leaves (10 V for 1 min) were immersed was determined. Higher contents of potassium, calcium, and sodium in the immersion solution of the electrically treated tissue ( $3.40 \pm 0.02$ ,  $11.90 \pm 0.09$ , and  $16.40 \pm 0.05$  mg/l, respectively) were observed compared to the control solution ( $1.20 \pm 0.01$ ,  $2.50 \pm 0.05$ , and  $4.80 \pm 0.01$  mg/l, respectively); for comparison, the content of these minerals in distilled water was  $0.45 \pm 0.01$ ,  $\pm 0.11$ , and  $0.16 \pm 0.01$  mg/l, respectively (Zvitov et al. 2003a).

Extraction rate from food materials is dependent on diffusion through the cells. The average diffusion coefficient of a small solute in a membrane is often  $10^6$  times lower than that in the adjacent aqueous solutions (Nobel 1999). The selective permeability is lost if membranes are denatured or detached from the cytoplasm (Aguilera and Stanley 1999). In an experiment that also dealt with electrification of leaves, moderate electrical fields (MEF), from 1 to 100 V/cm, were used to treat mint leaf samples that had been placed in tea bags or cut into  $1 \text{ cm}^2$  squares and immersed in an aqueous fluid medium. The electrical fields were applied by a voltage across immersed electrodes at opposite ends of a receptacle. MEF significantly increased the extraction yield for fresh mint leaves because of additional electrical field effects during heating. Higher extraction rates were observed for fresh mint leaves but not for dried ones or for fermented black tea leaves (Sensoy and Sastry 2004).

Other advantages of vegetative paste or cell culture electrification have been described in a few references. Since green vegetables easily lose their green color during processing and storage, a novel high-intensity PEF technique was applied

to process spinach puree with dissolvable zinc salt. PEF increased the stability of the chlorophyll by increasing electrical fields and adding zinc ions and stabilizers. The visible green color in spinach puree treated by PEF was similar to that of paste treated by thermal processing. In terms of energy, flavor, vegetable quality, and processing time, the electrical method seems to be more effective than thermal processing (Yin et al. 2007); however, in most references, the cost of the apparatuses used to perform industrial-scale tasks is not discussed. Another manuscript dealt with the effects of PEF on growth of and secondary-metabolite production by a plant cell culture using suspension cultures of *Taxus chinensis* as a model system. Cultured cells in different growth phases were exposed to a PEF (50 Hz, 10 V/m) for various periods of time. A significant increase in intracellular accumulation of bioactive secondary metabolite was observed by exposing the cells in the early exponential growth phase to a 30 min PEF. The metabolite content increased by 30% after exposure to PEF, without loss of biomass, relative to controls. Results hypothesized that the PEF altered the cell membrane's dielectric properties (Ye et al. 2004) and thus, in a way, both manuscripts' hypotheses and basic assumptions were strengthened by the findings of others (Zvitov et al. 2003a).

In addition, X-ray analyses were conducted on leaves subjected to DC electrical field. Results indicated a reduction in potassium content ( $\sim 7\%$ ) compared to untreated tissues ( $\sim 25\%$ ). These results support, in part, the mechanism by which the electrical field damages the cells, resulting in leakage of the cell contents to the surrounding medium (Zvitov and Nussinovitch 2003; Zvitov et al. 2003b). The electrical field appears to influence the property of differential permeability attributed to live cytoplasmic and vacuolar membranes. In addition, the influence of the electrical field is similar to that of other processing techniques (heating or freezing) responsible for a loss of differential permeability when the cell dies and a consequent ease of solute diffusion into or out of the cell (Bourne 1983). Most of the studies on electrical treatment techniques in food processing have revealed that beyond a critical value (applied potential difference of  $\sim 1$  V), electrical breakdown of the membrane is achieved and is reflected by increased permeability (Eshtiagi and Knorr 2002; Taiwo et al. 2001).

### ***4.3 Electrification of Fruit/Vegetable Pieces***

The information derived from the current literature on electrification of solid foods is scarce. Experiments with cylindrical pieces of fresh carrot, potato, and yam (solid foods) were conducted in order to obtain information on changes in electrical conductivity during multiple thermal treatments. Electrical conductivity is the most important parameter in ohmic heating (Wang and Sastry 1997). Results showed that in cyclic heating, the heating rate increased with the cycles. Samples preheated by either conventional or ohmic heating showed a higher heating rate than raw materials. Preheated vegetables have higher conductivities than fresh ones, and a tendency towards an increase with cycles was observed (Wang and Sastry 1997).

Low DC electrification of fruit/vegetable pieces was conducted with five different plant tissues (Zvitov and Nussinovitch 2001a). Potato (*Solanum tuberosum*) was chosen because it is the world's most widely grown tuber crop, and the fourth largest food crop (after rice, wheat, and maize) in terms of fresh produce. Potato is commonly grown for its starchy tuber. Sweet potato (*Ipomoea batatas*) was chosen for electrification purposes due to its starchy content and because it is regarded as an important root vegetable. Both potato and sweet potato are convenient to use in such research since it is easy to obtain pieces of predetermined size and shape from the tuber and thus adjust the samples to the electrification process. Kohlrabi (*Brassica oleracea* Gongylodes group) and radish (*Raphanus sativus*), edible root vegetables of the Brassicaceae family, are also good candidates for producing controllable sample pieces. Finally, pear (the juicy fruit of the *Pyrus* tree) was chosen because it is firm and provides a good tissue to curve samples from. Moreover, at least a few of these samples suffer from browning, and thus the influence of electrification on browning could also be studied. It was observed that samples derived from plant tissues (potato, sweet potato, kohlrabi, radish, and pear) undergo shrinkage via the application of small voltages (DC) for short times. Additional influences included migration of minerals from the shrunken tissue, and changes in specimen shape, texture, color and mechanical properties. Similar to gels, pores were produced in the tissue (from the anode side), promoting slow release of minerals and other cell components (Zvitov and Nussinovitch 2001a; Zvitov et al. 2003b). The spiral shape produced on the specimen surface as a result of the spiral anode shape (Fig. 5) was observed even after freeze-dehydration of the sample (Fig. 5D).

#### ***4.4 Inhibition of Potato Browning by Electrical Field***

Enzymatic browning is one of the most important color reactions affecting fruits, vegetables and seafood. It is catalyzed by the enzyme polyphenol oxidase. Some enzymatic browning reactions are beneficial to the overall acceptability of foods, as is the case, for example, with tea, coffee, and cocoa. Polyphenol oxidases are also responsible for development of the characteristic golden brown color in dried fruits such as raisins, prunes, dates, and figs. Blanching is generally required for inactivation of the enzyme after color development, in order to minimize discoloration (Eskin 1990). Enzymatic browning is one of the most devastating reactions for many exotic fruits and vegetables, in particular tropical and subtropical varieties. It is estimated that there is an over 50% loss of fruit yields as a result of enzymatic browning (Whitaker and Lee 1995). Potatoes and other starchy staples are susceptible to browning and this creates economic losses for the agriculturist and food processor. Browning can also adversely affect flavor and nutritional value.

Four methods have been proposed for the inhibition of phenol oxidase activity: exclusion of reactants such as oxygen, denaturation of enzyme proteins, interaction with a copper prosthetic group, and interaction with phenolic substrates or quinines



(Vamos-Vigyazo 1981; Walker 1977). However, few of these methods can be used with foods. In foods, enzymatic browning can be prevented by chemicals such as sulfur dioxide, sulfites, bisulfites, and metabisulfates that inhibit both enzymic and nonenzymic browning. Browning inhibitors in fruits and vegetables can be ascorbic acid, sometimes in combination with citric acid or NaCl. There are other inhibitory combinations, such as ascorbic acid, citric acid, sodium acid pyrophosphate, calcium chloride, ascorbic acid phosphate, and ascorbic acid triphosphate, to inhibit potato browning, or L-cysteine as an inhibitor of avocado and banana browning. Other browning inhibitors or compounds that are able to synergize with browning inhibitors are 4-hexyl-resorcinol, tropolone, kojic acid, carbon monoxide, and hypochlorites, to name but a few.

As already mentioned, blanching is generally required for inactivation of the enzyme after color development, in order to minimize discoloration. Hot-water blanching remains the most important unit operation in processing whole potatoes for French fries, potato chips, hash browns, and flakes. This process suffers from time-consuming heat penetration, and can result in a cooked potato with related off-flavors. By applying an electrical field in the range of 43–70 V/cm (DC current of ~0.02–0.2 A) to a potato specimen interposed between Pt electrodes in a water medium, four phenomena were observed: continuous shrinkage, changes in the apparent structure of the tissue surface area (Fig. 5C), increased pH, and inhibition of the potato browning reaction. An ~14% reduction in tissue weight occurred. Contraction did not stop after application of the electrical field: it continued for ~20 more minutes. In contrast, potato tissue without electrical treatment swelled in water. Tissue shrinkage can be explained by considering the potato's cellular structure as a foam with closed-cell geometry filled with a gel (Aguilera 1992). As was observed for gels, the affected area of the tissue resembled the shape of the electrode (Zvitov and Nussinovitch 2001a). Pores were produced within the tissue (from the anode side), possibly promoting the slow release of minerals and other cell constituents from the contracted specimens. Potassium, phosphate and sulfur contents in a potato specimen subjected to 70 V/cm decreased from initial average values of 2050, 300, and 150  $\mu\text{g/g}$  to 590, 240, and 106  $\mu\text{g/g}$ , respectively. The treated potato samples were less brown, as reflected by their higher  $L^*$  values (the  $L^*$  value spans the lightness-darkness axis of the color system, (the higher the  $L^*$  value the lighter the object)) relative to the control.

Polyphenol oxidase was extracted under standard conditions from both treated and nontreated potato tissues. Electrification caused a reduction in the enzyme's natural activity. The electrical field repressed enzymatic browning without the addition of reagent or the use of heat (Zvitov and Nussinovitch 2001a). Similar reductions in enzyme action were detected when a group of selected enzymes were subjected to continuous PEF treatments to evaluate the inactivation effect. In a treatment lasting 126  $\mu\text{s}$ , 51.7% and 83.3% of pepsin was inactivated at 37.0 kV/cm and 41.8 kV/cm, respectively. Reductions in the enzyme activities of polyphenol oxidase and peroxidase were also reported. Lysozyme activity was not significantly changed. In these experiments, both PEF and the induced heating were responsible for the observed effects (Yang et al. 2004).

#### 4.5 Gel-Plant “Sandwiches”

As a general definition, a sandwich is an item typically made up of one or two slices of a material, between which is laid one or more layers of some other material. A system composed of cylindrical red beet tissue samples sandwiched between cylindrical agarose, agar, or alginate layers and electrified by low DC electrical field (up to 40 V/cm) yielded extraction of pigments and minerals into the gels. Cations were detected in the gel near the cathode and anions near the anode. Gel layers, as well as the beet tissue, developed higher pH values near the cathode and lower values near the anode, with a minor temperature elevation of less than 4.5 °C in both the tissue and the gel. Extraction and separation caused the gel layer close to the anode to become red and that close to the cathode to become yellow (Zvitov and Nussinovitch 2005). This was demonstrated by higher measured  $a^*$  values (the  $a^*$  value spans the green-red axis of the color system) in the gel closer to the anode and higher  $b^*$  values (the  $b^*$  value spans the yellow-blue axis) in the gel near the cathode.

The occurrence of yellow and red pigments was presumably due to a separation between betanin and its reduced form. The stiffer the gel, the lower the amount extracted by the method and the smaller the weight loss of the red beet specimens due to fluid loss. This straightforward method and apparatus appear to constitute an easy technique to extract and separate pigments and minerals from vegetative tissues, mostly when following a line of planned investigation. The tissue with reduced soluble solids, minerals and pigments can still be utilized in other food applications (for baking, filling, etc.), whereas the ground tissue obtained using the more traditional extraction procedures is of almost no use for food products (Zvitov et al. 2003a).

#### 4.6 Influences of Electrification on Intact Plant Tissues

In addition to the proclaimed resemblance of the cellular structure of fruits and vegetables to closed-cell foams filled with gel (Aguilera 1992), two more reports further fueled interest in elucidating the behavior of intact plant tissue under DC electrical fields. One concluded that hydrogels (probably pectins) may play an important role in the control of xylem hydraulic resistance in plants (Zwieniecki et al. 2001), and the other speculated on the resemblance of vegetative tissue to hydrocolloid networks (Zvitov and Nussinovitch 2002; Zvitov et al. 2003b). To investigate the influence of electrification on intact plant tissues, plants of *Cucumis sativus* L., *Phaseolus vulgaris* L. and *Commelina communis* L. were grown and different parts of the plant (i.e. radicles, hypocotyls, cotyledons, leaves), trimmed and intact, were subjected to DC electrical field application. The epidermis of *C. communis* was peeled for observation of stomatal aperture (after application of DC current to the intact leaves). Plant tissues (hypocotyls, radicles, cotyledons, leaves), as is or trimmed to discs, were sandwiched between a pair of Pt electrodes and the space was filled with distilled water or KCl and 2-(*N*-morpholino)ethanesulfonic acid (MES). A few cells of similar design were produced

in different sizes to permit inclusion of different-sized plant tissues into the apparatus. Changing the position of the electrode controlled its distance from the tissue. A DC voltage ranging from 0 to 20 V was applied across the electrodes by a DC power supply for 10–60 s. Electrical field strength was up to 0.5 kV/cm. The use of relatively low electrical field strength is desirable to minimize the absorption energy in the treated systems, which could be transformed into heat.

Examined intact plant tissues (i.e., hypocotyls, radicles, cotyledons, leaves) contracted as a result of the supplied electrical field. *C. sativus* cotyledons lost ~20% of their initial fresh weight after application of 10 V/cm (150 V cm<sup>-1</sup>) for 1 min. Negligible temperature changes were detected (up to 4.5°C) during the electrical application. For *P. vulgaris* radicles, *C. sativus* hypocotyls and *C. sativus* cotyledons, similar to what has been observed for alginate gel beads and other plant tissues, the shape of the affected area of the shrunken tissue resembled the shape of the electrode. Contraction was not uniform, nor was the density distribution. Different electrode shapes might contribute to more uniform shrinkage of such moieties, making changes in shape as well as changes in volume more controllable, subsequently making it easier to induce tailor-made changes. *C. communis* leaves can be easily treated because of their flattened shape, high distribution of stomata, and provision of an easy way to observe the changes caused by the DC voltage. After electrification, open stomata could be observed on both sides of the leaf lamina (from both anode and cathode sides), as compared to the closed stomata of the untreated tissues. Stomatal opening was observed to be due to the DC electrical field (Fig. 8). When a stomatal pore opens, guard-cell turgor exceeds that of the epidermal cells owing to an increase in its turgor pressure. One possible explanation for the stomatal opening can be the differential influence of the electrical treatment on guard-cell turgor pressure versus the surrounding epidermal cells' turgor. The applied voltage damages the epidermal cells; consequently, they lose their turgor and offer no back pressure to the swelling guard cells' movement. Thus, many stomata are seen to be open (Zvitov et al. 2003b).

Leaves that were electrically treated demonstrated failure at lower strains than the untreated leaves, occurring at the contact area between the electrode and the tissue, in accordance with the more pronounced structural changes observed in that region. The higher the DC electrical field, the more pronounced its impact on the tissue, as



**Fig. 8** Photomicrographs of *Commelina communis* epidermal peel (abaxial side up): (A) untreated tissue (closed stomata); (B) electrically contracted (5 V) tissue (open stomata); (C) electrically contracted (20 V) tissue (open stomata)

manifested by a greater weight loss and more profound structural changes. Small voltages ( $\sim 5$  V) were sufficient to cause opening of the stomata in the treated leaf discs but relatively higher voltages ( $\sim 20$  V) led, in addition to stomatal opening, to guard-cell death, as evidenced by light microscopy. Cell viability in both treated and untreated leaves was confirmed by using neutral red staining. As expected, small voltages damaged the epidermal and subsidiary cells but kept the guard cells viable, whereas high voltages led to death of the guard cells as well.

#### ***4.7 Mechanism Involved in Electrifying Plant Tissues***

Structural analysis by electron and light microscopy enabled a better understanding of the mechanism involved during DC electrical field application to plant tissues. The electrical treatment damages the cells, resulting in leakage of their contents into the surrounding medium. In addition, the gel-like properties of the plant's cell wall may contribute to the observed tissue shrinkage (Cosgrove 2001; Zwieniecki et al. 2001). Also observed was stomatal opening, presumably due to the differential influence of the electrical treatment on guard-cell turgor, relative to its influence on the turgor of the surrounding epidermal cells. The applied voltage damages the epidermal cells; consequently, they lose their turgor and offer no resistance to the swelling of the guard cells, which causes opening of the stomatal pore. Thus, many stomata are seen to be open. Possible implications of the stomatal opening could be facilitated water loss from the tissue to enhance drying processes and perhaps ethylene production and involvement in the ripening process of fruits. In addition, leakage of minerals from the cells and partial drying of the tissue due to the electrical treatment could be observed.

### **5 Advantages and Future Prospects of Low Current/Low Voltage DC Electrification**

The contraction of plant tissues in a fluid medium is important for several reasons. It provides a way of extracting desired components from the treated tissue (i.e., pigments, minerals, vitamins, antioxidants, and other tissue constituents from the plant) without harming tissue integrity. Thus, it is possible to simultaneously obtain the desired ingredients and utilize the tissue for further applications, such as pieces to be included in jams or soups, or for individual quick-frozen processes. The contraction can also serve as a partial dehydration technique. Other advantages of the low DC electrification lie in its nonthermal character and its potential to increase food quality. Electrification of potatoes resulted in reducing the browning phenomenon in cut specimens. The electrically induced weight loss could be beneficial for decreasing initial enzyme activity, and as a method of extracting betanin or other substances from beet. The discrete volume transition of gels induced by the electrical field can also be useful (Tanaka 1981; Tanaka et al. 1982) for technological purposes other than food-related ones such as: making switches, memories and

mechanochemical transducers, or even artificial muscles, for storing two- or three-dimensional images via the local collapse and swelling of a gel, and for understanding retinal detachment and corneal edema.

## References

- Aguilera, J. M. (1992) Generation of engineered structures in gels. In: H. G. Schwartzberg and R. W. Hartel (Eds.), *Physical Chemistry of Foods*. Marcel Dekker Inc., New York, pp. 387–421.
- Aguilera, J. M. and Stanley, D. W. (1999) *Microstructural Principles of Food Processing and Engineering*. Aspen Publishers Inc., Gaithersburg, MD.
- Almdal, K., Dyre, J., Hvidt, S. and Kramer, O. (1993) Towards a phenomenological definition of the term “gel”. *Polym. Gels Networks* 1, 5–17.
- Araki, C. (1958) Seaweed polysaccharide. In: *Proc. 4<sup>th</sup> Int. Cong. Biochem.*, Vienna, Pergamon Press, London, pp. 15–30.
- Araki, C. (1965) Some recent studies on the polysaccharides of agarophytes. *Proc. Intl. Seaweed Symp.* 5, 3–17.
- Armisen, R. and Galatas, F. (2000) Agar. In: G. O. Phillips and P. A. Williams (Eds.), *Handbook of Hydrocolloids*. Woodhead Publishing Co., Cambridge, UK, pp. 21–40.
- Barbosa-Canovas, G. V., Gongora-Nieto, M. M., Pothakamury, U. R. and Swanson, B. G. (1999) *Preservation of Foods with Pulsed Electric Fields*. Academic Press, Washington, DC.
- Barbosa-Canovas, G. V. and Zhang, Q. H. (2001) *Pulsed Electric Fields in Food Processing: Fundamental Aspects and Applications*. Technomic Publishing Co. Inc., Washington, DC.
- Bennion, M. (1985) *Gels and Gelatin*. Macmillan Publishing Co., New York, pp. 501–507.
- Beutner, R. (1920) *Entstehung elektrischer Strome in lebenden*. Geweben, Stuttgart.
- Bourne, M. C. (1983) Physical properties and structure of horticultural crops. In: M. Peleg and E. B. Bagely (Eds.), *Physical Properties of Foods*. Avi Publishing Co. Inc., Westport, CT, pp. 207–228.
- Chen, Y. H., Barthakur, N. N. and Arnold, N. P. (1994) Electrohydrodynamic (Ehd) drying of potato slabs. *J. Food Eng.* 23, 107–119.
- Colin, F. and Timberlake, C. F. (1986) Plant pigments for coloring food. *BNF Nutr. Bull.* 14 (2), 113–125.
- Cosgrove, D. J. (2001) Wall structure and wall loosening. A look backwards and forwards. *Plant Physiol.* 125, 131–134.
- Cottrell, I. W. and Baird, J. K. (1980) *Kirk-Othmer Encyclopedia of Chemical Technology (vol. 12)*. John Wiley and Sons, New York, pp. 45–66.
- DeRossi, D. and Chiarelli, P. (1994) Biomimetic macromolecular actuators. *Macro-Ion Characterization. Amer. Chem. Soc. Symp.* 54, Ch.40, 517–530.
- Doi, M., Matsumoto, M. and Hirose, Y. (1992) Deformation of ionic polymer gels by electric fields. *Macromolecules* 25, 5504–5511.
- Duckworth, M., Hong, K. C. and Yaphe, W. (1971) The agar polysaccharides of *Gracilaria* species. *Carbohydr. Res.* 18, 1–9.
- Duckworth, M. and Yaphe, W. (1971) Structure of agar. 1. Fractionation of a complex mixture of polysaccharides. *Carbohydr. Res.* 16, 189–197.
- Eshtiaghi, M. N. and Knorr, D. (2002) High electric field pulse pretreatment: potential for sugar beet processing. *J. Food Eng.* 52, 265–272.
- Eskin, N. A. M. (1990) *Biochemistry of Foods*. Academic Press, Inc., New York.
- Fellows, P. J. (2000) *Food Processing Technology—Principles and Practice (2nd ed.)*. Woodhead Publishing Limited, Cambridge, UK, pp. 150–157.
- Gates, J. C. (1981) *Basic Foods*. Holt, Reinhart and Winston, New York, pp. 99–153.
- Glicksman, M. (1969) *Gum Technology in the Food Industry*. Academic Press, New York.

- Gong, J. P., Komatsu, N., Nitta, T. and Osada, Y. (1997) Electrical conductance of polyelectrolyte gels. *J. Phys. Chem. B.* 101, 740–745.
- Hamlen, R. R., Kent, C. E. and Shafer S. N. (1965) Electrically activated contractile polymer. *Nature* 206, 1148–1149.
- Hirose, Y., Giannetti, G., Marquardt, J. and Tanaka, T. (1992) Migration of ions and pH gradients in gels under stationary electric-fields. *J. Phys. Soc. Jpn.* 61, 4085–4097.
- Hirotsu, S. (1987) Phase-transition of a polymer gel in pure and mixed solvent media. *J. Phys. Soc. Jpn.* 56 (1), 233–242.
- Kishi, R., Hasebe, M., Hara, M. and Osada, Y. (1990) Mechanism and process of chemomechanical contraction of polyelectrolyte gels under electric field. *Polymers Adv. Tech.* 1, 19–25.
- Kishi, R. and Osada, Y. (1989) Reversible volume change of microparticles in an electric-field. *J. Chem. Soc. Farad. Trans. I* 85, 655–662.
- Knorr, D., Geulen, M., Grahl, T. and Sitzmann, W. (1994) Food application of high-electric-field pulses. *Trends Food Sci. Tech.* 5, 71–75.
- Lund, E. J. (1930) Distribution of potentials in the Douglas fir. *Pub. Puget Sound Biol. Sta.* 7, 259–287.
- Meer, W. (1980) Agar. In: R. Davidson (Ed.), *Handbook of Water-Soluble Gums and Resins*. McGraw-Hill, New York, pp. 1–19.
- Nobel, P. S. (1999) *Physiochemical and Environmental Plant Physiology (2nd ed.)*. Academic Press, London.
- Nussinovitch, A. (1997) *Hydrocolloid Applications: Gum Technology in the Food and Other Industries*. Blackie Academic & Professional, London, pp. 169–184.
- Nussinovitch, A. (2003) *Water-Soluble Polymer Applications in Foods*. Blackwell Publishing, Oxford, UK.
- Nussinovitch, A. and Peleg, M. (1990) An empirical model for describing weight changes in swelling and shrinking gels. *Food Hydrocolloid.* 4, 69–76.
- Nussinovitch, A., Velez-Silvestre, R. and Peleg, M. (1993) Compressive characteristics of freeze-dried agar and alginate gel sponges. *Biotech. Prog.* 9, 101–104.
- Nussinovitch, A. and Zvitov, R. (2004) System and method for treating biological tissue using direct current electrical field. Israel Patent Application #PCT/IL2004/000223.
- Nussinovitch, A. and Zvitov, R. (2007) Dried electrified hydrocolloid gels having unique structure and porosity (PCT application PCT/IL2007/000888 filed 15/7/2007, Publication No. WO2008/007383).
- Nussinovitch, A. and Zvitov-Marabi, R. (2008) Unique shape, surface and porosity of dried electrified alginate gels. *Food Hydrocolloid.* 22 (3), 364–372.
- Osada, Y., Kishi, R. and Hasebe, M. (1987) Anomalous chemomechanical characteristics of electro-activated polyelectrolyte gel. *J. Polym. Sci. C-Polym. Lett.* 25, 481–485.
- Osada, Y., Gong, J. P. and Sawahata, K. (1991) Synthesis, mechanism, and application of an electro-driven chemomechanical system using polymer gels. *J. Macromol. Sci. Chem.* A28, 1189–1205.
- Ramanathan, S. and Block, L. H. (2001) The use of chitosan gels as matrices for electrically-modulated drug delivery. *J. Contr. Release* 70, 109–123.
- Rassis, D., Nussinovitch, A. and Saguy, I. S. (1997) Tailor-made porous solid foods. *Inter. J. Food Sci. Tech.* 32, 271–278.
- Rastogi, N. K., Eshtiaghi, M. N. and Knorr, D. (1999) Accelerated mass transfer during osmotic dehydration of high intensity electrical field pulse pretreated carrots. *J. Food Sci.* 64, 1020–1023.
- Seifriz, W. (1936) *Protozoa*. McGraw-Hill Book Company, Inc. New York and London, pp. 332–389.
- Sensoy, I. and Sastry, S. K. (2004) Extraction using moderate electric fields. *J. Food Sci.* 69 (1), 7–13.
- Shiga, T. and Kurauchi, T. (1990) Deformation of polyelectrolyte gels under the influence of electric field. *J. Appl. Polym. Sci.* 39, 2305–2320.

- Shinohara, H. and Aizawa, M. (1989). Control of polymer gel morphology by small potential electric-stimulation with a conducting polymer electrode. *Jpn. Polym. Sci. Tech.* 46 (11), 703–708.
- Shoenfeld, N. A. and Gradzinsky, A. J. (1980) Contribution of electrodiffusion to the dynamics of electrically stimulated changes in mechanical properties of collagen membranes. *Biopolymers* 19 (2), 241–262.
- Silberberg, A. (1989) Gelled aqueous systems. *Adv. Chem. Ser.* 223, 3–14.
- Szczesniak, A. (1968) Simulated fruits and vegetables. US patent No. 3,362,831.
- Taiwo, K. A., Angersbach, A., Ade-Omowaye, B. I. O. and Knorr, D. (2001) Effects of pretreatments on the diffusion kinetics and some quality parameters of osmotically dehydrated apple slices. *J. Agric. Food Chem.* 49, 2804–2811.
- Tal, Y., van Rijn, J. and Nussinovitch, A. (1999) Improvement of mechanical and biological properties of freeze-dried denitrifying alginate beads by using starch as a filler and carbon source. *Appl. Microb. Biotech.* 51, 773–779.
- Tanaka, T. (1981) Gels. *Sci. Amer.* 244, 110–116.
- Tanaka, T., Nishio, I., Sun, S. and Uneo-Nishio, S. (1982) Collapse of gels in an electric field. *Science* 218, 467–469.
- Timberlake, C. F. and Henry, B. S. (1986) Plant pigments as natural food colors. *Endeavour* 10 (1), 31–36.
- Tolstoguzov, V. B. and Braudo, E. E. (1983) Fabricated foodstuffs as multicomponent gels. *J. Texture Stud.* 14 (3), 183–212.
- Trevors, J. T. and Pollack, G. H. (2005) Hypothesis: the origion of life in a hydrogel environment. *Prog. Biophys. Mol. Biol.* 89, 1–8.
- Ueoka, Y., Gon, J. and Osada, Y. (1997) Chemomechanical polymer gel with fish-like motion. *J. Intel. Mater. Syst. Struct.* 8, 465–471.
- Vamos-Vigyazo, L. (1981) Polyphenol oxidase and peroxidase in fruits and vegetables. *CRC Crit. Rev. Food Sci. Nutr.* 15, 49–127.
- Wahab, S. M. A., Ahmed, M. A., Radwan, F. A., Hassan, R. M. and ElRefae, A. M. (1997) Relative permittivity and electrical conductivity of some divalent metal alginate complexes. *Mater. Lett.* 30, 183–188.
- Walker, J. R. L. (1977) Enzymatic browning in foods, its chemistry and control. *Food Tech. N.Z.* 12, 19–25.
- Wang, W. C. and Sastry, S. K. (1997) Changes in electrical conductivity of selected vegetables during multiple thermal treatments. *J. Food Proc. Eng.* 20 (6), 799–516.
- Whitaker, J. R. and Lee, C. Y. (1995) Recent advances in chemistry of enzymatic browning. In: C. Y. Lee and J. R. Whitaker (Eds.), *Enzymatic Browning and Its Prevention (ACS Symposium Series 600)*. American Chemical Society, Washington, DC, pp. 2–7.
- Whiting, C. J., Voice A. M., Olmsted, P. D. and McLeish, T. C. B. (2001) Shear modulus of polyelectrolyte gels under electric field. *J. Phys. Condens. Matter.* 13, 1381–1393.
- Willis, R. H., Lee, T. H., Graham, D., McGlasson, W. B. and Hall, E. G. (1981) *Postharvest, an Introduction to the Physiology and Handling of Fruit and Vegetables*. Avi Publishing Co. Inc., Westport, CN, pp. 1–2.
- Yang, R. J., Li, S. Q. and Zhang, Q. H. (2004) Effects of pulsed electric fields on the activity of enzymes in aqueous solution. *J. Food Sci.* 69 (4), 241–248.
- Ye, H., Huang, L. L., Chen S. D. and Zhong, J. J. (2004) Pulsed electric field stimulates plant secondary metabolism in suspension cultures of *Taxus chinensis*. *Biotech. Bioeng.* 88 (6), 788–795.
- Yin, Y. G., Han, Y. and Liu, J. B. (2007) A novel protecting method for visual green color in spinach puree treated by high intensity pulsed electric fields. *J. Food Eng.* 79 (4), 1256–1260.
- Yoshioka, Y. and Calvert, P. (2002) Epoxy-based electroactive polymer gels. *Exp. Mech.* 42 (4), 404–408.
- Zvitov, R. and Nussinovitch, A. (2001a) Physico-chemical properties and structural changes in vegetative tissues as affected by direct current (DC) electrical field. *Biotech. Prog.* 17, 1099–1106.

- Zvitov, R. and Nussinovitch, A. (2001b) Weight, mechanical and structural changes induced in alginate gel beads by DC electrical field. *Food Hydrocolloid.* 15 (1), 33–42.
- Zvitov, R. and Nussinovitch, A. (2002) Gel network as a model of vegetative tissue under the application of low intensity DC electrical fields. In: *6th Int. Hydrocolloid. Conf.* Toronto, Canada, Jul 10–15.
- Zvitov, R. and Nussinovitch, A. (2003) Changes induced by DC electrical field in agar, agarose, alginate and gellan gel beads. *Food Hydrocolloid.*, 17 (3), 255–263.
- Zvitov, R., Schwartz, A. and Nussinovitch, A. (2003a) Comparison of betalain extraction from beet (*Beta vulgaris*) by low DC electrical field versus cryogenic freezing. *J. Texture Stud.* 34 (1), 83–95.
- Zvitov, R., Schwartz, A., Zamski, E. and Nussinovitch, A. (2003b) Direct current electrical field effects on intact plant organs. *Biotech. Prog.* 19, 965–971.
- Zvitov, R., Zohar-Perez, C. and Nussinovitch, A. (2004) Short-duration low-DC electrical field treatment: a practical tool for considerably reducing counts of gram-negative bacteria entrapped in gel beads. *Appl. Environ. Microbiol.* 70 (6), 3781–3784.
- Zvitov, R. and Nussinovitch, A. (2005) Low DC electrification of gel-plant tissue 'sandwiches' facilitates extraction and separation of substances from *Beta vulgaris* beetroots. *Food Hydrocolloid.* 19 (6), 997–1004.
- Zwieniecki, M. A., Melcher, P. J. and Holbrook, N. M. (2001) Hydrogel control of xylem hydraulic resistance in plants. *Science* 291, 1059–1062.



# Electro-Osmotic Dewatering (EOD) of Bio-Materials

Arun S. Mujumdar and Hiroshi Yoshida

**Abstract** In practical application of electro-osmotic dewatering (EOD), it is very important to increase the dewatering rate, and to decrease the final water content and the electric power consumption for water removal. In a batch apparatus for dewatering operation of colloidal suspensions or sludges, electric power applications, such as alternating current (AC) electric field and interrupted or intermittent electric field, and also arrangements and configurations of the electrode in contact with the suspension or sludge can be available for improving the performance of electro-osmotic dewatering. The effects of these electric field applications and the electrode arrangements and configurations on the dewatering processes are shown, and the usage of electro-osmotic dewatering is focused to biomaterials such as sewage/activated sludge, waterworks sludge, food processing products and wastes, and biomass sludge.

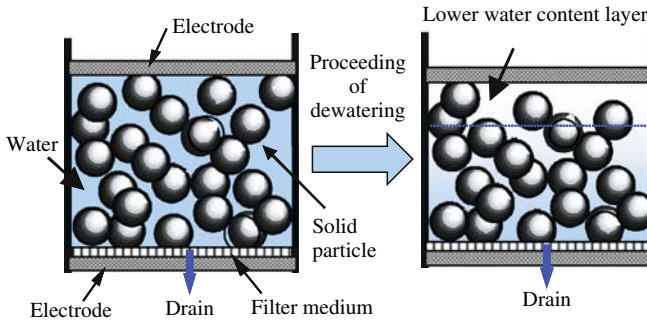
## 1 Introduction

Electro-osmotic dewatering (EOD) is typically performed by applying an external electric field under direct current (DC) condition to a semisolid material placed between two electrodes. In the process of EOD for a bed of semisolid material of which the initial water content is uniform throughout the bed, as shown in Fig. 1, EOD proceeds downwards and the water content in part of the material near the upper electrode opposite to the drainage surface is locally reduced, resulting in an increase of electrical contact resistance between the upper electrode and the material being dewatered (Yoshida and Yukawa 1991; Yoshida and Yukawa 1992; Yoshida 1993). It is supposed that gas produced by electrolysis occurring at the electrode increases the electrical contact resistance, and such increase of electric resistance

---

A.S. Mujumdar  
National University of Singapore, Mineral, Metal & Materials Technology Centre,  
Engineering Science Programme  
e-mail: mpeasm@nus.edu.sg

H. Yoshida  
Oyama National College of Technology, Department of Materials Chemistry and Bioengineering  
e-mail: yoshida@oyama-ct.ac.jp



**Fig. 1** Proceeding of a bed of material dewatered by EOD

has a negative effect on the distribution of electric field strength throughout the bed in the dewatering process. Consequently such a circumstance for EOD hinders continuation of the dewatering, and the efficiency of EOD is reduced excessively.

For applying EOD practically to various kinds of materials, it is important essentially to increase the dewatering rate, and to decrease the final water content and the electric power consumption for water removal, as much as possible. From these points of view, various applications of electric field, which are different from continuous DC condition, have been attempted to improve the performance of EOD. In order to reduce the negative effect for dewatering, which is characteristic of EOD, such as the increase of electrical contact resistance mentioned above, many investigations have been carried out for better and higher performance of EOD.

The mechanism of EOD is different from that of such widely used dewatering processes as mechanical methods using fluid pressure, compressive and centrifugal forces. EOD has some advantages compared with mechanical dewatering methods, and it can be more effective for solid–liquid mixtures consisting of colloidal particles and gelatinous and biological materials that are not successfully dewatered by mechanical methods. EOD has been applied to numerous materials, mainly inorganic materials such as peat, clay, soil, coal, cement, concrete, metal and hydroxides (Rampacek 1966). EOD for clay slurries and washed mineral sludges has been examined for over a century. Referring to biomaterials, EOD has been used for dewatering of waterworks and sewage sludges, food processing wastes, biological wastes, and biomass sludges.

R&D on EOD carried out in the last two decades is described in this chapter. This overview includes various published applications of electric field for processing EOD which are expected to be available for enhancing the performance of EOD are shown in terms of water removal and energy consumption.

## 2 Theoretical Backgrounds

### 2.1 Recent Theoretical Developments

Recent development of theories of EOD have principally been made by Iwata et al. (Iwata et al. 1991a; Iwata 2000; Iwata et al. 2004).

In EOD of a compressible semisolid material such as a sludge consisting of liquid and solid particles, both electric field and hydraulic pressure gradients are concurrently generated in a bed of the compressible material, and not only the liquid but also the solid particles in the material move with the progress of dewatering. In EOD combined with mechanical pressure, the effects of the strength of electric field ( $E$ ) and the hydraulic pressure ( $p_L$ ) distributions produced in the bed must be taken into account in a theoretical consideration of the dewatering process. Since the solid particles as well as the liquid migrate in the bed with dewatering, it is convenient to use the mass of particles accumulated above per unit area of the drainage surface,  $\omega$ , as a variable for representing an arbitrary position in the direction of the height of the bed. In other words,  $\omega$  is defined a moving material coordinate system as the mass of solids per unit cross-sectional area of the bed measured from the lower electrode. Then the superficial linear velocity  $q$  of liquid flow in such a compressible bed of dewatered material is expressed as follows (Iwata et al. 1991a):

$$q = \frac{1}{\mu\alpha_c} \left( \frac{\sigma_s E}{\rho_p \varepsilon} + \frac{\partial p_L}{\partial \omega} \right) \quad (1)$$

where  $\mu$  is the viscosity of liquid;  $\sigma_s$ , the effective charge on the solid surface per unit volume of particles;  $\rho_p$ , the density of solid particles;  $\varepsilon$ , the porosity of the bed; and  $\alpha_c$ , the specific hydrodynamic resistance of the material dewatered. Equation 1 takes into account the tortuosity and size of liquid flowing path, and the first term of the right hand side in Equation (1) represents the electro-osmotic flow, while the second term, the hydraulic pressure flow in the material.

Using the electric current density,  $I$ , passing through the cross-section of the bed, the specific electric conductivity of the material  $\lambda$ , the volumetric specific surface area of the particles  $S_v$ , and the Kozeny constant  $k$ ,  $E$  and  $\alpha_c$  in Equation (1) are respectively given by

$$E = \frac{I}{\lambda}, \quad \alpha_c = \frac{k S_v^2 (1 - \varepsilon)}{\rho_p \varepsilon^3} \quad (2)$$

In expression (mechanical pressure) under an electric field, the relation between  $p_L$  and the solid compressive pressure  $p_S$  in the material bed is given by the same formula as the following one for pure expression.

$$\frac{\partial p_L}{\partial \omega} + \frac{\partial p_S}{\partial \omega} = 0 \quad (3)$$

Using Equations (2–3), Equation (1) can be rewritten as

$$q = \frac{1}{\mu\alpha_c} \left( \frac{\sigma_s I}{\rho_p \varepsilon \lambda} - \frac{\partial p_S}{\partial \omega} \right) \quad (4)$$

If the void ratio  $e$  defined by  $\varepsilon/(1-\varepsilon)$  is used, the material balance of liquid with respect to an infinitesimal element  $d\omega$  in the bed leads to the continuity equation relating the change in  $q$  to the change in  $e$  as follows:

$$\frac{\partial e}{\partial t} = \rho_p \frac{\partial q}{\partial \omega} \tag{5}$$

where  $t$  is the dewatering time. Substitution of Equation (4) into Equation (5) gives

$$\frac{\partial e}{\partial t} = \frac{\partial}{\partial \omega} \left\{ \frac{\rho_p}{\mu \alpha_C} \left( \frac{\sigma_S I}{\rho_p \varepsilon \lambda} - \frac{\partial p_S}{\partial \omega} \right) \right\} \tag{6}$$

Equation (6) is the basic equation representing for the process of EOD, and is reduced to the consolidation equation if  $I = 0$ . The basic differential Equation (6) can be numerically solved using the empirical correlations of  $e$  versus  $p_S$ ,  $\sigma_S$  versus  $e$ , and  $\lambda$  versus  $e$ , respectively, and the initial and boundary conditions given appropriately. Then one can estimate all of the  $e$ - and the  $p_S$ -distributions in the material bed in the dewatering process, as shown in Fig. 2, for example.

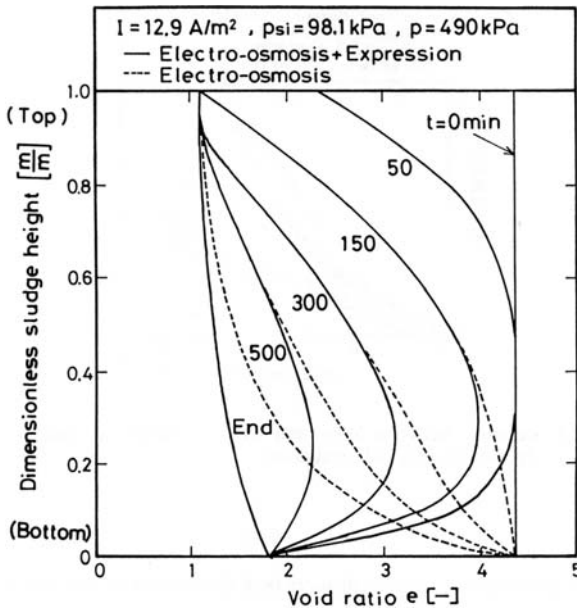


Fig. 2 Estimated time changes of  $e$ -distributions under pure EOD and EOD combined with expression

As  $\partial e/\partial t$  in Equation (6) should be 0 at the end of dewatering, Equation (6) gives the following equation:

$$\frac{\partial p_S}{\partial \omega} = \frac{\sigma_S I}{\rho_p \varepsilon \lambda} \quad (7)$$

Equation (7) suggests that the  $e$ - and the  $p_S$ -distributions are not uniform numerically at the final stage of dewatering, and that  $e$  at the drainage surface does not change; that is, the initial value of  $e$  is maintained during dewatering and  $p_S$  becomes a maximum value near the upper electrode opposite to the drainage surface.

Based on Equation (6), another theoretical method was proposed recently (Iwata et al. 2004). Here, the term on the left-hand side in Equation (5) is expressed as follows:

$$\frac{\partial e}{\partial t} = \frac{\partial e}{\partial p_S} \cdot \frac{\partial p_S}{\partial t} \quad (8)$$

As in the mechanical consolidation process, the modified consolidation coefficient  $C_e$  defined by the following equation is introduced (Shirato et al. 1967).

$$C_e = \frac{\rho_p}{\mu \alpha_C \left( -\frac{de}{dp_S} \right)} \quad (9)$$

On the assumption that  $C_e$  is constant during dewatering, Equation (6) is rewritten as follows:

$$\frac{\partial p_S}{\partial t} = C_e \frac{\partial}{\partial \omega} \left( \frac{\partial p_S}{\partial \omega} - E_{pg} \right), \quad E_{pg} = \frac{\sigma_S I}{\rho_p \varepsilon \lambda} \quad (10)$$

where  $E_{pg}$  is a driving force for electro-osmotic flow and may be called ‘‘electro-osmotic pressure gradient’’ physically in a sense. Assuming  $E_{pg}$  to be also constant during dewatering, Equation (6) can be reduced eventually to the following formula representing the mechanical consolidation process. Accordingly EOD may be recognized as a kind of consolidation.

$$\frac{\partial p_S}{\partial t} = C_e \frac{\partial^2 p_S}{\partial \omega^2} \quad (11)$$

Equation (11) can be solved by using the proper initial and boundary conditions giving the following equation:

$$p_S(\omega, t) = p_{S,i} + E_{pg} \omega - \sum_{n=1}^{\infty} \left\{ \frac{8\omega_0 E_{pg} (-1)^{n-1}}{(2n-1)^2 \pi^2} \right\} \sin \left\{ \frac{(2n-1)\pi}{2} \cdot \frac{\omega}{\omega_0} \right\} \exp \left\{ -\frac{(2n-1)^2 \pi^2}{4} \cdot \frac{C_e t}{\omega_0^2} \right\} \quad (12)$$

In this equation,  $p_{S,i}$  is the pre-consolidation pressure, and  $\omega_0$ , the total mass of solid particles per unit cross-sectional area of the bed.

Besides the above equation, the average consolidation coefficient  $U_C$ , which represents the progress of dewatering can be expressed from Equations (4), (12) as follows:

$$U_C = \frac{L_i - L}{L_i - L_f} = 1 - \frac{32}{\pi^3} \sum_{n=1}^{\infty} \frac{(-1)^{n-1}}{(2n-1)^3} \exp \left\{ -\frac{(2n-1)^2 \pi^2}{4} \cdot \frac{C_e t}{\omega_0^2} \right\} \quad (13)$$

Here  $L$  is the thickness of the bed in the dewatering process, and  $L_i$  and  $L_f$ , the initial and the final thicknesses of the bed, respectively.  $C_e$  and  $E_{pg}$  in Equations (9–10) are determined based on experimental data. Thus, for the process of EOD under constant electric current, the time evolutions of  $L$ , the  $p_s$ - and the  $e$ -distributions in the material are estimated from Equations (12–13).

## 2.2 Principles for High Performance EOD

As described previously in the Section 1, the water content near the upper electrode opposite to the drainage surface is locally reduced during EOD, resulting in increase of electrical contact resistance between the electrode and the material being dewatered. The specific electric conductivity,  $\lambda$ ?, of the material is ordinarily decreased with decreasing water content, and then such a circumstance enhances the increase of the electrical contact resistance. Consequently the efficiency of EOD is reduced markedly.

For high-performance EOD, it is advisable to maintain low electrical contact resistance and to make the strength of electric field throughout the material bed as uniform and large as possible in the dewatering process. As it is difficult to estimate local strength of electric field acting effectively for dewatering in the material, the average strength of electric field,  $E_{av}$ , applied to all over the bed in the dewatering process is discussed as follows.

The electric resistance between two electrodes, namely the electric resistance,  $R_E$ , of the material bed, is expressed by

$$R_E = \frac{L}{\lambda_{av} A} \quad (14)$$

where  $\lambda_{av}$  is an equivalent average specific electric conductivity of the material.  $L$  and  $A$  are the thickness and the cross-sectional area of the bed, respectively, and these may be regarded as the distance between two electrodes and the area of the electrode, respectively.  $R_E$  in Equation (14) is also given by Equation (15) using the voltage,  $V$ , applied to the bed and the electric current,  $i$ , passing through the cross-section of the bed.

$$R_E = \frac{V}{i} = \frac{V}{AI} \quad (15)$$

where  $I$  is the electric current density. From Equations (14–15),  $E_{av}$  is expressed by

$$E_{av} = \frac{V}{L} = \frac{i}{A\lambda_{av}} = \frac{I}{\lambda_{av}} \quad (16)$$

If  $L$  and  $\lambda_{av}$  are assumed to be nearly constant,  $V$  and  $I$  should be increased to intensify  $E_{av}$ .  $L$  is actually decreased and  $\lambda_{av}$  is also usually decreased with dewatering, as described above.

Incidentally, EOD can be operated under constant voltage or constant current condition. Accordingly, when an electric field is applied at a constant voltage operation ( $V = \text{constant}$ ),  $E_{av}$  in Equation (16) should be increased theoretically because of the decrease of  $L$ . However, a net value of  $E_{av}$  applied to the material being dewatered is just reduced due to the occurrence of a large electrical contact resistance enhanced with the progress of dewatering. While in the operation at constant current ( $i = \text{constant}$ ), net  $E_{av}$  in Equation (16) could be increased with decreasing  $\lambda_{av}$  in spite of the enhancement of electrical contact resistance. In this operation, however, the electric power would be poorly utilized; in other words, the applied voltage required to maintain a constant current condition would be too high due to the large electrical contact resistance. Equation (16) also indicates that  $E_{av}$  is increased if  $A$  is smaller.

From the viewpoints mentioned above, various applications for better and higher performance of EOD can be devised in principle to improve the dewatering rate, the final water content, and the efficiency of electric power consumption for water removal.

### 2.3 Characteristics of Materials Suitable for EOD

The electro-osmotic velocity of liquid flow  $u$  is given by the following equation derived on the basis of an electrostatic capacitor model, for example.

$$u = \frac{\zeta D}{4\pi\mu} E = \frac{\zeta D}{4\pi\mu} \cdot \frac{I}{\lambda} \quad (17)$$

where  $\zeta$  is the zeta potential of the solid particle and  $D$  is the dielectric constant of liquid.  $E$ ,  $\mu$ ,  $I$ , and  $\lambda$  are as before. The electro-osmotic flow is a phenomenon that is caused by the  $\zeta$ -potential in an electric double layer at the interface between different phases. In the derivation of Equation (17), it is assumed that the thickness of the electric double layer is quite small compared with the diameter of the capillary or pore size. As the electric double layer thickness is usually smaller than the capillary diameter, Equation (17) is applicable to most cases, and  $u$  is independent of the capillary structure; in other words, the electro-osmotic flow is not affected by the diameter of the particles contained in the dewatered material. Hence, EOD can be particularly effective for the material including very fine particles (e.g., colloids).

Equation (17) also indicates that  $u$  is proportional to the electrical properties such as the  $\zeta$ -potential of solid particles and the dielectric constant of liquid  $D$ , and that is inversely proportional to the viscosity  $\mu$  and the specific electric conductivity  $\lambda$  of the liquid. Therefore, large  $\zeta$  and small  $\mu$  and  $\lambda$  of the original material can be appropriate for EOD, and it is advantageous that  $\zeta$  changes to the larger and  $\lambda$  changes to the smaller value in the dewatering process.

EOD has so far been known to be effective for dewatering of colloidal, gelatinous, and biological materials, which are not performed successfully by conventional

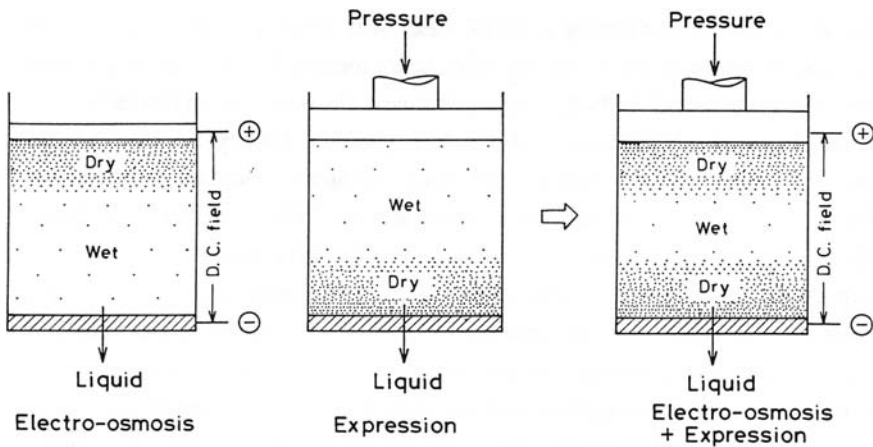
mechanical dewatering methods. And the aspects of biomaterials that can be considered for EOD from the viewpoints described above may be summarized as follows:

1. As the electro-osmotic flow is theoretically considered to be independent of the capillary structure, EOD could be effective for materials that have minute capillary structures like fibrous plants.
2. Sewage sludge or activated sludge can hardly be dewatered mechanically, because such sludge disposed biologically contains very fine particles such as microorganisms and organic decomposed products.
3. The suspended particles in typical sewage sludge generally have negative  $\zeta$ -potential. However, in the case that many kinds of colloidal particles are contained not as the suspended particles in the liquid, the viscosity  $\mu$  of the liquid becomes high, resulting in a disadvantage for EOD.
4. Coagulated or agglomerated sludge produced in wastewater and sewage treatments is very compressible, collapsible and transformable, so that such a sludge is extremely difficult to dewater by mechanical methods such as vacuum dewatering, pressure dewatering or expression.
5. Gelatinous materials are often found in food processing products, and those are also hardly removed by mechanical dewatering methods.
6. Proteins, polymers made of amino acids, exist as both cationic and anionic electrolytes in aqueous solution and have a net charged surface with positive or negative ions environmentally depending on pH of the solution. Then the proteinaceous macromolecules have positive or negative  $\zeta$ -potential in the solution, and the proteins may be regarded as the particulates in solid-liquid separation for bio-materials.
7. If corrosion of the electrode material is caused by electrolysis, the bio-materials dewatered electro-osmotically are contaminated, and also they may be denatured by ohmic heating.

### 3 Applications of Electric Field for High-Performance EOD

As explained briefly in Introduction, the characteristics of EOD have been examined in many experimental studies. Combined operations of electrical and mechanical dewatering fields were investigated and used in practice as a method for improvement of EOD. The combined fields for high-performance EOD were applied by the operations of EOD combined with vacuum dewatering, with hydraulic-pressure dewatering, and with mechanical expression (Lockhart 1992; Yoshida 1993; Wakeman and Tarleton 1999). Figure 3 shows schematically the process of EOD combined with expression, for example. In the case of EOD only, the water content in a bed of the material is reduced near the upper part of the bed, but much water still remains in the lower part at the final stage of the dewatering, as shown later. On the other hand, if the top surface of the bed is impermeable, mechanical expression proceeds with dewatering from the lower part of the bed. Thus, EOD and mechanical expression are complementary; they remove water from both the upper and

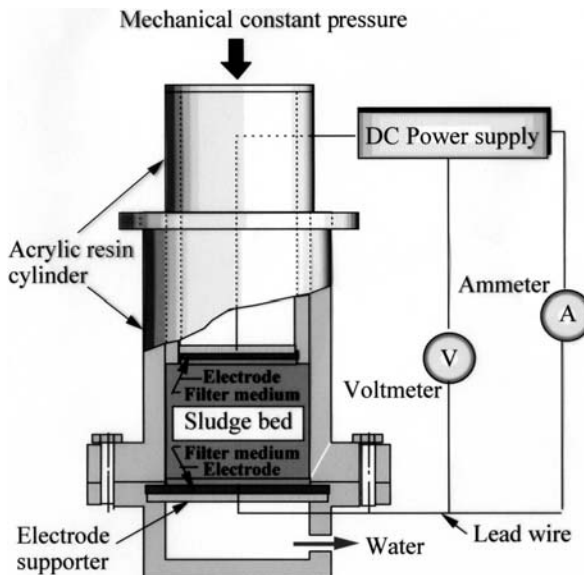




**Fig. 3** Schematic diagram of combined dewatering of electro-osmosis coupled with expression

the lower sides. Consequently, a combination of these dewatering operations can be expected to be a useful means for improvement of EOD (Yoshida 1993). The process of EOD combined with mechanical expression was discussed theoretically and experimentally by taking into account the hydraulic pressure distribution in a bed of the dewatered material (Iwata et al. 1991b).

A batch-type experimental apparatus used for EOD is illustrated in Fig. 4. A semisolid material to be dewatered is put between two filter media in contact



**Fig. 4** Typical batch-type experimental apparatus for EOD

with each of the upper and the lower electrodes made of perforated plate or wire netting in the vertical direction, and subsequently an electric field for EOD is typically applied and investigated under a continuous DC condition. The polarity of both electrodes is determined in consideration of the polarity of  $\zeta$ -potential of solid particles so as to remove water downwards from the material.

In EOD under continuous DC operation for the semisolid material (e.g. sludge) of which the initial water content is uniform throughout the sludge bed, a final distribution of water content in the direction of height of the bed at the end of dewatering is shown in Fig. 5. The ordinate in this figure represents a dimensionless parameter that is obtained by normalizing the distance from the bottom of the bed by the whole height of the bed at the end of dewatering, because the whole bed height actually decreases with the progress of dewatering. Similar results are obtained experimentally in the combined process of EOD and vacuum dewatering (Yoshida 1993; Vijn 1999a).

As shown in Fig. 5, EOD under the condition of DC power supply is successively performed downwards and the water content is reduced considerably in the upper part of the bed opposite to the drainage surface. The reduction of the water content near the upper electrode enhances the increase of electrical contact resistance between the upper electrode and the top surface of the sludge bed shown in Fig. 4, resulting in a large expenditure of the voltage applied to the bed. In such

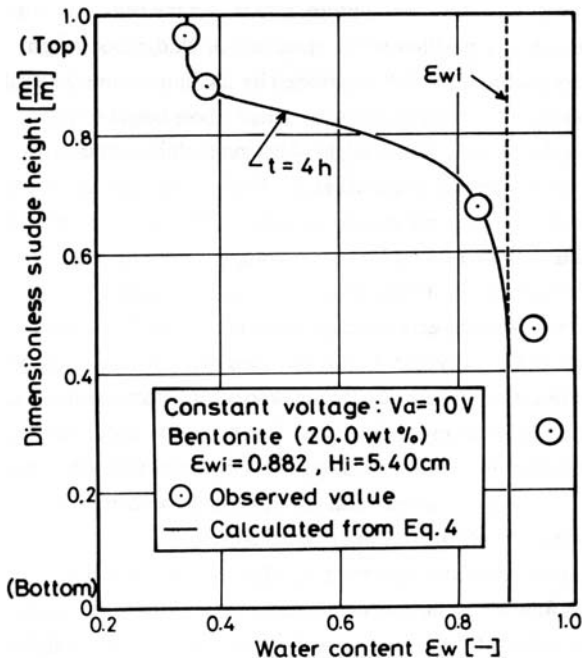


Fig. 5 Final distribution of water content in sludge bed dewatered using electro-osmosis

circumstances, the applied electric field does not act effectively in the lower part of the bed, and then continuation of EOD becomes increasingly difficult.

Different applications of electric field, besides continuous DC, have recently been investigated in an effort to improve the performance of EOD. New developments for high-performance EOD are described in the next section.

### ***3.1 Electric Field Application with Electrode Polarity Reversals***

An improvement for the performance of EOD under continuous DC condition had been originally tested by Gray and Somogyi (1977). They investigated an electro-osmotic treatment with the electrode polarity reversals of every 30 min for red mud sludge and suggested that reversals of electrode polarity or electric current direction improved consolidation of the sludge and more efficient dewatering.

The electric field application of alternating current (AC) with periodic reversals of the electrode polarity has been also investigated from the viewpoint of lowering an increase of the electrical contact resistance between the upper electrode and the sludge being processed (Yoshida et al. 1999). By applying a very-low-frequency AC electric field combined with mechanical expression to the sludge bed, the direction of liquid flow in the bed by electro-osmosis can be reversed periodically with time, and this EOD process was expected to be useful for sludge dewatering from both sides of the bed between the electrodes.

The AC operation for an efficient EOD process was investigated in the region of low frequency below 1 hertz (Hz) for the electrode polarity reversals. An AC electric field was experimentally applied to the sludge bed actually by using an electric power supply system consisting of function generator, power amplifier, and oscilloscope, and both rectangular and sine waves can be mostly used as the wave form of AC voltage, as shown in Fig. 6. An effective value (root mean square-value: RMS-value) of the voltage applied under the condition of AC was used for a comparison between the AC and DC operations, and the effective applied voltage was constant in each wave form and equal to the DC voltage applied constant during the dewatering process.

The effects of the wave form and the wave frequency on final dewatered amount per unit cross-sectional area of the sludge bed for a clay material are shown in Fig. 7. On a semi-log plot as shown in this figure, the value of final dewatered amount  $Q_f$  approximately in the low region below 1 Hz of the wave frequency  $f$  increases with decreasing  $f$  in both the rectangular and sine waves, and then in the range below about 0.01 Hz  $Q_f$  becomes larger than the DC operation. From these results, it is found that the AC operation at a certain low frequency can improve the performance of EOD compared with the DC operation. This fact suggests that the process of EOD with electrode polarity reversals can be effective not only for reducing the water content uniformly throughout the whole sludge bed but also reducing the excessive increase of the electrical contact resistance caused by DC operation. However, it was also reported that the efficiency of electric power consumption for the amount

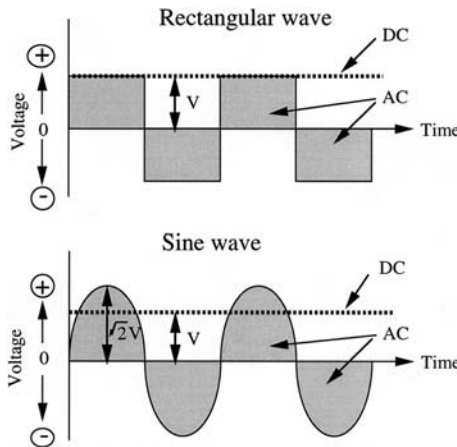


Fig. 6 Schematic diagram of wave forms of an AC electric field

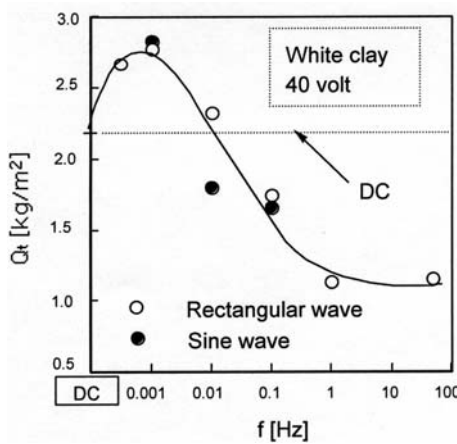


Fig. 7 Relation between  $Q_t$  and  $f$  in both rectangular and sine waves

of removed water under AC was lower than that under DC except near the end of dewatering (Yoshida et al. 1999).

### 3.2 Interrupted or Intermittent Electric Field Application

Lockhart (1986), Lockhart and Hart (1988) studied many of the variables in terms of EOD, and one of the variables was interrupted electric power application; in other words, on-off power application. According to their studies, the experimental results of on-off alternations with equal periods up to 5 min suggested that better results than continuous DC power application were not always appeared, and that the results depended on the material dewatered and the apparatus used in the

experiments. It was also noted that the interrupted power applications did not offer any inherent advantage or power saving capability, but the on-off power regimes were not suggested to be not useful for practical value from power interruptions.

Therefore, interrupted EOD of a clay sludge was demonstrated for the first time as a new method of interrupting power operation (Rabie et al. 1994; Gopalakrishnan et al. 1999b). In this pioneering method shown in Fig. 8, a constant voltage or current is applied for  $t_{on}$ , the on-time, followed by a period of  $t_{off}$ , the off-time when the power is turned off. This pattern is then repeated. Almost the same experimental apparatus as shown in Fig. 4 was used, and the electrodes were short-circuited through a shunt resistor with extremely small resistance during the periods of power interruption. In the interrupted regimes, the off-time ranged from 0.5 to 20 s with the on-time fixed 30 s. Figure 9 gives an example of efficient interruption with a short circuit and shows the volume of water removed as a function of the cumulative on-time for both continuous DC and the interrupted processes with three off-times of 0.5, 3, and 20 s. It is seen that the largest volume of water was removed for the

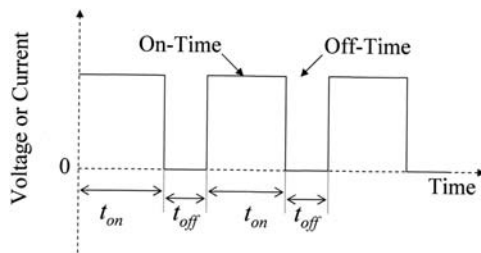


Fig. 8 Schematic diagram of time variation of applied DC voltage or current

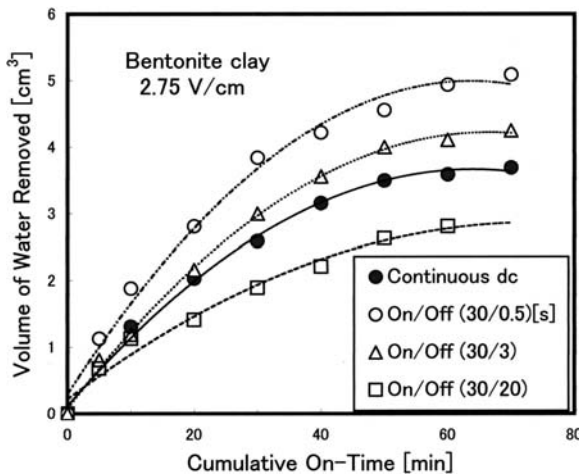


Fig. 9 Relation between water removal and cumulative on-time

shortest off-time of 0.5 s, and that the interrupted EOD process with the off-time of 0.5 s removed finally about 40% more water than continuous DC.

Figure 10 shows the relation between the volume of water removed and the cumulative electric power consumption for continuous DC, and the interrupted processes with a short circuit of the off-times of 0.5 and 20 s. For a given electric power consumption, the interrupted EOD process with a short circuit of the 0.5 s off-time removed much water more than the DC process, whereas the interrupted process with the 20 s off-time removed less than the DC process. From these results, a certain operation in the interrupted mode has a beneficial effect if the electrodes are short-circuited during the off-time, and the dewatering rates and the final volume of water removed can be larger than those by continuous DC mode for equal energy consumption. For the interrupted EOD process enhanced by short-circuiting the electrodes, it was also reported that an experimental optimum off-time was 0.1 s for an on-time of 30 s for Hydrocol clay suspensions (Gopalakrishnan et al. 1996a).

For efficient performance of EOD, an intermittent electric field, abbreviated to IEF, made by rectifying an AC electric field can be used to reduce the excessive increase of the electrical contact resistance with proceeding of the dewatering. The rectified intermittent electric field was constituted of half waves as shown in Fig. 11, in which both rectangular and sine waves were used as the wave form of AC, and the magnitude of AC voltage applied could be divided by two conditions of both the same peak-value voltage (PV) and the same effective RMS-value voltage (EV) as the voltage applied under DC and AC electric fields. Figure 11 gives an example of both PV and EV with 40 V under the IEF in each wave form.

In the rectified half-wave IEF, a diode was added to the AC circuit described before for half-wave rectification of AC, and on-time of the electric power supply was equal to off-time, and the on-off time was set in the region of more than 50 s, namely, very low frequency below 0.01 Hz of AC. Then the process of EOD under the IEF was investigated experimentally, under both conditions of the same PV and

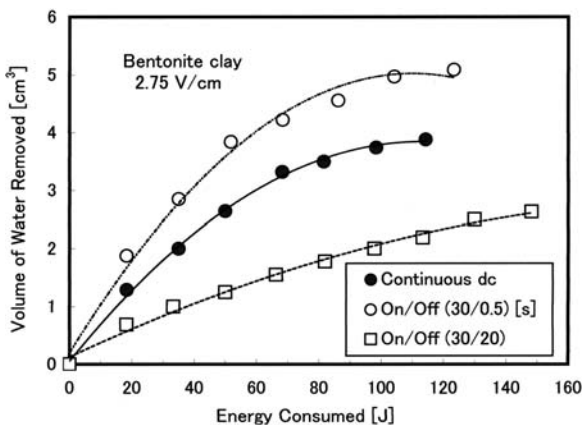
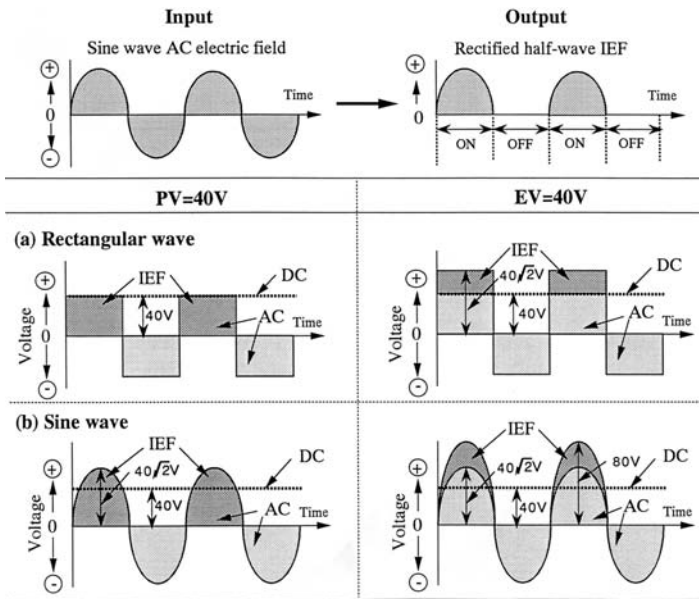


Fig. 10 Relation between water removal and energy consumption



**Fig. 11** Schematic diagram of intermittent electric field (IEF) obtained by half-wave rectification of AC electric field with rectangular and sine waves

the same EV as the constant voltage applied under DC or AC condition (Yoshida 2000).

Figure 12 shows the time evolutions of the amount of removed water  $W$  under IEF of which AC with sine wave form was rectified to half waves at a very low frequency of 0.001 Hz (on–off time = 500 s). Figure 13 shows the relation between  $W$  and the electric power consumption  $P$  in the case of rectangular wave form with  $f$  of 0.001 Hz. These figures show a comparison among the IEF, DC and AC, where their EVs are constant and the same, respectively. It can be seen from Figs. 12 to 13 that both the dewatering rate  $dW/dt$  and  $W$  under the IEF are increased compared with those under the DC and AC, and that the electric power efficiency  $W/P$  under the IEF is remarkably higher than those under the DC and AC. These results are considered to be due to the aforementioned electrical contact resistance which is reduced to some extent during the dewatering process under the IEF.

The final amount of removed water  $W_f$  under the rectified half-wave IEF with rectangular wave AC was investigated by varying the cycle time, corresponding to the period of one on and off state, and the relation between  $W_f$  and the cycle time was shown in Fig. 14, where the voltages applied under the IEFs were in both cases of  $PV = 40$  V and  $EV = 40$  V, and the cycle time was varied from 0.5 or 1.0 to 10 min. From this figure,  $W_f$  can be found to become maximal at around 5 min in both cases, and even in the case of PV,  $W_f$  in a certain range of the cycle times is larger than that under the DC condition (Yoshida et al. 2001).

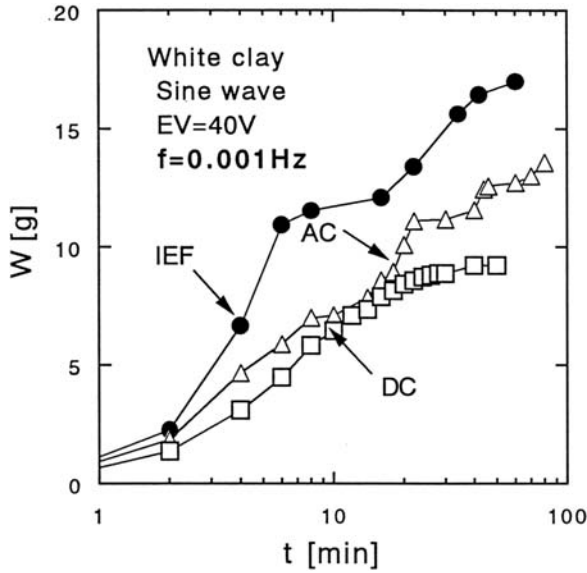


Fig. 12 Time evolutions of  $W$  under IEF, DC and AC

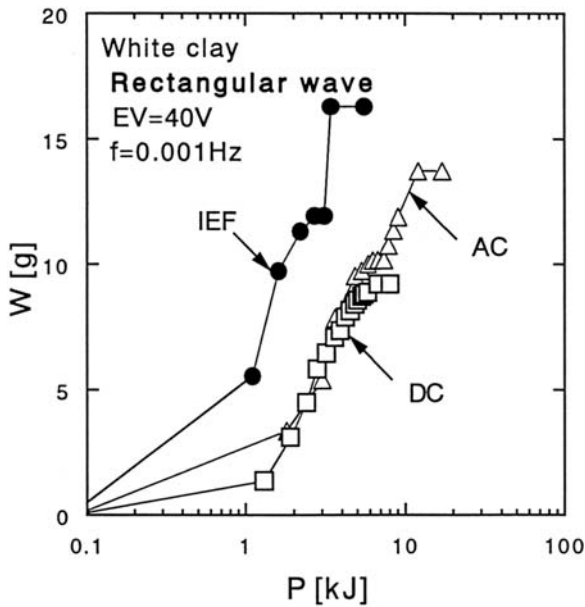


Fig. 13 Relations between  $W$  and  $P$  under IEF, DC and AC



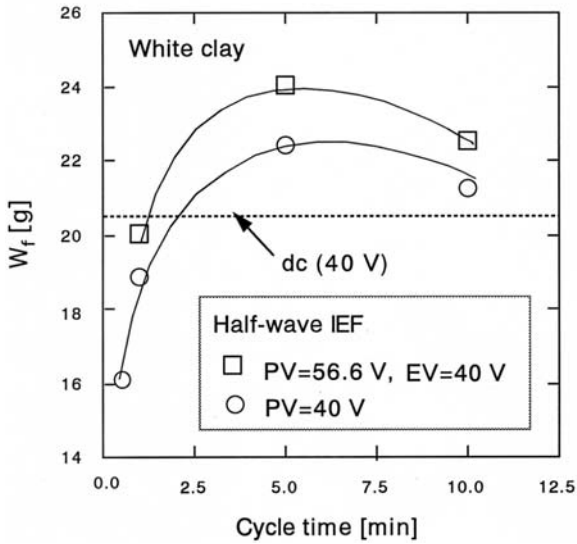


Fig. 14 Relation between total water removal  $W_f$  and cycle time under IEF

An IEF under pulsed DC was also investigated by varying the ratio of on/off time  $R$  defined as:

$$R = \text{off-time/on-time} \tag{18}$$

The relation between  $W_f$  and  $R$  in this pulsed IEF was obtained as shown in Fig. 15. In this figure, the on-time is 4 min in all the pulsed DC IEF; therefore  $R = 1.0$  represents the half-wave IEF and the off-time is 4 min. Figure 16 also shows the relation between the electric power efficiency for the final amount of removed water  $W_f/P_f$  and  $R$  under the pulsed DC IEF. These results indicate that there is an

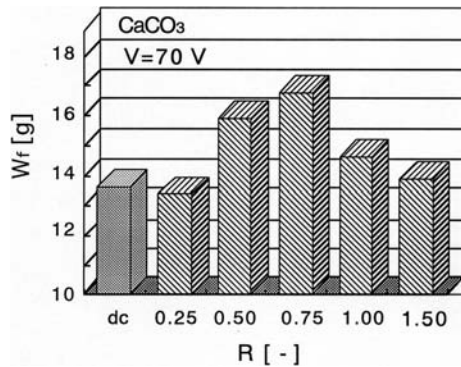
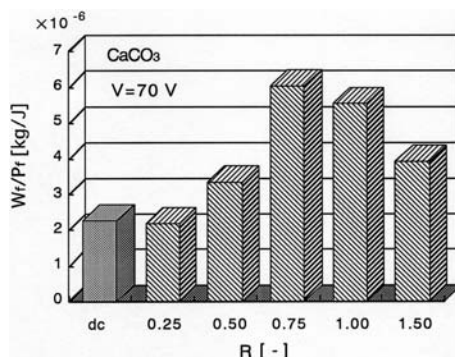


Fig. 15  $W_f$  under pulsed DC IEF

**Fig. 16** Efficiency of electric power consumed for  $W_f$  under pulsed DC IEF



optimum value of  $R$  in terms of both  $W_f$  and  $W_f/P_f$  that are respectively highest at approximately  $R = 0.75$  (off-time = 3 min) for all IEFs (Yoshida et al. 2001).

The effect of the half-wave IEF under pulsed DC was investigated by using a cross-flow continuous-type experimental apparatus which consisted of two vertical cylindrical electrodes. In such an apparatus used for electrokinetic dewatering of slurry, an electric field was applied to the slurry flowing downwards continuously between the vertical cylindrical electrodes. Thus the slurry can be dewatered electro-osmotically toward both sides of the flowing path across the vertical electrodes. The half-wave IEF was also available for the cross-flow continuous dewatering apparatus, and the intermittent power application could be useful for improving the performance of EOD not only in the batch experiment but also in the continuous one (Yoshida 2001).

### 3.3 Electric Field Generated by Combination of Constant Current and Constant Voltage Conditions

The process of EOD has been principally operated and investigated under conditions of either constant voltage, abbreviated to CV, or constant current, abbreviated to CC here. If the electric resistance between two electrodes  $R_E$ , namely the electric resistance of the dewatered material is increased with proceeding of the dewatering, the EOD process operated at CV goes to an end because the electric current passing through the material bed gradually decreases, while the operation at CC has to be stopped forcibly because the voltage required to maintain the condition of CC is too high. The increase or decrease of  $R_E$  depends on the physical and electrical properties of the material to be dewatered. Therefore, a combination of CV and CC could be determined according to the properties of the material so as to make the average strength of electric field,  $E_{av}$ , applied to the whole bed of the material as large as possible in the dewatering process, as described previously in the Section 2.2.

From this point of view, the operation of CV combined with CC was investigated as a means to improve the EOD process, and such a combined operation was shown to be effective in terms of the final amount of water removed  $W_f$  and the efficiency

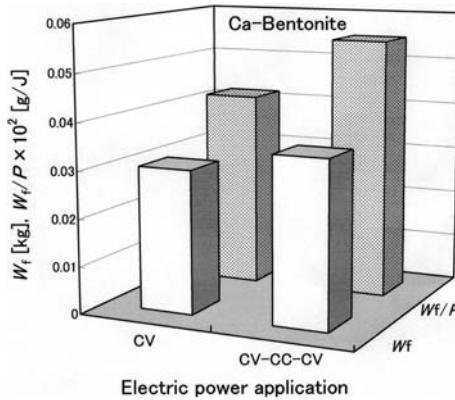


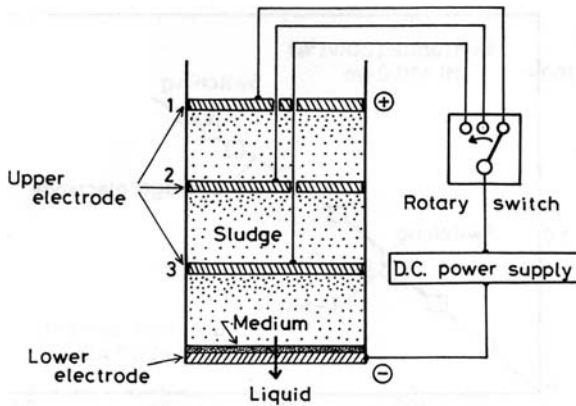
Fig. 17 Effect of combination of CV with CC

of electric power consumption for its removal  $W_f/P_f$ , as an example shown in Fig. 17 (Yoshida et al. 2004).

### 3.4 Electrode Arrangements and Configurations

Electrode arrangements for electro-dewatering in relation to impoundments had been investigated by a group of the Commonwealth Scientific and Research Organization (CSIRO, Australia) (Lockhart 1986). Both horizontal and vertical electrode arrangements were examined for in situ dewatering of sand and coal washery tailings, and their electrodes were respectively set with mesh arrangement with considerable open area in each impoundment. The field trials for dewatering were carried out using horizontal electrode arrangements at a coal washery tailing pond, and the findings were attractive, especially considering the high cost of chemical flocculants needed for centrifugal dewatering practice. The vertical electrode arrangements were found to be more appropriate at a sand washery tailing pond.

As described in the initial part of the Section 3, using EOD, the water content in the sludge bed being processed cannot usually be reduced in the lower part near the drainage surface. That is, it is difficult electro-osmotically to dewater throughout the whole sludge bed. In view of this, an EOD system with multistage upper electrodes was proposed, and it is schematically shown in Fig. 18 (Yoshida 1993). In this figure, the experimental apparatus for the system is a case of three-stage perforated upper electrodes as the anode is arranged vertically at regular intervals within the sludge bed. It can be seen that the bed is divided into three parts by their upper electrodes in the vertical direction. At the beginning, an electric field is applied between the highest upper electrode (anode) and the lower electrode (cathode) on the drainage surface. Thereafter, when the excessive increase of the electrical contact resistance between the highest electrode and the sludge is observed; in other words, a drop of the applied voltage is observed to be considerably large near the highest upper



**Fig. 18** Multistage upper electrode-type EOD apparatus (e.g. three-stage)

electrode, the upper electrode can be changed from the highest to the middle one by use of the rotary switch. Thus, applying an electric field to the sludge bed alternatively by switching in turn from the higher upper electrode downward to the lower one, the water content can be reduced throughout the whole sludge bed. Using a bentonite clay sludge and stainless steel for the electrode material, consequently higher-performance of EOD could be realized using the multistage upper electrode method (Yoshida 1993). However, it may be difficult to remove the upper electrodes from inside of sludge bed after completing the dewatering process.

Another method using a third electrode called the “gate” electrode placed between the upper and lower electrodes was experimented with to enhance the performance of EOD, as illustrated in Fig. 19 (Yamada et al. 2001). According to the experimental results reported, it was possible to control both the flow of electric current and the migration of particles due to electrophoresis caused by the voltage applied to the third gate electrode, and as the result a greater liquid flow could be achieved than ordinary EOD operation. Yamada et al. (2001) also explained their good results obtained under certain conditions in terms of a model of the field effect transistor (FET) that involved electronic charge carriers that could be modulated by choosing a voltage of the gate electrode. Vijn (2002) pointed out that the FET model is not applicable to the phenomena involved in the gate-electrode system, and suggested that the gate-electrode EOD is not essentially much different from the multistage electrode EOD method mentioned above, but the gate electrode system possibly provides a method for improving the EOD process under certain conditions.

Using a rotating upper electrode replaced with a stationary or fixed electrode was experimentally investigated for an improvement of EOD (Ho and Chen 2001). In this case, a sludge of bentonite was used and excess sludge was loaded beyond the upper electrode to keep good contact between the electrode and the dewatered sludge. The perforated plate upper electrode used for anode was rotated with the speed from 0 to 300 rpm. This method promoted significantly an increase in the rate of dewatering with the rotational speed, and the final amount of water removed

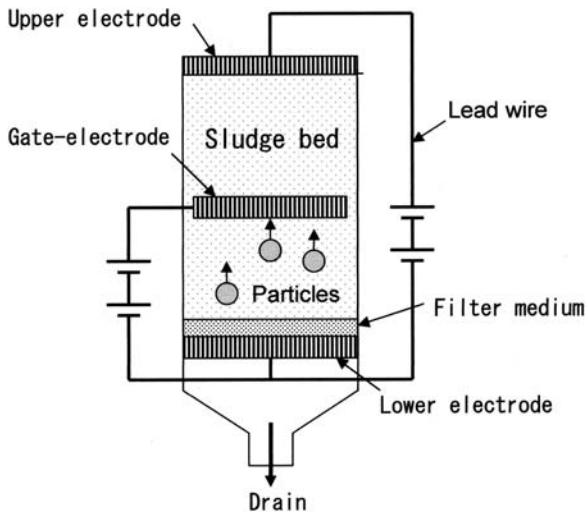


Fig. 19 Experimental arrangement for EOD involving a gate electrode

from the sludge was demonstrated to reach maximum at about 240 rpm, as shown in Fig. 20. It was discussed that such increase as maximum water removal was due to the combined effect of both the “falling-off” of the dewatered sludge from the rotating anode electrode and sufficient supply of fresh sludge on the anode, namely the refreshment of the portion near the anode with wet fresh sludge. The increase of water removal with rotating speed was associated with an electric current increased by anode rotation. For these reasons, both effects would improve the performance of EOD, and the upper electrode rotation also would be useful for making the water

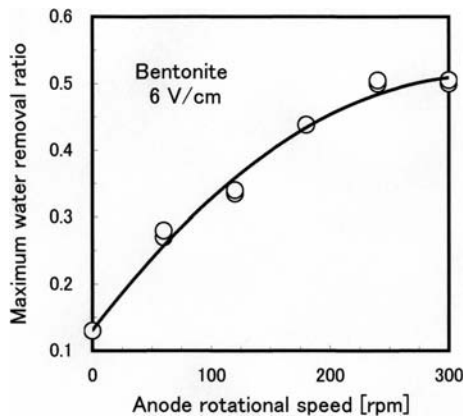


Fig. 20 Increase of dewatering with anode rotational speed

content distribution along the sludge bed more uniform and higher solid concentration of the sludge dewatered.

In order to improve the performance of EOD from the viewpoint of increasing electrical contact resistance, it is also possible to insert the upper electrode into the material as dewatering proceeds, as shown in Fig. 21. Then a porous plate generally used for the upper electrode could be replaced with several rod-type electrodes which are inserted into the sludge bed. In using the rod-type electrodes, if the area of the rod-type electrode available for dewatering is regarded as the area of the bottom surface of each rod, the total area of the upper electrodes which are in contact with the sludge effectively for the dewatering is supposed to become smaller than the area of a porous plate upper electrode used ordinarily.

From this point of view, electric field application was experimentally investigated by decreasing the area of the plate-type upper electrode opposite to the drainage surface compared with the cross-sectional area of the sludge bed, and the influence of such electric field application as decreasing the area of the upper electrode on the dewatering process was discussed in terms of total amount of water removed and electric power consumption (Yoshida and Okada 2006).

Half of the cross-sectional area of the sludge bed was employed for the upper electrode area and the electric field application was operated by the CC condition, and then the experimental results were compared with the upper electrode with the same area as the cross-sectional area of the bed. Figure 22 shows the variations of  $E_{av}$  with the lapse of time for the upper electrode with half area of the cross-section of the sludge bed and with the same area as that. The value of  $E_{av}$  was calculated using Equation (16) using the changes of  $V$  and  $L$  with time. At the beginning,  $E_{av}$  in the upper electrode with half area of the cross-section of the bed is larger than the same-area upper electrode as the bed, as shown in this Fig. 22. This can be ascribed to the increase of  $R_E$  or  $V$  in the half-area electrode. It is also suggested that an increase in the electrical contact resistance in the half-area electrode is reduced compared with the same area electrode. Figure 23 compares the total amount of water removed,  $W_f$ , and the final efficiency of electric power consumption for water removal,  $W_f/P_f$ , in both operating conditions. It is found that both  $W_f$  and  $W_f/P_f$  in the half-area electrode are larger than the same-area electrode of the bed. As mentioned above, a decrease of the area of the upper electrode can be expected for the purpose of improving EOD performance.

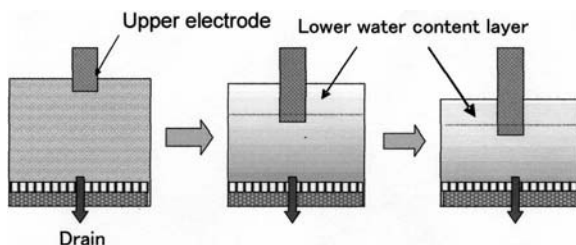


Fig. 21 Rod-type upper electrode inserted into sludge bed with EOD

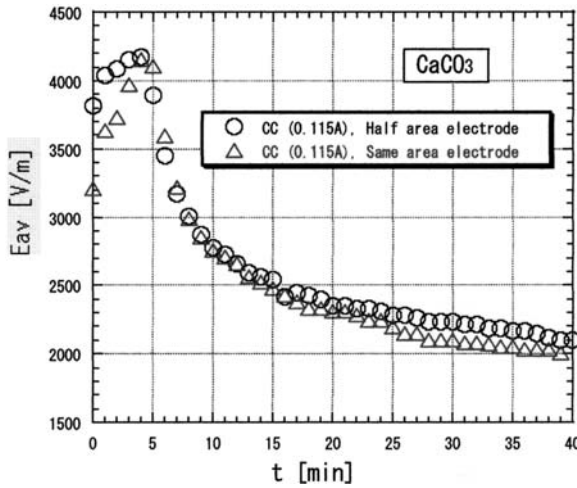


Fig. 22 Time variations of  $E_{av}$  in upper electrode with half area of sludge bed

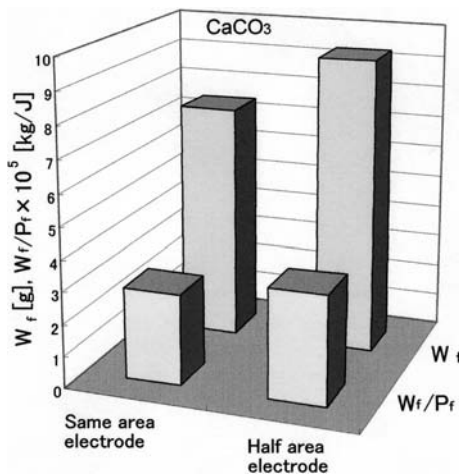


Fig. 23 Effect of half area of upper electrode on  $W_f$  and  $W_f/P_f$

As shown in Fig. 24, an essentially different type of experimental apparatus for EOD from the experimental one shown in Fig. 4 was proposed, in which an electric field was applied horizontally to facilitate the removal of gases produced at electrodes and to keep the anode soaked in water during the dewatering process (Zhou et al. 2001). This experimental apparatus was investigated for dewatering of waste activated sludge taken from a wastewater treatment plant. The activated sludge can be related to the Section 4. Figure 25 illustrates the time evolutions of water removal with the electric field strength as a parameter. It is found that the water removal can

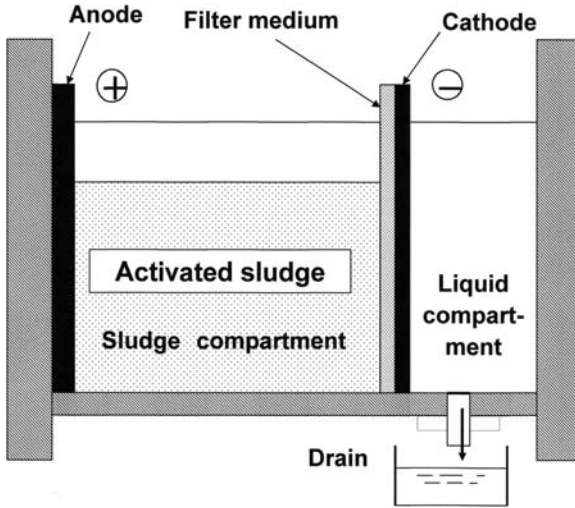


Fig. 24 Experimental apparatus for horizontal electric field

be increased by increasing the applied voltage using the horizontal electric field. It was also reported that, compared to the operation of EOD applied in a vertical electric field, the apparatus using an application of the horizontal electric field had advantages in terms of high efficiency, simple structure, and ease of operation.

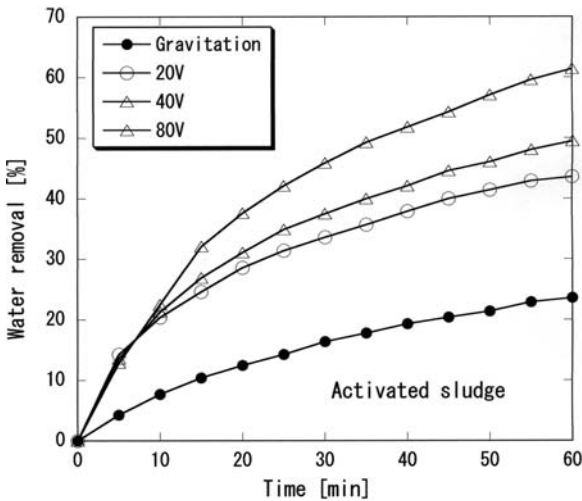


Fig. 25 Time evolutions of water removal with applied voltage



## 4 EOD of Bio-Materials

As described earlier in the Section 2.3, EOD has the potential for dewatering of biomaterials and has some advantages compared with conventional mechanical dewatering methods. It has so far been used in practice mainly for dewatering of biomaterials or biosludges produced from bioindustry and the related industrial fields: for example, sewage/activated sludge, waterworks sludge, food processing products and wastes, and biomass sludge.

### 4.1 Sewage/Activated Sludge and Biomass Sludge

Many installations for disposal of biosludge produced by wastewater treatment process are used widely, so that a large amount of excess sewage/activated sludge gets discharged from the process. Such sludges that are colloidal in nature with extremely small particle size are very difficult to dewater purely mechanically.

Figure 26 gives an example of the effectiveness of EOD on sewage sludge dewatering (Yukawa et al. 1986). Figure 27 shows that the water content in the discharged cake of sewage sludge can be remarkably reduced by EOD, reaching about 50%, which is a value that cannot be attained by mechanical expression (Kondoh and Hiraoka 1990). Accordingly, a few equipments for EOD were developed in Japan, and their practical operations are shown in Figs. 28–29, for example. As shown in Fig. 28, one of them consisted of a rotary drum in which surface of the drum was used as one electrode and a seamless moving belt as the other electrode, and the sludge fed into the space between the drum and moving belt was dewatered electro-osmotically under the combined field of electric field and expression (Yamaguchi et al. 1986). Another industrial EOD device is filter press type as shown in Fig. 29 (Kondoh and Hiraoka 1990). This figure illustrates schematically the sectional view of the filter chamber of the equipment. Each filter chamber consists of filter cloths, filter plates, membrane for expression, and electrodes. After the filter chamber is filled with sludge, the sludge is dewatered by pressure filtration at first and then expressed by inflation of the membrane, and finally dewatered electro-osmotically by an electric field. However, it seems that these equipments are not widely used at this time.

CSIRO in Australia investigated the applicability of EOD to aerobic wastewater treatment sludges which were particularly difficult to dewater using conventional mechanical equipment (Barton et al. 1999). It was reported that the bench-scale dewatering experiments produced cakes with solid contents of 42–46% in weight using EOD, compared with 24–30 wt% using pressure dewatering alone. Thus, EOD showed a substantial increase in the cake solid contents from sewage sludges produced by biological wastewater treatment processes. Barton et al. (1999) discussed a mathematical model for EOD described in the Section 2.1; the basic differential Equation (6), which represents the process of EOD, for the adaptability of application to sewage treatment sludges, and consequently preliminary results

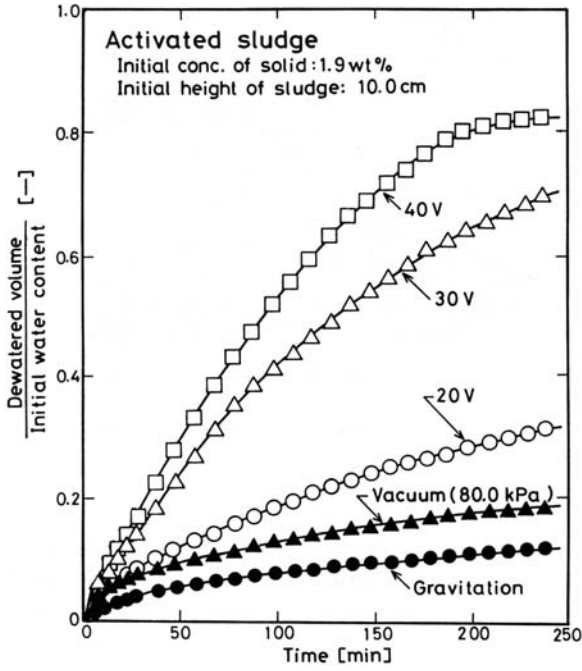


Fig. 26 Effect of EOD on activated sludge

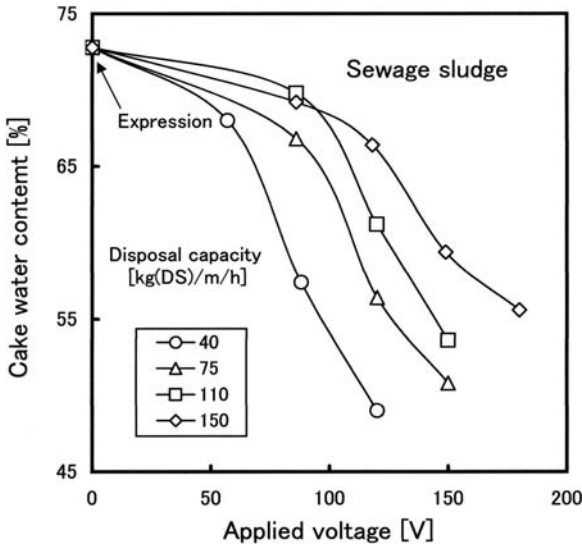


Fig. 27 Effect of combined field dewatering on sewage sludge

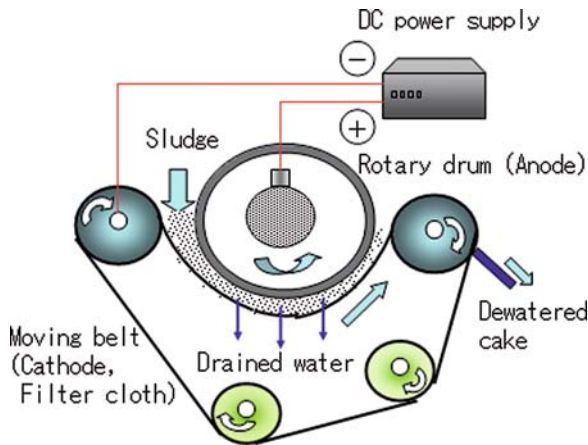


Fig. 28 Rotating drum type EOD machine

provided meaningfully a reasonable simulation of the modeling procedure for the EOD process of sewage sludges as well.

In order to identify a relationship between water removal limits by EOD and the forms of water in sewage sludge, the freezing–thawing technique was also examined using an analysis of proton nuclear resonance (NMR) spectroscopy. And the NMR

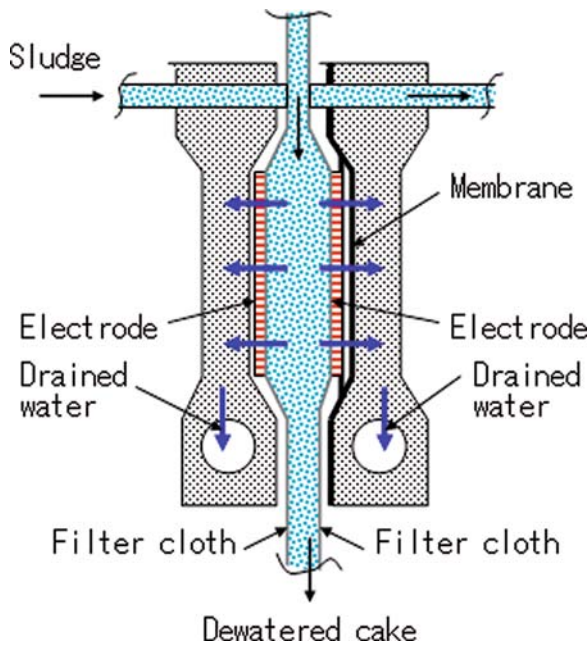


Fig. 29 Sectional view of filter-press-type EOD machine

analysis showed to provide a good way of quantifying the degree of association of water with the solids in thickened sewage sludge, and the dewatering limits by EOD was identified by estimating the forms of water removed by mechanical dewatering (Barton et al. 1999).

For the activated sewage sludge in wastewater treatment, the combined field techniques of both EOD and pressure filtration or expression have been investigated on laboratory and pilot-plant scales by many researchers to find the dewaterability of the sludge and the technical possibility for it. And these techniques were confirmed to be promising for the dewatering of the biological sludges in terms of attainable solid contents (to more than 60 wt%) and very low power consumption compared to that needed by thermal drying techniques (Smollen and Kafaar 1994; Saveyn et al. 2001, 2005, 2006).

Biomass sludge resulting from the concentration of waste slurry from biological wastewater treatment and enzyme production are rich in nutrients, and the sludge can be used as fertilizer for agricultural soils. For the purpose of this utilization, it has to be dewatered previously from around 3–5 wt% to 30 wt% in dry solid contents, which could be easily demonstrated by the operation of EOD experimentally, and low power consumption could be obtained when keeping the strength of electric field to a low level, since the electrical conductivity was quite high for the biomass sludge (Hansen et al. 2003).

## ***4.2 Food Processing Products and Wastes***

The operation of EOD combined with mechanical pressure (expression), which was called the combined field dewatering, has so far been applied to food processing industry, and several studies have been carried out on EOD of food materials.

To produce sardine powder for a gelatinous product such as “kamaboko”, a continuous screw-press-type bench scale dewatering machine that is applicable to avoid protein denaturation of fish meat was developed by applying combined field of electro-osmotic and mechanical methods. In this EOD machine, the screw is used as one electrode and the strainer as the other electrode. Final water content of sardine minced meat soaked with water was only 60% by the conventional mechanical method, but it was reduced to less than 40% in only 15–18 min by applying the combined field (Suzuki et al. 1990).

The process of the combined field dewatering, involving electro-osmosis and expression, was studied experimentally for seaweed (Lightfoot and Raghavan 1994, 1995). They observed that the addition of electro-osmosis to expression significantly improved the performance of dewatering of seaweed. They also found that electro-osmosis reduces the energy consumed for producing kelp meal for animal consumption if dewatering is followed by thermal drying to produce the final product dried.

The potential benefits of combined field dewatering were also investigated for brewer's grain, apple pomace, and vegetable waste (Orsat et al. 1996). They conducted that their solid concentrations with the addition of an electric field to

expression can be increased respectively from 30% to 48% for brewer's spent grain, from 23% to 53% for apple pomace, and from 11% to 67% for vegetable waste. As mentioned above, the combined field dewatering of kelp (seaweed) before drying process had been shown to be useful for reducing energy requirements for drying (Lightfoot and Raghavan 1994). This preliminary investigation led to the development of a pilot-scale operation for the production of kelp meal, and the kelp after treating chemically and draining was dewatered experimentally using the pilot-scale roller-press-type machine for the combined field dewatering (Orsat et al. 1999). The roller press consisted of seven rollers (four bottoms and three tops) and two idler rollers mounted on an aluminum truss frame, and the material to be dewatered was loaded onto a belt, which carried the material through the press rollers where the combined field was applied simultaneously. In this pilot-scale electro-osmotic roller press operation for kelp meal production, it was ensured that the combined field was effective at removing water from the drained kelp, in spite of remaining problems with capacity and reliability.

Vegetable wastes produced from the food industry are costly to handle because of their high moisture content. Effectiveness of the combined field dewatering for such vegetable waste sludges was studied experimentally on small scale (Chen et al. 1996). Chen et al. (1996) used fresh vegetable sludge samples made from one part by weight of cauliflower and two parts of cucumber as a model of vegetable waste. In the experiments with such a vegetable sludge, the final average water removal of 55% was achieved by the combined field dewatering, and this was twice as high as that of mechanical pressure alone and four times as high as that of EOD alone.

Figure 30 shows the water removal with different initial heights of the sludge bed for the combined field dewatering, in which the mechanical pressure was fixed at a constant value and the initial strength of electric field, defined as the applied

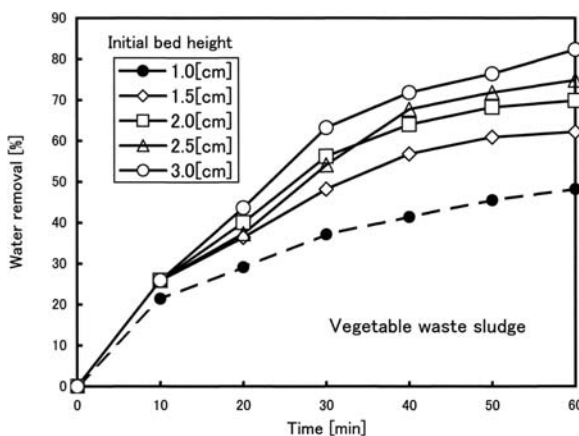


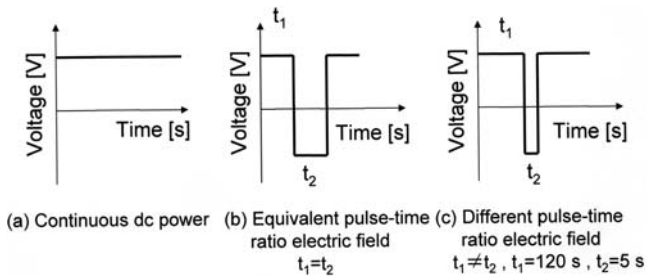
Fig. 30 Effect of initial bed height for vegetable sludge

voltage divided by the initial bed height, was also fixed at a constant value. It is observed in this figure that the water removed increases with increasing the initial height of sludge bed and also the increase in the water removal tends to be smaller with the initial bed height. Consequently, for the model vegetable sludges tested, it was found that the combined field dewatering is more effective than just EOD and mechanical pressure contributes significantly to the sludge dewatering, and that the increase in the initial bed height increases the amount of water removed.

“Tofu” is a soy food generally regarded as one of the healthy foods and is very popular in east Asia. The production of tofu yields enormous waste stream known as “okara,” which is the solid residue after separation of soymilk produced by squeezing or centrifugation of soybean mash. A large amount of okara discharged in tofu manufacturing process has to be dried and burned or sent to landfill, but the storage and transportation of it are very difficult because of its high moisture content on wet basis (around 80%). Hence, okara treatment and disposal have been a serious problem in food processing. To enhance the dewatering efficiency of okara, a twinscrew-press-type ceramicfilter with electro-osmosis was designed and examined (Isobe et al. 1996; Li et al. 1999). It was reported that the water content of okara was decreased by the screw press from 85% to 74% of which the dewatering efficiency was 50%, and that was reduced considerably up to 40% in case of a batch compression process with the addition of electro-osmosis. The experiments by electro-osmosis were performed using DC and AC electric fields with the frequency from 0.2 to 0.5 Hz, and the low-frequency AC fields combined with mechanical pressure had the potential to be used in the dewatering of okara compared with DC operation (Isobe et al. 1996).

Making a sheet of tofu, mechanical pressure dewatering has been used commonly, but it has the disadvantage of low dewatering efficiency and poor quality control based on the experience of the manufacturers. The combined field of electro-osmosis and constant mechanical pressure was performed on the dewatering process of tofu sheet (Li et al. 2002; Xia et al. 2003). Li et al. (2002) examined the application of AC electric field with frequency ranging from 0.3 to 5 Hz for the dewatering of tofu sheet, and found that the dewatering time was shortened markedly and the AC frequency in the range 0.5–1 Hz provided good quality of tofu sheet dewatered in terms of strength, strain and toughness. Xia et al. (2003) investigated combined field dewatering for 10–30 min at applied voltage ranging from 30 to 50 V under various pulsed DC electric field as shown in Fig. 31, and the microstructure of tofu sheet was also observed by a scanning electron microscope (SEM). According to their results, the combined field dewatering was found to increase the dewatering rate for tofu sheet compared with that by mechanical pressure only. SEM micrographs showed that the network of tofu sheet near anode was significantly more compact and homogeneous, if the treatment of EOD was added to mechanical pressure dewatering.

Removal of water by EOD from tomato paste suspension was also used to concentrate the suspension (Al-Asheh et al. 2004; Jumah et al. 2005). For the purpose of this treatment, an apparatus was designed in a vertical orientation, and



**Fig. 31** Application of different electric fields

laboratory tests demonstrated applying electric field under both DC and AC operations to the tomato paste suspension held between two electrodes. The effects of applied voltage, electric current, height of the bed, pH, and initial solid concentration of the suspension were examined in terms of water removal and energy consumption for dewatering. It is reported that significant amounts of water can be removed by EOD under the operating conditions used. This process saved 70% of energy compared with that needed to dry the same amount of water. The application of AC electric field provided more promising results than those by DC application.

### 4.3 Miscellaneous Topics

There are a few interesting papers which are related to EOD applications where dewatering per se is not objective (Vijh 1999a,b,c; 2004). Electrochemical treatment of cancerous tumors has been studied experimentally. Vijh (1999c) proposed a theoretical model to analyze the primary mechanism of electrochemical treatment of the tumors. The idea for the analysis was that the process of electrochemical treatment can be regarded as a case of EOD of the tumor tissue with the consequent changes in pH, with the concomitant role of reactions at the electrodes. That is, the electrochemical treatment of tumor causes a net flow of water from the anode to the cathode, causing EOD of the tissue, based on the electrically induced flow of water trapped between the tumor cells. All the main experimental observations—for example, water removal near the anode and water accumulation near the cathode as well as the associated pH changes and other factors considered to be involved in necrosis—were explained by the analysis proposed. Some suggestions were made based on the analysis to explain the enhancement of the efficacy of the process of electrochemical treatment of cancerous tumors.

Electrokinetic remediation of contaminated soils and dredged sediments is another application of EOD, which has attracted major attention. However, this subject is outside of the scope of this chapter (e.g., Shaplo and Probstein 1993; Reddy et al. 2005).

## 5 Closing Remarks

Although EOD has been examined both theoretically and experimentally for decades and its advantages in dewatering are well documented, commercial applications are still few. Typically EOD is not as cost-effective as a stand-alone operation. It is necessary to use it in combination with pressure or vacuum dewatering. Thus the equipment capital cost is higher than that of conventional dewatering equipment. Future R&D will hopefully allow cost-effective development of EOD-enhanced equipment for sludge dewatering and contaminated soil remediation.

## References

- Al-Asheh, S., Jumah, R., Banat, F. and Al-Zou'Bi, K. (2004) Direct current electro-osmosis dewatering of tomato paste suspension. *Food and Bioproducts Processing*. 82(C3), 193–200.
- Barton, W. A., Miller, S. A. and Veal, C. J. (1999) The electro-dewatering of sewage sludges. *Drying Technology*. 17(3), 497–522.
- Chen, H., Mujumdar, A. S. and Raghavan, G. S. V. (1996) Laboratory experiments on electro-osmotic dewatering of vegetable sludge and mine tailings. *Drying Technology*. 14(10), 2435–2445.
- Gray, D. H. and Somogyi, F. (1977) Electro-osmotic dewatering with polarity reversals. *Journal of Geotechnical Engineering Division*. 103(1), 51–54.
- Gopalakrishnan, S., Mujumdar, A. S. and Weber, M. E. (1996a) Optimal off-time in interrupted electro-osmotic dewatering. *Separations Technology*. 6(3), 197–200.
- Gopalakrishnan, S., Mujumdar, A. S., Weber, M. E. and Pirkonen, P. M. (1996b) Electro-kinetically enhanced vacuum dewatering of mineral slurries. *Filtration & Separation*. Nov/Dec, 33, 929–932.
- Hansen, H. K., Kristensen, I. V., Ottosen, L. M. and Villumsen, A. (2003) Electro-osmotic dewatering of porous materials-experiences with chalk, iron hydroxide and biomass sludges, and wet fly ash. *Journal of Chemical Engineering of Japan*. 36(6), 689–694.
- Ho, M. Y. and Chen, G. (2001) Enhanced electro-osmotic dewatering of fine particle suspension using a rotating anode. *Industrial and Engineering Chemistry Research*. 40(8), 1859–1863.
- Isobe, S., Uemura, K. and Noguchi, A. (1996) Dewatering of soybean residue “okara” by electro-osmosis and screw press. *Proceedings of The Second International Soybean Processing and Utilization Conference*. Bangkok, Thailand, pp. 523–527.
- Iwata, M. (2000) Final moisture distribution in materials after electro-osmotic dewatering. *Journal of Chemical Engineering of Japan*. 33(2), 308–312.
- Iwata, M., Igami, H., Murase, T. and Yoshida, H. (1991a) Analysis of electro-osmotic dewatering. *Journal of Chemical Engineering of Japan*. 24(1), 45–50.
- Iwata, M., Igami, H., Murase, T. and Yoshida, H. (1991b) Combined operation of electro-osmotic dewatering and mechanical expression. *Journal of Chemical Engineering of Japan*. 24(3), 399–401.
- Iwata, M., Sato, M. and Nagase, H. (2004) Analysis of constant-electric electro-osmotic dewatering. *Kagaku Kogaku Ronbunshu*. 30(5), 626–632.
- Jumah, R., Al-Asheh, S., Banat, F. and Al-Zoubi, K. (2005) Electro-osmotic dewatering of tomato paste suspension under AC electric field. *Drying Technology*. 23(7), 1465–1475.
- Kondoh, S. and Hiraoka, M. (1990) Commercialization of pressurized electro-osmotic dehydrator (PED). *Water Science and Technology*. 22(12), 259–268.
- Li, L., Li, X., Uemura, K. and Tatsumi, E. (1999) Electro-osmotic dewatering of okara in different electric fields. *Proceedings of The 99-th International Conference on Agricultural Engineering*. Beijing, China, pp. IV58–IV63.



- Li, X., Nanayama, K., Uemura, K., Sakabe, H. and Isobe, S. (2002) Production of tofu sheet by electro-osmosis combined with mechanical compression. Proceedings of The Third Annual Meeting of The Society of Food Engineers, Japan. Tokyo, Japan. OF-5, p. 75.
- Lightfoot, D. G. and Raghavan, G. S. V. (1994) Combined fields dewatering of seaweed (*nerocystis luetkeana*). Transactions of the ASAE. 37(3), 899–906.
- Lightfoot, D. G. and Raghavan, G. S. V. (1995) Combined fields dewatering of seaweed with a roller press. Applied Engineering in Agriculture. 11(2), 291–295.
- Lockhart, N. C. (1986) Electro-dewatering of fine suspensions. In: H. S. Muralidhara (Ed.), *Advances in solid-liquid separation*. Battelle Press, Columbus, pp. 241–274.
- Lockhart, N. C. (1992) Combined field dewatering: bridging the science-industry gap. Drying Technology. 10(4), 839–874.
- Lockhart, N. C. and Hart, G. H. (1988) Electro-osmotic dewatering of fine suspensions: the efficacy of current interruptions. Drying Technology. 6(3), 415–423.
- Orsat, V., Raghavan, G. S. V. and Norris, E. R. (1996) Food processing waste dewatered by electro-osmosis. Canadian Agricultural Engineering 38(1), 1–5.
- Orsat, V., Raghavan, G. S. V., Sotocinal, S., Lightfoot, D. G. and Gopalakrishnan, S. (1999) Roller press for electro-osmotic dewatering of bio-materials. Drying Technology. 17(3), 523–538.
- Rabie, H. R., Mujumdar, A. S. and Weber, M. E. (1994) Interrupted electro-osmotic dewatering of clay suspensions. Separations Technology. 4, 38–46.
- Rampacek, C. (1966) Electro-osmotic and electro-phoretic dewatering as applied to solid-liquid separation. In: J. B. Poole and D. Doyle (Eds.), *Solid-liquid separation-a review and a bibliography*-. Her Majesty's Stationery Office. London, pp. 100–108.
- Reddy, K. R., Urbanek, A. and Khodadoust, A. P. (2005) Electro-osmotic dewatering of dredged sediments; bench-scale investigation. Journal of Environmental Management. 78(2), 200–208.
- Shapfro, A. P. and Probstein, R. F. (1993) Removal of contaminants from saturated clay by electro-osmosis. Environmental Science & Technology. 27(2), 283–291.
- Saveyn, H., Curvers, D., Pel, L., DeBondt, P. and Van der Meeren, P. (2006) In situ determination of solidosity profiles during activated sludge electro-dewatering. Water Research. 40(11), 2135–2142.
- Saveyn, H., Huybregts, L. and Van der Meeren, P. (2001) Enhanced sludge dewatering by electro-filtration; a feasibility study. Meded Rijksuniv Gent Fak Landbouwkd Toegep Biol Wet. 66(3a), 71–78.
- Saveyn, H., Pauwels, G., Timmerman, R. and Van der Meeren, P. (2005) Effect of polyelectrolyte conditioning on the enhanced dewatering of activated sludge by application of an electric field during the expression phase. Water Research. 39(13), 3012–3020.
- Shirato, M., Murase, T., Kato, H. and Fukaya, S. (1967) Studies on expression of slurries under constant pressure. Kagaku Kogaku. 31(11), 1125–1131.
- Smollen, M. and Kafaar, A. (1994) Electro-osmotically enhanced sludge dewatering; pilot-plant study. Water Science and Technology. 30(8), 159–168.
- Suzuki, Y., Konno, M., Sato, Y. and Shishido, I. (1990) Development of continuous dehydrator for fish meat by electro-osmotic method. Kagaku Kogaku Ronbunshu. 16 (6), 1133–1137.
- Vijh, A. K. (1999a) The significance of current observed during combined field and pressure electro-osmotic dewatering of clays. Drying Technology. 17(3), 555–563.
- Vijh, A. K. (1999b) Salient experimental observations on the electro-osmotic dewatering (EOD) of clays and sludges and their interpretation. Drying Technology. 17(3), 575–584.
- Vijh, A. K. (1999c) Electrochemical treatment of tumors (ECT): Electro-osmotic dewatering (EOD) as the primary mechanism. Drying Technology. 17(3), 585–596.
- Vijh, A. K. (2002) Electro-osmotic dewatering by a “new” method using a “gate” electrode; field effect transistor (FET) model or simply a multistage dewatering? Drying Technology. 20(3), 705–710.
- Vijh, A. K. (2004) Electro-chemical effects in biological materials: electro-osmotic dewatering of cancerous tissue as the mechanistic proposal for the electro-chemical treatment of tumors. Journal of Materials Science: Materials in Medicine. 10(7), 419–423.

- Wakeman, R. J. and Tarleton, E. S. (1999) *Filtration -equipment selection modelling and process simulation*. Elsevier Advanced Technology. Oxford, pp. 244–246.
- Xia, B., Sun, D.-W., Li, L.-T., Li, X.-Q. and Tatsumi, E. (2003) Effect of electro-osmotic dewatering on the quality of tofu sheet. *Drying Technology*. 21(1), 129–145.
- Yamada, K., Hobo, Y., Hayashi, N., Uchida, E. and Watanabe, S. (2001) Achieving increased efficiency in a solid-liquid separation process using electro-osmosis. *Proceedings of Filtration and Separation Symposium '01*. Tokyo, Japan, pp. 161–164.
- Yamaguchi, M., Arai, T. and Matsusita, H. (1986) Dewatering of Wastewater and sewage sludges by an electro-osmotic dewatering system. *Yosui To Haisui (Water and Waste)*. 28(4), 36–41.
- Yoshida, H. (1993) Practical Aspects of Dewatering Enhanced by Electro-Osmosis. *Drying Technology*. 11(4), 787–814.
- Yoshida, H. (2000) Electro-osmotic dewatering under intermittent power application by rectification of a.c. electric field. *Journal of Chemical Engineering of Japan*. 33(1), 134–140.
- Yoshida, H. (2001) Effect of intermittently applied electric field on electro-kinetic dewatering of slurry in a cross-flow continuous type dewatering apparatus. *Journal of Chemical Engineering of Japan*. 34(6), 840–843.
- Yoshida, H., Fujimoto, T. and Hishamudi Hassan, H. (2004) Electro-osmotic dewatering under electric fields with combination of constant voltage and constant current. *Kagaku Kogaku Ronbunshu*. 30(5), 633–635.
- Yoshida, H., Kitajyo, K., and Nakayama, M. (1999) Electro-osmotic dewatering under a.c. electric field with periodic reversals of electrode polarity. *Drying Technology*. 17(3), 539–554.
- Yoshida, H. and Okada, M. (2006) Influence of electric field application with decreasing one sided area of electrodes in electro-osmotic dewatering. *Drying Technology*. 24, 1313–1316.
- Yoshida, H., Tanaka, K. and Komatsu, M. (2001) Influence of on and off times of power application on electro-osmotic dewatering under intermittent electric field. *The Transactions of Filtration Society*. 2(1), 27–32.
- Yoshida, H. and Yukawa, H. (1991) Analysis of dewatering processes enhanced by electro-osmosis. *Fluid/Particle Separation Journal*. 4(1), 1–7.
- Yoshida, H. and Yukawa, H. (1992) Analysis of electro-osmotically enhanced sludge dewatering. In: A. S. Mujumdar (Ed.), *Advances in drying, vol.5*. Hemisphere, Bristol, pp. 301–323.
- Yukawa, H., Hakoda, M., Okonogi, H. and Yoshida, H. (1986) Electro-osmotic dewatering of wasted activated sludge. *Yosui To Haisui (Water and Waste)*. 28(6), 30–35.
- Zhou, J., Liu, Z., She, P. and Ding, F (2001) Water removal from sludge in a horizontal electric field. *Drying Technology*. 19(3&4), 627–638.

# Electrofiltration of Biomaterials

R. Hofmann, T. K appler, and C. Posten

**Abstract** Solid–liquid separation of biomaterials is still a problem that has not sufficiently been solved on the technical scale. Most biological compounds like cells and biopolymers exhibit comparatively high electrical surface charges. These allow for the application of electrical forces strong enough to overcome hydrodynamical forces. The contribution given here describes an innovative filter chamber, which makes use of this property. In this so-called press electrofiltration, an electrical field is superimposed onto a conventional dead-end filtration with membranes on both sides of the filtration chamber. The electrical field induces an electrophoretic flux of charged biomaterials towards the oppositely charged electrode. Thus, a big filter cake can be built up on the membrane at this side, while dewatering happens at the membrane next to the other electrode. Here only a thin surface layer is formed. One special feature of this newly designed filter chamber is the separation of the electrodes by flushing chambers. These allow for the removal of electrolysis gases, as well as for pH and temperature control. After reviewing the mathematical description of electrofiltration, the chapter highlights the advantages of this approach by describing different application examples. These range from dewatering of biopolymers, namely polysaccharides and proteins, to removal of cells from product up to fractionation of different polymer colloids from each other. Each example is extensively discussed on the basis of given data for model systems and for real fermentation suspensions. It is outlined that press electrofiltration is especially worthwhile for fine, highly charged particles as being present in biosuspensions. One unique selling point is the high final biopolymer concentration, which can be reached. For transfer of these examples to processes in fermentation or food industries useful general guidelines are given at the end of the chapter.

---

R. Hofmann  
Evonik Degussa GmbH, Process Technology  
e-mail: ralph.hofmann@degussa.com

## 1 Introduction

Bioseparation gets more and more important with the increasing level of chemical production, which is impacted by biotechnology. As the purification of biopolymers is often the most difficult task during a bioproduction, more effective and economically attractive ways have to be developed to cope with the multicomponent broths containing a valuable product. An ideal bioseparation process step combines high separation efficiency with high selectivity and with gentle process conditions. These requirements are best fulfilled by using membrane processes (Ghosh 2003). Membrane processes are used to separate and concentrate microorganisms in the primary separation step. Ultrafiltration is used to increase the concentration of biopolymers such as proteins. For the filtration of biological material, there is the drawback of high filtration resistances that biopolymers and microorganisms have. Therefore, filtration processes are normally performed in a cross-flow mode where a flow tangential to the filtration direction reduces the buildup of the filter cake. To guarantee a flow that creates a shear force that is high enough, the liquid must not exceed a certain viscosity. As biopolymers often significantly increase viscosity with increasing concentration, the end concentration of a cross-flow filtration is limited. Additionally, shear forces can damage sensitive enzymes, which is also a drawback (Kaufmann 1997). Electrofiltration is a promising alternative membrane process for an effective dewatering and fractionation of biomaterials, and especially biopolymers. Here an electric field is used to decrease the filter cake build-up. As biopolymer molecules—and therefore the colloid particles—often have charged groups on their surfaces, they can be easily influenced in their movement by an electric field. The electric field is brought into a filter chamber in a way that the electric force on the molecule or particle to be separated within the chamber is directed opposite to the flux direction. The concept was used for microfiltration and ultrafiltration in bio-applications (Iritani et al. 1992; Wakeman 1986; Wakeman 1998). Electrofiltration can be used especially when high end concentrations are to be achieved or to reach very high selectivities. The charge then has to be different within the system to be separated. Concentration of biosolids allows very high end concentrations, which can directly be fed into a drying system.

## 2 Dewatering of Biomaterials by Press Electrofiltration

Solid–liquid separation of biomaterials is, due to the poor permeability of biomaterial filter cakes, still a problem that has not sufficiently been solved on the technical scale. Additional to their small size, another reason for the bad filterability of biomaterials and especially biopolymers can be found in their strong interaction with their solvent, which in most cases is water. However, biomaterials also have a characteristic that makes them well suited for the application of the press electrofiltration—that is their high surface charge resulting from dissociation of functional groups or the adsorption of small salt ions.

## 2.1 Force Balance

Press electrofiltration superimposes an electric field onto a conventional dead-end filtration. Due to this electric field, an electrophoretic flux of biomaterial is induced in the opposite direction of the convective material flux, which is caused by the hydraulic pressure gradient. This leads to a reduced surface layer or filter cake build-up and further to accelerated filtration kinetics.

The forces that act on a single bioparticle can be estimated using the following equations: The convective filtrate flux causes a hydrodynamic resistance force to act on each particle deposited in the filter cake. This hydrodynamic force can be estimated in a first assumption by Stoke's law:

$$F_R = 6 \cdot \pi \cdot \eta_f \cdot r_h \cdot v_f \quad (1)$$

In this equation the resistance force  $F_R$  is proportional to the hydrodynamic radius of the particle and the filtrate flux velocity  $v_f$ . According to Karman and Kozeny (Rumpf and Gupte 1971) the filter cake's permeability, and so the filtrate flux velocity, is in the first assumption proportional to the particle size to the power of 2. Using this assumption for the hydrodynamic resistance force one gets the rough proportionality:

$$F_R \sim r_h^3 \quad (2)$$

The electric force acting on a charged bioparticle with the zeta potential  $\zeta$  can be estimated by Equation (3) (Schwuger 1996):

$$F_{el} = 4 \cdot \pi \cdot \varepsilon \cdot \varepsilon_0 \cdot r_h \cdot \zeta \sim r_h \quad (3)$$

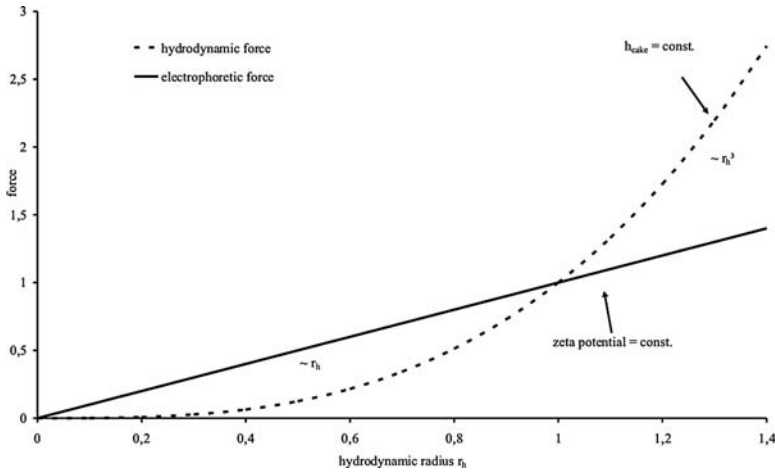
Thus, the electric force  $F_{el}$  increases proportionally with the size  $r_h$  of the bioparticle, while the hydrodynamic force increases with the particle size to the power of 3.

Figure 1 shows the curve progressions of these forces acting in opposite directions with increasing particle size  $r_h$ . From this comparison and the Equations (1) and (3), one can see that especially for very fine and highly charged particles, the electrophoretic force overwhelms the hydrostatic resistance force.

Hence, the following statements can be deduced from Equations (1) and (2):

- Press electrofiltration is worthwhile for fine particles and colloids such as microorganisms, cell debris, and biopolymers.
- Press electrofiltration is worthwhile for the separation of highly charged particles and colloids as biopolymers having dissociated chemical groups

Since biomaterials especially biopolymer such as polysaccharides and proteins are often highly charged due to amino groups or carboxyl groups, press electrofiltration is especially suited for their separation. Originally press electrofiltration



**Fig. 1** Estimation of the electric force and the hydrodynamic force as function of the hydrodynamic radius of a bioparticle

was investigated for the dewatering of mineral suspensions. However, the great disadvantage of dewatering mineral suspension compared to biosuspension by the electrofiltration is the use of costly electrical energy, which often is not profitable for such low-cost bulk products. Furthermore, suspended mineral particles are not that fine and are hard to filter as biopolymers and their surface charge are generally much smaller as they lack dissociated chemical groups.

## 2.2 Filtration

For the macroscopic description of the cake (or dead-end) filtration Darcy's law can be employed. In this equation the filtrate volume flux is proportional to the applied pressure  $\Delta p$  and the square of the filter surface area, and is inversely proportional to the viscosity of the solvent  $\eta_f$ , the mass specific filter cake resistance  $\alpha_{av}$ , and the deposited mass of biomaterial on the filter  $m_{\text{cake,dry}}$ .

$$\frac{dV_f}{dt_f} = \frac{\Delta p \cdot A^2}{\eta_f \cdot \alpha_{av} \cdot m_{\text{cake,dry}}} \quad (4)$$

The filtration resistance of the filter medium is neglected here as the cake resistance highly dominates filtration kinetics.

The overall mass balance around the filter cake

$$m_{\text{cake,dry}} = c \cdot (V_f + V_{\text{cake,wet}}) \quad (5)$$

leads to a relationship between the deposited mass of biomaterial  $m_{\text{cake,dry}}$  and the filtrate volume  $V_f$ .

Since  $V_{\text{cake,wet}}$  is much smaller than  $V_f$ , Equation (5) can be approximated as follows:

$$m_{\text{cake,dry}} = c \cdot V_f \quad (6)$$

With the relation of Equation (6) the integrated form of Equation (4) is given as

$$\frac{t_f}{V_f} = \frac{\eta_f \cdot \alpha_{\text{av}} \cdot c}{2 \cdot \Delta p \cdot A^2} \cdot V_f \quad (7)$$

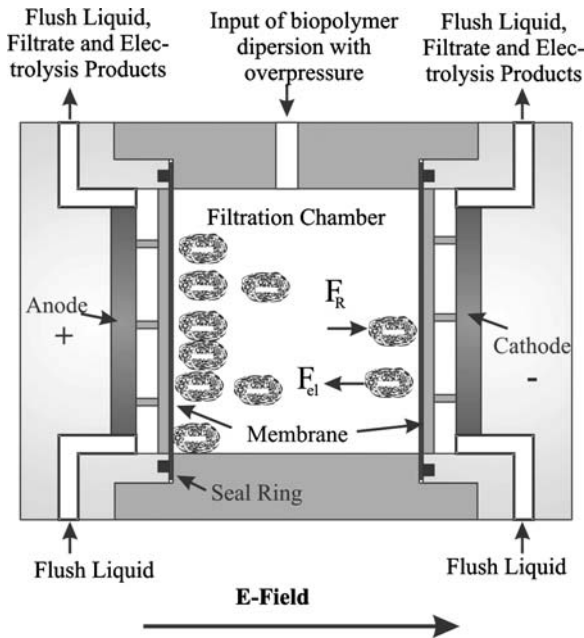
Since polymer filter cakes are highly compressible, an average specific filtration resistance  $\alpha_{\text{av}}$  must be used, which in the integrated Darcy's law, Equation (7), is averaged over the filter cake height and the filtration time  $t_f$ . Furthermore, the filter resistance of the filter medium was neglected in the equations above as in most cases the filter cake resistance of the biomaterials is much greater than the filter resistance of the membrane or filter cloth.

By plotting the filtration time  $t_f$  and the total filtrate volume  $V_f$  data as  $t_f/V_f$  versus  $V_f$ , the specific filter cake resistance  $\alpha_{\text{av}}$  can be calculated from the slope of the plot, if a conventional press filtration is performed.

Press electrofiltration superimposes an electric field onto a conventional dead-end filtration. The electric field acts parallel to the flow direction of the filtrate, and therefore the process remains a dead-end filtration process. The electric field induces an electrophoretic flux of charged biomaterials towards the oppositely charged electrode. In the case of negatively charged biopolymers, the filter cake assembly on the membrane next to the cathode (minus pole) is reduced by the electrophoretic flux of these biopolymers away from this membrane. Thus, only a thin surface layer is formed on this filter medium. In the following text this membrane is termed the cathode-side membrane, or working membrane see Fig. 2. The negatively charged biopolymers are retained by the opposing anode-side membrane, where they are deposited, forming a thick filter cake. If the biomaterial is negatively charged, electrophoretic and convective biopolymer flux act in opposite directions at the cathode-side membrane. This means that on this membrane the filter cake buildup is reduced due to the electric field. The filtration on this "working" membrane can be described by Yukawa's enhancement of Darcy's law (Hofmann 2005; Hofmann, Kaeppler and Posten 2006).

Therefore, Yukawa et al. (1976) enhanced the integrated Darcy equation (Equation 7) in the numerator by the externally applied electric field strength  $E$ , given as  $(E_{\text{crit}} - E)/E_{\text{crit}}$ . Thereby  $E_{\text{crit}}$  is the critical electric field strength at which the electric force is in balance with the hydrodynamic resistance force. In order to account for the electro-osmotic dewatering of the filter cake, an electro-osmotic pressure  $\Delta p_e$  is added to the hydraulic pressure  $\Delta p_h$ . This enhancement of Darcy's law is shown in Equation (8)

$$\frac{t_f}{V_f} = \frac{\eta_f \cdot \alpha_{\text{av}} \cdot c \cdot (E_{\text{crit}} - E)/E_{\text{crit}}}{2 \cdot (\Delta p_h + \Delta p_e) \cdot A^2} \cdot V_f \quad (8)$$

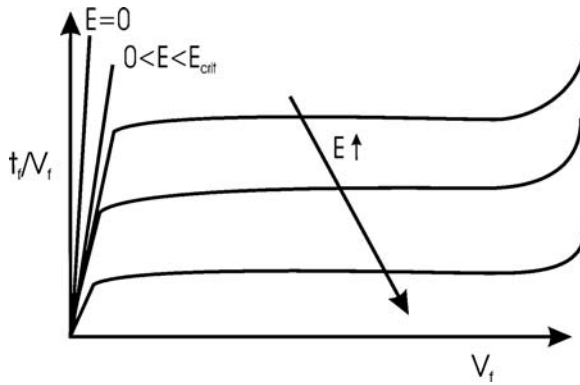


**Fig. 2** Press electrofiltration using an electrofilter plate,  $F_R$ : hydrodynamic force and  $F_{el}$ : electric force

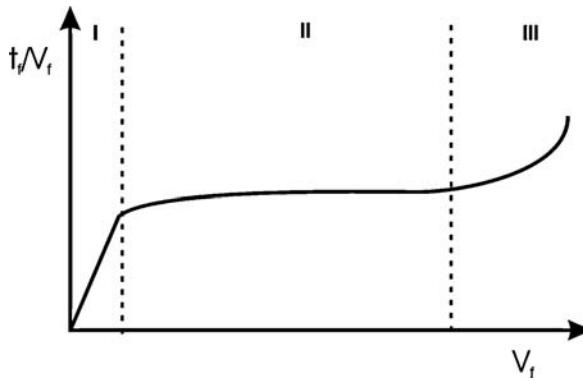
Figure 3 shows different  $t_f/V_f$  versus  $V_f$  plots with varying electric field strengths. The  $t_f/V_f$  versus  $V_f$  plot of a conventional press filtration without an superimposed electric field has a constant positive slope. This indicates that a filter cake is continuously built up on both filtration membranes, thereby reducing the filtrate flux. At the outset, in response to an increasing electric field, the slope of the  $t_f/V_f$  over the  $V_f$  curve decreases. Nevertheless it remains stable. However at a certain electric field strength it changes its course. Ideally the  $t_f/V_f$  versus  $V_f$  plot shows a section with a horizontal proceeding. This indicates that the applied electric field strength is as great as the critical electrical field strength in Equation (8). At this field strength, the slope is zero. For a phenomenological interpretation of the proceedings during the press electrofiltration, the curve in Fig. 4 is divided into three sections (Hofmann and Posten 2003). In this example a negatively charged biopolymer is dewatered by press electrofiltration. This means that during the filtration the negatively charged biopolymers migrate to the anode-side membrane and away from the cathode-side membrane.

*Section I:* The plot shows a positive slope. At the beginning of the press electrofiltration there is no biopolymer filter cake on either membrane, resulting in a large filtrate flux. Thus, a large hydrodynamic resistance force acts on biopolymers deposited on the membrane. A thin filter cake is formed on the membrane, since the resistance force is greater than the electrophoretic force.





**Fig. 3** Schematic  $t_f/V_f$  versus  $V_f$  plots at different electric field strengths



**Fig. 4** Schematic  $t_f/V_f$  versus  $V_f$  plot for the press electrofiltration of a highly charged bioparticle

*Section II:* The formation of a biopolymer cake on the anode- and the cathode-side membrane in Section I causes a decrease in both the filtrate flux and the hydrodynamic resistance force acting on the biopolymers deposited on the membranes. On the anode-side membrane the resistance force and the electrophoretic force act in the same direction, but on the cathode-side membrane they act in opposite directions. At a certain point, the resistance force acting on the biopolymer on the cathode-side membrane becomes as great as the electrophoretic force. From this point no more biopolymer is deposited on the cathode-side filter cake. The  $t_f/V_L$  versus  $V_L$  plot shows a horizontal course since the filter cake height remains constant. The electric field strength here is as large as the critical electric field strength in Yukawa's modification of Darcy's law (Equation 8). Keeping the biopolymer cake height small and constant dramatically improves the dewatering of the biopolymer dispersion.

*Section III:* With the further proceeding of the press electrofiltration the slope of the plot increases again. This indicates that an increasing amount of biopolymer is

deposited on the cathode-side membrane. During the experiment the total biopolymer concentration in the filter chamber increases. These biopolymers are deposited mainly on the anode-side filter cake, causing the filter cake formed on the anode-side membrane to grow and come into contact with cathode-side filter cake. This results in a reduction of the filtrate flux through this membrane and marks the end of the positive effect of the electric field on the filtration kinetics. In this section a consolidation of the whole filter cake takes place.

### 2.3 Press Electrofiltration Versus Thermal Evaporation

Press electrofiltration comes along with consumption of electric energy. This electric energy consumption can be calculated according to Equation (9) by measuring the amperage  $I$ , the applied voltage  $U$ , and the filtration time  $t_f$ :

$$W_{el} = U \cdot I \cdot t_f \quad (9)$$

The specific energy consumption may be calculated with Equation (10) knowing the filtrate flux velocity  $v_f$ , the electric field strength  $E$ , the specific conductivity  $\kappa_c$  of the bio-dispersion, and the width of the filter plates  $d_{filter}$ .

$$\frac{W_{el}}{V_f} = \frac{U^2 \cdot t_f}{R_{el} \cdot V_f} = \underbrace{E^2 \cdot d_{filter}^2}_U \cdot \underbrace{\frac{\kappa_c \cdot A_{filter}}{d_{filter}}}_{1/R_{el}} \cdot \underbrace{\frac{V_f}{v_f \cdot A_{filter}}}_{t_f} \cdot \frac{1}{V_f} = \frac{E^2 \cdot d_{filter} \cdot \kappa_c}{v_f} \quad (10)$$

Since electric energy is necessary to maintain the electric field, press electrofiltration is a hybrid between a mechanical and a thermal dewatering process with respect to energy consumption. The energy consumption during press electrofiltration depends primarily on the electric conductivity of the dispersion. A high conductivity causes a high current to flow through the electrofilter, which leads to increasing electric energy consumption. Therefore, it is essential to optimize the electrofiltration process in such a way that the ionic strength of the dispersion is as low as possible. This can be achieved by optimizing the use of salts in the upstream production steps. Furthermore, an upstream desalination step might also be worthwhile in some cases. Practical experience has shown that the specific conductivity of a biopolymer dispersion should be below 8–10 mS/cm if press electrofiltration is to be sensible from an energy-related point of view.

Apart from the energy consumption, a further advantage of the press electrofiltration compared to a thermal evaporation is that the temperature during electrofiltration may be controlled by an unrestricted regulation of the quantity and temperature of the flushing solution. Other than the temperature increase, arguments often cited against press electrofiltration technology involved safety aspects. In this newly constructed electrofilter plate shown in Fig. 2, the electrolysis gas formed at the electrodes is removed by an electrode flushing. At the anode, oxygen can be formed and at the cathode, hydrogen. In order to prevent the formation of chlorine

gas it is recommended to use, for example, a  $\text{Na}_2\text{SO}_4$  solution as the flushing solution. In order to prevent a mixing of the cathodic and anodic electrolysis gases, the flushing solution can be degassed in a settler immediately after leaving the electrofilter and before going to the filtrate collecting tank. In such a settler it is further possible to dilute the electrolysis gases by an air flow. The quantity of hydrogen generated can be estimated by Faraday's law (Equation 11) and from the amperage  $I$  flowing through the electrofilter. Thus, it is possible to specify the air flow required for a safe dilution of the hydrogen gas.

$$\begin{aligned} \text{Cathode : } \frac{dN_{\text{H}_2}}{dt_f} &= \frac{I}{2 \cdot F} \\ \text{Anode : } \frac{dN_{\text{O}_2}}{dt_t} &= \frac{1}{4 \cdot F} \text{ or } \frac{DN_{\text{Cl}_2}}{dt_t} = \frac{1}{2 \cdot F} \end{aligned} \quad (11)$$

A more sophisticated method of handling the electrolytically formed hydrogen and oxygen gases would be a conversion of this chemical energy again into electric energy using a fuel cell. This would also offer the possibility to apply press electrofiltration for dispersion having a high specific conductivity.

Other electrolysis products formed at the anode and cathode can be  $\text{H}_3\text{O}^+$  and  $\text{OH}^-$ . By mixing the flushing solutions in the filtrate collecting tank as shown in Fig. 5, these ions neutralize each other, thereby preventing a pH shift during electrofiltration. The use of a buffer solution for the electrode flushing offers a further possibility of working at a defined pH.

*Example 1:* Press electrofiltration of the polysaccharide xanthan in a pilot-scale filter press

In the following, a pilot-scale concentration of the polysaccharide xanthan by press electrofiltration is discussed. An electrofilter press equipped with the electrofilter plates SYMBIOSE 250 of the company LENSER (Senden, Germany) is

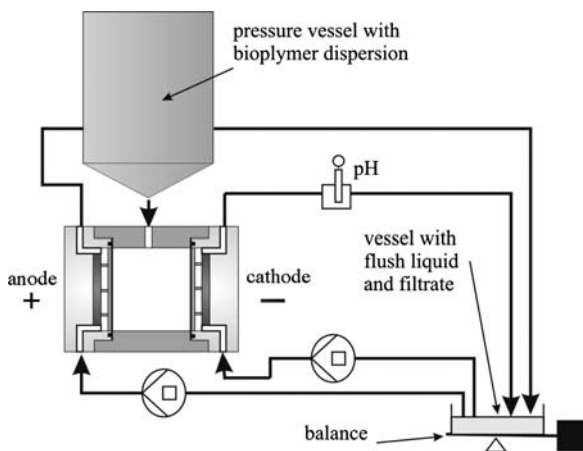


Fig. 5 Build up of a press electrofiltration plant in lab-scale

**Table 1** Technical data of the production-scale electrofilter plates SYMBIOSE 250 and SYMBIOSE 470 (Lenser GmbH, Senden, Germany)

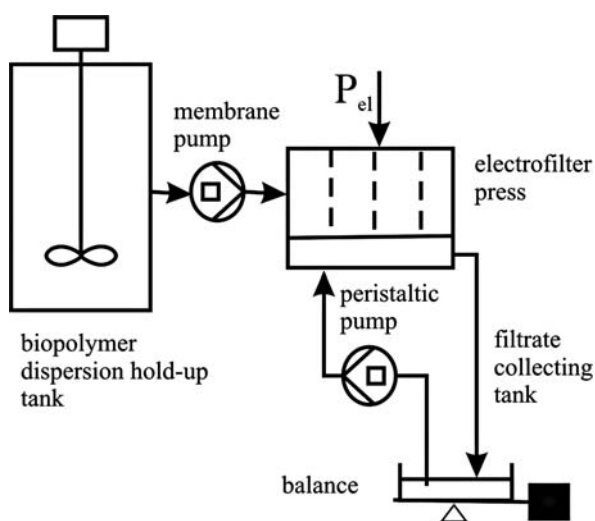
| Type         | Filter chamber volume [dm <sup>3</sup> ] | Filter medium  | Surface area [cm <sup>2</sup> ] |
|--------------|--|--|---------------------------------|
| Symbiose 250 | 0.337                                    | all kinds of MF- and UF-membranes<br>all kinds of filter cloth | 225                             |
| Symbiose 470 | 1.7                                      | all kinds of filter cloth                                      | 1174                            |

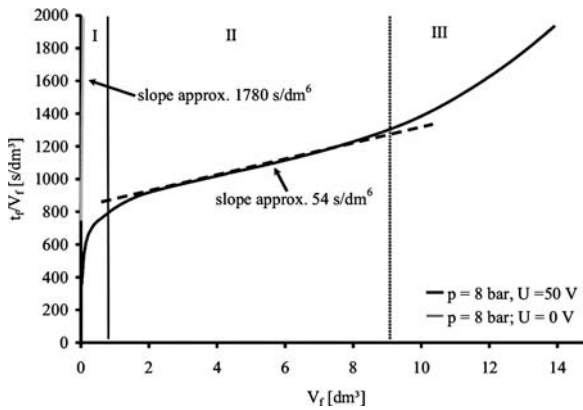
employed. Hitherto there are two different electrofilter plates available which can be used in conventional filter presses. The technical data of this filter plates are listed in Table 1.

The filter plate SYMBIOSE 250 can be equipped with micro- or ultrafiltration membranes. Thus, it is suitable for dewatering biocolloids like polysaccharide or enzyme dispersions. The larger electrofilter plate SYMBIOSE 470 can be used for the dewatering of plant homogenisates.

The setup of the electrofilter press with its periphery is shown in Fig. 6.

A detailed description of this work is given by (Hofmann et al. 2006). Figure 7 shows the comparison of  $t_f/V_f$  versus  $V_f$  plots of a pilot-scale press electrofiltration and a conventional press filtration of the polysaccharide xanthan. The xanthan concentration in the dispersion was 5 g/l. Xanthan is an extracellular microbial polysaccharide. Due to its ability to increase viscosity of liquids and liquid solutions, it is one of most important technical biopolymers. Its molecular weight is between 1 and 12 million Da (Lecourtier and Chauveteau 1984; Paradossi and Brant 1982; Steinbüchel 2003) and its main chain is predominatly composed of the

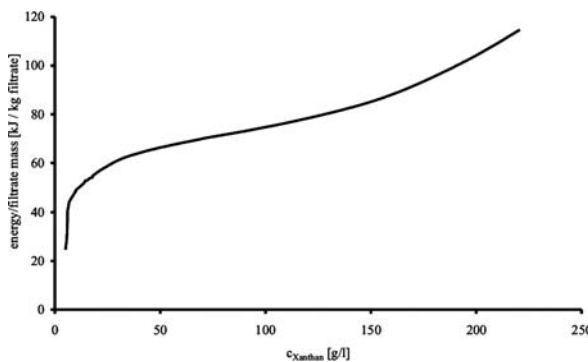
**Fig. 6** Pilot-scale electrofilter press with peripherals



**Fig. 7**  $t_f/V_f$  versus  $V_f$  plot of a press electrofiltration and a conventional press filtration of a xanthan dispersion in a pilot-scale (electro)filter press ( $U = 50 \text{ V}$ ,  $\Delta p = 8 \text{ bar}$ ,  $c_{\text{xanthan},0} = 5 \text{ g/l}$ )

sugar glucose. Every second glucose residue possesses a trisaccharide side chain. The carboxyl groups of the glucuronic acid and the pyruvate dissociate in aqueous solution and thus give the molecule a relatively high negative charge. This is an important factor for the applicability of press electrofiltration.

The applied voltage in the electrofiltration shown in Fig. 7 was 50 V. The pressure in the press electrofiltration and the conventional press filtration experiment was 8 bar. The most striking differences between both filtrations are the curve progressions of the  $t_f/V_f$  versus  $V_f$  plots. The conventional press filtration has a straight line with a large slope. The press electrofiltration is a curved line showing the three characteristic sections of a press electrofiltration. That electrofiltration shows the three characteristic sections indicates that the filtration kinetics of the electrofiltration is dominated by electrophoretic effects. The slope of the  $t_f/V_f$  versus  $V_f$  plot of the conventional press filtration is approximately 185 times greater than the slope of the press electrofiltration in Section II (see Fig. 7). This means that for conventional



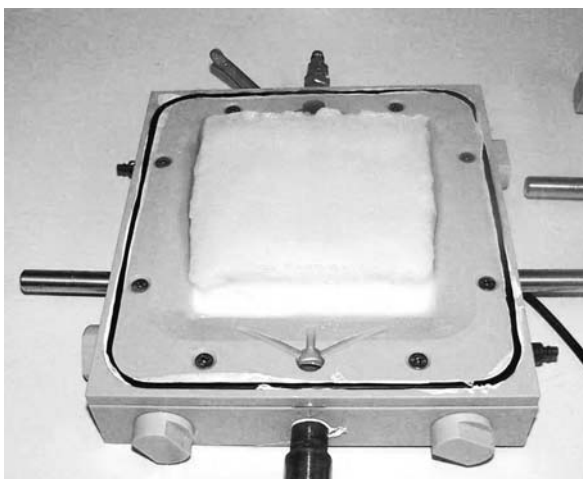
**Fig. 8** Specific energy consumption during the electrofiltration of a xanthan dispersion

press filtration, 185 times more time is required to attain the same quantity of filtrate, compared to press electrofiltration. The complete curve for conventional press filtration reaches filtrate volume  $V_f$  of 1.6 l at a  $t_f/V_f$  value of approximately 18,000 s/dm<sup>3</sup>, is not plotted here as the electrofiltration plot would no longer be visible. Figure 8 shows the specific energy consumption during dewatering the xanthan dispersion from 5 g/l up to 220 g/l. For concentrating it up to 220 g/l the specific energy consumption was 114 kJ/kg filtrate. Regarding the evaporation energy of water, which is 2250 kJ/kg, electrofiltration exhibits a much higher energy efficiency than the thermal dewatering process.

Figure 9 shows a picture of the press electrofilter plate SYMBIOSE 250 (or better one half of the filter chamber) before the electrofiltration. Figure 10 shows



**Fig. 9** Filter chamber of the electrofilter plate SYMBIOSE250



**Fig. 10** Xanthan filter cake after press electrofiltration ( $c_{\text{Xanthan}} = 220$  g/l)

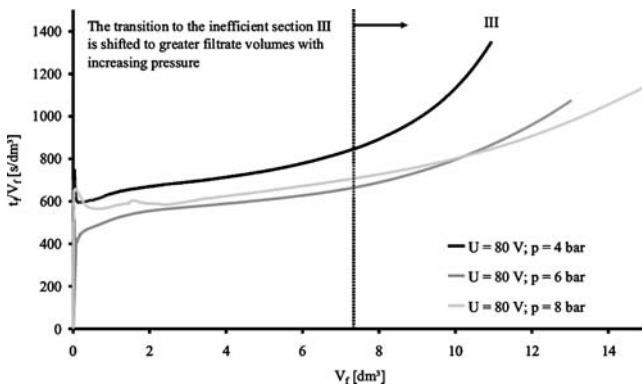


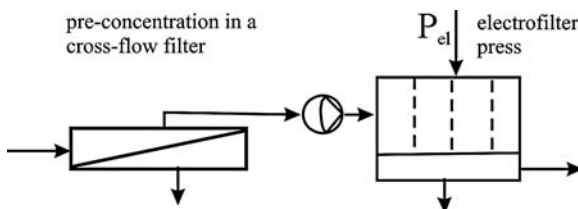
Fig. 11  $t_f/V_f$  versus  $V_f$  plot of press electrofiltrations at different pressures

a picture of the xanthan filter cake after press electrofiltration. The final xanthan concentration in this filter cake is approximately 220 g/l.

Biomaterials often form highly compressible filter cakes. Consequently the applied pressure has an effect on the course of the filtration plot (see Fig. 11.). By increasing the pressure, the beginning of the ineffective Section III is shifted towards a greater filtrate volume. This means that a greater biopolymer concentration will develop within the filter chamber. Because of the compressibility of xanthan filter cakes, the anode-side filter cake becomes more compressed with increasing pressure. Thus, a bigger overall xanthan concentration in the filter chamber is necessary until the anode-side filter cake comes into contact with the cathode-side membrane (the working membrane). This gives the operator of an electrofilter the chance to optimize its energy efficiency of its electrofilter by increasing the pressure.

## 2.4 Press Electrofiltration Versus Cross-Flow Filtration

State of the art for the dewatering of biopolymer dispersions and biosuspensions, which are difficult to filtrate, is hitherto the cross-flow-filtration. In cross-flow filtration, although the shear force of the recirculating dispersion minimizes surface layer deposition on the filtration membrane, this method of deposition control is not as effective as deposition control of press electrofiltration. This can be explained by the fact that the electric force field is in its effect much more specific than the shear force field of the cross flow filtration. The electric field acts directly on individual bioparticles rather than the shear forces that act only on the bulk solution. The electric forces in electrofiltration depend mainly on the bioparticle surface charge and the concentration gradient within the liquid (rather than on the distance from the walls). This makes it more effective for deposition control. In cross-flow filtration the shear force close to the wall approaches zero. However, this is where deposition takes place.



**Fig. 12** Combination of an electrofilter press with a cross-flow filter device for a cost-saving biopolymer dewatering up to high concentrations

But the comparison of cross-flow filtration and dead-end-electrofiltration plant must be extended to more than just the filtrate fluxes. It is undeniable that the electrofiltration device is more expensive than the cross-flow device because of the electrical system required. However, the unique selling point of press electrofiltration compared to cross-flow filtration is the high final biopolymer concentrations that can be reached. These concentrations are much higher than in the dynamic filtration process such as cross-flow filtration as biopolymers strongly increase the viscosity of dispersion even at low concentrations. As shown in Fig. 12, it can be advantageous to pre-concentrate a dispersion first, using cross-flow filtration or even centrifugation, and then dewater the pre-concentrated dispersion in a smaller-dimensioned press electrofilter to the desired final concentration.

### 3 Fractionation

In addition to dewatering and concentration of biopolymers, the electrofiltration approach can also be applied for the separation of mixtures containing several components. Producing a certain substance with a biotechnological approach often leads to suspensions consisting of a multitude of components, such as cell debris, polysaccharides, proteins, DNA, and small organic compounds. If only one substance is the desired product, a multitude of separation unit operations have to be strung together in order to achieve the purity needed. All operations are linked to a certain product loss and of course to investment and operating costs. Thus, there is a big demand for more effective processes that can combine more than one separation criterion, so called hybrid processes, such as the previously discussed electrofiltration.

When considering fractionation processes in biotechnology, one has to look at the separation methods that are possible. Fractionation is performed by precipitation, chromatography, or filtration. But commonly used technologies have drawbacks, such as toxic precipitation agents, high costs (chromatography), or unsatisfactory selectivities (filtration), especially for mixtures of similar-sized components such as protein mixtures.

Filtration is, on the other hand, advantageous because of low costs, high scalability, and good performance. There have been several studies that have attempted to increase filtration selectivity by using charged membranes, electrostatic interactions,



or gas sparging (Bellara et al. 1997; Ghosh and Cui 1998; Ghosh et al. 1998; Mehta and Zydney 2006; Vaneijndhoven et al. 1995).

Electrofiltration takes advantage of the fact that biopolymers are often charged because of acidic and basic side groups, such as carboxyl or amino groups. According to pH and ionic strength, the zeta potential can be set and chosen in a way that only one substance or one group of molecules is charged in a distinctive way. Of course, the variation is limited by interaction effects between the molecules, as they might coagulate if they are oppositely charged.

The interactions between two species can be characterized by the approach of Derjaguin-Landau-Verwey-Overbeek (DLVO) both for particle systems and for biopolymers such as proteins. The pair potential of mean force can be calculated by an addition of three potentials:

$$W_{22}(a) = W_{hs}(a) + W_{elec}(a) + W_{disp}(a) \quad (12)$$

$W_{hs}$  is the hard-sphere potential,  $W_{elec}$  the potential of electric force, and  $W_{disp}$  the potential of dispersion. The most important for electrofiltration are the electric forces that are highly depending on pH and ionic strength:

$$W_{Elec}(a) = \frac{Z^2 e^2 a^{-1} \exp[-\kappa(a-r)]}{4\pi \epsilon_0 \epsilon_r (1 + \kappa r/2)^2} \quad (13)$$

The pH value changes the charge  $z$ , and the ionic strength of the solution determines the Debye-Hueckel parameter  $\kappa$ .

These interactions have to be considered, when pH and ionic strength settings are optimized in order to maximize the electric force (see Equation 3).

### ***3.1 Fractionation of Bacteria and Extracellular Enzyme Product***

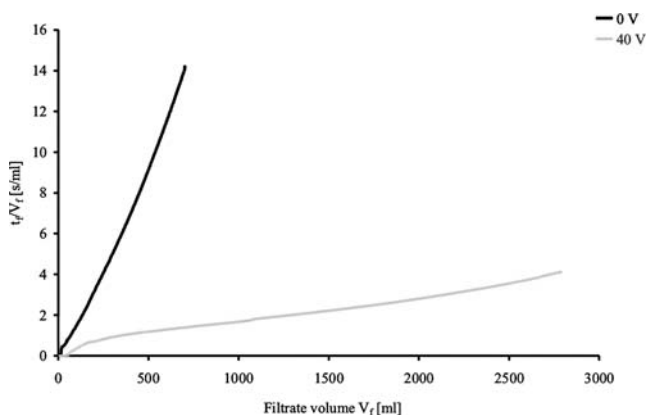
In whole-cell biotechnology, the first separation step is the removal of the solid, that is, the microorganisms that are whole cells or cell debris, depending on the product location intra- or extracellular. Centrifugation and filtration processes are used for this purpose. In common dead-end filtration processes, the filtration rate is not sufficient because of the high specific cake resistance of cell mass. Cross-flow techniques can be used to overcome this limitation. But there the drawback that the retentate suspension has to remain pumpable, and can therefore not be concentrated to a high end concentration remains. Viscosity increases extremely with cell concentration.

Using electrofiltration is an alternative that combines the advantages of high filter performance and as a dead-end-process, high end concentration. This end concentration also lowers the amount of wastewater that is needed in cross-flow approaches where the product can be won by diluting the retentate.

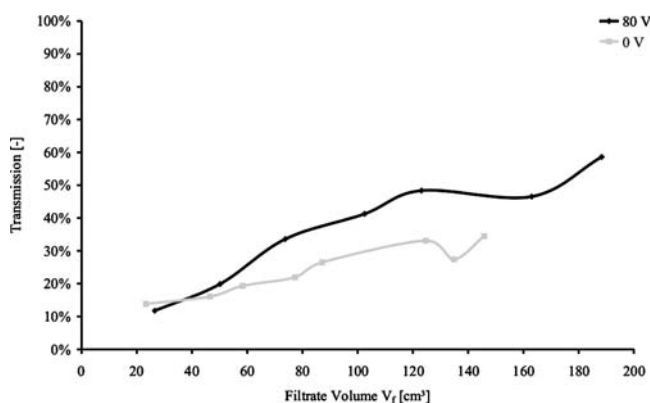
A cultivation of *Bacillus licheniformis* (German Collection of Microorganisms and Cell Cultures DSMZ 1969) was filtrated after the bioproduction as a fractionation example. *Bacillus licheniformis* is a gram-positive bacterium that is used to produce extracellular enzymes such as serine-alkaline-proteases and  $\alpha$ -amylases (Takac et al. 2000). The separation was performed with and without an electric field to investigate the impact of the electrokinetic effects for this filtration (Käppler et al. 2006). *Bacillus licheniformis* was cultivated in a synthetic medium and was filtered when its bio dry mass concentration was approximately 6 g/l. Figure 13 shows the filtration kinetics of the filtrations in the form  $t_f/V_f$  versus  $V_f$ , where the slope indicates filtration resistance, meaning that small slope is equivalent to a small filtration resistance. It can be seen that an electric field can greatly accelerate the filtration. With the field on, 700 ml of filtrate could be won in a tenth of the time needed without the electric field. The reason for this behavior is that the microorganisms have a zeta potential of approximately  $-20$  to  $-30$  mV. Therefore, their migration to the anode-side membrane is accelerated and their migration to the cathode side is decelerated. At a certain point of time during the filtration, the electric force prevails over the hydrodynamic resistance force (see Equations 1 and 3) and the all microorganisms migrate to the anode side. Therefore, only a small filter cake resistance can be detected on the cathode side. Measurement of the mass of the filter cake showed that 5–7 times more mass was found on the anode side. In addition to this electrophoretic effect, there is also electroosmosis, which enhances the filtration speed.

Filtration acceleration can be used to shorten the whole separation process or to achieve higher concentrations of the retentate. This higher end concentration leads to a smaller product loss during this filtration step.

In addition to the acceleration the filter cake manipulation, the two-sided electro-filtration approach can be used to increase the yield of extracellular enzyme present in the suspension liquid. Figure 14 shows that the transmission of enzyme could be



**Fig. 13**  $t_f/V_f$  versus  $V_f$  plot of a filtration of *Bacillus licheniformis* with and without electric field



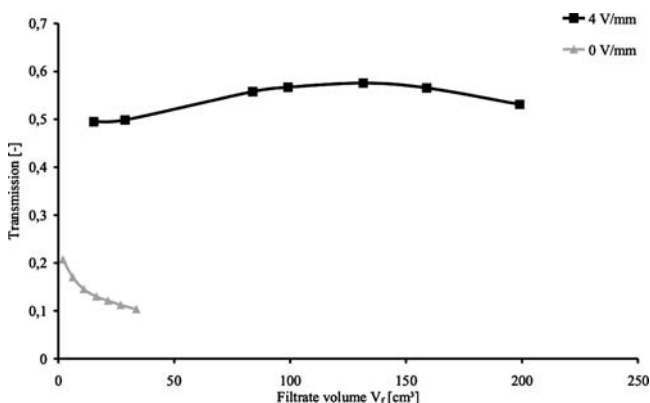
**Fig. 14** Transmission of extracellular enzymes during the filtration of *Bacillus licheniformis* with and without electric field

enlarged. The reason for that was a reduced filter cake layer that could be passed easier. It was measured that filter cake layer on the anode side was 5–7 times smaller than on the cathode side. The effect, however, is only an increase of approximately 50%, which is less than expected. One reason is the mentioned interactions between enzymes and microorganisms. They are oppositely charged and therefore not freely dissolved in the liquid. They might be attached to a certain degree to the microorganisms and, there, do not reach the filtrate as the electric force is not strong enough to disrupt that connection.

But, on the whole, the increase of filtration velocity and of product yield makes electrofiltration an interesting option for primary separation after fermentation.

### 3.2 Fractionation of Highly Viscous Polysaccharide and Protein

After primary separation, the fermentation broth still contains a multitude of different substances. As a model system a mixture of xanthan and BSA protein was chosen exemplary in order to simulate the separation of a valuable protein out of a liquid which contains rests of complex substrate. This could be waste from food or agricultural industries. Xanthan is highly viscosifying. The fractionation of the two systems could be greatly improved with respect to filtrate velocity as the main filtration resistance is brought by xanthan, and therefore the effects described in Section 2 of this chapter are also valid for the fractionation process. More important is the yield of (BSA), which was collected in the filtrate. A membrane was chosen that could easily be passed through by Bovine serum albumin (BSA), and which completely retained xanthan (pore size was 0.1  $\mu\text{m}$ ). Figure 15 shows the transmission values for BSA in experiments with and without the application of an electric field. Without an electric field only small amounts (below 20%) could be won; with longer duration of the experiment, this value decreased because of the filter cake



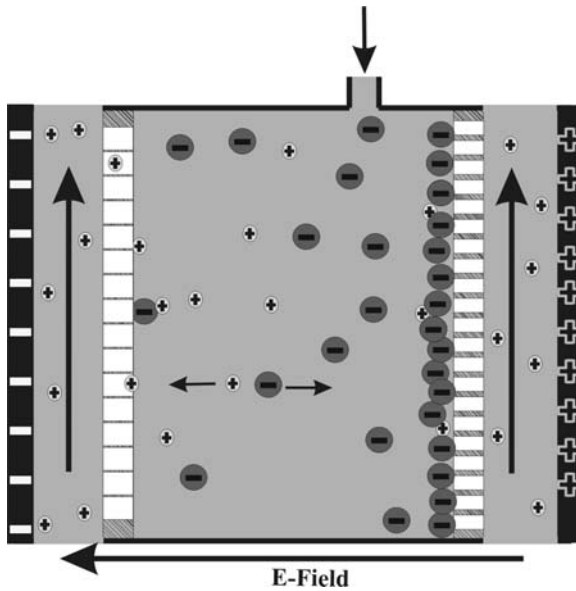
**Fig. 15** Transmission of BSA during the filtration of a xanthan–BSA mixture with and without electric field

buildup, which prevented BSA from reaching the filtrate as it was effective as a secondary membrane. With an electric field 50% could be won from the beginning, and moreover, this value could be kept constant as the filter cake layer on the anodic side remains constant after a certain point of time.

### 3.3 Fractionation of Proteins

Bioactive peptides have been separated from alpha(s2)-casein hydrolysates (Bargeman et al. 2002a,b,c). An ultrafiltration membrane for the separation of the peptides by electro-ultrafiltration and ion-exchange membranes to separate the electrode from the feed and filtrate stream was used.

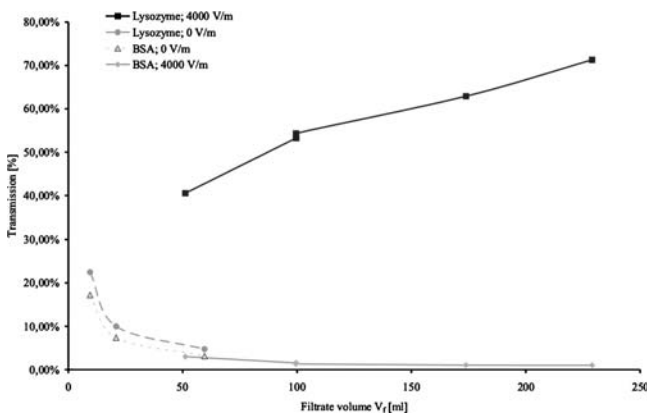
Another approach refrains from using ion-exchange membranes: The filter chamber shown in Fig. 2 can be equipped with two ultrafiltration membranes that are unequal in their molecular weight cutoff (MWCO). Molecules of similar size can be separated by using a pH value that lies between the pI of the two proteins. Then, they are unequally charged. The one that is negatively charged will predominantly migrate to the anode side, while the other that is then positively charged will move to the cathode side. Choosing membranes that definitely retain one molecule on their electrophoretically preferred side and the other membrane that allows the protein to pass through offers the chance of reaching high selectivity of the ultrafiltration procedure. Figure 16 shows the schematic of the exemplary separation of BSA (69 kDa, pI = 4.7–4.9) and lysozyme (14 kDa, pI = 11), which are unequal in both charge and size. The BSA migrates to the anode side and is collected there at the 10 kDa membrane. Lysozyme can pass the other side where a 50 or 100 kDa membrane was used. Using larger pore sizes on the cathode side would enhance the flux, and therefore the equilibrium between electric force and hydrodynamic force would not be maintained. Trials with a 0.1  $\mu\text{m}$  membrane showed that the pressure



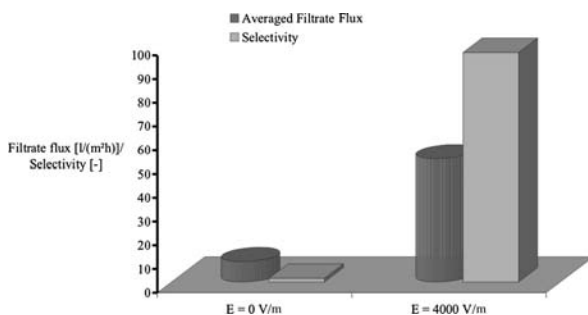
**Fig. 16** Outline of the processes taking place within the filter chamber during two-sided electrofiltration (Käppler and Posten 2007)

applied has to be regulated even to a very small value in order to keep the flow velocity small.

The results obtained by trials are displayed in Figs. 17 and 18. Figure 17 shows the transmission values of BSA and lysozyme in the experiment with and without electric field. We can see that without an electric field the transmission of both proteins decreases with time. On both sides of the filter chamber the BSA



**Fig. 17** Transmission of BSA and lysozyme in experiments with a two-sided dead-end filtration apparatus with and without electric field

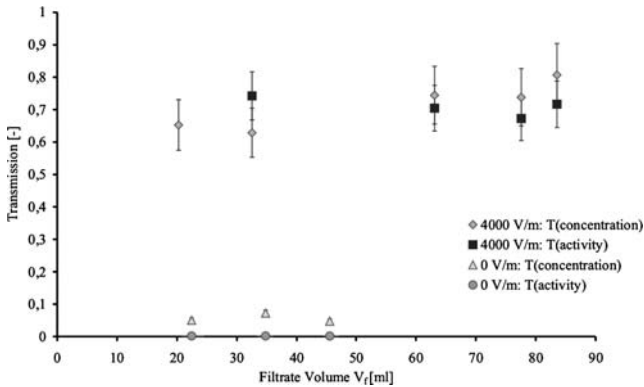


**Fig. 18** Comparison of filtrate flux and selectivity of filtrations with and without an electric field

molecules, which are bigger than the lysozyme molecules, are partially retained by the membranes and build a layer on the membrane which decreases both the filtrate flux and the transmission of lysozyme. At the beginning, some BSA molecules could transmit through the 50 kDa membrane, but later, the blockage of the filter cake layer hinders the following BSA proteins of entering the filtrate. If the electric field is applied, the situation is different. From the beginning of the filtration the BSA molecules migrate predominantly to the anode side, where they are retained by the membrane. Therefore, the amount of BSA molecules reaching the cathode side is quite small and no resistance cake can be formed. Lysozyme molecules can migrate to and through the cathode-side membrane as they are positively charged. With the duration of the filtration the BSA transmission even decreases. At the beginning the flux is quite high, and thus the electric force cannot completely dominate the migration of BSA. Later the flux decreases and the electric force is stronger than the hydrodynamic resistance. BSA molecules entering the filter chamber will then only migrate to the anode side.

The transmission values of lysozyme could be largely increased in comparison to the case when no electric field is applied. Therefore, the high transmission of lysozyme and the increased retention of BSA lead to high selectivities of more than 100 in this case, and also more than 800 as reported (Käppler and Posten 2007). Figure 18 illustrates the effects of the electric field in this application with respect to selectivity and filtrate flux. The filtrate flux is also largely enhanced as the BSA layer on the anode side does not exist in the electrofiltration case, which makes it possible for the liquid to enter the filtrate at a higher rate.

As is shown in Fig. 16, the lysozyme molecules, which pass the membrane, have direct contact with the electrodes. As the electric field strength present is high enough to disrupt water molecules, it is possible that proteins may be damaged. However, the volume fraction of high electrical field in the whole flashing chamber is very small. Works with xanthan polysaccharide have shown that there was no change of the chemical structure of the polysaccharide in an electrofiltration application (Hofmann and Posten 2002). In the case of protein fractionation, an analytical test was used that compares the measured concentration with the activity of the enzyme. If there is damage to the active site of the enzyme due to the electric



**Fig. 19** Effect of the electric field on the activity of an enzyme (lysozyme) during the filtration procedure

field this should be seen when comparing concentration and activity values, at least if the damage is excessive. As it can be seen in Fig. 19, the transmission values measured by concentration do not differ greatly from the measurements with the specific activity test. That means that there is not great destruction of enzymatic activity for lysozyme. As these measurements have certain deviations, it can not be completely excluded that some lysozyme molecules were destroyed or damaged. This, however, is only interesting for the production of imperative highly purified pharmaceutical substances.

### 3.4 Outlook for the Fractionation with Electrofiltration

Fractionations have certain limits when using an electroultrafiltration approach. The charge of the molecules that are to be separated has to be different. So each process in which the charge of certain molecule groups differs from others can be an area where electrofiltration could be used. For example, DNA has a negative charge. This might also be a field of application if DNA has to be separated from other molecules that are uncharged or positively charged.

In the future, the development of a continuously running device in which the flow in the filter chamber remains small enough to be in a dead-end-like procedure is plausible. Additionally, the interaction between membrane and molecules can be used for a better fractionation process. Then, the extremely high selectivity might still be increased.

Protein mixtures that consist of equal-sized molecules can also be separated by the two-sided electrofiltration approach. When both size and charge are equal, electrofiltration is limited. The parameter settings, such as pH or ionic strength, could be changed in order to shift the charge values. But there are limits. Ionic strength cannot be lowered easily and dialysis steps or diafiltration is cost-intensive and has to be challenged economically.

But there are many cases where electrofiltration can be used as a fractionation tool to increase purity, yield, and kinetics of downstream processing.

## 4 General Guidelines

As concluding remarks about the operation of a press electrofiltration, several rules of thumb are summarized here that are based on the practical experience of the authors with this technology:

1. The press electrofiltration of biomaterials forming a compressible filter cake should be performed at a filtration pressure chosen as high as possible. The greater the applied electric field strength, the more a pressure increase improves the energy efficiency of the press electrofiltration.
2. An increase in the electric field strength normally causes an increase of the filtrate flux. However, the specific energy consumption ( $W_{el}/V_f$ ) increases with an increased electric field strength. Theoretically the filtrate flux velocity should increase proportional to the electric field strength, and the specific energy consumption should increase proportional to the applied electric field strength. Electrofiltration experiments with the polysaccharide xanthan showed this behavior.
3. Microfiltration membranes are, with respect to their greater mechanical stability and greater porosity, better suited for electrofiltration than ultrafiltration membranes. The more porous and the thinner the filter medium is, the smaller the voltage drop over the membrane and the greater the electric field strength within the filter chamber.
4. Electrodes should be flushed by a sulfate or phosphate solution. Chlorides containing salt solutions are not suited since chlorine is formed at the electrodes.
5. The specific conductance of the biopolymer dispersion should be as small as possible but remaining at least smaller than 8–10 mS/cm. An upstream desalination step or an integrated process development with a focus on a reduction of the salt concentration in the biopolymer dispersion can significantly reduce the process costs of an electrofiltration.
6. An active cooling of the electrode flushing reduces the conductivity of the biopolymer dispersion in the filter chamber and the flush liquid. The smaller the conductivity, the greater the electric field strength can be and the faster the electrofiltration. For electrofiltration it is not worthwhile to increase the temperature with the goal of decreasing the viscosity of the filtrate. According to Darcy's law (Equation 4) a decrease in viscosity would increase the filtrate flux. However, the most beneficial effect if one wants to dewater biomaterials is a reduction of the filter cake height.
7. For the fractionation of biological components, it is important to have a distinction of these components in their charge. This can be achieved by changing the pH or ionic strength in the suspension. Highly charged components that are



oppositely charged can form aggregates. Thus, interactions of the components are crucial in an electrofiltration fractionation

8. Enzyme degradation has to be considered when dealing with sensitive molecules. No degradation of enzymes was observed in the investigations. But when dealing with substances where small amounts of damaged proteins have to be definitely excluded, like pharma proteins, additional membranes that separate filtrate chambers and electrodes should be installed.

## 5 Nomenclature

---

|                           |   |
|---------------------------|---|
| $a$                       | Particle radius [m]                     |
| $A$                       | Surface [m <sup>2</sup> ]               |
| $A_{\text{filter}}$       | Filter membrane area [m <sup>2</sup> ]  |
| $c$                       | Concentration [kg/m <sup>3</sup> ]      |
| $d_{\text{filterFilter}}$ | plate distance [m]                      |
| $E_{\text{filterFilter}}$ | Electric field [V/m]                    |
| $e$                       | Elementary charge [C]                   |
| $E_{\text{crit}}$         | Critical electric field [V/m]           |
| $F$                       | Faraday constant [C/mol]                |
| $F_{\text{el}}$           | Electrical force [N]                    |
| $F_{\text{R}}$            | Hydrodynamic resistance force [N]       |
| $h_{\text{cake}}$         | Height of filter cake [m]               |
| $I$                       | Electric current [A]                    |
| $m_{\text{cake,dry}}$     | Mass of filter cake [kg]                |
| $N_{\text{H}_2}$          | Amount of hydrogen [mol]                |
| $N_{\text{O}_2}$          | Amount of oxygen [mol]                  |
| $p$                       | Pressure [Pa]                           |
| $p_e$                     | Electroosmotic pressure [Pa]            |
| $P_{\text{el}}$           | Electric power [W]                      |
| $p_h$                     | Hydrodynamic pressure [Pa]              |
| $r$                       | Particle distance [m]                   |
| $r$                       | Particle distance [m]                   |
| $R_{\text{el}}$           | Electric resistance [Ohm]               |
| $r_h$                     | Hydrodynamic radius [m]                 |
| $t$                       | Time [s]                                |
| $t_f$                     | Filtration time [h]                     |
| $U$                       | Voltage [V]                             |
| $V_{\text{cake,net}}$     | Volume of filter cake [m <sup>3</sup> ] |
| $v_f$                     | Filtrate velocity [m/s]                 |
| $V_f$                     | Filtrate volume [m <sup>3</sup> ]       |
| $W_{22}$                  | Interaction potential [J]               |
| $W_{\text{disp}}$         | Dispersion potential [J]                |
| $W_{\text{el}}$           | Electric energy [J]                     |
| $W_{\text{elec}}$         | Electrostatic potential [J]             |
| $W_{\text{hs}}$           | Hard sphere potential [J]               |
| $z$                       | Valence [-]                             |

---

## Greek letters:

|                 |  |
|-----------------|--|
| $\alpha_{av}$   | Specific filter cake resistance [m/kg] |
| $\varepsilon$   | Permittivity constant [-]              |
| $\varepsilon_0$ | Permittivity of vacuum [As/(Vm)]       |
| $\eta_f$        | Viscosity of fluid [Pa s]              |
| $\kappa_c$      | Conductivity [S/m]                     |
| $\kappa$        | Debye-Hueckel-parameter [1/m]          |
| $\zeta$         | Zeta potential [mV]                    |

## References

- Bargeman G, Houwing J, Recio I, Koops GH, van der Horst C. (2002a) Electro-membrane filtration for the selective isolation of bioactive peptides from an alpha(s2)-casein hydrolysate. *Biotechnology and Bioengineering* 80, 599–609.
- Bargeman G, Koops GH, Houwing J, Breebaart I, van der Horst C, Wesselingh JA. (2002b) The Development of Electro-Membrane Filtration for the Isolation of Valuable Charged Components. *Chemie Ingenieur Technik* 74, 639–640.
- Bargeman G, Koops GH, Houwing J, Breebaart I, van der Horst HC, Wessling M. (2002c) The development of electro-membrane filtration for the isolation of bioactive peptides: the effect of membrane selection and operating parameters on the transport rate. *Desalination* 149, 369–374.
- Bellara SR, Cui ZF, Pepper DS. (1997) Fractionation of BSA and lysozyme using gas-sparged ultrafiltration in hollow fiber membrane modules. *Biotechnology Progress* 13, 869–872.
- Ghosh R. (2003) *Protein Bioseparation using ultrafiltration: Theory, Application and New Developments*. Imperial College Press, London.
- Ghosh R, Cui ZF. (1998) Fractionation of BSA and lysozyme using ultrafiltration: effect of pH and membrane pretreatment. *Journal of Membrane Science* 139, 17–28.
- Ghosh R, Li QY, Cui ZF. (1998) Fractionation of BSA and lysozyme using ultrafiltration: Effect of gas sparging. *Aiche Journal* 44, 61–67.
- Hofmann R. (2005) *Prozesstechnische Entwicklung der Presselektrofiltration als innovatives Verfahren zur Abtrennung von Biopolymeren*. VDI-Verlage, Düsseldorf.
- Hofmann R, Kaeppler T, Posten C. (2006) Pilot-scale press electrofiltration of biopolymers. *Separation Purification Technology* 51, 303–309.
- Hofmann R, Posten, C. (2002) Biopolymer Recovery with Pressure Electrofiltration and Determination of the Biopolymer Quality by MAS-NMR and FT-IR Techniques. *Engineering in Life Sciences* 2, 304–311.
- Hofmann R, Posten C. (2003) Improvement of dead-end filtration of biopolymers with pressure electrofiltration. *Chemical Engineering Science* 58, 3847–3858.
- Iritani E, Ohashi K, Murase T. (1992) Analysis of Filtration Mechanism of Dead-End Electroultrafiltration for Proteinaceous Solutions. *Journal of Chemical Engineering of Japan* 25, 383–388.
- Käppler T, Hofmann R, Posten C. (2006) Elektrofiltration – Einsatzgebiet Enzymproduktion. *Chemie Ingenieur Technik* 78, 261–266.
- Käppler T, Posten C. (2007) Fractionation of proteins with two-sided electro-ultrafiltration. *Journal of Biotechnology* 128, 895–907.
- Kaufmann M. (1997) Unstable proteins: how to subject them to chromatographic separations for purification procedures. *Journal of Chromatography B* 699, 347–369.
- Lecourtier J, Chauveteau G. (1984) Xanthan Fractionation by Surface Exclusion Chromatography. *Macromolecules* 17, 1340–1343.
- Mehta A, Zydny AL. (2006) Effect of membrane charge on flow and protein transport during ultrafiltration. *Biotechnology Progress* 22, 484–492.
- Paradossi G, Brant DA. (1982) Light-Scattering Study of a Series of Xanthan Fractions in Aqueous-Solution. *Macromolecules* 15, 874–879.

- Rumpf H, Gupte AR. (1971) Einflüsse der Porosität und Korngrößenverteilung im Widerstandgesetz der Porenströmung. *Chemie Ingenieur Technik* 43, 367–375.
- Schwuger MJ. (1996) *Lehrbuch der Grenzflächenchemie*. Thieme, Stuttgart.
- Steinbüchel A. (2003) *Biopolymers*. Wiley-VCH Verlag, Weinheim.
- Takac S, Elmas S, Calik P, Ozdamar TH. (2000) Separation of the protease enzymes of *Bacillus licheniformis* from the fermentation medium by crossflow ultrafiltration. *Journal of Chemical Technology and Biotechnology* 75, 491–499.
- Vaneijndhoven RHCM, Saksena S, Zydney AL. (1995) Protein Fractionation Using Electrostatic Interactions in Membrane Filtration. *Biotechnology and Bioengineering* 48, 406–414.
- Wakeman R. (1986) Electrofiltration – Microfiltration Plus Electrophoresis. *Chemical Engineering London* 426, 65.
- Wakeman RJ. (1998) Electrically enhanced microfiltration of albumin suspensions. *Food and Bioproducts Processing* 76, 53–59.
- Yukawa H, Kobayashi K, Tsukui Y, Yamano S, Iwata M. (1976) Analysis of Batch Electrokinetic Filtration. *Journal of chemical Engineering of Japan* 9, 396–401.

# Food Industry Applications for Pulsed Electric Fields

Henry Jaeger, Ana Balasa, and Dietrich Knorr

**Abstract** In this chapter the potential of pulsed electric fields (PEF) to enhance or create alternatives to conventional methods in food processing will be summarized. After a brief introduction of the historical background, some applications for gentle food preservation will be presented. The enhancement of mass transfer processes like extraction or drying by PEF-pretreatment will be pointed out by showing examples ranging from fruit juice and plant oil recovery to the disintegration of animal tissue. The use of PEF for the softening of plant tissue, for the induction of stress reactions, as well as for wastewater treatment will be illustrated. The discussion of energy requirements and cost-effectiveness will complete the chapter.

## 1 Introduction

The possible application of this nonthermal technology in a wide range of the food industry is based on its effect on biological cells—electroporation.

When exposed to high electric field pulses, cell membranes develop pores that may be permanent or temporary, depending on the intensity and treatment conditions. Pore formation increases membrane permeability, which results in the loss of cell content or intrusion of surrounding media.

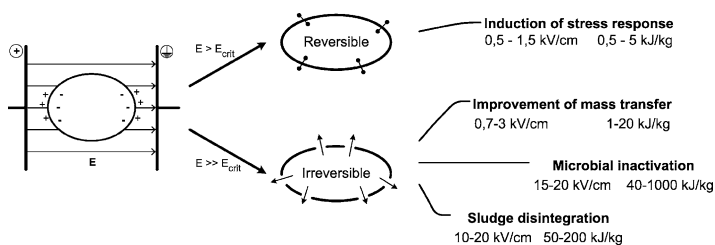
Low treatment intensity allows a reversible disturbance of the phospholipids bilayer, which is routinely used as tool in molecular biology to introduce polar molecules like DNA into a host cell through the cell membrane. The quick voltage shock disrupts areas of the membrane temporarily, but then the membrane may reseal quickly and leave the cell intact. Recent investigations showed the potential of this low-intensity treatment to induce stress reactions in plant cells resulting in the promotion of a defense mechanism by increased production of secondary metabolites.

---

H. Jaeger

Department of Food Biotechnology and Food Process Engineering, Berlin University of Technology

e-mail: henry.jaeger@tu-berlin.de



**Fig. 1** Food applications of biological tissue exposure to pulsed electric fields with required electric field strength and energy input. Increasing treatment intensity will lead to formation of large, irreversible membrane pores resulting in permanent electroporation of cells ( $E$ , electrical field strength;  $E_{crit}$ , minimal field strength necessary for pore formation)

An irreversible perforation of the cell membrane reduces its barrier effect permanently and causes cell death. Applied to fruit and vegetable cells, mass transfer processes like pressing, extraction, or drying are more effective; in the case of meat brining and pickling, mass transport and microdiffusion could be enhanced. The loss of cell vitality caused by electroporation is, furthermore, a capable tool for the inactivation of microorganisms used for a nonthermal pasteurization of liquid food.

The mentioned applications with their typical electric field strength and energy requirements are outlined in Fig. 1. The most important process variables include electric field strength and distribution in the treatment chamber, energy input, and treatment temperature. From a processing point of view the energy input required to achieve a certain microbial inactivation or cell disintegration seems to be appropriate to be used as a treatment intensity parameter as it can indicate costs of operation.

However, neither treatment time (product of pulse width and number of pulses) nor specific energy input is adequate to describe processing parameters sufficiently as no information is given about the energy delivered per pulse or the number of pulses per volume element.

Designs for industrial food processing are emerging nowadays. The challenges for industrial implementation are as follows:

- Availability of impulse generation systems in industrial scale.
- Minimization of the consumption of electrical energy by optimized process conditions.
- Evaluation of process efficiency for the different application possibilities
- Customer acceptance as a possible health hazard of this new process by affecting food constituents in a negative way is not exhaustively investigated as it is in the case for most traditional operations within food technology.

Within this chapter, potential applications of pulsed electric fields in the food industry will be shown. Apart from preservation, the disintegration of biological tissue and the induction of stress reactions in plant cells will be discussed in detail. The historical background of the technology as well as the most present considerations about cost estimation and technical feasibility will frame the work.

## 2 Historical Approach

The application of electrical currents for microbial inactivation has been investigated as early as the time when electricity was commercially available. At the end of the nineteenth century bactericidal effects by the use of direct and alternating current were under investigation of Prochownick and Spaeth (1890) and Thiele and Wolf (1899). Although an inactivation of *Staphylococcus aureus* in suspension was not found after application of direct current of 300 mA, differences of media acidity at different points of the treatment chamber were observed.

One of the first attempts to use electricity for milk pasteurization was in the 1920s with a process called “electropure” by the application of a 220 V alternating current within a carbon electrode treatment chamber (Beattie and Lewis 1925; Fetterman 1928; Moses 1938). The method was based on thermal treatment using direct heating of milk by a current flowing through, and it was believed that the bactericidal action was due to the generated heat. Some researchers have reported a microbial inactivation below thermal death points, assumed to be caused by the formation of toxic compounds (Tracy 1932). The process was accepted as safe pasteurization method in six states in the United States. Around 50 units were in operation until the 1950s mainly provided by Trumbell Electric Manufacturing Co. and served about 50,000 consumers (Edebo and Selin 1968; Getchell 1935). Rising energy costs and competition with novel thermal preservation technologies like UHT finally lead to the discontinuation of this application (Toepfl et al. 2007b).

Unlike the “electropure” process, based on Joule heating, which involves the passage of an electrical current resulting in the generation of heat by the resistivity of the food material, a technology using high-voltage electricity up to 32 kV for a pulsed discharge application across two electrodes was investigated since the 1950s and resulted in a process called electrohydraulic treatment (Gilliland and Speck 1967a). The electrodes were submerged below the surface of an aqueous suspension containing microorganisms within a pressure vessel. Electric arcs resulting in the formation of transient pressure shock waves, ultraviolet light pulses, electrochemical reactions, and highly reactive radicals were claimed to be responsible for the bactericidal effect (Gilliland and Speck 1967b).

The electrohydraulic treatment was regarded as a quick, effective, and inexpensive nonthermal method for the sterilization of water and sewage without the need for raising temperature or adding chemicals (Allen and Soike 1967). Although promising results were obtained in these early studies, except for wastewater treatment the application of this process in food technology was never realized (Jeyamkondan et al. 1999). Disintegration of food particles and food contamination caused by the electrode material seemed to be the main reasons.

The phenomena of ohmic heating, electrochemical reactions, and hydraulic pressure attributed to the use of electrical energy in the described applications are of less importance when short pulses without arcing are applied.

Pioneering experimental work of the pulsed electric fields application for food processing was undertaken by Heinz Doevenspeck. He described efficiency of

pulsed electric fields for cell disruption within food material for improvement of the phase separation (Doevenspeck 1960, 1961). Within the next 10 years pulsed electric field technology was further developed by Doevenspeck and expanded to microbial inactivation. Growth of microorganisms and spoilage of beer samples was prevented after a pulsed electric field treatment. Treatment of fish tissue led to an improved separation of solid and liquid phase and an increase in digestibility of the PEF-treated fish slurry in comparison to conventionally fish meal.

The application of the PEF process as a pretreatment to enhance the production of biogas was investigated in a wastewater treatment plant resulting in a 20% increase. Other application examples given in Doevenspeck's patent range from wastewater and tap water treatment to cleaning of gasses as well as extraction applications. An inactivation of pathogens in marination brine and egg powder suspensions has also been described. An industrial-scale plant has been erected for the processing of beef and pork material and fish waste material with a capacity of up to 2500 kg/hour in a fat smeltery in Germany in 1961 (Toepfl et al. 2007b).

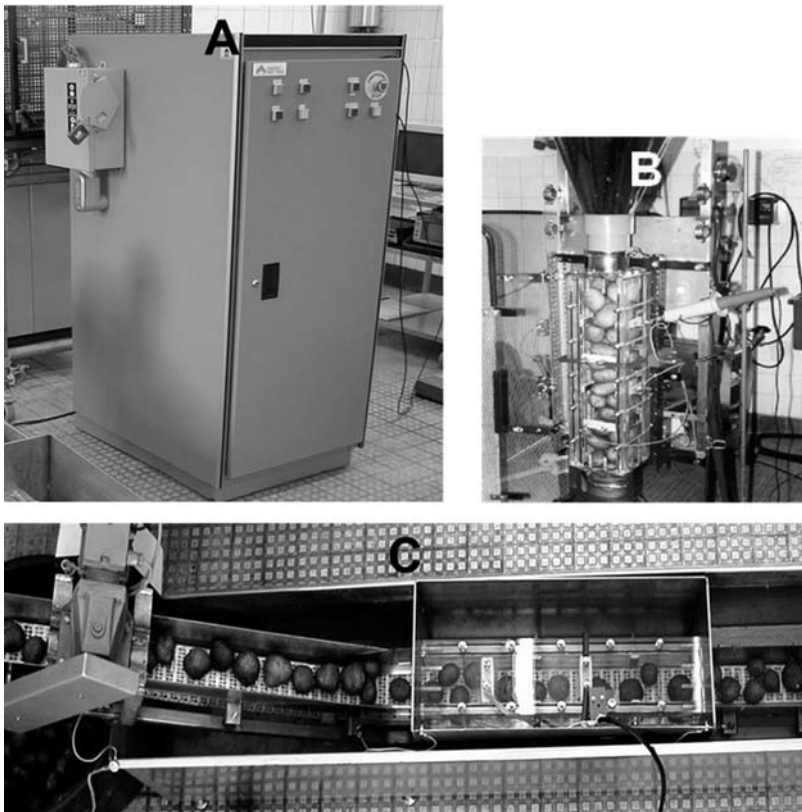
The first systematic studies on the nonthermal lethal effect of pulsed electric fields on microorganisms were conducted at Unilever Research Centre in the United Kingdom (Sale and Hamilton 1967). The insignificance of electrolysis on the lethal effect of DC pulses could be shown. Damage to the cell membrane with an irreversible loss of its function as semipermeable barrier was proposed as cause of cell death. Leakage of ions and loss of cytoplasmic content together with changes in membrane morphology and cell lysis after treatment confirmed this assumption (Sale and Hamilton 1968). As the killing effect of PEF was not dependent on current density, it was concluded that inactivation occurred due to nonthermal effects and electric field strength was identified as one of the most important factors.

Krupp Maschinentechnik recognized the technique's potential, and a group consulted by Doevenspeck worked on alternative processing techniques to induce cell disintegration and to improve phase separation culminating in the development of the processes Elcrack® and Elsteril®. In the Elcrack® process a slurry of comminuted fish or slaughterhouse offal was pumped through one or more dielectric discharge zones where the animal cells were subjected to the high-voltage pulses. This treatment disrupts the cell membrane, permitting the fat to emerge from the animal cells and consequently improving fat recovery during subsequent mechanical separation step (Krupp 1988). The Elsteril® process aims at microbial inactivation in pumpable food at higher field intensities since microbial cells are smaller in diameter than animal cells and therefore require higher field strength for cell disruption.

A similar application is given in a U.S. patent (Anonymous 1987) that describes "methods and apparatus for extending the shelf-life of fluid food products" by subjecting the fluid foodstuff such as dairy products, fruit juices, and fluid egg products to a controlled high-voltage electric field treatment. The patent recommends that electric pulses should be applied at a temperature of at least 45°C and it is further suggested that the fluid food product should be subjected to the PEF-treatment at pasteurization temperatures by which substantially improved shelf-life extensions may be achieved over those obtained by conventional pasteurization process.

A pilot scale PEF unit with a capacity of up to 200 kg/hour for treatment of sugar beet, palm fruit, oil seeds, fruit mashes, and fish slurry was developed by Krupp Maschinentechnik and industrial equipment has been realized to be installed in a fish factory in Norway . The application consisted of the Elcrack® system and a subsequent separation of free liquid followed by slurry separation in a screw press. Decanter centrifuges and separators were used to separate the fluid in the water and oil phase. Protein was removed using an ultrafiltration. In the beginning of the 1990s interest in PEF application increased at a research level and a great number of working groups in universities as well as commercial activities followed.

In 1995 Pure Pulse Technologies developed a continuous processing system called CoolPure® for the treatment of up to 2000 l/hour. In the same year a letter of no objection was released by the Food and Drug Administration (FDA) for the use of



**Fig. 2** PurePulse prototype system (A) providing a maximum voltage of 10 kV and an average power of 8000 J/s. It was used by the Department of Food Biotechnology and Food Process Engineering from 1998 to 2005 for fruit and vegetable processing along with different treatment chamber designs (B and C, developed at Berlin University of Technology) for the PEF-treatment of potato prior to starch extraction



PEF technology in food preservation. Additionally, in 1996 the treatment of liquid egg has been approved with certain conditions yet to be accepted (Barbosa-Cánovas and Altunakar 2007).

Although the investigations on pulsed electric field technology are numerous, only a limited amount of technical- or industrial-scale prototypes and/or commercial applications are available. At present, there are approximately 25 research groups working on PEF applications for food production. Research work is performed on microbial and enzyme inactivation, PEF applications as a disintegration technique, and the induction of stress response in biological cells.

A prototype for potato starch extraction (Fig. 2) was developed by ProPuls, Germany, and commercial prototypes for this application based on a patented Marx Generator design have been developed by KEA-Tec, Germany. Industrial prototypes for disintegration of plant material were developed for a sugar processing and a fruit juice company in Germany (Kraus 2003, 2004; Schultheiss et al. 2002; Schultheiss et al. 2004). A technical-scale unit for the preservation of fruit juice was installed in 2003 at Stork Food Systems in the Netherlands (Braakman 2003).

The first commercial PEF application was installed in 2005 in the United States for fruit juice preservation (Clark 2006). Genesis Juice Corp. used to distribute unpasteurized premium fruit juices until a warning letter of FDA was published (FDA 2003) requesting a nonthermal preservation technique. After PEF-pasteurization, a shelf life of 4 weeks has been obtained under refrigeration conditions. Clearance of the FDA is available since 1996, indicating the techniques potential for safe and gentle preservation.

In Europe, an approval is still pending. Based on the Novel Food legislation, the manufacturer can obtain the possibility to commercialize PEF-treated products if substantial equivalence to a commercially available, conventionally processed product is proven.

### **3 Preservation of Foods by Pulsed Electric Fields**

Consumer interest in fresh-like products with maintained taste, colour, flavour, and nutritional value is increasing, and therefore industrial interest in nonthermal inactivation of microorganisms in foods is arising. PEF-treatment combines gentle food preservation with short treatment times, continuous operation, and easy implementation into existing product flow.

Effective inactivation for most of the spoilage and pathogenic microorganisms has been shown, but in comparison to the treatment of plant or animal tissue the treatment intensity needs to be much higher. The potential to achieve sufficient reduction of microbes in various food products like fruit or vegetable juices (Ayhan et al. 2002; Evrendilek et al. 2000; Heinz et al. 2003; Hodgins et al. 2002; Lechner and Cserhalmi 2004; McDonald et al. 2000; Min and Zhang 2003; Molinari et al. 2004; Zhang et al. 1994), model beer (Ulmer et al. 2002) or milk (Bendicho et al. 2002; Sepulveda et al. 2005; Toepfl et al. 2006) has been investigated.

Reports on the effects of PEF on enzymes are limited and different experimental setups and processing parameters make them difficult to compare (Schuten et al. 2004; Van Loey et al. 2002; Yang et al. 2004).

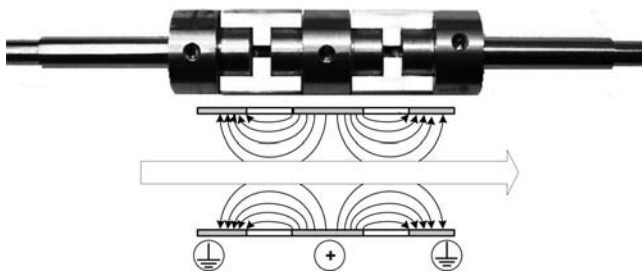
Enzyme inactivation after PEF-treatment is likely to be related to secondary effects such as local temperature distributions, electrochemical reactions or formation of free radicals instead of primary effects of the electric field. Unless utilizing thermal effects, the higher resistivity of enzymes might be a restriction for the preservation of liquid food by PEF as the reduction of enzymatic activity is often critical in food processing and preservation.

On the other hand, many enzymes are positively used in food processing and therefore PEF provides a high potential for the development of new processes and products.

The availability of pilot-scale equipment with continuous operability allows production capacities up to 1000 l/hour. Components required are an impulse generation system and a treatment chamber, where the food is pumped through while being exposed to the electrical field at ambient or refrigerated as well as elevated temperatures. Heat exchangers might be used to preheat the media. After treatment, the dissipated electrical energy resulting in a temperature increase has to be removed before aseptic packaging. An example of a colinear treatment chamber that can be easily implemented into existing processing lines is given in Fig. 3. It consists of a central high-voltage electrode and grounded counterparts separated by insulators. The product is pumped through by a central drilling.

The geometry of the treatment chamber has a considerable effect on electric field distribution and the total resistance and therewith on the discharge circuit. For application in the food industry the electrode and insulator material have to be food grade, and autoclavable, electrochemical properties, electrode erosion, and release of metallic particles into the food material have to be taken into account (Mastwijk 2004; Morren et al. 2003; Roodenburg et al. 2005a, 2005b).

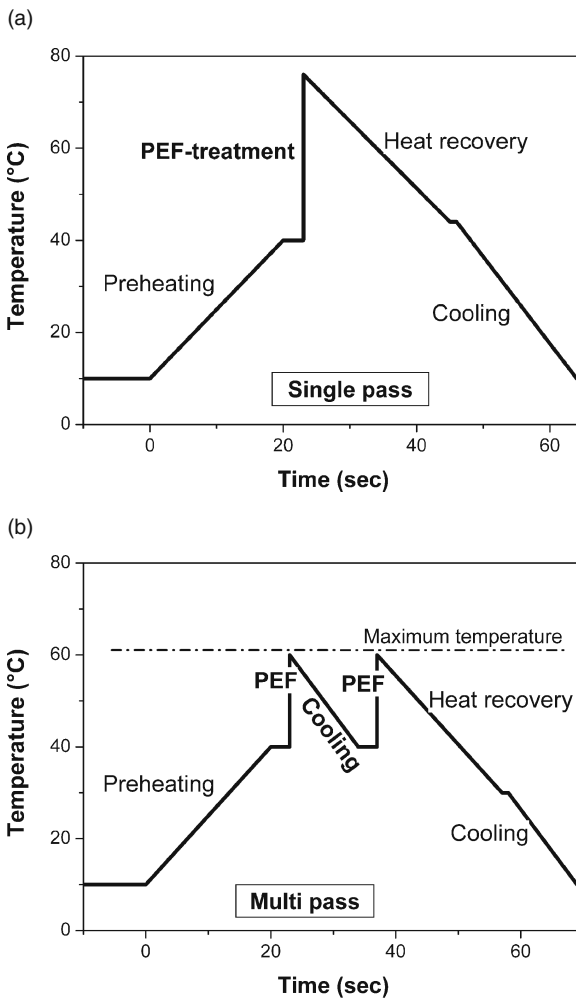
Although PEF is based on a nonthermal inactivation mechanism, a product temperature increase occurs due to the dissipation of electric energy. A specific energy input of, for example, 220 kJ/kg will cause a temperature raise from 20°C to 72°C, using water as an example with a specific heat capacity of 4.19 kJ/kg K.



**Fig. 3** Design of a colinear treatment chamber for the continuous treatment of liquid food and fruit mashes used at Berlin University of Technology

Depending on product and target organism this specific energy input might still not be sufficient for a desired reduction in colony counts, leading to an even higher temperature increase.

One concept to prevent temperature raise above a certain level is to split the total energy input needed for microbial inactivation into several portions. Therefore, the serial alignment of multiple treatment chambers with intermediate cooling sections is an option to maintain temperature below critical levels (Fig. 4). For cooling, an additional amount of energy will be required, leading to an unfavourable energy balance, which is only justifiable in case of heat-sensitive and high-value products.



**Fig. 4** Temperature–time profile of single pass and multipass PEF-processing concepts

On the other hand, allowing a certain temperature increase during PEF-treatment or raising the inlet temperature by preheating the product is reported to reduce the pulse number and the energy input required to obtain a certain level of microbial inactivation.

Treatment temperature has a highly synergetic effect on treatment efficacy as it significantly influences cell membrane fluidity and stability. At low temperatures the phospholipid bilayer is packed in a gel-like structure whereas its order decreases with increasing temperature forming a liquid-crystalline structure (Jayaram et al. 1992; Stanley 1991). The effect of increasing efficiency of PEF application at elevated temperatures has been reported in several studies (Evrendilek and Zhang 2003; Li, Zhang et al. 2005; Toepfl et al. 2007a).

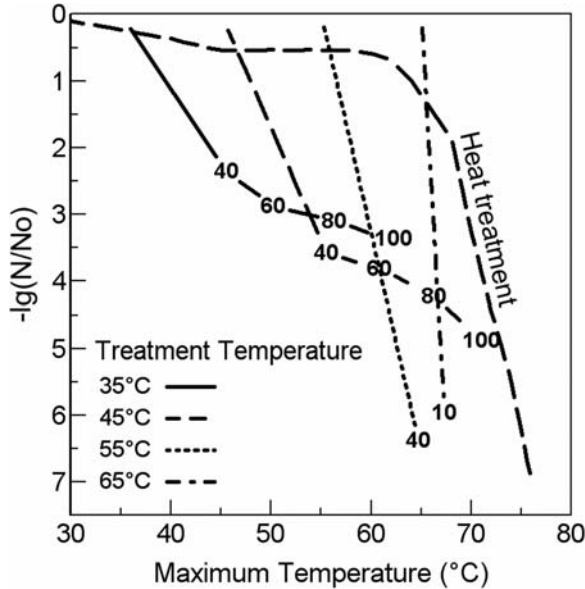
The high energy input of a PEF-treatment at low temperatures results in high costs of operation. By using a combination of heat and PEF-treatment, the energy consumption and the maximum temperature can be reduced. Compared to sole heat treatment, a given inactivation can be obtained at lower temperatures without any holding times resulting in a lower thermal load. Therefore, from a processing point of view, splitting the total required energy input into thermal energy, which makes the microbes more susceptible to PEF, and electrical pulse energy, which causes electroporation, is a possibility for the optimization of inactivation and energy consumption. A processing concept including heat recovery after PEF-treatment, where the energy dissipated by PEF, is used to preheat untreated media will be presented in a later section.

### **3.1 Juice**

The first commercial application of PEF for fruit juice preservation has been reported in the United States (Clark 2006), processing 200 l/hour of apple, strawberry, and other juices and showing its potential for an industrial exploitation. In addition to microbial inactivation, residual enzyme activity will determine shelf life of fruit juices if no chilled distribution is used.

The impact of a PEF-treatment on juice quality has been investigated by different research groups and no apparent changes in physical or chemical properties caused by electric field exposure have been found (Ayhan et al. 2001, 2002; Barbosa-Cánovas et al. 1998; Lechner and Cserhalmi 2004; Min and Zhang 2003; Yeom et al. 2000; Zárate-Rodríguez and Ortega-Rivas 2000).

In comparison to heat treated samples a higher amount of retained vitamin C and a 5–9% loss of flavour compounds in comparison to up to 25% loss after a thermal treatment could be observed. In a study investigating PEF-impact on four citrus juice varieties, no real difference was found for °Brix, pH, conductivity, viscosity, as well as nonenzymatic browning index and formation of hydroxymethylfurfural after a treatment at 28 kV/cm and 50 pulses (Cserhalmi et al. 2006). The energy input is not given, but can be estimated to be in a range of 68 kJ/kg for grapefruit, 66 kJ/kg for lemon and orange juice, and 83 kJ/kg for tangerine juice for the pulse parameters mentioned. The processing intensity was in a similar range with one



**Fig. 5** Comparison of inactivation of *E. coli* in apple juice after PEF-treatment at 34 kV/cm with four different treatment temperatures and sole heat treatment in relation to achieved maximum temperature. The numbers at the curves represent the specific energy input in kJ/kg (adapted from Heinz et al. 2003)

required for microbial inactivation; so, these results underline the minor impact of a PEF application on juice quality in contrast to a conventional heat treatment.

A comparison between a sole thermal treatment and a PEF-treatment of *E. coli* in apple juice at different initial PEF temperatures and energy levels in relation to the maximum temperature after treatment is shown in Fig. 5. By using a combination of heat and PEF-treatment, the input of electrical energy and the maximum temperature can be reduced. Compared to sole heat treatment, a given inactivation can be obtained at lower temperatures, resulting in a lower thermal load and in an improved preservation of quality and fresh-like character of the juice.

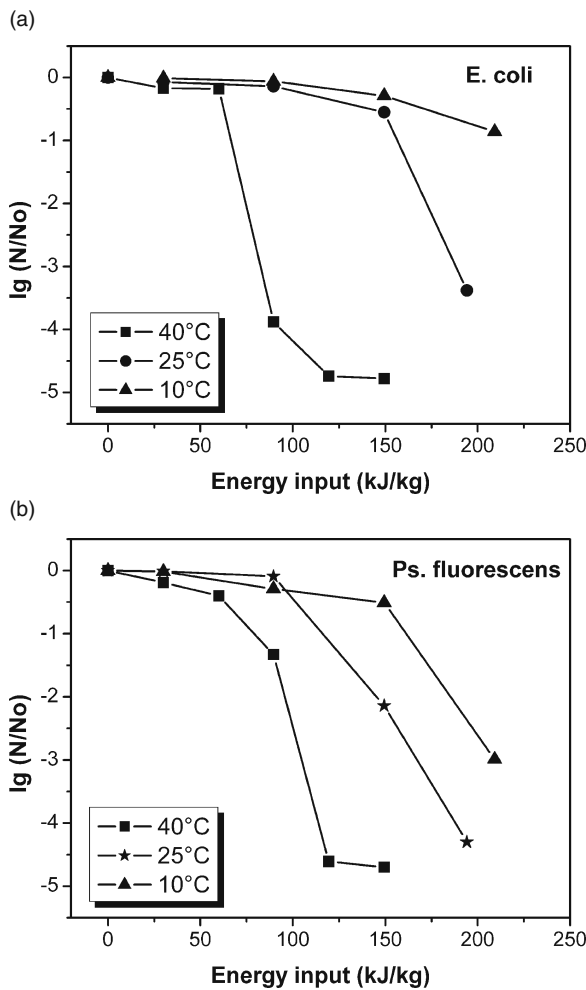
### 3.2 Milk

Milk was the first product commercially pasteurized by the direct application of electrical energy using the “electropure” process established in the 1920s. Hence, it is not surprising that also applicability of pulsed electric energy within a treatment for milk preservation was studied (Bendicho et al. 2002; Sampedro et al. 2005; Sepulveda et al. 2005; Smith et al. 2002; Toepfl et al. 2006).

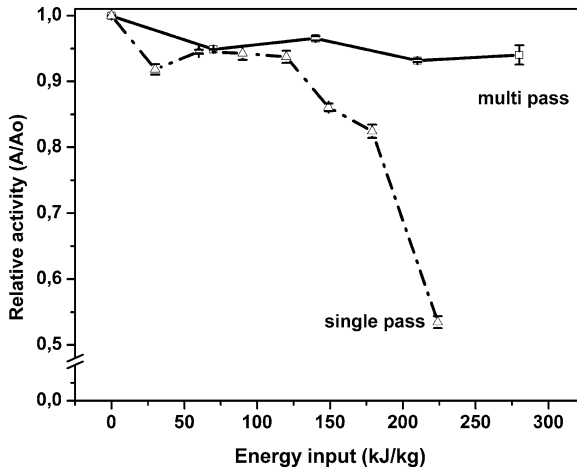
As in the case of juice decontamination, the focus was on microbial inactivation (Calderon-Miranda et al. 1999; Evrendilek et al. 2004; Picart et al. 2002; Reina et al. 1998) as well as on PEF impact on enzymes (Bendicho et al. 2003; Castro et al. 2001).

Only few data are available regarding PEF effects on other milk constituents and technological milk properties. Perez and Pilosof (2004) reported a partial modification of the native structure of  $\beta$ -Lactoglobulin when subjecting the concentrate to an electric field of 12.5 kV/cm. Thermal stability of  $\beta$ -Lg was reduced after PEF but gelation rate showed to be enhanced. Bovine Immunoglobulin G subjected to PEF at 41 kV/cm for 54  $\mu$ s did not show any detectable changes in the secondary structure or the thermal stability (Li, Bomser et al. 2005; Li, Zhang et al. 2003).

Investigations, conducted at Berlin University of Technology, showed a 4.5 log reduction of *Escherichia coli* and *Pseudomonas fluorescens* in milk (Fig. 6),



**Fig. 6** PEF-Inactivation of *E. coli* and *Ps. fluorescens* in milk depending on specific energy input and treatment temperature. Field strength 21.6 kV/cm, flow 5 l/hour (adapted from Jaeger 2006)



**Fig. 7** Relative activity of Lactoperoxidase in raw milk after PEF-treatment at 35 kV/cm and 27°C. Multipass: Treatment was performed using a multipass system applying 70 kJ/kg per pass with intermediate cooling keeping maximum temperature below 45°C. Single pass: Milk was subjected to the different energy inputs with only one pass resulting in a temperature increase up to 80°C at 225 kJ/kg, causing thermal inactivation of lactoperoxidase (adapted from Jaeger 2006)

whereas the inactivation of lactoperoxidase in milk by PEF revealed only a slight decrease in enzyme activity of about 5% when using a multipass system (Fig. 7).

Several effects of electric fields on enzymes have been proposed, including conformational changes of protein structure, local thermal, and pH effects as well as formation of radicals or other electrochemical reactions. The electrophoretic effect might cause changes or the release of central ions from complex protein structures.

Changes of pH or local differences in temperature increase as well as the release of metallic particles from the electrodes might play an additional role and might be considered as impact factors causing enzyme inactivation as the electroporation effect is related to membrane structures only. In case of lactoperoxidase the retained antimicrobial activity after the PEF decontamination of milk can be used to delay the growth of microorganisms during storage. In contrast to application of thermal energy an only limited impact of PEF-treatment on food constituents was found.

The reduction of maximum temperature during milk preservation and the short residence time of a PEF-treatment will maintain heat-sensitive constituents after microbial decontamination.

A combined application of mild heat and pulsed electric fields for milk preservation can provide a possibility to operate at lower maximum temperature than during conventional processing. This is of high interest with regard to servicing times of heat exchangers, where a reduction of biofouling and associated efforts for cleaning of heat exchanger plates could provide a potential to increase operation times and cost reduction (Bansal and Chen 2006).

## 4 Improvement of Mass Transfer Process in Plant Material

Even though most of the studies have been committed to the ability of PEF technology to inactivate microorganisms, in the last decades progressive research has been done on its impact on chemical composition of foods, PEF-assisted cell expression and extraction, and induction of stress reactions in plant tissue, which offers numerous possibilities for the food industry.

### 4.1 PEF-Assisted Cell Expression and Extraction

Conventional disintegration techniques such as grinding, pressing, and thermal and enzymatic treatments are some of many operations applied in food industry for mechanical disruption of cellular material prior to recovery of intracellular compounds or juice and oil extraction. The main objective of the aforementioned techniques is permeabilization of a cell membrane to promote intracellular components and/or liquid accessibility. However, these techniques may destroy tissue; may deteriorate textural properties of a product and loss of nutritionally and technologically valuable components may occur, which limits products potential for further utilization of raw material.

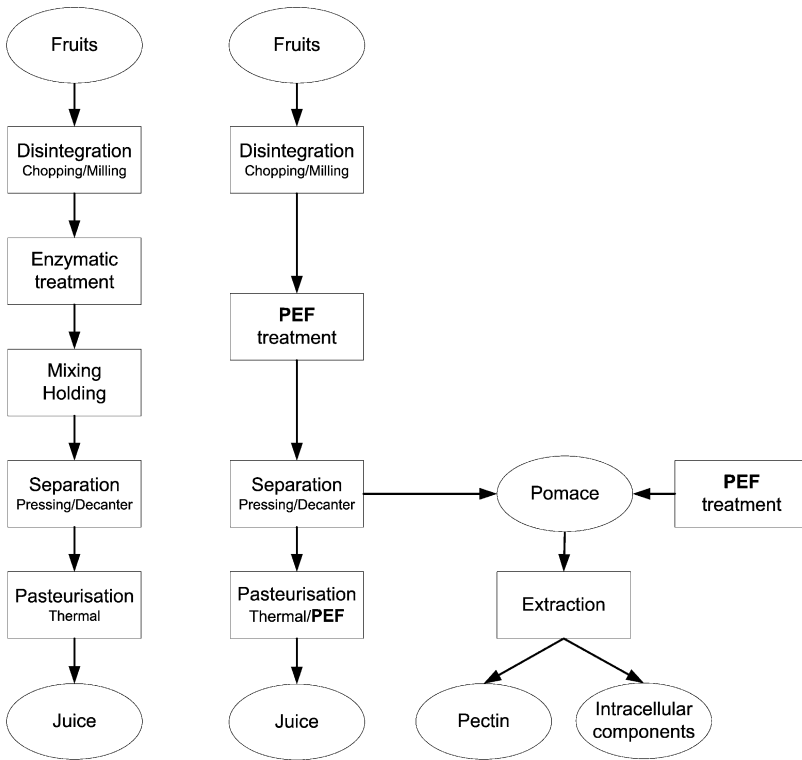
PEF-induced cell membrane permeabilization, called electroporation, is used to increase permeability of the cell membrane and, in the case of expression and extraction, enhance mass transport out of the cells (Bazhal and Vorobiev 2000; Doeven-speck 1961; Fincan et al. 2004; Flaumenbaum 1968; Knorr and Angersbach 1998; Knorr et al. 1994). Disruption of the cells can be achieved by applying PEFs of different intensities (for particular products) across the cell medium or plant tissue. Larger cells need lower electric field intensities to achieve sufficient cell disruption, while smaller cells need much higher treatment intensities for the same degree of cell membrane permeabilization.

Additional to cell size, cell geometry is of a great importance for achieving process treatment intensity to induce sufficient transmembrane potential for an electropermeabilization. Furthermore, initial condition of cellular structure, type of biological material, and homogeneity of the structure contributes to the effectiveness of the treatment. Due to the mentioned reasons the most efficient processing conditions are not the same for variant plant systems employed, and individual approach is necessary to optimize PEF-treatment intensity needed for membrane electropermeabilization.

#### 4.1.1 Fruit Juice Extraction and Expression

PEF technology can be utilized within fruit juice production not only as a preservation method but as a pretreatment of raw material to increase permeability of the cells enhancing juice extraction and extraction of intracellular components (processing scheme is shown in Fig. 8).





**Fig. 8** Apple juice processing scheme. Comparison of conventional juice making process with electroplasmolysis treated apple mash and pomace

The first attempt to produce apple juice with higher extraction yield of valuable components was in the 1960s (Flaumenbaum 1968). Until today a couple of studies have been made with the objective to improve solid–liquid extraction of juice from apple mash (Bazhal et al. 2001; Lebovka et al. 2004a; McLellan et al. 1991; Schilling et al. 2007; Toepfl et al. 2005), whereas several groups reported high increase in juice yield after PEF-treatment, while few could not achieve such a high distinction. Bazhal and Vorobiev (2000) reported significant increase in total juice yield after intermediate PEF-treatment (in between two pressings).

When PEF-treatment of very low intensities (100–520 V/cm) was simultaneously applied to pressure treatment (Bazhal et al. 2001), a passive form of PEF-induced cell plasmolysis was revealed. Damage of electropermeabilized cells together with moisture migration out of the cells was enhanced with pressure and cell membrane resealing process was hindered. One of the advantages of such a treatment is in increased purity and clarity of extracted juices.

Although the effectiveness of a process concerning juice yield slightly varied within reports, it was mostly agreed that no apparent change in pH value, total

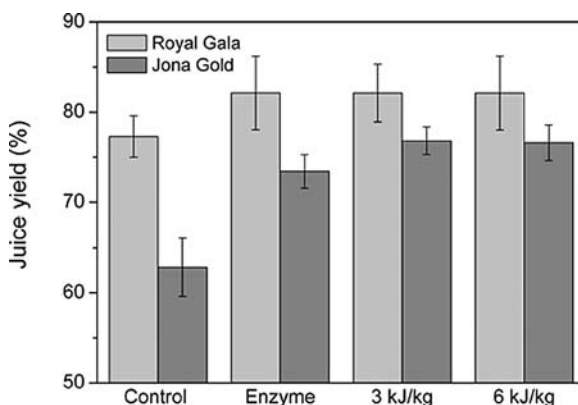
sugars, and total acidity was reached. Additionally, the content of many nutritionally valuable compounds was retained or even enhanced.

When PEF is employed instead of enzymatic mash maceration, it is possible to regain antioxidant substances from plant processing residual material (Balasa *et al.* 2006). Also, good potential for pectin recovery is enabled (Schilling *et al.* 2007), since these food components have not been destroyed with enzymatic or high-temperature treatments.

PEF processing technology can be easily integrated in already existing industrial plant with conventional juice making process (Fig. 8). For a variety of application, batch systems can be employed as a pretreatment operation prior to size degradation, while the true potential is in continuous PEF-treatment processing. Therefore, PEF could be implemented together with a decanter centrifuge, which allows solid–liquid continuous separation, within the continuous juice making process. Practical application of such a process does not require development of the inverse process design procedure.

On the other hand, it has to be mentioned that the implementation of PEF disintegration has to come along with the adaptation of previous and subsequent processing steps. The mash particle size, based on the grinding technique, as well as the system used for solid–liquid separation, like a belt press, filter press, or decanter, is an important influence parameter. Only a well-aligned process will be able to convert the cell disintegration obtained by PEF into a higher juice yield at the end.

The impact of different PEF-treatment intensities on juice yield from Royal Gala and Jona Gold in a baling press in comparison with untreated and enzyme treated sample is shown in Fig. 9. In comparison to a filter press a higher surface/volume ratio is obtained in a baling press as the mash is divided into several lots. Even if a baling press is operable in batch mode only, it shows a principle of liquid–solid



**Fig. 9** Juice yield obtained in baling press from two apple varieties after PEF-treatment at 2 kV/cm and different specific energy input in comparison to enzyme treatment and untreated sample (adapted from Toepfl 2006)

separation similar to that of a belt press. The application of belt presses could provide a highly promising and continuously operated alternative to the application of filter presses. The improvement and adaptation of separation techniques on structural changes of fruit mashes caused by PEF-treatment is therefore a major requirement for successful PEF application.

Solid–liquid expression of PEF-pretreated carrots (Knorr et al. 1994) and grapes (Balasa et al. 2006; Praporscic et al. 2007; Tedjo et al. 2002) was studied on the laboratory scale as well. In addition to the higher juice yield obtained after PEF-treatment, evaluation of selected quality criteria for both juices showed that application of high-intensity electric field pulses on mash resulted in higher  $\beta$ -carotene content and pigment release in juice than from samples processed in a conventional way.

Good flavor and color characteristics of a product together with high nutritive value are not only of a great importance for food technologists, but awareness of consumers rose together with demands for high-quality natural foods. As high-temperature treatments cause losses of nutritionally and physiologically valuable components, therefore lowering product quality, PEF was observed not to deteriorate these properties maintaining fresh characteristics of the final product.

The possibility of employing PEF technology in sugar processing has also attracted attention. Current industrial production of sugar includes thermal denaturation of the cell membranes with temperatures above 70°C with subsequent extraction. Temperature facilitates diffusion coefficient and sugar together with water-soluble substances diffuse out of the cells. On the other hand, structural substances from the cell wall undergo changes due to high-temperature treatment and become water soluble, which does not attribute to high purity of extracted raw juices.

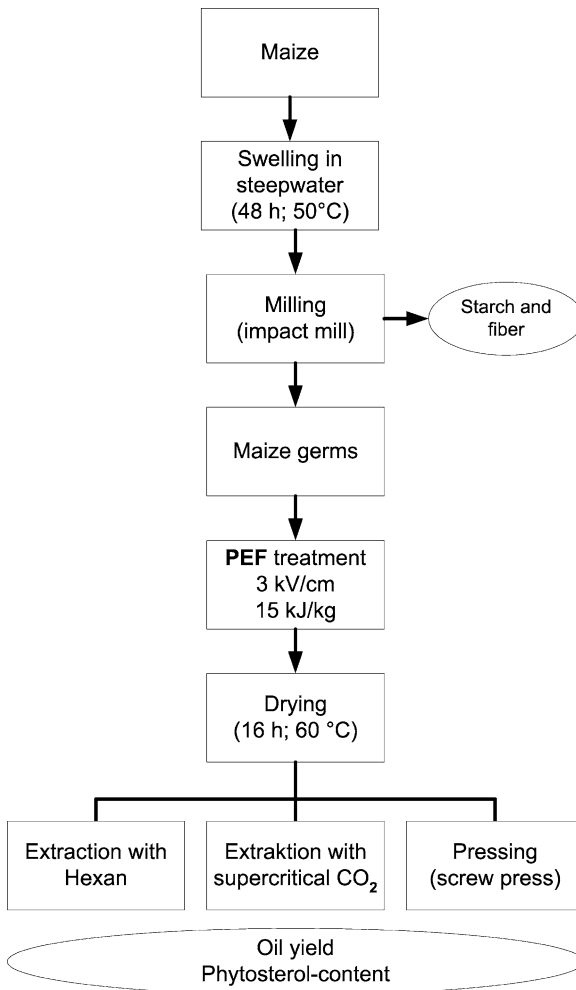
Therefore, a nonthermal method for enhancing efficiency of the sugar production process with PEFs was developed (El-Belghiti et al. 2005; Eshtiaghi and Knorr 1999; Knorr and Angersbach 1998). Extraction of sugar beet using moderate electric field treatment of around 1.2–2.4 kV/cm followed by mechanical pressing resulted in two- to threefold increase of the solid concentration in the obtained extract (Eshtiaghi and Knorr 2000). In a similar study Bouzrara and Vorobiev (2000) have been investigating mechanism of solid–liquid expression from sugar beet cossettes, whereas they showed PEF-enhanced mechanical compression with facilitated liquid extraction from permeabilized cells.

PEF-treatment was successfully applied at the laboratory level and with scale-up experiments towards a novel process of cold juice extraction (Jemai and Vorobiev 2006). Processing scheme, which consisted of two initial pressing steps with an intermediate PEF-treatment, followed by one or more washing steps and a final pulp pressing, turned out to be very efficient and results obtained showed significant increase in extracted juice yield. Purity and quality of juices obtained after PEF-treatment was shown to be higher than of industrial juices, while denaturation of cell wall components due to high-temperature treatment did not occur. Such a process can lead to much reduced energy consumption.

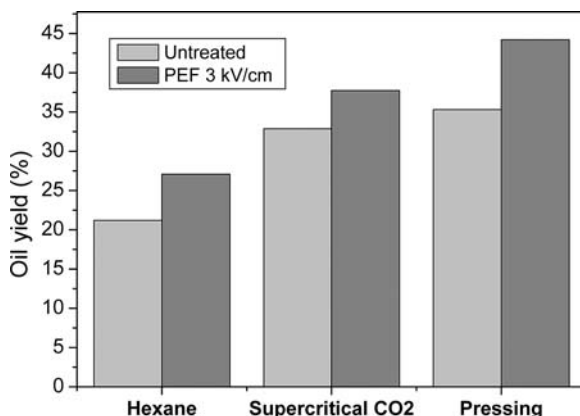
### 4.1.2 Plant Oil Extraction

Plant oils are used in wide variety of ways in food, medicine, cosmetics, and industrial production of biodiesel that attracted a huge interest in a last couple of years. Based on the same effect (increased mass transfer coefficient due to electropermeabilization), application of high-intensity electric fields could replace and upgrade conventional techniques in recovery of plant oils.

Till date, there are not many studies done in this field, but few showed promising results. Extraction of oil on laboratory scale from PEF-pretreated maize, soybeans, and olives was developed and is shown in Fig. 10 (Guderjan et al. 2005).



**Fig. 10** Process scheme for the production of maize germ oil with implemented PEF-treatment and use of different extraction techniques as conducted at Berlin University of Technology



**Fig. 11** Oil yield comparison of untreated and electropermeabilized (3 kV/cm, 15 kJ/kg) maize germs extracted with different methods according to the process scheme Fig. 10 (adapted from Guderjan and Knorr 2005)

Besides higher oil yield, additional progress is shown in higher content of nutritional ingredients. The oil yield obtained by different extraction techniques after PEF-treatment of maize germs is shown in Fig. 11.

Further investigation of low-intensity PEF-treatment on oil yield and functional food ingredients content after pressing and solvent extraction of rapeseed was done by Guderjan et al. (2007). Unsaturated properties and saponification values of rapeseed oil stayed unchanged, while higher concentration of free fatty acids and chlorophyll was determined. The possibility of using nonthermal PEF processing in extraction of plant oils offers higher extraction yield with preservation of functional food ingredients.

### 4.1.3 Extraction of Intracellular Compounds

Available methods for the recovery of intracellular compounds that are used nowadays are freeze-thawing and mechanical expression or extraction with strong organic solvents. The efficiency of these methods depends on the degree of cell membrane permeabilization influencing extraction process. As the primary effect of PEF on biological cells is breakdown of the cell membrane, application of such a treatment could be used instead of conventional processing methods.

Enhancing diffusion of soluble substances through the membrane for winning of bioactive substances like different macromolecules, flavors, pigments, and other cell metabolites is of considerable interest not only for food industry but in cosmetic production or in biotechnology as well.

Extraction of intracellular pigments facilitated with high-intensity electric field treatment had proven to be a very efficient process in terms of energy and time consumption for winning of these valuable components with beneficial antioxidant properties (Balasa et al. 2006; Eshtiaghi and Knorr 2000; Fincan et al. 2004; Tedjo et al. 2002). PEF-induced cell permeabilization and release of intracellular pigments

(anthocyanins) from wine grapes was studied by Tedjo et al. (2002). They showed a threefold increase of total anthocyanin content after applying electric field strength of 3 kV/cm and 50 pulses.

The advantage of such a nonthermal treatment is in the utilization of extraction application related to good pressing efficiency and enhanced extraction of intracellular components, mentioned in previous subchapters. The content of functional food ingredients (e.g., flavonoids, carotenoids, phenolic acids) in such a product is higher, which contributes to consumer demands for healthy, valuable food with higher nutritional value. Impact of low-intensity PEF-treatment (1 kV/cm) on extractability of betalain (main beetroot pigment) and ionic species was shown by Fincan et al. (2004). Ninety percent of the total red coloring release was obtained with low energy input of 7 kJ/kg.

In addition, this type of nonthermal electroporation might be beneficial for the development of a high-quality food product with further possibility of residue exploitation. Industrial and agricultural residues are valuable source of natural antioxidants, which are often wasted or disposed as soil conditioner, whereas they could be further utilized for the recovery of valuable intracellular compounds.

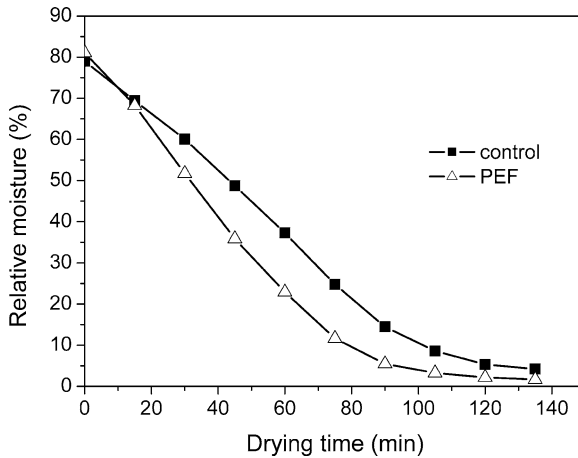
One other possible commercial exploitation for the recovery of intracellular components is electroporabilization of seaweed, microalgae, and other aquatic species. PEF-treatment provides good potential of gentle processing in contrast to hot-water extracts, which are commonly used for winning of bioactive substances (e.g., vitamins, pigments, proteins, minerals, hormones) from aqueous species. Koehler et al. (2005) reported an increase of 27%, 809%, and 525% in protein, chlorophyll, and carotenoids content of extracts obtained from PEF-treated (15 kV/cm) algae (*Chlorella vulgaris*), with total energy input of 100 kJ/kg. Data for *Chlorella vulgaris* and *Spirulina platensis* microalgae are given in Table 1.

## 4.2 Drying Enhancement

Removal of water is one of the oldest methods used for food preservation. Food industries nowadays are mostly using high-temperature treatments (thermal dehydration and/or hot drying) to produce dehydrated foods. Physical and biochemical status of foods are affected with conventional dehydration methods, contributing to change in colour, texture, and taste of heat-treated products. Valuable heat-sensitive

**Table 1** Increase of extraction of intracellular compounds from *Chlorella* (Chl.) and *Spirulina* (Spir.) microalgae after PEF-treatment of rehydrated spraydried algal biomass at 15 kV/cm and 100 kJ/kg and subsequent disintegration by boll mill followed by hot-water extraction (adapted from Koehler et al. 2005)

| Component              | Chl.  | Chl. PEF | Yield increase (%) | Spir. | Spir. PEF | Yield increase (%) |
|------------------------|-------|----------|--------------------|-------|-----------|--------------------|
| Protein (g/100 g)      | 5.48  | 6.98     | +27                | 33.68 | 38.12     | +13                |
| Chlorophyll (g/100 g)  | 0.011 | 0.1      | +809               | 0.17  | 0.26      | +52.9              |
| Carotenoids (g/100 g)  | 0.008 | 0.05     | +525               | 0.044 | 0.11      | +150               |
| Protease (Units/100 g) | 204.7 | 707.2    | +245.5             | 864.2 | 812.5     | -94                |



**Fig. 12** Relative moisture content (weight balance) of 5 mm thick potato slices during convective air drying at 80°C air temperature and 1 m/s air velocity. PEF-pretreatment was performed after sample blanching 5 min at 85°C applying 60 pulses of 1.5 kV/cm (adapted from Toepfl 2006)

components are lost as well. Diffusion of moisture from the core to the surface determines drying rate of the product, and therefore acceleration of mass transfer would be advantageous.

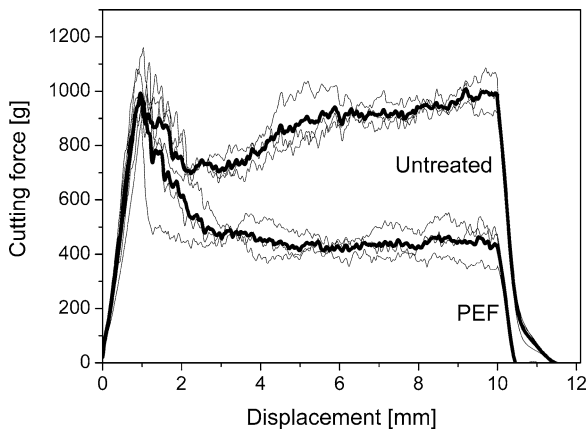
As electropermeabilization of the cell membrane leads to drastic increase in mass transfer rates, high-intensity PEF-treatment can be exploited within this process as well. PEF-enhanced permeability of potato tissue, which resulted in improved mass transfer during air dehydration and therefore shorter drying time, was demonstrated by Angersbach and Knorr (1997) and Rastogi et al. (1999).

Diffusion coefficients and drying rates of osmotic dehydration accelerated with high-intensity PEF-pretreated carrots (0.22–1.60 kV/cm) were investigated by Rastogi et al. (1999). With such a low treatment intensities, where the applied energy was in a range of 0.04–2.25 kJ/kg, increase of temperature did not occur, whereas enhanced diffusion coefficient contributed to faster water loss.

It has been shown that application of PEF-treatment minimizes quality degradation and saves energy by a means of reducing drying times, as shown in Fig. 12 (Ade-Omowaye et al. 2001a, 2001b). When taken into account that PEF-treatment of plant and animal tissue applied for drying enhancement requires energy input in a range of 2–20 kJ/kg, it is evident that there is a potential to reduce the total energy input required for product processing.

## 5 Softening of Plant Tissue

The effect of irreversible electroporation of biological cells results in the loss of membrane semipermeability and subsequently in a decrease of turgor pressure within the cell. Since this pressure acts as the plant cell supportive structure, a loss of turgor results in tissue softening.



**Fig. 13** Impact of a PEF-treatment (1.2 kV/cm, 10 kJ/kg) on textural properties of potato tissue. *Bold lines* show the average of three samples of untreated and PEF-treated potato (adapted from Janositz 2005)

It is obvious that a change of textural properties can be utilized during production and processing of various biological products. Tissue softening of apple, potato, and carrot after PEF-treatment have been described and a reduction of the elastic modulus was reported (Fincan and Dejmek 2003; Lebovka et al. 2004b).

For sugar beet 50% steady-state cutting force reduction and improvement of cut quality could be observed (Kraus 2003) along with less abrasion of the cutting devices.

A reduction of grinding energy of potato similar to that of thermal or enzymatic treatment can be achieved with a continuous, short-time, and low-energy ( $\sim 10$  kJ/kg) PEF-treatment. Cutting behaviour and properties of the cut surface are reported to be changed, resulting, for example, in a lower fat uptake of French fries when processing PEF-pretreated potato (Janositz 2005). A force–displacement curve of potato samples after PEF-treatment in comparison with untreated samples is shown in Fig. 13.

## 6 Stress

Plants have evolved defense mechanisms like the synthesis of proteins and phytochemicals when they are exposed to extreme circumstances. Naturally occurring adverse external conditions such as wind, rain, deficit in physical or chemical environment, or imposer to other living organisms can cause a defensive response (Mitchell 1996). Phytochemical defense can be characterized as accumulation of different pigments, flavors, and other bioactive components, which are important anti-inflammatory and antioxidant substances and therefore valuable food ingredients. Although strained conditions are naturally occurring, they may also be

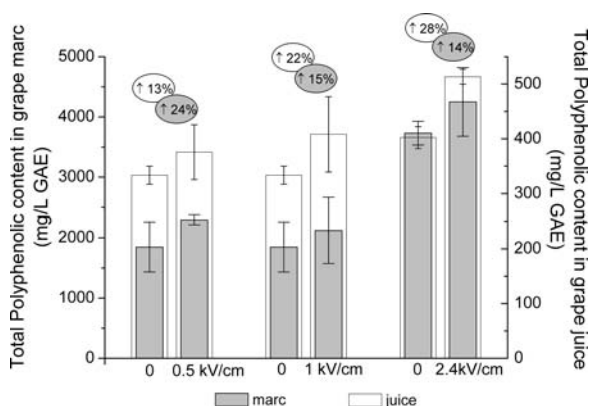


artificially induced to stimulate plants for the production of large amounts of phytochemicals.

One of the PEF applications that attracted considerable interest in the last years is induction of stress response reactions with biosynthesis of plant metabolites. Nonthermal gentle processing with very low treatment intensities (from 0 to 1.5 kV/cm) is related to retention and availability of plant metabolites, whereas production of secondary metabolites and modification of functional properties of food ingredients are possible.

As mentioned before, application of low-intensity treatment does not necessary cause irreversible permeabilization. When an external electric field with adequate strength is applied, initiation of conductive channels across the membrane occurs, with a temporal pore formation. The electrically insulating properties of a membrane can be recovered within very-short-time resealing pores and restoring vitality and metabolic activity of the cells (Angersbach et al. 2000). As PEF-treatment permeabilizes the cell membrane to a certain degree, after which resealing of pores occur, biological systems can be stimulated by meaning of stimulation of metabolic activity and subsequent production of secondary metabolites.

Doenenburg and Knorr (1993) studied the impact of low-intensity PEF-treatment (0–1.6 kV/cm, 0–30 pulses) in a frame of reversible and irreversible membrane permeabilization on the production and recovery of secondary metabolites from cultured plant tissue. They reported that sustainable content of plant pigment was released before cell viability was lost. PEF-induced release of intracellular pigments from plant systems was shown by Guderjan et al. (2005). It was reported that sublethal treatment of maize germs (0.6 kV/cm) increased phytosterol production, which resulted in increased oil yield with higher phytosterol concentration.



**Fig. 14** Total polyphenolic content of grape marc and grape juice obtained from grapes treated with different PEF intensities (0.5; 1; 2.4 kV/cm, 50 pulses). 13%, 22%, and 28% denotes increase of total polyphenolic content of grape juice in comparison to untreated sample; 24%, 15% and 14% denotes increase of total polyphenolic content of grape marc in comparison with untreated sample. GAE: Gallic acid equivalent (adapted from Balasa and Knorr 2006)

Interestingly, such a high increase could not be asserted with PEF-treatment in a range of irreversible membrane permeabilizations at 7.3 kV/cm and 120 pulses.

Secondary metabolite production from wine grapes (*Vitis vinifera*) induced with electric field pulses of low intensity (specific energy input of 0.1 kJ/kg) was investigated at Berlin University of Technology. Total polyphenolic increase after PEF-treatment of grapes is shown in Fig. 14.

Reversible electroporation began to be intensively investigated only in the last couple of years, whereas the mechanism of plant response to electromechanical impact at the present moment is still scarce.

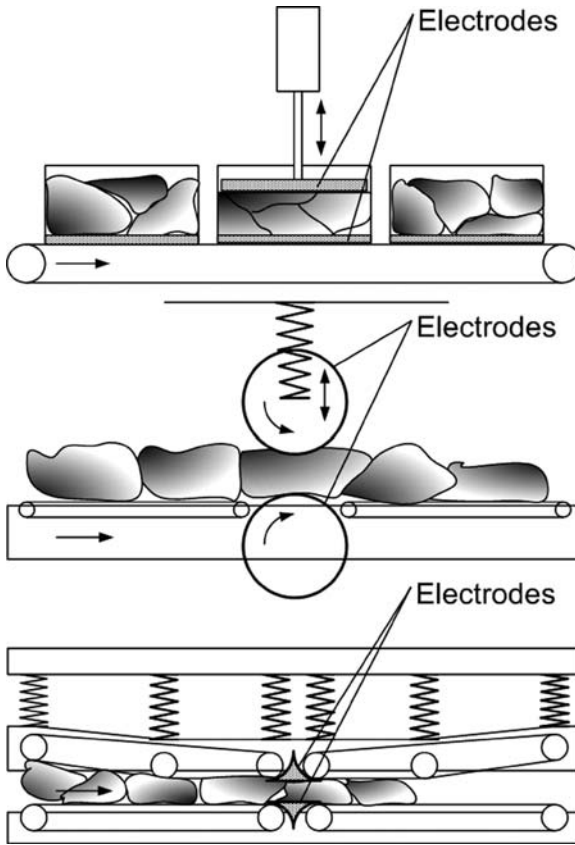
## 7 Meat Treatment

Only a few reports are available on the impact of PEF-treatment on protein-based food structures like meat and fish or protein gels (Barsotti et al. 2001; Gudmundsson and Hafsteinsson 2001; Hafsteinsson et al. 2000; Sitzmann and Münch 1988).

Permeabilization of meat tissue was reported to be utilized to enhance mass transfer as occurring during drying or brining processes (Toepfl and Heinz 2007). Salt in combination with antimicrobials like nitrite is used to increase the shelf life of meat products. Depending on the type of salting (brining or dry pile salting), a certain time depending on diffusion rate is required for impregnation to allow penetration of salt to the product core. Another hurdle to prevent microbial growth is a further reduction of water activity obtained by drying and maturing (Black forest or Parma-type ham, Salami-type sausage). PEF technology for the disintegration of animal cellular tissue like for the disintegration of fruit and vegetable products is therefore an appropriate tool to improve mass transfer processes and accelerate curing and drying, reducing time requirements. The improved availability of intracellular liquid for fermenting cultures accelerates the fermentation of raw sausages.

PEF-treatment of whole pieces of meat as a “dry” treatment can be realized by different designs, all allowing direct contact between meat and electrodes (Fig. 15), whereas for the treatment of pumpable minced sausage, a continuous colinear flow-through treatment chamber design (as shown in Fig. 3) is appropriate.

The impact of PEF on meat tissue integrity was shown by treating pork shoulder samples with varying intensities (Toepfl and Heinz 2007). Increased sample conductivity could be observed by increasing treatment intensity, indicating higher tissue permeability and improved ion flux. Reduction of the maximum cutting force instantaneously after PEF-treatment as well as a tender structure of dry cured ham after maturing was observed. The enhanced activity of endogenous proteolytic enzymes due to their increased release after PEF-treatment is assumed to cause this tenderization improvement. The impact of PEF-treatment on meat conductivity could be shown to be similar to the mechanical stress during tumbling; so PEF-treatment provides a potential to reduce tumbling time during cooked ham processing.



**Fig. 15** Design concepts for a continuous treatment of meat pieces. *top*: Semicontinuous conveying system using the ground electrode as part of the transport box; *centre*: Moveable electrodes designed as roller; *bottom*: Fixed and movable conveyor belts to transport pieces through an electrode pair (as proposed by the German Institute of Food Technology, Quakenbrueck)

The drying of pork shoulder was reported to be accelerated depending on PEF-treatment intensity and salting procedure so that an enhanced drying rate and a reduction of drying time could be achieved. As drying rate is mainly determined by the diffusion of moisture from the product core to the surface apart from the water removal from the surface, disintegrated meat structure improves the drying process.

In treating minced meat, the PEF application could be used as an additional disintegration technique, apart from grinding, resulting in a decrease in curing time of sausages as moisture removal is accelerated and an enhanced fermentation due to the improved release of intracellular substances takes place. To allow a treatment of sausage meats the treatment chamber is implemented in the filling tube.

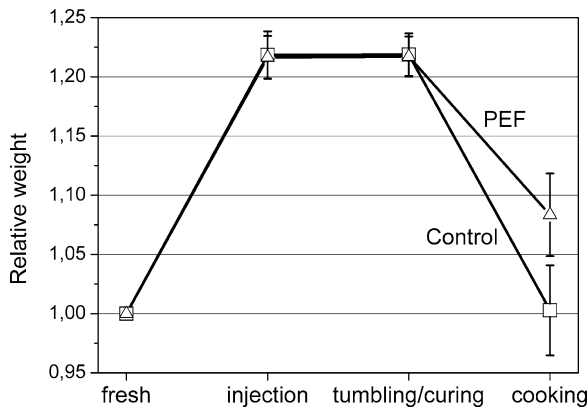
No detrimental effect on starter cultures will occur as the applied field intensity is too low to cause microbial inactivation.

PEF-pretreatment can be utilized to improve uptake of salt and nitrite. An increase of brine uptake in fish based on an enhanced diffusion of salt to the product core was reported by Hafsteinsson et al. (2000).

During the production of cooked ham, commonly pickling brine is injected up to 25% of fresh weight to induce nitrite, salt, and spices and to improve yield after cooking. Injection is followed by tumbling to improve brine distribution and to achieve mechanical disintegration. The impact of PEF on mass transport and microdiffusion of brine was investigated by Toepfl (2006). The drip loss after cooking of ham was observed to be reduced from 22% to 13% when processing PEF-treated (2 kV/cm and 10 kJ/kg) meat (Fig. 16).

The microstructure of the ham samples analyzed by Scanning electron microscopy (SEM) microscopy indicates enhanced protein swelling after PEF-treatment due to the formation of protein–water interactions due to facilitated brine and phosphate microdiffusion and an inclusion of free water by improved access of phosphates to protein filaments. As the drip loss of PEF-treated meat is increased during cooking if brine was used without phosphate addition, it can be concluded that water-binding capacity is not enhanced by the PEF-treatment itself but by the synergetic effect of phosphate and PEF.

Mechanical stress during tumbling enhances even the distribution of brine and partial protein disintegration, improving the water binding capacity. In comparison with untreated samples the tumbling time for PEF-treated meat could be reduced, still achieving similar weight yield leading to shortened time and smaller production costs.



**Fig. 16** Weight development during production of cooked ham relative to fresh weight. 22% (w/w) brine injection with 1.5% phosphate addition, tumbling 2 hours, curing 4 hours, cooking up to 64°C core temperature (adapted from Toepfl 2006)

## 8 Wastewater Treatment

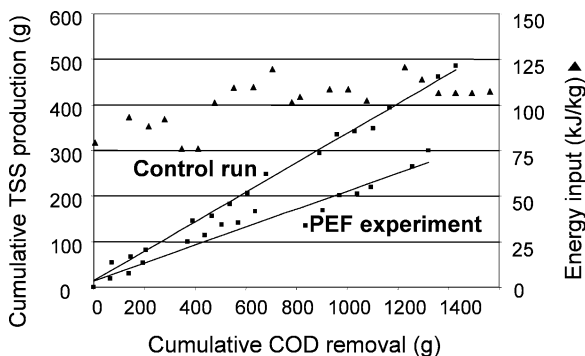
PEF-treatment attributes have not only found applicability in the possible disintegration or pasteurization of food products but also in the treatment of wastewater, which can be also considered as a product generated during food processing.

Sludge as resulting from the processing of wastewater consists of large amounts of organic matter mainly in the form of a variety of different organisms. Their disintegration by application of PEF-treatment and the subsequent release of intracellular material initiates and promotes biodegradation and autolysis of cells resulting in a minimization of excess sludge production.

Volatile suspended-solids and gas production during anaerobic degradation were found to be improved after a PEF-treatment at 15 kV/cm and an energy input of 150 kJ/l (Kopplow et al. 2004). Increasing chemical oxygen demand (COD) and as a result of the release of organic material, an improvement of digestion and subsequent dewatering was observed (Loeffler et al. 2001).

In contrast to conventional disintegration techniques such as thermal or ultrasound treatment or mechanical rupture, PEF-treatment causes a direct and efficient permeabilization of cell membranes within short processing times. An improved agglomeration and sludge separation and, as to be seen in Fig. 17, a 45% reduction of total suspended solids in the excess sludge was demonstrated by Koners et al. (2004) by using an energy input of 100 kJ/kg at 15 kV/cm, allowing a sludge retention time of 14 days.

Unlike microbial contamination of food products, which is aimed to be inactivated by PEF-treatment, the microbiota of sludge is much more diverse and optimization of PEF-treatment parameters would be required.



**Fig. 17** Cumulative total soluble solids (TSS) and energy input during a 2 month trial. PEF processing of 200 l of sludge at 5 l/hour, 15 kV/cm and 35°C. Retention time of 14 days (adapted from Toepfl 2006)

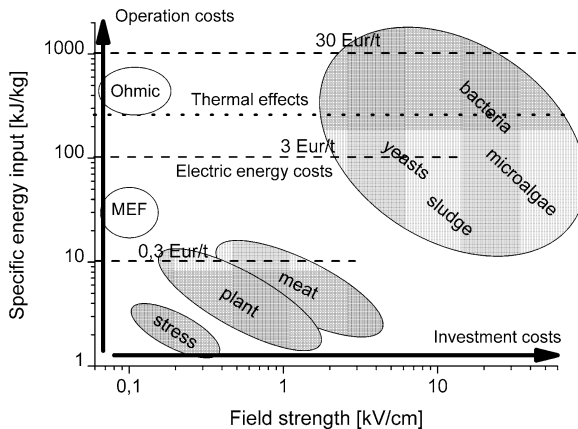
## 9 Energy Requirements and Cost-Effectiveness

Electric energy input and field strength need to be selected depending on the different applications and target organisms (Fig. 18). The desired level of cell permeabilization can range from a few percent of reversibly permeabilized cells (for the induction of stress response) to over 90% for the improvement of mass transfer in plant tissue and up to 8 log-cycles inactivation for a safe microbial decontamination.

The different processing intensity requirements determine the treatment costs. Field strength mainly influences the investment costs as it depends on the high-voltage power supply equipment. Energy input primarily determines the costs of operation as it requires a certain electric energy consumption

A higher field strength increases the total costs for realizing a certain specific energy input. For the disintegration of plant or animal tissue the energy efficiency of a PEF-treatment (2–20 kJ/kg) in comparison to a mild electric field (MEF) application (20–40 kJ/kg) can be seen. MEF applications, as described by Jemai and Vorobiev (2002) and Sensoy and Sastry (2004), is characterized as a process of controlled, possibly reversible permeabilization by electric fields from 1 V/cm to 1000 V/cm used to enhance diffusion coefficients of soluble substances from apple slices or improve the extraction from tea and mint leaves.

Exemplarily, a cost–benefit analysis for the increase of olive oil yield by the application of PEFs is shown in Table 2. Olive oil, in comparison with maize germ and rapeseed oil, gains a higher price on the market, and increase of oil yield has therefore a much higher financial benefit. The calculations show that PEF-equipment will amortize itself within 2 years for a given production capacity. The energy input for the decontamination of liquid food dependent on the processing



**Fig. 18** Required processing intensities for the induction of stress reactions, disintegration of plant or animal cells and microbial inactivation in comparison to a mild electric field (MEF)-treatment or ohmic heating. When exceeding an energy input of 250 kJ/kg, mainly thermal effects occur. Electric energy costs are based on a price of 10 ct/kW-hour (adapted from Toepfl 2006)

**Table 2** Cost–benefit analysis for the increase of olive oil yield by application of PEF. Estimated was a production capacity of 100 t/day during 3 months per year working 5 days a week. PEF-treatment was performed at 2 kV/cm and 60 pulses corresponding to a specific energy input of 3.4 kJ/kg (adapted from Guderjan 2006)

|   | Traditional oil production | PEF–pretreatment (1% increase of oil yield) |
|---|----------------------------|---|
| <b>Product specifications</b>               |                            |   |
| Oil content in olives (%)                   | 22                         |   |
| Oil yield (%)                               | 90                         | 91  |
| Oil per tonne germ (kg/t)                   |                            |   |
| <b>Processing capacity</b>                  |                            |   |
| Processing capacity (t/year)                | 6000                       |   |
| Oil t/year                                  | 1.188                      | 1.201                                       |
| <b>Costs</b>                                |                            |   |
| PEF investment costs (Euro)                 |                            | 100.000                                     |
| PEF energy consumption (kJ/kg oil)          |                            | 3,43  |
| Energy consumption kW-hour/t                |                            | 0,953                                       |
| Energy costs (Euro/t)                       |                            | 0,095                                       |
| Energy costs per year (Euro/year)           |                            | 571,67                                      |
| <b>Olive Oil selling prices</b> (Euro/t)    | 3.800                      |   |
| <b>Sales revenue</b> (Euro/year)            | 4.514.400                  | 4.564.560                                   |
| <b>Profit less energy costs</b> (Euro/year) |                            | <b>49.588</b>                               |

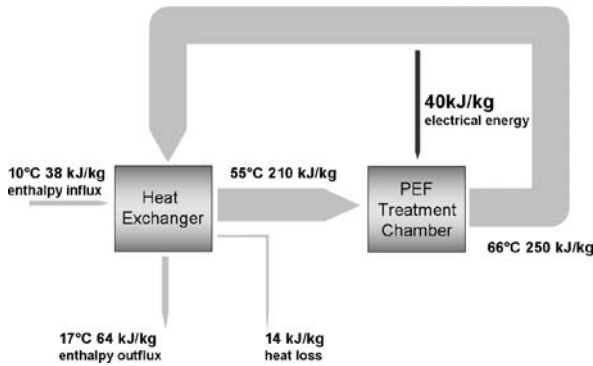
conditions was reported to be in the range of 300–1000 kJ/kg mainly due to the fact that intermediate cooling was applied to maintain treatment temperature at the ambient level. For a conventional thermal pasteurization of fruit juice, an energy input of 20 kJ/kg is sufficient due to heat recovery potential of up to 95%.

The strong synergetic effect of temperature and microbial inactivation by PEFs offers the possibility for an energetic optimization of an energy-intensive PEF decontamination process by using heat recovery so that an energy input of only 40 kJ/kg is needed.

An enthalpy diagram for the PEF process for the pasteurization of apple juice is shown in Fig. 19. To preheat the juice to a temperature of 55°C, the energy of the PEF-treated product is utilized in a heat exchanger and the treated product is cooled to 17°C. After a start-up phase, the pasteurization process can be operated by the input of electrical energy; no additional energy input is needed for heating and cooling.

The optimum process parameters have to be identified as PEF-treatment at lower temperature does not provide the possibility to recover the dissipated energy, since there is no need to preheat the product. Higher electric energy input is necessary to obtain sufficient inactivation, which results in high costs of operation needed to cool the product after treatment.

Pulse modulator typology and components, supplier as well as processing and product parameters lead to a wide range of investment costs obtained. Energy requirements for cell disintegration can be estimated to be in the range of 1–3 kW-hour/t and for preservation of liquid food, in the range of 30–50 kW-hour/t. The



**Fig. 19** Enthalpy diagramm of a suggested PEF-treatment system for apple juice with an initial temperature of 55°C and a specific energy input of 40 kJ/kg sufficient for a 6-log reduction of *E. coli*. As specific heat capacity 3.8 kJ/kgK was used, the heat loss in the heat exchanger was estimated for 5% (adapted from Heinz et al. 2003)

investment required for an installation of a 30 kW pulse generator based on a solid state typology providing rectangular bipolar pulses with a peak voltage up to 30 kV and repetition rates up to 1000 Hz is currently estimated to be in the range of 125.000 Euros, resulting in a treatment capacity of up to 10 t/hour for cell disintegration or 1t/hour for liquid media decontamination (Toepfl 2007).

Calculations do not include additional benefits due to the less detrimental impacts of PEF on product quality. Reduction of processing times by the implementation of PEF in the above-mentioned processes of meat treatment, the disintegration of plant tissue instead of enzymatic treatment with its potential to extract native structure pectin from the pomace or the accelerated drying of plant material have to be considered as well as increased yield of juice or oil containing higher contents of valuable compounds. Therefore, a further reduction of total costs seems obvious.

For an efficient PEF pasteurization of liquid food, the required treatment intensity is much higher in terms of electric field strength and energy input in comparison to those required for disintegration of plant or animal tissue . The use of electrical power is commonly connected to higher costs than energy derived by fuel or gas. If PEF-treatment at the ambient temperature is desired, the electric energy input required for microbial decontamination will have to be removed by active cooling, causing additional costs of operation and investment. These extra costs will have to be justified by sufficient margins or consumer benefits.

## 10 Future Aspects

The application of PEF in food processing has the potential for different applications. When operating at low electric field strength and energy input as in the case of plant or animal cell disintegration, the cost balance and the availability of pulse modulators with corresponding power are improved considerably. Application of



PEF provides a good potential to replace conventional cell disintegration techniques, and continuous application of short treatment durations makes PEF an attractive candidate as a novel nonthermal unit operation.

Highly valuable substances from plants used as health ingredients or for cosmetic application attract considerable interest. An increase of these substances by PEF-induced synthesis as a stress reaction and an enhanced extraction by the use of PEF for cell disintegration appear promising to promote the development of this technique.

For pasteurization application in the milk or juice industry, the margins appear too small to justify the replacement of thermal preservation. On the other hand, high-value products like enzyme or vitamin solutions or protein fractions isolated from milk, which are all very heat sensitive, are potential products for nonthermal pasteurization by PEF.

The combination of techniques that deliver effective preservation without the extreme use of any single technique is a major trend within the food industry. Therefore, the combination of PEF with other stress factors like mild heat, antimicrobial compounds, pH, or organic acids, as well as the combination with other nonthermal decontamination techniques like microfiltration, will determine further development.

The interactions between the product and PEF process and possible undesired changes still remain uncertain and for this reason the legislative situation in Europe still remains arguable as each new technology has to obtain authorization through the process set out in the Novel Food Regulation .

There are still some technological challenges especially in the case of PEF-pasteurization that have to be overcome prior to industrial exploitation. Optimization of the treatment chamber design and electrode geometry, which determines electric field distribution and flow pattern along with local deviations in field strength, residence time, and temperature gradients, is of special interest. Electrochemical reactions and electrode erosion have to be controlled to maintain chemical food safety.

At present, no experience on long-term reliability of the impulse generators as well as electrode lifetime and service and maintenance costs is available, and it remains challenging to convince potential users to invest in PEF technology.

## References

- Ade-Omowaye, B. I. O., Angersbach, A., Eshtiaghi, M. N., and Knorr, D. (2001a). "Impact of high intensity electric field pulses on cell permeabilisation and as pre-processing step in coconut pressing." *Innovative Food Science and Emerging Technologies*, 1, 203–209.
- Ade-Omowaye, B. I. O., Rastogi, N. K., Angersbach, A., and Knorr, D. (2001b). "Effects of high hydrostatic pressure or high intensity electrical field pulse pre-treatment on dehydration characteristics of red paprika." *Innovative Food Science and Emerging Technologies*, 2, 1–7.
- Allen, M., and Soike, K. (1967). "Disinfection by electrohydraulic treatment." *Science*, 156, 524–525.
- Angersbach, A., Heinz, V., and Knorr, D. (2000). "Effects of pulsed electric fields on cell membranes in real food systems." *Innovative Food Science and Emerging Technologies*, 1, 135–149.

- Angersbach, A., and Knorr, D. (1997). "Anwendung elektrischer Hochspannungsimpulse als Vorbehandlungsverfahren zur Beeinflussung der Trocknungscharakteristika und Rehydrations-eigenschaften von Kartoffelwürfeln." *Nahrung*, 41, 194–200.
- Anonymous. (1987). "Methods and apparatus for extending the shelf-life of fluid food products." Maxwell Laboratories, Inc., San Diego, U.S., U.S. patent 4695472.
- Ayhan, Z., Yeom, H. W., Zhang, Q. H., and Min, D. B. (2001). "Flavor, color and vitamin C retention of pulsed electric field processed orange juice in different packaging materials." *Journal of Agricultural Food Chemistry*, 49, 669–674.
- Ayhan, Z., Zhang, Q. H., and Min, D. B. (2002). "Effects of pulsed electric field processing and storage on the quality and stability of single-strength orange juice." *Journal of Food Protection*, 65(10), 1623–1627.
- Balasa, A., and Knorr, D. (2006). "Extraction of total phenolics from grapes in correlation with degree of membrane poration." *COST meeting 928-300606*, Reykjavik, Island.
- Balasa, A., Toepfl, S., and Knorr, D. (2006). "Influence of pulsed electric field treatment on total polyphenolic content of grape products." *Food factory of the future*, Gothenburg, Sweden.
- Bansal, B., and Chen, X. D. (2006). "A critical review of milk fouling in heat exchangers." *Comprehensive Reviews in Food Science and Food Safety*, 5, 27–33.
- Barbosa-Cánovas, G. V., and Altunakar, B. (2007). "Pulsed electric fields processing of foods: an overview." *Pulsed electric fields technology for the food industry*, J. Raso and V. Heinz, eds., Springer Verlag.
- Barbosa-Cánovas, G. V., Pothakamury, U. R., Palou, E., and Swanson, B. G. (1998). *Nonthermal preservation of foods*, Marcel Dekker, New York.
- Barsotti, L., Dumay, E., Mu, T. H., Fernandez Diaz, M. D., and Cheftel, J. C. (2001). "Effects of high voltage electric pulses on protein-based food constituents and structures." *Food Science & Technology*, 12, 136–144.
- Bazhal, M., Lebovka, N. I., and Vorobiev, E. (2001). "Pulsed electric field treatment of apple tissue during compression for juice extraction." *Journal of Food Engineering*, 50, 129–139.
- Bazhal, M., and Vorobiev, E. (2000). "Electrical treatment of apple cosettes for intensifying juice pressing." *Journal of the Science of Food and Agriculture*, 80, 1668–1674.
- Beattie, J. M., and Lewis, F. C. (1925). "The electric current (Apart from the Heat Generated). A Bacteriological Agent in the Sterilization of Milk and other fluids." *Journal of Hygiene*, 24, 123–137.
- Bendicho, S., Barbosa-Cánovas, G. V., and Martín, O. (2002). "Milk processing by high intensity pulsed electric fields." *Trends in Food Science & Technology*, 13, 195–204.
- Bendicho, S., Barbosa-Cánovas, G. V., and Martín, O. (2003). "Reduction of protease activity in simulated milk ultrafiltrate by continuous flow high intensity pulsed electric field treatments." *Journal of Food Science*, 68(3), 952–957.
- Bouzzara, H., and Vorobiev, E. (2000). "Beet Juice Extraction by pressing and pulsed electric fields." *International Sugar Journal*, 102(1216), 194–200.
- Braakman, L. (2003). "Breakthrough in pasteurisation – pulsed electric fields." *Food Engineering and Ingredients*, 1, 34–38.
- Calderon-Miranda, M. L., Barbosa-Cánovas, G. V., and Swanson, B. G. (1999). "Inactivation of *Listeria innocua* in skim milk by pulsed electric fields and nisin." *International Journal of Food Microbiology*, 51(1), 19–30.
- Castro, A. J., Swanson, B. G., Barbosa-Cánovas, G. V., and Zhang, Q. H. (2001). "Pulsed electric field modification of milk alkaline phosphatase activity." *Electric fields in food processing*, G. V. Barbosa-Cánovas and Q. H. Zhang, eds., Technomic, Lancaster, PA, 65–82.
- Clark, P. (2006). "Pulsed electric field processing." *Food Technology*, 60, 66–67.
- Cserhalmi, Z., Sass-Kiss, A., Toth-Markus, M., and Lechner, N. (2006). "Study of pulsed electric field treated citrus juices." *Innovative Food Science & Emerging Technologies*, 7(1–2), 49–54.
- Doenenburg, H., and Knorr, D. (1993). "Cellular permeabilisation of cultured plant tissue by high electric field pulses or ultra high pressure for the recovery of secondary metabolites." *Food Biotechnology*, 7(1), 35–48.

- Doevenspeck, H. (1960). "Verfahren und Vorrichtung zur Gewinnung der einzelnen Phasen aus dispersen Systemen." German Patent DE Germany, 1237-154.
- Doevenspeck, H. (1961). "Influencing cells and cell walls by electrostatic impulses." *Fleischwirtschaft*, 13(12), 968-987.
- Edebo, L., and Selin, I. (1968). "The effect of the pressure shock wave and some electrical quantities in the microbicidal effect of transient electric arcs in aqueous systems." *Journal of General Microbiology*, 50, 253-259.
- El-Belghiti, K., Rabhi, Z., and Vorobiev, E. (2005). "Kinetic model of sugar diffusion from sugar beet tissue treated by pulsed electric field." *Journal of the Science of Food and Agriculture*, 85, 213-218.
- Eshtiaghi, M. N., and Knorr, D. (1999). "Process for treatment of sugar beet." European Patent, WO99/6434.
- Eshtiaghi, M. N., and Knorr, D. (2000). "Anwendung elektrischer Hochspannungsimpulse zum Zellaufschluss bei der Saftgewinnung am Beispiel von Weintrauben." *LVT*, 45, 23-27.
- Evrendilek, G. A., Jin, Z. T., Ruhlman, K. T., Qiu, X., Zhang, Q. H., and Richter, E. R. (2000). "Microbial safety and shelf-life of apple juice and cider processed by bench and pilot scale PEF systems." *Innovative Food Science and Emerging Technologies*, 1, 77-86.
- Evrendilek, G. A., and Zhang, Q. H. (2003). "Effects of pH, temperature, and pre-pulsed electric field treatment on pulsed electric field and heat inactivation of *Escherichia coli* O157:H7." *Journal of Food Protection*, 66(5), 755-759.
- Evrendilek, G. A., Zhang, Q. H., and Richter, E. R. (2004). "Application of pulsed electric fields to Skim Milk inoculated with *Staphylococcus aureus*." *Biosystems Engineering*, 87(2), 137-144.
- FDA. (2003). "Genesis warning letter." Bothell, USA.
- Fetterman, J. C. (1928). "The electrical conductivity method of processing milk." *Agricultural Engineering*, 9(4), 107-108.
- Fincan, M., and Dejmeck, P. (2003). "Effect of osmotic pretreatment and pulsed electric field on the viscoelastic properties of potato tissue." *Journal of Food Engineering*, 59, 169-175.
- Fincan, M., DeVito, F., and Dejmeck, P. (2004). "Pulsed electric field treatment for solid-liquid extraction of red beetroot pigment." *Journal of Food Engineering*, 64, 381-388.
- Flaumenbaum, B. L. (1968). "Anwendung der Elektroplasmolyse bei der Herstellung von Fruchtsäften." *Flüssiges Obst*, 35, 19-22.
- Getchell, B. E. (1935). "Electric pasteurization of milk." *Agricultural Engineering*, 16(10), 408-410.
- Gilliland, S. E., and Speck, M. L. (1967a). "Inactivation of microorganisms by electrohydraulic shock." *Applied Microbiology*, 15(5), 1031-1037.
- Gilliland, S. E., and Speck, M. L. (1967b). "Mechanism of the bactericidal action produced by electrohydraulic shock." *Applied Microbiology*, 15(5), 1038-1044.
- Guderjan, M. (2006). "Untersuchungen zum Einfluss elektrischer Hochspannungsimpulse bei der Gewinnung pflanzlicher Öle." University of Technology, Berlin.
- Guderjan, M., Elez-Martínez, P., and Knorr, D. (2007). "Application of pulsed electric fields at oil yield and content of functional food ingredients at the production of rapeseed oil." *Innovative Food Science & Emerging Technologies*, 8, 55-68.
- Guderjan, M., and Knorr, D. (2005). "Application of pulsed electric fields for the development of a gentle processing concept for the recovery of oils of plant origin." *DFG Projekttreffen Fette und Lipide in der Ernährung*, Freudenstadt, Germany.
- Guderjan, M., Toepfl, S., Angersbach, A., and Knorr, D. (2005). "Impact of pulsed electric field treatment on the recovery and quality of plant oils." *Journal of Food Engineering*, 67(3), 281-287.
- Gudmundsson, M., and Hafsteinsson, H. (2001). "Effect of electric field pulses on microstructure of muscle foods and roes." *Food Science & Technology*, 12, 122-128.
- Hafsteinsson, H., Gudmundsson, M., Arnarson, G. Ö., Jónsson, Á., and Siguroardottir, M. S. (2000). "High electric field pulses: food safety; quality; and critical parameters." Project report. European project FAIR CT97-3044.

- Heinz, V., Toepfl, S., and Knorr, D. (2003). "Impact of temperature on lethality and energy efficiency of apple juice pasteurization by pulsed electric fields treatment." *Innovative Food Science and Emerging Technologies*, 4(2), 167–175.
- Hodgins, A. M., Mittal, G. S., and Griffiths, M. W. (2002). "Pasteurization of fresh orange juice using low-energy pulsed electrical field." *Journal of Food Science*, 67(6), 2294–2299.
- Jaeger, H. (2006). "Einfluss von gepulsten elektrischen Feldern auf die Aktivität von Enzymen und die Inaktivierung ausgewählter Mikroorganismen in Milch." Diploma thesis, University of Technology, Berlin.
- Janositz, A. (2005). "Auswirkung von Hochspannungsimpulsen auf das Schnittverhalten von Kartoffeln." Diploma thesis, University of Technology, Berlin.
- Jayaram, S., Castle, G. S. P., and Magaritis, A. (1992). "Kinetics of sterilization of *L. brevis* cells by the application of high voltage pulses." *Biotechnology and Bioengineering*, 40(11), 1412–1420.
- Jemai, A. B., and Vorobiev, E. (2002). "Effect of moderate electric field pulses on the diffusion coefficient of soluble substances from apple slices." *International Journal of Food Science and Technology*, 37, 73–86.
- Jemai, A. B., and Vorobiev, E. (2006). "Pulsed electric field assisted pressing of sugar beet slices: towards a novel process of cold juice extraction." *Biosystems Engineering*, 93(1), 57–68.
- Jeyamkondan, S., Jayas, D. S., and Holley, R. A. (1999). "Pulsed electric field processing of foods: a review." *Journal of Food Protection*, 62(9), 1088–1096.
- Knorr, D., and Angersbach, A. (1998). "Impact of high-intensity electric field pulses on plant membrane permeabilization." *Trends in Food Science & Technology*, 9, 185–191.
- Knorr, D., Geulen, M., Grahl, T., and Sitzmann, W. (1994). "Food application of high electric field pulses." *Trends in Food Science and Technology*, 5, 71–75.
- Koehler, E., Toepfl, S., Knorr, D., and Pulz, O. (2005). "Unconventional procedures for the production and stabilization of extracts with active agents." *6th European workshop microalgal biotechnology*, Potsdam, Germany.
- Koners, U., Toepfl, S., Heinz, V., Camacho, P., Ginestet, P., and Knorr, D. (2004). "Application of Pulsed Electric Field Treatment for sludge reduction on waste water treatment plants." *2nd European pulsed power symposium*, Hamburg, Germany, 68–72.
- Kopplov, O., Barjenbruch, M., and Heinz, V. (2004). "Sludge pre-treatment with pulsed electric fields." *Water Science and Technology*, 49(10), 123–129.
- Kraus, W. (2003). "The 2002 beet campaign – VDZ Zweigverein Süd." *Zuckerindustrie*, 128(5), 344–354.
- Kraus, W. (2004). "Reports on the 2003 campaign – VDZ Zweigverein Süd." *Zuckerindustrie*, 129(5), 349–363.
- Krupp Maschinentechnik. (1988). "Fish processing by the Elcrack process." *Brochure Krupp Maschinentechnik GmbH*, Hamburg, Germany.
- Lebovka, N. I., Praporscic, I., and Vorobiev, E. (2004a). "Combined treatment of apples by pulsed electric fields and by heating at moderate temperature." *Journal of Food Engineering*, 65, 211–217.
- Lebovka, N. I., Praporscic, I., and Vorobiev, E. (2004b). "Effect of moderate thermal and pulsed electric field treatments on textural properties of carrots, potatoes and apples." *Innovative Food Science and Emerging Technologies*, 5(1), 9–16.
- Lechner, N., and Cserhalmi, Z. (2004). "Pulsed electric field (PEF) processing effects on physical and chemical properties of vegetable juices." *Safe consortium seminar: novel preservation technologies in relation to food safety*, Brussel, Belgium.
- Li, S.-Q., Bomser, J. A., and Zhang, Q. H. (2005). "Effects of pulsed electric fields and heat treatment on stability and secondary structure of bovine immunoglobulin G." *Journal of Agriculture & Food Chemistry*, 53(3), 663–670.
- Li, S.-Q., Zhang, Q. H., Lee, Y.-Z., and Pham, Z.-V. (2003). "Effects of pulsed electric fields and thermal processing on the stability of bovine Immunoglobulin G (IgG) in enriched soymilk." *Food Chemistry and Toxicology*, 68(4), 1201–1207.

- Li, S. Q., Zhang, Q. H., Tony, Z. J., Turek, E. J., and Lau, M. H. (2005). "Elimination of *Lactobacillus plantarum* and achievement of shelf stable model salad dressing by pilot scale pulsed electric fields combined with mild heat." *Innovative Food Science & Emerging Technologies*, 6, 125–133.
- Loeffler, M., Schmidt, W., Schuhmann, R., Röttering, A., Neumann, J., and Dreesen, C. (2001). "Treatment of sewage sludge with pulsed electric fields." *International conference on pulsed power applications*, Gelsenkirchen, Germany.
- Mastwijk, H. (2004). "Recent developments in pulsed electrical field treatment in relation to food safety." *Safe consortium seminar: novel preservation technologies in relation to food safety*, Brussels, Belgium.
- McDonald, C. J., Lloyd, S. W., Vitale, M. A., Petersson, K., and Innings, F. (2000). "Effect of pulsed electric fields on microorganisms in orange juice using electric field strengths of 30 and 50 kV/cm." *Journal of Food Science*, 65(6), 984–989.
- McLellan, M. R., Kime, R. L., and Lind, K. R. (1991). "Electroplasmolysis and other treatments to improve apple juice yield." *Journal of Science of Food and Agriculture*, 57(2), 303–306.
- Min, S., and Zhang, Q. H. (2003). "Effects of commercial-scale pulsed electric field processing on flavor and color of tomato juice." *Journal of Food Science*, 65(5), 1600–1606.
- Mitchell, C. A. (1996). "Recent advances in plant response to mechanical stress: theory and application." *Horticultural Science*, 31(1), 31–35.
- Molinari, P., Pilosof, A. M. R., and Jagus, R. J. (2004). "Effect of growth phase and inoculum size on the inactivation of *S. cerevisiae* in fruit juices by pulsed electric fields." *Food Research International*, 37(8), 793–798.
- Morren, J., Roodenburg, B., and de Haan, S. W. H. (2003). "Electrochemical reactions and electrode corrosion in pulsed electric field (PEF) treatment chambers." *Innovative Food Science and Emerging Technologies*, 4(3), 285–295.
- Moses, B. D. (1938). "Electric pasteurization of milk." *Agricultural Engineering*, 19(12), 525–526.
- Perez, O., and Pilosof, A. M. R. (2004). "Pulsed electric field effects on the molecular structure and gelation of  $\beta$ -lactoglobulin concentrate and egg white." *Food Research International*, 37, 102–110.
- Picart, L., Dumay, E., and Cheftel, C. (2002). "Inactivation of *Listeria innocua* in dairy fluids by pulsed electric fields: influence of electric parameters and food composition." *Innovative Food Science & Emerging Technologies*, 3, 357–369.
- Praporscic, I., Lebovka, N. I., Vorobiev, E., and Mietton-Peuchot, M. (2007). "Pulsed electric field enhanced expression and juice quality of white grapes." *Separation and Purification Technology*, 52, 520–526.
- Prochownick, L., and Spaeth, F. (1890). "Über die keimtötende Wirkung des galvanischen Stroms." *Deutsche Medizinische Wochenschrift*, 26, 564–565.
- Rastogi, N. K., Eshtiaghi, M. N., and Knorr, D. (1999). "Accelerated mass transfer during osmotic dehydration of high intensity electrical field pulse pretreated carrots." *Journal of Food Science*, 64(6), 1020–1023.
- Reina, L. D., Jin, Z. T., Zhang, Q. H., and Yousef, A. E. (1998). "Inactivation of *Listeria monocytogenes* in milk by pulsed electric field." *Journal of Food Protection*, 61(1203–1206).
- Roodenburg, B., Morren, J., Berg, H. E. I., and de Haan, S. W. H. (2005a). "Metal release in a stainless steel Pulsed Electric Field (PEF) system: Part I. Effect of different pulse shapes; theory and experimental method." *Innovative Food Science & Emerging Technologies*, 6(3), 327–336.
- Roodenburg, B., Morren, J., Berg, H. E. I., and de Haan, S. W. H. (2005b). "Metal release in a stainless steel pulsed electric field (PEF) system: Part II. The treatment of orange juice; related to legislation and treatment chamber lifetime." *Innovative Food Science & Emerging Technologies*, 6(3), 337–345.
- Sale, A. J. H., and Hamilton, W. A. (1967). "Effect of high electric fields on micro-organisms. I. Killing of bacteria and yeast. II. Mechanism of action of the lethal effect." *Biochimica Biophysica Acta*, 148, 781–800.

- Sale, A. J. H., and Hamilton, W. A. (1968). "Effects of high electric fields on microorganisms. III. Lysis of erythrocytes and protoplasts." *Biochimica Biophysica Acta*, 163, 37–43.
- Sampedro, F., Rodrigo, M., Martínez, A., Rodrigo, D., and Barbosa-Cánovas, G. V. (2005). "Quality and safety aspects of PEF application in milk and milk products." *Critical Reviews in Food Science and Nutrition*, 45, 25–47.
- Schilling, S., Alber, T., Toepfl, S., Neidhart, S., Knorr, D., Schieber, A., and Carle, R. (2007). "Effects of pulsed electric field treatment of apple mash on juice yield and quality attributes of apple juices." *Innovative Food Science & Emerging Technologies*, 8, 127–134.
- Schultheiss, C., Bluhm, H. J., Mayer, H. G., Kern, M., Michelberger, T., and Witte, G. (2002). "Processing of sugar beets with pulsed electric fields." *IEEE Transactions on Plasma Science*, 30(4), 1547–1551.
- Schultheiss, C., Bluhm, H. J., Sack, M., and Kern, M. (2004). "Principle of electroporation and development of industrial devices." *Zuckerindustrie*, 129(1), 40–44.
- Schuten, H., Gulfo-van Beusekom, K., Pol, I., Mastwijk, H., and Bartels, P. (2004). "Enzymatic stability of PEF processed orange juice." *Safe consortium seminar: novel preservation technologies in relation to food safety*, Brussels, Belgium.
- Sensoy, I., and Sastry, S. K. (2004). "Extraction using moderate electric fields." *Journal of Food Science*, 69(1), 7–13.
- Sepulveda, D. D., Góngora-Nieto, M. M., Guerrero, J. A., and Barbosa-Cánovas, G. V. (2005). "Production of extended shelf-life milk by processing pasteurized milk with pulsed electric fields." *Journal of Food Engineering*, 67, 81–86.
- Sitzmann, W., and Münch, E. W. (1988). "Das ELCRACK Verfahren: Ein neues Verfahren zur Verarbeitung tierischer Rohstoffe." *Die Fleischmehlindustrie*, 40(2), 22–28.
- Smith, K., Mittal, G. S., and Griffiths, M. W. (2002). "Pasteurization of milk using pulsed electrical field and antimicrobials." *Journal of Food Science*, 67(6).
- Stanley, D. W. (1991). "Biological membrane deterioration and associated quality losses in food tissues." *Critical reviews in food science and nutrition*, F. M. Clydesdale, ed., CRC Press, New York.
- Tedjo, W., Eshtiaghi, M. N., and Knorr, D. (2002). "Einsatz nicht thermischer Verfahren zur Zell-Permeabilisierung von Weintrauben und Gewinnung von Inhaltsstoffen." *Flüssiges Obst*, 9, 578–583.
- Thiele, H., and Wolf, K. (1899). "Über die Einwirkung des elektrischen Stroms auf Bakterien." *Centralblatt Bakterien und Parasitenkunde.*, 25, 650–655.
- Toepfl, S. (2006). "Pulsed Electric Fields (PEF) for permeabilization of cell membranes in food- and bioprocessing – applications, process and equipment design and cost analysis," PhD., University of Technology, Berlin.
- Toepfl, S. (2007). "Design concepts for PEF-applications for the food industry." German Institute of Food Technology, Quakenbrück, Personal Communication.
- Toepfl, S., and Heinz, V. (2007). "Application of pulsed electric fields to improve mass transfer in dry cured meat products." *Fleischwirtschaft International*, 22(1/2007), 62–64.
- Toepfl, S., Heinz, V., and Knorr, D. (2005). "Anwendung gepulster elektrischer Felder als Zellaufschluss- und Konservierungsverfahren." *GDL Kongress Lebensmitteltechnologie*, Dresden.
- Toepfl, S., Heinz, V., and Knorr, D. (2007a). "High intensity pulsed electric fields applied for food preservation." *Chemical Engineering and Processing*, 46(6), 537–546.
- Toepfl, S., Heinz, V., and Knorr, D. (2007b). "History of pulsed electric field treatment." *Food preservation by pulsed electric fields*, H. L. M. Lelieveld, S. Notermans, and S. W. H. de Haan, eds., Woodhead Publishing Limited, Cambridge.
- Toepfl, S., Jaeger, H., Heinz, V., and Knorr, D. (2006). "Neues Verfahren zur Haltbarmachung von Milch." *Deutsche Molkerei Zeitung*, 2, 24–28.
- Tracy, R. L. (1932). "Lethal effect of alternating current on yeast cells." *Journal of Bacteriology*, 24(6), 423–438.

- Ulmer, H. M., Heinz, V., Gaenzle, M. G., Knorr, D., and Vogel, R. F. (2002). "Effects of pulsed electric fields on inactivation and metabolic activity of *Lactobacillus plantarum* in model beer." *Journal of Applied Microbiology*, 93(2), 326–335.
- Van Loey, A., Verachert, B., and Hendrickx, M. (2002). "Effects of high electric field pulses on enzymes." *Trends in Food Science and Technology*, 12, 94–102.
- Yang, R. J., Li, S. Q., and Zhang, Q. H. (2004). "Effects of pulsed electric fields on the activity of enzymes in aqueous solution." *Journal of Food Science*, 69(4), 241–248.
- Yeom, H. W., Streaker, C. B., Zhang, Q. H., and Min, D. B. (2000). "Effects of pulsed electric fields on the quality of orange juice and comparison with heat pasteurization." *Journal of Agricultural Food Chemistry*, 48, 4597–4605.
- Zárate-Rodríguez, E., and Ortega-Rivas, E. (2000). "Quality changes in apple juice as related to nonthermal processing." *Journal of Food Quality*, 23, 337–349.
- Zhang, Q., Monsalve-González, A., Qin, B. L., Barbosa-Cánovas, G. V., and Swanson, B. G. (1994). "Inactivation of *Saccharomyces cerevisiae* in apple juice by square-wave and exponential-decay pulsed electric fields." *Journal of Food Process Engineering*, 17, 469–478.

# Application of High-Voltage Electrical Discharges for the Aqueous Extraction from Oilseeds and Other Plants

Cécile Grémy-Gros, Jean-Louis Lanoisellé, and Eugène Vorobiev

**Abstract** Aqueous extraction is a traditional operation unit used to recover from food plants various products such as sugar, oil, or proteins. The yields of extraction are generally low. To enhance aqueous extraction different treatments may be applied before and/or during extraction. Application of high-voltage electrical discharges in water leads to original phenomena such as shock waves or active species creation. Steps of creation and required material are presented. High-voltage electrical discharges in water are interesting for different applications especially for extraction.

## 1 Introduction

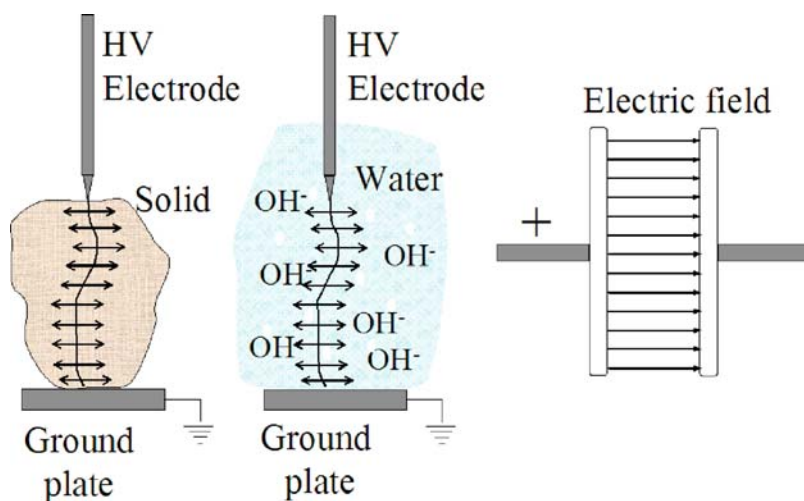
The electrotechnology called high-voltage electrical discharges (HVED), which is presented in this chapter, is used in aqueous solutions in order to extract oil and soluble material from plant products. Basically, HVED can be divided into three categories (Fig. 1): (i) arc discharge through the interior of solid material; (ii) underwater arc discharge, which can initiate a strong pressure pulse and produce significant oxidative chemistry in the bulk liquid resulting from UV-photolysis, electrohydraulic cavitation, and supercritical water oxidation; (iii) electrolytic discharge, which can establish and maintain a strong electric field in a treatment chamber for a few microseconds but will avoid heating and electrical breakdown.

When electrical treatment is applied in an aqueous solution, different phenomena are observed during HVED, depending on electric field intensity. If the electric field is of low intensity, water carries electricity and behaves like a good electrical conductor. Electrical signals look like simple exponential decreases (Fig. 2) (Sun et al. 1997) such as signals observed in wet solid electrical treatment. When the electric field overshoots the breakdown electric field, a new phenomenon involving this electrical breakdown is observed. Electric current goes through water, which behaves like an insulating material, and produces shock waves, ultraviolet

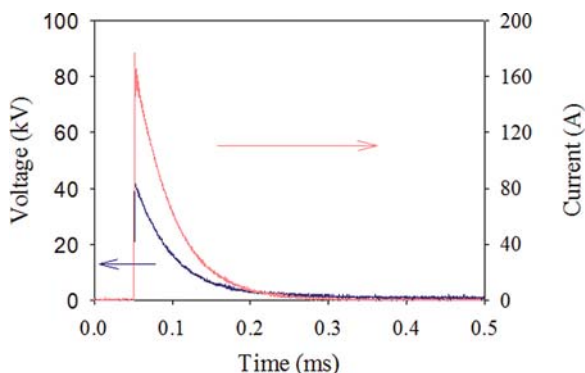
---

C. Grémy-Gros  
Université d'Angers, ISTIA, LASQUO, UPRES EA 3858  
e-mail: cecile.gros@istia.univ-angers.fr





**Fig. 1** Categories of electric discharges: arc discharge through solid (*left*), liquid (*center*), electrolytic discharge (*right*) (adapted from Bluhm et al. 2001)



**Fig. 2** Typical voltage and current curves in absence of electrical breakdown (Gros 2005)

radiations, and active species (Naugol'nykh and Roi 1971; Sun et al. 1998). Then, the electrical signals look like damped oscillations (Sun et al. 1998; Zuckerman et al. 2002; Gros et al. 2004). The application of HVED produces such phenomena. In fact, classical discharge, which mainly depends on electrical conductivity of the aqueous solution and creation of electrical breakdown, can be in competition.

Lightning is the first electrical breakdown observed by humans. The electric origin of this natural phenomenon was discovered by Benjamin Franklin in 1753. The first artificial electrical breakdown was produced by Humphry Davy towards 1800 (Hnatiuc 2002). This is the beginning of intense activity in research and in the application of electrical discharge. In 1905, Swedbery found that a pulsed discharge in water can produce an intense shock wave (Lu et al. 2001). The study of electrical

breakdowns leads to the identification of their main characteristics, namely, their huge complexity, the influence of many factors, and the variety of their forms (electrical breakdown, corona discharge, streamer, lightning, etc.). Even after two centuries of research and about 20 major theories, many aspects of this phenomenon stay unappreciated. Many authors have tried to explain the formation of electrical breakdown in liquids, mainly water (Naugol'nykh and Roi 1971; Katsuki et al. 2002).

Extraction is an essential operation for industries that treat biological materials. Many technologies have been developed for this operation. Extraction may be done by pressure (screw press, hydraulic press (Beckett 1999), belt press, etc.) or by a solvent, for example, hexane (Abu-Arabi et al. 2000), supercritical CO<sub>2</sub> (Bozan and Temelli 2002), or water. The transfer of solute from biological solids to an adjacent liquid is a traditional unit operation in different food applications. It is used to obtain various products such as sugar, coffee, tea, and pectin. To enhance aqueous extraction different treatments (mechanical, biological, thermal, electrical (El-Belghiti et al. 2005)) may be applied before and/or during extraction.

Concerning oilseeds, aqueous extraction may be mainly used to recover oil and/or soluble products such as proteins (Lopes Barbosa et al. 2006), gums, and mucilage (flaxseed, mustard). Aqueous extraction may be the central operation or a part of the process. Indeed, different types of product can be treated: whole or crushed seed, press-cake, and defatted cake.

A seed is considered as oilseed if it is grown largely for oil. The major oilseeds produced in 2005 (FAO 2005; United States Department of Agriculture 2007) are soybean (217.9 Mt), rapeseed (48.6 Mt), cottonseed (42.5 Mt), peanut/groundnut (33.9 Mt), sunflower seed (29.7 Mt), palm kernel (10 Mt), copra/coconut (5.6 Mt), sesame seed (3.2 Mt), flaxseed/linseed (1.8 Mt), and castor seed (1.3 Mt in 2003).

The treatment of whole oilseeds (e.g., flaxseed (Cui et al. 1994) and white mustard (Balke and Diosady 2000)) with aqueous extraction is usually used to extract mucilage that is present in the hull of seeds. Mucilage is a heterogeneous polysaccharide which has interesting properties and may have applications in food industry. There are many different methods of aqueous mucilage extraction. Some authors have tested the hot extraction from flaxseed (Mazza and Biliaderis 1989; Bhatti 1993; Cui et al. 1994). Optimum conditions have been determined by experimental design: temperature of 85–90°C, pH 6.5–7.0, and 13/1 water/seed ratio (Cui et al. 1994). Others have soaked whole seeds in water or sodium bicarbonate solutions (0.05 and 0.10 M for 6 and 12 hours) and have used polysaccharide degrading enzymes (Wanasundara and Shahidi 1997). On white mustard seeds, two-stage extraction process using water with an initial temperature of 45°C at an 8/1 water/seed ratio resulted in over 90% mucilage removal in approximately 3 hours (Balke and Diosady 2000). The authors also show the existence of two steps in mucilage extraction: first hydration of the seed and mucilage, then dissolution of mucilage.

The aqueous extraction of oil is an interesting alternative to solvent extraction due to simultaneous recovery of protein and oil, the better quality of oil, and the absence of volatile organic compounds emission (Rosenthal et al. 1996). But aqueous extraction has also some disadvantages: lower oil yield, high water consumption, and the

addition of demulsification operation. Sometimes this problem of low extraction efficiency of aqueous processes can be overcome by optimization of process parameters (pH, temperature, time, water/seed ratio, agitation, number of treatments, etc.) or by the use of hydrolytic enzymes (Tano-Debrah and Ohta 1997; Sharma et al. 2002).

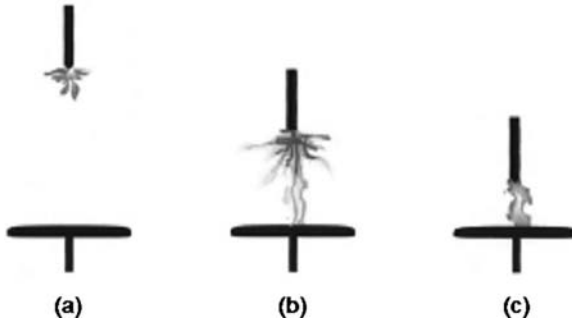
The aqueous extraction process of oil is generally composed of three main stages:

- Firstly, the crushed product is dispersed in water. The crushing stage is crucial for aqueous extraction. It induces the particles reduction and structure modifications; this facilitates the oil output (Southwell and Harris 1992). However, an excessive crushing leads to stable emulsion formation when the product is dispersed in water. Indeed, smaller oil drops are obtained and demulsification becomes more difficult (Aguilera et al. 1983). Concerning the water/seed ratio, the lowest values seem preferable to obtain less stable emulsions and generate less effluent to treat. But higher water/seed ratios are required to achieve better oil yield. The optimal water/seed ratio depends on the type of treated product.
- Secondly, the aqueous mixture is agitated to enhance oil and proteins extraction. Whereas a simple agitation is needed to obtain high oil yield for groundnut and sunflower, greater energies are needed to have an efficient extraction for other seeds. For each product, an optimal value of pH exists for oil extraction (Kim 1989; Southwell and Harris 1992). This value corresponds also to the optimum of protein extraction: a strong correlation seems to exist between protein and oil extraction. Moreover, weakest yields of extraction for oil and proteins are obtained for the isoelectric pH, which corresponds to the minimum solubility of proteins. Thus, aqueous extraction may be considered as an operation of protein solubilization which involves oil extraction. The temperature of extraction seems to have a complex effect on oil extraction. The optimal duration of extraction depends on treated product. The increase of the duration leads to the production of more stable emulsion.
- Thirdly, this separation stage is performed to recover oil and proteins.

Different physical treatments as ultrasounds, microwave heating, instantaneous pressure drop, etc., can be used to increase extraction yields. This chapter focuses on the application of HVED for the enhancement of aqueous extraction from oilseeds.

## 2 High-Voltage Electrical Discharges

The steps of creation of HVEDs are explained below. The HVED have already different applications such as degradation of organic compounds contained in water (Sugiarto and Sato 2001), microorganism inactivation (Zuckerman et al. 2002), or extraction of soluble material (Vishkvaztzev et al. 1998; Barskaya et al. 2000).



**Fig. 3** Type of electric discharge in aqueous solution. (a) streamer,  $E = 4.4$  kV/cm; (b) streamer and spark,  $E = 13.3$  kV/cm; (c) spark,  $E = 33.3$  kV/cm (Sugiarto and Sato 2001)

## 2.1 Steps of Creation

The application of high voltage across the electrodes leads to accelerate the electrons that achieve enough energy to excite water molecules. Then an avalanche of electrons is created. Air bubbles, which are initially presented in liquid or formed thanks to local heating, participate and accelerate the phenomenon (Alkimov et al. 1971).

If electric field is intense enough, avalanche of electrons becomes the starting point of streamer propagation from the positive electrode to the negative one (Fig. 3). Lots of active molecules are produced inside of streamers under action of excited electrons (Joshi et al. 1995; Sun et al. 1998).

When one of the streamers reaches negative electrode, electrical breakdown occurs and discharge channel is created. This leads to the increase of arc diameter, current increase, and voltage decrease. This discharge channel, which is also called leader, is characterized by a plasma with high conductivity due to the large plasma electron temperature and density. Also, the large plasma density and temperature gradients, together with the nonelastic properties of the liquid, lead to the formation of shock waves (Vitkovitsky 1997; Zuckerman et al. 2002). In addition to the shock wave formation, ultraviolet radiations and active species are produced (Sun et al. 1998).

All these steps of arc creation may be interesting for comprehension of such a technology, but a question is still there: how can we produce electrical breakdown in water?

## 2.2 Condition of Apparition

In order to obtain electrical breakdown between two electrodes, the value of applied electric field  $E$  (V/m) must exceed the breakdown electric field  $E_{br}$ . Different formulas are used to calculate  $E$  according to electrodes geometry (Burkes 1978). For needle/plate electrode, electric field is calculated with the following formula:

$$E = 0.9 \cdot \left(\frac{U}{l}\right) \cdot \frac{r+l}{r} \tag{1}$$

where  $U$  is the applied voltage (V),  $r$  is the electrode radius (m) and  $l$  is the distance between electrodes (m).

The value of  $E_{br}$  (V/m) can be estimated from the next semiempirical formula (Martin 1973):

$$E_{br} = k \cdot S^{-0.1} \cdot t_{eff}^{-1/3} \tag{2}$$

where  $k$  is a constant ( $V \cdot s^{1/3} \cdot m^{-0.8}$ ),  $S$  is the area of the electrode ( $m^2$ ) and  $t_{eff}$  is the effective time of the applied voltage (s), that is, the duration between voltage application and leader creation while voltage is almost constant.

### 2.3 Material and Energy

The production of electrical breakdown in water requires a generator with a huge capacitor. In Figs. 4 and 5 an example of generator and chamber of treatment used to produce HVED for extraction is presented. Some characteristics of electrical circuits of laboratory-scale HVED generators are presented in Table 1.

The energy is initially contained in the capacitor. A huge quantity of energy is needed to create the electrical breakdown in water. This energy is considered as losses of energy. Authors have managed to determine different origins of energy losses for HVED treatment in water (Yushkov 2004). The losses of energy  $W_L$  in the pre-breakdown stage of discharge buildup can be represented in the following form:

$$W_L = W_1 + W_2 + W_3 \tag{3}$$

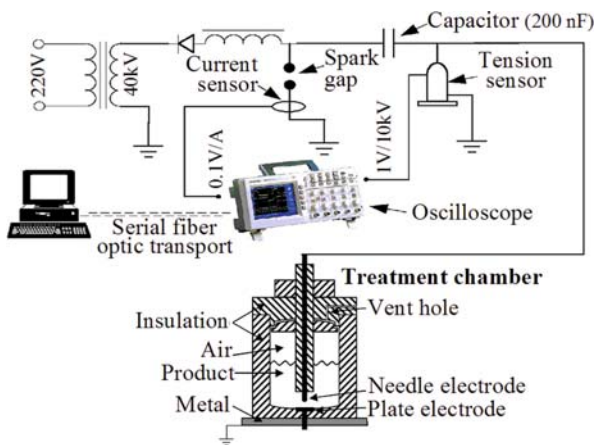


Fig. 4 Schema of a HVED generator (Gros et al. 2004)

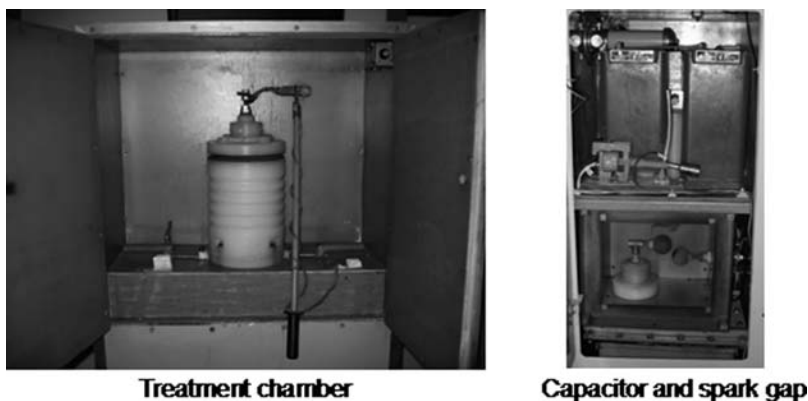


Fig. 5 Generator of HVED (Gros 2005)

Table 1 Characteristics of electrical circuits of laboratory scale HVED generators

| Energy $W$ (J) | Capacitor $C$ ( $\mu\text{F}$ ) | Inductance $L$ ( $\mu\text{H}$ ) | Distance between electrodes $l$ (mm) | Reference            |
|----------------|---------------------------------|----------------------------------|--------------------------------------|----------------------|
| 200            | 0.01                            | 15–200                           | 13–50                                | Barskaya et al. 2000 |
| 160            | 0.2                             | 1.15                             | 5                                    | Gros et al. 2004     |

where  $W_1$  is the energy losses with the formation of overheated instability in the zone of potential electrode due to the flow of ion currents from this electrode;  $W_2$  is the energy losses with formation and development of leaders in the working space;  $W_3$  is the energy losses due to spreading of currents from the surface of the bare part of the potential electrode and surface of leaders. Yushkov (2004) has shown that the energy losses are not negligible; they can achieve up to 50% of the energy contained in the capacitor.

With the experimental equipment presented in Fig. 4, Gros et al. (2004) have treated a suspension of linseed press-cake in a long time experiment (2,500 pulses)

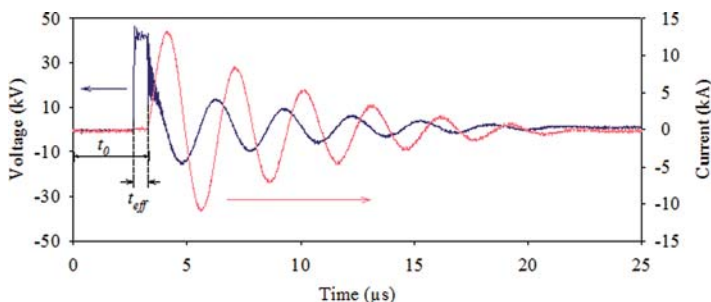
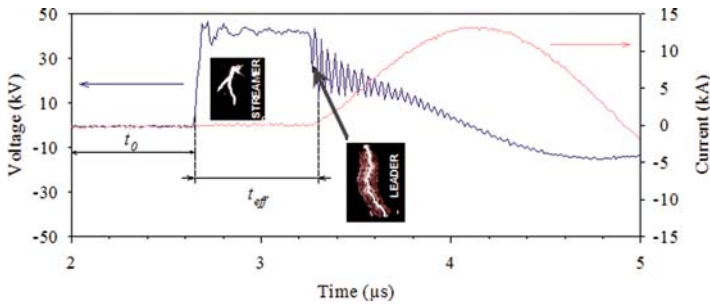


Fig. 6 Typical voltage and current curves measured during a HVED with a 5 mm interelectrode distance.  $t_{\text{eff}}$  : effective time of the applied voltage  $\approx 0.5 \mu\text{s}$ ;  $t_0$ : duration between the measure beginning and the creation of the discharge channel (Gros et al. 2004)



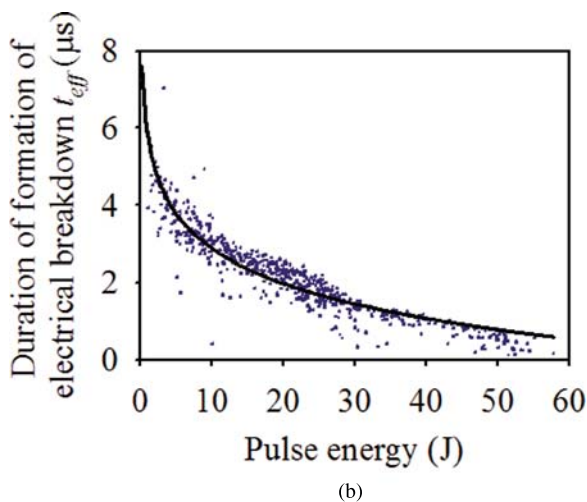
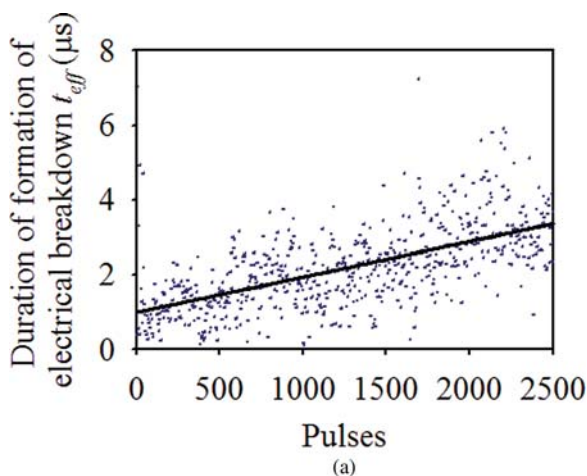
**Fig. 7** Typical voltage and current curves measured at the beginning of HVED with a 5 mm interelectrode distance (photographs: Sun et al. 1998)

and recorded electrical signals (Figs. 6 and 7). They determined the duration of electrical breakdown formation  $t_{\text{eff}}$ , the electrical characteristics associated to the damped oscillations and the energy consumed during these oscillations. The values of  $t_{\text{eff}}$  increase during the experiment (Fig. 8a). This is explained by the increase of electrical conductivity of the treated mixture during experiment. This also means that energy losses becomes higher during formation of electrical breakdown: the pulse energy decreases with the increase of  $t_{\text{eff}}$  (Fig. 8b).

## 2.4 Interest in HVED for Various Applications

An electrical breakdown in water has many applications because of various effects that can be produced: ultraviolet radiations, active species (Sun et al. 1998), and shock waves (Vitkovitsky 1997).

These secondary effects can be used, for example, for water ozonation. The application of electrical breakdown leads to bubbles division and improves treatment efficiency. The creation of active substances, involves destruction of polluting substances and microorganisms (Malik et al. 2001). The application of HVED permits the degradation of pollutants such as phenol (Sugiarto and Sato 2001; Chen et al. 2004), the decoloration of dyes (Sugiarto et al. 2003) and inactivation of microorganisms (Zuckerman et al. 2002). Electrical breakdown in water can also be of interest for the effects of associated shock waves. Mikula et al. 1997 have used discharges ( $U = 40$  kV,  $I_{\text{max}} = 45$  kA,  $C = 0.50$   $\mu\text{F}$ ,  $L = 1.4$   $\mu\text{H}$ ,  $l = 7$  mm) to treat water suspensions of  $\text{TiO}_2$  or wood (sawdust, needles) and water solution of methylhydroxyethylcellulose. Shock waves crush  $\text{TiO}_2$  particles: their average diameter decreases and suspension turbidity is modified. In fact,  $\text{TiO}_2$  aggregates, which are spontaneously formed in water, are broken thanks to shock waves. In the case of beech sawdust, the rate of acid hydrolysis increases with the number of discharge pulses. These changes have been interpreted as the result of physical destruction of the materials, for example, increasing of specific surface area of the treated materials. The viscosity of the solution of methylhydroxyethylcellulose slowly decreased with application of pulses but the molecular weight of the polymer



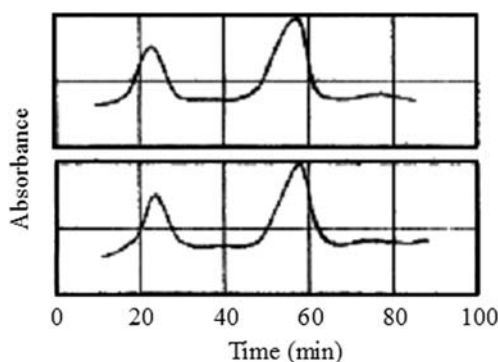
**Fig. 8** Evolution of the duration of electrical breakdown formation  $t_{\text{eff}}$  during a 2,500 pulses experiment (a). Relation between  $t_{\text{eff}}$  and the energy consumed after electrical breakdown (b) (Gros et al. 2004)

changed only slightly. The treatment of spruce needles improves their wettability and thus the contact with microorganisms (Mikula et al. 1997). Apparatuses were also developed to split up rocks (Wesley and Ayres 1984).

### 3 Extraction Enhanced by HVED

HVED treatments may also be interesting to enhance aqueous extraction. The effects of classical aqueous extraction and HVED are combined.





**Fig. 9** HPLC profiles of soymilk produced with classical extraction and extraction enhanced by HVED (wavelength = 280 nm) (Vishkvatzev et al. 1998)

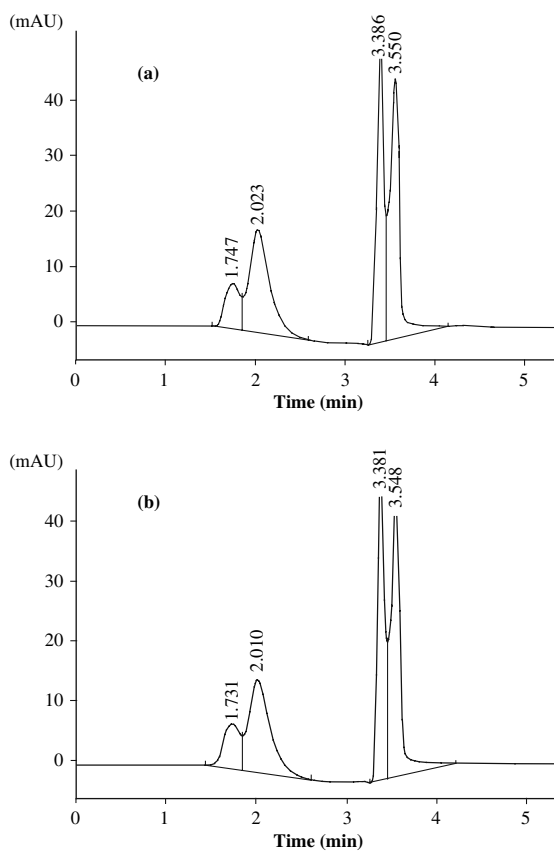
### 3.1 Quality of Extracted Products

As HVED treatment produces active species, authors were interested in the quality of proteins (Vishkvatzev et al. 1998). They have used HPLC to compare protein profile of soymilk obtained with classical extraction and HVED treatment. Their conclusion is that HVED treatment seems to have no effect on quality of extracted proteins (Fig. 9). Gros (2005) has also tested effect of HVED treatment on quality of proteins. HVED pulses are applied on BSA solution using a 1 l cell chamber related to a generator ( $U = 40$  kV,  $C = 0.20$   $\mu$ F,  $l = 5$  mm,  $W = 160$  J). Treated and untreated solutions are compared using HPLC (Fig. 10). No difference is observed between the two signals. This result confirms the absence of effect of HVED treatment on proteins.

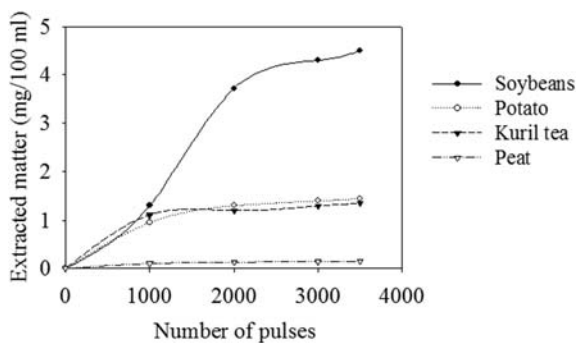
### 3.2 Extraction of Soluble Molecules

HVEDs may be used to accelerate soluble molecules extraction from biological products (Fig. 11) (Barskaya et al. 2000). With a generator ( $U = 50$  kV,  $C = 0.01$   $\mu$ F,  $l = 13$ – $50$  mm,  $W = 100$ – $500$  J), extraction speed could be multiplied by 40 up to 50 compared to infusion.

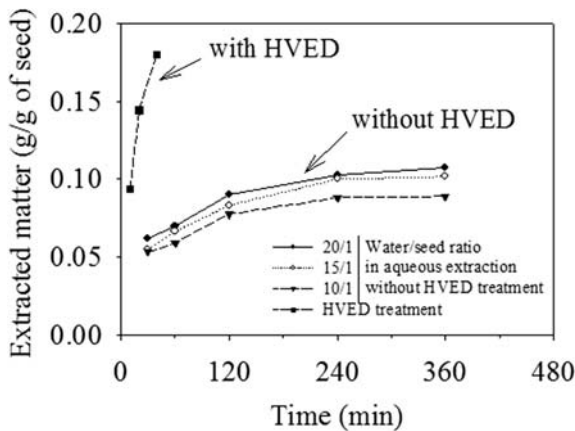
HVED treatment is used to enhance a mucilage extraction from whole linseed (Gros et al. 2003). Authors compared aqueous extraction at  $34^{\circ}\text{C}$  under agitation (120 rpm) with different water/seed ratios and HVED treatment. Seeds of 50 g are melted with 500 ml of demineralized water ( $20^{\circ}\text{C}$ ) and treated for 10 min (i.e., 300 pulses at 0.5 Hz) with a generator ( $U = 40$  kV,  $C = 0.20$   $\mu$ F,  $l = 5$  mm,  $W = 160$  J). A centrifuge separation is then performed ( $17,700g$ ,  $20^{\circ}\text{C}$ , 10 min) to obtain the solution and residue. The residue is then treated a second and a third time with freshwater in the same conditions. During HVED treatment, linseeds are crushed under action of shock waves. Three 10 min treatments were sufficient to extract mucilage almost entirely (Fig. 12). In the third one, proteins begin to be



**Fig. 10** HPLC profiles of untreated (a) and treated (b) solutions of protein (wavelength = 280 nm) (Gros 2005)



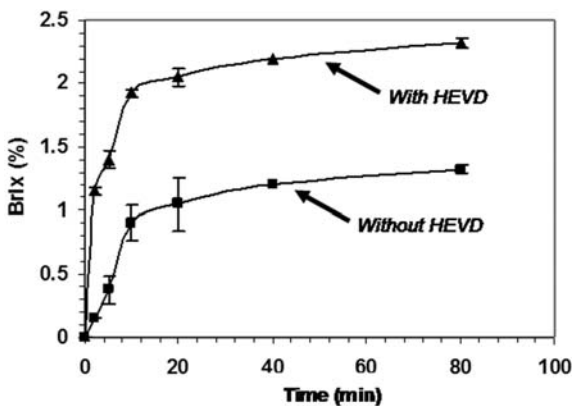
**Fig. 11** Effect of HVED treatment on extraction of different biological products (Barskaya et al. 2000)



**Fig. 12** Amount of matter extracted with different water/seed ratios and with three electrical discharge treatments with generator of electrical discharges (Gros et al. 2003)

extracted. The authors also observed that the increase of first treatment duration has an undesirable effect: mucilage creates a jelly, which traps the seeds, and so centrifuge separation becomes less efficient.

El-Belghiti (2005) has applied HVED for aqueous extraction of solutes from two dried products: tea leaves and *Datura innoxia* (common name: moonflower) roots. The water/gratings ratio was fixed as 10. Aqueous extraction was carried out at room temperature (20°C) under stirring at 250 rpm. HVED ( $U = 40$  kV, 100 pulses) had smashed products to small fragments, and a limited increase of 10°C temperature was observed. The extraction kinetics were obtained by measuring, in the suspension, Brix (tea leaves, Fig. 13) or electric conductivity (*Datura innoxia* roots, Fig. 14).



**Fig. 13** Effect of a HVED treatment on aqueous extraction from dried tea leaves (adapted from El-Belghiti 2005)

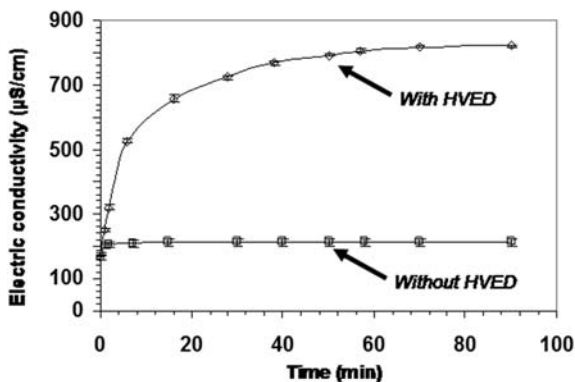


Fig. 14 Effect of a HVED treatment on aqueous extraction from dried *Datura innoxia* roots (adapted from El-Belghiti 2005)

In both cases, HVED application has led to higher solute concentration and has increased the extraction kinetic.

El-Belghiti et al. (2007) have compared moderate pulsed electric field (MPEF), HVED, and ultrasonic irradiations (UI) as treatments to enhance aqueous extraction from fennel gratings. The objective was to obtain extract used as natural food preservative (antioxidants). The water/gratings ratio was fixed as 2. Aqueous extraction was carried out at room temperature (20°C) under stirring at 250 rpm. The three assisted extractions led to the same final yield of solutes and preserve the

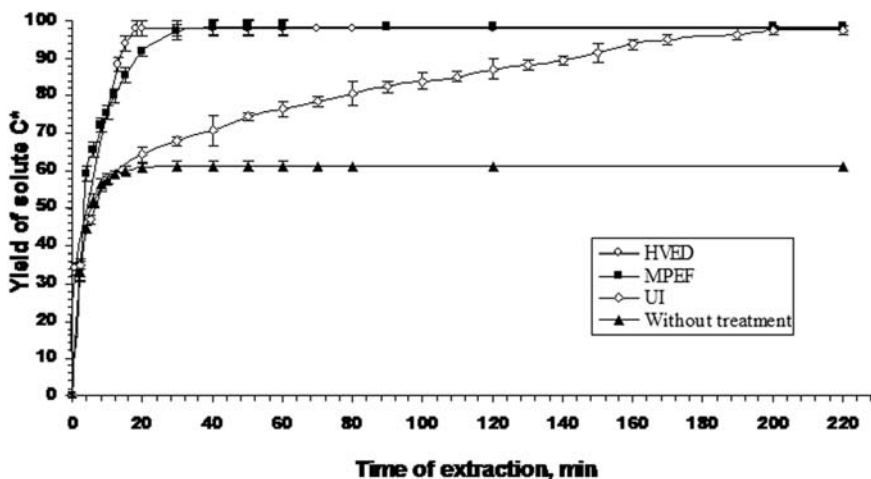


Fig. 15 Kinetics of solute extraction from fennel gratings pre-treated by MPEF, HVED and UI.  $c^*$  (%) is the ratio  $c/c_\infty$ ,  $c$  being the actual solutes concentration in solution and  $c_\infty$  being the equilibrium solutes concentration (El-Belghiti et al. 2007)

antioxidant substances. However, their kinetics were different due to the principles of action and the treatments used, which were different (Fig. 15). HVED and UI offered, respectively, the most rapid and the slowest kinetics. The final yield of 98% was reached in 20 min with HVED, in 40 min with MPEF, and in more than 180 min with UI. The amounts of energy needed for these treatments were also different: the treatment by UI requires a high amount of energy (320 kJ/kg) compared to HVED and MPEF (70 and 40 kJ/kg, respectively). Thus, the MPEF treatment appears to be energetically the most economic one.

### 3.3 Oil Extraction

Aqueous extraction of oil may also be enhanced by application of HVED. Kinetic of aqueous extraction enhanced by HVED is established for linseed press-cake (Gros 2005). Linseeds are crushed and pressed for 1 hour with an hydraulic press (12 MPa, 50°C) (Gros et al. 2003). Press-cake is reduced in powder (30 g) and melt with demineralized water (300 ml, 5  $\mu$ S/cm, 20°C). The mixture is treated with HVED (1–1,640 pulses) and centrifuged (10,000g, 20°C, 20 min). As soon as linseed powder and water are in contact, 26% of the residual oil moves into water (Fig. 16). This first step of extraction is simply due to a washing effect of water. Then from 15 to 220 pulses, oil is extracted under the action of HVED and 26% of oil remains in the residue after 1, 640 pulses.

For dry matter (Fig. 17), the first contact between linseed powder and water provokes an immediate extraction of 15.5% of dry matter (first phase). From 80 to 1,640 pulses dry matter is also extracted (second phase). This extraction in two phases was also described for aqueous extraction of mucilage from mustard seed (Balke and Diosady 2000).

Optimization of such a process is possible using classical lever for aqueous extraction (pH, time, water/seed ratio, agitation, number of treatments, etc.) and

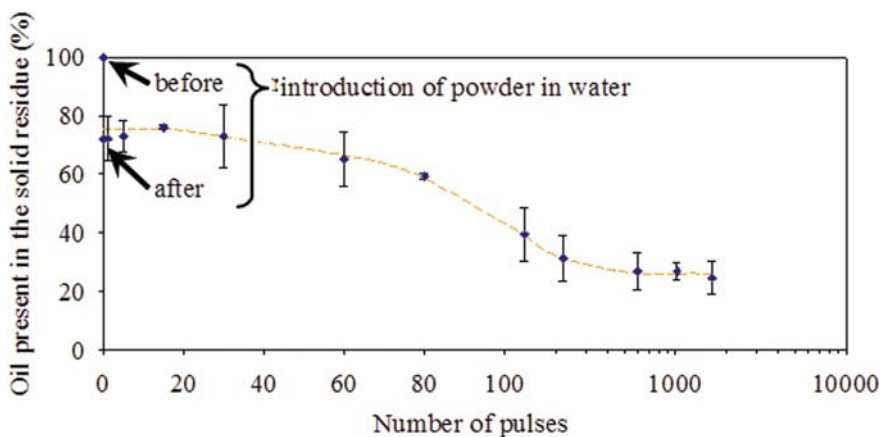


Fig. 16 Effect of number of pulses on oil contain in final residue (Gros et al. 2004)

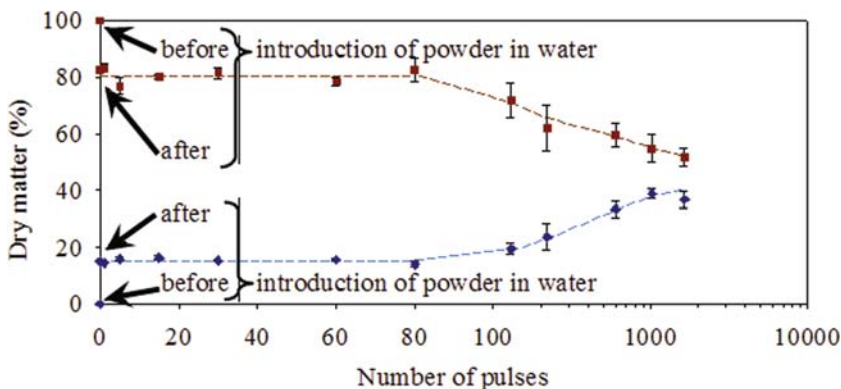


Fig. 17 Effect of number of pulses on quantity of dry matter in liquid phase (◆) and solid residue (■) during HVED treatment (Gros et al. 2004)

knowledge on HVED. Thanks to previous results (Gros 2005), a process based on two stages of aqueous extraction enhanced by HVED was proposed to recover oil from linseed press-cake. The extraction process was optimized using an experimental strategy based on a central composite design with star points (Gros et al. 2005). For each experiment, the same number of pulses (280) is applied. Authors have tested the effect of the repartition of pulses on two successive steps (13+267; 60+220; 130+150; 200+80; 247+33) and three process parameters: pH (4.9; 5.2; 5.8; 6.2; 6.5), water/press-cake ratio (6.67/1; 7.5/1; 8.75/1; 10/1; 10.83/1), and temperature (13; 20; 30; 40; 47°C). The authors have examined the main effect of these parameters on oil and soluble matter extraction and on energy consumed after electrical breakdown.

The pH has an effect on discharge efficiency and on aqueous extraction of oil but not on soluble matter (Figs. 18–20). The pH of suspension was controlled by addi-

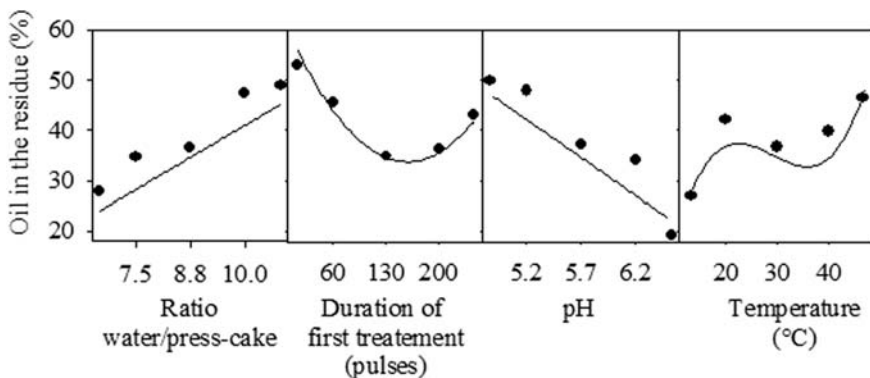


Fig. 18 Main effects of parameters on oil contained into the final residue (Gros et al. 2005) (curves: model; points: mean of experimental values)

tion of acid or base: electrical conductivity of suspension was modified and losses of energy during HVED creation were increased. The HVED were less efficient with the addition of ions. pH modifies the solubility of proteins: minimum solubility is observed at pH 3.5–4.0 (isoelectric pH) for linseed proteins (Dev and Quensel 1988). So the increase of pH increases the solubility of proteins and enhances oil extraction.

Water/press-cake ratio had an effect on discharge efficiency and on aqueous extraction of oil (Figs. 18 and 20). The increase of water/press-cake ratio has decreased the extraction efficiency. This effect came from enhanced extraction for concentrated suspensions and from the decrease of discharge efficiency with the increase of water/press-cake ratio.

Duration of first treatment had an effect on extraction of oil and soluble matter. There was an optimal repartition of pulses between the first and the second treatment for oil extraction. This effect results from the decrease of extraction efficiency in the first treatment (Fig. 21) as it was observed during kinetic study.

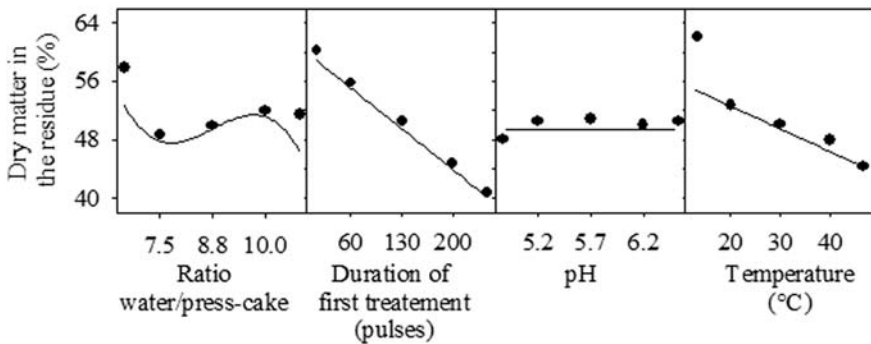


Fig. 19 Main effects of parameters on dry matter contained into residue (Gros 2005)

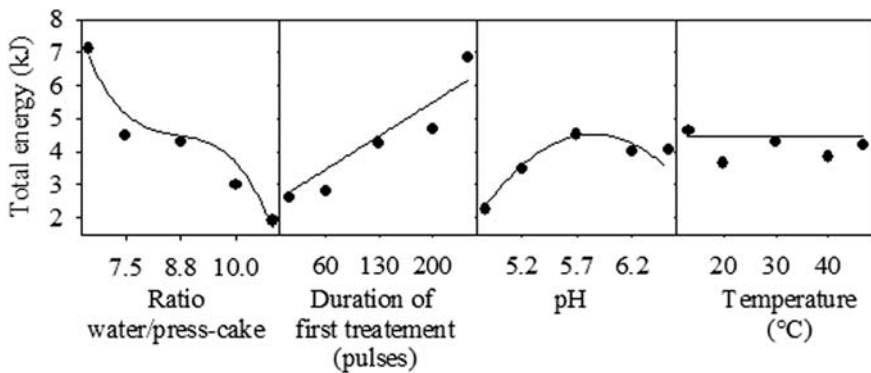
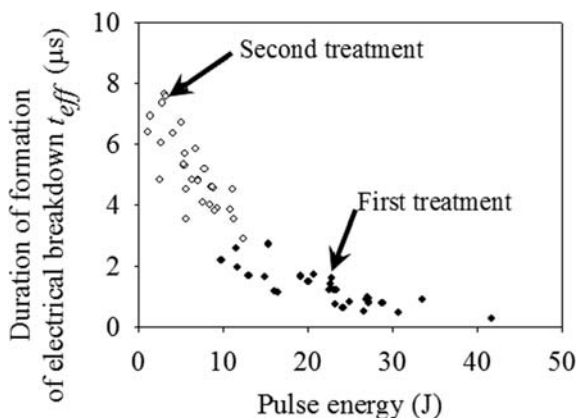


Fig. 20 Main effects of parameters on useful energy consumed for a 280 pulses experimentation (Gros et al. 2005)



**Fig. 21** Relation between mean duration of electrical breakdown formation  $t_{eff}$  and mean energy consumed (Gros et al. 2005)

Temperature had an effect on extraction of oil and dry matter but not on discharge efficiency.

## 4 Conclusion

HVEDs in water produce different phenomena such as ultraviolet radiation, active species, and shock waves. All these phenomena may be interesting for different applications (water treatment, pretreatment of biological product, particle crushing). Even if HVED treatment is aggressive, no denaturation of protein is observed on treated samples.

Concerning aqueous extraction, HVED enhances kinetic and quantity of extracted matter (soluble matter, oil). To understand and optimize aqueous extraction enhanced by HVED, knowledge of physical principles of discharges and aqueous extraction are required.

HVEDs in water should not be considered as the unique solution to enhance the aqueous extraction from food plants. However, this type of electrical treatment gives the interesting results for different tested products (soybean, potato, tea, peat, linseed, *Datura* roots, fennel grating, linseed press-cake).

## References

- Abu-Arabi, M. K., Allawzi, M. A., Al-Zoubi, H. S. and Tamimi, A. (2000) Extraction of jojoba oil by pressing and leaching. *Chemical Engineering Journal* 76(1), 61–65.
- Aguilera, J. M., Gengross, M. F. and Lusas, E. W. (1983) Aqueous processing of lupin seed. *Journal of Food Technology* 18(3), 327–333.



- Alkimov, A. P., Vorobyev, V. V., Klimkin, V. F., Ponomarenko, A. G. and Soloukhin, R. I. (1971) The development of electrical discharges in water. *Soviet Physics – Doklady* 15, 959–961.
- Bhalke, D. T. and Diosady, L. L. (2000) Rapid aqueous extraction of mucilage from whole white mustard seed. *Food Research International* 33(5), 347–356.
- Barskaya, A. V., Kuretz, B. I. and Lobanova, G. L. (2000) Extraction of water soluble matters from vegetative raw material by electrical pulsed discharges. 1st International Congress on Radiation Physics, High Current Electronics, and Modification of Materials, Tomsk, Russia, 533–535.
- Beckett, S. T. (1999) *Industrial chocolate: Manufacture and use*. Blackwell Science, Oxford, UK.
- Bhatty, R. S. (1993) Further compositional analyses of flax: Mucilage, trypsin inhibitors and hydrocyanic acid. *JAOCS, Journal of the American Oil Chemists' Society* 70(9), 899–904.
- Bluhm, H., Baumung, K., Böhme, R., Frey, W., Giese, H., Heinzl, A., Hoppe, P., Link, G., Müller, G., Schultheiss, C., Schumacher, G., Strässner, H., Strauss, D., Weisenburger, A. and Zimmermann, F. (2001) Pulsed power science and technology at Forschungszentrum Karlsruhe. International Conference on Pulsed Power Applications, Gelsenkirchen, March 27–29, A04/1-A04/8.
- Bozan, B. and Temelli, F. (2002) Supercritical CO<sub>2</sub> extraction of flaxseed. *JAOCS, Journal of the American Oil Chemists' Society* 79(3), 231–235.
- Burkes, T. R. (1978) A critical analysis and assessment of high power switches. Dahlgren, VA, Naval Surface Weapons Center, Report NP 30/78.
- Chen, Y.-S., Zhang, X.-S., Dai, Y.-C. and Yuan, W.-K. (2004) Pulsed high-voltage discharge plasma for degradation of phenol in aqueous solution. *Separation and Purification Technology* 34(1–3), 5–12.
- Cui, W., Mazza, G., Oomah, B. D. and Biliaderis, C. G. (1994) Optimization of an aqueous extraction process for flaxseed gum by response surface methodology. *Lebensmittel-Wissenschaft und-Technologie* 27(4), 363–369.
- Dev, D. K. and Quensel, E. (1988) Preparation and functional properties of linseed protein products containing differing levels of mucilage. *Journal of Food Science* 53(6), 1834–1837, 1857.
- El-Belghiti, K. (2005) *Effets d'un champ électrique pulsé sur le transfert de matière et sur les caractéristiques végétales*. PhD thesis, Génie des procédés industriels. Compiègne, University of Compiègne: 208.
- El-Belghiti, K., Moubarik, A. and Vorobiev, E. (2007) Use of moderate pulsed electric field, electrical discharges and ultrasonic irradiations to improve aqueous extraction of solutes from fennel (*Foeniculum vulgare*), unpublished data.
- El-Belghiti, K., Rabhi, Z. and Vorobiev, E. (2005) Effect of centrifugal force on the aqueous extraction of solute from sugar beet tissue pretreated by a pulsed electric field. *Journal of Food Process Engineering* 28(4), 346–358.
- FAO (2005) Faostat – <http://faostat.Fao.Org/site/336/default.aspx>. 2007.
- Gros, C. (2005) *Extraction aqueuse et athermique de l'huile de lin assistée par décharges électriques de haute tension*. PhD thesis, Génie des procédés industriels. Compiègne, University of Compiègne: 238.
- Gros, C., Lanoisellé, J.-L. and Vorobiev, E. (2003) Towards an alternative extraction process for linseed oil. *Chemical Engineering Research and Design* 81(9), 1059–1065.
- Gros, C., Lanoisellé, J.-L. and Vorobiev, E. (2004) Aqueous extraction and separation of linseed press-cake components enhanced by high voltage electrical discharges. 9th World Filtration Congress, New Orleans, LA, USA.
- Gros, C., Lanoisellé, J.-L. and Vorobiev, E. (2005) Extraction aqueuse d'huile végétale à partir de tourteaux de lin assistée par décharges électriques de haute tension. 9<sup>e</sup> congrès de la Société Française de Génie des Procédés, Récents Progrès en Génie des Procédés, 92, SFGP, Paris, France, B-12.
- Hnatiuc, E. (2002) Procédés basés sur les décharges électriques. In: E. Hnatiuc (Ed.), *Procédés électriques de mesure et de traitement des polluants*. Lavoisier Tec & Doc, Paris, France, 219–295.

- Joshi, A. A., Locke, B. R., Arce, P. and Finney, W. C. (1995) Formation of hydroxyl radicals, hydrogen peroxide and aqueous electrons by pulsed streamer corona discharge in aqueous solution. *Journal of Hazardous Materials* 41(1), 3–30.
- Katsuki, S., Leipold, F., Laroussi, M. and Schoenbach, K. H. (2002) Plasma formation and electrical breakdown in water. *IEEE International Conference on Plasma Science. ICOPS 2002*, Banff, Alberta, Canada May 26–30, 4P05.
- Kim, S. H. (1989) Aqueous extraction of oil from palm kernel. *Journal of Food Science* 54(2), 491–492.
- Lopes Barbosa, A. C., Lajolo, F. M. and Genovese, M. I. (2006) Influence of temperature, pH and ionic strength on the production of isoflavone-rich soy protein isolates. *Food Chemistry* 98(4), 757–766.
- Lu, X.-P., Pan, Y., Liu, K.-F., Liu, M.-H. and Zhang, H.-H. (2001) Early stage of pulsed discharge in water. *Chinese Physics Letters* 18(11), 1493–1495.
- Malik, M. A., Ghaffar, A. and Malik, S. A. (2001) Water purification by electrical discharges. *Plasma Sources Science and Technology* 10(1), 82–91.
- Martin, J. C. (1973) Nanosecond pulse techniques, in pulsed electrical power circuit and electromagnetic system design notes pep4-1, vol. 1, afw1-tr 73–166, note 4.
- Mazza, G. and Biliaderis, C. G. (1989) Functional properties of flaxseed mucilage. *Journal of Food Science* 54(5), 1302–1305.
- Mikula, M., Panák, J. and Dvonka, V. (1997) The destruction effect of a pulse discharge in water suspensions. *Plasma Sources Science and Technology* 6(2), 179–184.
- Naugol'nykh, K. A. and Roi, N. A. (1971) *Elektricheskii razryad v vode* (electric discharge in water). Nauka, Moscow, Russia.
- Rosenthal, A., Pyle, D. L. and Niranjan, K. (1996) Aqueous and enzymatic processes for edible oil extraction. *Enzyme and Microbial Technology* 19(6), 402–420.
- Sharma, A., Khare, S. K. and Gupta, M. N. (2002) Enzyme-assisted aqueous extraction of peanut oil. *JAOCs, Journal of the American Oil Chemists' Society* 79(3), 215–218.
- Southwell, K. H. and Harris, R. V. (1992) Extraction of oil from oilseeds using the hot water flotation method. *Tropical Science* 32(3), 251–262.
- Sugiarto, A. T., Ito, S., Ohshima, T., Sato, M. and Skalny, J. D. (2003) Oxidative decoloration of dyes by pulsed discharge plasma in water. *Journal of Electrostatics* 58(1–2), 135–145.
- Sugiarto, A. T. and Sato, M. (2001) Pulsed plasma processing of organic compounds in aqueous solution. *Thin Solid Films* 386(2), 295–299.
- Sun, B., Sato, M. and Clements, J. S. (1997) Optical study of active species produced by a pulsed streamer corona discharge in water. *Journal of Electrostatics* 39(3), 189–202.
- Sun, B., Sato, M., Harano, A. and Clements, J. S. (1998) Non-uniform pulse discharge-induced radical production in distilled water. *Journal of Electrostatics* 43(2), 115–126.
- Tano-Debrah, K. and Ohta, Y. (1997) Aqueous extraction of coconut oil by an enzyme-assisted process. *Journal of the Science of Food and Agriculture* 74(4), 497–502.
- United States Department of Agriculture (2007) Oilseeds: World markets and trade. (FOP 3-07).
- Vishkvaztzev, L. I., Kuretz, B. I., Lobanova, G. L., Filatov, G. P. and Barskaya, A. V. (1998) Use of electrical discharges for the treatment of soya beans (in Russian). *Vestnik Rossiyskoy Akademii Selskohozyaistvennih Nauk* 6, 71–72.
- Vitkovitsky, I. (1987) *High power switching*. Van Nostrand Reinhold Co, New York, USA.
- Wanasundara, P. K. J. P. D. and Shahidi, F. (1997) Removal of flaxseed mucilage by chemical and enzymatic treatments. *Food Chemistry* 59(1), 47–55.
- Wesley, R. H. and Ayres, R. A. (1984) Method and apparatus for electrohydraulic fracturing of rock and the like. US Patent 4,479,680.
- Yushkov, A. (2004) *Study of cast pile forming by pulse discharges* (in Russian). Tomsk, Russia, Tomsk Polytechnical University.
- Zuckerman, H., Krasik, Y. E. and Felsteiner, J. (2002) Inactivation of microorganisms using pulsed high-current underwater discharges. *Innovative Food Science and Emerging Technologies* 3(4), 329–336.

# Industrial-Scale Treatment of Biological Tissues with Pulsed Electric Fields

H. Bluhm and M. Sack

**Abstract** In this section we discuss the technical requirements and perspectives for industrial-scale electroporation of plant cell tissues. Energetically it seems more favorable to apply strong fields and short pulses than weak fields and long pulses. Different generator configurations for the production of strong pulsed electric fields and the durability of their main components are considered. Schemes for the process control and the verification of the achieved degree of electroporation are examined. In the second part of this contribution we describe the status of some emerging industrial applications like sugar beet treatment, extraction of aromas, and flavors from wine grapes, and the conditioning of green biomass for energetic utilization by electroporation-assisted dewatering.

## 1 Introduction

The present contribution will be restricted to the industrial exploitation of permanent pores (permeability) induced by strong pulsed electric fields (PEFs) in the membranes of plant cells, a process usually termed electroporation. A detailed description of electroporation has been given in Chapters 1 and 2 of this book and will not be repeated here. Stress reactions enhancing the production of certain substances in the cell interior or influencing the growth of fungi, which also have been reported in the literature (Tsukamoto et al. 2003), will not be considered.

The treatment of plant cell tissues with PEFs as a supplementary step or a substitute for existing procedures in a food processing chain is justified only if economic, ecologic, or qualitative advantages can be realized. These advantages can result from an increased yield of nutriments, shorter process times, reduced energy consumption, or a longer shelf life of the product.

Industrial-scale treatment of plant cell tissues generally demands for large throughputs. A large sugar factory, for example, is capable to process a sugar beet flow rate of up to 600 t/hour, while the capacity of a fruit dejuicing plant is typically

---

H. Bluhm  
Forschungszentrum Karlsruhe GmbH, Institute for Pulsed Power and Microwave Technology,  
Postfach 3640, D-76021 Karlsruhe  
e-mail: bluhm@ihm.fzk.de

of the order of 100 t/hour. A large throughput can either be realized by a large flow cross-section or a high flow velocity. Evidently a robust, reliable, and inexpensive technology for the production of adequately strong electric fields in large volumes is a prerequisite for a successful industrial utilization of electroporation. The formation of large irreversible pores is a function of the product of field strength  $E$  and pulse duration  $\tau$ . Energetically it seems more favorable to create the permanent pores with strong fields and short pulses than with weak fields and long pulses. To illustrate this let us consider a flow of sugar beet cossettes with a packing density of 60%. To maintain the integrity of the cossettes the flow velocity needs to be restricted to less than 1.5 m/s. In our example the cross-section of the field zone is assumed to be  $0.3 \times 0.3 \text{ m}^2$  and its length 1.50 m. Thus, the sugar beet throughput corresponds to 290 t/hour and the time during which a cell remains in the reactor becomes 1 s. There is a threshold of about 0.5 V for the potential across a membrane that needs to be exceeded before pores begin to grow. Assuming a mean size of 100  $\mu\text{m}$  for the sugar beet cells, we can conclude that a minimum field strength of 10 kV/m is required. For a pulse duration of 1  $\mu\text{s}$ , typically 30 pulses with 500 kV/m are necessary to open the membrane. Let us now compare the two extreme cases of DC operation at 10 kV/m with that of pulsed operation at 500 kV/m, 30 Hz repetition rate, and 1  $\mu\text{s}$  pulse width. The conductivity of a suspension of sugar beet cossettes is on the order of 0.3 S/m. In case of DC operation we need a voltage amplitude of 3 kV and the ohmic current becomes 1.35 kA. Thus, the high-voltage supply must deliver an average power of 4.05 MW. In case of pulsed operation, a voltage amplitude of 150 kV and a pulsed current of 67.5 kA are needed. However, the average power reduces to 160 kW.

The requirements for pulse generators suitable for industrial-scale treatment of plant cell tissues have been summarized in Table 1.

Besides supplying the requested electrical parameters, the pulse generator should allow a low maintenance rate and a long durability of components to meet the economic requirements.

## 2 Pulse Generators for Industrial Applications

### 2.1 Generator Configurations

The parameters summarized in Table 1 can be realized through different generator configurations. The simplest setup is a high-voltage capacitor or a parallel

**Table 1** Requirements for industrial-scale pulse generators

| Parameter          | Value              |
|--------------------|--------------------|
| Pulse amplitude    | 100 kV–1 MV        |
| Pulse current      | 10–100 kA          |
| Power of pulse     | 1–10 GW            |
| Pulse duration     | 1–10 $\mu\text{s}$ |
| Average power      | 100–500 kW         |
| Repetition rate    | 1–50 Hz            |
| Component lifetime | $10^9$ pulses      |

connection of several capacitors discharged into the reaction chamber through a closing switch. A variant of this configuration is the Blumlein setup shown in Fig. 1a. Here two LC chains are charged in parallel and discharged in series thus doubling the output voltage. The main problem with all of these configurations is to achieve the required pulse amplitude of several hundred kilovolts. Of course it is conceivable to increase the output voltage by a pulse transformer as shown in Fig. 1b. However, the core of this transformer needs to be quite large since the core cross section  $F$  multiplied with the sum of the saturation inductance  $B_s$  and the remnant inductance  $B_r$  of the ferromagnetic material must be greater than the time integral of the voltage pulse  $U(t)$ :

$$F(B_r + B_s) > \int U(t)dt \quad (1)$$

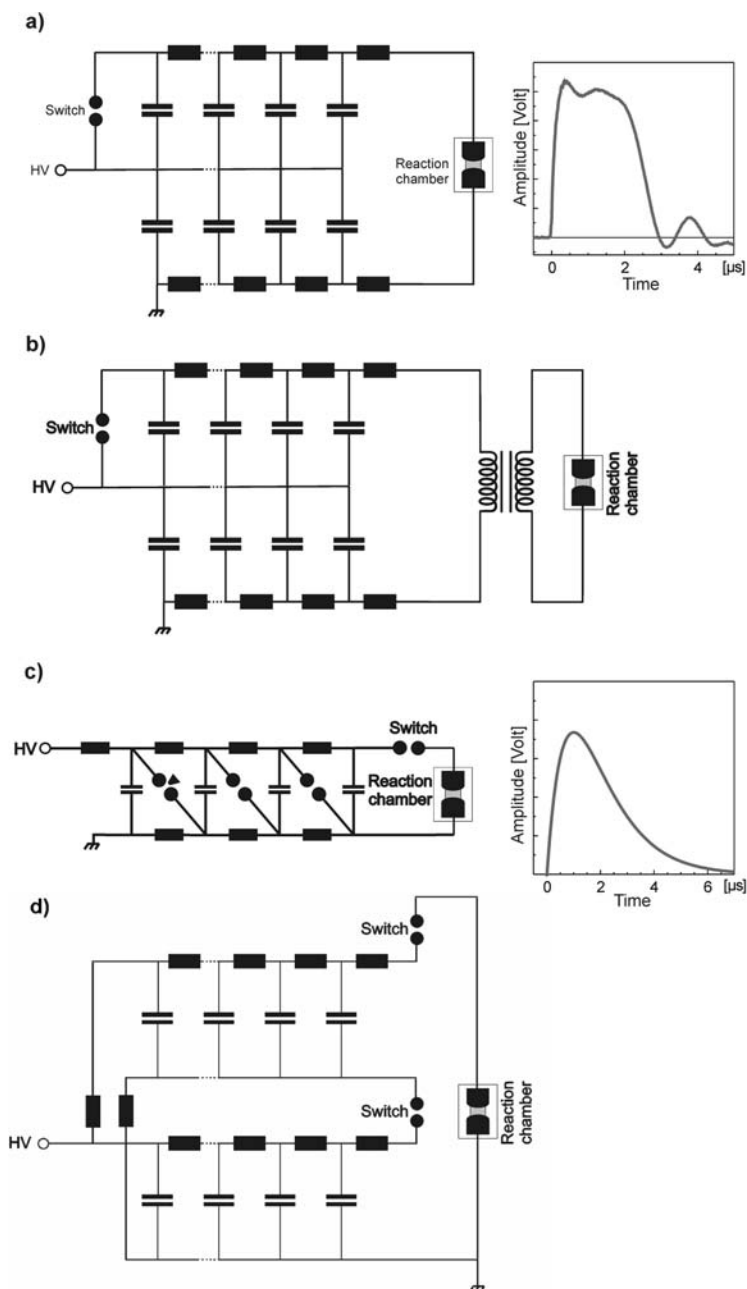
For a voltage amplitude of 100 kV and a pulse duration of several  $\mu s$   $F$  can reach several tenth of a square meter. Another disadvantage is that the pulse transformer does not only change the voltage amplitude but also multiplies the impedance of the generator with the square of the transformation factor  $n$ . For this reason and to avoid pulse deformation,  $n$  has to be limited.

Therefore, a more attractive configuration is the Marx generator whose principle is shown in Fig. 1c. The Marx generator consists of several high voltage capacitors that are charged in parallel from a high-voltage power supply and by closing a set of switches discharged in series (Marx 1923, 1924). Using a Marx configuration it is easily possible to achieve megavolts in output voltage.

A generator consisting of a set of LC chains in a Marx generator configuration (Fig. 1d) is capable of delivering a high rectangular shaped output voltage without the use of a transformer. But due to the larger amount of elements such a device is much more complex and costly than a Marx generator. For many industrial applications the higher efficiency of a rectangular pulse compared to a rather slowly rising and exponentially decaying pulse of a Marx generator is not required.

An important parameter of the Marx generator is its impedance  $Z$ , which we define as  $\sqrt{L/C}$ , where  $L$  is the total inductance of the circuit including the inductance of the connections between the Marx and the reactor and  $C$  is the serial capacitance of the erected Marx generator  $C = C_s/k$  ( $C_s$  = stage capacitance,  $k$  = number of stages) (Bluhm 2006). In general the electroporation reactor can be considered as a purely resistive load  $R$  and the actual voltage at the reactor  $U_{\max}$  is determined by the ratio of the Marx impedance and the load resistance. This ratio also determines the percentage of voltage reversal  $U_{\text{rev}}$  at the Marx capacitors which is an important parameter for the lifetime of high-voltage capacitors and should not exceed the value rated by the constructor of the capacitor. Typically it should be less than 20% of the maximum rated voltage. The necessary electric fields inside the reactor and the allowable voltage reversal determine the range of acceptable variations of the reactor resistance  $R$  resulting from variations in the conductance of the cell suspension flowing through the reactor.

Analyzing the equivalent circuit of the erected Marx generator with a total erected voltage  $U_0$  connected to the load, we obtain the following expressions for the relative amplitude  $U_{\max}/U_0$  and for the fractional voltage reversal  $U_{\text{rev}}/U_0$  as



**Fig. 1** Possible generator configurations for industrial-scale electroporation. (a) and (b) LC chains in Blumlein configuration without and with a high voltage pulse transformer. (c) Marx generator. (d) Two-stage Marx generator with LC chains. The diagrams on the right-hand side show the attainable pulse shapes

a function of the ratio  $Z/R$ :

$$\frac{U_{\max}}{U_0} = \frac{1}{\sqrt{\left(\frac{Z}{R}\right)^2 - \frac{1}{4}}} \exp\left(-\frac{\alpha + k\pi}{2\sqrt{\left(\frac{Z}{R}\right)^2 - \frac{1}{4}}}\right) \sin(\alpha + k\pi) \tag{2}$$

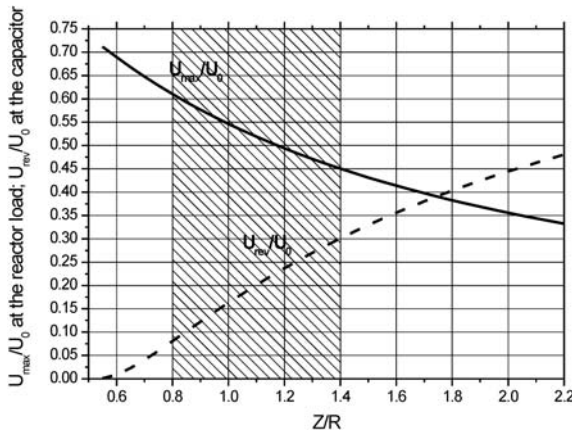
$$\frac{U_{\text{rev}}}{U_0} = \exp\left(-\frac{k\pi}{2\sqrt{\left(\frac{Z}{R}\right)^2 - \frac{1}{4}}}\right) \tag{3}$$

where  $\alpha$  is given by

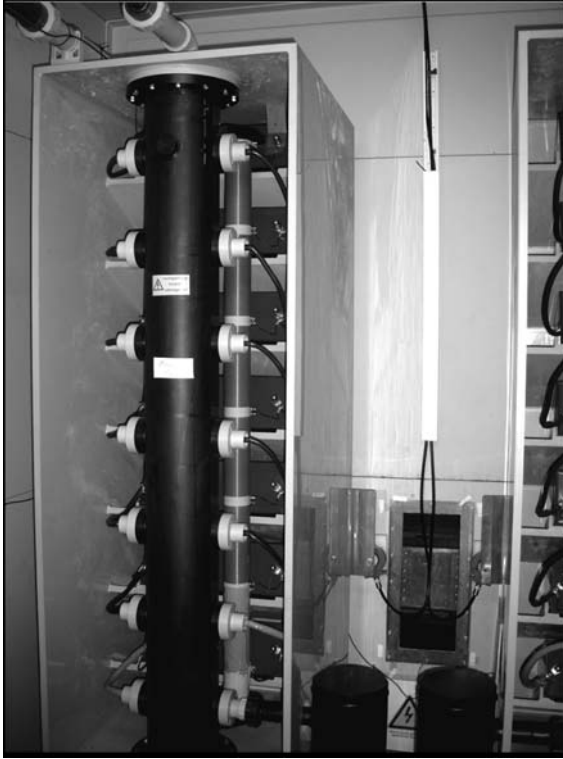
$$\alpha = \arctan\left(2\sqrt{\left(\frac{Z}{R}\right)^2 - \frac{1}{4}}\right) \tag{4}$$

The equations above are given for the periodically damped case with  $Z > \frac{1}{2} R$  only, as the aperiodically damped case is of less interest for industrial electroporation devices. Equations (2) and (3) have been plotted in Fig. 2. The crosshatched area is the granted operating range for a permitted reversal of up to 30% and an accepted reduction of the pulse amplitude down to 45% of its maximum. Commonly the impedance of a repetitive multistage Marx-generator exceeds 20  $\Omega$  while the exemplary reactor described in the introduction represents a resistance between 4  $\Omega$  and 8  $\Omega$ . Therefore, several Marx generators connected in parallel will be required to drive a large-scale reactor. The problem of synchronizing these generators will be discussed later.

Figure 3 shows two prototype Marx generators that were built to drive a demonstration plant for sugar beet treatment (Schultheiss et al. 2004). They consisted of



**Fig. 2** Voltage amplitude  $U_{\max}$  and the voltage reversal  $U_{\text{rev}}$  of a Marx generator divided by the total erected voltage  $U_0$  as a function of the ratio of the Marx impedance  $Z$  and reactor resistance  $R$



**Fig. 3** Seven-stage Marx generators built to drive a demonstration plant for sugar beet treatment

seven stages and were able to deliver a voltage pulse with a total erected voltage  $U_0 = 350$  kV at a repetition rate of up to 20 Hz. The low energy-density capacitors were rated for a lifetime of more than  $10^9$  shots.

## 2.2 Spark Gap Switches

The spark gap switches used in the generators shown in Fig. 3 were contained in a common cylindrical polyethylene tube and operated in a self-break mode. Ignition occurred when the capacitors had been charged past the breakdown voltage of the first switch gap whose interelectrode distance had been reduced compared to the others. Thus, a consecutive ignition of switches was enforced and the breakdown of the following gaps was facilitated through illumination with UV light from the arcs of the preceding ones. Nitrogen gas was circulated through the switch housing both for cooling and removing of the debris that was eliminated from the gas stream by filters.

Also for industrial-scale generators spark gap switches seem more favorable than solid state switches. Gas filled spark gaps are simple, robust, and inexpensive. The



high complexity and the large dimensions of a high-voltage, high-current thyristor stack, for example, which also lead to large product costs, have up to now prevented the broad use of solid state switches in pulsed power applications. The complexity is increased by protective circuits often necessary to prevent the destruction of the device in case of any malfunction in the circuit.

Nevertheless there are also major problems connected with the use of spark gap switches. Their main problem is the burn-up of the switch electrodes. Erosion does not only lead to an enlargement of the interelectrode gap but also to a change—in most cases a roughening—of the electrode surface and to a contamination of the switching gas with dust and gaseous reaction products. The combination of these effects can result in a strong change of the ignition properties and ultimately limits the lifetime of the switch. Also precipitation of debris from the electrodes on the inner wall of the switch housing can contribute to this degradation. Two measures have been taken to retard the alteration of the switching characteristics: profiling of the field distribution on the electrode surface and selection of suitable materials. A uniform field distribution across the electrode surface can provide a homogeneous burn-up. This has been reached by shaping the surface with a Borda profile (Borda 1766).

Figure 4 shows a set of switch electrodes machined with such a profile inside the switch housing. If in addition the surface area of the electrode is made large the growth rate of the interelectrode gap is slowed down. The onset of electrode erosion requires a sufficiently high locally restricted energy deposition that either leads to mechanical stress, local melting or evaporation of the material (Donaldson 1990, 1991). A complete modeling of the electrode burn-up in a spark gap is very complex, and quantitative scaling laws descending from it will probably never become available (Belkin 1971; Belkin and Kiselev 1977). For that aim not only the melting and evaporation of the material have to be calculated but also magnetohydrodynamic and



**Fig. 4** Set of spark gap switches with Borda electrode profiles in a common switch housing

acoustic effects expelling the material from the melt zone need to be considered. In addition, the plasma physics in the spark channel and the influence of evaporating material on the plasma properties have to be simulated. On the other hand, if one restricts the simulation to isolated phenomena we can only expect some hints for the selection of suitable electrode materials and for a possible qualitative scaling of the burn-up with current, pulse duration, kind of gas, etc. It turns out that the load integral  $\int_0^{t_p} I(t)^2 dt$  is a useful parameter to describe the phenomena (Zingerman 1960). One can derive the following formula that relates the load integral with the material and spark channel properties:

$$\int_0^{t_p} I(t)^2 dt = \frac{T_{\text{eff}}^2 \rho c' \kappa}{U_c} \cdot \pi^3 b^4 \quad (5)$$

Here  $I(t)$  is the current flowing through the spark;  $t_p$  is the pulse duration;  $T_{\text{eff}} = T_m T_0$  is the difference between the melting point of the electrode material and its initial temperature;  $\rho$  is the material density;  $c' = c + \Delta H_m / T_{\text{eff}}$  is the reduced specific heat taking into account the melt heat  $\Delta H_m$ ;  $\kappa$  is the heat conductivity;  $U_c$  is the cathode fall and  $b$  is the arc radius. We can see from Equation (5) that the admissible load integral before the beginning of melting increases with the square of the melting temperature, the product  $\rho c' \kappa$ , and the spark channel radius  $b$  with a power of 4 and it is inversely proportional to the square of the cathode fall  $U_c^2$ . The problem with Equation (5) is that neither the channel radius  $b$  nor the cathode fall  $U_c$  and their parametric dependence on the nature of the switching gas and the switch current are known.

A similar equation like Equation (5) can be derived for the onset of evaporation. However, for the range of currents and pulse durations of interest here electrode erosion is dominated by the molten volume and not by evaporation.

A different form of Equation (5) can be derived if we introduce the heat flux  $\Gamma_0 = U_c I / \pi b^2$  and solve for the melting temperature  $T_{\text{eff}}$ :

$$T_{\text{eff}} = \frac{\Gamma_0 \sqrt{t_p}}{\sqrt{\rho c' \kappa} \sqrt{\pi}} \quad (6)$$

From the above considerations we can derive the following criteria for the selection of electrode materials: Preferable are materials with large values of  $\rho c' T_{\text{eff}}$  and  $\sqrt{\bar{\kappa} \rho c' T_{\text{eff}}}$ . The first parameter describes the necessary specific energy to melt the electrode material while the second is proportional to the heat flux required for the onset of melting. Here  $\bar{\kappa}$  is the mean heat conductivity between room temperature and the melting point. A classification of materials based on these parameters is presented in Table 2.

Composite materials try to take advantage of the different physical properties of their components (Haufe et al. 1972; Donaldson 1991). Among these materials CuW is most frequently used for spark gap electrodes. Besides CuW, CuCr and CuCrZr are commonly applied. CuW exploits the good heat conductivity of copper and the

**Table 2** Classification of possible electrode materials based on the assumption that melting is the dominating erosion mechanism

| Material   | $T_m$ [K] | $\bar{\kappa}$ [J/s cm K] | $c'$ [J/g K] | $\rho c' T_{\text{eff}}$ [J/cm <sup>3</sup> ] | $\sqrt{\rho c' \bar{\kappa} T_{\text{eff}}}$ [J/cm <sup>2</sup> s <sup>1/2</sup> ] |
|------------|-----------|---------------------------|--------------|---|--|
| Tungsten   | 3695      | 1.105                     | 0.271        | $1.75 \cdot 10^4$                             | $7.97 \cdot 10^3$  |
| Molybdenum | 2896      | 1.38                      | 0.251        | $6.54 \cdot 10^3$                             | $4.78 \cdot 10^3$  |
| Copper     | 1357      | 3.54                      | 0.727        | $6.56 \cdot 10^3$                             | $4.83 \cdot 10^3$  |
| Niobium    | 2750      | 0.537                     | 0.265        | $5.45 \cdot 10^3$                             | $2.65 \cdot 10^3$  |

high melting point of tungsten. In table 3 the thermophysical properties of Cu, W, and Cr have been listed. CuW consists of a spongy matrix of tungsten that has been impregnated with copper. Since the melting temperature of Cu is much below that of W, molten Cu remains with a certain probability within the solid tungsten matrix. If the heat transfer between copper and tungsten occurs sufficiently fast copper begins to evaporate before tungsten starts to melt because even the evaporation temperature of copper is lower than the melting point of tungsten. On the other hand the heat of evaporation of copper is more than three times larger than the heat of melting of tungsten. Therefore, it is expected that the heat flux to the electrode for material erosion can be appreciably larger than for pure copper or tungsten. The mixing ratio for minimum erosion depends also on the structure of the matrix. According to experimental experience the lowest erosion rates appear at 30–40% of Cu.

Important for the success of the matrix concept is the rapidity of temperature equilibration between the components. In this respect the heat conductivity of the material component with the lower boiling temperature, the heat transfer coefficient between components, and the structure of the matrix are crucial parameters.

At required current levels above 10 kA, it seems impossible to eliminate the burn-up of electrodes. Therefore, the self-breakdown level of spark gaps will change during operation and needs to be compensated periodically. This can either be achieved by reducing the gas pressure or by mechanically readjusting the gap width.

Some experience with the burn-up of CuW electrodes has been gained in our laboratory (Sack and Bluhm 2005). At a current level of  $\hat{I} = 4.5$  kA, pulse width of  $t_h = 1.4$   $\mu$ s, and load integral of 20 A<sup>2</sup>s averaging over 500 000 pulses, the mean material losses were found to be 183 ng per pulse for one pair of electrodes. At the working level of an industrial Marx generator of  $t = 9.5$  kA,  $t_h = 1.15$   $\mu$ s pulse width, and a load integral of 82 A<sup>2</sup>s, losses of 824 ng per pulse have been measured.

**Table 3** Thermophysical properties of Cu, W, and Cr to explain the properties of composite materials.  $\bar{c}$ ,  $\bar{\kappa}$  are the mean heat capacitance and thermal conductivity respectively

| Material | $T_m$ [K] | $T_v$ [K] | $\bar{\kappa}_m$ [J/s K] | $\rho c T_{\text{eff}}$ (melting) [J/cm <sup>3</sup> ] | $\rho c T_{\text{eff}}$ (boiling) [J/cm <sup>3</sup> ] | $\sqrt{\rho \bar{c} \bar{\kappa} T_{\text{eff}}}$ (melting) [J/cm <sup>2</sup> s <sup>1/2</sup> ] | $\sqrt{\rho \bar{c} \bar{\kappa} T_{\text{eff}}}$ (boiling) [J/cm <sup>2</sup> s <sup>1/2</sup> ] |
|----------|-----------|-----------|--------------------------|--|--|---|---|
| Wolfram  | 3695      | 5828      | 0.95                     | $1.75 \cdot 10^4$                                      | $1.01 \cdot 10^5$                                      | $7.97 \cdot 10^3$   | $2.23 \cdot 10^4$   |
| Kupfer   | 1357      | 2835      | 2.67                     | $6.56 \cdot 10^3$                                      | $5.61 \cdot 10^4$                                      | $4.83 \cdot 10^3$   | $1.93 \cdot 10^4$   |
| Chrom    | 2180      | 2944      |                          |  |  |   |   |
| Zirkon   | 2128      | 4682      |                          |  |  |   |   |

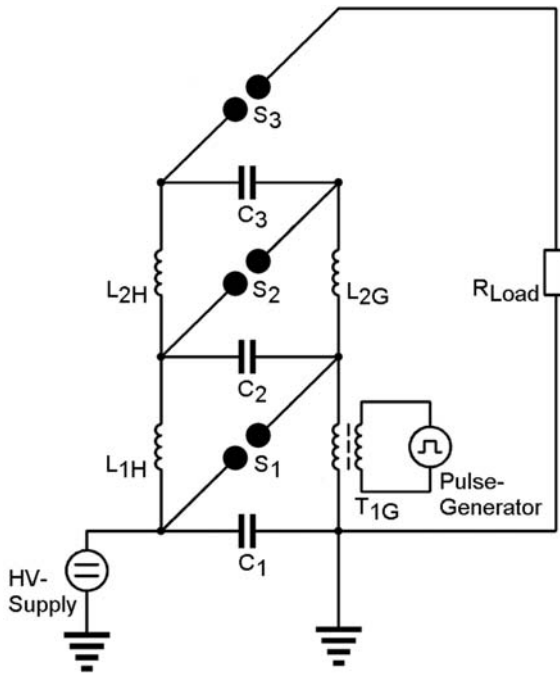
The applied electrodes were machined with a Borda profile of 40 mm diameter. If a maintenance period of 200 million pulses, corresponding to approximately 3 month operation of a generator running at 20 Hz, were acceptable, an increase of the gap distance by 1.9 mm for  $\hat{I}=4.5$  kA and 8.7 mm for  $\hat{I}=9.5$  kA would have been to be compensated, corresponding to about 16% and 73% respectively of the initial gap width of 12 mm. These values demonstrate the severity of electrode wear and request for a permanent and automatic adjustment of the switch self-breakdown level. Since the homogeneous field distribution of the Borda profile fosters the uniform burn-up across the electrode surface, it is possible to reduce the increase of the gap width by enlarging the electrode area. Nevertheless at least for the higher current it seems not feasible to compensate the burn-up just by reducing the gas pressure. Systems for adjusting the gap distance mechanically during operation have therefore been designed. A conceivable control scheme will be discussed later.

### 2.3 Synchronization

It has been mentioned already that the impedance of a multistage repetitive Marx generator is generally much larger than the equivalent resistance of a large-volume industrial electroporation reactor. Designing the Marx generator to match the reactor impedance, although in principle conceivable, severely enhances the switch electrode burn-up. Therefore it is preferable to divide the total required pulse current between several Marx generators. However, this requires synchronizing their pulse generation. Synchronization can be achieved by triggering the first switch in the Marx generators with a sufficiently low jitter. Triggering of spark gap breakdown is generally obtained with an auxiliary electrode (Bluhm 2006). The partial gap between this electrode and one of the main electrodes is rapidly overvolted with the help of an additional trigger pulse generator. After breakdown of this partial gap, the entire charging voltage appears across the second partial gap and leads to its rapid ignition. The disadvantage of this kind of triggering is the even quicker wear of the exposed trigger electrode. A trigatron-type trigger circuit exhibits as well an increased wear for the same reasons. Therefore, we have developed a new durable trigger concept that does not need a third electrode (Sack et al. 2003, 2005). The principle is shown in Fig. 5.

It is based on the superposition of a voltage pulse on the charging voltage of the first capacitor  $C_1$ , which appears across the two-electrode spark gap  $S_1$ . For that purpose the ground-side charging coil is replaced by a pulse transformer  $T_{1,G}$  connected to an auxiliary pulse generator. The pulse transformer superimposes a voltage pulse to the charging voltage of the stage capacitor. The spark gap  $S_1$  ignites because of overvoltage and launches an ignition wave through the other switches. Additionally, the transformer decouples the auxiliary trigger pulse generator from the load voltage of the Marx capacitors.

In the auxiliary trigger pulse generator, a semiconductor switch connects an energy storage capacitor to the primary of the pulse transformer. Depending on the design the trigger pulse can either be generated when the semiconductor switch



**Fig. 5** General scheme of a trigger concept without a trigger electrode based on the superposition of a trigger pulse on the charging voltage of capacitor  $C_1$ , which appears across the spark gap  $S_1$

closes or when it subsequently opens. After triggering, the trigger pulse polarity is opposite to the stage voltage across the transformer. Hence, a transient insulation of the two adjacent stages has to be provided by a sufficiently large inductance in the pulse transformer branch. In case of pulse generation at closing time the stages may be insulated either by an increased stray inductance of the pulse transformer, or by an additional series inductance. If the trigger pulse is generated by switch opening, the inductance of the transformer’s secondary serves as the transient insulation.

Moreover, the trigger pulse generator has to withstand the voltage appearing across the secondary. Although a closed switch is inherently protected against overvoltage, it has to cope with the current through the charging branch ramping up during pulse formation of the Marx generator. The current driven through the secondary of the transformer flows in the same direction as the current of the trigger pulse. Hence, the switch has to be designed for the sum of both currents. An anti-parallel diode may protect the switch in case of ringing.

An open switch has to be protected against the voltage induced across the primary. The main protective measure is to choose a sufficiently large transformer ratio, which guarantees that the induced voltage remains safely below the maximum voltage rating of the semiconductor switch. Additionally, suppressor diodes may protect the switch. A diode in series to the switch protects it against polarity reversal due to ringing, as for many IGBTs (insulated gate bipolar transistor) or MOSFETs

(metal oxide semiconductor field effect transistor) the reverse breakdown voltage is much less than the forward breakdown voltage.

To obtain a low jitter a fast-rising overvoltage pulse across the spark gap is essential. The stray capacitances of the first stage together with the equivalent inductance of the two charging branches form a resonant circuit determining the rise time of the trigger pulse. If one trigger transformer is implemented e.g. in the ground side charging branch, its effective inductance  $L_{TIG,eff}$  forms together with the charging coil  $L_{1H}$  in the high-voltage side charging branch an inductive voltage divider. The voltage across the spark gap can be calculated from Equation (7) as the sum of the charging voltage of  $C_1$  and the secondary pulse voltage multiplied by the divider ratio.

$$U_{S_1} = U_{C_1} + \frac{L_{1H}}{L_{1H} + L_{TIG,eff}} U'_{Pulse} \quad (7)$$

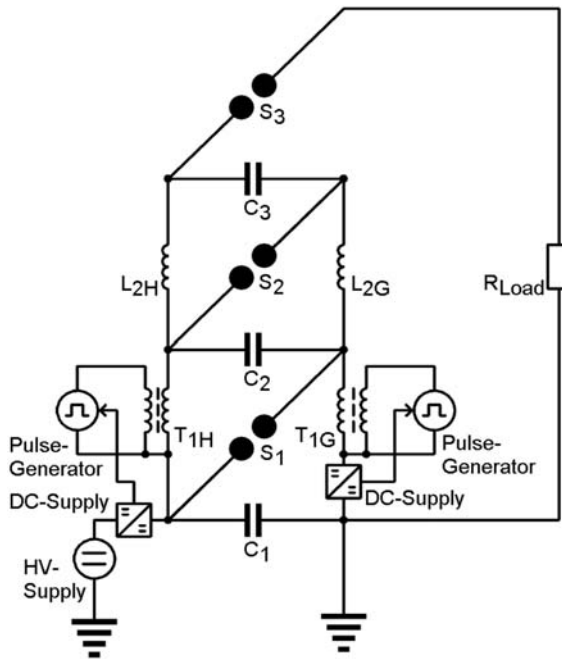
For the fast rising trigger pulse, the stage capacitors  $C_1$  and  $C_2$  can be regarded to be of low impedance. The equivalent inductance of the arrangement is given by

$$L_{1,eq.} = \frac{L_{1H} \cdot L_{TIG,eff}}{L_{1H} + L_{TIG,eff}} \quad (8)$$

Provided, that both inductances are of the same order the voltage across the spark gap is only approximately half of the secondary trigger pulse amplitude. The equivalent inductance is approximately half of the inductance in each branch.

To compensate for the effect of the voltage divider, the secondary pulse voltage might be increased. But this measure is at the expense of greater effort for the insulation of the pulse transformer, and of more energy required to charge its stray capacitances to a higher voltage. Alternatively, each of the two charging branches can be equipped with the described combination of trigger transformer and trigger pulse generator as shown in Fig. 6. Both pulse generators need to be synchronized since they drive the load in a parallel configuration. If both trigger pulse generators have equal amplitudes, there is no leakage current through either of the two branches.

Using the Marx generator in a common unipolar configuration the pulse circuit consisting of the generator and the electroporation reactor as a load is preferably grounded at the electroporation reactor rather than at the Marx generator. In this way the inductive voltage drop across the ground connection between the generator and the reactor does not lead to any additional current flow along the product stream. Such a leakage current would be undesirable since it reduces the efficiency of the device. But in such a configuration the ground side of the Marx generator floats at 10–20 kV above ground. In case of an accidental flash-over bridging the electrodes inside the electroporation reactor, the floating voltage above ground could become even higher. If the trigger circuitry is empowered from the ground side, the trigger transformers or an extra insulated power supply have to be designed to withstand this voltage. For the transformer–pulse generator combination at the high-voltage side of the charging branch the charging voltage has to be considered additionally.



**Fig. 6** Improved scheme of a trigger concept without a trigger electrode with one transformer–pulse generator combination in each charging branch powered by the Marx generator’s charging current

To overcome these insulation requirements, the trigger pulse generators can be empowered by the charging current of the Marx generator. A DC power supply performs a kind of impedance matching, so that the storage capacitor of the trigger pulse generator can be charged together with the stage capacitors of the Marx generator. Additionally, it delivers the auxiliary power required for the control circuitry and for the fiber-optic receiver used to synchronize the pulse generation.

### 2.4 Burn-Up Control Scheme

Several possibilities exist to determine the growth of the gap in the switches due to burn-up: Mechanical or optical measurements of the gap width, although possible in principle, are costly and may require periodic interruptions of operation. Therefore, we prefer to derive a control parameter from changes of the switching characteristics itself.

During pulsed breakdown of a spark gap we can distinguish several time steps:  $t_0$  the time until the static breakdown voltage  $U_0$  is exceeded,  $t_s$  the statistical delay time until an avalanche effective electron appears in the gap,  $t_a$  the avalanche buildup time until the critical charge density for streamer propagation is reached and  $t_{arc}$  the time until a low-resistance arc across the gap has been established (Bluhm 2006). If

we assume that the times  $t_0$ ,  $t_s$ , and  $t_{\text{arc}}$  are short compared to the avalanche buildup time the time integral of the applied voltage  $U(t)$  above  $U_0$  is a constant that just depends on the gap geometry (Kind 1958):

$$\int_{t_0+t_s}^{t_0+t_s+t_a} [U(t) - U_0] dt = F \quad (9)$$

Here  $F$  is a constant depending on the gap geometry.  $t_0$  and  $t_s$  can be considered to be small if the voltage across the gap rises very fast and  $t_{\text{arc}}$  is always quite short. In addition we can reduce  $t_s$  even further if the start electrons are supplied from a corona discharge that appears in the gap during charging of the capacitors. In the trigger scheme described before the shape  $U(t)$  of the trigger pulse remains constant. Therefore, any deviations of the integral in Equation (9) reflect changes of the gap geometry which determines both  $t_a$  and  $U_0$ .

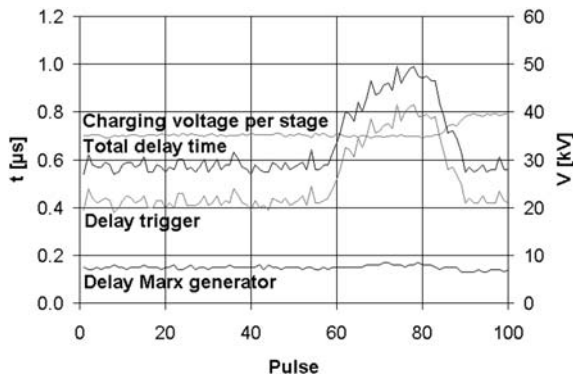
For practical reasons it is advantageous to choose as the control parameter the avalanche buildup time  $t_a$ . For that purpose the light pulse from the first spark gap of the Marx generator can be analyzed. If we determine the time difference between the initiation of the trigger generator and the light signal from the spark gap and subtract the constant delay of the trigger circuitry we get a measure of the gap geometry, which can be used to control the gap distance or the switch gas pressure. As the measurement exhibits some scattering due to the jitter, it is necessary to do an averaging before the processing.

Figure 7 demonstrates the effectiveness of this control process. Here instead of increasing the gap distance in the switches we changed the breakdown characteristics of the spark gap switches by increasing the gas pressure from 1.15 bar to 1.25 bar leading to an increase of the ignition delay. The figure shows the trigger delay, that is, the time between the signal to the trigger generator and the breakdown of the first spark gap, the delay to ignite the remaining spark gaps of the Marx generator (delay Marx generator), the total delay time as the sum of both curves, and the charging voltage per stage. Initially, the pressure had been stabilized to a trigger delay of 0.4  $\mu\text{s}$  in the first gap for a charging voltage of 35 kV per stage. Raising the pressure to 1.25 bar the delay doubled and became 0.8  $\mu\text{s}$ . It came back to the initial value after the charging voltage was increased to 40 kV.

Since the trigger delay is a statistical process the signals need to be averaged over several shots before an adjustment of the switch gap is made. Naturally the fine tuning of the switch will become easier if the jitter of the trigger delay is small. A small jitter is also required to obtain a good synchronization of several Marx generators. A necessary condition for small jitter is a fast rising trigger pulse. In addition pre-ionization of the spark gap can appreciably reduce this jitter.

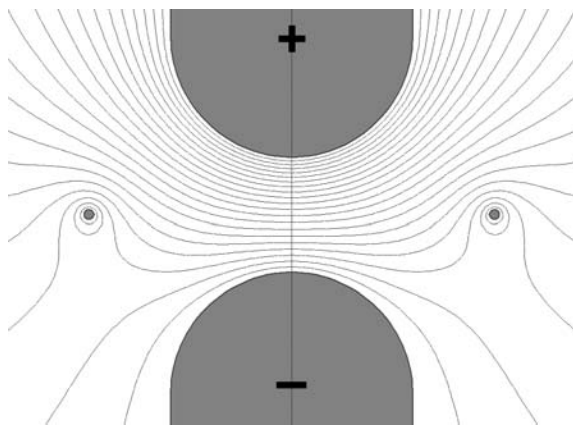
For that purpose a passive corona discharge has been applied. The corona discharge is established around a thin wire which is electrically connected to the negatively charged electrode of the spark gap. Because of the electron emission a negative glow discharge is more stable than a positive one. The wire is bent to a ring and mounted at some distance around the electrode gap in such a way, that





**Fig. 7** Demonstration of switch control by measurement of the delay of spark ignition in the first gap. Before pulse 60 the pressure and the charging voltage had been adjusted to 1.15 bar and 35 kV respectively. From pulse 60 on the pressure was gradually raised to 1.25 bar, while the charging voltage was still kept at 35 kV. From pulse 85 on the voltage was readjusted to reach the previous trigger delay of 0.4  $\mu$ s

the glow discharge around the wire radiates UV light into the gap and onto the electrodes. The ring-like structure causes a symmetric radiation and electron injection fostering together with a homogeneous field distribution a homogeneous wear along the electrode surface. The diameter of the wire and the distance from the electrodes is chosen such that on the one hand the inhomogeneous field around the wire is sufficient to establish the glow discharge. On the other hand, the field inside the space between the wire and the electrodes is chosen low enough to inhibit a direct discharge between the wire and the positive electrode. Figure. 8 shows the equipotential lines of a non optimized configuration with spherical electrodes.



**Fig. 8** Equipotential distribution in a spark gap with spherical electrodes surrounded by a corona wire to supply sufficient start electrons before the application of the trigger pulse

To achieve a homogeneous field distribution similar to the field configuration of the undisturbed Borda profile the shape of the electrodes needs further optimization to compensate for the influence of the corona ring.

It has been experimentally confirmed that a small jitter of the time delay can be achieved with this setup. A jitter ( $2\sigma$ ) of the total switching time of less than 92 ns has been obtained for a charging voltage of 90% of the self-breakdown value.

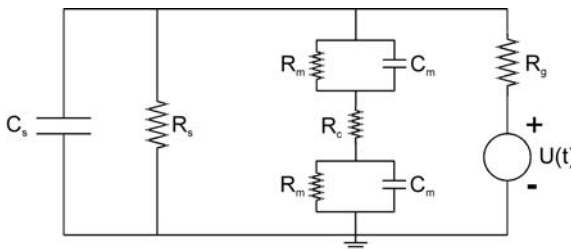
## 2.5 Screening of the Degree of Electroporation

To verify that the desired degree of electroporation of the treated plant cell tissue is achieved a continuous measurement is required. In principle it is possible to draw samples from the stream of treated plant cells and to determine the achievable product yield in a laboratory. However this procedure seems rather slow and probably not acceptable. Therefore, an in situ measurement technique is necessary.

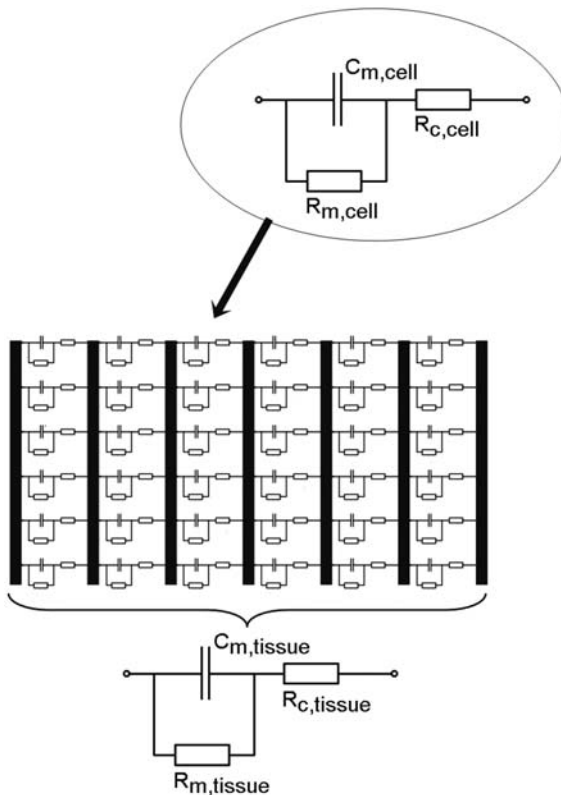
Such a technique can be based on considerations about the equivalent electric circuit of cell tissue. A single biological cell in a conducting suspension connected to a pulse generator can be represented by the circuitry shown in Fig. 9.

A cell tissue can be modeled by a complex parallel and series arrangement of such equivalent circuits, bridged by additional resistors representing ohmic current paths around the cells, formed, for example, by capillaries (Fig. 10 centre). However, such a network can be formally restructured to a network of the same simplified structure as for a single cell but with values for the elements that depend on the geometry (Fig. 10 right).

The specific resistance of a cell membrane has been measured by Greenham to be of the order of 3000 Ohm  $\text{cm}^2$  (Greenham 1966). Pores forming in the membrane cause a reduction of the membrane resistance while the membrane capacitance is little affected. Nevertheless the frequency response of the tissue network can change appreciably.



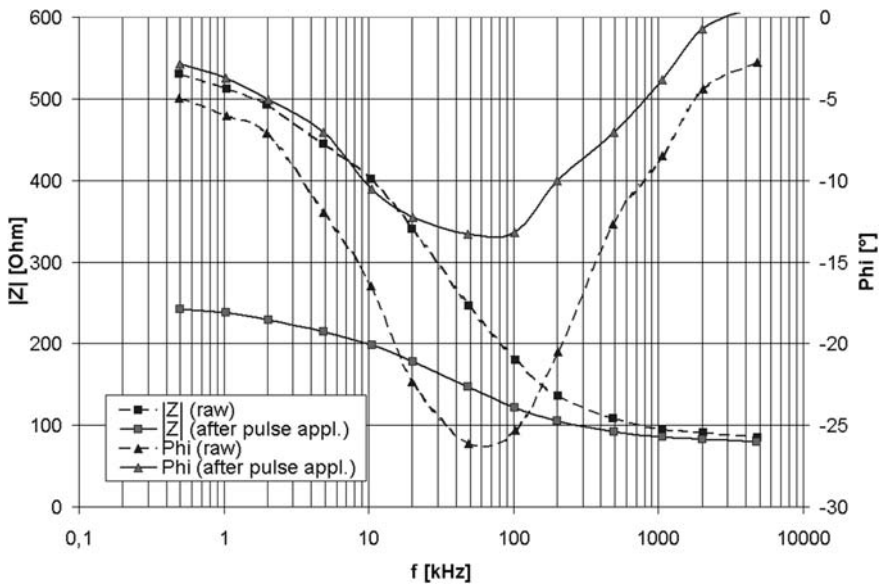
**Fig. 9** Equivalent circuit of a biological cell.  $R_m$  = membrane resistance,  $C_m$  = membrane capacitance,  $R_c$  = resistance of cytoplasm,  $R_s$  = resistance of suspension outside the cell,  $C_s$  = stray capacitance bypassing the cell,  $R_g$  = generator impedance,  $U(t)$  = time-dependent voltage pulse



**Fig. 10** Simplified equivalent circuits of a single biological cell (*top*) and of cell tissue (*bottom*)

Therefore, it has been proposed to derive the value of  $R_{m,tissue}$  from an impedance measurement at two frequencies sufficiently apart and to use the result as a measure of the degree of electroporation that has been achieved (Angersbach et al. 1997, 1999; Lebovka et al. 2000, 2001). At a low frequency in the range of several hundred hertz, the capacitive part of the current through the cell membrane becomes negligible; hence, the sum of  $R_{s,tissue}$  and  $R_{m,tissue}$  is obtained. At a high frequency in the range of several megahertz, the capacitance is short-circuited and only the value of  $R_{s,tissue}$  will be measured.  $R_{m,tissue}$  can be calculated from the difference of both results. The cell tissue is considered to be electroporated completely, when  $R_{m,tissue}$  has fallen to several ohms. Then the membranes of many cells will have been denatured and the cytoplasm will penetrate into the space outside the cell enclosure. This diffusion process is supported by the inner pressure of the cells.

The described method works fine for small reactors, where the inductivities of the leads can be neglected. Figure. 11 shows the complex impedance of a cubical sugar beet sample in the frequency range between 100 Hz and 10 MHz. It is evident that in this case the upper frequency needs to exceed 5 MHz. To use this method in a large-scale industrial reactor, electrode separations of several 10 cm have to be



**Fig. 11** Complex impedance of a cubical sample ( $125 \text{ cm}^3$ ) from a sugar beet both for raw and treated material

bridged. In these cases, one cannot neglect the effect of inductances which together with stray capacitances can form a resonant circuit.

Furthermore, it will take between 1 and 2 s to probe the reactor with two frequencies. Therefore, in a stream of plant material the probed samples will not be identical resulting in erroneous measurements, if the flow is inhomogeneous. A simultaneous measurement at two frequencies could avoid this problem. However in this case it would become necessary to investigate, whether the biological system is linear enough for the two measurement frequencies not to influence each other. Anyway, the measurement device would be more complex.

To overcome these difficulties a new measurement method has been proposed (Sack and Bluhm 2007). It is based on the change of the phase angle between voltage across the sample and current through the sample with frequency. Especially at medium frequencies the influence of the capacitive current flow through the cell membranes on the phase shift becomes quite strong. For sugar beets the phase shift is maximal at approximately 50 kHz, both for raw and partly electroporated beets. As the capacity  $C$  becomes more and more shorted while the electroporation progresses, the phase angle decreases and can be taken as a measure for the degree of electroporation that has been reached. If all cells were completely opened, the phase angle should come close to  $0^\circ$  in the ideal case.

Conducting the measurements at frequencies around 50 kHz ensures that the influence of stray inductances remains small. In addition using just a single frequency makes continuous monitoring of the degree of dissociation of the plant cell material

much easier. We can determine the phase shift between the current and voltage signals just from the time difference between their zero crossings.

### 3 Emerging Industrial Applications

#### 3.1 Treatment of Sugar Beets

Probably the most advanced large scale industrial application of electroporation is the treatment of sugar beets. The standard procedure of sugar production from beets consists of carving the fruits into cossettes and subsequently extracting the juice from these cossettes at elevated temperatures with as little water as possible (Schiweck and Clarke 2001). The sugar dissolved in the cell juice can leave the beet cossettes only if the cell and vacuole membranes have been destroyed. In modern sugar plants this is achieved by thermal denaturation at temperatures above 70°C (Fig. 12). The transport of sugar and other water-soluble substances from the inside of the cossettes to the extraction water occurs by diffusion. Since the diffusion coefficient is temperature dependent the extraction temperature should be as high as possible. However, at too large temperatures, considerable amounts of structural substances from the cell walls are also denatured and become water soluble. Thus impure raw juices are achieved which need extensive processing. Therefore a temperature course is applied which represents a compromise: Denaturation is achieved by heating the cossettes to 70–78°C for a short time and extraction is carried out at 69–73°C.

The temperature course also influences the surviving of microorganisms introduced into the process by soil from the beets. The metabolism of these bacteria can lead to sugar losses. Some organisms are not at all inhibited at the applied temperatures and therefore disinfectants (e.g., hydrogen peroxide and formalin) are generally introduced into the extraction system.

Appreciable energy savings and less expensive purification procedures are conceivable if the juice extraction could be carried out at much reduced temperatures. The use of PEFs as a nonthermal method for the breakage of cell membranes in vegetables has first been described by Doevensbeck and Flaumenbaum (Doeven-speck 1962; Flaumenbaum 1967). Recently it has been proposed to use a combination of pressing and PEF-treatment for the extraction of juice from sugar beets (Bouzzara and Vorobiev 2000, 2001; Jemai and Vorobiev 2003; Eshtiaghi and Knorr 2002). Although this process can lead to a much reduced energy consumption it represents a completely new technology and requires a redesign of the entire sugar plant. Also it seems difficult to scale-up their proposal from the laboratory level to the large throughputs of up to 15 000 t/day required for an economic sugar factory.

Here we restrict the discussion to a different approach which aims at integrating the pulsed electric field treatment into the production line of existing sugar plants as indicated in Fig. 12 (Schultheiss et al. 2002, 2004).

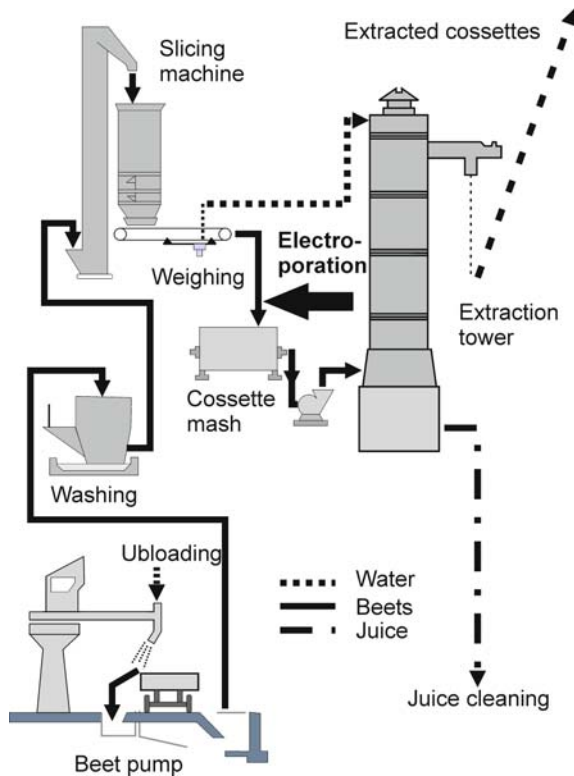


Fig. 12 Entrance stage of a conventional sugar factory

To demonstrate the potential advantages of electroporation for the extraction of juice from sugar beet cells the mobile test device KEA (Karlsruher Elektroporations Anlage – Karlsruhe electroporation device) was built in the Research Centre Karlsruhe and used in several experimental campaigns at a sugar factory. A general view of the facility is shown in the left part of Fig. 13. The treatment chamber shown in the right part was built from a polypropylene-tube of 18 cm inner diameter. It contains four electrode pairs constructed from stainless steel. Each pair consisted of two disk shaped electrodes of 4 cm diameter, axially and azimuthally displaced by 16 cm and  $90^\circ$  respectively. The twisted electrode pairs secured that each cell of an entire sugar beet passing through the tube had seen at least the minimum field at the centre between two electrodes. At nominal pulse voltage this field reached a value of in average 8.8 kV/cm. The treated beets leaving the reaction tube were transported to a tub with the help of a screw conveyor visible on the left side in Fig. 13. A maximum throughput of 300 kg/hour could be handled with this setup.

High voltage pulses with amplitudes of up to 220 kV were created with the help of a six-stage low-impedance Marx generator. Discharging the Marx into the reaction chamber a unipolar pulse of about 1  $\mu$ s duration is achieved. Each pulse



**Fig. 13** The mobile test device KEA used to demonstrate the potential advantages of electroporation for the production of sugar from sugar beets. The left part shows the complete set up. The photo on the right depicts the treatment vessel

represents an electrical energy of 0.75 kJ. The Marx was capable to run at a repetition rate of 10 Hz. Both the Marx generator and the reaction tube were housed in a Faraday cage to eliminate the emission of electromagnetic noise. The high voltage supply is a 10 kW commercially available unit.

At first entire sugar beets were treated. After treatment they were cut into pieces and either cold pressed or extracted in water at different temperature levels. Figure 14 shows a cut through sugar beets before and after treatment in the reaction chamber together with the corresponding yield of juice obtained by cold pressing with 32 bar pressure for 15 min. Juice droplets appearing on the cut surface of the treated beet are indicative that the cell membranes have been destroyed by the



**Fig. 14** Cut through sugar beets before and after treatment in the reaction chamber together with the corresponding yield of juice obtained by cold pressing with 32 bar pressure for 15 minutes

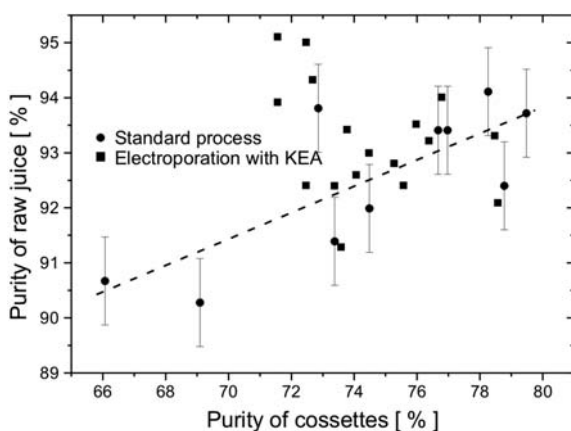
pulsed electric fields. It has been found that the same specific yield as through thermal denaturation at 72°C could be achieved with much lower specific energy input. Thus, it is evident that electric pulse treatment has a large potential for energy saving.

Besides by cold-pressing the sugar beets treated in the KEA reaction chamber were also extracted by diffusion into water. It was found that the same sucrose extraction as in the standard procedure at 72°C could be achieved at lower temperatures. Since the mobility of the sugar molecules decreases with falling temperature longer extraction times would become necessary at too low temperatures, thus reducing the achievable mass throughput. Therefore, a compromise has to be found, which is considered to be below 70°C. At this temperature a thermal dissociation of cell substances does not yet occur and we can expect a purer raw juice draft.

As shown in Fig. 15 this has indeed been observed. Here the raw juice purity—defined as the sucrose fraction in the juice—has been plotted versus the cossette purity—defined as the ratio of sugar to the total solid mass in the beet. It is seen that especially for beets of lower quality electroporation and extraction at lower temperatures lead to improved juice purity. Generally there is always a mixture of beet qualities entering the sugar factory.

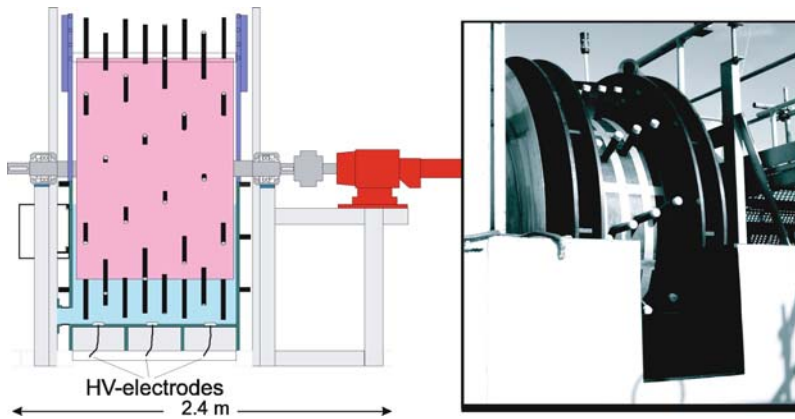
In addition to the benefits described above it has also been found that the raw juice draft (i.e., weight of juice/weight of beet), which in the standard procedure is around 110%, could be significantly reduced, without changing the sucrose extraction. For thermal reasons it is desirable to attain the lowest possible raw juice draft.

Summarising the results, it is obvious that replacing the normal thermal treatment at elevated temperatures (>70°C) for denaturation by the application of pulsed electric fields in the process line of a sugar factory leads to numerous advantages. There are two major areas for energy saving in a sugar factory by adding an electroporation step to the process line: Extraction can be carried out at lower temperatures and with



**Fig. 15** Raw juice purity versus cossette purity. At low beet quality the raw juice purity obtained from treatment with PEFs is superior





**Fig. 16** Transport drum and reactor vessel of the 10 t/hour sugar beet electroporation facility KEA-ZAR

lower raw juice draft. It seems feasible to integrate the electroporation step into the process line without requiring major changes of the other components of the sugar plant.

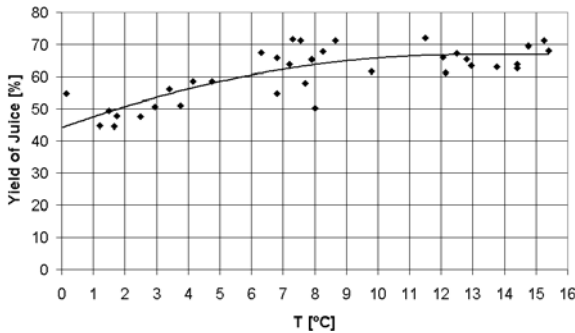
Encouraged by the findings with the mobile plant the demonstration plant KEA-ZAR was built at a factory site (Frenzel et al. 2005). This facility allowed a throughput of up to 10 t/hour. Its reaction chamber consisted of a coaxial cylindrical set up. The inner cylinder providing the beet transport was a plastic drum with spikes protruding from its surface (Fig. 16). The high-voltage electrodes were placed in the jacket of the outer cylinder. The ground electrodes were stainless steel ribbons mounted on the jacket of the inner cylinder.

The pulses were supplied from the two seven-stage Marx generators shown in Fig. 3, each delivering pulses with an amplitude of 210 kV at a frequency of 20 Hz. The complete facility is shown in Fig. 17. KEA-ZAR could demonstrate that the advantages of electroporation for the extraction of sugar from sugar beets can also be realized under the conditions of industrial production and the operating experience gained with KEA-ZAR will enter into the design of the next demonstration plant fully integrated into the factory and designed to treat a partial stream of up to 1500 t/day. KEA-ZAR has also shown that field homogeneity is important for the complete destruction of all beet cells.

Another important parameter for the disintegration of beet cells is the temperature at which the treatment is carried out. This is shown in Fig. 18, where the yield of juice has been plotted as a function of temperature for equal pulse parameters (30 pulses with  $E = 3$  kV/cm). Since beets are harvested in autumn and stored outside, their temperature can become close to  $0^{\circ}\text{C}$ . Experiments showed, that the amount of electrical energy needed for complete denaturation of cells increases with decreasing temperature (Frenzel et al. 2005). Therefore, an optimum processing strategy has to be developed, that is, comparing the costs for the delivery of higher electric fields with those of preheating the beets using the waste heat from the



**Fig. 17** Prototype facility KEA-ZAR during construction at the factory site



**Fig. 18** Yield of juice from sugar beet samples as a function of temperature for equal pulse protocols (30 pulses of 3 kV/cm)

concentration of raw juice in the later process stages of the factory. However, to warm up the entire stream of beets in the sugar factory seems not feasible because of the rather large thermal time constants. Therefore, it is more advantageous to cut the beets into cossettes which because of their smallness need much shorter times to warm up before treatment. An additional advantage of cossettes is that they allow a simpler transport concept without mechanical elements.

### 3.2 Treatment of Grapes

Bouquet, taste, and color of wine are decisively determined by the degree of disintegration of the skin cells of wine berries. Commonly this is either achieved by mash fermentation or by mash heating. In the first case alcohol is produced which then acts as the extractive agent (aqueous-alcoholic extraction). The disadvantage

of this process is that it is time consuming and therefore expensive. Mash heating (aqueous-thermal extraction) is quicker and very often supported by the addition of enzymes.

Electroporation of wine grapes is an alternative non-thermal process completed in a few seconds leading to a prudent extraction of colors and valuable constituents within hours (Eshtiaghi and Knorr 2000; Tedjo et al. 2002).

To explore the capabilities of electroporation for the production of wine a facility allowing a throughput of several tons per hour is required. Thus, it is possible to look into the complete process chain up to the final product. For that purpose the specially designed mobile facility KEA-Wein, shown in Fig. 19, has been built at the Research Centre Karlsruhe and operated in several campaigns between 2001 and 2006 together with the State-Institute on Wine-Cultivation in Freiburg, Germany and the company KEA-TEC GmbH (Sigler et al. 2005). KEA-Wein, was able to produce electric fields of up to 60 kV/cm in the reactor at a repetition rate of up to 15 Hz. It was able to handle a throughput of up to 1 t/hour at a connected wattage of 15 kW. The average specific energy consumption was around 15 kW-hour/t. To prevent a flash-over inside the reactor due to air bubbles the must can be pressurized up to a pressure of 8 bar.

Both red and white wine grapes have been treated (Sigler et al. 2005). Red Burgundy mash has first been electroporated in 2001 and compared to a control sample that was disintegrated by the usual heating process. To extract color and tanning substances both samples were left to stand for one night and then pressed, precleared and fermented into wine. As shown in Table 4 the tanning and acid concentrations of the electroporated must samples were somewhat lower than those of the control samples. However this can probably be changed by varying the electrical parameters. Nevertheless, the basic analytic data of the finished wine, especially the color and tanning agent values came very close to those of the control specimen.



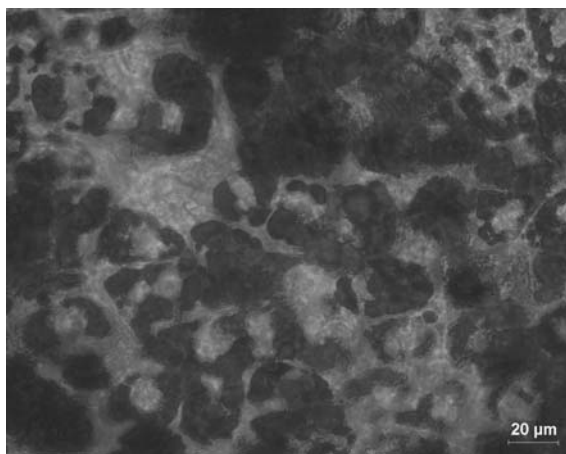
**Fig. 19** Mobile facility KEA-Wein for the treatment of grape mash with strong PEFs

**Table 4** Basic analytic data for red burgundy must and wine (2001) (Sigler et al. 2005)

|                      | Must (precleared)    |                        |                          |                  | Wine          |                     |                     |                  |                             |                              |                          |                 |             |                                  |
|----------------------|----------------------|------------------------|--------------------------|------------------|---------------|---------------------|---------------------|------------------|-----------------------------|------------------------------|--------------------------|-----------------|-------------|----------------------------------|
|                      | Must sweetness (°Oe) | Centrifugal sludge (%) | Tanning substances (g/l) | Total acid (g/l) | Alcohol (g/l) | Total Extract (g/l) | s.fr. Extract (g/l) | Total acid (g/l) | Free SO <sub>2</sub> (mg/l) | Total SO <sub>2</sub> (mg/l) | Tanning substances (g/l) | Color intensity | Color shade | Quality f. <sup>1</sup> (n = 48) |
| Control (MH)         | 96.5                 | 1.21                   | 2.8                      | 8.3              | 98.5          | 25.1                | 23.8                | 4.7              | 48                          | 131                          | 2.1                      | 2.47            | 0.95        | 2.17                             |
| Electro-<br>poration | 96.0                 | 1.37                   | 2.3                      | 6.9              | 104           | 24.7                | 23.2                | 4.1              | 51                          | 121                          | 2.0                      | 2.33            | 1.02        | 2.15                             |

Blind tasting by 48 knowledgeable persons resulted in indistinguishable quality ranking between both wines.

Additional campaigns were carried out in 2003 and 2004. It was the aim to reduce the centrifugal sludge content further by optimizing the hydraulic transport through the reactor and to extend the treatment to other types of grapes. The results were similar as in 2001 and showed especially high contents of digestible nitrogen in the must. Always rather high field strengths, on the order of 50 kV/cm, were required to get satisfactory color extraction. This finding has been attributed to the smallness of vacuoles in the cells of the skins containing the color (Fig. 20). Also it became apparent that the nonthermal aqueous extraction conditions allow new modified red



**Fig. 20** Microscopic picture of peel tissue of red Burgundy wine grapes showing several small, irregularly shaped color containing vacuoles per cell

wine profiles. Future experiments shall exploit this potential and evaluate whether a combination between electroporation and fermentation can lead to advantages.

From the vintage in 2002 Riesling mash without stalks has been treated. Both, the control and the electroporated sample were pumped through the facility. Therefore, the mechanical stress was equal and any differences in the result could solely be attributed to the effect of electroporation. For further comparison mash has also been prepared by whole-berry pressing (WBP). The results are presented in Table 5. As expected the must from the latter treatment showed the lowest sludge content while the electroporated sample had the highest sludge fraction. However in the precleared must the differences became small. Strikingly the must obtained from the electroporated mash showed lower acid values but higher contents of tanning agents and yeast digestible nitrogen. The finished wine from the electroporated variant was still characterized by a larger content of tanning substances and a larger amount of sugar free extract. Also remarkable is the higher fraction of potassium indicating complete cell disintegration.

Of much interest in the field of white wine preparation is the liberation of aromas and their precursors especially from the peels of the berries. Electroporation clearly led to the largest amount of aromas in the wine.

A sensual examination of the finished wines by 50 butlers clearly put the electroporated wine in the first rank and graded its quality with the highest valuation. In 2005 these results were confirmed for bouquet wines like Traminer.

Thus in the domain of white wines electroporation improves the extraction of type specific aromas and aroma precursors. As shown in Fig. 21 electroporation produces the highest yield of terpenes and other aroma substances.

Summarizing, electroporation of grapes allows an effective and prudent extraction especially of those substances contained in the cells of the berry skin. Therefore,

**Table 5** Basic analytic data for Riesling must and wine (2002) (Sigler et al. 2005)

|                  | Must (precleared)    |                        |                          | Wine             |               |               |                     |                     |                  |                             |                              |                          |                 |                   |
|------------------|----------------------|------------------------|--------------------------|------------------|---------------|---------------|---------------------|---------------------|------------------|-----------------------------|------------------------------|--------------------------|-----------------|-------------------|
|                  | Must sweetness (°Oe) | Centrifugal sludge (%) | Tanning substances (g/l) | Total acid (g/l) | Dig. Nitrogen | Alcohol (g/l) | Total Extract (g/l) | s.fr. Extract (g/l) | Total acid (g/l) | Free SO <sub>2</sub> (mg/l) | Total SO <sub>2</sub> (mg/l) | Tanning substances (g/l) | Potassium (g/l) | Ranking. (n = 50) |
| WBP Comparison   | 82                   | 0.80                   | 0.22                     | 11.1             | 25            | 99.0          | 21.5                | 18.2                | 6.7              | 44                          | 85                           | 0.26                     | 498             | 2.3               |
| Control (pumped) | 77                   | 0.97                   | 0.33                     | 9.2              | 32            | 96.2          | 19.4                | 19.3                | 6.7              | 43                          | 83                           | 0.33                     | 585             | 2.5               |
| Electroporation  | 79                   | 0.80                   | 0.57                     | 8.6              | 37            | 98.9          | 20.6                | 20.5                | 6.8              | 41                          | 92                           | 0.38                     | 776             | 1.3               |

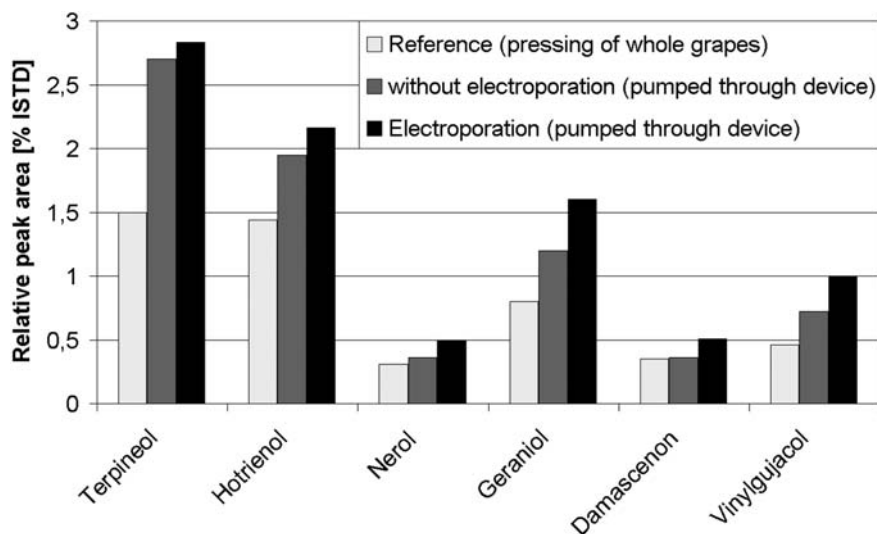


Fig. 21 Aroma substances in Riesling wine after different kinds of processing

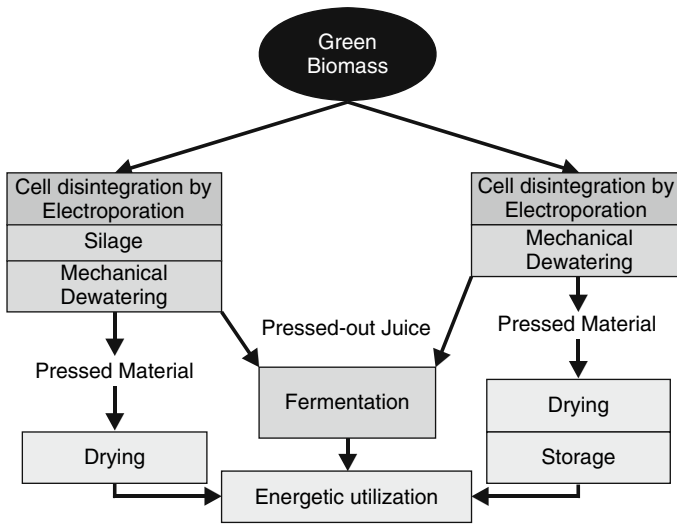
it offers the potential to develop wines of new characters and flavors. It can either be applied as a self-contained method or in combination with common methods. In case of red must preparation it can lead to economic advantages by either reducing the energy cost or the time for color extraction. Despite these obvious advantages a license for the use of electroporation in wine production is still pending.

### 3.3 Conditioning of Green Biomass by Electroporation Assisted Dewatering

To exploit the unrealized energetic capacity of biomass, which has been estimated to potentially cover up to 20% of the present energy consumption in Europe, it is indispensable to cultivate energy plants.

Among all sources, agriculture has the largest potential for a directed production of energetically useable biomass. Therefore it is to be expected that the cultivated area for energy plants like corn, lupines, etc., shall grow appreciably. In addition new cultivation concepts like the two-culture utilization system promise an essential increase in the yield of dry biomass while simultaneously relieving cultivated ecosystems (Scheffer 2003). In this concept it is intended to harvest nonripened plants. However, their energetic utilization requires new concepts for preservation and dewatering. Commonly ensilage is presently used for preservation. But the energetic utilization of silage especially for the production of liquid fuel from biomass (biomass to liquid (BTL) process) requires extensive dehydration by pressing and heating.

As depicted in Fig. 22 electroporation could support drying and establish a new procedure for preservation of green biomass. It is conceivable that the degradation



**Fig. 22** Concept of electroporation assisted dewatering of green biomass. The figure shows the two possible paths to store biomass and to prepare it for utilization in a BTL process

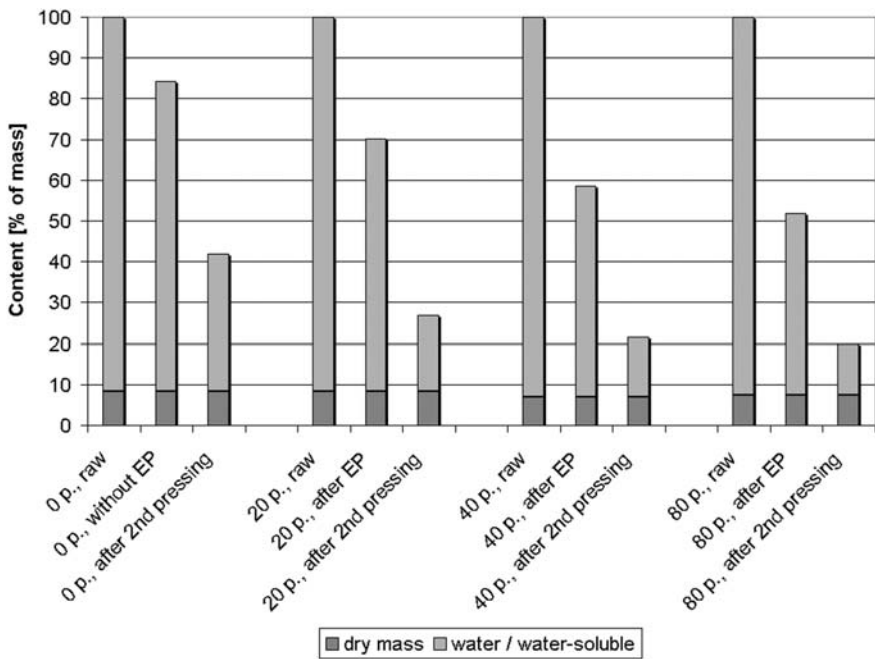
of cells before ensilage facilitates the pressing of silage. An alternative preservation concept, which becomes especially attractive for the green biomass produced in the two-culture concept, can be based on electroporation assisted pressing and additional drying by heating. If the degree of moisture in the dried biomass falls below 15–20%, it becomes storable for longer time.

The pressed-out juice contains fine grinded and easily solvable and breakable organic substances and is therefore considered as the ideal substrate for further utilization in biogas plants.

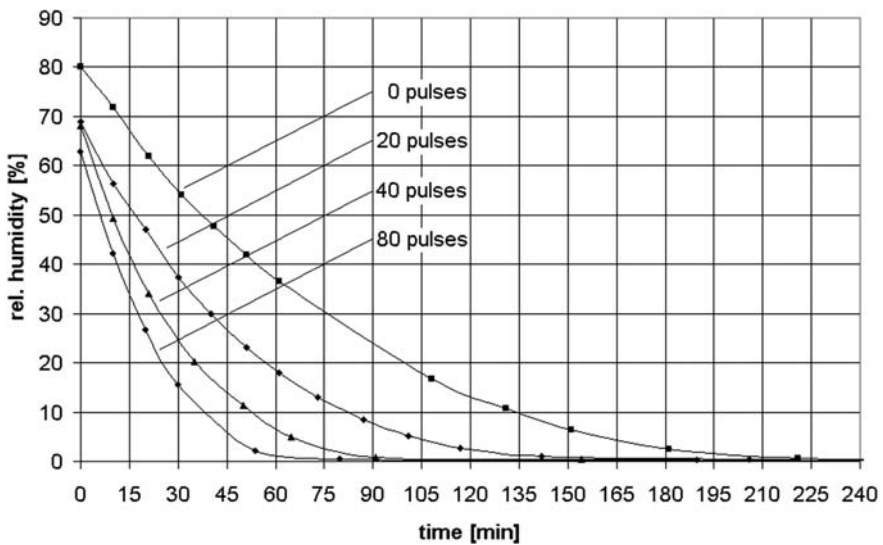
For the electroporation of plant material, a good electric contact to the electrodes is essential. Therefore, usually the material is either suspended in water or treated as mash. But for the dewatering of green biomass aiming at rather low water contents both methods cannot be applied. Any process water added for electroporation has to be removed in the subsequent drying step.

Hence, some water from the plant material is extracted in a pressing step before electroporation. The juice fills the space between the plant material and the electrodes and displaces the air. Moreover, this step compacts the material and thus improves the effectiveness. During electroporation the mechanical pressure is kept constant. The electroporation-assisted dewatering process starts already during pulse application. In case of a batch process with the force applied through a piston, the piston moves down a bit as the water is extracted from the opened cells.

After electroporation water is further extracted by pressing. As an example Fig. 23 shows the relative contents of dry mass and juice with water soluble substances for young maize plants after electroporation and the subsequent pressing step after varying numbers of pulses at a field strength  $\hat{E} = 7 \text{ kV/cm}$  and a pulse



**Fig. 23** Relative contents of dry mass and water with water-soluble substances for young maize plants after electroporation with growing numbers of pulses ( $\hat{E} = 7 \text{ kV/cm}$ ,  $t_h = 1.6 \text{ }\mu\text{s}$ ) and a subsequent pressing step (Sack et al. 2007)



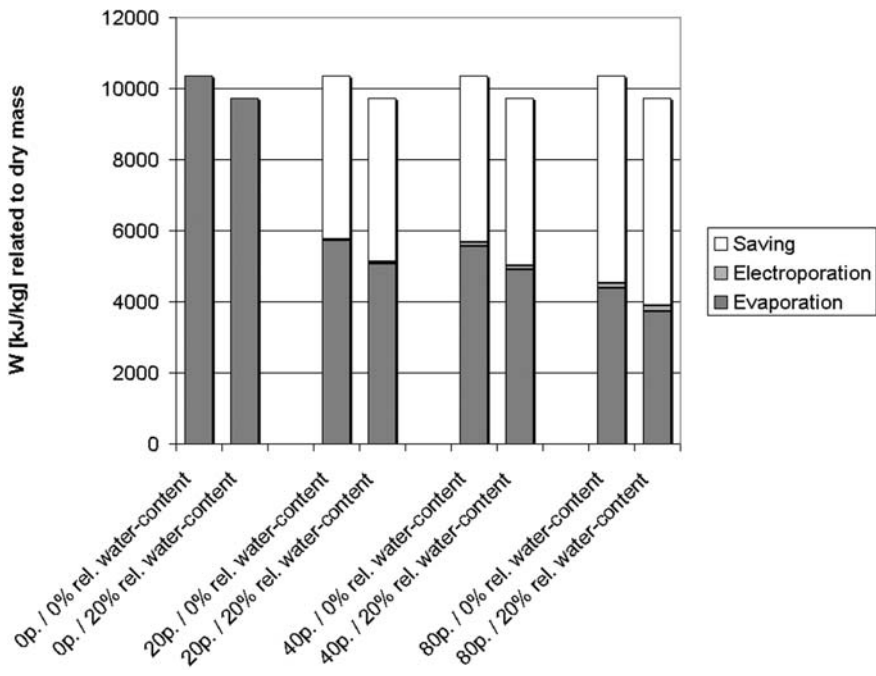
**Fig. 24** Temporal decrease of the relative humidity for young maize plants during thermal drying at  $105^\circ\text{C}$  ( $\hat{E} = 7 \text{ kV/cm}$ ,  $t_h = 1.6 \text{ }\mu\text{s}$ ). The curves are for plants treated with different numbers of pulses



duration of  $t_h = 1.6 \mu s$ . Without electroporation approximately 63% of the juice can be extracted. This fraction increases with the number of applied pulses to 85% after applying 80 pulses. Nevertheless the relative humidity in this case is still 63%.

The required relative humidity of 15–20% is achieved in a subsequent drying process. Fig. 24 shows the temporal decrease of the relative humidity during a thermal drying process in an oven at 105°C. The electroporation-assisted drying enables a much faster processing. The diagram shows that after application of 80 pulses the threshold value of 20% relative humidity is reached in one quarter of the time needed for nonelectroporated material.

In Fig. 25 the required energy per kg of dry mass to achieve a relative rest humidity of 0% and 20% for young maize plants treated with different numbers of electrical field pulses has been plotted. Here the energies were divided into energy for electroporation and energy for evaporation. The electric energy required for electroporation was always small compared to the thermal energy for the drying process. In case of 80 pulses it amounted to 150 kJ per kilogram dry mass while the necessary thermal energy became about 3700 kJ/kg. Without electroporation a total specific energy of approximately 10000 kJ/kg was needed. These findings clearly demonstrate a considerable energy saving potential. However, a complete



**Fig. 25** Required energy per kg of dry mass to achieve relative rest humidity of 0% and 20% respectively for young maize plants treated with different pulse numbers ( $\dot{E} = 7 \text{ kV/cm}$ ,  $t_h = 1.6 \mu s$ ). The energies have been split into energy for electroporation and evaporation

energy balance still needs a more careful consideration of heat recycling and to take into account the efficiency of electric energy conversion in the electroporation step.

## References

- Angersbach A, Heinz V, Knorr D (1997) Elektrische Leitfähigkeit als Maß des Zellaufschlussgrades von zellulären Materialien durch Verarbeitungsprozesse. *LVT* 42(4): 195–200.
- Angersbach A, Heinz V, Knorr D (1999) Electrophysiological model of intact and processed plant tissues: cell disintegration criteria. *Biotechnol. Programm.* 15: 753–762.
- Belkin GS (1971) Dependence of electrode erosion on heat flux and duration of current flow. *Sov. Phys. Tech. Phys.* 15(7): 1167–1170.
- Belkin GS and Kiselev VYa (1977) Effect of the medium on the electrical erosion of electrodes at high currents. *Sov. Phys. Tech. Phys.* 23(1): 24–27.
- Bluhm H (2006) *Pulsed Power Systems*. Springer, Berlin, Heidelberg, New York.
- Borda JC (1766) Sur l'écoulement des fluids par les orifices des vases. *Mém. Acad. Roy. Sciences, Année 1766*: 579–607.
- Bouzzara H, Vorobiev E (2000) Beet juice extraction by pressing and pulsed electric fields. *Int. Sugar J.* 102(1216): 194–200.
- Bouzzara H, Vorobiev E (2001) Nicht-thermisches Pressen und Auswaschen von frischen Zuckerrübenschnitzeln kombiniert mit der Anwendung eines pulsierenden elektrischen Feldes. *Zuckerindustrie* 126: 463–466.
- Doevenspeck H (1962) Über die Beeinflussung von Zellen und Zellverbänden durch elektrostatische Impulse. *Archiv für Lebensmittelhygiene* 13(3): 68–69.
- Donaldson AL (1990) Lifetime considerations. In: *Gas discharge closing switches*. G. Schaefer, M. Christiansen, and A. Guenther Eds., Plenum Press, New York: 325–344.
- Donaldson AL (1991) Electrode erosion in high-current, high-energy transient arcs. Thesis Texas Tech University, Lubbock, Texas USA.
- Eshtiaghi M, Knorr D (2000) Anwendung elektrischer Hochspannungsimpulse zum Zellaufschluss bei der Saftgewinnung am Beispiel von Weintrauben. *LVT* 45(1): 23–27.
- Eshtiaghi M, Knorr D (2002) High electric field pulse pretreatment: potential for sugar beet processing. *J. Food Eng.* 52: 265–272.
- Flaumenbaum B (1967) Anwendung der Elektropasmolyse bei der Herstellung von Fruchtsäften. *Die Lebensmittel-Industrie* 8: 19–22.
- Frenzel S, Michelberger T, Sack M, Bluhm H, Kern M (2005) Entwicklung und Bau einer Elektroimpuls-Pilotanlage. Abschlussbericht, Förderkennzeichen 0330434, *TIB-Hannover*, 2005.
- Greenham CG (1966) The Relative Electrical Resistances of the Plasmalemma and Tonoplast in Higher Plants. *Planta (Berl.)* 69: 150–157.
- Haufe W, Reichel W, Schreiner H (1972) Losses of varying types of CuW sintered impregnation material in the air at high current levels. *Zeitschrift für Metallkunde* 63(10): 651–654.
- Jemai A, Vorobiev E (2003) Enhanced leaching from sugar beet cosettes by pulsed electric fields. *J. Food Eng.* 59: 405–412.
- Kind D (1958) Die Aufbaufläche bei Stoßspannungsbeanspruchung technischer Elektrodenanordnungen in Luft. *Elektrotechnische Zeitschrift* 79(3): 65–69.
- Lebovka N, Bazhal M, Vorobiev E (2000) Simulation and experimental investigation of food material breakage using pulsed electric field treatment. *J. Food Eng.* 44: 213–223.
- Lebovka N, Bazhal M, Vorobiev E (2001) Pulsed electric field breakage of cellular tissues: Visualisation of percolative properties. *Innov. Food Sci. Emerging Technol.* 2: 113–125.
- Marx E (1923) Verfahren zur Schlagprüfung von Isolatoren und anderen elektrischen Vorrichtungen. German Patent 455933.

- Marx E (1924) Versuche über die Prüfung von Isolatoren mit Spannungsstößen. *Elektrotechnische Zeitschrift* 25: 652–654.
- Sack M, and Bluhm H (2005) Long-term Test of a Triggered Marx Generator, Proc. Pulsed Power Conference 2005, Monterey, DVD-ROM.
- Sack M and Bluhm H New Measurement Methods for an Industrial Scale Electroporation Facility for Sugar Beets, Proc. OPTIM 2006, Vol. 1 pp. 135–140, Brasov, Romania, May 18–19, 2006.
- Sack M, Eing C, Buth L, Berghöfer Th, Frey W, Bluhm H (2007) Electroporation as an optimizing step in the drying of green biomass, Proc. Pulsed Power and Plasma Science Conference, Albuquerque 2007, DVD-ROM.
- Sack M, Schultheiss C, Bluhm H (2003) Wear-less Trigger Method for Marx Generators in Repetitive Operation. 14th IEEE Pulsed Power Conf., Dallas, Tex., June 15–18, 2003.
- Sack M, Schultheiss C, and Bluhm H (2005) Triggered Marx Generators for the Industrial-Scale Electroporation of Sugar Beets. *IEEE Trans. Industry Applications*, 41(3): 707–714.
- Scheffer K (2003) Der Anbau von Energiepflanzen als Chance einer weitere Ökologisierung der Landnutzung, *Mitt. Ges. Pflanzenbauwiss.* 14: 114–119.
- Schiweck H, Clarke M (2001) In: Ullmann's Encyclopedia of Industrial Chemistry, Sixth Edition, 2001 Electronic Release, Wiley-VCH, Weinheim, Germany.
- Schultheiss C, Bluhm H, Mayer H, Kern M, Michelberger T, Witte G (2002) Processing of sugar beets with pulsed electric fields. *IEEE Trans. on Plasma Science* 30(4): 1547–1551.
- Schultheiss C, Bluhm H, Mayer H-G, Sack M, Kern M (2004) Die Wirkungsweise der Elektroporation und die Entwicklung industrieller Anlagen. *Zuckerindustrie* 129(1): 40–44.
- Sigler J, Schultheiss C, Kern M (2005) Maischeporation – ein neuer Weg der Weinbereitung. *Schweiz. Z. Obst-Weinbau* 16: 14–16.
- Tedjo W, Eshtiaghi M, Knorr D (2002) Einsatz nicht-thermischer Verfahren zur Zell-Permeabilisierung von Weintrauben und Gewinnung von Inhaltsstoffen. *Flüssiges Obst* 9: 578–583.
- Tsakamoto S, Maeda T, Ikeda M, and Akiyama H (2003) Application of pulsed power to mushroom culturing. Proc. 14th Pulsed Power Conference, pp. 1116–1119, Dallas 2003.
- Zingerman AG (1960) Thermal theory of the electrical erosion of metals. *Electrom.* 5(1): 1427–1485.

# Index

## A

Abidor, I.G., 3, 8, 11, 14  
Abram, F., 52–53  
Abu-Arabi, M.K., 219  
Acrylamide, 100  
Adenosine diphosphate (ADP), 86  
Adenosine triphosphate (ATP), 86  
Ade-Omowaye, B.I., 18, 68–69, 70, 200  
Agarwal, A., 43  
Aguilera, J.M., 70, 74, 108, 110, 113–114, 220  
Aizawa, M., 104  
Al-Asheh, S., 150  
Albagnac, G., 54, 59  
Algae (*Chlorella vulgaris*), 199  
Alginate gels  
    electrical treatment on mechanical properties, effect of, 104  
    influence of, on weight loss during electrification, 103–104  
    structural changes, 104–105  
Alkimov, A.P., 221  
Allen, M., 183  
Almdal, K., 99  
Altunakar, B., 186  
Amami, E., 68–69  
Ammonium persulfate, 100  
Anaerobic degradation, 206  
Andre, F., 7  
Anderson, G.L., 6  
Angersbach, A., 9, 18, 39, 45, 47, 193, 196, 200, 202, 253  
Antioxidant substances, 195  
Aouida, M., 24  
Apple juice processing, 194  
Aqueous extraction from oilseeds, 217–220  
    extraction enhanced by HVED, 225–226  
    extraction of soluble molecules, 226–230

    oil extraction, 230–233  
    quality of extracted products, 226  
    high-voltage electrical discharges, 220–221  
        condition of apparition, 221–222  
        material and energy, 222–224  
        steps of creation, 221  
        for various applications, 224–225  
    stages, 220  
Aqueous extraction of solutes from food plants, 62–68  
Araki, C., 102  
Archie, G.E., 45, 72  
Archie's exponent, 72  
Armisen, R., 105  
Aronsson, K., 52–53  
Atrualiyev, D.N., 18  
Axelsson, L.T., 85  
Ayhan, Z., 186, 189  
Ayres, R.A., 225

## B

*Bacillus licheniformis*, 170  
Bacteria and yeast, electroporation of, 18–19  
Baird, J.K., 102  
Bajgai, T.R., 70  
Balasa, A., 181, 195–196, 198, 202  
Balke, D.T., 219, 230  
Bansal, B., 192  
Barbosa-Cánovas, G.V., 39, 70, 97, 186, 189  
Bargeman, G., 172  
Barrau, C., 10–11  
Barskaya, A.V., 220, 223, 226–227  
Barsotti, L., 39, 203  
Barton, W.A., 145, 148  
Bayraktar, H.T.P., 20  
Bazhal, M.I., 46–48, 54, 56, 193–194  
Beattie, J.M., 183  
Beaudry, C., 70  
Beckett, S.T., 219

- Belatain, 199  
 Belkin, G.S., 243  
 Bellara, S.R., 169  
 Bendicho, S., 186, 190  
 Bennion, M., 100, 107  
 Benz, R., 88  
 Berg, H., 10  
 Bernhardt, J., 43  
 Betanin extraction, food industry and, 108–111  
 Beutner, R., 96  
 Beveridge, J.R., 9  
 Beveridge, T.J., 23  
 Bhatti, R.S., 219  
 Biedinger, U., 20  
 Biliaderis, C.G., 219  
 Bilska, A., 4  
 Bioactive peptides, 172  
 Biodiesel, 197  
 Biological tissues with pulsed electric fields, 237–238  
     emerging industrial applications  
         grapes, 260–264  
         green biomass by electroporation  
             assisted dewatering, 264–268  
         sugar beets, 255–260  
     pulse generators for industrial applications  
         burn-up control scheme, 249–252  
         generator configurations, 238–242  
         screening of the degree of electroporation, 252–255  
         spark gap switches, 242–246  
         synchronization, 246–249  
 Biomass sludge, 148  
 Bioseparation, 156  
 Bisacrylamide, 100  
 Blangero, C., 23  
 Block, L.H., 107  
 Bluhm, H., 218, 237, 239, 245–246, 249, 254  
 Borda, J.C., 243, 246, 252  
 Bourne, M.C., 111  
 Bouzrara, H., 54–57, 196, 255  
 Bovine Immunoglobulin G, 191  
 Bovine serum albumin (BSA), 171  
 Bozan, B., 219  
 Braakman, L., 186  
 Brandinsky, K., 15  
 Brant, D.A., 164  
*Brassica oleracea*, see Kohlrabi  
 Braudo, E.E., 108  
 °Brix of sugar beet juice, 64  
 Browning inhibitors, 112–113  
 Brunstedt, J., 88  
 BSA, see Bovine serum albumin (BSA)  
 Bureau, M.F., 7  
 Burkes, T.R., 221  
 Burn-up control scheme, 249–252  
 Bustard, M.T., 18  
**C**  
 Calderon-Miranda, M.L., 190  
 Calvert, P., 107  
 Canatella, P.J., 4–5, 14, 41, 44, 51  
 Cao, W., 70  
 Carlson, V.S., 91  
 $\beta$ -Carotene, 196  
 Carpita, N., 23  
 Carstensen, E.L., 86  
 Castro, A.J., 190  
 Čegovnik, U., 21  
 Cell cytoskeleton, 23  
 Cell membrane, 3  
     electroporation, 2  
     fluidity, 22  
     fusogenic state, 3  
 Cellular tissues, electrically induced damage in  
     damage degree estimation, 44–45  
     transient effects, evolution of, 45–47  
 Cellular tissues, electrothermal treatments  
     of, 83–84  
     food engineering applications of MEF  
         processes  
             drying rate, 88–89  
             extraction, 89–91  
             fermentation, 91–92  
     nonthermal effects of electric fields on cells  
         with intact membranes, 84–88  
 Cell wall in bacteria, yeast, and plants, 23–24  
 Čemažar, M., 17, 21  
 Chalermchatand, Y., 54  
 Chand, P.K., 20  
 Chang, D.C., 2, 52, 88  
 Chao, R.Y., 62  
 Chassy, B.M., 18  
 Chauveteau, G., 164  
 Cheftel, J.C., 39  
 Chemical oxygen demand (COD), 206  
 Chemomechanical system, 101  
 Chen, C., 41  
 Chen, G., 140  
 Chen, H., 149  
 Chen, X.D., 192  
 Chen, Y.-S., 224  
 Chen, Y.H., 97  
 Chernomordik, L., 22  
 Chiarelli, P., 101  
 Chizmadzhev, Y.A., 41, 43

*Chlorella vulgaris*, see Algae

Cho, H.Y., 91

Chou, S.K., 70

Christou, P., 19

Chua, K.J., 70

Clark, P., 186, 189

Cold juice extraction, 196

Colin, F., 109

Collins, D.M., 18, 22

Combined field dewatering, 148

Conductivity disintegration index, 45

Consolidation coefficient, 125

Conte, P., 16

CoolPure<sup>®</sup>, 185

Corrales, M., 62

*Corynebacterium*, 18

Cosgrove, D.J., 116

Coster, H.G.L., 22, 86

Cottrell, I.W., 102

Crank, J., 64, 71

Cserhalmi, Z., 186, 189

CSIRO, Australia, 145

Cui, Z.F., 169

Cui, W., 219

Cukjati, D., 15

## D

Damage degree estimation, 44–45

Damage time, 45–46

Danfelter, M., 3–4, 6, 17

Danielli, J.F., 88

Darcy's law, 158, 176

Daskalov, I., 15

Davalos, R.V., 9

DC electrical field effects on plant tissues and gels, 96–97

advantages and future prospects of, 116–117

electrical apparatus and measurement systems, 97–99

electrification of gels, 99

alginate gels, 103–105

different gel types, 105–106

electrified networks, types of, 102–103

induction of phase transition in gels by electrical fields, 99–102

electrification of plant tissues, 107

electrification of fruit/vegetable pieces, 111–112

expression processes in the food industry and betanin extraction, 108–111

gel-plant "sandwiches," 114

gels and plant tissues, resemblance between, 108

influences of electrification on intact plant tissues, 114–116

inhibition of potato browning by electrical field, 112–113

mechanism involved in electrifying plant tissues, 116

Debye-Hueckel parameter, 169

Degree of electroporation, screening of, 252–255

Dejmek, P., 39, 44, 54, 201

Depolarizing factors, 43

Derjaguin-Landau-Verwey-Overbeek (DLVO) approach, 169

DeRossi, D., 101

Dev, D.K., 232

D'Halluin, K., 11, 20–21, 24

Dimitrov, D.S., 9, 22, 41

Diosady, L.L., 219, 230

Djuzenova, C.S., 10

DNA, 25

adsorption, 10

damage, 4

–membrane interaction, 11

plasmid, 6

topology on transformation efficiency, 18

Doenenburg, H., 202

Doevenspeck, H., 183–184, 193, 255

Doi, M., 101

Donaldson, A.L., 243–244

Dougherty, W., 9

Dower, W.J., 18–19, 24

Drainage surface, 123

Drying

food plants, 70–75

kinetics and moisture diffusion affected by PEF cell disintegration, 70–74

temperature evolution, 74–75

processes, 72

rate, 88–89

Duckworth, M., 105

## E

Edd, J.F., 9

Edebo, L., 183

El-Belghiti, K., 62–63, 65–66, 196, 219, 228–229

Elcrack<sup>®</sup>, 185

Electric field

and electroporation, 4–9

strength and total treatment time, 51–52

Electric pulses, 4

- Electrification  
of fruit/vegetable pieces, 111–112  
of plant tissues  
  gel-plant "sandwiches," 114  
  gels and plant tissues, resemblance  
    between, 108  
  influences of, on intact plant tissues,  
    114–116  
  inhibition of potato browning by  
    electrical field, 112–113  
  mechanism involved in electrifying  
    plant tissues, 116
- Electrochemotherapy, 16–17
- Electrofiltration of biomaterials, 156  
dewatering of, 156  
  filtration, 158–162  
  force balance, 157–158  
  press electrofiltration *versus* cross-flow  
    filtration, 162–167  
  press electrofiltration *versus* thermal  
    evaporation, 162–167
- fractionation, 168–169  
of bacteria and extracellular enzyme  
  product, 169–171  
with electrofiltration, 175–176  
of highly viscous polysaccharide and  
  protein, 171–172  
of proteins, 172–175  
  guidelines, 176–177
- Electrofusion, 8–10
- Electrohydraulic treatment, 183
- Electrokinetic remediation, 151
- Electro-osmotic dewatering (EOD), 121–122,  
145  
  characteristics of materials suitable for,  
    127–128  
  electric field for high-performance,  
    128–131  
  combination of constant current  
    and constant voltage conditions,  
    138–139  
  electrode arrangements and  
    configurations, 139–144  
  with electrode polarity reversals,  
    128–131  
  interrupted or intermittent electric field  
    application, 132–138
- food processing products and wastes,  
  148–151
- principles for high performance, 126–127
- sewage/activated sludge and biomass  
  sludge, 145–148
- theoretical developments, 122–126
- Electroosmotic pressure gradient, 125
- Electropermeabilization, 40–44, 84–85, 87  
  membranes and cells, stability of, 43–44  
  transmembrane potential, 41–43
- Electroporation, 87, 193  
  applications  
    bacteria and yeast, 18–19  
    medicine, use in, 16–17  
    plant protoplast electroporation, 19–20  
    transfection of intact plant tissue, 20–21  
    water sterilization and food  
      preservation, 17–18  
  basics and mechanisms, 2–4  
  on cell cytoskeleton, 23  
  degree of, screening of, 252–255  
  of different cell types, 21–22  
  electrodes/shaping the electric field, 15–16  
  cell cytoskeleton, influence of, 23  
  cell membrane fluidity, influence of, 22  
  cell wall in bacteria, yeast, and plants,  
    influence of, 23–24  
  influential parameters, 4  
    electric field, 4–9  
    medium composition, 9–10  
    osmotic pressure, 10–12  
  single-cell to tissue, 12–15
- Electropure process, 183, 190
- Electrothermal treatments of cellular tissues,  
83–84  
  food engineering applications of MEF  
    processes  
    drying rate, 88–89  
    extraction, 89–91  
    fermentation, 91–92  
  nonthermal effects of electric fields on cells  
    with intact membranes, 84–88
- Elsteril<sup>®</sup> process, 184
- El Zakhem, H., 45
- Enzymatic browning, 112
- Enzyme inactivation, 187
- EOD, *see* Electro-osmotic dewatering (EOD)
- Escande-Geraud, M.L., 12
- Escherichia coli*, 18
- Eshtiaghi, M.N., 54, 111, 196, 198, 255, 261
- Eskin, N.A.M., 112
- Evans, G.A., 6
- Evrendilek, G.A., 52, 186, 189–190
- Exerova, D., 49
- Extraction, 89–91
- Eynard, N., 11, 19–20, 24
- F**
- Faurie, C., 4, 7
- Fear, E.C., 15

- Fedorenchenko, L.A., 89  
 Fellows, P.J., 109  
 Feng, T.Y., 11, 20, 22–24  
 Fensom, D.S., 86  
 Ferber, D., 2  
 Fermentation, 91–92  
 FET, *see* Field effect transistor (FET)  
 Fetterman, J.C., 183  
 Fiedler, S., 18  
 Field effect transistor (FET), 140  
 Filev, P.D., 40  
 Filtration acceleration, 170  
 Fincan, M., 39, 44, 62, 193, 198–199, 201  
 Flaumenbaum, B.L., 40, 193–194, 255  
 Food engineering applications of MEF processes  
   drying rate, 88–89  
   extraction, 89–91  
   fermentation, 91–92  
 Food industry and betanin extraction, 108–111  
 Food industry applications for pulsed electric fields, 181–182  
   energy requirements and cost-effectiveness, 207–209  
   future aspects, 209–210  
   historical approach, 183–186  
   mass transfer process in plant material  
     drying enhancement, 199–200  
     PEF-assisted cell expression and extraction, 193–199  
   meat treatment, 203–205  
   preservation of foods, 186–189  
     juice, 189–190  
     milk, 190–192  
   softening of plant tissue, 200–201  
   stress, 201–203  
   wastewater treatment, 206  
 Food plants  
   drying of, 70–75  
   solid-liquid expression from, 54–61  
 Food preservation, water sterilization and, 17–18  
 Frenzel, S., 259  
 Fricke, H., 43  
 Fromm, M.E., 2, 19  
 Fryer, P.J., 85  
 Fusogenic state, cell membrane, 3
- G**  
 Gabriel, B., 3–5, 13, 20  
 Galatas, F., 105  
 Gallo, S.A., 22  
 Galvani's observation, 96  
 Ganeva, V., 11, 19–20, 24  
 “Gate” electrode, 140  
 Gates, J.C., 107  
 Gehl, J., 17  
 Gel-plant “sandwiches,” 114  
 Gels and plant tissues, resemblance between, 108  
 Gene electrotransfer, 11, 19–20  
 Generator configurations, 238–242  
 Getchell, B.E., 183  
 Ghosh, R., 156, 169  
*Giardia muris*, 18  
 Gilliland, S.E., 183  
 Gimsa, J., 43  
 Glicksman, M., 103  
 Golzio, M., 4, 7–8, 11  
 Gong, J.P., 101  
 Gopalakrishnan, S., 133–134  
 Gorbatov, A.V., 40, 45  
 Gould, S.W., 18  
 Gozukirmizi, N., 21  
 Gradzinsky, A.J., 101  
 Graham, L.L., 23  
 Graškova, D., 13, 17  
 Gray, D.H., 131  
 Green chemistry, 62  
 Greenham, C.G., 252  
 Grimi, N., 59–60  
 Grinding energy, 201  
 Grobner, U., 10, 22  
 Gros, C., 218, 222–223, 225–228, 230–233  
 Gross, D., 13  
 Grosse, C., 13  
 Guderjan, M., 197–198, 202, 208  
 Gudmundsson, M., 203  
 Gulyi, I.S., 40  
 Gupte, A.R., 157  
 Gurel, F., 21
- H**  
 Haas, C.N., 18  
 Hafsteinsson, H., 203, 205  
 Halden, K., 90  
 Hamilton, W., 3–4, 6, 13, 51, 184  
 Hamlen, R.R., 100, 102  
 Hansen, H.K., 148  
 Harkin, D.G., 23  
 Harris, R.V., 220  
 Hart, G.H., 132  
 Hashinaga, F., 70  
 Haufe, W., 244  
 Hay, E.D., 23  
 He, G.Y., 21



- Heinz, V., 183, 186, 190, 203, 209  
Heller, R., 6, 17  
Henry, B.S., 109  
Hibino, M., 3, 13  
High-voltage electrical discharges (HVED),  
217–221  
    condition of apparition, 221–222  
    material and energy, 222–224  
    steps of creation, 221  
    for various applications, 224–225  
Hiraoka, M., 145  
Hirose, Y., 101, 104, 107  
Hirotzu, S., 101  
Hnatiuc, E., 218  
Ho, M.Y., 140  
Ho, J.S., 41  
Hodgins, A.M., 186  
Hofmann, R., 155, 159–160, 164, 174  
Hui, S.W., 2, 12  
Hybrid processes, 168  
Hydrocolloid gels, 100
- I**  
Imai, T., 85  
Iritani, E., 156  
Irreversible electroporation, 9, 17–18  
    *See also* Electroporation; Reversible  
    electroporation  
Isobe, S., 18, 150  
Iwata, M., 122–123, 125, 129
- J**  
Jaeger, H., 181, 191–192  
Janáček, K., 85, 88  
Janmey, P., 23  
Janositz, A., 201  
Jaroszeski, M.J., 9  
Jayaram, S., 189  
Jemai, A., 44, 54, 57, 62, 89–90, 196, 207, 255  
Jeyamkondan, S., 183  
Joersbo, M., 19–20, 86, 88  
Jones, M.G.K., 88  
Jørgensen, K., 49  
Joshi, A.A., 221  
Juice, 189–190  
Juice decontamination, 190  
Jumah, R., 150
- K**  
Kafaar, A., 148  
Kandušer, M., 1, 21–22  
Kanthou, C., 17, 23  
Käppler, T., 155, 159, 170, 173–174  
Karlsruher elektroporations anlage (KEA), 256  
Katrokha, I.M., 40  
Katsuki, S., 219  
Kaufmann, M., 156  
KEA, *see* Karlsruher elektroporations anlage  
    (KEA)  
KEA-ZAR, 259  
Kemp, M.R., 85  
Kim, J., 89  
Kim, S.H., 220  
Kim, Y.H., 19, 24  
Kind, D., 250  
Kinosita, K., 3, 13, 22, 88  
Kiselev, V.Ya., 243  
Kishi, R., 101, 103, 107  
Klenchin, V.A., 4, 6  
Kliewe, V.H., 91  
Knorr, D., 47, 54, 73, 97, 111, 181, 193, 196,  
198, 200, 202, 255, 261  
Koehler, E., 199  
Kogan, F.I., 40  
Kohlrabi (*Brassica oleracea*), 112  
Kondoh, S., 145  
Koners, U., 206  
Kopplow, O., 206  
Kotnik, T., 2, 4, 13, 41, 43, 53  
Kotyk, A., 85, 88  
Krassowska, W., 40  
Kraus, W., 186, 201  
Krupp Maschinentechnik, 184–185  
Kulshrestha, S., 83, 85, 90  
Kupchik, M.P., 40  
Kurauchi, T., 101  
Kutney, J.P., 20
- L**  
*Lactobacillus acidophilus*, 91–92  
*Lactococcus lactis*, 92  
 $\beta$ -Lactoglobulin, 191  
Ladygin, V.G., 20  
Lakkakula, N.R., 90  
Landau, L.D., 43  
Lazzeri, P.A., 21  
LBG, *see* Locust bean gum (LBG)  
Leader, 221  
Lebedeva, N.E., 43–44  
Lebovka, N.I., 9, 17–18, 39–41, 43–49, 51–52,  
54, 56, 63–65, 70–74, 83, 89, 194,  
201, 253  
Lechner, N., 186, 189  
Lecourtier, J., 164  
Lee, C.Y., 112  
Lee, R.C., 9  
Lee, T.M.O., 19

- Leontiadou, H., 3  
 Lewis, F.C., 183  
 Li, F.-D., 70  
 Li, L.H., 9, 16, 150  
 Li, S.-Q., 189, 191  
 Li, X., 150  
 Lightfoot, D.G., 148–149  
 Lima, M., 40, 70, 85, 89–90  
 Lindsey, K., 88  
 Liu, F., 10  
 Liu, M., 7  
 Lockhart, N.C., 128, 132, 139  
 Locust bean gum (LBG), 100  
 Loeffler, M., 206  
 Loew, L.M., 13  
 Loghavi, L., 83, 91–92  
 Lopes Barbosa, A.C., 219  
 Lorz, H., 20  
 Lu, X.-P., 218  
 Lucas, M.L., 6  
 Lund, E.J., 97  
 Lundqvist, J.A., 15  
 Lysjanskii, 64  
 Lysozyme, 174
- M**
- Macromolecules, 6–8, 19  
 Mašek-Lebar, A., 4–5  
 Maize germ oil, 197  
 Malik, M.A., 224  
 Mañas, P., 52  
 Marchal, L., 56  
 Marszalek, P., 2, 13  
 Martin, J.C., 222  
 Martín-Belloso, O., 52  
 Marx, E., 239–240  
 Marx capacitors, 246  
 Marx generators, 241, 246–250, 259  
 Mason, C.K., 19  
 Mastwijk, H., 187  
 Matov, B.I., 40  
 May, B.K., 71–72  
 Mazan, M., 23  
 Mazza, G., 219  
 McDonald, C.J., 186  
 McLellan, M.R., 194  
 Meaking, W.S., 3–4, 6  
 Meat treatment  
   food industry applications for pulsed  
   electric fields, 203–205  
 Medicine and electroporation, 16–17  
 Meer, W., 105  
 Mehta, A., 169
- Meilhoc, E., 19  
 Membrane fluidity, 22  
 Membranes and cells, stability of, 43–44  
 Messner, P., 23  
 Microfiltration membranes, 176  
 Miklavcic, D., 1, 4–5, 13, 15–17,  
   22, 43  
 Mikula, M., 224–225  
 Mild electric field (MEF) application, 207  
 Milk, 190–192  
 Miller, L., 9  
 Min, S., 186, 189  
 Mir, L.M., 7, 17  
 Mitchell, C.A., 201  
 Mittal, G.S., 41  
 Moderate electric field (MEF)-treatment, 40  
 Molinari, P., 186  
 Mordhorst, A.P., 20  
 Morren, J., 187  
 Moses, B.D., 183  
 Mouritsen, O.G., 49  
 Münch, E.W., 203
- N**
- Naugol'nykh, K.A., 218–219  
 Neidhardt, F.C., 85–86  
 Neidl, G., 91  
 Neumann, E., 2–4, 6, 10, 19  
 Nicotinamide adenine dinucleotide  
   (NAD), 86  
 Nikolova, A., 49  
 Nobel, P.S., 110  
 Nonthermal food preservation  
   benefit of, 18  
 Novaković, S., 21  
 Nussinovitch, A., 95, 97, 100–102, 104–109,  
   111–114
- O**
- Oblak, J., 18  
 Ochatt, S.J., 20  
 O'Hare, M.J., 21  
 Ohno-Shosaku, T., 10  
 Ohta, Y., 220  
 Oilseeds, aqueous extraction from, 217–220  
   extraction enhanced by HVED, 225–226  
   extraction of soluble molecules,  
   226–230  
   oil extraction, 230–233  
   quality of extracted products, 226  
   high-voltage electrical discharges, 220–221  
   condition of apparition, 221–222  
   material and energy, 222–224

- Oilseeds, aqueous extraction from (*cont.*)  
 steps of creation, 221  
 for various applications, 224–225  
 stages, 220
- Okada, M., 142
- Okada, Y., J., 10
- Okara, 150
- Olofsson, J., 15
- Optimal energy consumption, 47–48
- Orrenius, S., 10
- Orsat, V., 148–149
- Ortega-Rivas, E., 189
- Osada, Y., 101, 107
- Osmotic dehydration (OD), 68–70
- Osmotic pressure, 10–12
- Osterhout, W.J.V., 86
- P**
- Paradossi, G., 164
- Pauly, H., 41, 43
- Pavlin, M., 3, 5, 10, 14, 44
- Pavšelj, N., 7, 15–16
- Peleg, M., 104, 108
- Perez, O., 191
- Perré, P., 71–72
- Phytochemical defense, 201
- Phytosterol, 202
- Picart, L., 190
- Pilosof, A.M.R., 191
- Pitt, R.E., 19, 22
- Plant oils, 197
- Plant protoplast electroporation, 19–20
- Plant tissues, pulsed-electric-fields-induced  
 effects, 39–40  
 diffusion, and drying  
 aqueous extraction of solutes from food  
 plants, 62–68  
 drying of food plants, 70–75  
 osmotic dehydration, 68–70  
 solid–liquid expression from food  
 plants, 54–61  
 electric field effects in, 40  
 damage as function of pulse protocol,  
 51–53  
 electrically induced damage, 44–47  
 electropermeabilization, 40–44  
 electroporation during ohmic heating,  
 50–51  
 optimal energy consumption, 47–48  
 synergetics of, and thermal treatments,  
 48–49
- Plant tissues and gels, DC electrical field  
 effects on, 96–97
- advantages and future prospects of,  
 116–117
- electrical apparatus and measurement  
 systems, 97–99
- electrification of gels, 99  
 alginate gels, 103–105  
 different gel types, 105–106  
 electrified networks, types of, 102–103  
 induction of phase transition in gels by  
 electrical fields, 99–102
- electrification of plant tissues, 107  
 electrification of fruit/vegetable pieces,  
 111–112  
 expression processes in the food  
 industry and betanin extraction,  
 108–111  
 gel-plant "sandwiches," 114  
 gels and plant tissues, resemblance  
 between, 108  
 influences of electrification on intact  
 plant tissues, 114–116  
 inhibition of potato browning by  
 electrical field, 112–113  
 mechanism involved in electrifying  
 plant tissues, 116
- Plasmolysis, *see* Electropermeabilization
- Pliquett, U., 5, 10, 41
- PMF, *see* Proton motive force (PMF)
- Pollack, G.H., 99
- Polyelectrolyte gels, 102
- Polymer filter cakes, 159
- Polyphenol oxidase, 113
- Polysaccharides, 102, 108
- Polyvinyl alcohol (PVA) gel fiber, 100
- Posten, C., 155, 159–160, 173–174
- Praporscic, I., 40, 54–58, 89, 196
- Prausnitz, M.R., 3
- Preat, V., 7
- Press electrofiltration, 155, 157, 159, 176  
*versus* cross-flow filtration, 162–167
- Pressing–washing–pressing (PEF– P–W–P),  
 59–60
- Probstein, R.F., 151
- Prochownick, L., 183
- Proton motive force (PMF), 85–86
- Pseudomonas fluorescens*, 191
- Puc, M., 3, 16
- Pucihar, G., 5, 10, 13–15, 44
- Pulsed-electric-fields-induced effects in plant  
 tissues, 39–40  
 diffusion, and drying  
 aqueous extraction of solutes from food  
 plants, 62–68

- drying of food plants, 70–75
  - osmotic dehydration, 68–70
  - solid–liquid expression from food plants, 54–61
  - electric field effects in, 40
    - damage as function of pulse protocol, 51–53
    - electrically induced damage, 44–47
    - electropermeabilization, 40–44
    - electroporation during ohmic heating, 50–51
    - optimal energy consumption, 47–48
    - synergetics of, and thermal treatments, 48–49
  - Pulsed electric fields (PEF), biological tissues, 237–238
    - emerging industrial applications
      - green biomass by electroporation assisted dewatering, 264–268
      - treatment of grapes, 260–264
      - treatment of sugar beets, 255–260
    - pulse generators for industrial applications
      - burn-up control scheme, 249–252
      - generator configurations, 238–242
      - screening of the degree of electroporation, 252–255
      - synchronization, 246–249
    - with pulse generators for industrial applications
      - spark gap switches, 242–246
  - Pulsed electric fields (PEF), food industry
    - applications for, 181–182
    - energy requirements and cost-effectiveness, 207–209
    - future aspects, 209–210
    - historical approach, 183–186
    - improvement of mass transfer process in plant material
      - drying enhancement, 199–200
      - PEF-assisted cell expression and extraction, 193–199
    - meat treatment, 203–205
    - preservation of foods, 186–189
      - juice, 189–190
      - milk, 190–192
    - softening of plant tissue, 200–201
    - stress, 201–203
    - wastewater treatment, 206
  - Pulse generators for industrial applications
    - burn-up control scheme, 249–252
    - generator configurations, 238–242
    - screening of the degree of electroporation, 252–255
    - spark gap switches, 242–246
    - synchronization, 246–249
  - Pulse modulator typology, 208
  - Pulse protocol, damage as function of, 51–53
    - electric field strength and total treatment time, 51–52
    - intervals between pulses, 52
    - pulse duration, 52–53
    - waveforms, 52
  - Punch-through, 87
  - Pyun, Y., 89
- Q**
- Qin, B.L., 52
  - Quecini, Y.M., 20
  - Quensel, E., 232
- R**
- Rabie, H.R., 133
  - Radish (*Raphanus sativus*), 112
  - Raghavan, G.S.V., 148–149
  - Rakoczy-Trojanowska, M., 21
  - Ramanathan, S., 107
  - Ramos, C., 2, 8–9
  - Rampacek, C., 122
  - Raouzeos, G.S., 71
  - Raphanus sativus*, see Radish
  - Raso, J., 52–53
  - Rassis, D., 104
  - Rastogi, N.K., 97, 200
  - Raw juice purity, 258
  - Reactive oxidative species, 20–21
  - Reberšek, M., 4, 7
  - Rech, E.L., 20
  - Reddy, K.R., 151
  - Reina, L.D., 190
  - Relative moisture content, 200
  - Reshetko, E.V., 40
  - Reversible electroporation, 16
  - Rogov, I.A., 40, 45
  - Roi, N.A., 218–219
  - Rols, M.P., 2–5, 8, 10–11, 13, 16, 21–23
  - Roodenburg, B., 187
  - Rosenheck, K., 3
  - Rosenthal, A., 219
  - Rouan, D., 21
  - Rowley, B.A., 91
  - Rubinsky, B., 9
  - Rumpf, H., 157
  - Ryttzen, F., 13, 15
- S**
- Sabri, N., 11, 20, 24
  - Saccharomyces cerevisiae*, 23

- Sack, M., 237, 245–246, 254, 266  
 Saguy, I., 75  
 Sale, A.J.H., 3–4, 6, 13, 51, 184  
 Salengke, S., 70, 89  
 Sampedro, F., 52–53, 190  
 Saponification values, 198  
 Saravacos, G.D., 71  
 Sastry, S.K., 40, 51, 56, 70, 83, 85, 88–90, 97,  
 110–111, 207  
 Šatkauskas, S., 4, 7–8  
 Saunders, J.A., 8, 10, 19–20, 24  
 Saveyn, H., 148  
 Scanning electron microscopy (SEM)  
 microscopy, 205  
 Schaffer, C., 23  
 Scheffer, K., 264  
 Schilling, S., 194–195  
 Schreier, P.J.R., 85, 90  
 Schultheiss, C., 186, 255  
 Schuten, H., 187  
 Schwan, H.P., 2, 13, 41, 43  
 Schwan's equation, 2  
 Schwartzberg, H.G., 54, 62  
 Schwuger, M.J., 157  
 Screening of the degree of electroporation,  
 252–255  
 Seifriz, W., 96–97  
 Šel, D., 15–16  
 Selectrochemotherapy, 16–17  
 Selin, I., 183  
 Semisolid, 99  
 Šemrov, D., 15  
 Sensoy, I., 90, 110, 207  
 Sepulveda, D.D., 186, 190  
 Serša, G., 4, 17  
 Shahidi, F., 219  
 Shaplo, A.P., 151  
 Sharma, A., 220  
 Shiga, T., 101  
 Shimada, K., 91  
 Shimahara, K., 91  
 Shinohara, H., 104  
 Shirato, M., 125  
 Shoenfeld, N.A., 101  
 Shynkaryk, M.V., 40, 47, 70, 73–75  
 Sigler, J., 261–263  
 Silberberg, A., 108  
 Single-cell electroporation, 12  
 See also Electroporation  
 Single-cell to tissue, 12–15  
 Sitzmann, W., 203  
 Sludge, 206  
 Small molecules, 5–6  
 Smelt, J.P.P.M., 52  
 Smith, K., 190  
 Smollen, M., 148  
 Soike, K., 183  
 Solid–liquid expression from food plants,  
 54–61  
 combined pressing and PEF-treatment, 54  
 kinetics of solid–liquid expression and  
 quality of juices, 54–61  
 Solid–liquid separation of biomaterials, 156  
 Somiari, S., 7  
 Somogyi, F., 131  
 Sorokin, A.P., 21  
 Southwell, K.H., 220  
 Sowers, A.E., 8–9, 22, 41  
 Spaeth, F., 183  
 Spark gap switches, 242–246  
 Speck, M.L., 183  
*Spirulina platensis*, 199  
 Stanley, D.W., 110, 189  
*Staphylococcus aureus*, 183  
 Stein, W.D., 88  
 Stenger, D.A., 2, 12  
 Stopper, H., 16  
 Stuchly, M.A., 15  
 Suga, M., 19  
 Sugar production, 196  
 Sugiarto, A.T., 220–221, 224  
 Sukharev, S.I., 4, 6  
 Sun, B., 217–218, 221, 224  
 Susil, R., 14  
 Suzuki, Y., 148  
 SYMBIOSE 164, 166  
 Synchronization, 246–249  
 Szczesniak, A., 108
- T**  
 Taiwo, K.A., 111  
 Takac, S., 170  
 Tal, Y., 104  
 Tanaka, T., 100–101, 116  
 Tanaka's explanation, 101  
 Tano-Debrah, K., 220  
 Tarek, M., 40  
 Tedjo, W., 196, 198–199, 261  
 Teijo, W., 69  
 Teissié, J., 2–5, 8–11, 13, 16, 18, 20–21, 23, 40  
 Tekle, 4, 7, 13  
 Temelli, F., 219  
 Tetramethylethylenediamine (TEMED), 100  
 Thiele, H., 183  
 Three-dimensional polymeric network, 108  
 Timberlake, C.F., 109

- Tissue shrinkage, 113  
 Tissue softening, 201  
 Toepfl, S., 39, 43–44, 51, 54, 57, 70, 73,  
 183–184, 186, 189–190, 194–195,  
 200, 203, 205–207, 209  
 Tofu, 150  
 Tolstoguzov, V.B., 108  
 Total soluble solids (TSS), 206  
 Tracy, R.L., 183  
 Transfection of intact plant tissue, 20–21  
 Transmembrane potential, 41–43  
 Trevors, J.T., 24, 99  
 Tryfona, T., 18  
 Tsong, T.Y., 2–3, 13, 18, 22, 86, 88  
 Tsukamoto, S., 237  
 Tubulin, 23
- U**  
 Uemura, K., 18  
 Ueoka, Y., 101  
 Ulmer, H.M., 186  
 Unal, R., 92  
 Županič, A., 17
- V**  
 Valič, B., 8, 13, 43  
 Vamos-Vigyazo, L., 113  
 Van der Poel, P.W., 54, 62–63  
 Van der Rest, M.E., 19, 22  
 Vaneijndhoven, R.H.C.M., 169  
 Vanisree, M., 20  
 Van Loey, A., 187  
 Vega-Mercado, H., 39, 70  
 Velizarov, S., 10, 22  
 Vernhes, M.C., 4–5  
 Vienken, J., 8, 10  
 Vijh, A.K., 130, 140, 151  
 Vishkvatzev, L.I., 220, 226  
*Vitis vinifera*, see Wine grapes  
 Vitkovitsky, I., 221, 224  
 Vorobiev, E., 17–18, 39, 43–45, 54–58, 62–63,  
 83, 89–90, 193–194, 196, 207, 255
- W**  
 Wachner, D., 43  
 Wahab, S.M.A., 101  
 Wakeman, R.J., 128, 156  
 Walden, R., 21  
 Walker, J.R.L., 113  
 Wanasundara, P.K.J.P.D., 219  
 Wang, W.C., 40, 51, 56, 88, 97, 111  
 Wang, X., 18  
 Wards, B.J., 18, 22  
 Washing–pressing (PEF–W–P), 59–60  
 Water/press-cake ratio, 232
- Water sterilization and food preservation,  
 17–18  
 Weaver, J.C., 2, 9, 13, 41, 43, 88  
 Wesley, R.H., 225  
 Whitaker, J.R., 112  
 Whiting, C.J., 102  
 Williams, E.J., 85  
 Willis, R.H., 107  
 Wine grapes, 203  
 Wingender, R., 21  
 Wirth, R., 18  
 Wolf, H., 4, 6–7, 11  
 Wolf, K., 183  
 Wouters, P.C., 52–53  
 Wu, F.S., 11, 20, 22–24  
 Wu, Y., 8
- X**  
 Xanthan, 100, 164, 171  
 Xia, B., 150  
 Xie, T.D., 10, 18, 37  
 Xue, G.P., 11
- Y**  
 Yamada, K., 140  
 Yamaguchi, M., 145  
 Yang, R.J., 113, 187  
 Yang, R.Y.K., 20  
 Yaphe, W., 105  
 Ye, H., 111  
 Yeom, H.W., 189  
 Yin, Y.G., 111  
 Yoon, S.W., 90  
 Yoshida, H., 121, 128–132, 135, 138–140, 142  
 Yoshioka, Y., 107  
 Yukawa, H., 121, 145, 159, 161  
 Yukawa's enhancement of Darcy's law, 159  
 Yushkov, A., 222–223
- Z**  
 Zagorulko, A.Ja., 40  
 Zaharoff, D.A., 6–7  
 Zampaglione, I, 7  
 Zárate-Rodríguez, E., 189  
 Zhang, Q., 9, 18  
 Zhang, Q.H., 52, 86, 186, 189, 191, 997  
 Zhang, Z., 71  
 Zhong, T., 40, 70, 89  
 Zhou, A., 18  
 Zhou, J., 143  
 Zimmermann, U., 2–3, 8, 10, 13, 22, 43,  
 49, 88  
 Zuckerman, H., 218, 220–221, 224  
 Zvitov, R., 96–97, 100–102, 104–115  
 Zwieniecki, M., 114, 116  
 Zydney, A.L., 169