

# 2

## Old Babylonian Arithmetical Table Texts

Old Babylonian clay tablets inscribed with arithmetical or metrological table texts are typically much taller than wide, often rectangular with the sides more or less in the ratio 3 : 2.

### 2.1. Old Babylonian Tables of Squares

#### 2.1 a. Standard Tables of Squares

(Cf. Neugebauer, *MKT I* (1935), 69-70, 74, 85; Neugebauer and Sachs *MCT* (1945), 33.)

A complete “unabridged” Old Babylonian table of squares contains entries for *the squares of all integers from 1 to 59 and 1 (00)*. For examples, see *MKT I* § 4b: 5-13. The entries in all lines (except possibly the first line of the table) are normally of one of the following two types,

type a:  $n$     a.rá  $n$     sq.  $n$   
 type b:  $n$      $n$             sq.  $n$

(This is a simplification of the set of types of Old Babylonian tables of squares that was proposed by Neugebauer in *MKT I*, 74.)

*A complete unabridged table of squares with entries of type a looks like this:*

|    |      |    |       |
|----|------|----|-------|
| 1  | a.rá | 1  | 1     |
| 2  | a.rá | 2  | 4     |
| 3  | a.rá | 3  | 9     |
| 4  | a.rá | 4  | 16    |
| 5  | a.rá | 5  | 25    |
| 6  | a.rá | 6  | 36    |
| 7  | a.rá | 7  | 49    |
| 8  | a.rá | 8  | 1 04  |
| 9  | a.rá | 9  | 1 21  |
| 10 | a.rá | 10 | 1 40  |
| 11 | a.rá | 11 | 2 01  |
| 12 | a.rá | 12 | 2 24  |
| 13 | a.rá | 13 | 2 49  |
| 14 | a.rá | 14 | 3 16  |
| 15 | a.rá | 15 | 3 45  |
| 16 | a.rá | 16 | 4 16  |
| 17 | a.rá | 17 | 4 49  |
| 18 | a.rá | 18 | 5 24  |
| 19 | a.rá | 19 | 6 01  |
| 20 | a.rá | 20 | 6 40  |
| 21 | a.rá | 21 | 7 21  |
| 22 | a.rá | 22 | 8 04  |
| 23 | a.rá | 23 | 8 49  |
| 31 | a.rá | 31 | 16 01 |
| 32 | a.rá | 32 | 17 04 |
| 33 | a.rá | 33 | 18 09 |
| 34 | a.rá | 34 | 19 16 |
| 35 | a.rá | 35 | 20 25 |
| 36 | a.rá | 36 | 21 36 |
| 37 | a.rá | 37 | 22 49 |
| 38 | a.rá | 38 | 24 04 |
| 39 | a.rá | 39 | 25 21 |
| 40 | a.rá | 40 | 26 40 |
| 41 | a.rá | 41 | 28 01 |
| 42 | a.rá | 42 | 29 24 |
| 43 | a.rá | 43 | 30 49 |
| 44 | a.rá | 44 | 32 16 |
| 45 | a.rá | 45 | 33 45 |
| 46 | a.rá | 46 | 35 16 |
| 47 | a.rá | 47 | 36 49 |
| 48 | a.rá | 48 | 38 24 |
| 49 | a.rá | 49 | 40 01 |
| 50 | a.rá | 50 | 41 40 |
| 51 | a.rá | 51 | 43 21 |
| 52 | a.rá | 52 | 45 04 |
| 53 | a.rá | 53 | 46 49 |

*Continued*

|           |             |           |           |
|-----------|-------------|-----------|-----------|
| 24        | a.rá        | 24        | 9 36      |
| 25        | a.rá        | 25        | 10 25     |
| 26        | a.rá        | 26        | 11 16     |
| 27        | a.rá        | 27        | 12 09     |
| 28        | a.rá        | 28        | 13 04     |
| 29        | a.rá        | 29        | 14 01     |
| <b>30</b> | <b>a.rá</b> | <b>30</b> | <b>15</b> |

|    |      |    |       |
|----|------|----|-------|
| 54 | a.rá | 54 | 48 36 |
| 55 | a.rá | 55 | 50 25 |
| 56 | a.rá | 56 | 52 16 |
| 57 | a.rá | 57 | 54 09 |
| 58 | a.rá | 58 | 56 04 |
| 59 | a.rá | 59 | 58 01 |
| 1  | a.rá | 1  | 1     |

Two Old Babylonian tables of squares of standard type are present in the Schøyen Collection. One of them, **MS 2794** (Fig. 2.1.1, top), is a complete “abridged” table of squares of *type a*. A complete “abridged” Old Babylonian table of squares contains entries only for *the squares of the 23 integers 1, 2, ..., 19, 20, 30, 40, 50*, in the same way as Old Babylonian single multiplication tables contain entries for the head number multiplied by these integers. For examples, see *MKT 1* § 4b: 1-4. In the unabridged table above, bold style indicates the entries in an abridged table of squares.

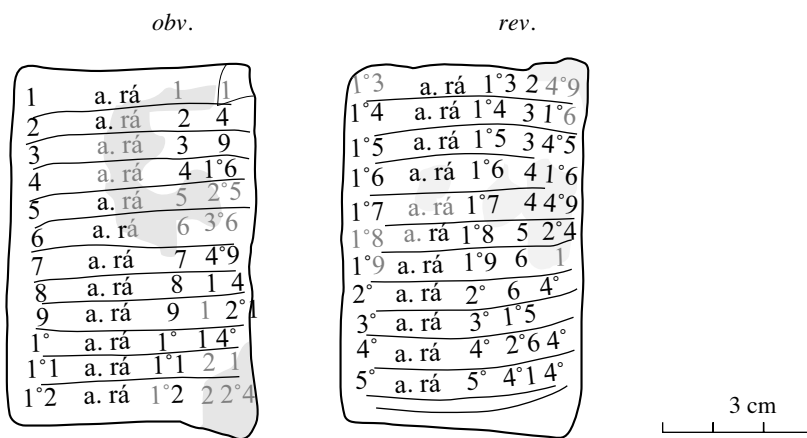

MS 2794. An OB abridged table of squares, for integers from 1 to 20, and 30, 40, 50 (23 lines). Type a.

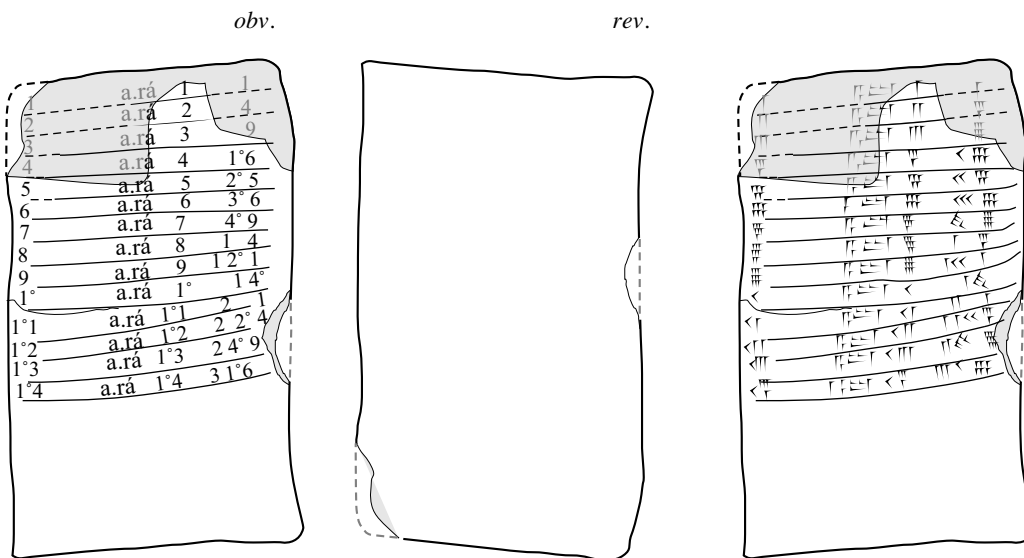

MS 2706. An excerpt from an OB table of squares, for integers from 1 to 14 (14 lines). Type a.

Fig. 2.1.1. Two Old Babylonian tables of squares, one complete but abridged, the other incomplete.

**MS 2706** (Fig. 2.1.1, bottom) is an *excerpt* (a partial copy of the text) from a table of squares with entries of *type a*. For some reason, its 14 lines do not even cover the whole obverse of the clay tablet. The work with the tablet seems to have been interrupted before it was finished.

### 2.1 b. Special Tables of Squares

Note. There is no big difference between “clay tablets with squaring exercises” (Sec. 1.2 above) and “special tables of squares” (the present paragraph). Loosely speaking, the only difference is that a clay tablet with squaring exercises looks very much like a clay tablet with multiplication exercises (Sec. 1.1 above), while a special table of squares looks like a standard table of squares (Sec. 2.1 a above).

**MS 3937** (Fig. 2.1.2, top) is a special table of squares. More precisely, it is a table of *squares of multiples of 5*, from  $10 = 5 \cdot 2$  to  $205 = 5 \cdot 25$ . The entries are all of *type b*.

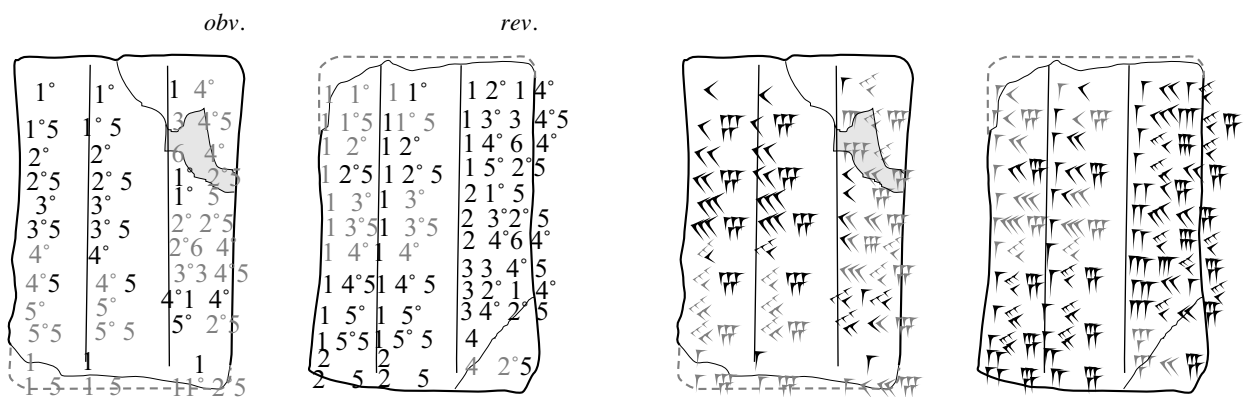

MS 3937. A table of 24 squares of successive multiples of 5. Type b.  
Two errors in the text are easy to explain.

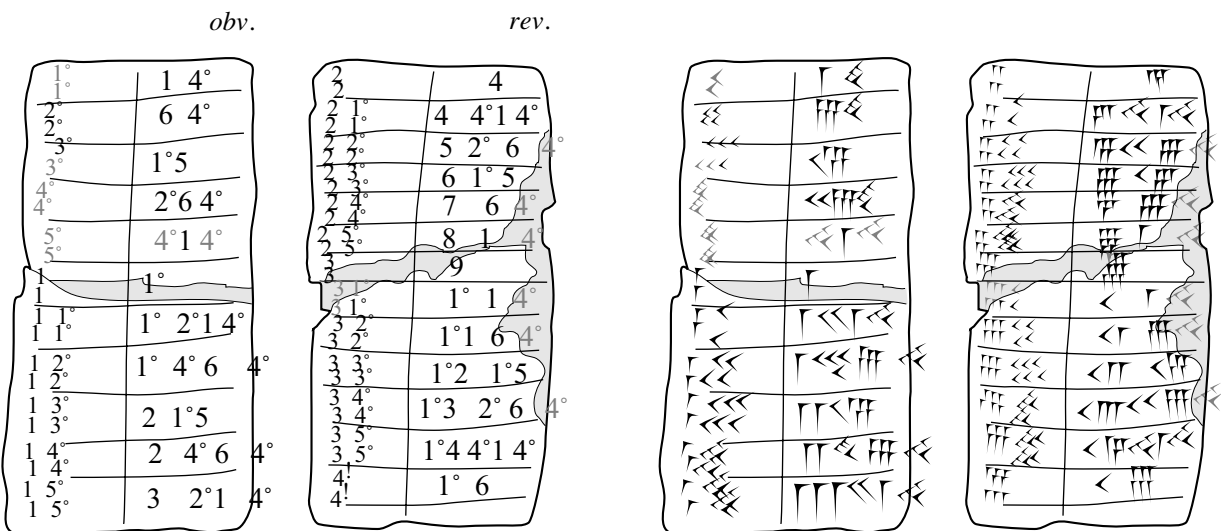

MS 3906. A table of 24 squares of successive multiples of 10. Type b<sub>v</sub>.

Fig. 2.1.2. Two examples of Old Babylonian special tables of squares.



## MS 3906

|      |   |      |   |           |                  |              |
|------|---|------|---|-----------|------------------|--------------|
| 10   | · | 10   | = | 1 40      |                  |              |
| 20   | · | 20   | = | 6 40      |                  |              |
| 30   | · | 30   | = | 15        |                  |              |
| 40   | · | 40   | = | 26 40     |                  |              |
| 50   | · | 50   | = | 41 40     |                  |              |
| 1    | · | 1    | = | 1         |                  |              |
| 1 10 | · | 1 10 | = | 1 21 40   | 1 + 20 + 1 40    | or 1 40 · 49 |
| 1 20 | · | 1 20 | = | 1 46 40   | 1 + 40 + 6 40    | 1 40 · 1 04  |
| 1 30 | · | 1 30 | = | 2 15      | 1 + 1 + 15       | 1 40 · 1 21  |
| 1 40 | · | 1 40 | = | 2 46 40   | 1 + 1 20 + 26 40 | 1 40 · 1 40  |
| 1 50 | · | 1 50 | = | 3 21 40   | 1 + 1 40 + 41 40 | 1 40 · 2 01  |
| 2    | · | 2    | = | 4         |                  |              |
| 2 10 | · | 2 10 | = | 4 41 40   | 4 + 40 + 1 40    | 1 40 · 2 49  |
| 2 20 | · | 2 20 | = | 5 26 40   | 4 + 1 20 + 6 40  | 1 40 · 3 16  |
| 2 30 | · | 2 30 | = | 6 15      | 4 + 2 + 15       | 1 40 · 3 45  |
| 2 40 | · | 2 40 | = | 7 06 [40] | 4 + 2 40 + 26 40 | 1 40 · 4 16  |
| 2 50 | · | 2 50 | = | 8 [01 40] | 4 + 3 20 + 41 40 | 1 40 · 4 49  |
| 3    | · | 3    | = | 9         |                  |              |
| 3 10 | · | 3 10 | = | 10 01 40  | 9 + 1 + 1 40     | 1 40 · 6 01  |
| 3 20 | · | 3 20 | = | 11 06 40  | 9 + 2 + 6 40     | 1 40 · 6 40  |
| 3 30 | · | 3 30 | = | 12 15     | 9 + 3 + 15       | 1 40 · 7 21  |
| 3 40 | · | 3 40 | = | 13 26 40  | 9 + 4 + 26 40    | 1 40 · 8 04  |
| 3 50 | · | 3 50 | = | 14 41 40  | 9 + 5 + 41 40    | 1 40 · 8 49  |
| 4    | · | 4    | = | 15        |                  |              |

Strictly speaking, the entries in MS 3906 are not of type b, that is arranged like this:

$$\text{type b: } \quad n \quad n \quad \text{sq. } n$$

Instead, they are arranged in a *variant of type b*, in the following way,

$$\text{type } b_v: \quad \begin{array}{c} n \\ n \end{array} \quad \text{sq. } n$$

just like the entries in the multiplication and squaring exercises discussed in Secs. 1.1-1.2 above.

*A parallel text:* The round hand tablet **Böhl 1328** (Neugebauer, *MKT 3* (1937), 51) is a table of squares of multiples of 5, from 1 (00) = 5 · 12 to 1 15 = 5 · 15. No photo or hand copy of that text is available, but the transcription offered in *MKT 3* shows that the entries are of type  $b_v$ .

## 2.2. Old Babylonian Tables of Square Sides

(Cf. *MKT 1*, 70-71, 75; *MCT*, 33-34.)

**MS 3963, 2185, and 3864** (Fig. 2.2.1 below) are three examples of Old Babylonian tables of square sides. The tables of square sides on the three tablets are not complete, they are only *excerpts* from a complete table of square sides. A *complete* table of square sides lists the square sides of the squares of *all* integers from 1 to 1 (00), while MS 3963 and MS 2185 list only the square sides of squares of integers from 21 to 40, and MS 3864 only those of squares of integers from 40 to 50.

Normally, Old Babylonian tables of square sides are of “type a”, in the sense that each line in such a table is of the form

$$\text{sq. } n \text{ .e } n \quad \text{í b. si}_8 \quad \text{sq. } n \text{ makes } n \text{ equalsided (where } n \text{ is an integer)}$$

Here, the *ad hoc* translation to the right is an attempt to describe what is meant by the Sumerian phrase to the left. The ergative postfix .e means that the square sq.  $n$  makes something to  $n$ . The verb  $\text{si}_8$  has the basic meaning ‘to be equal’. The whole phrase should probably be understood in a *geometric* sense, as saying that

a square field with the area sq.  $n$  has the side  $n$ .

A complete Old Babylonian table of square sides looks like this:

|       |    |    |                    |                          |       |    |    |                    |                          |
|-------|----|----|--------------------|--------------------------|-------|----|----|--------------------|--------------------------|
| 1     | .e | 1  | íb.si <sub>g</sub> | (or ba.si <sub>g</sub> ) | 16 01 | .e | 31 | íb.si <sub>g</sub> | (or ba.si <sub>g</sub> ) |
| 4     | .e | 2  | íb.si <sub>g</sub> |                          | 17 04 | .e | 32 | íb.si <sub>g</sub> |                          |
| 9     | .e | 3  | íb.si <sub>g</sub> |                          | 18 09 | .e | 33 | íb.si <sub>g</sub> |                          |
| 16    | .e | 4  | íb.si <sub>g</sub> |                          | 19 16 | .e | 34 | íb.si <sub>g</sub> |                          |
| 25    | .e | 5  | íb.si <sub>g</sub> |                          | 20 25 | .e | 35 | íb.si <sub>g</sub> |                          |
| 36    | .e | 6  | íb.si <sub>g</sub> |                          | 21 36 | .e | 36 | íb.si <sub>g</sub> |                          |
| 49    | .e | 7  | íb.si <sub>g</sub> |                          | 22 49 | .e | 37 | íb.si <sub>g</sub> |                          |
| 1 04  | .e | 8  | íb.si <sub>g</sub> |                          | 24 04 | .e | 38 | íb.si <sub>g</sub> |                          |
| 1 21  | .e | 9  | íb.si <sub>g</sub> |                          | 25 21 | .e | 39 | íb.si <sub>g</sub> |                          |
| 1 40  | .e | 10 | íb.si <sub>g</sub> |                          | 26 40 | .e | 40 | íb.si <sub>g</sub> |                          |
| 2 01  | .e | 11 | íb.si <sub>g</sub> |                          | 28 01 | .e | 41 | íb.si <sub>g</sub> |                          |
| 2 24  | .e | 12 | íb.si <sub>g</sub> |                          | 29 24 | .e | 42 | íb.si <sub>g</sub> |                          |
| 2 49  | .e | 13 | íb.si <sub>g</sub> |                          | 30 49 | .e | 43 | íb.si <sub>g</sub> |                          |
| 3 16  | .e | 14 | íb.si <sub>g</sub> |                          | 32 16 | .e | 44 | íb.si <sub>g</sub> |                          |
| 3 45  | .e | 15 | íb.si <sub>g</sub> |                          | 33 45 | .e | 45 | íb.si <sub>g</sub> |                          |
| 4 16  | .e | 16 | íb.si <sub>g</sub> |                          | 35 16 | .e | 46 | íb.si <sub>g</sub> |                          |
| 4 49  | .e | 17 | íb.si <sub>g</sub> |                          | 36 49 | .e | 47 | íb.si <sub>g</sub> |                          |
| 5 24  | .e | 18 | íb.si <sub>g</sub> |                          | 38 24 | .e | 48 | íb.si <sub>g</sub> |                          |
| 6 01  | .e | 19 | íb.si <sub>g</sub> |                          | 40 01 | .e | 49 | íb.si <sub>g</sub> |                          |
| 6 40  | .e | 20 | íb.si <sub>g</sub> |                          | 41 40 | .e | 50 | íb.si <sub>g</sub> |                          |
| 7 21  | .e | 21 | íb.si <sub>g</sub> |                          | 43 21 | .e | 51 | íb.si <sub>g</sub> |                          |
| 8 04  | .e | 22 | íb.si <sub>g</sub> |                          | 45 04 | .e | 52 | íb.si <sub>g</sub> |                          |
| 8 49  | .e | 23 | íb.si <sub>g</sub> |                          | 46 49 | .e | 53 | íb.si <sub>g</sub> |                          |
| 9 36  | .e | 24 | íb.si <sub>g</sub> |                          | 48 36 | .e | 54 | íb.si <sub>g</sub> |                          |
| 10 25 | .e | 25 | íb.si <sub>g</sub> |                          | 50 25 | .e | 55 | íb.si <sub>g</sub> |                          |
| 11 16 | .e | 26 | íb.si <sub>g</sub> |                          | 52 16 | .e | 56 | íb.si <sub>g</sub> |                          |
| 12 09 | .e | 27 | íb.si <sub>g</sub> |                          | 54 09 | .e | 57 | íb.si <sub>g</sub> |                          |
| 13 04 | .e | 28 | íb.si <sub>g</sub> |                          | 56 04 | .e | 58 | íb.si <sub>g</sub> |                          |
| 14 01 | .e | 29 | íb.si <sub>g</sub> |                          | 58 01 | .e | 59 | íb.si <sub>g</sub> |                          |
| 15    | .e | 30 | íb.si <sub>g</sub> |                          | 1     | .e | 1  | íb.si <sub>g</sub> |                          |

MS 3963 and MS 3864 are both of type a. However, MS 2185 is of a new type, which may be called “type a'”, in which each line of the table is of the form

$$\text{sq. } n .e n \text{ ba. si}_g \quad \text{sq. } n \text{ makes } n \text{ equalsided (where } n \text{ is an integer).}$$

There is no real difference between type a and type a', since íb. and ba. are two Sumerian grammatical prefixes with more or less the same function, but with no direct counterparts in English.

The Sumerian term for a (geometric) ‘square’ is íb.si<sub>g</sub>. It is a term characterizing a square as a (rectangular) *field with equal sides*, hence, for lack of a better alternative, the conform translation ‘equalside’. The Sumerian term for ‘side of a square’ is the same(!) as the term for a square. Therefore, ‘equalside’ can stand for both a square and the side of a square. Moreover, in some circumstances íb.si<sub>g</sub> has to be regarded as a verb, in other circumstances as a noun. This double ambivalence of the term íb.si<sub>g</sub> makes it even harder to find a good translation of the mentioned key phrase in Old Babylonian tables of square sides. (For a more thorough discussion of the matter, see Høyrup, *LWS* (2002), 25-27.)

In addition to being of the unusual type a', the table of square sides MS 2185 has a couple of other special features. Of minor importance is that it ends with a brief subscript or colophon, an invocation of the god Nisaba, the Sumerian god of grain, writing, and wisdom, and as such the patron of scribes. More interesting is that it makes use of what may be called “variant number signs” 7<sub>v</sub>, 8<sub>v</sub>, 9<sub>v</sub> for the numbers 7, 8, 9. The standard Old Babylonian 7 is written 3-3-1 (3 wedges on top of 3 wedges on top of 1 wedge), while the variant 7<sub>v</sub> is written 4-3 (4 wedges

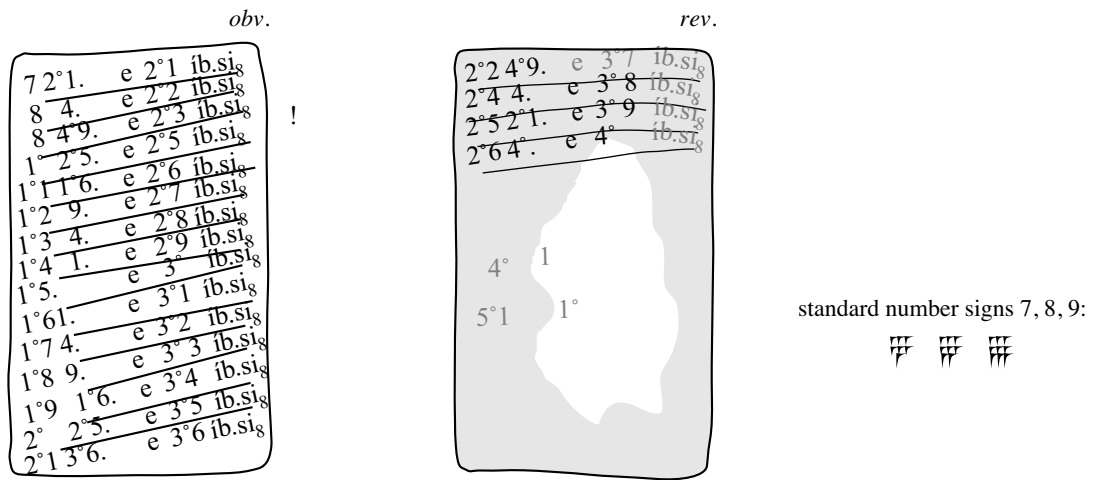

MS 3963. Square sides of squares of integers, from 21 to 40 (20 lines). Type a, with *ib.sig*. The line '9 36.e 24 *ib.sig*' is missing.

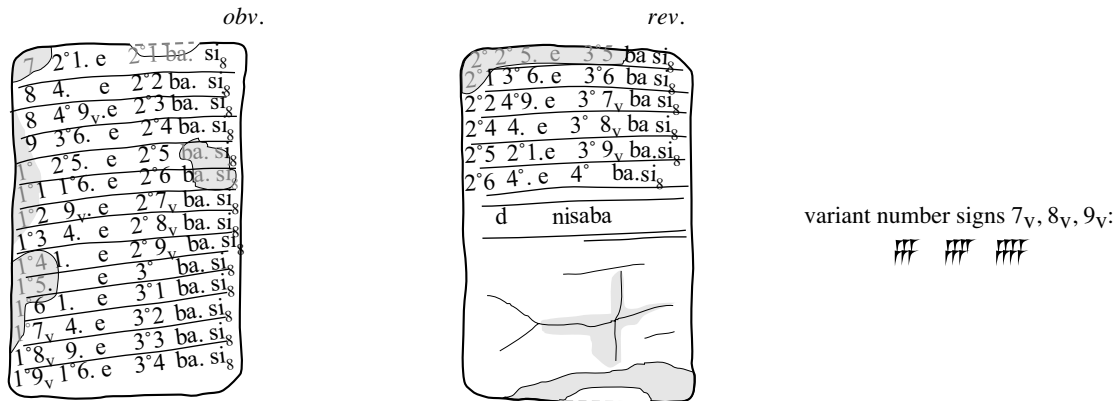

MS 2185. Square sides of squares of integers, from 21 to 40 (20 lines). Type a' (new), with *ba.sig*. Variant number signs for 7, 8, 9.

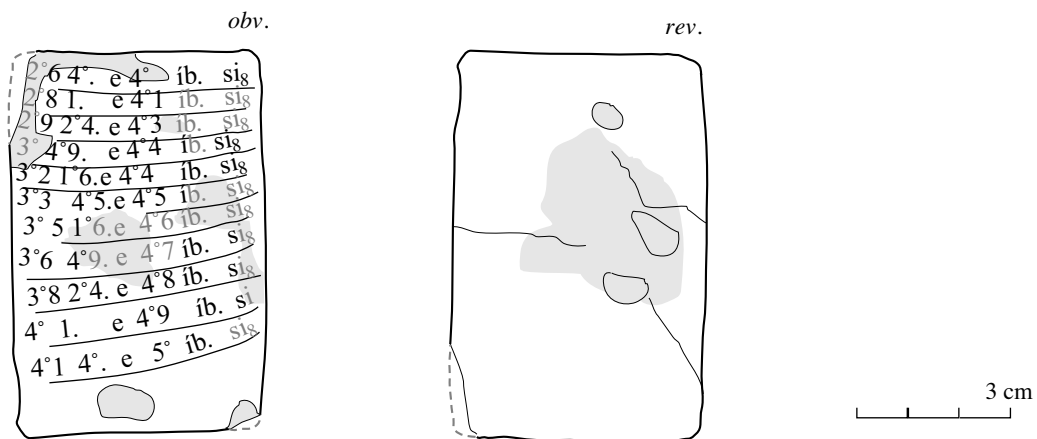

MS 3864. Square sides of squares of integers, from 40 to 50 (11 lines). Type a, with *ib.sig*.

Fig. 2.2.1. Three excerpts of the Old Babylonian complete table of square sides.

on top of 3 wedges). Similarly, the standard Old Babylonian 8 and 9 are written 3-3-2 and 3-3-3, respectively, while the variants  $8_v$  and  $9_v$  are written 4-4 and 5-4. (See the illustrations in Fig. 2.2.1 above.) Using the variant number signs is an archaic feature in an Old Babylonian text, since the variant signs were the ones used in the Neo-Sumerian Ur III period which preceded the Old Babylonian period.

A rapid survey shows that variant number signs can be found, often alternating with standard number signs, exclusively in Old Babylonian mathematical cuneiform texts from *southern* Mesopotamian cities such as Uruk, Larsa, and Ur. Such mathematical texts can be dated to before the fall of the southern cities in the year Samsuiluna 11, 1739 BC. In terms of the Goetze/Høyrup/Friberg classification of unprovenanced mathematical cuneiform texts, variant number signs are used only in texts belonging to groups 1, 2, and 3 or to the groups of series texts Sa and Sb (see § 7 and Appendix 1 in Friberg, *RA* 94 (2000)).

Although it may seem to be the case that the use of variant number signs is characteristic for relatively *early* Old Babylonian mathematical texts, from a wider perspective the situation is quite complex and confusing. See the discussion in Oelsner, *ChV* (2001), where the use of variant number signs in mathematical cuneiform texts of unknown dates is compared with the use of such number signs in securely dated non-mathematical (legal and administrative) texts.

### 2.3. Old Babylonian Tables of Cube Sides

A complete Old Babylonian table of cube sides looks like this:

|           |   |    |       |
|-----------|---|----|-------|
| 1.        | e | 1  | ba.si |
| 8.        | e | 2  | ba.si |
| 27.       | e | 3  | ba.si |
| 1 04.     | e | 4  | ba.si |
| 2 05.     | e | 5  | ba.si |
| 3 36.     | e | 6  | ba.si |
| 5 43.     | e | 7  | ba.si |
| 8 32.     | e | 8  | ba.si |
| 12 09.    | e | 9  | ba.si |
| 16 40.    | e | 10 | ba.si |
| 22 11.    | e | 11 | ba.si |
| 28 48.    | e | 12 | ba.si |
| 36 37.    | e | 13 | ba.si |
| 45 44.    | e | 14 | ba.si |
| 56 15.    | e | 15 | ba.si |
| 1 08 16.  | e | 16 | ba.si |
| 1 21 53.  | e | 17 | ba.si |
| 1 37 12.  | e | 18 | ba.si |
| 1 54 19.  | e | 19 | ba.si |
| 2 13 20.  | e | 20 | ba.si |
| 2 34 21.  | e | 21 | ba.si |
| 2 57 28.  | e | 22 | ba.si |
| 3 22 47.  | e | 23 | ba.si |
| 3 50 24.  | e | 24 | ba.si |
| 4 20 25.  | e | 25 | ba.si |
| 4 52 56.  | e | 26 | ba.si |
| 5 28 03.  | e | 27 | ba.si |
| 6 05 52.  | e | 28 | ba.si |
| 6 46 29.  | e | 29 | ba.si |
| 7 30.     | e | 30 | ba.si |
| 8 16 31.  | e | 31 | ba.si |
| 9 06 08.  | e | 32 | ba.si |
| 9 58 57.  | e | 33 | ba.si |
| 10 55 04. | e | 34 | ba.si |
| 11 54 35. | e | 35 | ba.si |
| 12 57 36. | e | 36 | ba.si |
| 14 04 13. | e | 37 | ba.si |
| 15 14 32. | e | 38 | ba.si |
| 16 28 39. | e | 39 | ba.si |
| 17 46 40. | e | 40 | ba.si |
| 19 08 41. | e | 41 | ba.si |
| 20 34 48. | e | 42 | ba.si |
| 22 05 07. | e | 43 | ba.si |
| 23 39 44. | e | 44 | ba.si |
| 25 18 45. | e | 45 | ba.si |
| 27 02 16. | e | 46 | ba.si |
| 28 50 23. | e | 47 | ba.si |
| 30 43 12. | e | 48 | ba.si |
| 32 40 49. | e | 49 | ba.si |
| 34 43 20. | e | 50 | ba.si |
| 36 50 51. | e | 51 | ba.si |
| 39 03 28. | e | 52 | ba.si |
| 41 21 17. | e | 53 | ba.si |
| 43 44 24. | e | 54 | ba.si |
| 46 12 55. | e | 55 | ba.si |
| 48 46 56. | e | 56 | ba.si |
| 51 26 33. | e | 57 | ba.si |
| 54 11 52. | e | 58 | ba.si |
| 57 02 59. | e | 59 | ba.si |
| 1.        | e | 1  | ba.si |



**MS 3863, and 3913** (Fig. 2.3.1 below) are two examples of Old Babylonian tables of cube sides. A *complete* table of cube sides lists the cube sides of the cubes of *all* integers from 1 to 1 (00) = 60. MS 3863 is an *excerpt* from a complete table of cube sides, with entries for cube sides from 41 to 1 (00) = 60, the last third of a complete table of cube sides. MS 3913 is an *abridged* table of cube sides, with entries only for cube sides from 1 to 20, and for 30, 40 and 50. Three other examples in the Schøyen Collection of such abridged tables of cube sides are **MS 3981, MS 3972, and MS 3985**.

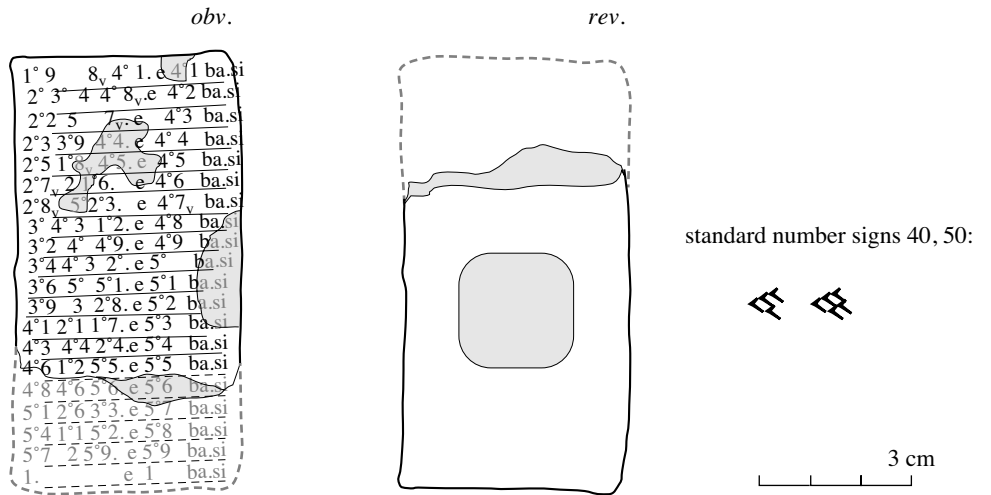

MS 3863. Cube sides from 41 to [1(00)] (20 lines). Type a. Variant number signs only for 7 and 8.

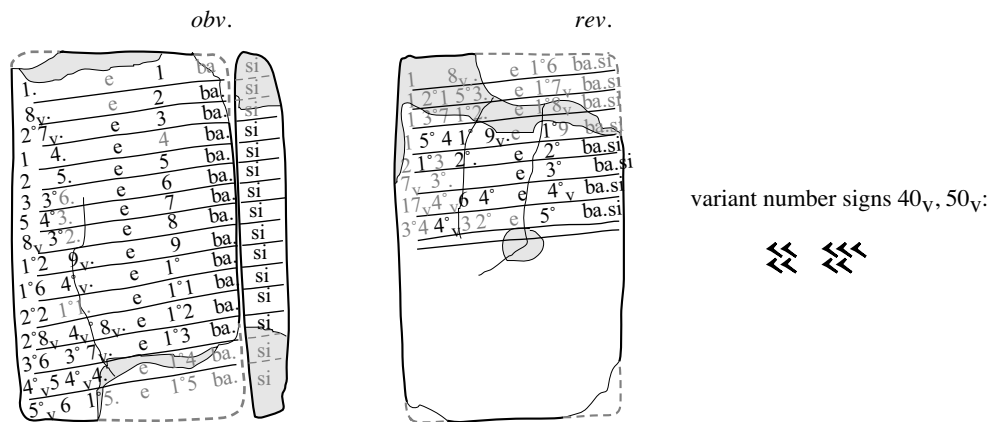

MS 3913. Cube sides from 1 to 20, and 30, 40, 50 (23 lines). Type a. Variant number signs for 7, 8, 9, 40, and 50.

Fig. 2.3.1. Two excerpts of Old Babylonian tables of cube sides, type a.

MS 3863 makes use of variant number signs only for 7 and 8, not for 9. On the reverse of MS 3863 there is a large but shallow square impression, of unknown significance, stamped into the clay.

MS 3913 is unusual in that it makes use of variant number signs not only for 7, 8, and 9, but also for 40, and 50. In their standard forms, 40 and 50 are written as 3 oblique wedges above 1 or 2 oblique wedges, respectively, in *slanting* rows. The variant form for 40 is 2 oblique wedges over 2, in *horizontal* rows, and the variant form for 50 is 3 oblique wedges over 2, again in horizontal rows. See the illustrations in Fig. 2.3.1 to the right, top and bottom.

Normally, tables of cube sides are of “type a”, in the sense that each line in such a table is of the form

cu.  $n$ . e  $n$  ba. si                      cu.  $n$  makes  $n$  likesided (where  $n$  is an integer)

Here, the cuneiform sign si is a homophone to the sign si<sub>8</sub>. Both signs stand for a Sumerian verb with the meaning ‘to be equal’. It is not clear why, in most cases, the sign si<sub>8</sub> is used in connection with squares and square sides, while the sign si is used in connection with cube sides. A possible explanation is that tables of cube sides was a relatively late invention, and that the way of writing the term /si/ had changed with time. What is known is that the sign si<sub>8</sub> (or sá) was used to describe the equalsidedness of squares already in Early Dynastic/Old Sumerian tables of squares (cf. the discussion in Ch. 6 below), but that *no pre-Babylonian tables of cube sides have yet been found*.

On the other hand, *no pre-Babylonian tables of square sides have been found either*. So, to complete the attempted explanation, it must be added that while it is natural to consider square courtyards, square bricks, and so on, there are no corresponding situations where it is natural to consider cube-shaped objects. For this reason, it is not really surprising that there are *no known examples of Sumerian or Babylonian tables of cubes*. It is tempting to draw the conclusion that, on one hand, the existence of Sumerian and Babylonian tables of squares can be explained as a consequence of the fact that squares are commonly occurring artefacts, while, on the other hand, the existence of Old Babylonian tables of square sides and cube sides can be explained only as a consequence of Old Babylonian mathematicians’ preoccupation with quadratic and cubic equations! (Cf. Sec. 2.4 below with its discussion of tables of quasi-cube sides.)

Six tables of cube sides in the Schøyen Collection are of type a. There are, in addition to MS 3863, and 3913, mentioned above, the following three:

**MS 2987**, an excerpt from a table of cube sides, from 21 to 40 (15 + 5 lines, with a subscript in 2 lines)

**MS 3931**, another excerpt from 21 to 40 (16 + 4 lines)

**MS 3962**, a brief excerpt from a table of cube sides, from 50 to 1 (00) (11 lines)

**MS 3972**, a complete abridged table of cube sides, like MS 3913 (23 lines)

Three tables of cube sides in the Schøyen Collection are of other types than type a. One of them is **MS 3973/1** (Fig. 2.3.2, top), a table of cube sides from 31 to 1 (00) = 60, which is of “type b” in the sense that each line in the table is of the *purely numerical* form

cu.  $n$      $n$     (where  $n$  is an integer)

There is an error in this text, in line 3 on the reverse, where the cube of 54 is given as 43 13 43 instead of 43 44 24. There is no obvious explanation of this error.

**MS 3966** (Fig. 2.3.2, middle) is a small square tablet, inscribed on the obverse with only five lines from a table of cube sides, with  $n$  from 13 to 17. Its type is a somewhat strange variant of the purely numerical type b, in that the first line of numbers in the brief table is followed on the right edge by the word íb.si-tam = (possibly) *mithartam* (*mithartum* is the Akkadian counterpart to the Sumerian íb.si ‘likesided’, *mithartam* is the accusative of *mithartum*, and -tam would then be a phonetic complement to íb.si, presumably showing that íb.si was understood as a logogram for *mithartum*). The accusative shows that the line should be translated as ‘36 37 (makes) 13 likesided’.

Note: In an attempt to make a distinction between cube sides and square sides, the term ‘likesided’ was used above in connection with cube sides, but ‘equalsided’ in connection with square sides. After all, while the Akkadian counterpart of the Sumerian terms íb.si<sub>8</sub>/ba.si<sub>8</sub> is known to have been *mithartum*, it is not impossible that the Akkadian counterpart of ba.si/íb.si may have been some other Akkadian word.

**MS 2996** (Fig. 2.3.2, bottom) is a table of cube sides from 46 to 1 (00) = 60. It is of a new type, which may be called “type c” with entries of the form

cu.  $n$      $n$ .àm    ba. si                      cu.  $n$ ,     $n$     it is, likesided

(It is difficult to know what a more precise translation of the Sumerian phrase should be.) This type is related to, but not identical with, what Neugebauer called “type 2 a” (*MKT 1*, 75).

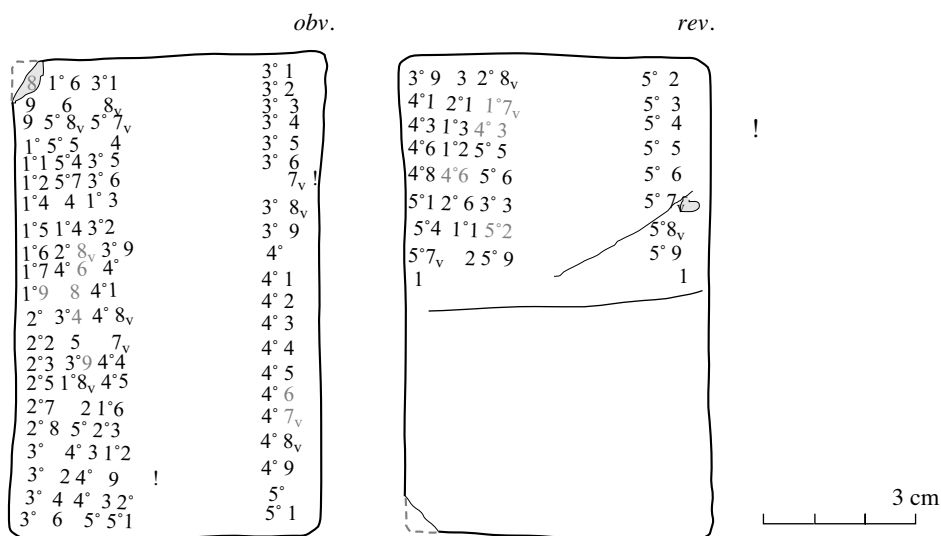

MS 3973/1. Cube sides from 31 to 1 (00) (30 lines). Type b (new). Variant number signs for 7 and 8. The entry in line 3 on the reverse is incorrect, with 43 13 53 instead of 43 44 24.

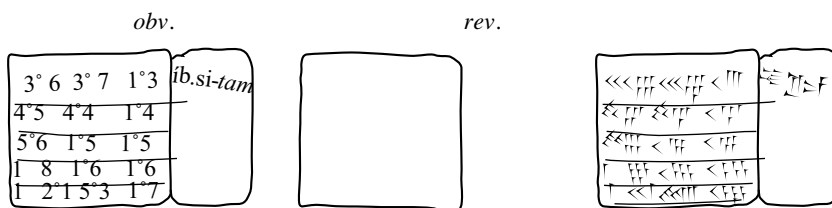

MS 3966. Cube sides from 13 to 17 (5 lines). Type b' (new).

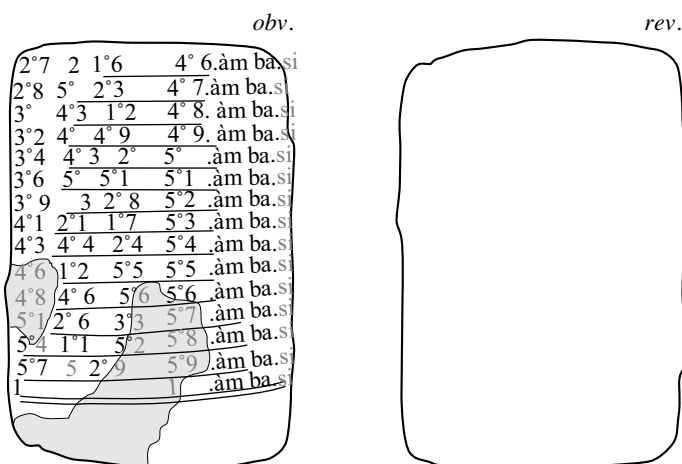

MS 2996. Cube sides from 46 to 1 (00) (15 lines). Type c (new).

Fig. 2.3.2. Three excerpts of Old Babylonian tables of cube sides, of new types.

### 2.4. Old Babylonian Tables of Quasi-Cube Sides

#### 2.4 a. MS 3899. A Table of $n \cdot n \cdot (n + 1)$ Sides

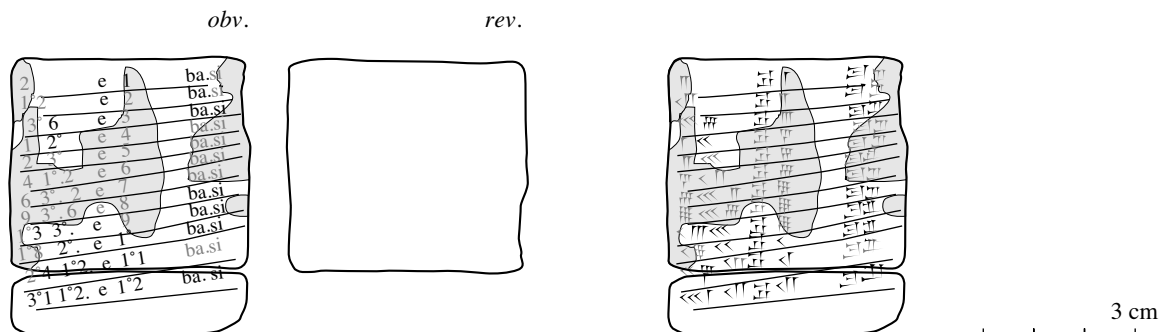

MS 3899. A table of  $n \cdot n \cdot (n + 1)$  sides from 1 to 12.

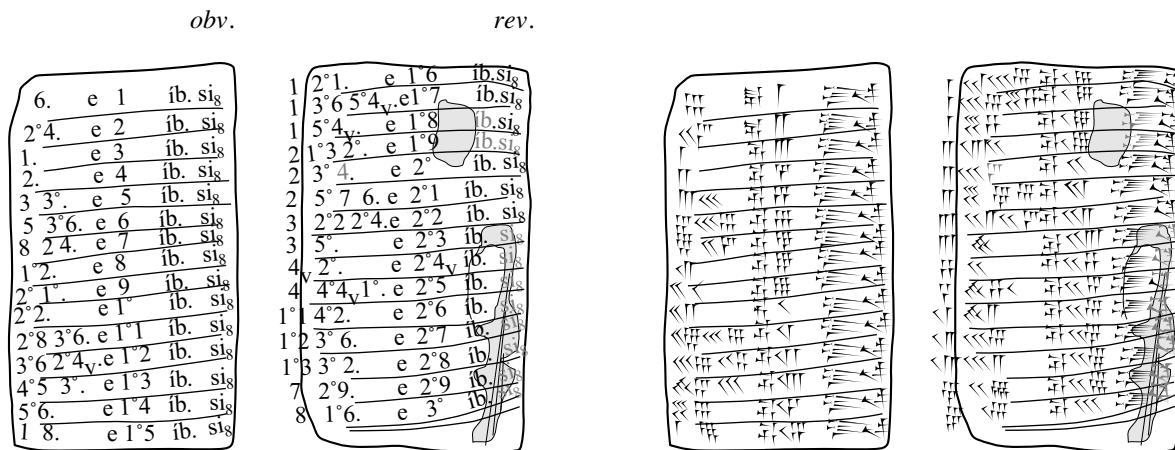

MS 3048. A table of  $n \cdot (n + 1) \cdot (n + 2)$  sides from 1 to 30.

Fig. 2.4.1. Two Old Babylonian tables of quasi-cube sides, of two different kinds.

**MS 3899** (Fig. 2.4.1, top) is a small, squarish tablet, inscribed with a table text on the obverse and the lower edge. Much of the text on the obverse is damaged, but at least the lines close to and on the lower edge are clearly legible. The general layout of the text is that of a table of cube sides, with entries of the form

$$m \text{ e } n \text{ ba.si} \qquad m \text{ makes } n \text{ likesided}$$

In the 12 lines of text, the ‘likesided’  $n$  proceeds from 1 to 12, and it is easy to check that whenever the value of  $m$  is preserved, it satisfies the equation

$$m = n \cdot n \cdot (n + 1).$$

Hence, it may be motivated to call MS 3899 a table of “quasi-cube sides”, or, more precisely, a table of “ $n \cdot n \cdot (n + 1)$  sides”. (Cf. Friberg, *RIA* 7 (1990) Sec. 5.2 f.)

A reconstruction of the whole text of the table is given below.

## MS 3899

|           |     |     |         |                          |       |
|-----------|-----|-----|---------|--------------------------|-------|
| [2]       | .e  | 1   | ba.[si] | $1 \cdot 1 \cdot 2 =$    | 2     |
| [12]      | .e  | [2] | ba.[si] | $2 \cdot 2 \cdot 3 =$    | 12    |
| [3]6      | .e  | [3] | ba.si   | $3 \cdot 3 \cdot 4 =$    | 36    |
| [1] 20    | [.e | 4   | ba.si]  | $4 \cdot 4 \cdot 5 =$    | 1 20  |
| [2 30     | .e  | 5   | ba.si]  | $5 \cdot 5 \cdot 6 =$    | 2 30  |
| [4 12     | .e  | 6   | ba.si]  | $6 \cdot 6 \cdot 7 =$    | 4 12  |
| [6 32     | .e  | 7   | ba.si]  | $7 \cdot 7 \cdot 8 =$    | 6 32  |
| [9 36     | .e  | 8]  | ba.si   | $8 \cdot 8 \cdot 9 =$    | 9 36  |
| [1]3 30   | .e  | [9] | ba.si   | $9 \cdot 9 \cdot 10 =$   | 13 30 |
| [18] 20   | .e  | 10  | ba.si   | $10 \cdot 10 \cdot 11 =$ | 18 20 |
| [2]4 1[2] | .e  | 11  | [ba.si] | $11 \cdot 11 \cdot 12 =$ | 24 12 |
| 31 12     | .e  | 12  | ba.si   | $12 \cdot 12 \cdot 13 =$ | 31 12 |

VAT 8492 § 3. Another Table of  $n \cdot n \cdot (n + 1)$  Sides, for  $n$  from [1] to [1 00]

The large table text **VAT 8492** is mentioned repeatedly by Neugebauer in *MKT 1*, unfortunately without any reference to a photo or hand copy of the tablet. The first paragraph of the text (col. *i* 1 - col. *ii* 15; *MKT 1*, 70) is a table of square sides, with each line of the form

$$m.e.n \text{ íb.si}_g \quad m \text{ makes } n \text{ equalsided} \quad (\text{for } n \text{ from [1] to 1 00})$$

The second paragraph (col. *ii* 16 - col. *iii* 30; *MKT 1*, 73) is a table of cube sides,

$$m.e.n \text{ ba.si} \quad m \text{ makes } n \text{ likesided} \quad (\text{for } n \text{ from 1 to [1 00]})$$

The third, and last paragraph (col. *iii* 31 - col. *iv* 45; *MKT 1*, 76) is a table of  $n \cdot n \cdot (n + 1)$  sides, again with each line of the form

$$m.e.n \text{ ba.si} \quad m \text{ makes } n \text{ likesided} \quad (\text{for } n \text{ from [1] to [1 00]})$$

The transliteration of the quasi-cube table VAT 8492 offered in *MKT* is incomplete. A more complete transliteration is offered below:

## VAT 8492 § 3

|                         |     |                  |         |                          |          |
|-------------------------|-----|------------------|---------|--------------------------|----------|
| .....                   | ... | ...              | .....   | .....                    | .....    |
| [1 42 36                | .e  | 1]8 <sub>v</sub> | ba.si   | $18 \cdot 18 \cdot 19 =$ | 1 42 36  |
| [2 00 20                | .e  | 1]9              | ba.si   | $19 \cdot 19 \cdot 20 =$ | 2 00 20  |
| [2 20                   | .e] | 20               | ba.si   | $20 \cdot 20 \cdot 21 =$ | 2 20 00  |
| [2 41 42                | .e] | 21               | ba.si   | $21 \cdot 21 \cdot 22 =$ | 2 41 42  |
| [3 05 32                | .e] | 22               | ba.si   | $22 \cdot 22 \cdot 23 =$ | 3 05 32  |
| [3 31 36                | .e] | 23               | ba.si   | $23 \cdot 23 \cdot 24 =$ | 3 31 36  |
| [4                      | .e] | 24               | ba.si   | $24 \cdot 24 \cdot 25 =$ | 4 00 00  |
| [4 30 50]               | .e  | 25               | ba.si   | $25 \cdot 25 \cdot 26 =$ | 4 30 50  |
| 5 04 [12]               | .e  | 26               | ba.si   | $26 \cdot 26 \cdot 27 =$ | 5 04 12  |
| 5 40 12                 | .e  | 27 <sub>v</sub>  | [ba.si] | $27 \cdot 27 \cdot 28 =$ | 5 40 12  |
| 6 18 <sub>v</sub> [5]6  | .e  | 28 <sub>v</sub>  | [ba.si] | $28 \cdot 28 \cdot 29 =$ | 6 18 56  |
| 7 <sub>v</sub> 30.      | e   | 29               | [ba.si] | $29 \cdot 29 \cdot 30 =$ | 7 00 30! |
| 7 <sub>v</sub> 45       | .e  | 30               | [ba.si] | $30 \cdot 30 \cdot 31 =$ | 7 45 00  |
| 8 <sub>v</sub> [32 32.  | e]  | 3[1              | ba.si]  | $31 \cdot 31 \cdot 32 =$ | 8 32 32  |
| 9 23 [12.               | e]  | 3[2              | ba.si]  | $32 \cdot 32 \cdot 33 =$ | 9 32 12  |
| 10 17 <sub>v</sub> [06. | e]  | 3[3              | ba.si]  | $33 \cdot 33 \cdot 34 =$ | 10 17 06 |
| 11 14 20                | [.e | 34               | ba.si]  | $34 \cdot 34 \cdot 35 =$ | 11 14 20 |
| 12 15.                  | [e  | 35               | ba.si]  | $35 \cdot 35 \cdot 36 =$ | 12 15 00 |
| 13 19 1[2               | .e  | 36               | ba.si]  | $36 \cdot 36 \cdot 37 =$ | 13 19 12 |
| 14 27 <sub>v</sub> [02  | .e  | 37 <sub>v</sub>  | ba.si]  | $37 \cdot 37 \cdot 38 =$ | 14 27 02 |
| 15 38 <sub>v</sub> 3[6  | .e  | 38 <sub>v</sub>  | ba.si]  | $38 \cdot 38 \cdot 39 =$ | 15 38 36 |
| 16 [5]4                 | [.e | 39               | ba.si]  | $39 \cdot 39 \cdot 40 =$ | 16 54 00 |

Continued

|             |       |       |        |              |       |          |
|-------------|-------|-------|--------|--------------|-------|----------|
| 18 13 20    | [.e   | 40    | ba.si] | 40 · 40 · 41 | =     | 18 13 20 |
| 19 3[6 42   | .e    | 41    | ba.si] | 41 · 41 · 42 | =     | 19 36 42 |
| 21 [04 12   | .e    | 42    | ba.si] | 42 · 42 · 43 | =     | 21 04 12 |
| 22 [35 36   | .e    | 43    | ba.si] | 43 · 43 · 44 | =     | 22 35 36 |
| 24 [12      | .e    | 44    | ba.si] | 44 · 44 · 45 | =     | 24 12 00 |
| 25 [52 30   | .e    | 45    | ba.si] | 45 · 45 · 46 | =     | 25 52 30 |
| 27 [37 32   | .e    | 46    | ba.si] | 46 · 46 · 47 | =     | 27 37 32 |
| 2[9] 27 [12 | .e    | 47    | ba.si] | 47 · 47 · 48 | =     | 29 27 12 |
| 31 [2]1 [36 | .e    | 48    | ba.si] | 48 · 48 · 49 | =     | 31 21 36 |
| 3[3 20 50   | .e    | 49    | ba.si] | 49 · 49 · 50 | =     | 33 20 50 |
| 35 [25      | .e    | 50    | ba.si] | 50 · 50 · 51 | =     | 35 25 00 |
| .....       | ..... | ..... | .....  | .....        | ..... | .....    |

Below, in Fig. 2.4.2, is presented a new conform transliteration of the quasi-cube table on VAT 8492:

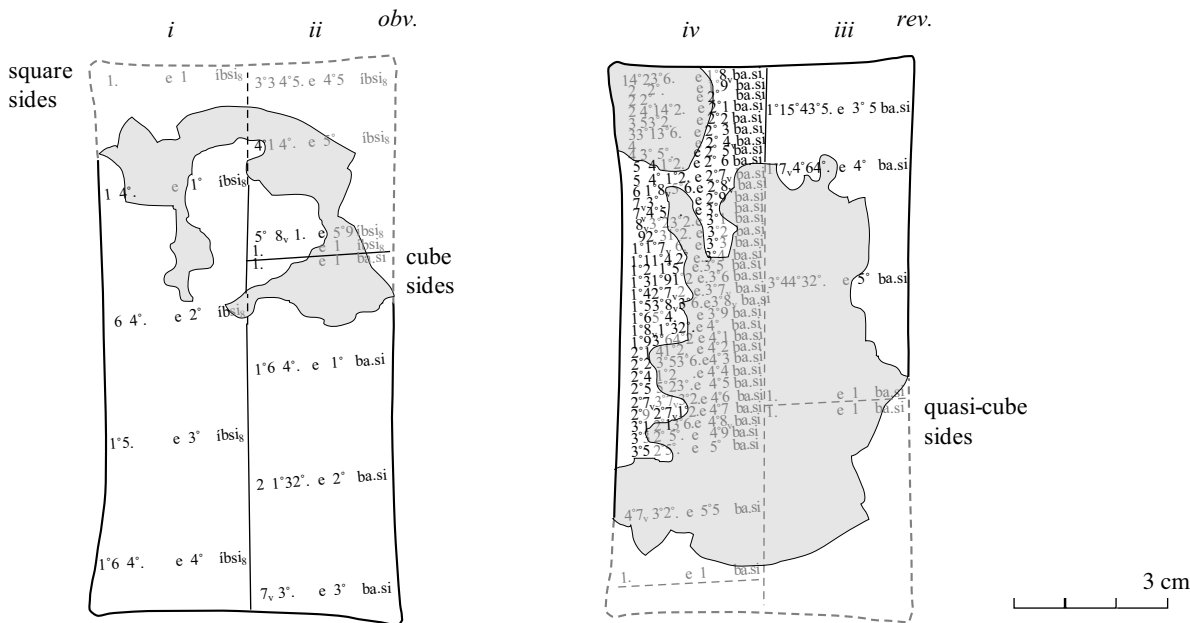

Fig. 2.4.2. VAT 8492. A combined table for square sides, cube sides (in outlines only), and quasi-cube sides.

2.4 b. For What Could a Table of  $n \cdot n \cdot (n + 1)$  Sides Possibly be Used?

The answer to this question is well known (see Neugebauer, *MKT 1* (1935), 210, and Høyrup, *LWS* (2002), 149-154). The fact that the product  $n \cdot n \cdot (n + 1)$  is equal to the sum of the cube of  $n$  and the square of  $n$  is behind the utilization of a table of  $n \cdot n \cdot (n + 1)$  sides in the large Old Babylonian mathematical theme text **BM 85200 + VAT 6599 ## 5 and 23**. The theme of that text is quadratic or cubic equations for the sides of an excavated box-like room (a “cellar”). In addition to ## 5 and 23, other exercises in the text dealing with cubic equations are ## 6-7 ## 20-22, and (probably) the now lost ## 1-4. The solution methods used in ## 6-7 and 20-22 are, almost certainly, trivial factorizations. Anyway, what makes the series of cubic equations in BM 85200 + VAT 6599 particularly interesting is that no other known cuneiform texts deal with cubic equations, other than extractions of cube sides in particularly easy cases. Here follows a transliteration and translation of one of the exercises making use of the table of  $n \cdot n \cdot (n + 1)$  sides:

**BM 85200 + VAT 6599 # 5.** (Høyrup, *LWS*, 138.) **A cubic equation for the sides of an excavated room.**

|      |  |  |
|------|--|--|
| 1'   | [uš sa]g en.nam /                        | Length and front are what?                   |
| 2'   | [... 3 ta-mar]                           | ... 3 you see.                               |
| 2' 3 | he-pé 1 30 ta-mar /                      | 1/2 of 3 break, 1 30 you see.                |
| 3'   | [igi 1 30 du <sub>8</sub> .a]            | <i>The opposite of 1 30 resolve,</i>         |
|      | 40 ta-mar bal sag                        | 40 you see, the ratio of the front.          |
|      | igi 12 bal gam                           | The opposite of 12, the ratio of the depth,  |
| 4'   | du <sub>8</sub> .a / [5 ta-mar]          | resolve, 5 you see.                          |
|      | [a-na 1] i-ši 5 ta-mar                   | To 1 raise, 5 you see.                       |
|      | a-na 40 i-ši 3 20 ta-mar /               | to 40 raise, 3 20 you see.                   |
| 5'   | [3 20] a-na 5 i-ši 16 40 ta-mar          | 3 20 to 5 raise, 16 40 you see.              |
|      | igi 16 40 du <sub>8</sub> .a 3 36 ta-mar | The opposite of 16 40 resolve, 3 36 you see. |
| 6'   | 3 36 / a-na 1 10 i-ši 4 12 ta-mar        | 3 36 to 1 10 raise, 4 12 you see,            |
|      | 6 íb.sig                                 | 6 equalsided.                                |
|      | 6 a-na 5 i-ši 30 ta-<mar>                | 6 to 5 raise, 30 you <see>.                  |
| 7'   | 6 a-na 3 20 i-<ši> / 20 sag              | 6 to 3 20 r<aise>, 20, the front.            |
|      | 6 a-na 1 i-ši 6 ta-mar gam               | 6 to 1 raise, 6 you see, the depth.          |
| 8'   | ki-a-am / ne-pé-šum                      | Such is the procedure.                       |

(The form of the sign 2' for '1/2' is shown in Fig. A4.2 in Appendix 4.) The question asked in the lost first few lines of this exercise may have been formulated in something like the following way:

An excavated room. As much as two times the length is three times the front. As much as the length is the depth.  
The mud I have torn out. The ground and the mud together, 1 10. Length and front are what?

In modern symbolic notation, the question can be reformulated as follows:

Let  $u$  be the long side (the length),  $s$  the short side (the front), and  $d$  the depth of a rectangular excavated room.

Let  $V$  be the volume (the mud), and let  $A$  be the base area (the ground) of the room.

Assume that  $s \cdot 3 = u \cdot 2$ , that  $d = u$ , and that  $A + V = 1;10$  (šar). Find  $u$ ,  $s$  (and  $d$ ).

A certain complication of the situation is caused by a well known peculiarity of Sumerian/Old Babylonian metrology, namely that the *horizontal* dimensions of the room,  $u$  and  $s$ , are measured in multiples of a ninda (= 6 meters), and multiplied by 'mutual eating (or holding)' ( $\times$ ), while the *vertical* dimension  $d$  is measured in multiples of a cubit (= 1/2 meter, since 1 ninda = 12 cubits), and is 'raised' to the base area ( $\cdot$ ). (See Høyrup, *LWS*, 20-21.) The base area is measured in sq. ninda (area šar), and the volume in sq. ninda times cubits (volume šar).

A second complication arises because, strictly speaking, the base area  $A$ , measured in area šar, cannot freely be added to the volume  $V$ , measured in volume šar. As first pointed out by Høyrup, Old Babylonian mathematicians apparently interpreted the expression "the ground and the mud together" as meaning the sum of two volumes, the first equal to the base area *multiplied by a unit of depth* (1 cubit), the second equal to the base area multiplied by the actual depth. In other words,

$$"A + V" = A \cdot 1 \text{ cubit} + A \cdot d = A \cdot (d + 1 \text{ cubit}).$$

Therefore, the question presumably stated in the first lines of # 5 can be further reformulated and made more precise as follows:

Let  $u = a \cdot 1$  ninda,  $s = a \cdot 2/3$  ninda, and  $d = a \cdot 12$  cubits.

Find  $a$  so that " $A + V$ " = 1;10 volume šar.

Since " $A + V$ " =  $a \cdot 1 \times a \cdot 2/3 \cdot (a \cdot 12 + 1)$  volume šar, this means that

$a$  must be a solution to the cubic equation  $a \cdot a \cdot 2/3 \cdot (a \cdot 12 + 1) = 1;10$ .

In the absence of modern symbolic notations, the cuneiform text mentions

;40, the 'ratio of the front' (bal sag), an expression corresponding to the modern equation  $s = a \cdot 2/3$ ,

and

12, the 'ratio of the depth' (bal gam), an expression corresponding to the modern equation  $d = a \cdot 12$ .

The equation  $a \cdot a \cdot 2/3 \cdot (a \cdot 12 + 1) = 1;10$  cannot be solved directly by use of the  $n \cdot n \cdot (n + 1)$  table. A further transformation is needed, in modern terms the introduction of  $n = a \cdot 12$  as a new unknown, so that  $a = n \cdot ;05$ . Since  $d = a \cdot 12$  cubits, this transformation can be interpreted as *the use of the depth rather than the length as a new primary unknown*. Hence, the following final reformulation of the stated question in # 5:

Let  $d = n$  cubits. Then  $u = n \cdot ;05 \cdot 1$  ninda =  $n \cdot ;05$  ninda, and  $s = n \cdot ;40 \cdot ;05$  ninda =  $n \cdot ;03 20$  ninda. Consequently, “ $A + V$ ” =  $n \cdot ;05 \times n \cdot ;03 20 \cdot (n + 1)$  volume šar =  $n \cdot n \cdot (n + 1) \cdot ;00 16 40$  volume šar, and  $n$  must be a solution to the cubic equation  $n \cdot n \cdot (n + 1) \cdot ;00 16 40 = 1;10$ . After multiplication by 3 36, the reciprocal of ;00 16 40, the equation is reduced to  $n \cdot n \cdot (n + 1) = 4 12$ .

It is easy to check that, indeed,

$$1 \cdot ;05 = ;05, \quad ;40 \cdot ;05 = ;03 20, \quad ;05 \cdot ;03 20 = ;00 16 40, \quad ;00 16 40 \cdot 3 36 = 1, \quad \text{and} \quad 3 36 \cdot 1;10 = 4 12.$$

These computations are explicitly mentioned in lines 3' - 6' of # 5. The unknown  $n$  was probably thought of as a correction factor for 1, the new bal gam ‘ratio of the depth’. Its value could be obtained from the line of an  $n \cdot n \cdot (n + 1)$  table saying

4 12.e    6 íb.sig                      4 12 makes 6 equalsided

With  $n = 6$ , it follows, as stated in lines 6' - 7' of # 5, that

$$u = 6 \cdot ;05 \text{ (ninda)} = ;30 \text{ (ninda)}, \quad s = 6 \cdot ;03 20 \text{ (ninda)} = ;20 \text{ (ninda)}, \quad \text{and} \quad d = 6 \cdot 1 \text{ (cubit)} = 6 \text{ (cubits)}.$$

**BM 85200 + VAT 6599 # 23** is a second exercise making use of the  $n \cdot n \cdot (n + 1)$  table. It is shown below in transliteration and translation:

**BM 85200 + VAT 6599 # 23.** (Høyrup, LWS (2002), 145.) **Another cubic equation.**

|   |  |  |
|---|--|--|
| 1 | túl.sag<br><i>ma-la uš-tam-ħir</i><br>ù 1 kùš diri gam-ma<br>1 45 saħar.ħi.a [ba].zi/                        | An excavated room (a cellar).<br>As much as I made equalsided,<br>and 1 cubit beyond, the depth, then<br>1 45 of mud I tore out. |
| 2 | za.e<br>5 diri a-na 1 bal i-ši 5 ta-mar<br>a-na 12 i-š[i 1] ta-mar /   | You:<br>The 5 beyond to 1, the ratio, raise, 5 you see.<br>To 12 raise, 1 you see.   |
| 3 | 5 šu-tam-<ħir> 25 ta-mar<br>25 a-na 1 i-ši 25 ta-mar   | 5 make equalsi<ded>, 25 you see.<br>25 to 1 raise, 25 you see.   |
| 4 | igi [25 du <sub>g</sub> .a] / 2 24 ta-mar<br>2 24 a-na 1 45 i-ši 4 12 ta-mar /                               | The opposite of 25 resolve, 2 24 you see.<br>2 24 to 1 45 raise, 4 12 you see.   |
| 5 | i-na íb.sig 1 daħ.ħa<br>6 ša <sup>2</sup> íb.s[i <sub>g</sub> ]<br>6 a-na 5 i-š[i 30] ta-<mar> im-<ta-ħar> / | From the “equalside 1 added”,<br>6 is that which is made equalsided.<br>6 to 5 raise, 30 you see, it is made equalsided.         |
| 6 | 6 gam<br>ne-pé-š[um]   | 7 <sup>1</sup> the depth.<br>The procedure.  |

The question stated in line 1 of this exercise can be reformulated in modern symbolic notation as

Let  $u$  be the long side (the length),  $s$  the short side (the front),  $d$  the depth, and  $V$  the volume of a rectangular room. Assume that  $s = u$ , that  $d = u + 1$  cubit, and that  $V = 1;45$  (šar). (Find  $u$ ,  $s$  and  $d$ .)

The situation is simpler in this case than it was in the case of # 5. The question can immediately be made more precise, still in modern terms, as

Let  $u = s = a \cdot 1$  ninda, and let  $d = (a \cdot 12 + 1)$  cubits.  
 Then,  $V = a \cdot 1 \times a \cdot 1 \cdot (a \cdot 12 + 1)$  volume šar,  
 and  $a$  must be a solution to the cubic equation  $a \cdot a \cdot (a \cdot 12 + 1) = 1;45$ .

The equation  $a \cdot a \cdot (a \cdot 12 + 1) = 1;45$  cannot be directly solved by use of the  $n \cdot n \cdot (n + 1)$  table. As in the case of # 5, a further transformation is needed, in modern terms the introduction of  $n = a \cdot 12$  as a new unknown. Then  $a$  can be expressed as a multiple of  $n$ ,  $a = n \cdot ;05$ . Hence, the following final reformulation of the stated question in # 23:



Let  $d = (n + 1)$  cubits, and let  $u = s = n \cdot ;05 \cdot 1 \text{ ninda} = n \cdot ;05 \text{ ninda}$ .

Then,  $V = n \cdot ;05 \times n \cdot ;05 \cdot (n + 1)$  volume šar =  $n \cdot n \cdot (n + 1) \cdot ;00 25$  volume šar, and

$n$  must be a solution to the cubic equation  $n \cdot n \cdot (n + 1) \cdot ;00 25 = 1;45$ .

After multiplication by  $2 24$ , the reciprocal of  $;00 25$ , the equation is reduced to  $n \cdot n \cdot (n + 1) = 4 12$ .

It is easy to check that, indeed,

$$1 \cdot ;05 = ;05, \quad 12 \cdot ;05 = 1, \quad ;05 \cdot ;05 = ;00 25, \quad ;00 25 \cdot 2 24 = 1, \quad \text{and} \quad 2 24 \cdot 1;45 = 4 12.$$

These computations are explicitly mentioned in lines 2-4 of # 23. The value of  $n$  can now, just as in # 5, be obtained from the line of an  $n \cdot n \cdot (n + 1)$  table saying

$$4 12.e \quad 6 \text{ ib.sig} \quad 4 12 \text{ makes 6 equalsided.}$$

With  $n = 6$ , it follows that

$$u = s = 6 \times ;05 \text{ (ninda)} = ;30 \text{ (ninda)}, \text{ and } d = 6 + 1 \text{ (cubits)} = 7 \text{ (cubits)}.$$

The answer provided in lines 5-6 of # 23 amounts to saying that the horizontal sides of the excavated room are equal to  $6 \cdot ;05 = 30$ , and that the depth is 6, a mistake for 7. Maybe the author of the text forgot that he had assumed the depth to be  $n + 1$  (cubits), not  $n$  (cubits) as in # 5.

### 2.4 c. VAT 8521. A Problem Text with References to a Table of $n \cdot n \cdot (n - 1)$ Sides

The large table text VAT 8492 mentioned above contains tables for  $n$  from 1 to 1 00 for square sides, cube sides, and  $n \cdot n \cdot (n + 1)$  sides, showing that the table of  $n \cdot n \cdot (n + 1)$  sides was regarded as a natural generalization of the more common table of cube sides. Problems ## 5 and 23 of the mathematical theme text BM 85200 + VAT 6599 demonstrated that the table of  $n \cdot n \cdot (n + 1)$  sides was so familiar to Old Babylonian mathematicians that it was possible to include a reference to that kind of table in an Old Babylonian mathematical exercise.

In a similar way, the curious mathematical theme text **VAT 8521** (Neugebauer, *MKT 1*, 352) demonstrates that a table of “ $n \cdot n \cdot (n - 1)$  sides” was regarded as another natural generalization of the common table of cube sides, and that it was possible to include a reference to that kind of table, too, in an Old Babylonian mathematical exercise. VAT 8521 is a theme text with four similarly worded exercises, all ostensibly concerned with interest problems. The interest rate is the usual 12 shekels per mina (that is, 20%), but the questions are quite nonsensical, asking what the initial capital will be if one year’s interest is required to be a square (## 1 and 3), a cube (# 2) or a number of the form  $n \cdot n \cdot (n - 1)$  (# 4). The answers provided are the following:

# 1: if the interest is, for instance, 1 40 (the square of 10), then the initial capital is 8 20

# 2: if the interest is, for instance, 7 30 (00) (the cube of 30), then the initial capital is 37 30 (00)

# 3: if the interest is, for instance, 36 (the square of 6), then the initial capital is 3 (00)

# 4: if the interest is, for instance, 18 (=  $n \cdot n \cdot (n - 1)$  with  $n = 3$ ), then the initial capital is 1 30

This text is historically very interesting, because it is the only known Old Babylonian precursor of a problem type that reappears nearly 2000 years later in Diophantus’ *Arithmetica*.

Below is presented the full text of problem # 4, in transliteration and translation:

#### VAT 8521 # 4. An artificial interest problem.

|   |   |
|---|---|
| 1 | <i>a-na</i> 1 ma.na [1]2 gín <i>i-di-in-ma</i> /                  |
| 2 | máš ba.si.1.lá <i>li-id-di-kum</i> /                              |
| 3 | 1 ma.na [gar.r]a 12 §[i]- <i>ip-tam</i> gar.ra /                  |
| 4 | ù 18 a.r[á š]a ba.si.1.lá<br><i>i-[na-di-nu-kum</i> gar.ra-ma] /  |
| 5 | 1 ma.na <i>a-na</i> 12 máš íl 12<br>igi 12 <i>p[u-t]ur-ma</i> 5 / |
| 6 | 5 <i>a-na</i> 18 a.rá ša ša-ak-nu íl 1 30 /                       |
| 7 | 1 30 sag kù.babbar /  |

To 1 mina 12 shekels he gave, then interest (as) “likeside-1-minus” may he give to you.  
1 mina set, 12, the interest, set,  
and 18 (as) the factor that “likeside-1-minus”  
will give to you set, then  
1 mina to 12, the interest, raise, 12.  
The opposite of 12 resolve, then 5.  
5 to 18, the factor that was set, raise, 1 30.  
1 30 is the initial silver.

|    |  |   |
|----|--|---|
| 8  | <i>šum-ma</i> 1 30 sag kù.babbar                 | If 1 30 is the initial silver, (and)                    |
| 9  | <i>a-na</i> 1 ma.na 12 <i>lu-ud-di-im-ma</i> /   | for 1 mina 12 he may give, then                         |
| 10 | 18 máš.bi 1 <i>li-id-di-nam</i> /                | 18 its interest 1(?) may he give to me.                 |
| 11 | 1 ma.na <i>a-na</i> 12 <i>ši-ip-tim</i> íl 12 /  | 1 mina to 12, the interest, raise, 12.                  |
| 12 | 12 <i>a-na</i> 1 30 sag kù.babbar íl 18 máš.bi / | 12 to 1 30, the initial silver, raise, 18 its interest. |
| 13 | ba.si 18.e <sup>2</sup> 1.lá en.nam 3            | 18 (as) “likeside-1-minus” is what? 3.                  |

In lines 1-2 of this problem text, the interest is requested to be in the form of ba.si.1.lá, a term meaning something like ‘cube-minus-1’. In line 4 it is suggested that 18 should be chosen as the value of the cube-minus-1. In lines 5-7, the initial capital is then found to be 1 30. The verification follows in lines 8-12, and in line 13 it is noted that 18 is the cube-minus-1 corresponding to (the side) 3. (It is difficult to understand the syntax of the text in line 13, but the meaning is clear.)

#### 2.4 d. MS 3048. A Table of $n \cdot (n + 1) \cdot (n + 2)$ Sides

**MS 3048** (Fig. 2.4.1 above) is an Old Babylonian table of quasi-cube sides of a completely new kind, a table of “ $n \cdot (n + 1) \cdot (n + 2)$  sides”. The integer  $n$  proceeds from 1 to 15 on the obverse of the clay tablet and from 16 to 30 on the reverse, as shown in the transliteration below. Errors are marked with bold style.

|                      |    |    |        |                |           |                                    |
|----------------------|----|----|--------|----------------|-----------|------------------------------------|
| 6                    | .e | 1  | íb.sig | 1 · 2 · 3 =    | 6         |                                    |
| 24                   | .e | 2  | íb.sig | 2 · 3 · 4 =    | 24        |                                    |
| 1                    | .e | 3  | íb.sig | 3 · 4 · 5 =    | 1 00      |                                    |
| 2                    | .e | 4  | íb.sig | 4 · 5 · 6 =    | 2 00      |                                    |
| 3 30                 | .e | 5  | íb.sig | 5 · 6 · 7 =    | 3 30      |                                    |
| 5 36                 | .e | 6  | íb.sig | 6 · 7 · 8 =    | 5 36      |                                    |
| 8 24                 | .e | 7  | íb.sig | 7 · 8 · 9 =    | 8 24      |                                    |
| 12                   | .e | 8  | íb.sig | 8 · 9 · 10 =   | 12 00     |                                    |
| <b>20 10</b>         | .e | 9  | íb.sig | 9 · 10 · 11 =  | 16 30!    | 11 · 10 · 11 = 20 10               |
| 22                   | .e | 10 | íb.sig | 10 · 11 · 12 = | 22 00     |                                    |
| 28 36                | .e | 11 | íb.sig | 11 · 12 · 13 = | 28 36     |                                    |
| 36 24                | .e | 12 | íb.sig | 12 · 13 · 14 = | 36 24     |                                    |
| 45 30                | .e | 13 | íb.sig | 13 · 14 · 15 = | 45 30     |                                    |
| 56                   | .e | 14 | íb.sig | 14 · 15 · 16 = | 56 00     |                                    |
| 1 08                 | .e | 15 | íb.sig | 15 · 16 · 17 = | 1 08 00   |                                    |
| 1 21 36              | .e | 16 | íb.sig | 16 · 17 · 18 = | 1 21 36   |                                    |
| 1 36 54              | .e | 17 | íb.sig | 17 · 18 · 19 = | 1 36 54   |                                    |
| 1 54                 | .e | 18 | íb.sig | 18 · 19 · 20 = | 1 54 00   |                                    |
| 2 13 <b>20</b>       | .e | 19 | íb.sig | 19 · 20 · 21 = | 2 13 00 ! | 20 · 6 <b>40</b> = 2 13 <b>20</b>  |
| 2 34                 | .e | 20 | íb.sig | 20 · 21 · 22 = | 2 34 00   |                                    |
| 2 57 06              | .e | 21 | íb.sig | 21 · 22 · 23 = | 2 57 06   |                                    |
| 3 22 24 <sup>1</sup> | .e | 22 | íb.sig | 22 · 23 · 24 = | 3 22 24   |                                    |
| 3 50 <sup>1</sup>    | .e | 23 | íb.sig | 23 · 24 · 25 = | 3 50 00   |                                    |
| 4 20                 | .e | 24 | íb.sig | 24 · 25 · 26 = | 4 20 00   |                                    |
| <b>4 44 10</b>       | .e | 25 | íb.sig | 25 · 26 · 27 = | 4 52 30 ! | 25 · 11 <b>22</b> = <b>4 44 10</b> |
| <b>11 42</b>         | .e | 26 | íb.sig | 26 · 27 · 28 = | 5 27 36 ! | 26 · 27 = 11 42                    |
| <b>12 36</b>         | .e | 27 | íb.sig | 27 · 28 · 29 = | 6 05 24 ! | 27 · 28 = 12 36                    |
| <b>13 32</b>         | .e | 28 | íb.sig | 28 · 29 · 30 = | 6 36 00 ! | 28 · 29 = 13 32                    |
| <b>7 29</b>          | .e | 29 | íb.sig | 29 · 30 · 31 = | 7 29 30 ! | 30 · 14 <b>58</b> = 7 29 <b>00</b> |
| 8 16                 | .e | 30 | íb.sig | 30 · 31 · 32 = | 8 16 00   |                                    |

It is somewhat surprising that the “sides” in this table are called íb.sig ‘equalsides’, the term normally used in Old Babylonian tables of square sides, while ba.si ‘likesides’ is the term normally used in Old Babylonian tables of cube sides. Equally surprising is the use of the term íb.sig in the cubic equation problems BM 85200 + VAT 6599 # 5 and # 23, mentioned above. On the other hand, ba.si is the term used in the tables of  $n \cdot n \cdot$

$(n + 1)$  sides MS 3899 and VAT 8492 # 3, as well as in the artificial interest problem VAT 8521 # 4.

There is an error in line 9 of MS 3048, where 20 10 occurs instead of the correct value 16 30. The error can be explained as a trivial mistake, the computation of the product of 11, 10, and 11, instead of 9, 10, and 11.

The error in line 19 of the table, 2 13 20 instead of 2 13 (00), can probably be explained as follows. The author of the table, feeling smart, may have intended to compute  $19 \cdot 20 \cdot 21$  as

$$19 \cdot 20 \cdot 21 = 20 \cdot 19 \cdot 21 = 20 \cdot (\text{sq. } 20 - 1) = 20 \cdot (6 \text{ } 40 - 1) = 2 \text{ } 13 \text{ } 20 - 20 = 2 \text{ } 13.$$

For some reason, he ended up counting with  $20 \cdot \text{sq. } 20$  instead of with  $20 \cdot (\text{sq. } 20 - 1)$ .

The error in line 29 of the table can be explained in a similar way. The author of the table, again feeling smart, may have intended to compute  $29 \cdot 30 \cdot 31$  as

$$30 \cdot 29 \cdot 31 = 30 \cdot 14 \text{ } 59, \text{ arguing that } 29 \cdot 31 = (30 - 1) \cdot (30 + 1) = \text{sq. } 30 - \text{sq. } 1 = 15 \text{ (00)} - 1 = 14 \text{ } 59.$$

For some reason, he ended up counting with  $30 \cdot 14 \text{ } 58$  instead of with  $30 \cdot 14 \text{ } 59$ .

The error in line 25 of the table is even simpler to explain, since  $26 \cdot 27 = 11 \text{ } 42$ . The author of the table simply made the mistake of multiplying 25 with 11 22 instead of with 11 42.

The curious series of related errors in lines 26-28 seem to suggest that the author of the table had recourse to a table of " $n \cdot (n + 1)$  sides" (*a table of quasi-square sides*). He intended to facilitate his computations by computing, for instance,  $26 \cdot 27 \cdot 28$  as  $(26 \cdot 27) \cdot 28$ , with the value of  $26 \cdot 27$  fetched from the table of  $n \cdot (n + 1)$  sides. Being bored, after too many computations, he did not pay attention to what he was doing and ended up writing three lines of the table of  $n \cdot (n + 1)$  sides in the place of three lines of the table of  $n \cdot (n + 1) \cdot (n + 2)$  sides!

An alternative, although related, explanation is that the table of  $n \cdot (n + 1) \cdot (n + 2)$  sides on MS 3048 was copied from a larger table with values of  $n \cdot (n + 1)$  and values of  $n \cdot (n + 1) \cdot (n + 2)$  side by side, as in the following tentative reconstruction:

| $n$ | $n \cdot (n + 1)$ | $n \cdot (n + 1) \cdot (n + 2)$ |
|-----|-------------------|---------------------------------|
| ... | ... ..            | ... ..                          |
| 26  | 11 42             | 5 27 36                         |
| 27  | 12 36             | 6 05 24                         |
| 28  | 13 32             | 6 36 00                         |
| ... | ... ..            | ... ..                          |

In such a case, the errors in lines 26-29 would have resulted from values inadvertently being copied from three lines of col. 2 instead of from the corresponding three lines of col. 3.

#### 2.4 e. For What Could a Table of $n \cdot (n + 1) \cdot (n + 2)$ Sides Possibly be Used?

As shown above, cubic equations for the sides of an excavated room were solved by use of a table of  $n \cdot n \cdot (n + 1)$  sides in ## 5 and 23 of the large Old Babylonian mathematical theme text BM 85200 + VAT 6599. In # 5, the front (the short side) of the room is  $2/3$  of the length (the long side), and the depth is equal to length. In addition, the sum of the volume and the bottom area of the room is given. Actually, what is called "the sum of the volume and the area" is the volume plus *the bottom area multiplied by 1 cubit*. Therefore, that sum is the same thing as the bottom area multiplied by *the depth plus 1 cubit*. In # 23, the front of the room is equal to the length, the depth is equal to *the length plus 1 cubit*, and the volume is given. In either case, after suitable reformulations, the given problem could be reduced to finding a solution to the cubic equation  $n \cdot n \cdot (n + 1) = 4 \text{ } 12$ . The table of  $n \cdot n \cdot (n + 1)$  sides immediately gave the answer, that  $n = 6$ . And so on.

Is it possible that the table of  $n \cdot (n + 1) \cdot (n + 2)$  sides was used in a similar way, as a tool for solving a certain class of cubic equations? The answer is yes, and it is not difficult to think of (constructed) examples. Consider, for instance, a problem of the following type (Fig. 2.4.3):

An excavated room. The length exceeds the front by 1 cubit. As much as the length is the depth. The mud I have torn out. The ground and the mud together, 1;27 30. Length and front are what?

In modern symbolic notations, the question can be reformulated as follows:

Let  $u$  be the long side (the length),  $s$  the short side (the front), and  $d$  the depth of a rectangular room. Let  $V$  be the volume (the mud), and let  $A$  be the base area (the ground) of the room. Assume that  $s = u - 1$  cubit, that  $d = u$ , and that  $V + A = 1;27\ 30$  (šar). Find  $u$ ,  $s$  and  $d$ .

Proceeding as in BM 85200 + VAT 6599 # 5, one can solve this problem in the following way:

Let  $d = n$  cubits. Then  $u = n \cdot ;05$  ninda, and  $s = (n - 1) \cdot ;05$  ninda. Consequently, “ $A + V$ ” =  $n \cdot ;05 \times (n - 1) \cdot ;05 \cdot (n + 1)$  volume šar =  $(n - 1) \cdot n \cdot (n + 1) \cdot ;00\ 25$  volume šar. Hence,  $n$  must be a solution to the cubic equation  $(n - 1) \cdot n \cdot (n + 1) \cdot ;00\ 25 = 1;27\ 30$ . After multiplication by 2 24, the reciprocal of ;00 25, the equation is reduced to  $(n - 1) \cdot n \cdot (n + 1) = 3\ 30$ . This equation has the solution  $n = 6$ . Hence,  $u = 6$  cubits = ;30 ninda,  $s = 5$  cubits = ;25 ninda, and  $d = 6$  cubits.

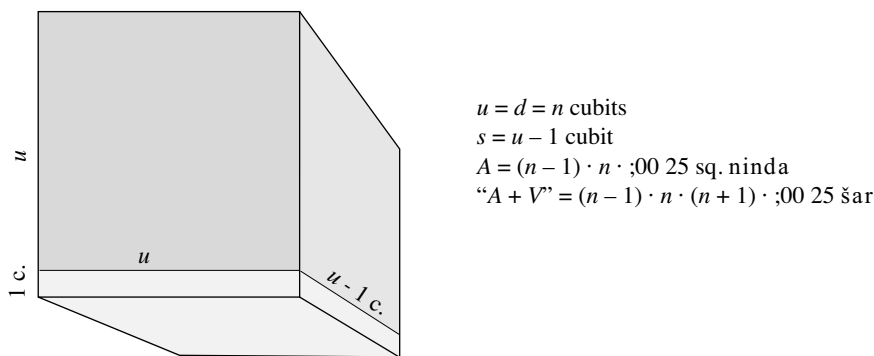

Fig. 2.4.3. Explanation of  $(n - 1) \cdot n \cdot (n + 1)$  as the “area plus volume” of an excavated room.

This explanation of the reason for the existence of an Old Babylonian table of  $n \cdot (n + 1) \cdot (n + 2)$  sides is not supported by the existence of any known Old Babylonian problem texts in which cubic equations are solved by use of such a table. Therefore, the explanation may or may not be correct, and it is comforting to know that an alternative explanation exists for the existence of an Old Babylonian table of  $n \cdot (n + 1) \cdot (n + 2)$  sides (quasi-cube sides). Recall that the errors in lines 26-28 of the table on MS 3048 suggest that the author of the table may have had recourse to a table of  $n \cdot (n + 1)$  sides (quasi-square sides). Now, it is well known among the mathematically educated in our own time that the sum of the first  $n$  integers is equal to  $n \cdot (n + 1)/2$  and that, similarly, the sum of the first  $n$  squares of integers is equal to  $n \cdot (n + 1) \cdot (n + 2)/6$ . The familiar arithmetical proof of the first of these propositions is very simple. The routine proof of the second proposition is somewhat more complicated, relying on the method of induction.

It is quite unlikely that general *arithmetical* identities of the kind mentioned above could be formulated and proved by Old Babylonian mathematicians, at least in the modern way. On the other hand, it is not unlikely that the same feat could be achieved by Old Babylonian mathematicians by means of *geometric* methods. Remember that Old Babylonian mathematicians apparently visualized and solved problems involving quadratic equations by use of geometric representations and “cut-and-glue” operations with geometric figures. The method has been called “naive geometry” by Høyrup (*LWS* (2002), Ch. IV) and “metric algebra” by Friberg (*BagM* 28 (1997), Ch. 1).

Consider, for instance, the sum of the first 10 integers. A suitable geometric representation of that sum is the total area of 10 rectangles, from 1 to 10 units long, but all 1 unit wide, together forming a “step triangle” with 10 steps. See the grey region in Fig. 2.4.4 below.

As shown by the figure, a rectangle of length (long side)  $n + 1$  and front (short side)  $n$  with, for instance,  $n = 10$ , can be divided into two such step triangles, one a slightly offset mirror image of the other. This is a simple geometric proof of the identity

$$1 + 2 + \dots + n = 1/2 \cdot n \cdot (n + 1), \text{ for all positive integers } n.$$

A word of caution: The Old Babylonian mathematicians had no way of indicating a “general” integer  $n$ . What they did instead, typically, was to choose some *arbitrary* integer and let it stand for *any* integer. Thus, an Old Babylonian mathematician would express an identity like the one above in something like the following way:

$$1 + 2 + \dots + 10 = 1/2 \cdot 10 \cdot (10 + 1),$$

with the silent understanding that the 10 could be replaced by any other (positive) integer.

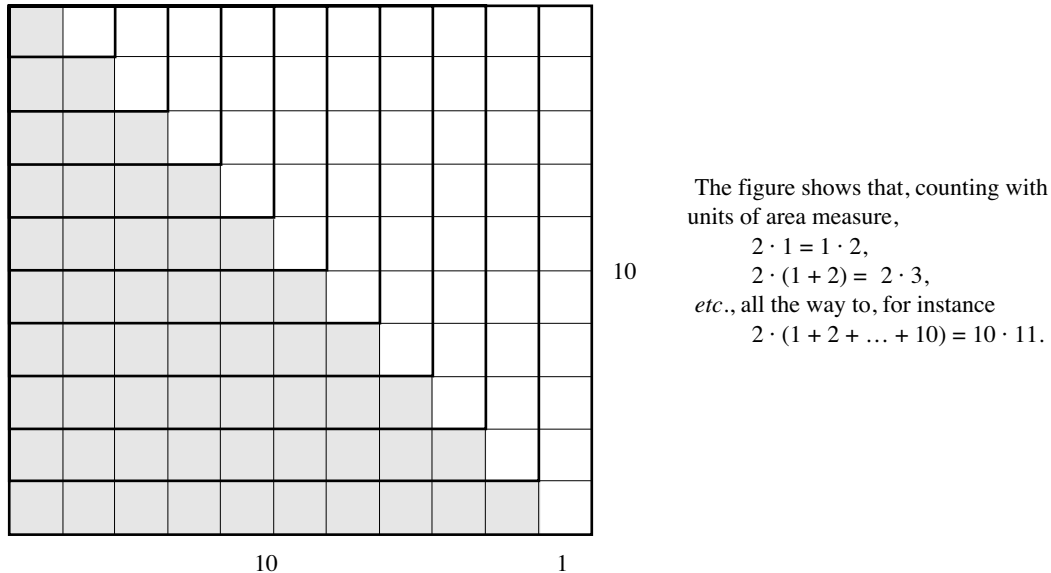

Fig. 2.4.4. Geometric interpretation of  $n \cdot (n + 1)$  as 2 times the sum  $1 + 2 + \dots + n$ .

See Friberg, *RIA* 7 (1990) Sec. 5.7 h, for a survey of summation rules for arithmetical or geometric progressions in Old and Late Babylonian mathematical texts. To that survey can now be added the Old Babylonian mathematical exercise BM 85 196 # 13. According to Robson, *MMTC* (1999), 80, the question in that exercise must be understood as follows: *How many days will a man spend carrying home one sheaf at a time if 6 sixties of sheaves are placed in a line before him, 5 ninda (30 meters) apart?* It is silently understood that the man’s daily work norm is walking with a load 45 00 ninda (16 kilometers). (See Sec. 7.3 a below.) Therefore, to bring home all the sheaves, the man has to walk

$$(1 + 2 + \dots + 600) \cdot 5 \text{ ninda} = 1/2 \cdot 600 \cdot 601 \cdot 5 \text{ ninda} = 1500 \cdot 601 \text{ ninda}.$$

To accomplish this, the number of days he has to spend carrying sheaves is

$$1500 \cdot 601/4500 = 601/3 = 200 \frac{1}{3} \quad (4 \text{ months of 30 days plus } 1/3 \text{ day}).$$

The construction in Fig. 2.4.4 above provides a geometric interpretation *in two dimensions* of numbers of the type  $n \cdot (n + 1)$ . The construction may have been known to Old Babylonian mathematicians. In a similar way, the construction in Fig. 2.4.5 below provides a geometric interpretation *in three dimensions* of numbers of the type  $n \cdot (n + 1) \cdot (n + 2)$ . This construction, too, may have been known to Old Babylonian mathematicians, even if there is no direct support for this conjecture.

In the two-dimensional case illustrated by Fig. 2.4.4, it is immediately clear that a *rectangle of sides  $n$  and  $n + 1$*  can be divided into *two equal step triangles with  $n$  steps*, and that this circumstance can be used for a geometric interpretation of the identity  $1 + 2 + \dots + n = 1/2 \cdot n \cdot (n + 1)$ . In the three-dimensional case illustrated by Fig. 2.4.5 below, the situation is more complicated, because the interior of a three-dimensional object is not visible. Anyway, the situation in three dimensions is not very different from the one in two dimensions. What is suggested by the construction in Fig. 2.4.4 is that a *rectangular block of front  $n$ , length  $n + 1$ , and depth  $n + 2$*  can be divided into *three equal step pyramids*, each

with  $n$  steps. This circumstance can be used for a geometric interpretation of the identity

$$1 \cdot 2 + 2 \cdot 3 + \dots + n \cdot (n + 1) = 1/3 \cdot n \cdot (n + 1) \cdot (n + 2).$$

Indeed, what this identity says is that the volume of each one of the three equal step pyramids is one third of the volume of the whole rectangular block.

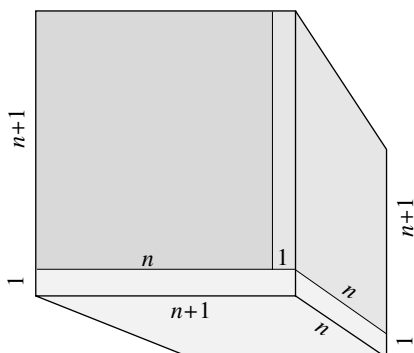

The figure can be used to show that  
 $3 \cdot (1 \cdot 2) = 1 \cdot 2 \cdot 3,$   
 $3 \cdot (1 \cdot 2 + 2 \cdot 3) = 2 \cdot 3 \cdot 4,$   
 $3 \cdot (1 \cdot 2 + 2 \cdot 3 + 3 \cdot 4) = 3 \cdot 4 \cdot 5,$   
*etc.*, all the way to, for instance,  
 $3 \cdot (1 \cdot 2 + \dots + 10 \cdot 11) = 10 \cdot 11 \cdot 12.$

Fig. 2.4.5. Geometric interpretation of  $n \cdot (n + 1) \cdot (n + 2)$  as 3 times the sum  $1 \cdot 2 + 2 \cdot 3 + \dots + n \cdot (n + 1)$ .

The idea that Old Babylonian mathematicians may have known that a rectangular block of front  $n$ , length  $n + 1$ , and depth  $n + 2$  can be divided into three step pyramids of equal volumes is supported by the fact that Old Babylonian mathematicians knew, in certain specific cases, that the volume of a pyramid is equal to one third of the product of its base area and its height. (See the discussion of the large Old Babylonian mathematical recombination text **BM 96954 + BM 102366 + SÉ 93** in Friberg, *PCHM* 6 (1996), Friberg, *UL* (2005), Fig. 4.8,4, and in Robson, *MMTC* (1999), Appendix 3.)

A related text is exercise # 1 in the Egyptian demotic mathematical papyrus **P.BM 10520** (Parker *DMP* (1972)), where the iterated sum of the integers from 1 to 10, called “1 filled up twice to 10”, is computed as  $55 \cdot 12/3$ , that is, as  $\{n \cdot (n + 1)/2\} \cdot (n + 2)/3$ . There is no indication of how the Egyptians had found this summation rule, or for what purpose it was used by them.

### 2.4 f. A Note on Excerpts from Old Babylonian Arithmetical Table Texts

The maximal extent of an Old Babylonian table of squares, square sides, or cube sides seems to have been 60 lines (from 1 to 1(00)). (Compare with the surveys in *MKT 1*, 70-71 and 73.) Since  $n$  goes from [1] to [1 00] in the table of  $n \cdot n \cdot (n + 1)$  sides in VAT 8492, that table, too, must have been a table of maximal extent. On the other hand, the small table of  $n \cdot n \cdot (n + 1)$  sides on the hand tablet MS 3899, with only 12 lines (Fig. 2.4.1, top), is a brief excerpt from a table of maximal extent. This fact, in itself, is interesting, because it suggests that the table of  $n \cdot n \cdot (n + 1)$  sides, although apparently not as common as ordinary tables of cube sides, must have been one of the mathematical “standard texts” which school boys in the Old Babylonian edubba had to study and make excerpts from.

Similarly, the table of  $n \cdot (n + 1) \cdot (n + 2)$  sides MS 3048 with its 30 lines (Fig. 2.4.1, bottom), apparently is one half of a table of maximal extent. Hence, this kind of table, too, seems to have been common enough to have been an Old Babylonian mathematical standard text, even if not as common as the ordinary table of cube sides.

Here follows a survey of all tables of squares, square sides, cube sides, and quasi-cube sides in the Schøyen Collection, showing how large a part each one is of a table of maximal extent:

|         |                    |            |                        |                   |
|---------|--------------------|------------|------------------------|-------------------|
| MS 2794 | t. of squares      | Fig. 2.1.1 | lines 1-20, 30, 40, 50 | complete abridged |
| MS 2706 | "                  | "          | lines 1-14             | 1st of 4 parts    |
| MS 3963 | t. of square sides | Fig. 2.2.1 | lines 21-40            | 2nd of 3 parts    |

|           |                        |            |                        |                   |
|-----------|------------------------|------------|------------------------|-------------------|
| MS 2185   | "                      | "          | lines 21-40            | 2nd of 3 parts    |
| MS 3864   | "                      | "          | lines 40-50            | 4th of 6 parts    |
| MS 3913   | t. of cube sides       | Fig. 2.3.1 | lines 1-20, 30, 40, 50 | complete abridged |
| MS 3863   | "                      | "          | lines 41-60            | 3rd of 3 parts    |
| MS 3973/1 | "                      | Fig. 2.3.2 | lines 31-60            | 2nd of 2 parts    |
| MS 3966   | "                      | "          | lines 13-17            | ?                 |
| MS 2996   | "                      | "          | lines 46-60            | 4th of 4 parts    |
| MS 2987   | "                      | "          | lines 21-40            | 2nd of 3 parts    |
| MS 3931   | "                      | "          | lines 21-40            | 2nd of 3 parts    |
| MS 3912   | "                      | "          | lines 50-60            | 5th of 6 parts    |
| MS 3899   | t. of quasi-cube sides | Fig. 2.4.1 | lines 1-12             | 1st of 5 parts    |
| MS 3048   | "                      | "          | lines 1-30             | 1st of 2 parts    |

The common pattern is obvious. With the exception of the very small clay tablet MS 3966, all the others are either complete abridged tables or one of 2, 3, 4, 5, or 6 equal (or almost equal) parts of a table of maximal extent. What this means is probably that excerpts from arithmetical table texts were not meant to be tools to assist in computations, but were instead *different writing exercises of equal size excerpted from complete tables, given out by the teacher to the individual members in classes of from 1 to 6 students!*

## 2.5. The Old Babylonian Standard Table of Reciprocals

It may be helpful to recall here the meaning of (modern) notations such as “regular sexagesimal number”, “reciprocal of a regular sexagesimal number”, *etc.* In modern discussions of Babylonian mathematics,  $n$  is called a regular sexagesimal number when *some* power of 60 can be divided by  $n$  exactly, without a remainder. However, in Babylonian *relative* place value notation *all* powers of 60 were written in the same way, as the single digit ‘1’. Therefore, a simpler definition is that

A regular sexagesimal number is a number  $n$  for which exact division of ‘1’ by  $n$  is possible.

A special Babylonian name for regular sexagesimal numbers is not known, and may never have existed. What we call a regular sexagesimal number was thought of by Old Babylonian mathematicians as a sexagesimal number  $n$  for which an ‘opposite number’  $\text{igi } n$  exists. This opposite number was required to be the *reciprocal of  $n$*  in the (generalized) sense that  $n \cdot \text{igi } n = '1'$ . In modern terms,

A given sexagesimal number  $n$  is called regular when it is possible to find another sexagesimal number  $\text{igi } n$  satisfying the requirement that  $n \cdot \text{igi } n = \text{some power of } 60$ .

Precisely because the sexagesimal base 60 itself is equal to  $2 \cdot 2 \cdot 3 \cdot 5$ , it follows that a sufficiently high power of 60 can be divided exactly by any given integer which is a product of an arbitrary number of factors 2, 3, and 5, but not by numbers containing other prime factors. Therefore,

A given sexagesimal number is regular when it is equal to (some positive or negative power of 60 times) *an integer containing no other prime factors than 2, 3, or 5.*

The well known *Old Babylonian* “standard table of reciprocals” enumerated all pairs of “1-place” regular sexagesimal numbers and their reciprocals, from  $\text{igi } 2 = 30$  to  $\text{igi } 54 = 1\ 06\ 40$ , and(!)  $\text{igi } 1 = 1$ . At the end of the table, there were two additional lines,  $\text{igi } 1\ 04 = 56\ 15$  and  $\text{igi } 1\ 21 = 44\ 26\ 40$ . Three further lines,  $\text{igi } 1\ 12 = 50$ ,  $\text{igi } 1\ 15 = 48$ , and  $\text{igi } 1\ 20 = 45$ , were actually redundant and were often omitted, probably because of the redundancy. The reason why the “2-place” regular numbers 1 04 and 1 21 were added to the list of regular 1-place numbers in the standard table of reciprocals is probably that  $1\ 04 (= 64) = 2^5$  and  $1\ 21 (= 81) = 3^4$ . Thus, both numbers are high powers of 2 and 3, respectively, yet close to ‘1’. Note, that, for instance

$$1\ 21 = 3^4, \text{ hence } \text{igi } 1\ 21 = 60^4/3^4 = 20^4 = 44\ 26\ 40.$$

(The atypical OB table of reciprocals BM 106444 (Robson, *AfO* 50 (2003/04)) ends with  $\text{igi } 2\ 05 (5^3) = 28\ 48!$ )

Old Babylonian standard tables of reciprocals of the most common type, “type a”, normally begin with *an extra line for the reciprocal of 2/3*, often in the following form

$$1.\text{da } 3''.\text{bi } 40.\text{àm} \quad 1, \text{ its } 2/3, 40 \text{ it is}$$

(For explicit examples, see the surveys of the beginnings of 28 tables of reciprocals in *MKT 1*, 10-12, and of 13 tables of reciprocals in *MCT*, 12.) The proposed translation of this initial phrase is only tentative. The exact meaning of the phrase is difficult to establish, because .da and .bi can both be grammatical suffixes, but they can also both be phonetic complements. In the latter case, /da/ may be the last syllable of the Sumerian word gešda = ‘sixty’, and /bi/ may be the last syllable of the Sumerian word šanabi ‘two-thirds’, written with the sign 3". The form of this sign is shown in Fig. 0.3 in Sec. 0.4.6.

The second line of Old Babylonian standard tables of reciprocals of type a is normally of the form

š.u.ri.a.bi (or š.u.ri.bi) 30.àm                      its half, 30 it is

All the other lines of an Old Babylonian standard table of reciprocals of type a are of the form

igi.n.gál.bi n'                      the opposite of n exists of it (and is) n'

A standard table of reciprocals (of type a) looks like this (28 or 31 entries):

|             |        |       |                  |                 |
|-------------|--------|-------|------------------|-----------------|
| 1.da        | 3".bi  | 40.àm | igi. 27.         | gál.bi 2 13 20  |
| š.u.ri.a.bi | 30.àm  |       | igi. 30.         | gál.bi 2        |
| igi. 3.     | gál.bi | 20    | igi. 32.         | gál.bi 1 52 30  |
| igi. 4.     | gál.bi | 15    | igi. 36.         | gál.bi 1 40     |
| igi. 5.     | gál.bi | 12    | igi. 40.         | gál.bi 1 30     |
| igi. 6.     | gál.bi | 10    | igi. 45.         | gál.bi 1 20     |
| igi. 8.     | gál.bi | 7 30  | igi. 48.         | gál.bi 1 15     |
| igi. 9.     | gál.bi | 6 40  | igi. 50.         | gál.bi 1 12     |
| igi.10.     | gál.bi | 6     | igi. 54.         | gál.bi 1 06 40  |
| igi.12.     | gál.bi | 5     | igi. 1.          | gál.bi 1        |
| igi.15.     | gál.bi | 4     | igi.1 04.        | gál.bi 56 15    |
| igi.16.     | gál.bi | 3 45  | (igi.1 12.gál.bi | 50)             |
| igi.18.     | gál.bi | 3 20  | (igi.1 15.gál.bi | 48)             |
| igi.20.     | gál.bi | 3     | (igi.1 20.gál.bi | 45)             |
| igi.24.     | gál.bi | 2 30  | igi.1 21.        | gál.bi 44 26 40 |
| igi.25.     | gál.bi | 2 24  |                  |                 |

The problematic formulation igi.n.gál.bi n' can be compared with the simpler phrases used in Old Babylonian mathematical assignments to compute the reciprocals of given numbers. Examples:

|             |                         |         |            |
|-------------|-------------------------|---------|------------|
| n igi.bi n' | n, its opposite (is) n' | MS 3264 | Fig. 1.4.5 |
| n igi n'    | n, opposite n'          | MS 2894 | Fig. 1.4.3 |
| n n'        | n, n'                   | MS 2793 | Fig. 1.4.3 |

The Old Babylonian standard table of reciprocals can also be compared with three tables of reciprocals, **HS 201**, **Ist. T 7375**, and **Ist. Ni 374**, all assumed to be from the Neo-Sumerian Ur III period, which immediately preceded the Old Babylonian period. (Oelsner, *ChV* (2001); Appendix 1 below, Fig. A1.2; Proust, *TMN* (2004), vol. 2, pl. 1; Friberg, *CDLJ* 2005:2, Fig. 6). The common layout of the three Ur III tables differs in several ways from the layout of the Old Babylonian standard table of reciprocals of type a. Thus, the initial entry on Ist. T 7375 is lost, but the initial entry on HS 201 is

1.da igi.2.gál.bi 30                      1 (· 60), the opposite of 2 exists of it (and is) 30

This entry corresponds to line 2 in the Old Babylonian standard table of reciprocals. There is no entry corresponding to line 1 in the standard table (the one for the reciprocal of 2/3). All the other entries in HS 201, Ist. T. 7375, and Ist. Ni 374 are of one or the other of the following two forms

|          |                  |   |
|----------|------------------|---|
| n igi n' | n, opposite n'   | (when n is a regular sexagesimal number)      |
| n igi nu | n, opposite none | (when n is a non-regular sexagesimal number!) |

It is also remarkable that the table on HS 201 proceeds from n = 2 to n = 32, the table on Ist. T 7375 from n = [2] to n = 1 (00), and the table on Ist. Ni 374 from n = [2] to n = 1 40! A further striking dissimilarity is that while Old Babylonian tables of reciprocals normally are written on single column tablets, the Ur III tables are written in two columns on each side of the clay tablet. This is probably because the Ur III tables contain many



more entries than the Old Babylonian standard table.

**MS 3874** (Fig. 2.5.1) is a standard table of reciprocals of type a. It ends with a subscript in 2 lines. The first line of the subscript states that this is an *im.gíd.da* written by the student *ši-ip-suen*. The term *im.gíd.da* ‘long clay’, or rather ‘long tablet’, is often seen in subscripts of this type and seems to allude to the fact that table texts often are written on clay tablets of a longish format. The second line of the subscript begins with the sign *u<sub>4</sub>* ‘day’. Although the remaining part of this line is damaged, it is clear that what was written here was a date of the standard type ‘day *n* of month so and so’.

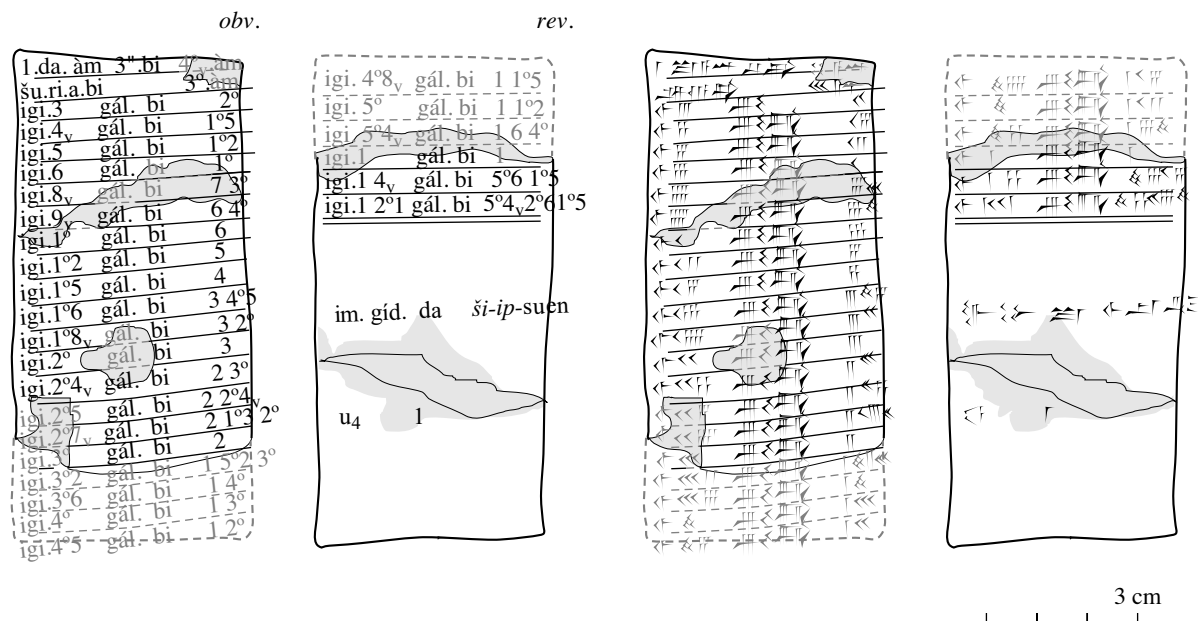

MS 3874. A standard table of reciprocals of type a (28 lines), with a colophon (scribe's name and date). Variant number signs for 4, 7, 8, 9, and 40, and the early OB form of the sign for .bi.

Fig. 2.5.1. An example of the Old Babylonian standard table of reciprocals, probably early Old Babylonian.

MS 3874 is particularly interesting because the text makes use of variant number signs for 6, 7, and 8, and even for 4 and 40. Also some of the non-numerical signs in the text, in particular the sign for the suffix *.bi* has an “archaic” form. All this suggests that MS 3874 is an “early” Old Babylonian table text from some southern city in Mesopotamia. (Cf. Friberg, *RA* 94 (2000) § 7c.)

**MS 3869/5** and **MS 3890** (Fig. 2.5.2) are two other Old Babylonian standard tables of reciprocals of type a. They both use standard Old Babylonian forms for the number signs and for non-numerical signs, such as *.bi*. They are therefore probably younger than MS 3874 and not from any of the southern Mesopotamian cities.

MS 3869/5 has lost its lower part. The last preserved line on this tablet is *igi.36.gál 1 40*. Presumably the whole standard table of reciprocals was inscribed on either just the obverse, or on the obverse and the uppermost part of the reverse. Anyway, what remains of the reverse is empty.

MS 3890 contains the full standard table of reciprocals, except for the three optional pairs between *igi.1 04.gál 56 15* and *igi.1 21.gál 44 26 40*. The first line of the text is

*1.da.àm 40.bi 40.*

Compare with MS 3874 and MS 3869/5, where the corresponding first lines of text are

*1.da.àm 3''.bi 40.[àm]*      and      *1.da 3''.bi 40*

A dissatisfied and irate teacher(?) has mutilated both obverse and reverse with several long scratches. The student’s error, whatever it was, may have disappeared behind the scratches.

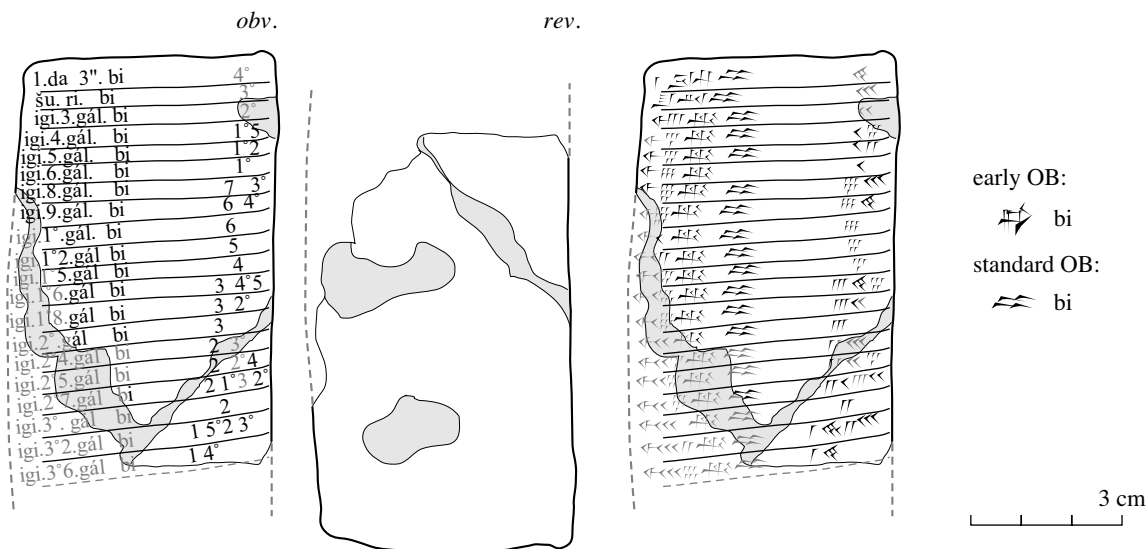

MS 3869/5. A standard table of reciprocals of type a. The lower edge of the clay tablet is lost.

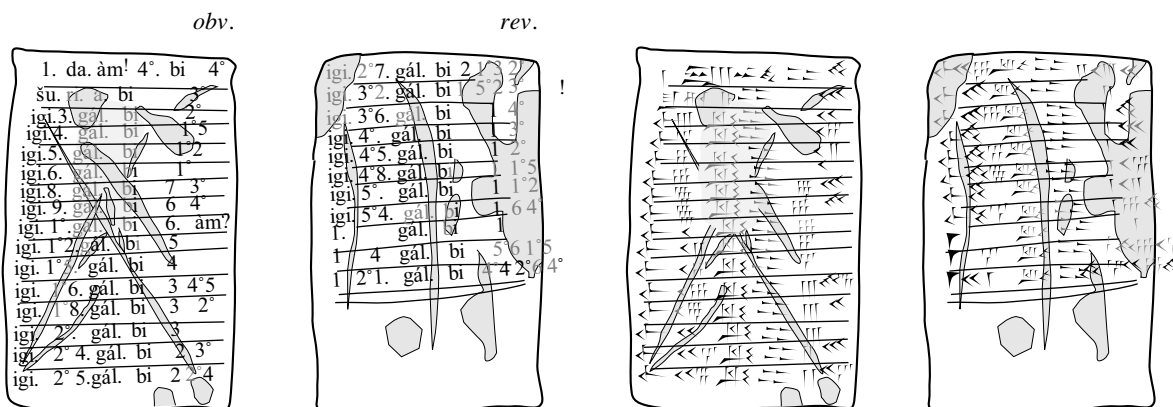

MS 3890. A standard table of reciprocals of type a (27 lines), mutilated in antiquity by an irate teacher.

Fig. 2.5.2. Two examples of the Old Babylonian standard table of reciprocals of type a.

Possibly, the teacher had noticed that the student had forgotten the sign *igi* at the beginning of the last three lines of the table, and also the whole line *igi.30.gál.bi 2*, all on the reverse.

In addition to the three examples mentioned above, all of type a, there is also a fourth example of an Old Babylonian standard table of reciprocals in the Schøyen Collection. That fourth example, is **MS 2877**, *obv.* (Fig. 2.6.7, bottom), a table of reciprocals of an atypical, purely numerical format, which may be called “type b\*” because of its similarity with the purely numerical format called type b\* in the case of single multiplication tables. (The text on the reverse of MS 2877 is a multiplication table for the “head number” 50.) Two pairs of reciprocals are missing in this table, probably by mistake, the pairs 27 — 2 13 20 and 50 — 1 12. In addition, the initial lines with the sexagesimal representations of the fractions 2/3 and 1/2 are absent from this table of reciprocals.

## 2.6. Old Babylonian Multiplication Tables

### 2.6 a. Single Multiplication Tables

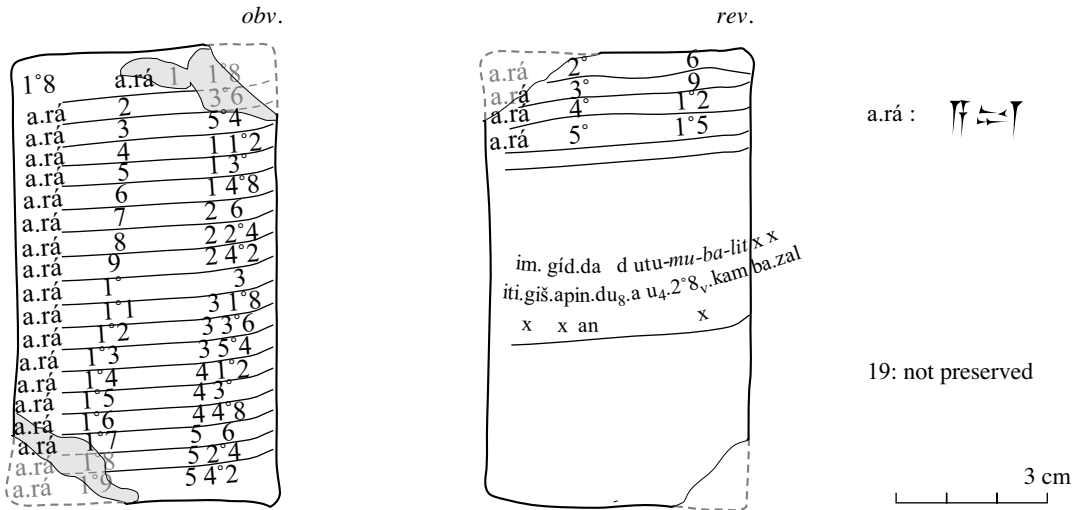

MS 2708. A single multiplication table (18 ×) of type a, the most common type (23 lines).  
Colophon: "Long tablet inscribed by Shamash-Muballit, day 28, month 8, is completed."

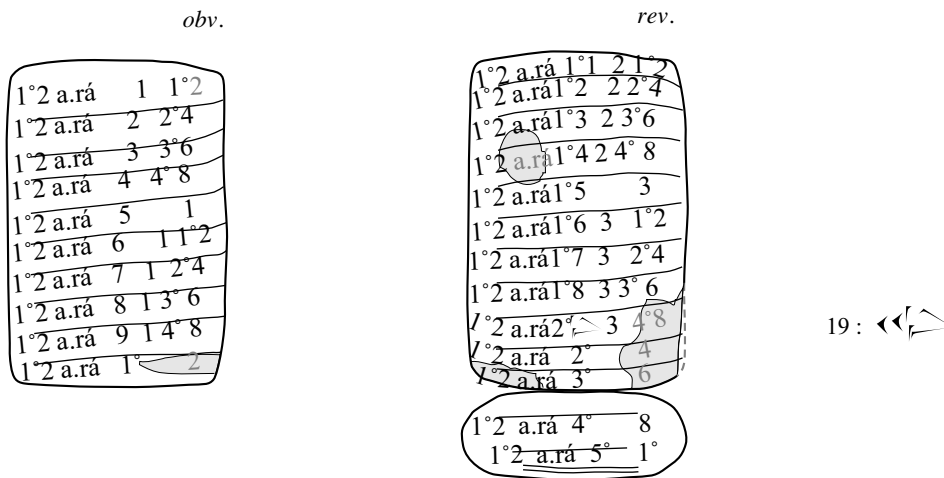

MS 2184/3. A single multiplication table (12 ×) of type a'.

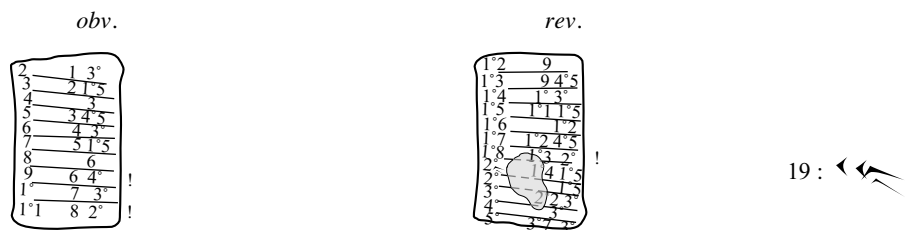

MS 3044/3. A single multiplication table (45 ×) of the purely numerical type b\* (new).  
Errors in line 9: 6 40 for 6 45, line 11: 8 20 for 8 15, and line 18: 13 20 for 13 30.

Fig. 2.6.1. Three examples, of three different types of Old Babylonian single multiplication tables.

An Old Babylonian “single multiplication table” is a clay tablet with a single table where a given number, the “head number”  $p$ , is multiplied first by the integers from 1 to 19, then by 20, 30, 40, and 50. This is the same arrangement as in, for instance, the complete abridged table of squares MS 2794 (Fig. 2.1.1), or the complete abridged table of cube sides MS 3913 (Fig. 2.3.1). Single multiplication tables constitute the most common category of mathematical cuneiform texts. Previously published single multiplication tables include, in particular, 85 texts in *MKT* (1935-37) (see *MKT* 1, 32-34, 36-43; *MKT* 2, 36-37, and *MKT* 3, 50), and 77 texts in *MCT* (1945), 19-24.

There are as many as 148 recognizable single multiplication tables in the Schøyen Collection. Ten representative examples are presented with full details in the present paragraph. The primary aim of the presentation is to illustrate different types of single multiplication tables that can be found among the tablets in the Schøyen Collection. Those types are:

|           |             |                             |                   |                                     |
|-----------|-------------|-----------------------------|-------------------|-------------------------------------|
| type a:   | first line: | $p \text{ a.rá } 1 \quad p$ | subsequent lines: | $\text{a.rá } n \quad p \cdot n$    |
| type a':  |             | $p \text{ a.rá } 1 \quad p$ |                   | $p \text{ a.rá } n \quad p \cdot n$ |
| type a'': |             | $p \text{ a.šà } 1 \quad p$ |                   | $p \text{ a.šà } n \quad p \cdot n$ |
| type b:   |             | $1 \quad p$                 |                   | $n \quad p \cdot n$                 |
| type b*:  |             | —                           |                   | $n \quad p \cdot n$                 |
| type c:   |             | $1 \text{ a.rá } p$         |                   | $n \text{ a.rá } p \cdot n$         |

These definitions and designations differ to some extent from the ones proposed in *MCT*, 20. However, types a and a' above are the same as types A and A' in *MCT*. Type a is, by far, the most common of all the types. Type b\* is purely numerical, with an omitted first line. It is represented by two examples in the Schøyen Collection but does not appear among the texts in *MKT* and *MCT*, where instead types B, B', B'', and C have various first lines, while all subsequent lines are of the same form as all the lines in tables of type b\*. Type b is identical with type C in *MCT*.

Type a'' is a new type, represented by two texts in the Schøyen Collection. In tables of type a'', the standard term a.rá, a Sumerian word actually meaning ‘step’, ‘going’, *etc.*, is replaced by the term a.šà, a Sumerian word with the meaning ‘field’, ‘area’. It is not clear if this is a *bona fide* new type, or a mistake (provided that the two tables of type a'' were written by the same hapless student). Type c, too, may be not a new type, but a mistake. It appears only on a single tablet with a beginner’s unfinished multiplication table.

From a mathematical point of view, the meaning of the phrase  $p \text{ a.rá } n \quad p \cdot n$  is clear. It is obviously ‘ $p$  times  $n$  (equals)  $p \cdot n$ ’. From a linguistic point of view, the situation is less clear. What does ‘ $p$  step  $n \quad p \cdot n$ ’ really mean? It is possible that the phrase originally meant something like ‘ $n$  steps, each of length  $p$ , equals  $p \cdot n$ ’.

**MS 2708** (Fig. 2.6.1, top) is a single multiplication table of type a with the head number 18. Of the 23 lines of the table, the first 19 are written on the obverse of the tablet, the remaining 4 on the reverse. That leaves plenty of room for a subscript in 3 lines:

im.gíd.da <sup>d</sup>utu-mu-ba-liṭ x / iti.<sup>giš</sup>apin.du<sub>8</sub>.a u<sub>4</sub>.28.kam ba.zal / x x x x  
‘Long tablet inscribed by Shamash-Muballit, the month of plowing (month 8), day 28 is completed. x x x x’

The month name iti.<sup>giš</sup>apin.du<sub>8</sub>.a (Akk. *Arahsamnu*) is the Sumerian name for the eighth month of the Babylonian lunar year.

**MS 2184/3** (Fig. 2.6.1, middle) is written on a smaller clay tablet than MS 2708. Consequently, the 23 lines of its multiplication table cover almost the entire surface of the tablet, with 10 lines on the obverse, 11 on the reverse, and the remaining 2 lines on the edge below the reverse. The multiplication table is of type a', with the head number 12. That the table is of type a' means that the number 12 is repeated at the beginning of each line of the table. Thus, the table begins with the lines

12 a.rá 1 12 / 12 a.rá 2 24 *etc.*, all the way to 12 a.rá 50 10

The number 19 is written in this text as 20 followed by a cuneiform sign that is hard to identify. This way of writing 19 seems to be more of a rule than an exception in single multiplication tables. Indeed, 10 examples of single multiplication tables are displayed in Figs. 2.6.1 and 2.6.3-5 in this paragraph. In all cases where the number 19 is well enough preserved so that its form can be determined, it is written as 20 followed by a cuneiform sign that is hard to identify. The unidentifiable sign is *different* in all those cases!

The result of a partial survey of the occurrence of this phenomenon in single multiplication texts from the Schøyen Collection is exhibited in Fig. 2.6.2 below, a table of 12 different forms of the sign for 19. The table shows that 19 written as 20 followed by a squiggle occurs in single multiplication tables of all types, and in conjunction with both standard and early Old Babylonian forms of the number signs for 7, 8, *etc.*













|           |            |          |   |  |
|-----------|------------|----------|---|--|
| MS 2184/2 |            | type a'  |    |  |
| MS 2184/3 | Fig. 2.6.1 | type a'  |    |  |
| MS 2184/7 |            | type a   |    |  |
| MS 2286/2 |            | type a'  |    |  |
| MS 2804/1 |            | type a   |    | 20.lá 1 <sub>h</sub>   |
| MS 2875   | Fig. 2.6.3 | type a   |    |  |
| MS 2895   |            | early OB | type a'   |                         |
| MS 3044/3 | Fig. 2.6.1 | type b*  |  |  |
| MS 3849   | Fig. 2.6.3 | type a   |  |  |
| MS 3866   | Fig. 2.6.4 | type a   |  |  |
| MS 3909/3 | Fig. 2.6.5 | type b*  |  |  |
| MS 3967/1 | Fig. 2.6.4 | type a   |  |  |
| MS 3967/2 |            | early OB | type a  |  20.lá 1 <sub>h</sub> |

Fig. 2.6.2. Signs for '19' in selected OB multiplication tables from the Schøyen Collection.

The origin of this curious way of writing 19 is well known. In Sumerian and Old Akkadian texts from the third millennium BC, both administrative and mathematical, it was a common practice to write numbers in a “subtractive form”. If a given number or measure *a* was slightly less than a relatively large round number or measure *b*, then it could be written as the large number *minus* a small number. Two explanations for the practice suggest themselves. One is that the large and round number *b* was the *expected* outcome of a measurement, *a* the *actual* outcome, and writing *a* as *b* – *d* was a way of showing how far the actual outcome was from the expected one. The other explanation is that, in certain kinds of operations with the numbers, notably multiplications, it was easier to count with *b* – *d* than with *a*.

An example is offered by the Old Sumerian table of square areas *OIP 14*, 70 (Edzard, *AOAT 1* (1969); Fig. A1.4 in Appendix 1), where, for instance the square of (10 – 1) cubits is written in the form 2' šar 4 gín – igi.4. (A cubit is 1/12 of a ninda and a šar is a square ninda. Therefore the computation behind this entry can be



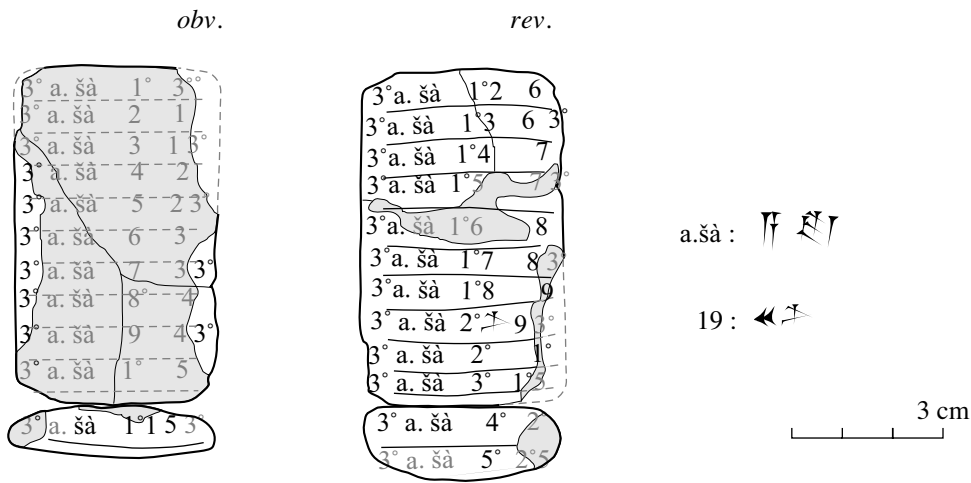

MS 2875. A multiplication table (30 ×) of type a" (new), with a.šà instead of a.rá. Variant number sign for 19.

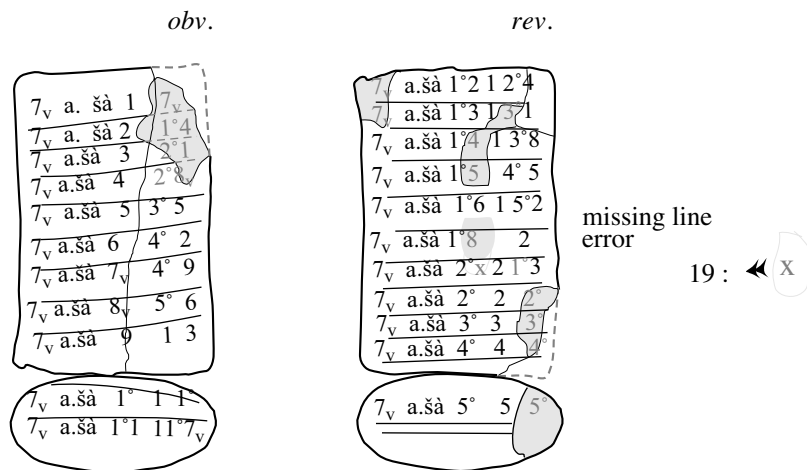

MS 2829. A multiplication table (7 ×) similar to MS 2875 above. Variant number signs for 7, 8, and 19. Missing line: 7 a.šà 17 1 59. Error in line 18: 2 instead of 2 06.

Fig. 2.6.3. Two curiously atypical Old Babylonian single multiplication tables.

Of the 77 single multiplication tables published in *MCT* and the 85 single multiplication tables published in *MKT* (together 162 tables), 21 (about 27%) end by giving the square of the head number. Of those 21, only 2 (2.5% of all the multiplication tables in *MCT* and *MKT*) give also the square side of the square of the head number. (Cf. *MKT* 1, 65.) The corresponding numbers for the Schøyen Collection are 152 single multiplication tables, of which 2 (1.3%) give the square of the head number and 1 (.65%) also the square side of that square.

**MS 3873/1** (Fig. 2.6.5, top) is a single multiplication table of type a, head number 24. The text ends with a subscript indicating *writer, month, and day*:

<im.>gíd.da<sup>d</sup>en.zu.[x] / iti.ab.è 24.kam

'long (tablet), PN, month 10, (day) 24th'.

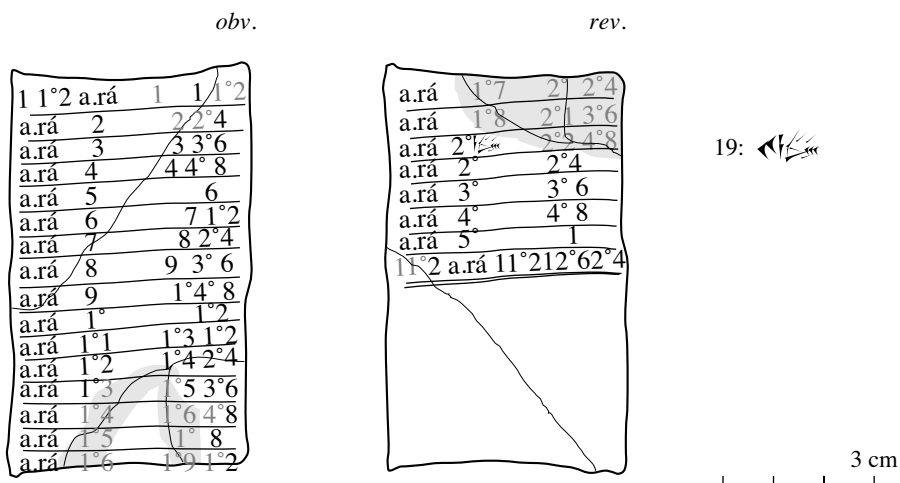

MS 3866. A single multiplication table (1 12 ×) of type a.  
The smallest known head number! Ends with the square of the head number.

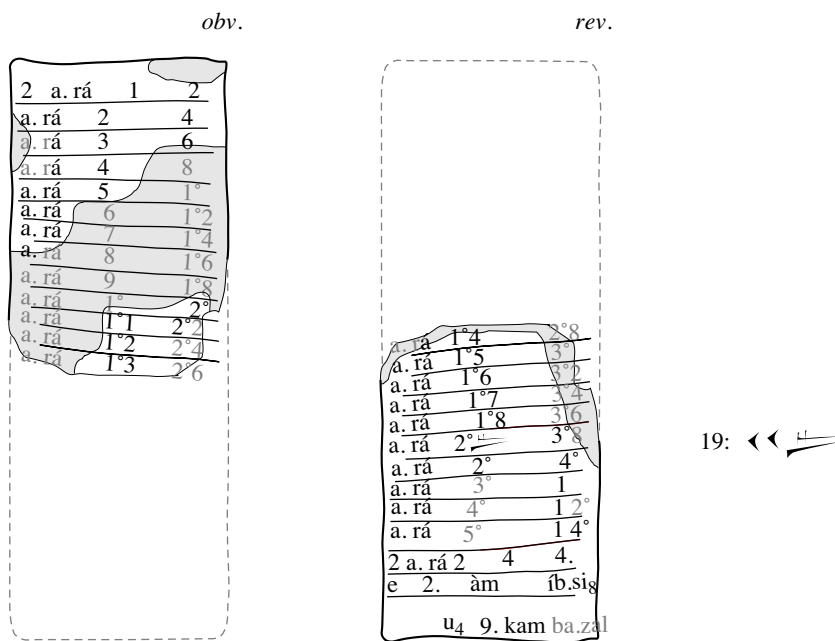

MS 3967/1. A single multiplication table (2 ×) of type a.  
Ends with the square of 2, and the square root of 4. Colophon: 'Day 9 is completed'

Fig. 2.6.4. Two Old Babylonian single multiplication tables ending with the square of the principal number.

MS 3909/3, finally (Fig. 2.6.5, bottom) is a single multiplication table of the unusual type b\*, head number 40. On the tablet, the multiplication table is followed by a subscript indicating *writer*, *month*, [*day*], and *year*:

|   |  |                                       |
|---|--|---------------------------------------|
| 1 | im.gíd.da <sup>d</sup> en.zu.[x] /                   | long tablet, PN                       |
| 2 | iti.še.kin.ku <sub>5</sub> u <sub>4</sub> .[x.kam] / | month 12, day <i>xth</i> ,            |
| 3 | mu sa-am-su-[i-lu-na x x]                            | the year (when) Samsuiluna <i>x x</i> |



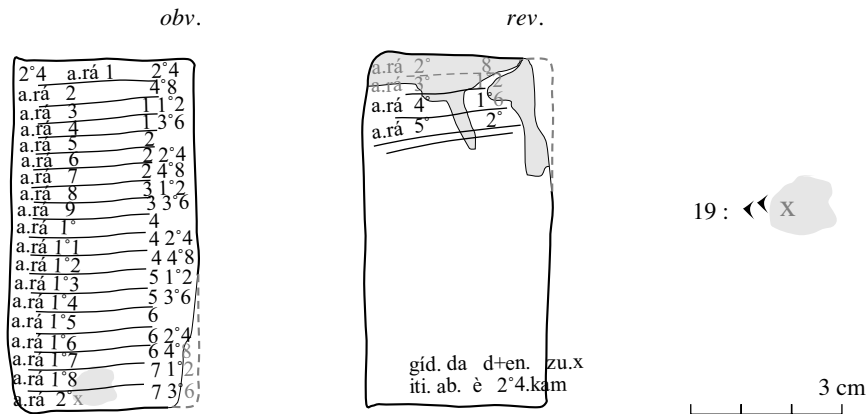

MS 3873/1. A single multiplication table (24 ×) of type a.  
Colophon indicating writer, month and day.

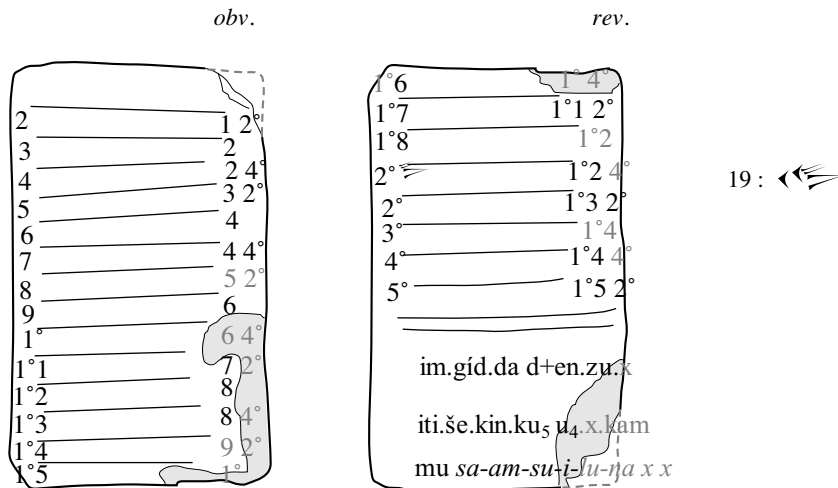

MS 3909/3. A single multiplication table (40 ×) of type b\*.  
Colophon indicating writer, month, [day], and year.

Fig. 2.6.5. Two Old Babylonian single multiplication tables with subscripts of standard type.

### 2.6 b. Double Multiplication Tables

(Cf. *MKT 1*, 44-59; *MCT*, 25-33.)

Nine examples of “double multiplication tables” are present in the Schøyen Collection. Copies of three of them, plus a double table of a related kind, will be shown below.

**MS 2719** (Fig. 2.6.6, top) is a first example of an Old Babylonian double multiplication table. It is inscribed with two single multiplication tables of type a, one with the head number 18 (on the obverse of the clay tablet), the other with the head number 16 40 (on the reverse of the tablet). Variant number signs for 4 are used on both obverse and reverse. A variant number sign for 19 is used on the reverse. The corresponding number on the obverse is not preserved.

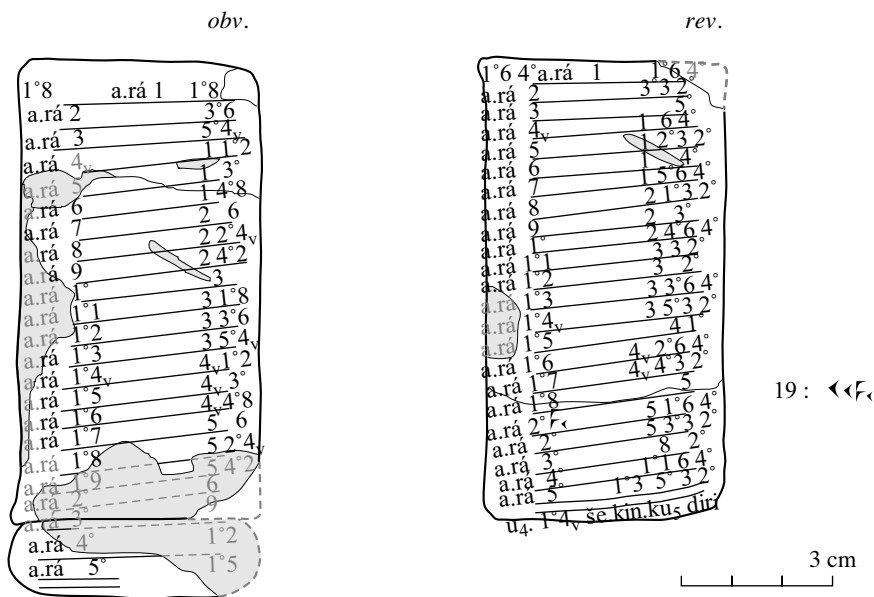

MS 2719. A double multiplication table (18 × and 16 40 ×) of type a. Variant number signs for 4 and 19. The table ends with a colophon: day 14th, month 12 II.

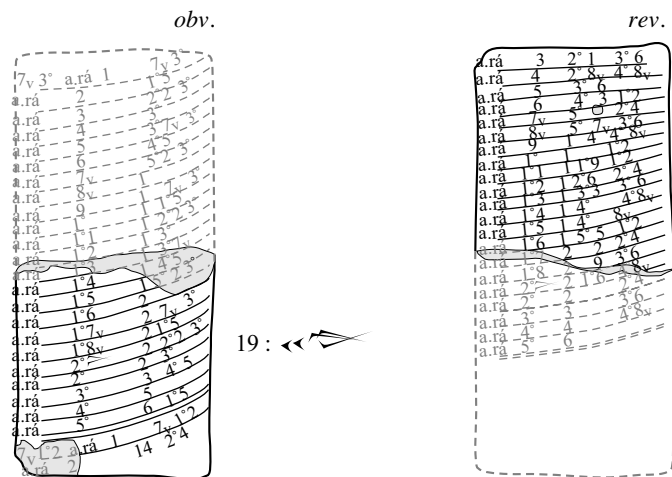

MS 3964. A double multiplication table (7 30 × and 7 12 ×) of type a. Variant number signs for 7, 8, and 19.

Fig. 2.6.6. Two double excerpts from an Old Babylonian combined multiplication table of type b\*.

The text on the reverse ends with a subscript, indicating *day and month*:

u<sub>4</sub> 14<sub>v</sub> še.kin.ku<sub>5</sub>.diri                      'day 14, <month> 12 II'

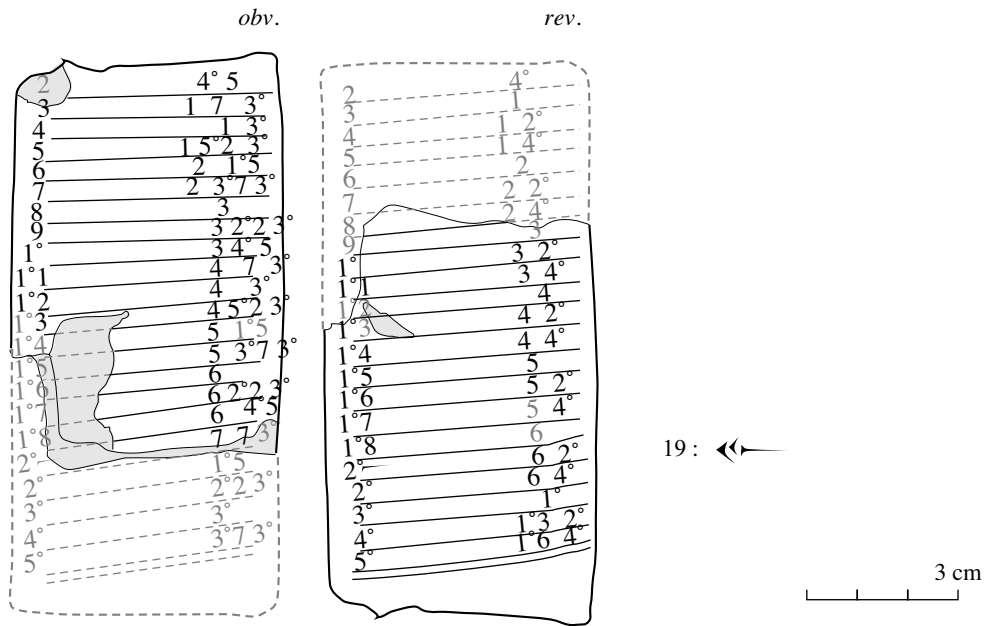

MS 2878. A double multiplication table: (22 30 × and 20 ×) of type b\*. Variant number sign for 19.

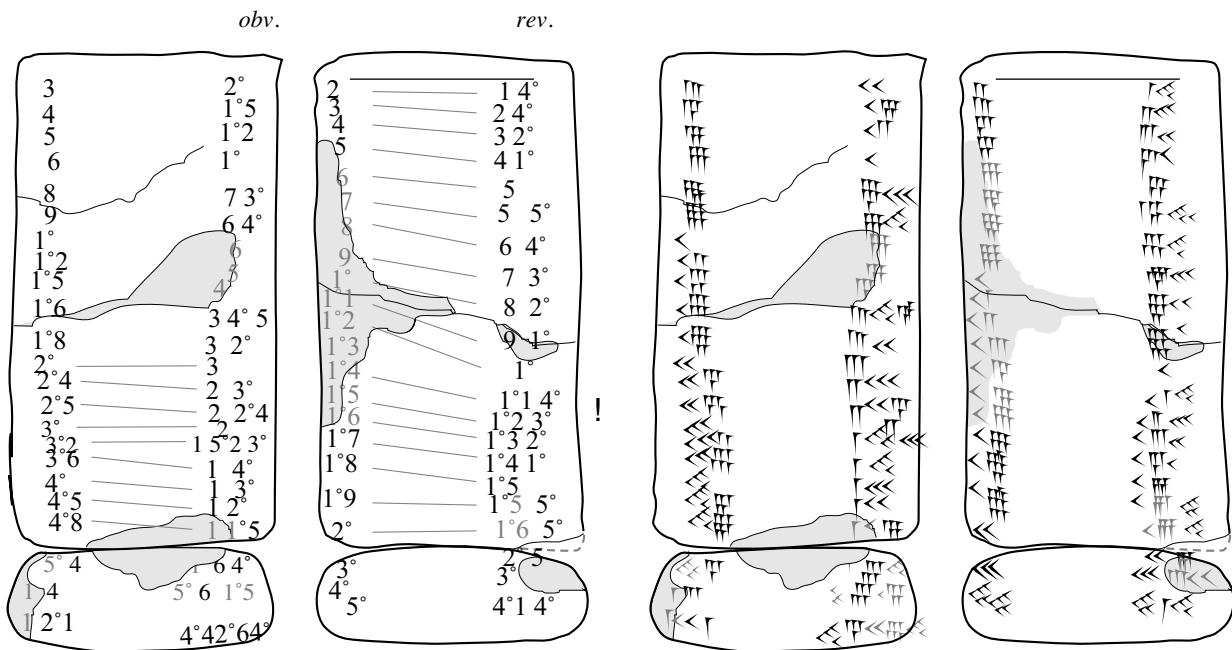

MS 2877. The first two sub-tables of a combined multiplication table: (reciprocals and 50 ×, both of type b\*). Standard number signs are used for all numbers, even 19.

Fig. 2.6.7. Two more double excerpts from an Old Babylonian combined multiplication table.

**MS 3964** (Fig. 2.6.6, bottom) is another example of an Old Babylonian double multiplication table of type a. A table on the obverse with the head number 7 30 is immediately followed by a table with the head number 7 12. The second table begins near the end of the obverse and continues onto the reverse. Variant number signs are used on both obverse and reverse for 7 and 8, but not for 4. A variant number sign for 19 is used on the obverse. The corresponding number on the reverse is not preserved.

**MS 2878** (Fig. 2.6.7, top) is an example of an Old Babylonian double multiplication table of the very unusual, purely numerical type b\*. A single multiplication table on the obverse has the head number 22 30, and a second table on the reverse has the head number 20. A variant number sign for 19 is used on the reverse. The corresponding number on the obverse is not preserved.

**MS 2877** (Fig. 2.6.7, bottom) is not, properly speaking, a double multiplication table, yet it is a text of a similar kind. It is inscribed on the obverse with a table of reciprocals of an atypical, purely numerical format, which may be called “type b\*” because of its similarity with the purely numerical format called type b\* in the case of single multiplication tables. Two pairs of reciprocals are missing in this table, probably by mistake, the pairs 27 — 2 13 20 and 50 — 1 12. In addition, the initial couple of lines are absent from this table of reciprocals, the ones displaying the sexagesimal representations of the fractions  $\frac{2}{3}$  and  $\frac{1}{2}$ .

On the reverse, MS 2877 is inscribed with a single multiplication table, head number 50. This multiplication table, too, is of the very unusual, purely numerical type b\*, just like the two single multiplication tables on MS 2878, and like the table of reciprocals on the obverse. Another unusual feature is that there are no variant number signs on MS 2877. Even the sign for 19 is written in the standard form, as a ten followed by a nine, not as twenty followed by a squiggle.

The layout on the reverse of MS 2877 is badly organized. (See the help lines inserted into the conform transliteration of the reverse in Fig. 2.6.7.) Numbers belonging together are not consistently facing each other, probably for the reason that the student who wrote the text copied first the entire left column of numbers from another text, then the right column, instead of copying from the other text line by line. The resulting confusion has made the writer forget to insert the number ‘10 50’ (13 times 50) in its proper place in the right column.

### 2.6 c. *Multiple Multiplication Tables*

(Cf. *MKT 1*, 35, 44-59; *MCT*, 24-33.)

Three examples of “multiple multiplication tables” are present in the Schøyen Collection. They are all shown below. A multiple multiplication table contains more than two but not a full range of single multiplication tables. (This is a somewhat arbitrary, but convenient distinction.)

**MS 3891** (Fig. 2.6.8 below) is a fairly well preserved example of a multiple multiplication table. It is inscribed with three single multiplication tables, in the following referred to as “sub-tables”, with the head numbers

7, 6 40, and 6.

The first sub-table is inscribed on the greater part of the obverse. The second sub-table was inscribed around the lower edge of the obverse (now lost) and on the upper two-thirds of the reverse. The last sub-table is almost completely preserved. It is inscribed close to and on the lower edge of the reverse, and on the left edge of the clay tablet.

MS 3891 resembles the double table MS 2877 in that all sub-tables are of type b\*, but whereas the standard sign is used for 19 in MS 2877, a variant number sign is used for 19 in MS 3891.

**MS 3939** is a fragment of a multiple multiplication table. The middle half of the tablet is preserved, although it is not in a very good shape. The writing is miniature. Yet it is possible to see that there were originally four sub-tables on MS 3939, single multiplication tables with the head numbers

8, 7 30, 7 12, and 7.

A suggested reconstruction of the text is shown in Fig. 2.6.8.

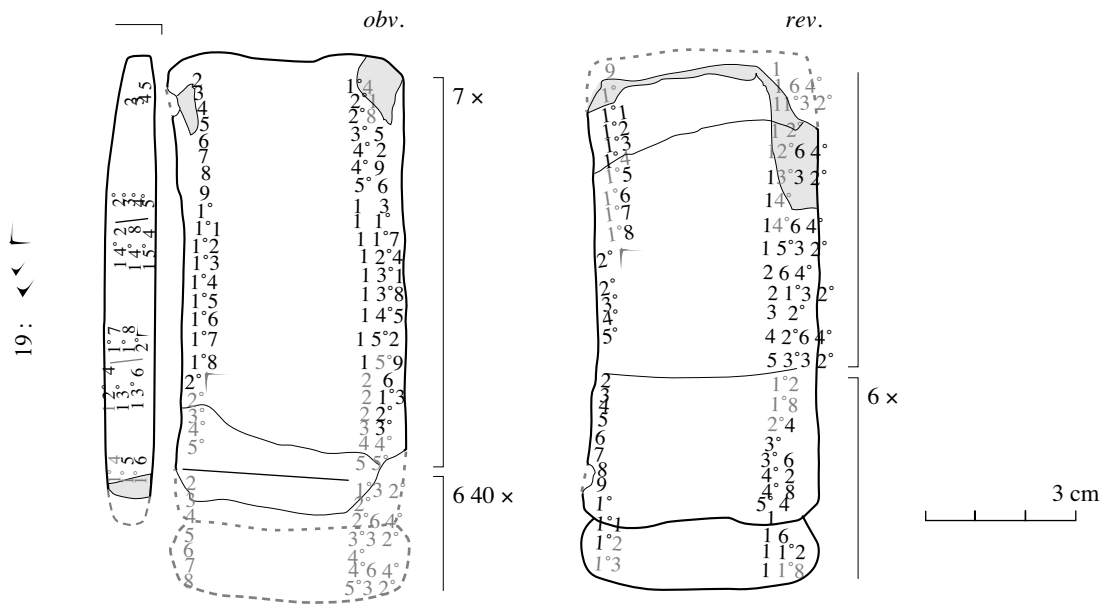

MS 3891. A multiple multiplication table (7, 6 40, 6 x) of type b\*. Variant number sign for 19.

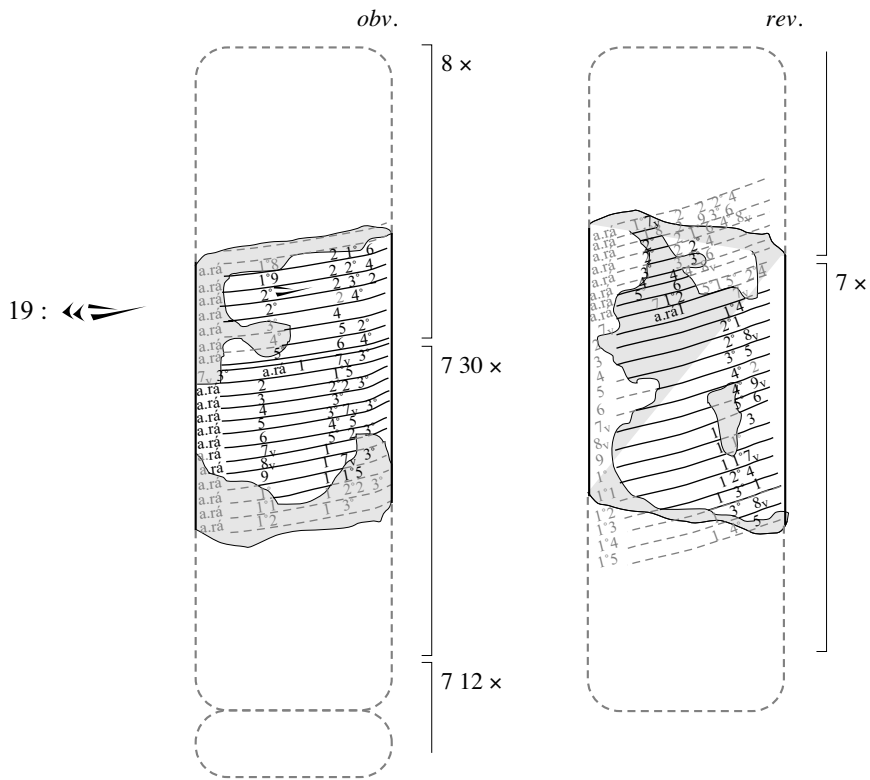

MS 3939. A multiple multiplication table (8, 7 30, 7 12, 7 x) of mixed types a and b. Variant number signs are used for 7, 8, and 19.

Fig. 2.6.8. Two examples of Old Babylonian multiple multiplication tables.

The first three sub-tables are of the common type a, but for some reason, probably because the writer got tired, the simpler type b is used for the fourth sub-table, which (apparently) begins with the standard line ‘7<sub>v</sub> a.rá 1 7<sub>v</sub>’ but then continues with purely numerical entries of the kind ‘n n · 7’

**MS 3870** (Fig. 2.6.9) is a fragment very much like MS 3939, but the writing on MS 3870 is even more miniature. According to the construction suggested in Fig. 2.6.9 below, there were originally five sub-tables on the clay tablet, single multiplication tables with the head numbers

[7], 6 40, 6 on the obverse, and 7 30, 7 12 on the reverse.

All the sub-tables are of type a. The text on the tablet is so badly preserved that it cannot be decided if variant number signs are used for 19.

Note that there is something wrong with the ordering of the sub-tables on MS 3870. The head numbers do not form a decreasing sequence, as would have been expected.

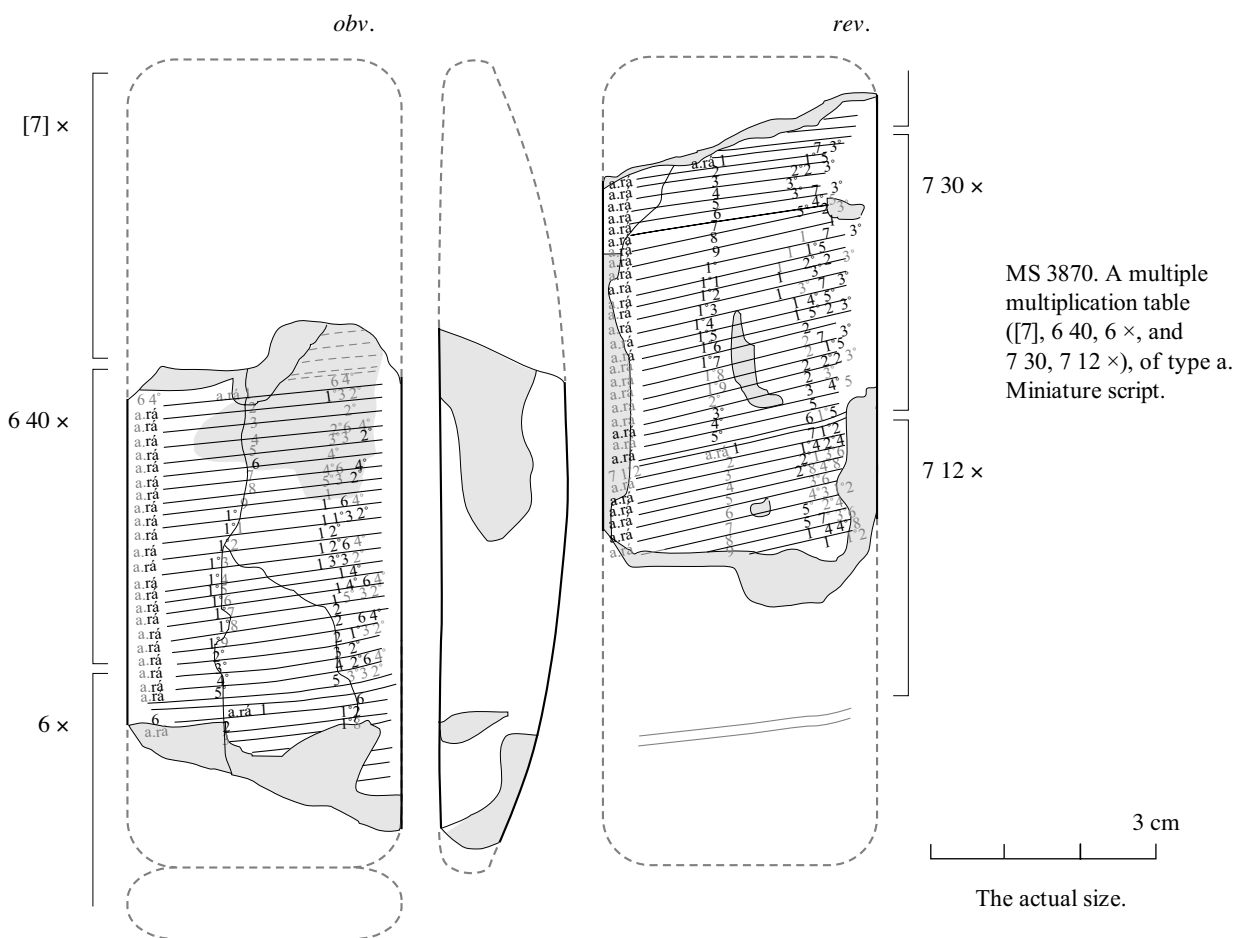

Fig. 2.6.9. MS 3870. A third example of an Old Babylonian multiple multiplication table.

### 2.6 d. The Old Babylonian Combined Multiplication Table

**MS 3845** (Fig. 2.6.10 below) is a substantial fragment, the lower half of a large clay tablet. According to the reconstruction presented in Fig. 2.6.11, it was inscribed, originally, with eleven sub-tables and a subscript. The first sub-table is a table of reciprocals, apparently of standard type, type a, with entries like, for instance, *igi.1 21.gál.bi 44 26 40*. The ten other sub-tables are single multiplication tables of type a, with entries like, for instance, *44 26 40 a.rá 1 44 26 40*, *a.rá 2 1 28 53 20*, etc. The head numbers represented in MS 3845 are

50, 45, 44 26 40, 40, 36, 30, 25, 24, 22 30, and 20.

The outline of the text in Fig. 2.6.11 shows that the correctness of the reconstruction is beyond doubt, since at least some part of each one of the eleven sub-tables is preserved.

A comparison with the combined multiplication table on the cylinder A 7897 (*MCT*, 25), and with the survey in *MKT* 1, 35, shows that in MS 3845 the head number 48 is missing. On the other hand, this head number is missing also in 18 of the 25 combined multiplication tables, which can be examined with respect to this issue, listed in *MKT* 1-2 and *MCT*. Moreover, there are no *single* multiplication tables with the head number 48 in *MKT* 1-2 and *MCT*.

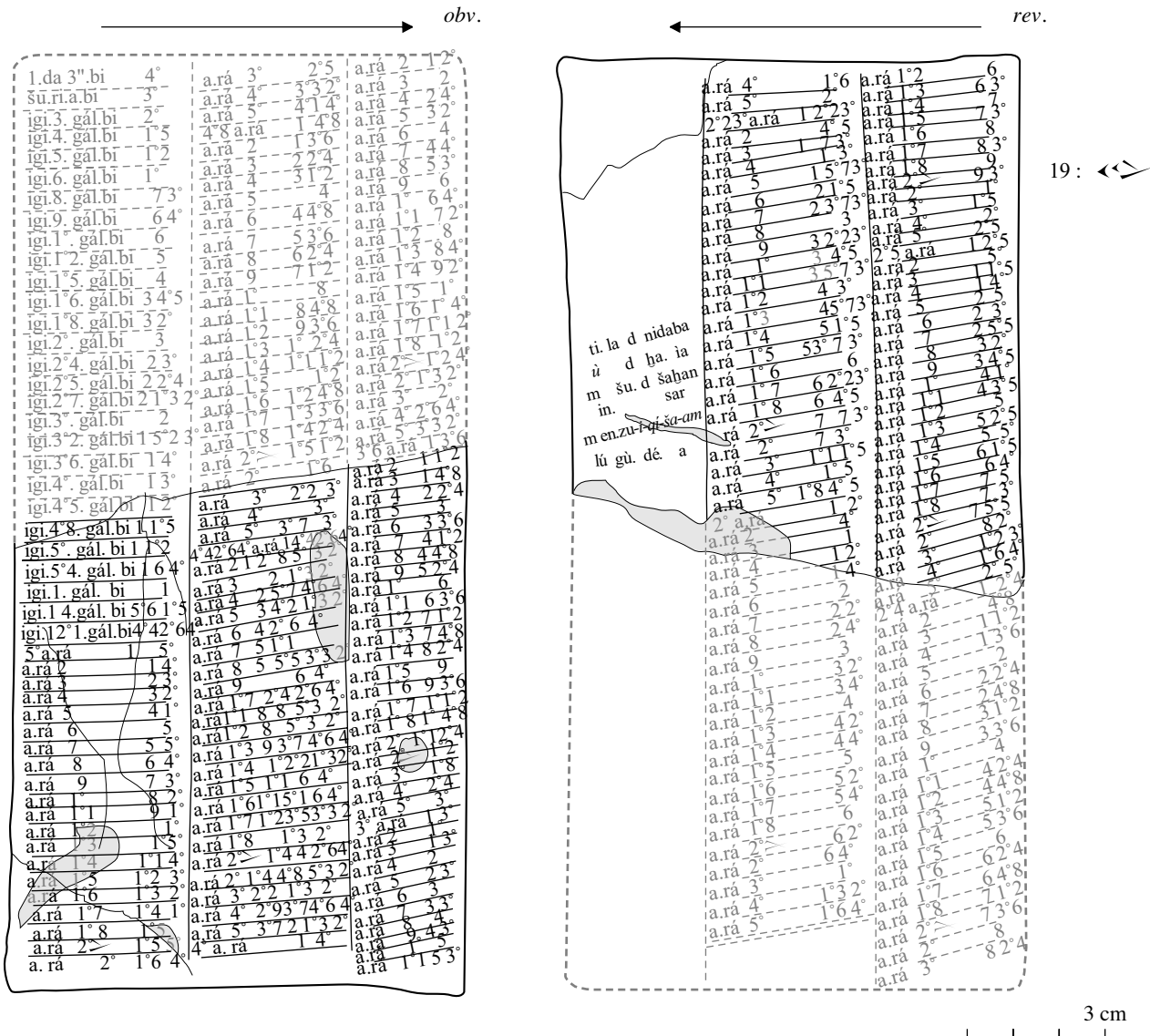

MS 3845. A large fragment of an Old Babylonian combined multiplication table of type a (11 sub-tables). The table ends with the multiplication table for 20, followed by a colophon. The arrows indicate that the columns on the obverse are to be read from left to right, but the columns on the reverse from right to left. This is a standard feature of cuneiform texts.

Fig. 2.6.10. MS 3845. The eleven first sub-tables of an Old Babylonian combined multiplication table.

In five of the sub-tables on MS 3845, the sign for 19 is preserved. In all these instances, the same form of a variant number sign for 19 is used. Standard number signs are used for the digits 4, 7, and 8.

The 11 sub-tables on MS 3845 are recorded in three columns on the obverse and two on the reverse. The sixth and last of the columns is empty except for a subscript in 6 lines:

|   |                                   |                       |
|---|-----------------------------------|-----------------------|
| 1 | ti.la <sup>d</sup> nisaba /       | By the life of Nisaba |
| 2 | ù <sup>d</sup> ha.ia /            | and Haia,             |
| 3 | mšù <sup>d</sup> .šahan /         | Shushahan             |
| 4 | in.sar /                          | wrote (it).           |
| 5 | m <sup>n</sup> en.zu-i-qí-ša-am / | Sueniqisham,          |
| 6 | lúgù.dé.a /                       | he of Gudea.          |

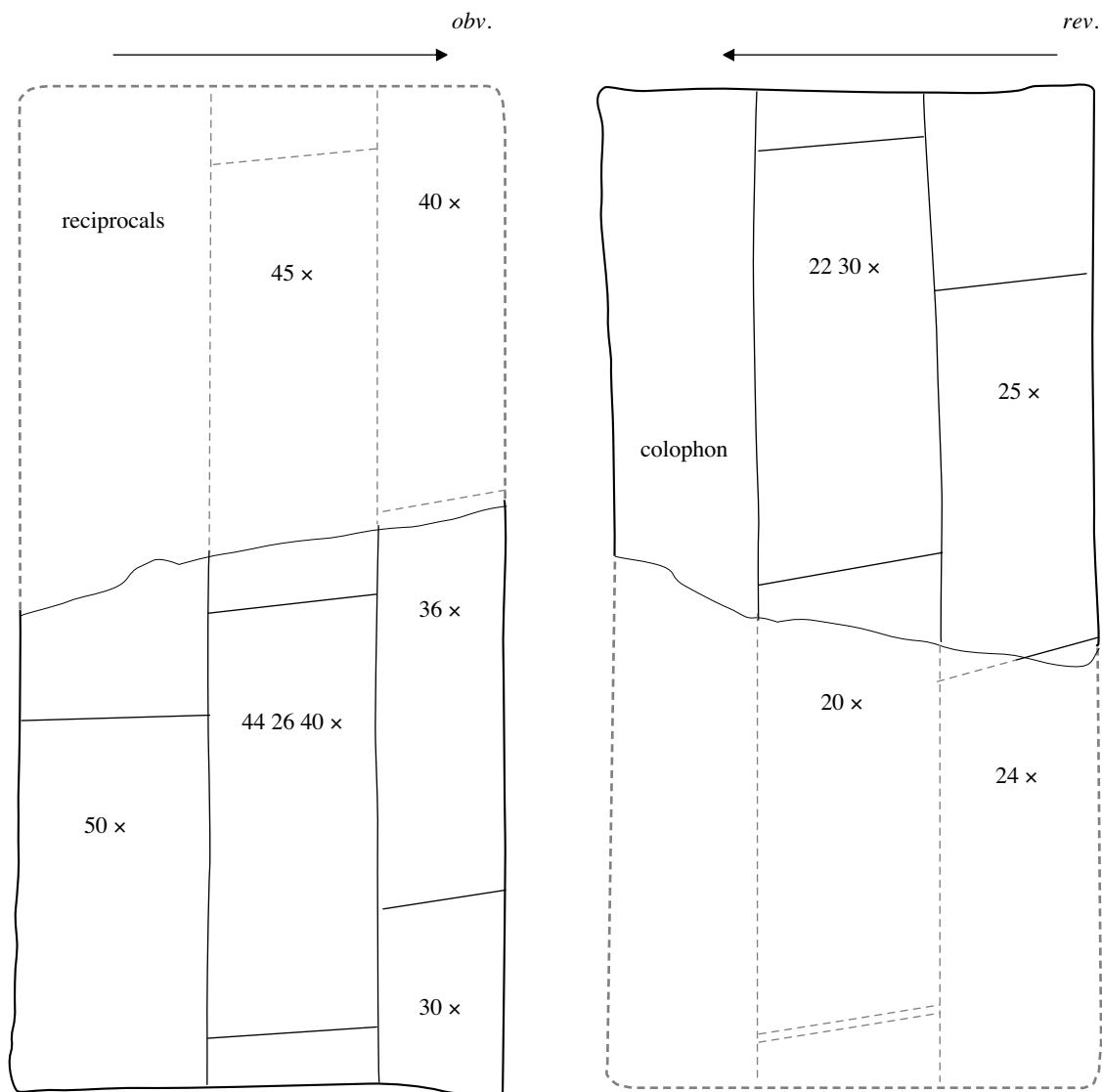

MS 3845, outline. A combined multiplication table with individual sub-tables for reciprocals and for the first 10 of maximally 43 single multiplication tables.

Fig. 2.6.11. MS 3845. The eleven first sub-tables of an Old Babylonian combined multiplication table.



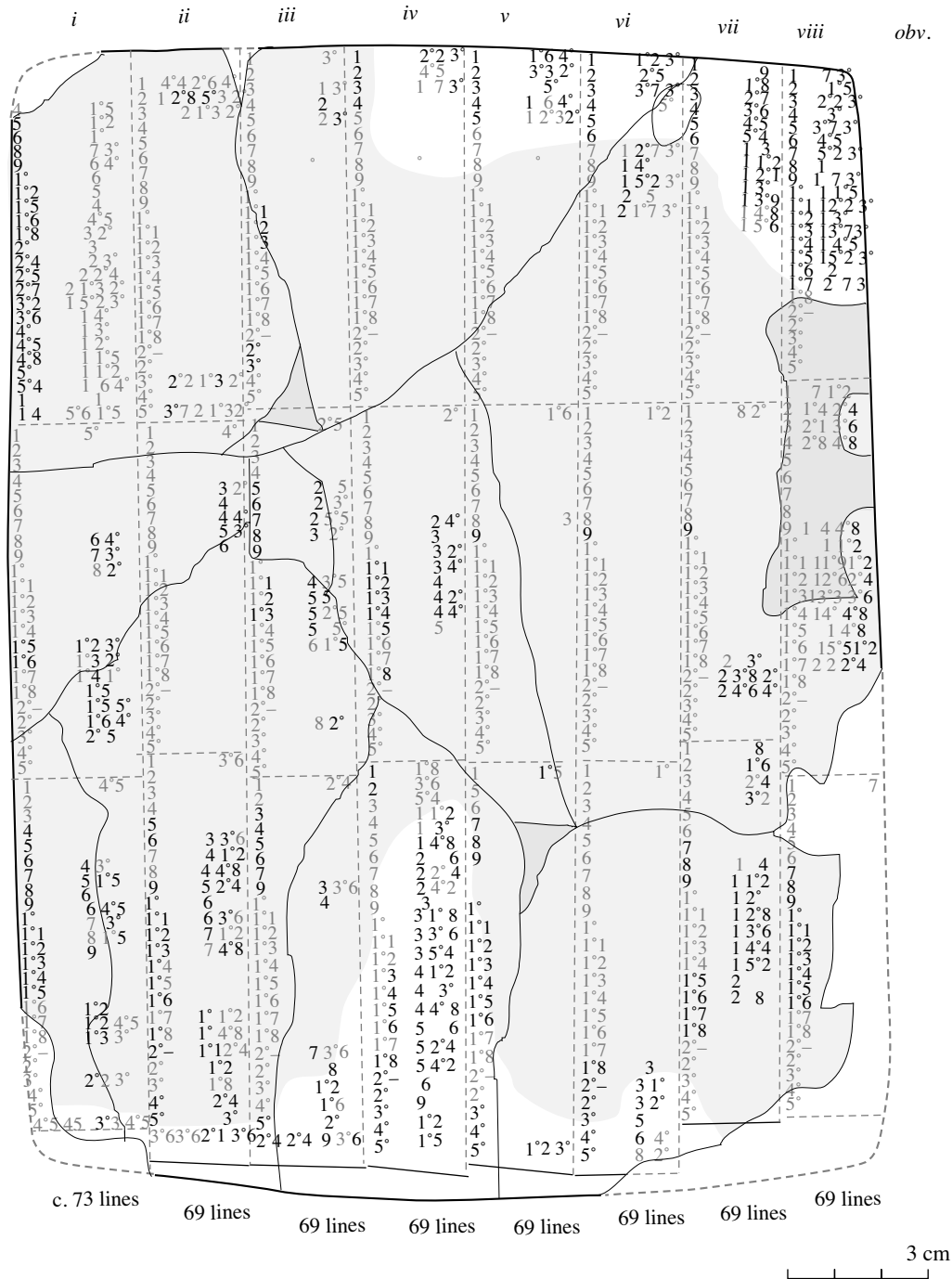

Fig. 2.6.12. MS 3974, *obv.* A nearly complete OB combined multiplication table with 40 sub-tables.

**MS 3974** (Figs. 2.6.12-13 above) is a nearly *complete* combined multiplication table with 40 sub-tables, in contrast to MS 3845, which, with its 11 sub-tables, is only *the first quarter* of a complete combined multiplication table. (Cf. the survey in *MKT 1*, 35, which clearly shows that several of the known Old Babylonian combined multiplication tables can be understood as either the first or the second *half* of a complete combined multiplication table. At least two of them, Ist. O 4849 and HS 204, are a *quarter* of a complete table and end with the multiplication table for 24, just like MS 3845.)

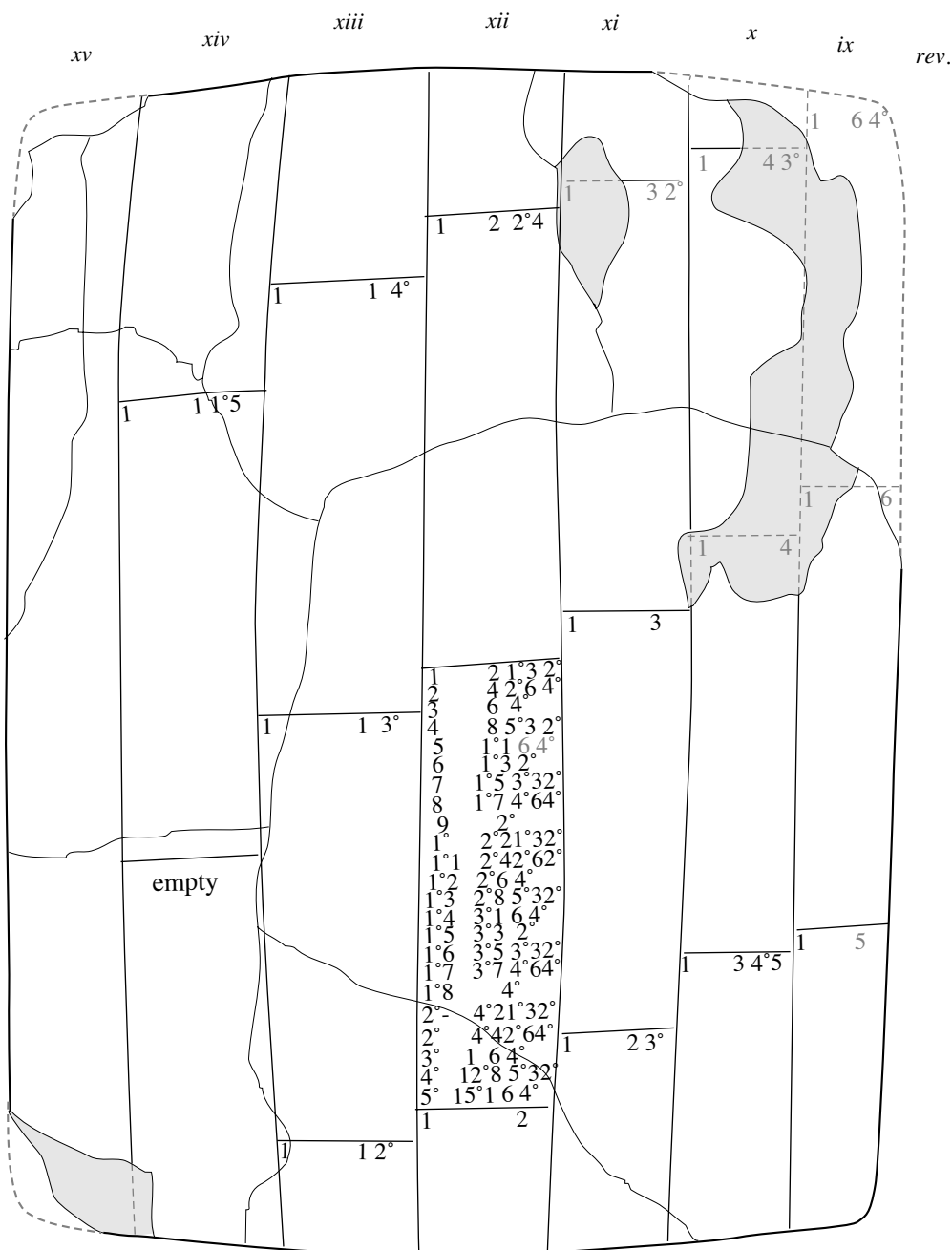

Fig. 2.6.13. MS 3974, rev. The standard head number 2 15 is replaced here by the new head number 2 13 20.

MS 3974 is well preserved in the sense that only small parts of the clay tablet are missing. The text on the reverse is also well preserved and readable. The text on the obverse is mostly rubbed off and almost unreadable. Fortunately, however, as a result of the particularly strong curvature of the tablet near the edges, much of the text close to the edges can still be read, so that at least a tentative reconstruction of the general layout of the text is possible (40 sub-tables in 14 columns, c. 924 lines):

Standard number notations are used in MS 3974 for the digits 4, 7, 8. For 19 a simple variant notation is used throughout, transcribed in the conform transliteration as ‘20 -’.

The 40 sub-tables in the 15 columns of MS 3974 are the table of reciprocals and the single multiplication tables with the following head numbers:

|      |          |    |       |       |       |      |      |        |      |      |         |      |      |
|------|----------|----|-------|-------|-------|------|------|--------|------|------|---------|------|------|
| rec. | 44 26 40 | 30 | 22 30 | 16 40 | 12 30 | 9    | 7 30 | [6 40] | 4 30 | 3 20 | 2 24    | 1 40 | 1 15 |
| 50   | 40       | 25 | 20    | 16    | 12    | 8 20 | 7 12 | 6      | 4    | 3    | 2 13 20 | 1 30 |      |
| 45   | 36       | 24 | 18    | 15    | 10    | 8    | [7]  | 5      | 3 45 | 2 30 | 2       | 1 20 |      |

Just as in MS 3845, the head number 48 is missing. Other “missing” head numbers are 2 15 and 1 12. On the other hand, an unexpected “extra” head number is 2 13 20. Other unexpected features are that the initial table of reciprocals ends with the pair 1 04, 56 15, omitting the otherwise standard pair 1 21, 44 26 40, and that the three sub-tables in the lower left corner of the obverse all seem to end with lines giving the squares of the head numbers (45, 45, 3 45; 36, 36, 21 36; 24, 24, 9 36).

The head number 2 15 is missing also in 2 of 6 combined multiplication tables in *MKT 1-2* and *MCT* that can be examined with respect to this issue. Moreover, there are no single multiplication tables with the head number 2 15 in *MKT 1-2* and *MCT*. Neither is the head number 1 12 represented in any of the combined or single multiplication tables in *MKT 1-2* and *MCT*.

### 2.6 e. Tables of Reciprocals and Multiplication Tables in the Schøyen Collection

#### 3 tables of reciprocals, 151 single multiplication tables, 35 different head numbers.

|            |                         |                   |                    |               |   |
|------------|-------------------------|-------------------|--------------------|---------------|---|
| rec.       | MS 3869/5               | 3874              | 3890               |               | 3 |
| 50 ×       | MS 2826                 | 3834/1            | 3849 (c)           | 3894/1-3      | 6 |
| 45 ×       | MS 2710                 | 3044/1-2          | <u>3044/3</u> (b*) |               | 4 |
| 44 26 40 × | MS 2711/1 (a)           | 2711/2            | 3858/1-2           | 3979          | 5 |
| 40 ×       | MS 2810                 | 2733              | <u>3909/3</u> (b*) | 3909/1-2, 4-5 | 7 |
| 36 ×       | MS 2709                 | 3859/1-7          |                    |               | 8 |
| 30 ×       | MS <u>2875</u> (a'')    | 2895 (a')         | 3877/1-3           |               | 5 |
| 25 ×       | MS 2808                 | 3857/1-6          |                    |               | 7 |
| 24 ×       | MS 2316 (a')            | 2825              | <u>3873/1-2</u>    |               | 4 |
| 22 30 ×    | MS 2339                 | 3915/1-3          |                    |               | 4 |
| 20 ×       | MS 2807                 | 3900/1-3          |                    |               | 4 |
| 18 ×       | MS <u>2708</u>          | 3950/1, 3-4       |                    |               | 4 |
| 16 40 ×    | MS 2363                 | 2660/1-2          | 2701               | 3856          | 5 |
| 16 ×       | MS 2184/2 (a')          | 3875/1-4          |                    |               | 5 |
| 15 ×       | MS 2738                 | 3867/1-4          |                    |               | 5 |
| 12 30 ×    | MS 2184/4, 9            | 2876              | 3851/1-3           |               | 6 |
| 12 ×       | MS <u>2184/3</u> (a')   | 2286/2 (a')       |                    |               | 2 |
| 10 ×       | MS 2805                 | 3923              |                    |               | 2 |
| 9 ×        | MS 2184/6               | 2352              | 3850/1-4           |               | 6 |
| 8 20 ×     | MS 2184/5               | 2703              | 3872/1-5           |               | 7 |
| 8 ×        | MS 2042                 | 3043/1-2          |                    |               | 3 |
| 7 30 ×     | MS 2184/8               | 2702              | 3930               |               | 3 |
| 7 12 ×     | MS 2286/3 (a')          | 2812              | 3040/1-4           |               | 6 |
| 7 ×        | MS 2804/1-2             | <u>2829</u> (a'') | 3852/1-4           |               | 7 |
| 6 40 ×     | MS 2184/1, 7            | 3934              |                    |               | 3 |
| 6 ×        | MS 3902/1-3             |                   |                    |               | 3 |
| 5 ×        | MS 2707                 | 3933/1-2          |                    |               | 3 |
| 4 30 ×     | MS 3861/1-3             |                   |                    |               | 3 |
| 4 ×        | MS 3036/1-2             | 3878/1-2          |                    |               | 4 |
| 3 45 ×     | MS 2286/1               | 2809              | 2811               | 3039/1-2      | 5 |
| 3 20 ×     | MS 2854                 | 3853/1-2          | 3865               |               | 4 |
| 3 ×        | MS 3957/1               |                   |                    |               | 1 |
| 2 30 ×     | MS 3978                 |                   |                    |               | 1 |
| 2 ×        | MS <u>3967/1</u> , 2, 3 |                   |                    |               | 3 |
| 1 30 ×     | MS 3855/1-2             |                   |                    |               | 2 |
| 1 12 ×     | MS <u>3866</u>          |                   |                    |               | 1 |

Of the 151 single multiplication tables, all are of type a, except 7 of type a', 2 of type a", and 2 of type b\*.

Underlined texts are those shown in Figs. 2.6.1 and 2.6.3-2.6.5.

MS 3874 (rec.), MS 3890 (rec.), MS 2184/3 (12 ×), and MS 3044/3 (45 ×) are shown in color in Appendix 10.

It is easy to check that the first eleven items in this list coincide with the eleven sub-tables on MS 3845. Furthermore, the 33 first sub-tables on MS 3974 correspond to the first 33 items on the list. (Only some of the smallest head numbers of sub-tables of MS 3845, namely 2 24, 2 13 20, 1 40, 1 20, and 1 15, do not correspond to head numbers of single multiplication tables in the Schøyen Collection.) This can hardly be a coincidence. The most obvious explanation is that there once existed a canonical Old Babylonian table text, for which a fitting name would be “the Old Babylonian combined multiplication table”, of which all the tables in the list above are single excerpts, while MS 3845 and MS 3974 are longer, more complete excerpts. This explanation is further supported by the evidence provided by the double and multiple multiplication tables discussed in Secs. 2.6 b-c above. Here is first a detailed list of all double multiplication tables in the Schøyen Collection:

### Nine Double Multiplication Tables

|        |   |         |                        |
|--------|---|---------|------------------------|
| rec.   | & | 50 ×    | MS <u>2877</u> (b*)    |
| 25     | & | 24 ×    | MS 3942                |
| 22 30  | & | 20 ×    | MS <u>2878</u>         |
| 18     | & | 16 40 × | MS 3950/2, <u>2719</u> |
| 16     | & | 15 ×    | MS 2806                |
| 12 30  | & | 12 ×    | MS 3038                |
| 7 30   | & | 7 12 ×  | MS <u>3964</u>         |
| 4      | & | 3 45 ×  | MS 3977                |
| [3 20] | & | 3 ×     | MS 3957/2              |

8 double tables of type a, and 2 of type b\*.

Underlined texts are those shown in Figs. 2.6.6 and 2.6.7.

What this list suggests is that (at least in the enumerated cases) double multiplication tables are excerpts of *pairs of consecutive sub-tables* in the Old Babylonian combined multiplication table. A similar conclusion can be drawn from the following brief list of sub-tables in the multiple multiplication tables in the Schøyen Collection (other than the large texts MS 3845 and 3974):

### Three Multiple Multiplication Tables

|                          |                        |                        |
|--------------------------|------------------------|------------------------|
| [7], 6 40, 6 × (obverse) | 7 30, 7 12 × (reverse) | MS <u>3870</u> (a)     |
| 8, 7 30, 7 12, 7 ×       |                        | MS <u>3939</u> (a & b) |
| 7, 6 40, 6 ×             |                        | MS <u>3891</u> (b*)    |

1 table of type a, 1 of type b\*, and 1 of mixed type.

Underlined texts are those shown in Figs. 2.6.8 and 2.6.9.

According to this list, multiple multiplication tables can be regarded as excerpts of *several consecutive sub-tables* from the Old Babylonian combined multiplication table. However, in the case of MS 3870, the sub-tables on the reverse should rightly have *preceded* the sub-tables on the obverse. (Whenever an Old Babylonian cuneiform text is inscribed on a clay tablet that is flat on one side and rounded on the other, the flat side is normally the obverse and the rounded side the reverse.)

It is, of course, already a well known fact that there existed a more or less canonical Old Babylonian combined multiplication table, and that single, double, or multiple multiplication tables are excerpts from such a combined table. This was shown by Neugebauer in a series of tabular summaries in *MKT* and *MCT*. See, in particular, the surveys of head numbers in single or multiple multiplication tables in *MKT* 1, 34-35. Nevertheless, with the many new examples of multiplication tables in the Schøyen Collection, any statistical conclusion that one might want to draw about Old Babylonian multiplication tables can now be much better documented.

## Attested head numbers in Old Babylonian single or multiple multiplication tables

| sub-table       | fraction  | other explanations                             | <i>MKT/MCT</i>   | MS              |
|-----------------|-----------|--|------------------|-----------------|
| rec. t.         |           |  | 42 rec.          | 3 rec. \        |
| 50 ×            | rec. 1 12 | 5/6  | 5 smt a, a'      | 6 smt / a, c    |
| 48 ×            | rec. 1 15 |  | —                | —               |
| 45 ×            | rec. 1 20 | walking number (distance/man-day)              | 3 smt a          | 4 smt a, b*     |
| 44 26 40 ×      | rec. 1 21 |  | 5 smt a, b       | 5 smt a, a'     |
| 40 ×            | 2/3       |  | 1 smt a          | 7 smt a, b*     |
| 36 ×            | rec. 1 40 |  | 6 smt a, b       | 8 smt a         |
| 30 ×            | 1/2       |  | 3 smt b          | 5 smt a, a'     |
| 25 ×            | rec. 2 24 |  | 13 smt a, a', b  | 7 smt \ a       |
| 24 ×            | rec. 2 30 |  | 14 smt a, b      | 4 smt / a, a'   |
| 22 30 ×         | *         | → used in certain trailing part algorithms     | 1 smt a          | 4 smt \ a       |
| 20 ×            | rec. 3    | 1/3  | 1 smt a          | 4 smt / a       |
| 18 ×            | rec. 3 20 |  | 6 smt a          | 4 smt \ a       |
| 16 40 ×         | *         | → decimal value 1,000                          | 9 smt a, ?       | 5 smt / a       |
| 16 ×            | rec. 3 45 |  | 7 smt a, b       | 5 smt \ a, a'   |
| 15 ×            | rec. 4    |  | 3 smt a, b       | 5 smt / a       |
| 12 30 ×         | *         | → weight, rectangular mud brick (wet)          | 3 smt a          | 6 smt \ a       |
| 12 ×            | rec. 5    |  | 2 smt a, b       | 2 smt / a'      |
| 10 ×            | rec. 6    | weight, rectangular mud brick (sun-dried)      | 4 smt b          | 2 smt a         |
| 9 ×             | rec. 6 40 |  | 8 smt a, b       | 6 smt a         |
| 8 20 ×          | *         | → weight, rectangular mud brick (baked)        | 4 smt a, b       | 7 smt a         |
| 8 ×             | rec. 7 30 |  | 3 smt a, b       | 3 smt a         |
| 7 30 ×          | rec. 8    |  | 2 smt a          | 3 smt \ a       |
| 7 12 ×          | *         | → molding number, rectangular mud bricks       | 6 smt a          | 6 smt / a, a'   |
| 7 ×             | *         | → the smallest non-regular integer             | 7 smt a, b       | 7 smt a, a'     |
| 6 40 ×          | rec. 9    |  | 2 smt a          | 3 smt a         |
| 6 ×             | rec. 10   | man's load, rectangular mud bricks (sun-dried) | 5 smt a          | 3 smt a         |
| 5 ×             | rec. 12   |  | 3 smt a, b       | 3 smt a         |
| 4 30 ×          | *         | → carrying number, rectangular mud bricks      | 5 smt a, b       | 3 smt a         |
| 4 ×             | rec. 15   |  | 1 smt a          | 4 smt \ a       |
| 3 45 ×          | rec. 16   |  | 2 smt a, b       | 5 smt / a       |
| 3 20 ×          | rec. 18   |  | 7 smt a          | 4 smt a         |
| 3 ×             | rec. 20   |  | 1 smt a'         | 1 smt a         |
| 2 30 ×          | rec. 24   |  | 8 smt a          | 1 smt a         |
| 2 24 ×          | rec. 25   |  | 1 smt ?          | —               |
| 2 15 ×          | *         | → man's load, square mud bricks (sun-dried)    | —                | —               |
| 2 13 20 ×       | rec. 27   | man's load, mud; mud basket                    | —                | —               |
| 2 ×             | rec. 30   |  | 2 smt ?          | 3 smt a         |
| 1 40 ×          | rec. 36   | decimal value 100                              | 4 smt a, b       | —               |
| 1 30 ×          | rec. 40   |  | 4 smt b          | 2 smt a         |
| 1 20 ×          | rec. 45   |  | —                | —               |
| 1 15 ×          | rec. 48   |  | 1 smt ?          | —               |
| 1 12 ×          | rec. 50   |  | —                | 1 smt a         |
| 42 head numbers |           |  | 42 rec., 162 smt | 3 rec., 148 smt |

Of the 42 *attested* head numbers, 34 are from the standard table of reciprocals, while 8 are explained in other ways.

Double multiplication tables (only MS) are indicated above by slash-backslash (\ and /).

The only single multiplication tables of type a' in *MKT/MCT* are A 1555 (50 ×), NBC 6349 (25 ×, from Larsa), and *MMA*P 27, 61 (3 ×, from Susa, early OB).

Attested in *multiple* or combined multiplication tables (*MKT/MCT* and MS) are all entries above except 1 12!

A reconstruction of the *complete* Old Babylonian combined multiplication table is presented in Appendix 2.

In the first column of the table above are listed *all head numbers* appearing in known Old Babylonian single or multiple multiplication tables. In the last two columns of the table, a comparison is made between the *MKT/MCT* corpus and the MS corpus of Old Babylonian *single* multiplication tables. The two are of about the same size, but there are a few instances when a head number is documented in one corpus and not in the other.

There are examples of single multiplication tables with the head numbers 2 24, 1 40, and 1 20 in the *MKT/MCT* corpus, but not in MS. On the other hand, there is a multiplication table with the head number 1 12, *the smallest head number known so far*, only in the Schøyen Collection!

Common for both the *MKT/MCT* and the MS texts is that there are no examples of single multiplication tables with the head numbers 48, 2 15, and 1 20. Those head numbers can be found only in some of the multiple or combined multiplication tables.

In both corpuses, a majority of the single multiplication tables are of type a. In the *MKT/MCT* corpus, there are 15 tables of type b, and 3 of type a', while in the MS corpus, there are 6 tables of type a', and no tables of type b but 2 of type b\*. These small differences may or may not be significant. They possibly indicate that the multiplication tables in the two corpuses come from different sites. (Most of the single multiplication tables in *MKT 1* are from Nippur and Kish. See the map in Fig. 9.2.)

The second column in the table above was inserted there in *an attempt to answer the question why the listed head numbers, and no others, are attested in Old Babylonian single or multiple multiplication tables*. It is, of course, well known that some kind of connection exists between the Old Babylonian standard table of reciprocals and the set of head numbers used in Old Babylonian multiplication tables, but the details of this connection have never before been worked out.

Now, look at the following simplified display of the Old Babylonian standard table of reciprocals, and compare the numbers appearing in it with the attested head numbers.

|        |         |                          |                          |
|--------|---------|--------------------------|--------------------------|
| 3" 40  | 10 6    | <b>27</b> 2 13 20        | <b>54</b> <b>1 06 40</b> |
| 2' 30  | 12 5    | 30 2                     | <b>1</b> <b>1</b>        |
| 3 20   | 15 4    | <b>32</b> <b>1 52 30</b> | <b>1 04</b> <b>56 15</b> |
| 4 15   | 16 3 45 | 36 1 40                  | 1 12 50                  |
| 5 12   | 18 3 20 | 40 1 30                  | 1 15 48                  |
| 6 10   | 20 3    | 45 1 20                  | 1 20 45                  |
| 8 7 30 | 24 2 30 | 48 1 15                  | <b>1 21</b> 44 26 40     |
| 9 6 40 | 25 2 24 | 50 1 12                  |                          |

In the first column of this table of reciprocals are listed *all the 1-place regular sexagesimal numbers*

3, 4, 5, 6, 8, 9, 10, 12, 15, 16, 18, 20, 24, 25, 27, 30, 32, 36, 40, 45, 48, 50, 54, 1,

and *two 2-place regular sexagesimal numbers*:

1 04, 1 12, 1 15, 1 20, 1 21.

All of these are among the attested head numbers, with the exception of

27, 32, 54, 1, 1 04, and 1 21.

These non-attested head numbers are the numbers in bold style in the first column of the table above.

In the second column of the table of reciprocals are listed the reciprocals of the numbers in the first column. These reciprocals are:

40, 30, 20, 15, 12, 10, 7 30, etc.

All of these, too, are attested head numbers, with the exception of

1 52 30, 1 06 40, 1, and 56 15.

These non-attested head numbers correspond to the numbers in bold style in the second column of the table above. Thus, the bold numbers in the table of reciprocals above can be collected into *four pairs of reciprocals*:

(32, 1 52 30), (54, 1 06 40), (1, 1), (1 04, 56 15) **four missing pairs**

and *two single numbers*:

**27, 1 21** **two missing single numbers**

The result of this rapid analysis can be expressed more briefly in the following way:

Some but not all of the numbers appearing in the first or second column of the standard table of reciprocals correspond to attested head numbers in single or multiple multiplication tables.

It is also easy to check that, conversely,

Some but not all of the numbers attested as head numbers in single or multiple multiplication tables appear in the first or second column of the standard table of reciprocals.

Indeed, the following eight attested head numbers do not appear in the standard table of reciprocals:

**22 30, 16 40, 12 30, 8 20, 7 12, 7, 4 30, 2 15, 2 13 20**                      **nine extra single numbers**

The situation is obviously more complicated than one had reason to expect.

There are a couple of additional questions that need to be answered:

**Why is 50 the first head number, and why do the head numbers form a decreasing sequence?**

### 2.6 f. *An Explanation of the Head Numbers in the Combined Multiplication Table*

**1. Why 50 is the first head number.** In the standard table of reciprocals, the number 50 is not placed in a prominent position, so there must be some other reason why 50 is the first head number in the combined multiplication table. The reason may be that the multiplication table for 50, or rather  $50 = 5/6$ , was *chronologically* the first multiplication table. Although this is just a conjecture, it does make sense. Indeed, the fraction  $5/6$  is one of only four “basic fractions” for which there existed a special cuneiform sign (6"). (See Fig. A4.2 in Appendix 4 below.) The other basic fractions,  $1/3$ ,  $1/2$ , and  $2/3$  (with the signs 3', 2', and 3") had been around for a long time, having been constantly used in Sumerian cuneiform texts since at least the ED IIIa period in the middle of the third millennium BC. Presumably, counting with  $1/3$ ,  $1/2$ , and  $2/3$  was one of the basic skills of any Sumerian or Babylonian school boy. *The sign for 5/6, on the other hand, was not as commonly used.* According to a catalogue search at <http://cdli.ucla.edu> it is, apparently, first attested, in the form 6".ša, in two small Old Akkadian clay tablets, **CT 50, 138** and **ITT 2, 4355**, both badly understood. It is reasonable to assume that the need was felt for a multiplication table for this uncommon basic fraction, and that such a multiplication table became one of the first successful applications of the new way of writing sexagesimal numbers in place value notation. Since this hypothetical first multiplication table can have been used only for a brief period before the invention of the more general combined multiplication table, it is easy to understand why no such primordial multiplication tables have been preserved.

Nevertheless, there does exist a text that may be an example of just such a primordial multiplication table. That text is **MS 3849** (Fig. 2.6.14), which differs from the usual kind of Old Babylonian single multiplication tables in several ways. Already the format of the clay tablet sets this text apart from all the multiplication tables discussed above. The single or multiple multiplication tables shown in Figs. 2.6.1 and 2.6.3-9 are written on one column tablets, and the combined multiplication tables in Figs. 2.6.10-13 on large tablets with several columns on each side. MS 3849, on the other hand, is a medium size two column tablet with a single multiplication table in the first column on the obverse. The rest of the tablet is empty.

In the terminology used, for instance, by Proust in her analysis of the corpus of OB mathematical cuneiform texts from Nippur (Proust, *TMN* (2004)), MS 3849, *obv.* appears to be a text of type IIa, while the one column tablets discussed above are of type III, and the tablets with combined multiplication tables of type I. (See Proust, *op. cit.*, 5.2.1-5.2.4.) As demonstrated by Proust, the overwhelming majority of all OB mathematical cuneiform texts from Nippur are either metrological lists and tables, or arithmetical tables, inscribed on the obverse and/or the reverse of tablets of type II (*op. cit.*, Annexe 1, Figs. 1 and 2). In most cases, tablets of type II are inscribed on the obverse with large number signs in two columns, but on the reverse with number signs of normal size in several columns. The text on the obverse is the part of the curriculum most recently studied by the student who wrote the text, while the text on the reverse is a repetition of other recently learned parts of the curriculum. As observed by Proust, a good example is the Nippur text **CBM 11340+** (Hilprecht, *BE 20/1* (1906), text 20, with photos of obverse and reverse on plates IV-V). An outline of CBM 11340+ is offered by Neugebauer in *MKT 2*, pl. 62. On the obverse of that text there are two columns. In the left column, someone

has inscribed a multiplication table of type a with the head number 45, using unusually big cuneiform signs. In the right column, there is a clumsy and unfinished attempt to copy the content of the left column. On the reverse, there are four columns of text inscribed with an alternating series of copies of the table of reciprocals and the multiplication table with head number 50.

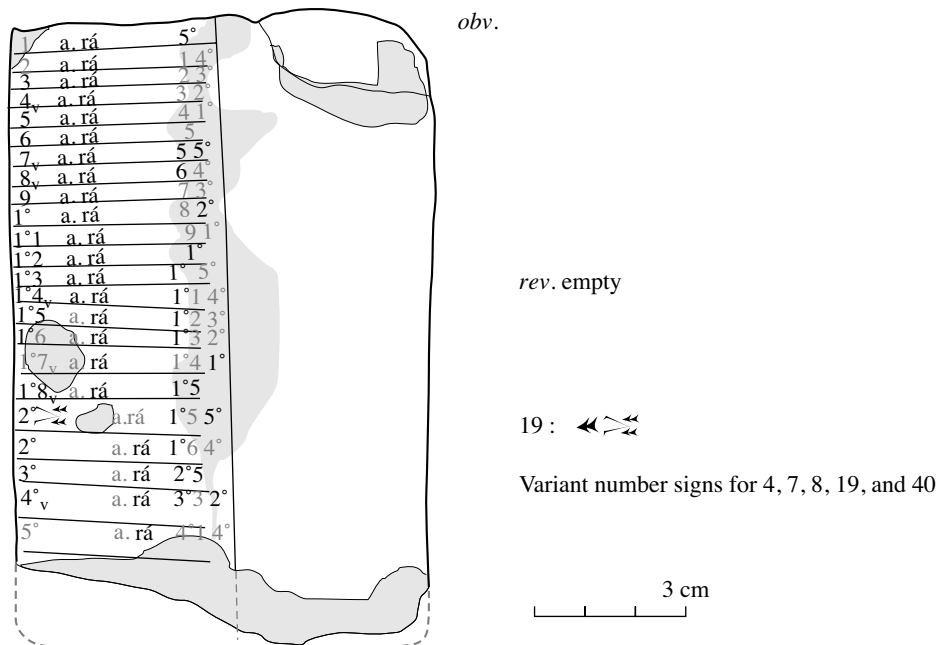

Fig. 2.6.14. MS 3849, *obv.* A single multiplication table (50 ×) of type c (new).

For some reason, on MS 3849 only the first column on the obverse is inscribed, with a multiplication table for the head number 50. There is no way of knowing what the remaining space on the clay tablet was intended for, but it is clear that this is not a tablet of the kind where the teacher’s neat writing in the first column was to be copied in a student’s clumsy hand in the second column. Indeed, the table in the first column was probably produced by an inexperienced student. The writing is not very elegant, and the signs are so weakly imprinted in the clay that it is very difficult to read them.

Another quite unusual feature of MS 3849 is that it makes use of variant number signs not only for 7, 8, and 19, but also for 4 and 40. The only other example of an arithmetical table text of this kind discussed above is the early Old Babylonian table of reciprocals MS 3874 in Fig. 2.5.1. Even more significant appears to be the fact that the multiplication table on MS 3849 is of an otherwise unattested kind (here called type c), with all entries of the form

$$n \text{ a.rá } p \cdot n \quad \text{instead of the normal equation} \quad \text{a.rá } n \quad p \cdot n .$$

Taken together, all these unusual features suggest that, possibly, MS 3849 is older than all the other clay tablets with multiplication tables discussed in this volume.

**2. Head numbers borrowed from the table of reciprocals.** Now, if a multiplication table for 50 was really the first multiplication table using the new sexagesimal place value numbers, then it cannot have lasted a long time before someone tried to construct other multiplication tables using the same technique. This kind of haphazard construction of new multiplication tables was by necessity only a transitory stage of the development, rapidly followed by the invention of the Old Babylonian combined multiplication table with its extensive assortment of multiplication tables associated in a systematic way with a whole series of head numbers. Presumably, the initial intention of the anonymous inventor of this combined multiplication table was to *facilitate division* through the compilation of a list of sexagesimal numbers in relative place value notation representing all numbers of the kind

$$n \cdot \text{rec. } m, \text{ where } m \text{ is any reasonably small regular sexagesimal number and } n \text{ any reasonably small integer.}$$



(In modern mathematical language, numbers of the form  $n \cdot \text{rec. } m$  can be interpreted as rational numbers  $n/m$ . The Old Babylonian combined multiplication table can be explained as a systematically arranged list of rational numbers that can be expressed as finite sexagesimal fractions.)

So, with departure from the already established multiplication table with head number 50, the inventor of the combined multiplication table started to construct new multiplication tables with the following head numbers imported *from the end of the right column* of the standard table of reciprocals:

(50.) 48, 45, 44 26 40.

Automatically, the head numbers so obtained were ordered in a *decreasing* sequence.

Obviously having a lot of trouble with his construction of the multiplication table for the 3-place head number 44 26 40, the inventor of the table now somewhat rashly decided to strike from his table of reciprocals the three pairs (27, 2 13 20), (32, 1 52 30), and (54, 1 06 40), because they contained 3-place numbers. Next, he made a new start *from the beginning of the right column* of the standard table of reciprocals, constructing multiplication tables with the following head numbers:

40, 30, 20, 15, 12, 10, 7 30, 6 40, 6, 5, 4, 3 45, 3 20, 3, 2 30, 2 24, 2, 1 40, 1 30, 1 20, 1 15, 1 12.

The procedure stopped at 1 12, because the 3-place number 1 06 40 had already been cancelled, because 1 would be of no interest as a head number, and because 56 15 did not fit into the decreasing sequence of head numbers listed so far!

Obvious gaps in this decreasing sequence of head numbers were then filled out by adding to the list head numbers imported *from the left column* of the table of reciprocals, read *upwards*:

36, 30, 25, 24, 18, 16, 9, 8.

By turning around in this way and proceeding upwards after reaching the pair (50, 1 12), the inventor of the combined table *unintentionally* missed adding to the list of head numbers both the pair (1 04, 56 15) and the single number 1 21, since they were situated in the table *below* the pair (1, 1).

**3. The extra head numbers.** The procedure described above explains all attested head numbers in Old Babylonian single or multiple multiplication tables, except the following nine:

**22 30, 16 40, 12 30, 8 20, 7 12, 7, 4 30, 2 15, 2 13 20**

**nine extra head numbers**

These head numbers were added to the list of head numbers for various reasons.

The most obvious case is that of **16 40**, which is the sexagesimal equivalent of the decimal round number 1,000. *Since decimal numbers were used in everyday life in Babylonia, outside the school environment*, it would clearly be advantageous to include a multiplication table for  $1,000 = 16\ 40$  in the combined multiplication table. (An extra multiplication table for  $100 = 1\ 40$  was not needed, since  $1\ 40 = \text{rec. } 36$  was already included in the list of head numbers.)

The inclusion of **7** in the list of head numbers was probably motivated by completely different considerations, in particular that 7 is the smallest sexagesimally *non-regular* integer. It is also one of the “special numbers” 7, 11, 13, 14, and 19, which occupied an important niche in both pre-Babylonian and Old Babylonian mathematics, as a counterweight to the otherwise dominating counting with regular sexagesimal numbers. (See Høyrup, *JNES* 52 (1993).)

Six of the seven remaining extra head numbers are associated with Old Babylonian “brick metrology”. (For a brief, but fairly thorough account of this interesting topic, see Sec. 7.3 a below, in particular the discussion of the new brick text MS 2221.) Old Babylonian mathematical texts dealing with bricks usually mention the following three types of bricks:

|                            |   |                      |
|----------------------------|---|----------------------|
| sig <sub>4</sub>           | ‘bricks’                                    | (rectangular bricks) |
| sig <sub>4</sub> .4b       | ‘cow-bricks’                                | (half-square bricks) |
| sig <sub>4</sub> .al.ūr.ra | ‘tile-bricks’ (literal translation unknown) | (square bricks)      |

Various constants for these and other, less common, types of bricks are listed in several Old Babylonian mathematical “tables of constants”. A particularly important constant for any given type of brick was its “molding

number” (*našpakum*), the number of brick-šar of bricks of that type contained in a volume-šar (1 sq. ninda · 1 cubit). A brick-šar was a convenient counting unit for bricks, equal to 12 sixties, and 1 ninda = 12 cubits, with 1 cubit = 30 fingers. Therefore, an alternative way of defining the molding number of any given type of bricks is the number of bricks of that type contained in one twelfth of one sixtieth of a volume-šar, that is in a volume equal to

$$1 \text{ volume-šar}/(12 \cdot 60) = 1 \text{ sq. ninda} \cdot 1 \text{ cubit} \cdot 1/(12 \cdot 60) = 1 \text{ sq. cubit} \cdot 6 \text{ fingers } (;\text{01 ninda}).$$

In particular, Old Babylonian rectangular bricks of the *standard format*  $1/2$  cubit  $\times$   $1/3$  cubit  $\times$  5 fingers had the molding number  $2 \cdot 3 \cdot 6/5 = 36/5 = 7 \frac{1}{5}$ , or simply 7 12 in sexagesimal numbers in Babylonian relative place value notation. Consequently, the “extra” head number **7 12** in the Old Babylonian combined table of constants can be explained as the molding number for rectangular bricks of the mentioned standard format. It was, of course, very useful for an Old Babylonian mathematician to have easy recourse to a multiplication table for this important constant.

The volume of a rectangular brick of the standard format can be expressed as follows:

$$1/(7;12) \cdot 1 \text{ volume-šar}/(12 \cdot 60) = ;\text{08 } 20 \cdot ;\text{00 } 05 \text{ volume-šar} = ;\text{00 } 00 \text{ } 41 \text{ } 40 \text{ volume-šar}.$$

This result can be compared with the text of the round hand tablet **YBC 7284** (*MCT*, 97). On the reverse of that clay tablet are mentioned the numbers 41 40, 8 20, and 12, the latter called *igi.gub.ba.bi* ‘its constant’. On the obverse, it is stated that the weight of one (rectangular) brick is  $8 \frac{1}{3}$  mina (8 written with the variant number sign 8<sub>v</sub>). Since 1 00 minas = 1 talent, it follows that  $8 \frac{1}{3}$  mina = ;08 20 talent. Consequently, the implication of YBC 7284 is that

the weight of a “unit brick” of the dimensions 1 sq. cubit · 6 fingers (;\text{01 ninda}) is precisely 1 talent.

This is a unitary relation of a kind that was typical for Sumerian/Old Babylonian metrology.

Another Old Babylonian text, the table of constants **RAFb = BM 36776** (see again Sec. 7.3 a below), makes it clear that the weight mentioned in YBC 7284 was the weight of a *baked* rectangular brick of standard format, and also that a sun-dried brick was assumed to be  $1/5$  lighter than a freshly made brick, and a baked brick  $1/6$  lighter than a sun-dried brick. In other words, it was assumed that

|             |                  |   |
|-------------|------------------|---|
| 12;30 minas | is the weight of | 1 <i>freshly made</i> rectangular brick |
| 10 minas    | is the weight of | 1 <i>sun-dried</i> rectangular brick    |
| 8;20 minas  | is the weight of | 1 <i>baked</i> rectangular brick.       |

Apparently, the inventor of the Old Babylonian combined multiplication table thought that it would be useful to include multiplication tables for these brick constants, too. This is a plausible explanation of the extra head numbers **12 30** and **8 20**. (A possible alternative explanation of 8 20 as a head number is that 8 20 is the reciprocal of the molding number 7 12. However, there is no similar alternative explanation of 12 30, which is the reciprocal of 4 48.)

The extra head numbers **4 30** and **2 15** are explained by the mentioned text **MS 2221** discussed in Sec. 7.3 a below. In the second column on the obverse of MS 2221 are listed the three numbers 6, 4 30, and 2 15. The three numbers can be explained as follows:

6, 4;30, and 2;15 *sun-dried* bricks of the three types R1/2c, H2/3c, and S2/3c constitute a man’s-load (1 talent).

Here R1/2c, H2/3c and S2/3c are convenient names for common sizes of rectangular bricks, half-square bricks, and square bricks. Clearly it was useful to have at hand multiplication tables for 6, 4 30, and 2 15, representing *man’s loads of bricks of the most common formats and sizes*. (The multiplication table 6 = rec. 10 was, of course, already included in the combined multiplication table.)

The extra head number **2 13 20** has a similar explanation. It appears, as a matter of fact, right below the three numbers 6, 4 30, and 2 15 in the second column on the obverse of MS 2221, where it represents *a man’s load of mud*, corresponding to the standard size of a mud basket.

As elegant as it seems to be, the explanation proposed above for the extra head numbers 4 30, 2 15, and 2 13 20 is not entirely convincing. This is shown by a look at the table presented above of attestations of head numbers in single multiplication tables. According to that table, 4 30 appears as a head number in 8 single mul-

ultiplication tables in *MKT/MCT* or *MS*, while there are no known single multiplication tables with the head numbers 2 15 or 2 13 20. Luckily, the reason for this imbalance is not hard to find. It is that 4 30 can alternatively be explained as the *carrying number* for rectangular bricks of standard size (type R1/2c). The carrying number for any type of bricks is the product of a man's load of that type of bricks and the *walking number* for a man carrying bricks, 45 00 ninda per man-day. Thus, for rectangular bricks of standard type, the carrying number can be calculated as

$$45\ 00\ \text{ninda/man-day} \cdot 6\ \text{bricks} = 4\ 30\ (00)\ \text{brick-ninda/man-day}.$$

In the table on the obverse of *MS 2221*, the first row

$$45 \quad 6 \quad 4\ 30 \quad \textit{libittum} \text{ ('brick')}$$

can be explained as a calculation of the carrying number 4 30 in precisely this way

The only remaining extra head number, **22 30**, is tougher to explain, since the number 22 30 is not mentioned in any of the known Old Babylonian tables of constants. However, it is possible that it was found to be useful to have a multiplication table for 22 30 in certain systematic applications of the trailing part algorithm in combination with the doubling-and-halving-algorithm (see Sec. 1.4 above). A beautiful example is the algorithm table **CBS 1215**, exhibited and explained in Appendix 3. In that text, the starting point is the pair of reciprocals 2 05, 28 48, where 2 05 is the third power of 5. With departure from this initial pair, 20 new pairs of reciprocals are constructed through the simple device of repeatedly doubling the first number and halving the second number. For each pair of reciprocals  $n, m$ , it is shown how  $m$  can be obtained from  $n$ , and  $n$  from  $m$ , by use of the trailing part algorithm. The details of the algorithm are displayed in Fig. A3.4 in Appendix 3.

Now, in this algorithm table, each reciprocal  $m$  is computed as the product of the reciprocals of factors of the corresponding number  $n$  (and conversely). The following regular sexagesimal numbers are used in various combinations as factors in the computations of the 21 *reciprocals*:

$$24, \mathbf{22\ 30}, 18, 12, 9, 6, 3\ 45, 3, 2\ 24, 1\ 30.$$

The following regular numbers are used in the computations of the 21 *reciprocals of reciprocals*:

$$16, 10, 6\ 40, 5, 4, 2\ 30, \mathbf{2\ 13\ 20}, 2, 1\ 40, 1\ 20, 1\ 15.$$

All these regular numbers are attested head numbers in the Old Babylonian combined multiplication table, all of them except 22 30 (and possibly 2 13 20) being borrowed directly from the Old Babylonian standard table of reciprocals. The number 2 13 20 occurs only once as a factor in CBS 1215, in the eighth sub-table where it is multiplied by 2, but the number 22 30 occurs as a factor 7 times. In sub-tables 9 and 10, 22 30 is multiplied by 18 and 9, respectively, in sub-tables 13 and 14 by 3 45, in sub-tables 17 and 18 by 14 03 45, the second power of 3 45, and in sub-table 21 by 52 44 03 45, the third power of 3 45. Thus, it is clear that it must have been very useful to have recourse to a multiplication table for 22 30 when constructing an algorithm table like CBS 1215.

**4. The uniqueness of the Old Babylonian combined multiplication table.** The preceding discussion of the rather peculiar form of the list of head numbers in the Old Babylonian combined multiplication table, and of the convoluted way in which that list must have been constructed, clearly demonstrates the uniqueness of the combined multiplication table. It is inconceivable that a table with this complicated structure can have been composed independently by two different persons.

It is now possible to give a tentative sketch of the historical development of counting with sexagesimal numbers at the beginning of the second millennium BC: At some time late in the Ur III period the relative place value system for sexagesimal numbers had been invented, as a clever modification of the Sumerian non-positional sexagesimal system (with "sign value numbers") which had been in use practically without change during the whole preceding millennium. Among the first applications of the new number system were the table of reciprocals in its original form (as in the table texts HS 201, Ist. T. 7375, and Ist. Ni 374), and a multiplication table for the fraction  $5/6 = '50'$  (as in MS 3849), for which now also a new sign was invented.

In an early part of the Old Babylonian period the teaching of mathematics in the scribe schools was intensified, partly because the students needed training in the use of the new positional numbers which were not as

intuitively comprehensible as the Sumerian sign value numbers, and partly because it turned out to be so much easier to count with the new numbers. It is likely that at this initial stage each teacher constructed his own multiplication tables with various head numbers for specific purposes. In particular, sexagesimal multiplication tables were probably constructed for the decimal units 10,  $100 = 1\ 40$ , and  $1,000 = 16\ 40$ , and multiplication tables were also constructed for the reciprocals of small regular integers, in order to facilitate division. Other multiplication tables were constructed with various head numbers suitable for counting with bricks, and so on.

Very soon, some anonymous teacher of mathematics decided to construct a large table text with many sub-tables, including at the same time a new streamlined version of the table of reciprocals, multiplication tables for reciprocals of regular numbers, and several of the special multiplication tables that were in circulation at the time. The result was the Old Babylonian combined multiplication table, constructed in the way described above. (For a detailed presentation of the table, see Appendix 2.)

The new combined multiplication table became very popular, soon being used in scribe schools all over Mesopotamia. Presumably, every mathematics teacher had two or three large clay tablets containing all the sub-tables of the combined multiplication table. The students were then asked to make excerpts (one, or two, and sometimes more sub-tables) from the large texts, as writing exercises and in order to learn some of the tables by heart. Apparently, the making of duplicates was avoided. That must be why most of the head numbers, except the very last ones in the list, are represented with about the same frequency in the extant corpus of Old Babylonian single multiplication tables, and why there is little overlapping of the double multiplication tables.

It is likely that the successful compilation of the combined multiplication table was the inspiration that led to the creation also of the other canonical arithmetical table texts, the tables of squares, square sides, and cube sides. (The related case of the large combined *metrological* table texts, and the many small excerpts from them, will be discussed below, in Sec. 3.)

Note: What was said above about the uniqueness of the combined multiplication table is not the whole truth. It is worth noting that no *single* multiplication tables with the head number 48 have yet been found, and in the large multiple multiplication text MS 3845 (Figs. 2.6.10-11), the head number 48 is absent. In the survey of multiple multiplication tables in *MKT 1*, 35 this head number is present only in 4 out of 18 listed multiple or combined multiplication tables. What must have happened is that some Old Babylonian scribe making a copy of the original combined multiplication table inadvertently forgot to include the single multiplication table with this head number. After that, all copies or copies of copies of this one incomplete combined table similarly lacked the head number 48.

**5. Late Babylonian multiplication tables with non-standard head numbers.** Noteworthy is also that in *JCS 22* (1968/1969) Aaboe published two “atypical” multiplication tables from Uruk. One of them (**IM 2899**) is a double multiplication table with the head numbers  $2\ 24 (= \text{rec. } 25)$  and  $2\ 13\ 20 (= \text{rec. } 27)$ . We now know, of course, that this is not really an atypical multiplication table, since both  $2\ 24$  and  $2\ 13\ 20$  are attested elsewhere as head numbers.

The other multiplication table published by Aaboe (**Ist. U 91**) is *Late Babylonian*. It is a multiple multiplication table with the following curious list of mostly non-standard head numbers:

[...], 32, **28 48**, **18 45**, **11 15**, **9 22 30**, **6 45**, **4 20**, **3 30**, 2 15, 2 13 20, [...].

Two of these head numbers are, in addition, non-regular:  $3\ 30 (= 7 \cdot 30)$ , and  $4\ 20 (= 13 \cdot 20)$ .

**BM 141493** = 1990-1-30 is another Late Babylonian clay tablet, previously unpublished,<sup>1</sup> with a single multiplication table for the non-regular head number 13, which is also a non-standard head number. The entries in this multiplication table are of the following type:

|        |     |                  |
|--------|-----|------------------|
| 1 · 13 | 13  |                  |
| 2 · 13 | 26  |                  |
| ... .. | ... | <i>Continued</i> |

1. Hand copies of BM tablets in this book (in most cases produced by F. Al-Rawi) are published here with the kind permission of the trustees of the British Museum.

... ..      ...  
 29 · 13      6 17      (the hand copy shows 6 07)  
 29 · 30      6 30

Note the use in this text of a *Late Babylonian multiplication sign*, which in this text is in the form of an oblique line of three oblique wedges. (Surprisingly, three oblique wedges was also a Late Babylonian stenographic sign for ‘9’.)

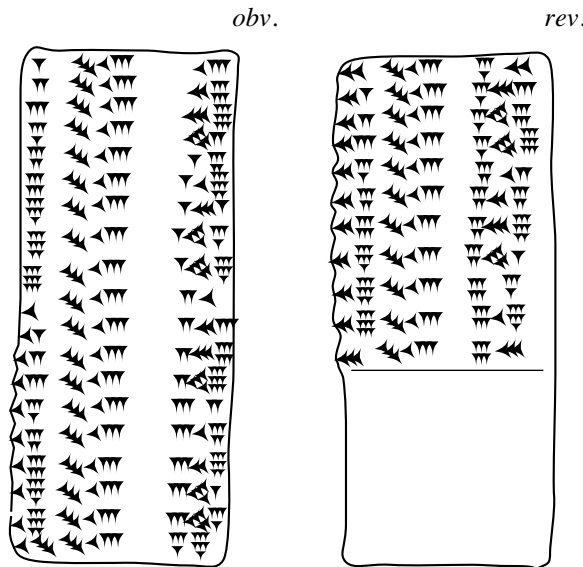

Fig. 2.6.15. BM 141493. A Late Babylonian single multiplication table with the irregular head number 13.

## 2.7. Old and Late Babylonian Sexagesimal Representations of Decimal Numbers

### 2.7 a. MS 3970. An Old Babylonian Unfinished Conversion Table

**MS 3970** (Fig. 2.7.1 below) is a clay tablet with only the beginning of an arithmetical table. The writing of the text stopped abruptly in the fifth and last line when only the initial ten-sign of the sexagesimal number 17 20 had been inscribed.

The meaning of the text becomes immediately clear if the five sexagesimal numbers of the aborted table are translated into decimal numbers:

|         |   |         |
|---------|---|---------|
| 11 40   | = | 700     |
| 13 20   | = | 800     |
| 15(00)  | = | 900     |
| 16 40   | = | 1,000   |
| 1[7 20] | = | [1,100] |

It is obvious that what the writer of this text wanted to write down was *the sexagesimal representations of multiples of the decimal unit 100*, starting with 700.

There is room enough on the obverse of the clay tablet for two columns of numbers. If the text had been completed, then it is likely that the right column would have listed the Akkadian *non-positional* decimal equivalents of the sexagesimal numbers in the left column, in the following way:

|       |                   |
|-------|-------------------|
| 11 40 | 7 me              |
| 13 20 | 8 me              |
| 15    | 9 me              |
| 16 40 | 1 li-im           |
| 17 20 | 1 li-im 1 me etc. |

However, it is possible that it never was the writer’s intention to include a second column in the text. It seems peculiar that in an Old Babylonian text like this the traditional (decimal) numbers would appear in the right column and the sexagesimal numbers in the left column. Compare with Old Babylonian metrological table texts where the sexagesimal numbers are always written in the right column. Another possibility is that MS 3970 is a *Late Babylonian* text, since in Late Babylonian metrological and other tables, the sexagesimal equivalents are usually written in the left column, as if the table was to be read from right to left. See Friberg, *GMS* 3 (1993). See also BM 36841 below.

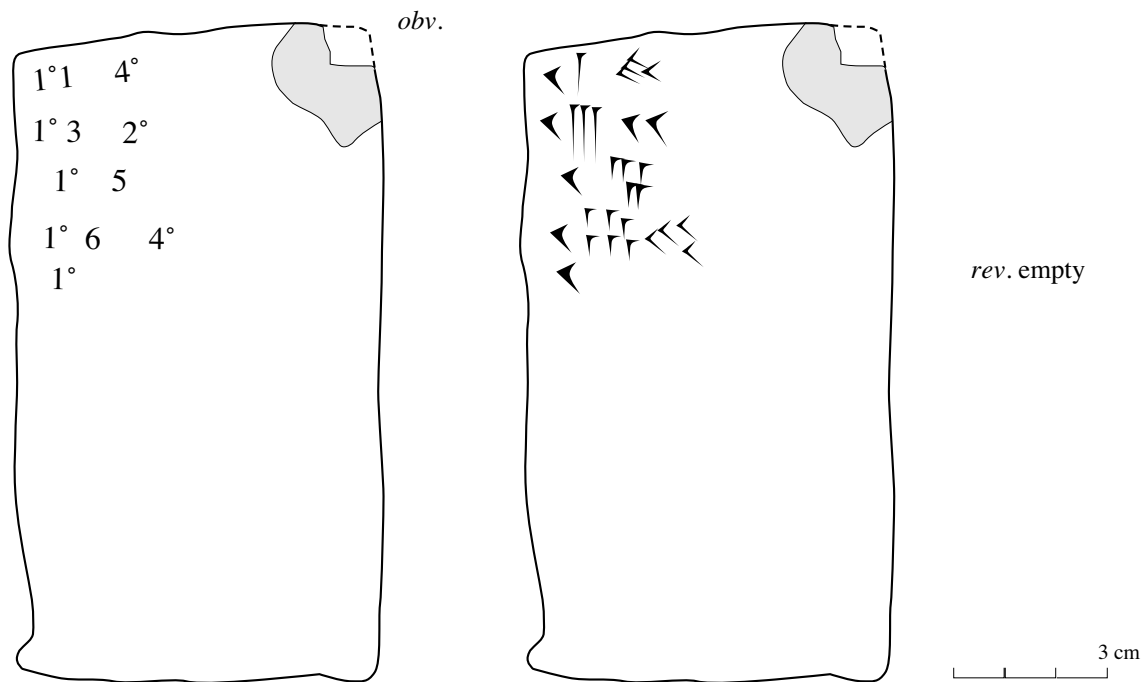

Fig. 2.7.1. MS 3970. Un finished text. Sexagesimal equivalents of multiples of the decimal unit 100.

2.7 b. *BM 36841. A Late Babylonian Parallel Text*

In view of the fact that sexagesimal numbers were used in Mesopotamia only for calculations, not in the daily life, one might have expected to find many examples of clay tablets with sexagesimal representations of decimal numbers. For some reason, that is not the case. Indeed, MS 3970 is the only known Old(?) Babylonian example of a text of that kind, and the only known parallel text is **BM 36841** (Figure 2.7.2 below), a previously unpublished fragment of a Late Babylonian clay tablet.

There are fragments of two table texts on the obverse of BM 36841. The table to the left is a table of reciprocals, quite different from the Old Babylonian standard table of reciprocals, with entries like

|             |      |      |                                    |         |        |
|-------------|------|------|------------------------------------|---------|--------|
| 4           | 15-ú | 4    | (is the sexagesimal equivalent of) | a 15-th | (1/15) |
| 3 45        | 16-ú | 3 45 | (is the sexagesimal equivalent of) | a 16-th | (1/16) |
| <i>etc.</i> |      |      |                                    |         |        |

The table to the right on the obverse is a decimal-sexagesimal conversion table with entries like

|             |                |      |                                    |           |
|-------------|----------------|------|------------------------------------|-----------|
| 5           | [3 <i>me</i> ] | 5    | (is the sexagesimal equivalent of) | 3 hundred |
| 6 40        | [4 <i>me</i> ] | 6 40 | (is the sexagesimal equivalent of) | 4 hundred |
| <i>etc.</i> |                |      |                                    |           |

The conversion table continues on the reverse, and proceeds to

|           |               |         |                                    |             |
|-----------|---------------|---------|------------------------------------|-------------|
| 2 46 40   | 10 <i>lim</i> | 2 46 40 | (is the sexagesimal equivalent of) | 10 thousand |
| [... ...] | [... ...]     |         |                                    |             |

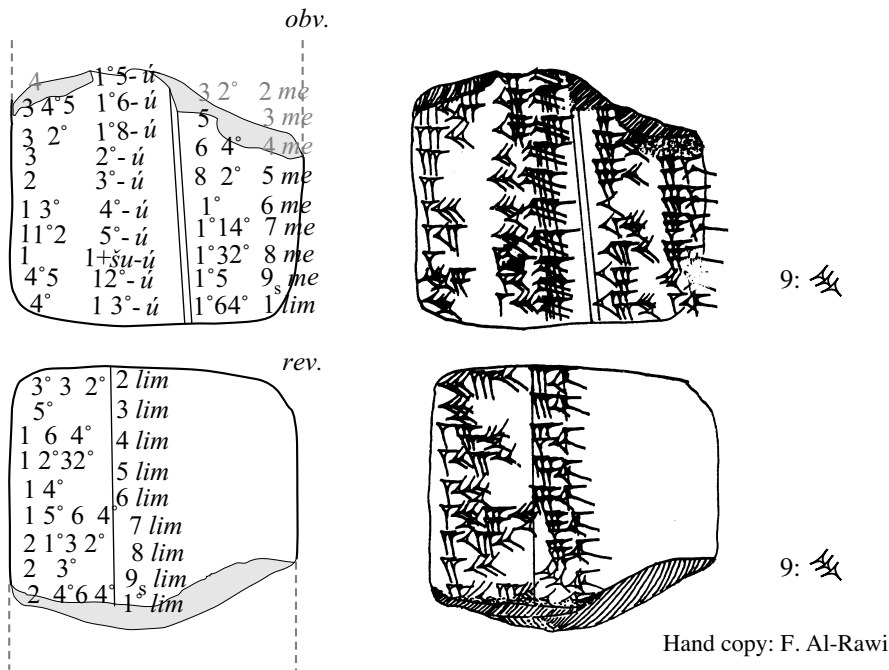

Fig. 2.7.2. BM 36841. A Late Babylonian table of reciprocals and a decimal-sexagesimal conversion table.